

Temposonics®

Magnetostrictive, Absolute, Non-contact
Linear-Position Sensors

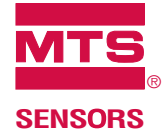

G-Series Redundant Models GT2 and GT3 Analog (Voltage/Current)

Document Part Number
551102 Revision A

Data Sheet



Model GT3 rod-style redundant position sensor

FEATURES

- Offers Redundancy for Enhanced Safety Applications
- Linear, Absolute Measurement
- Contains Up to Three Separate, Independent Measuring Systems in a Single Compact Housing
- Non-Contact Sensing Technology
- Superior Accuracy, Linearity Deviation Less Than 0.02%
- Repeatability Within 0.001%
- Fully Adjustable Analog Outputs (Voltage or Current) Within: -10 to +10 Vdc or 0 to 20 mA

BENEFITS

- Rugged Industrial Sensor
- Compact Design with a Standard Size 10 mm (0.39 in.) O.D. Stainless-Steel Rod
- Uses Standard Mounting

APPLICATIONS

- Ideal for High-Safety Applications Requiring Redundancy
- Continuous Operation In Harsh Industrial Conditions
- High Pressure Conditions

TYPICAL INDUSTRIES

- Power Plants
- Water and Wind Turbine Pitch Settings
- Marine Propellers
- Ship Control Systems
- Floodgate Control

Time-based Magnetostrictive position sensing principle

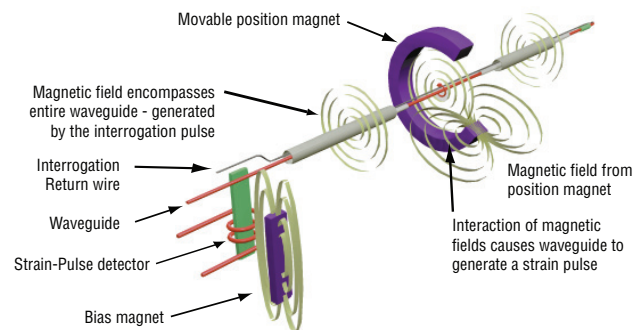

Benefits of Magnetostriction

Temposonics linear-position sensors use the time-based magnetostrictive position sensing principle developed by MTS. Within the sensing element, a sonic-strain pulse is induced in a specially designed magnetostrictive waveguide by the momentary interaction of two magnetic fields. One field comes from a movable permanent magnet that passes along the outside of the sensor. The other field comes from an “interrogation” current pulse applied along the waveguide. The resulting strain pulse travels at sonic speed along the waveguide and is detected at the head of the sensing element.

The position of the magnet is determined with high precision and speed by accurately measuring the elapsed time between the application of the interrogation pulse and the arrival of the resulting strain pulse with a high-speed counter. The elapsed time measurement is directly proportional to the position of the permanent magnet and is an absolute value. Therefore, the sensor's output signal corresponds to absolute position, instead of incremental, and never requires recalibration or re-homing after a power loss. Absolute, non-contact sensing eliminates wear, and guarantees the best durability and output repeatability.

All specifications are subject to change. Contact MTS for specifications and engineering drawings that are critical to your application. Drawings contained in this document are for reference only. Go to <http://www.mtssensors.com> for the latest support documentation and related media.

Product Overview and Specifications

Product overview

G-Series model GT sensors are extremely robust and are ideal for continuous operation under harsh industrial conditions. The rod housing is capable of withstanding high pressures such as those found in hydraulic cylinders. G-Series redundant sensors provide accurate, linear-position measurement for applications that benefit from redundancy due to safety relevant functions.

G-Series Redundant sensors feature two or three independent measuring systems contained in one compact housing. Each measuring system contains its own channel with sensor element, power and evaluation electronics and output signal. Each channel has its own output connector or cable.

All sensor elements are integrated in one pressure proofed, high-grade steel rod. Rod and housing style feature the approved standard dimensions with 10 mm (0.39 in.) diameter rod and 3/4-16 UNF or M18 x 1.5 threaded hex flanges. The redundant sensor easily installs in applications measuring linear movements of control valves, linear drives, fluid cylinders and machines.

Product specifications

Parameters	Specifications	Parameters	Specifications
OUTPUT		ENVIRONMENTAL	
Measured output variables:	Position	Operating conditions:	Operating temperature: -40 °C (-40 °F) to +75 °C (167 °F) Relative humidity: 90% no condensation
Resolution:	Analog: Infinite (restricted by output ripple)	EMC test:	Emissions: IEC/EN 61000-6-3 Immunity: IEC/EN 61000-6-2 IEC/EN 61000-4-2/3/4/5/6/8, level 3/4 criterium A, CE qualified
Update times:	< 1 ms (typical)	Shock rating:	100 g (single hit)/ IEC standard 68-2-27 (survivability)
Linearity deviation:	< ± 0.02% full stroke (minimum ± 50 µm)	Vibration rating:	5 g /10 to 2000 Hz, IEC standard 68-2-6 (operational)
Repeatability:	< ± 0.001% of full stroke (minimum ± 2.5 µm)	WIRING	
Hysteresis:	< 4 µm	Connection type:	6-pin male D60 (M16) connector or integral cable
Analog Outputs:	Model GT2: 2 output channels Model GT3: 3 output channels Voltages (Fully adjustable): 0 to 10, 10 to 0, -10 to +10, +10 to -10 Vdc (minimum controller load >5k ohms) Current (Fully Adjustable): 4 (0) to 20 mA, 20 to 4 (0) mA (min./max. load 0/500 ohms)	ROD STYLE SENSOR (MODEL GT2/GT3)	
Stroke Length:	GT2/GT3: Analog: 50 mm (2 in.) to 2900 mm (1015 in.)	Electronic head:	Aluminum housing
ELECTRONICS		Sealing:	IP 67
Operating voltage:	+24 Vdc nominal: -15 or +20% Polarity protection: up to -30 Vdc Overvoltage protection: up to 36 Vdc Current drain: 100 mA typical per channel Dielectric withstand voltage: 500 Vdc (DC ground to machine ground)	Sensor rod:	304L stainless steel
Setpoints:	Setpoint adjustment (Null/Span): 100% of electrical stroke length, 50 mm (2 in.) minimum distance between setpoints.	Operating pressure:	350 bar static, 690 bar peak (5000 psi static, 10,000 psi peak)
		Mounting:	Any orientation. Threaded flange M18 x 1.5 or 3/4 - 16 UNF-3A
		Typical mounting torque:	45 N-m (33 ft. - lbs.)
		Magnet types:	Ring magnet, open-ring magnet, or magnet float

Output options

G-Series rod-style redundant sensors are available with analog (voltage and current) outputs. The G-Series redundant, model GT2 sensor provides two output channels, and model GT3 provides three output channels.

ANALOG (VOLTAGE/CURRENT)

G-Series analog sensors provide direct signals, including voltage (0 to 10 Vdc or -10 to +10 Vdc, forward or reverse acting) and current (4 to 20 mA, or 0 to 20 mA, forward or reverse acting). (see 'Figure 1'). Both voltage and current outputs allow full adjustments of null and span setpoints (minimum 2 in. between setpoints). Since the outputs are direct, no signal-conditioning electronics are needed when interfacing with controllers or meters.

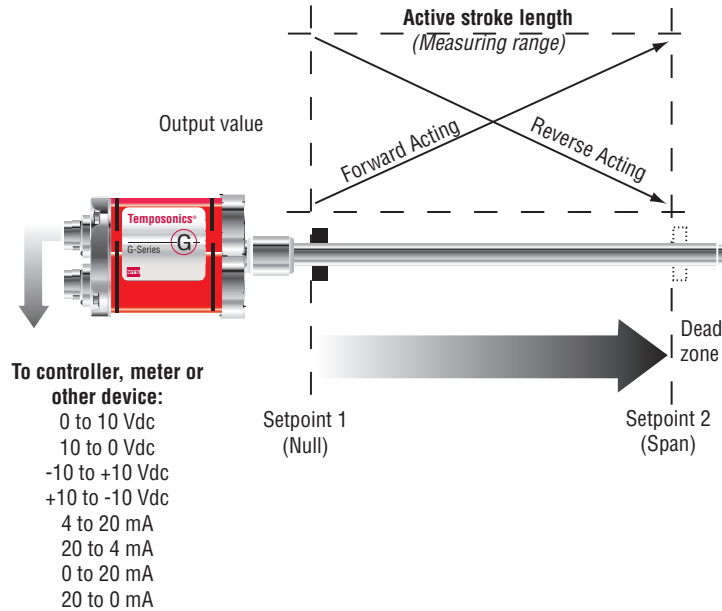

Figure 1. Single magnet analog output diagram

Advanced communications and programmability

SENSOR FIELD PROGRAMMING AND G-SERIES PC PROGRAMMING KIT

Temposonics G-Series Redundant sensors are preconfigured at the factory by model code designation. For many applications no adjustments are required for normal sensor installation and operation. If, however, sensor parameter changes are desired while in the field, the G-Series Redundant sensor is easily programmed by using the G-Series PC Programming kit (see 'Figure 2').

G-Series PC setup software is shipped with the sensor and can also be downloaded from www.mtssensors.com. You can use the PC setup software to configure, diagnose, monitor and program your G-Series sensor in the field without opening the sensor's electronics housing.

This can simplify installation and commissioning, saving valuable time. Keeping the sensor electronics isolated ensures that seal integrity and the highest product reliability are maintained.

G-Series Analog PC Programming Kit (part no.: 253311-1) includes the following components:

- Wall adapter style power supply (24 Vdc output)
- USB Serial converter box with USB cable to connect to PC
- Two connection cables:
 - Cable for sensor ordered with the D60 integral connector option.
 - Cable with quick connects for sensor ordered with the integral cable option.
- G-Series Analog PC Setup software, on CD-ROM (for Windows XP or higher)



Figure 2. G-Series PC Programming Kit, part no. 253311-1

G-Series Models GT2 and GT3 Redundant Sensors Monitoring, Diagnostics and Advanced Programmability

G-Series PC Setup and Configuration Software Interface

VISUAL SOFTWARE INTERFACE

The G-Series PC Setup and configuration software provides a user-friendly interface (see 'Figure 3') along with the sensor's advanced technology enables the operator to take advantage of the following features:

- Built-in serial interfaces for robust hard-wired serial communication (RS-485).
- Remote programmability for operational modes and sensor parameters (see 'Table 1').

ANALOG (VOLTAGE/CURRENT) OUTPUT FEATURES

Voltage or current output mode

Voltage or current output range

Full adjustment for Null and Span setpoints

Table 1. Remote programmability and operational modes

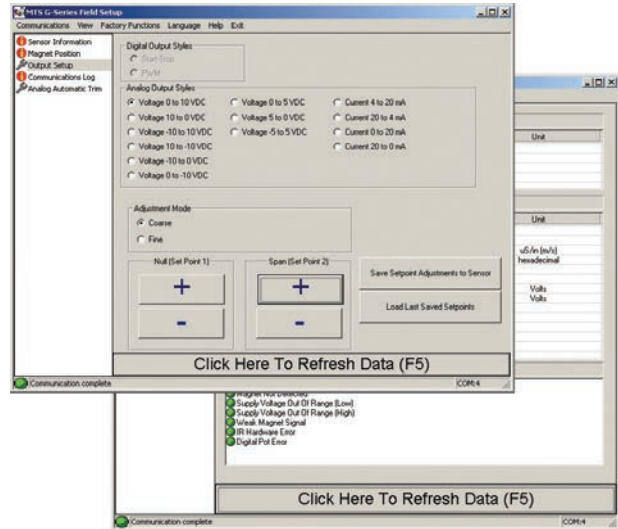

Figure 3. G-Series PC setup software interface examples

G-SERIES HANDHELD PROGRAMMER ACCESSORY FOR ANALOG OUTPUT

Programming for your G-Series analog output sensor can be achieved in the field using the G-Series Analog Handheld programmer accessory, part no. 253853 (see 'Figure 4').



Figure 4. G-Series Analog Handheld Programmer (part no.: 253853). Front and back views shown.

Using the G-Series Analog Handheld Programmer, magnet positions and corresponding output values can be adjusted for the beginning of stroke (Setpoint 1) and for the end of stroke (Setpoint 2) that is actually needed for the specific application. These adjustments are easily done, even when the sensor is not directly accessible, by connecting the programmer to the sensor's integral cable or extension cable.

Additionally, the programmer has its own red and green LEDs to provide a remote display of the sensor's status and error diagnostics.

For detailed information refer to the G-Series Analog Handheld Programmer Operating Instructions (document part no.: 551024) available at <http://www.mtssensors.com>.

Models GT2/GT3 rod-style sensor dimension references

Note:

When mounting the sensor, use a basic wrench (see 'Figure 5') with a maximum 8 mm (0.31 in.) thickness to ensure tightening torque is only applied to the hex flange and not to the electronics housing.

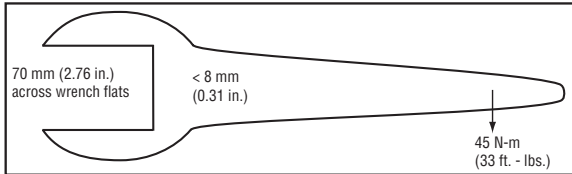

Figure 5. Basic wrench

Temposonics G-Series rod-style sensors (Models GT2/GT3) offer modular construction, flexible mounting configurations, and easy installation. Models GT2/GT3 sensors are designed for mounting in applications where high pressure conditions exist (5000 psi continuous, 10,000 psi spike), such as inside hydraulic cylinders (see 'Figure 8' on page 7). Both GT2 and GT3 sensor models can also be mounted externally in many applications.

MODEL GT3 ROD-STYLE SENSOR WITH RING MAGNET (MAGNET ORDERED SEPARATELY)

Drawing is for reference only, contact applications engineering for tolerance specific information.

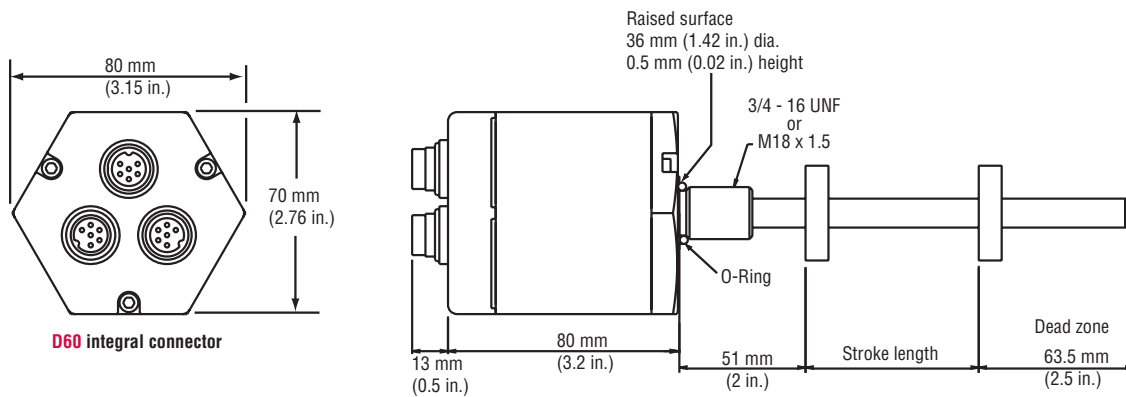

Figure 6. Models GT3 Rod-style sensor dimension reference (shown with **D60** integral connection type)

MODEL GT3 ROD-STYLE SENSOR WITH INTEGRAL CABLE (MAGNET ORDERED SEPARATELY)

Drawing is for reference only, contact applications engineering for tolerance specific information.

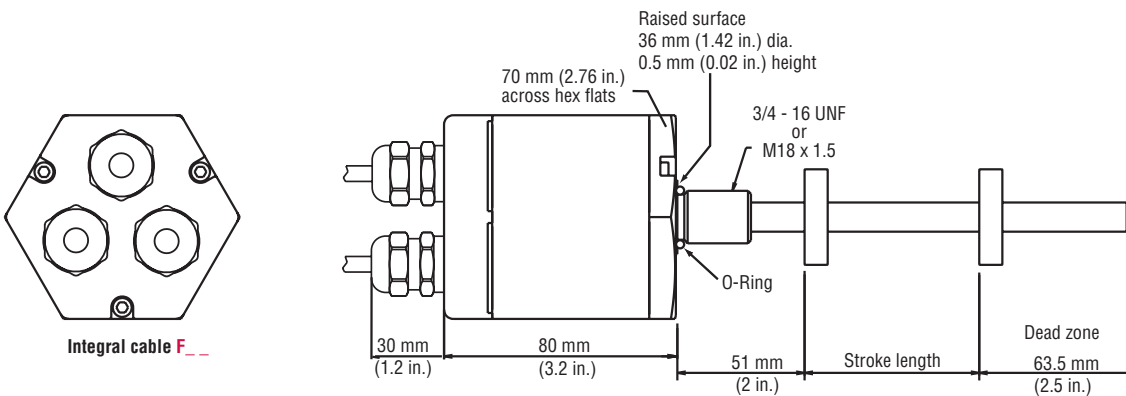
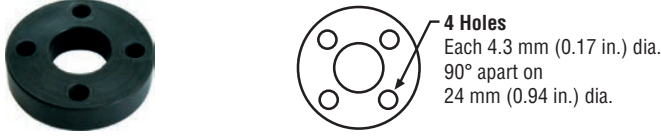
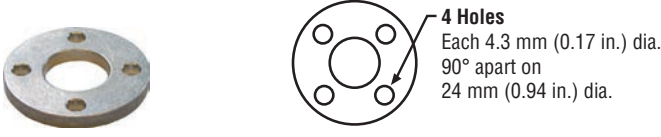

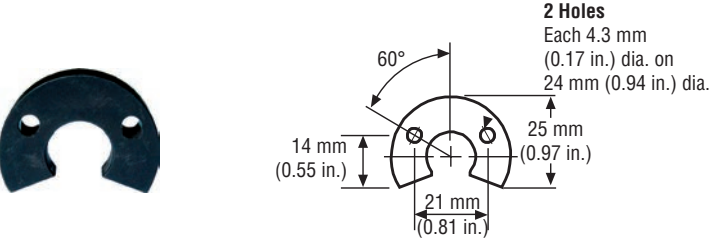
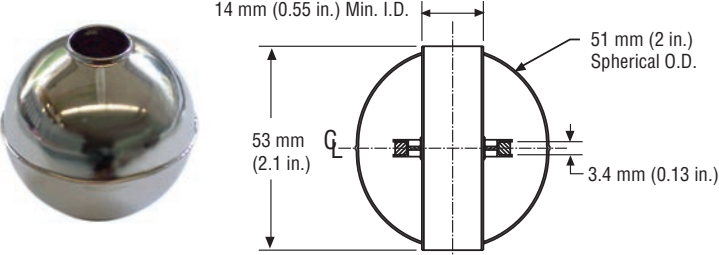
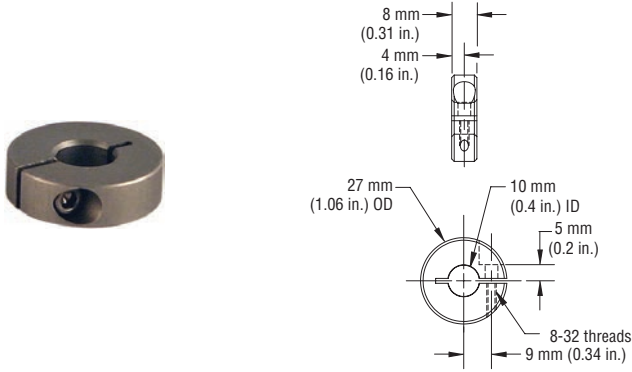

Figure 7. Model GT3 Rod-style sensor dimension reference (shown with integral cable)

G-Series Models GT2 and GT3 Redundant Sensors
Standard Magnet Selections

Standard magnet selections (Models GT2/GT3)

Magnets must be ordered separately with Models GT2/GT3 position sensors. The standard ring magnet (part number 201542-2) is suitable for most applications.

POSITION MAGNET SELECTIONS (Magnet must be ordered separately) <i>(Drawing dimensions are for reference only)</i>		
Magnet and magnet dimensions	Description	Part number
 <p>4 Holes Each 4.3 mm (0.17 in.) dia. 90° apart on 24 mm (0.94 in.) dia.</p>	<p>Standard ring magnet I.D.: 13.5 mm (0.53 in.) O.D.: 33 mm (1.3 in.) Thickness: 8 mm (0.3 in.) Operating temperature: - 40 °C to 100 °C</p>	201542-2
 <p>4 Holes Each 4.3 mm (0.17 in.) dia. 90° apart on 24 mm (0.94 in.) dia.</p>	<p>Magnet spacer (Non-ferrous, use with ring magnet Part number: 201542-2) I.D.: 14 mm (0.56 in.) O.D.: 32 mm (1.25 in.) Thickness: 3.2 mm (0.125 in.)</p>	400633
	<p>Ring magnet I.D.: 13.5 mm (0.53 in.) O.D.: 25.4 mm (1 in.) Thickness: 8 mm (0.3 in.) Operating temperature: - 40 °C to 100 °C</p>	400533
 <p>2 Holes Each 4.3 mm (0.17 in.) dia. on 24 mm (0.94 in.) dia. 60° 14 mm (0.55 in.) 25 mm (0.97 in.) 21 mm (0.81 in.)</p>	<p>Open-ring magnet, Style M I.D.: 13.5 mm (0.53 in.) O.D.: 33 mm (1.3 in.) Thickness: 8 mm (0.3 in.) Operating temperature: - 40 °C to 100 °C</p> <p>This magnet may influence the sensor performance specifications for some applications.</p>	251416-2
MAGNET FLOAT SELECTION <i>(Drawing dimensions are for reference only)</i>		
 <p>14 mm (0.55 in.) Min. I.D. 51 mm (2 in.) Spherical O.D. 53 mm (2.1 in.) 3.4 mm (0.13 in.)</p>	<p>Magnet float (Level sensing applications) Specific gravity: 0.70 maximum Pressure: 870 psi maximum</p> <p>(This float is used with Model RH rod-style sensors for hydraulic fluid or fresh water applications only). Collar (part no.: 560777) is recommended for end of stroke stops.</p>	251447
 <p>8 mm (0.31 in.) 4 mm (0.16 in.) 27 mm (1.06 in.) OD 10 mm (0.4 in.) ID 5 mm (0.2 in.) 8-32 threads 9 mm (0.34 in.)</p>	<p>Collar Provides end of stroke stops for magnet float (part no.: 251447)</p>	560777

Models GT2/GT3 rod-style sensor mounting

MODELS GT2/GT3 SENSOR MOUNTING

The position magnet requires minimum distances away from ferrous metals to allow proper sensor output. The minimum distance from the front of the magnet to the cylinder end cap is 15 mm (0.6 in.).

The minimum distance from the back of the magnet to the piston head is 3.2 mm (0.125 in.). However, a minimum distance of at least 5 mm (0.197 in.) is preferred for added performance margin. The non-ferrous spacer (part no.: 400633) provides this minimum distance when used along with the standard ring magnet (part no.: 201542-2), as shown in 'Figure 8'.

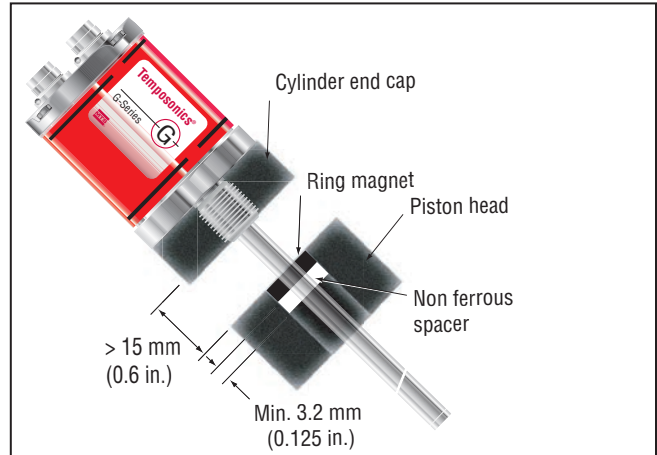

Figure 8. Models GT2/GT3 rod-style mounting

Models GT2/GT3 Rod-Style sensor cylinder installation

When used for direct-stroke measurement in fluid cylinders, the sensor's high pressure, stainless steel rod installs into a bore in the piston head/rod assembly (See 'Figure 9'). This method guarantees a long-life and trouble-free operation.

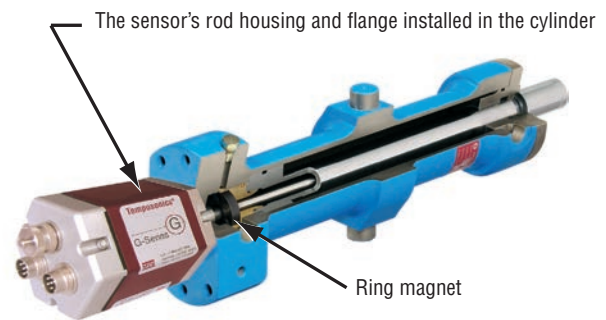

Figure 9. Fluid cylinder installation example

**G-Series Models GT2 and GT3 Redundant Sensors
Connections and Wiring**

Models GT2/GT3 connections and wiring

STANDARD MALE (D60) 6-PIN DIN INTEGRAL CONNECTOR (M16)



Male, 6-pin (D60) integral connector pin-out as viewed from the end of the sensor.

Important Notes:





1. A grounding lug on the end of the sensor is provided for convenient connection to earth ground.
2. Appropriate grounding of cable shield is required at the controller end.
3. For analog output sensors, the yellow wire (pin 3) and green wire (pin 4) provide serial communications. If possible, during sensor installation these wires should be placed for easy access if future programming or diagnostics are needed. When these wires are not used, they should be isolated with electrical tape to avoid unintended contact with other nearby wires or machine surfaces.

Pin Number	Wire Color	Function / Analog output
1	Gray	0 to 10, -10 to +10, or 4 to 20 mA, 0 to 20 mA reverse acting: 10 to 0, 10 to -10 Vdc or 20 to 4 mA, 20 to 0 mA
2	Pink	Return for pin 1
3	Yellow	Programming (RS-485+)
4	Green	Programming (RS-485-)
5	Red or Brown	Supply voltage (+Vdc)
6	White	DC ground (for supply)

CABLE CONNECTOR OPTIONS (FIELD INSTALLABLE) 6-PIN DIN (D60) FEMALE *(Drawing dimensions are for reference only)*

Connector and connector dimensions	Description	Part number
	<p>Cable Connector, Female, Straight Exit (Field installable)</p> <p>6-Pin DIN (D60) Mates with standard male (M16) integral connector</p>	560700
	<p>Cable Connector, Female, 90° Exit (Field installable)</p> <p>6-Pin DIN (D60) Mates with standard male (M16) integral connector</p>	560778

**MG-Series Models GT2 and GT3 Redundant Sensors
Ordering Information, Extension Cables**

EXTENSION CABLE WITH CONNECTORS FOR D6 (D60) CONNECTION TYPES		
Extension Cable and Connector	Description	Connection type
	Female Connector, Straight Exit with Standard PVC Jacket Cable <i>(Assembly Includes D6 Connector, Part No.: 560700 and Cable, Part No.:530026)</i>	D6
	Female Connector, 90° Exit with Standard PVC Jacket Cable <i>(Assembly Includes D6 Connector, Part No.: 560778 and Cable, Part No.:530026)</i>	DA
	Female Connector, Straight Exit with Black Polyurethane Jacket Cable (for higher resistance to moisture, oil and cold temperatures) <i>(Assembly Includes D6 Connector, Part No.: 560700 and Cable, Part No.:530052)</i>	DJ
	Female Connector, 90° Exit with Black Polyurethane Jacket Cable (for higher resistance to moisture, oil and cold temperatures) <i>(Assembly Includes D6 Connector, Part No.: 560778 and Cable, Part No.:530052)</i>	DK

Ordering Information - Extension Cable with Connector for D6 (D60) Connection Types

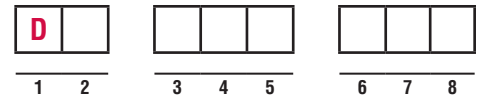

SENSOR CONNECTION TYPES _____ =

D	
---	--

1 - 2

- D6** = Female connector, straight exit (part no. 560700), and PVC jacket cable (part no. 530026)
- DA** = Female connector, 90° exit (part no. 560788), and PVC jacket cable (part no. 530026)
- DJ** = Female connector, straight exit (part no. 560700), and black polyurethane jacket cable (part no. 530052)
- DK** = Female connector, 90° exit (part no. 560788), and black polyurethane jacket cable (part no. 530052)

CABLE LENGTHS _____ =

--	--	--

3 - 5

For standard length cables up to 100 ft

- 005** = 5 ft
- 015** = 15 ft
- 025** = 25 ft
- 050** = 50 ft
- 100** = 100 ft

For custom length cables over 100 ft

— — — = Cable length (maximum cable length is dependent on the output selected; consult MTS Applications Engineering)

CABLE TERMINATION _____ =

--	--	--

6 - 8

- P0** = Pigtail cable without connector (2 digit code)
- D6M** = D6 male connector (straight exit). Only available with the **D6** option above.
- D6F** = D6 female connector, straight exit. Only available with the **D6** option above.
- DAF** = D6 female connector, 90° exit. Only available with the **DA** option above.

Models GT2 and GT3 Sensors

Ordering Information

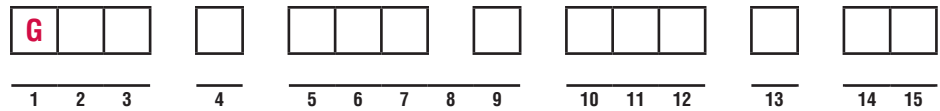

SENSOR MODEL _____ = **G T** 1-3

- GT2** = Double-redundant rod-style sensor
- GT3** = Triple-redundant rod-style sensor

HOUSING STYLE _____ = 4

Model GT rod-style sensor (magnet(s) must be ordered separately):

- S** = US customary threads and pressure tube, standard
- M** = Metric threads and pressure tube, standard

STROKE LENGTH _____ = 5-9

--- **M** = Millimeters
(Encode in 5 mm increments)

--- **U** = Inches and tenths
(Encode in 0.1 in. increments)

Stroke Length Note:

Rod-style sensor (model GT) stroke range = 50 mm (2 in.) - 2900 mm (115 in.)

CONNECTION TYPE _____ = 10-12

Integral connector:

- D60** = 6-pin DIN (M16), male, standard (2X or 3X)

Integral cables:

- F** = Integral cable, black polyurethane jacket with pigtail termination (2X or 3X)

Cable length:

Encode in feet if using US customary stroke length
Encode in meters if using metric stroke length

→ ___ = 3 (**03**) to 98 (**98**) ft. or 1 (**01**) to 30 (**30**) meters.

Cable Length Note:

MTS recommends the maximum integral cable length to be 10 meters (33 ft.). Cables greater than 10 m (33 ft.) in length are available, however, proper care must be taken during handling and installation.

INPUT VOLTAGE _____ = 13

- 1** = +24 Vdc (+20% - 15%)

OUTPUT _____ = 14-15

- | | |
|----------------------------|------------------------|
| V0 = 0 to +10 Vdc | A0 = 4 to 20 mA |
| V1 = +10 to 0 Vdc | A1 = 20 to 4 mA |
| V2 = -10 to +10 Vdc | A2 = 0 to 20 mA |
| V3 = +10 to -10 Vdc | A3 = 20 to 0 mA |

Note:

Standard factory settings configure all outputs to be the same per the output option selected (when configuring the model number). If needed, an output can be individually reprogrammed in the field to best fit the application.



Document Part Number: 551102, Revision A 04/10, 07/11

MTS and Temposonics are registered trademarks of MTS Systems Corporation. All other trademarks are the property of their respective owners.

Printed in USA. Copyright © 2011 MTS Systems Corporation. All Rights Reserved in all media.



**MTS Systems Corporation
Sensors Division**

3001 Sheldon Drive
Cary, North Carolina
27513, USA
Tel.: +1-800-633-7609
Fax: +1-919-677-2343
+1-800-498-4442
e-mail: sensorsinfo@mts.com
http://www.mtssensors.com

**MTS Sensor Technologie
GmbH & Co. KG**

Auf dem Schüffel 9
D - 58513 Lüdenscheid, Germany
Tel.: +49-2351-9587-0
Fax: +49-2351-56491
e-mail: info@mtssensor.de
http://www.mtssensor.de

**MTS Sensors Technology
Corporation**

737 Aihara-cho, Machida-shi
Tokyo 194-0211, Japan
Tel.: +81-42-775-3838
Fax: +81-42-775-5516
e-mail: info@mtssensor.co.jp
http://www.mtssensor.co.jp