

# Solenoid valve for gas VAS 1–3, double solenoid valve VCS 1–3

## OPERATING INSTRUCTIONS

Cert. Version 07.19 · Edition 06.22 · EN · 03250322

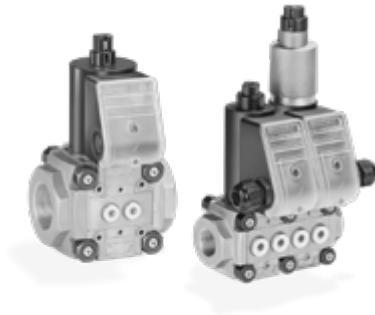

### 1 SAFETY

#### 1.1 Please read and keep in a safe place



Please read through these instructions carefully before installing or operating. Following the installation, pass the instructions on to the operator. This unit must be installed and commissioned in accordance with the regulations and standards in force. These instructions can also be found at [www.docuthek.com](http://www.docuthek.com).

#### 1.2 Explanation of symbols

**1, 2, 3, a, b, c** = Action

→ = Instruction

#### 1.3 Liability

We will not be held liable for damage resulting from non-observance of the instructions and non-compliant use.

#### 1.4 Safety instructions

Information that is relevant for safety is indicated in the instructions as follows:

#### **⚠ DANGER**

Indicates potentially fatal situations.

#### **⚠ WARNING**

Indicates possible danger to life and limb.

#### **⚠ CAUTION**

Indicates possible material damage.

All interventions may only be carried out by qualified gas technicians. Electrical interventions may only be carried out by qualified electricians.

#### 1.5 Conversion, spare parts

All technical changes are prohibited. Only use OEM spare parts.

### CONTENTS

1 Safety	1
2 Checking the usage	2
3 Installation	2
4 Wiring	4
5 Tightness test	5
6 Commissioning	5
7 Replacing the actuator	6
8 Replacing the damping unit	8
9 Replacing the circuit board	8
10 Maintenance	8
11 Accessories	9
12 Technical data	14
13 Air flow rate Q	15
14 Designed lifetime	15
15 Certification	16
16 Logistics	16
17 Disposal	17

## 2 CHECKING THE USAGE

Gas solenoid valves VAS for safeguarding gas or air on various appliances. Double solenoid valves VCS are combinations of two gas solenoid valves.

This function is only guaranteed when used within the specified limits – see page 14 (12 Technical data). Any other use is considered as non-compliant.

### 2.1 Type code

<b>VAS</b>	Solenoid valve for gas
<b>1-3</b>	Sizes
<b>-</b>	Without flange
<b>10-65</b>	Inlet and outlet flange nominal size
<b>R</b>	Rp internal thread
<b>F</b>	Flange to ISO 7005
<b>N</b>	NPT internal thread
<b>/N</b>	Quick opening, quick closing
<b>/L</b>	Slow opening, quick closing
<b>W</b>	Mains voltage 230 V AC, 50/60 Hz
<b>Q</b>	Mains voltage 120 V AC, 50/60 Hz
<b>K</b>	Mains voltage 24 V DC
<b>P</b>	Mains voltage 100 V AC, 50/60 Hz
<b>Y</b>	Mains voltage 200 V AC, 50/60 Hz
<b>S</b>	With PS and visual position indicator
<b>G</b>	With PS for 24 V and visual position indicator
<b>R</b>	Viewing side: right
<b>L</b>	Viewing side: left

### 2.2 Part designations

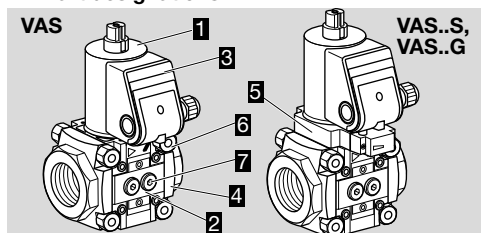

- 1 Solenoid actuator
- 2 Flow body
- 3 Connection box
- 4 Connection flange
- 5 Closed position indicator
- 6 Connection parts
- 7 Sealing plug

### 2.3 Type label

Mains voltage, electrical power consumption, ambient temperature, enclosure, inlet pressure and installation position: see type label.

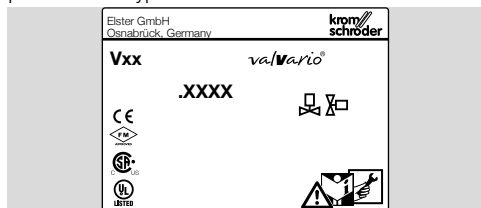

## 3 INSTALLATION

### ⚠ CAUTION

Incorrect installation

Please observe the following to ensure that the unit is not damaged during installation and operation:

- Sealing material and dirt, e.g. thread cuttings, must not be allowed to get into the valve housing.
- A filter must be installed upstream of every system.
- Dropping the device can cause permanent damage. In this event, replace the entire device and associated modules before use.
- Do not clamp the unit in a vice. Only secure the flange by holding the octagon with a suitable spanner. Risk of external leakage.
- It is not permitted to install gas solenoid valve VAS downstream of flow rate regulator VAH/VRH and upstream of fine-adjusting valve VMV. The VAS would no longer be able to perform its function as a second safety valve if installed in the above-mentioned position.
- If more than three valVario controls are installed in line, the controls must be supported.
- Solenoid valves with overtravel switch and visual position indicator VAS..SR/SL: actuator cannot be rotated.
- In the case of double solenoid valves, the position of the connection box can only be changed by removing the actuator and reinstalling it rotated by 90° or 180°.

- When joining two valves, determine the position of the connection boxes, push through the knock-outs in the connection boxes and install a cable gland set before installation in the pipework, see accessories, cable gland set for double solenoid valves.
- Install the unit in the pipe free of mechanical stress.
- For retrofitting a second gas solenoid valve, use the double block seal instead of O-rings. The double block seal is supplied with the seal set, see accessories, seal set for sizes 1-3.

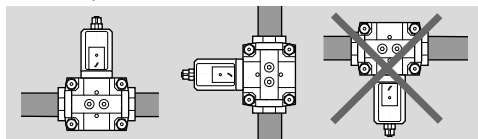

- Installation position: black solenoid actuator in the vertical upright position or tilted up to the horizontal, not upside down. In humid environments: black solenoid actuator in the vertical upright position only.

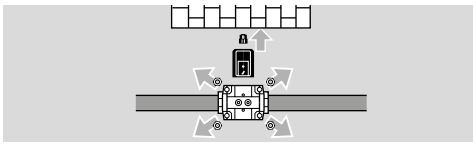

- The housing must not be in contact with masonry, minimum clearance 20 mm (0.79").
- Ensure that there is sufficient space for installation, adjustment and maintenance work. Minimum clearance of 50 cm (19.7") above the black solenoid actuator.

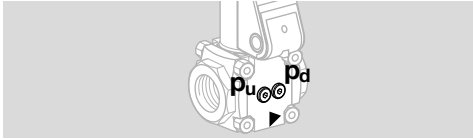

- The inlet pressure  $p_u$  and the outlet pressure  $p_d$  can be measured using the pressure test points on both sides, see accessories.

### Strainer

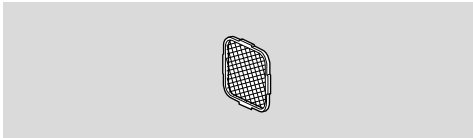

- A strainer must be fitted in the unit on the inlet side. If two or more gas solenoid valves are installed in line, then a strainer only needs to be fitted on the inlet side of the first valve.

### Differential pressure orifice

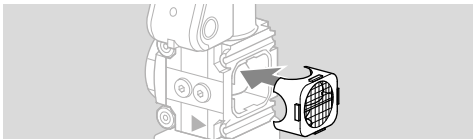

- If pressure regulator VAD/VAG/VAV 1 is retrofitted upstream of gas solenoid valve VAS 1, a DN 25 differential pressure orifice with outlet opening  $d = 30$  mm (1.18") must be inserted at the outlet of the pressure regulator. In the case of pressure regulator VAX 115 or VAX 120, the DN 25 differential pressure orifice must be ordered separately and retrofitted, Order No. 74922240.
- The retaining frame must be fitted to secure the differential pressure orifice at the outlet of the regulator.

### Retaining frame

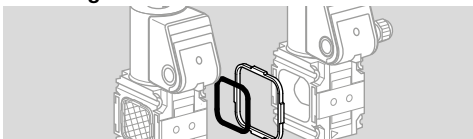

- If two controls (regulators or valves) are assembled, a retaining frame with double block seal must be fitted. Order No. for seal set: size 1: 74921988, size 2: 74921989, size 3: 74921990.

## Compression fittings

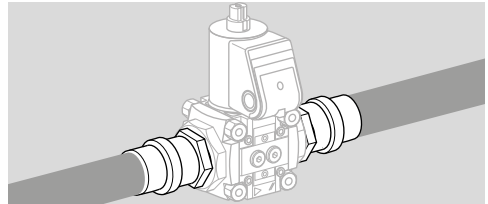

- The seals in some compression fittings are approved for temperatures of up to 70°C (158°F). This temperature limit will not be exceeded if the flow through the pipe is at least 1 m<sup>3</sup>/h (35.31 SCFH) of gas and the maximum ambient temperature is 50°C (122°F).

- 1 Remove the adhesive label or screw cap from the inlet and outlet.
- 2 Obey the direction of flow as marked on the housing.

### 3.1 VAS 1–3 with flanges



### 3.2 VAS 1–3 without flanges

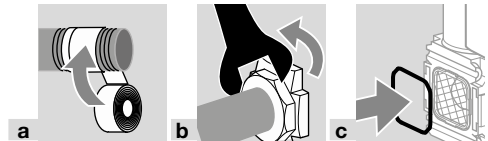

- O-ring and strainer (Fig. c) must be fitted.

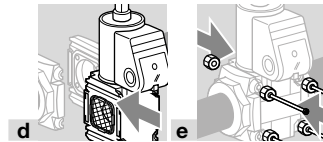

- Note the recommended tightening torques for the connection parts. See page 14 (12.2.1 Tightening torque).

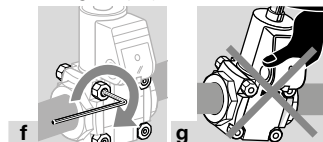

## 4 WIRING

### ⚠ WARNING

Risk of injury!

Please observe the following to ensure that no damage occurs:

- Electric shocks can be fatal! Before working on possible live components, ensure the unit is disconnected from the power supply.
- The solenoid actuator heats up during operation. Surface temperature approx. 85°C (approx. 185°F).



→ Use temperature-resistant cable (> 80°C).

**1** Disconnect the system from the electrical power supply.

**2** Shut off the gas supply.

→ UL requirements for the NAFTA market. To maintain the UL environmental rating Type 2, the enclosure openings shall be closed with fittings rated UL Type 2; 3; 3R; 3RX; 3S; 3SX; 3X; 4X; 5; 6; 6P; 12; 12K or 13. Gas solenoid valves shall be protected by a branch circuit protective device not exceeding 15 A.

→ Wiring to EN 60204-1.

→ Push through and remove the knock-out in the connection box before removing the cover. If the M20 cable gland or plug is already fitted, it is not necessary to remove the knock-out.

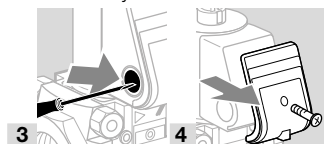

### M20 cable gland

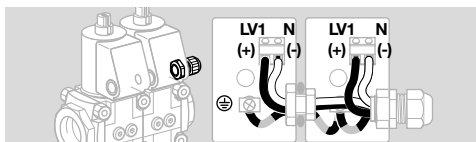
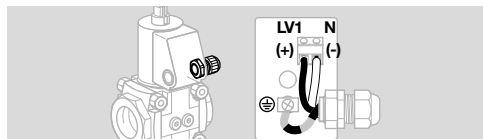
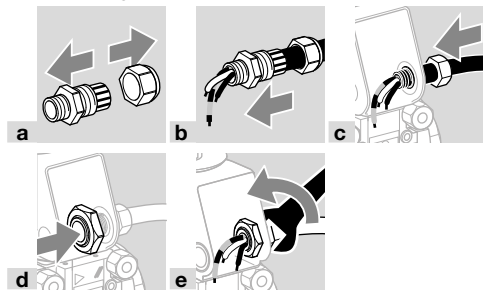

### Plug

→ LV1<sub>V1</sub> (+) = black, LV1<sub>V2</sub> (+) = brown, N (-) = blue

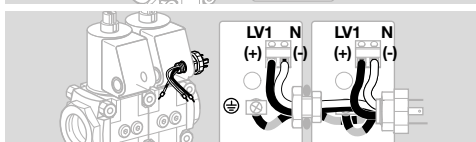
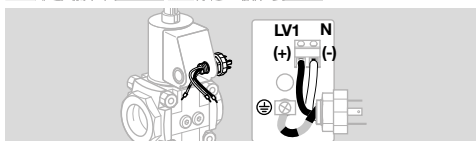
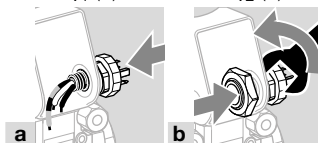

### Socket

→ 1 = N (-), 2 = LV1<sub>V1</sub> (+), 3 = LV1<sub>V2</sub> (+)

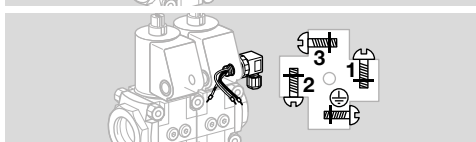
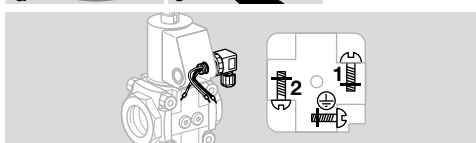
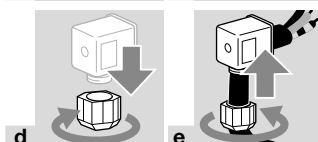
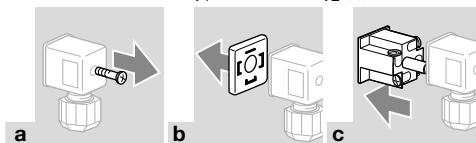

### Proof of closure switch

→ VAS 1–3 open: contacts **1** and **2** closed, VAS 1–3 closed: contacts **1** and **3** closed.

→ Indicator of proof of closure switch: red = VAS 1–3 open, white = VAS 1–3 closed.

→ Double solenoid valve: if a plug with socket is fitted, only one proof of closure switch can be connected.

## ⚠ CAUTION

Please observe the following to ensure smooth operation:

- The proof of closure switch is not suitable for frequent cycling operation.
- Route valve and proof of closure switch cables separately through M20 cable glands or use two separate plugs. Otherwise, there is a risk of interference between valve voltage and proof of closure switch voltage.

→ To make wiring easier, the connection terminal for the proof of closure switch can be removed.

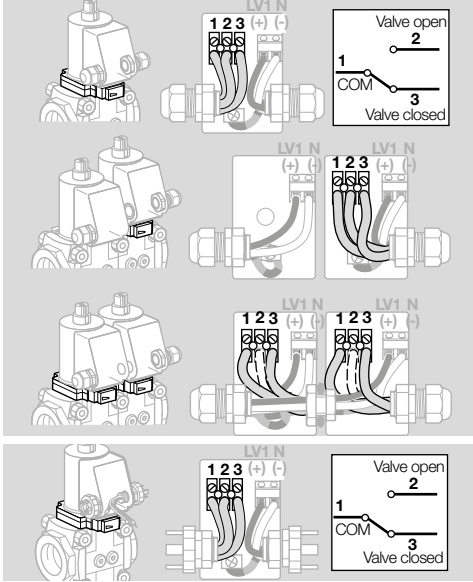

→ When installing two plugs on VAS 1–3 a with proof of closure switch: label the sockets and plugs to avoid confusion.

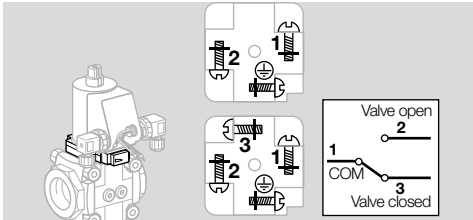

→ Ensure that the connection terminal for the proof of closure switch has been reconnected.

## Finishing the wiring

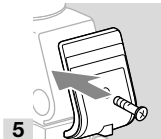

5

## 5 TIGHTNESS TEST

- 1 Close the gas solenoid valve.
- 2 To be able to check the tightness, shut off the downstream pipeline close to the valve.

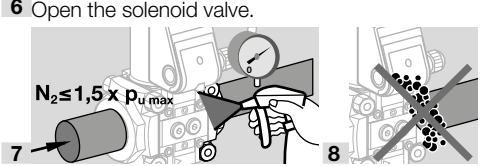
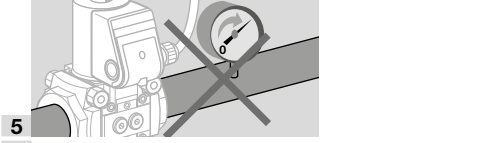
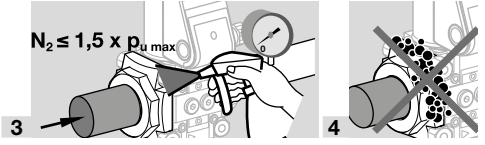

- 7 Tightness OK: open the pipeline.
- 9 Pipeline leaking: replace the seal on the flange, see accessories.  
Order No. for seal set: size 1: 74921988, size 2: 74921989, size 3: 74921990.  
Then check for tightness once again.

→ Unit leaking: remove the unit and return it to the manufacturer.

## 6 COMMISSIONING

### 6.1 Setting the flow rate

- At the factory, the valve is adjusted for maximum flow rate Q.
- The markings on the cover cap can be used for coarse adjustment of the flow rate.
- The cover cap can be rotated without changing the current flow rate.
- Allen key: 2.5 mm.
- Do not turn beyond the “max.” setting.

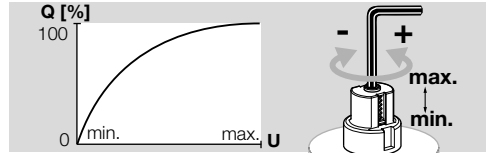

→ The VAS 1–3 remains tight even if the adjusting screw is overturned.

## 6.2 Setting the start rate on the VAS 1-3../L

- The start rate can be set by turning the damping unit a maximum of 5 turns.
- Check max. switching frequency, see page 14 (12.2 Mechanical data).
- Loosen the M5 setscrew (2.5 mm hexagon socket), but do not unscrew completely.

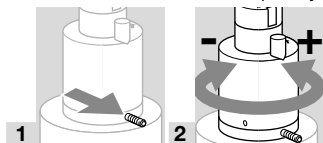

- 3** Set the start rate by turning the damping unit clockwise or anticlockwise.

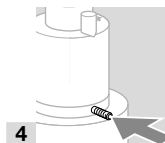

- 4** Screw the M5 setscrew back in.

## 6.3 Setting the damping speed on the VAS 1-3../L

- The opening speed can be influenced by turning the nozzle screw on the damping unit.

### CAUTION

Attention! To avoid leakage, please observe the following:

- If the nozzle screw is turned by more than 1 turn, the damping unit will leak and will have to be replaced.

- Turn the nozzle screw a maximum of 1/2 a turn in the appropriate direction.

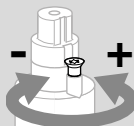

## 7 REPLACING THE ACTUATOR

- The actuator adapter set for the new actuator must be ordered separately.



VAx 1, VCx 1: Order No. 74924468,  
 VAx 2-3, VCx 2-3: Order No. 74924469.

### 7.1 Removing the actuator

#### VAS without damping unit

- 1 Disconnect the system from the electrical power supply.
- 2 Close the gas supply.

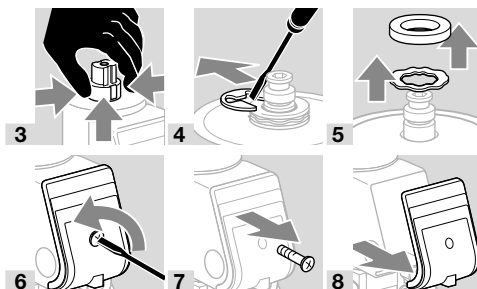

- Remove the M20 cable gland or other type of connection.

#### VAS without proof of closure switch

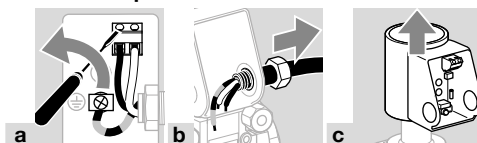

#### VAS with proof of closure switch

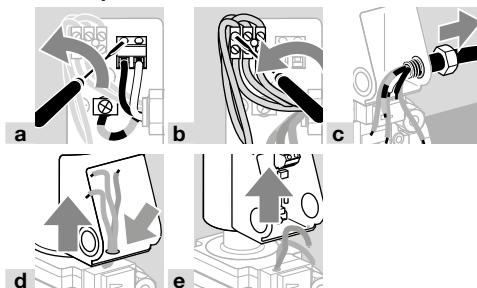

#### VAS with damping unit

- 1 Disconnect the system from the electrical power supply.
  - 2 Close the gas supply.
- Remove the M20 cable gland or other type of connection.
  - Loosen the setscrews, but do not unscrew completely (M3 = 1.5 mm hexagon socket, M5 = 2.5 mm hexagon socket).

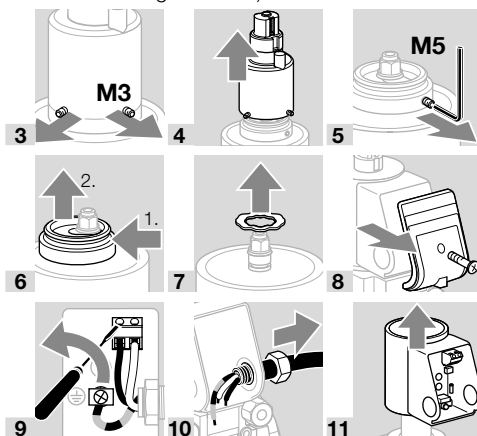

## 7.2 Fitting the new actuator

- The seals of the actuator adapter set are covered with a non-stick coating. No additional grease is required.
- Depending on the construction stage of the unit, there are two different methods for replacing the actuator: If the unit concerned has no O-ring in this place (arrow), replace the actuator as described here. Otherwise, go to the next note.

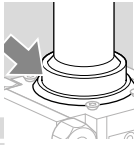

1

2 Insert seals.

3 Position of the metal ring can be selected.

VAX 1, VAN 1

VAX 2-3, VAN 2

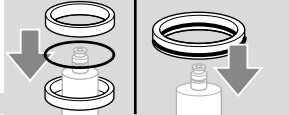

4

5 Slide seal under the second groove.



6

- If the unit concerned has an O-ring in this place (arrow), replace the actuator as described here: VAS 1: use all seals from the actuator adapter set. VAS 2, VAS 3: use the small seal from the actuator adapter set and only one of the large seals.

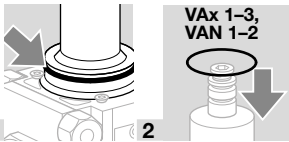

1

VAX 1-3,  
VAN 1-2



2

3 Slide seal under the second groove.

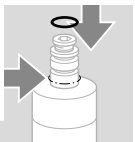

4

### VAS without damping unit

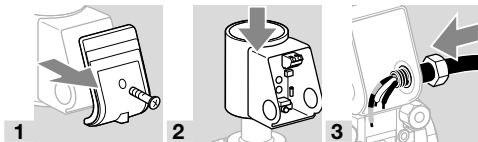

1

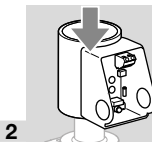

2

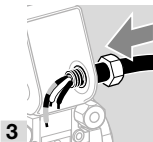

3

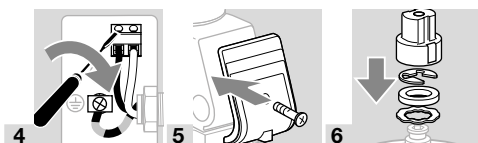

4

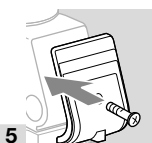

5

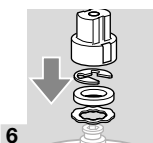

6

- 7 Open the gas solenoid valve and the gas supply.

### VAS with proof of closure switch

- Depending on the design of the proof of closure switch, one of the two enclosed seals must be inserted in the connection box housing.

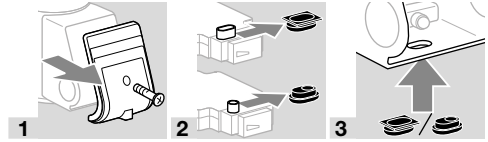

1

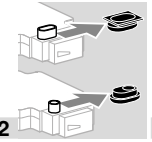

2

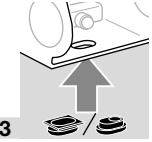

3

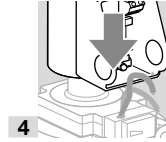

4

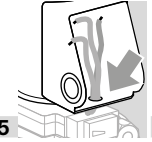

5

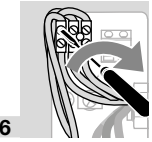

6

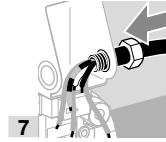

7



8



9

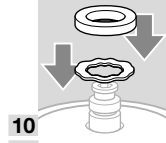

10

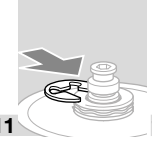

11

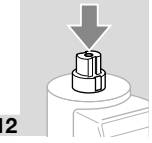

12

- 13 Open the gas solenoid valve and the gas supply.

### VAS with damping unit

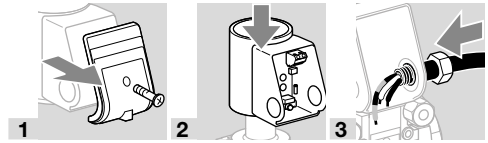

1

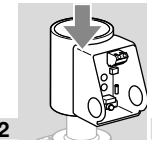

2

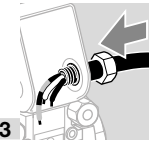

3

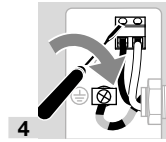

4



5

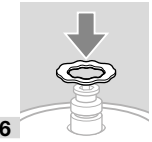

6

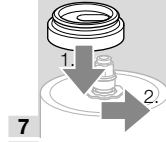

7

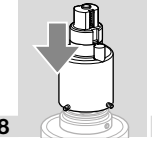

8

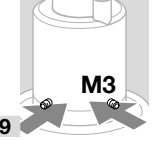

9

- 10 Screw in the M3 setscrews.

- 11 Open the gas solenoid valve and the gas supply.

- 12 Set the start gas rate, see page 6 (6.2 Setting the start rate on the VAS 1-3../L.). The connection between solenoid actuator and damping unit must then be checked for tightness.

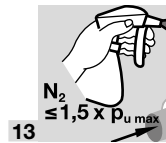

13

$N_2$   
 $\leq 1,5 \times P_{U \max}$

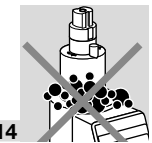

14

## 8 REPLACING THE DAMPING UNIT

- 1 Disconnect the system from the electrical power supply.
  - 2 Close the gas supply.
- Loosen the M3 setscrews (1.5 mm hexagon socket), but do not unscrew completely.

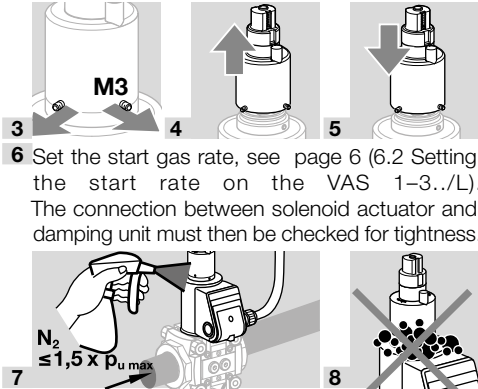

## 9 REPLACING THE CIRCUIT BOARD

### ⚠ WARNING

Risk of injury!

Please observe the following to ensure that no damage occurs:

- Electric shocks can be fatal! Before working on possible live components, ensure the unit is disconnected from the power supply.
- The solenoid actuator heats up during operation. Surface temperature approx. 85°C (approx. 185°F).



→ We recommend making a note of the contact assignment for subsequent rewiring.

→ 1 = N (-), 2 = LV1 (+)

- 1 Disconnect the system from the electrical power supply.
- 2 Close the gas supply.

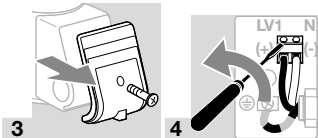

→ If a POC switch is wired, disconnect it.

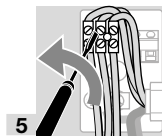

5 → Keep all components for subsequent assembly in a safe place.

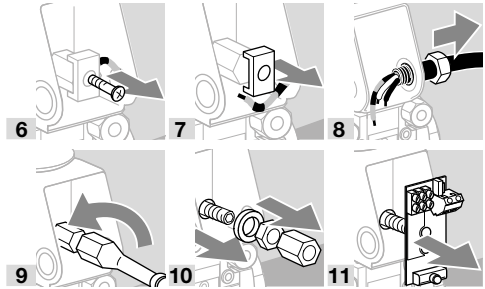

- 9
- 10
- 11
- 12 Insert new circuit board.
- 13 Follow the reverse procedure when reassembling.
- 14 Re-establish all connections.

→ Wire the new circuit board, see page 4 (4 Wiring).

→ Leave the connection box open for the electrical system test.

### 9.1 Electric strength test

- 1 Once the wiring has been carried out and before the devices are commissioned, a voltage surge test must be carried out.

Test points: mains connection terminals (N, L) with respect to PE wire terminal (PE ⊕).

Rated voltage > 150 V: 1752 V AC or 2630 V DC, testing time 1 second.

Rated voltage ≤ 150 V: 1488 V AC or 2240 V DC, testing time 1 second.

- 2 Screw the cover onto the connection box once the electrical test has been completed successfully.
- 3 The unit is fit for use again.

## 10 MAINTENANCE

### ⚠ CAUTION

In order to ensure smooth operation, check the tightness and function of the unit:

- Once per year, twice per year in the case of biogas; check for internal and external tightness, see page 5 (5 Tightness test).
- Check electrical installations once a year in line with local regulations; pay particular attention to the PE wire, see page 4 (4 Wiring).

→ If the flow rate has dropped, clean the strainer.

→ If more than one valVario control is installed in series: the controls may only be removed from the pipeline and reinstalled on the inlet and outlet flange all at once.

→ We recommend replacing the seals, see accessories, page 9 (11.1 Seal set for sizes 1–3).



- 1 Disconnect the system from the electrical power supply.
- 2 Shut off the gas supply.
- 3 Undo connection parts.

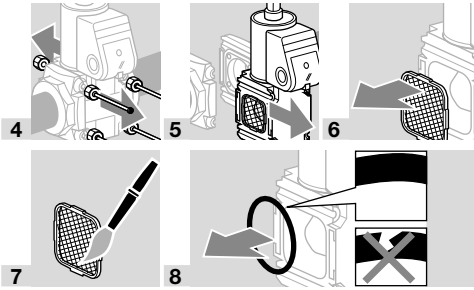

- 9 Once the seals have been replaced, follow the reverse procedure to reassemble the unit.  
→ Note the recommended tightening torques for the connection parts. See page 14 (12.2.1 Tightening torque).
- 10 Then check the unit for internal and external tightness, see page 5 (5 Tightness test).

## 11 ACCESSORIES

### 11.1 Seal set for sizes 1-3

When retrofitting accessories or a second valVario control or when servicing, we recommend replacing the seals.

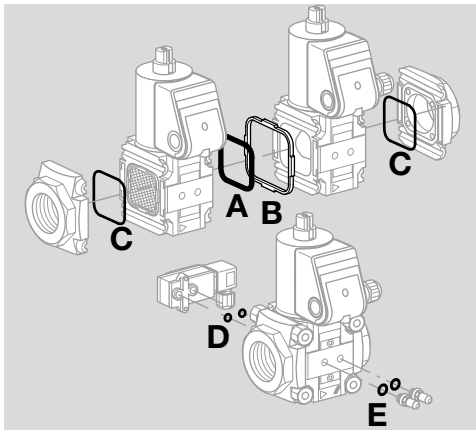

### VAx 1-3

VA 1, Order No. 74921988,  
VA 2, Order No. 74921989,  
VA 3, Order No. 74921990.

#### Scope of delivery:

- A 1 x double block seal,
- B 1 x retaining frame,
- C 2 x O-rings (flange),
- D 2 x O-rings (pressure switch),

for test nipple/screw plug:

- E 2 x sealing rings (flat sealing),
- 2 x profiled sealing rings.

### VCx 1-3

VA 1, Order No. 74924978,  
VA 2, Order No. 74924979,  
VA 3, Order No. 74924980.

#### Scope of delivery:

- A 1 x double block seal,
- B 1 x retaining frame.

### 11.2 Pressure switch for gas DG..VC

The pressure switch for gas monitors the inlet pressure  $p_u$ , the interspace pressure  $p_z$  and the outlet pressure  $p_d$ .

- Monitoring the inlet pressure  $p_u$ : the pressure switch for gas is mounted on the inlet side.
- Monitoring the outlet pressure  $p_d$ : the pressure switch for gas is mounted on the outlet side.

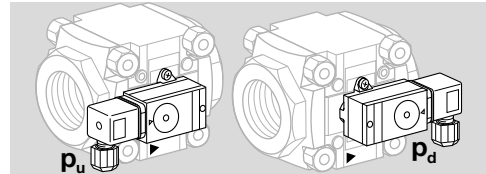

Scope of delivery:

- 1 x pressure switch for gas,
- 2 x self-tapping retaining screws,
- 2 x sealing rings.

Also available with gold-plated contacts for voltages of 5 to 250 V.

When using two pressure switches on the same side of the double solenoid valve, only the combination DG..C..1 and DG..C..9 may be used for design reasons.

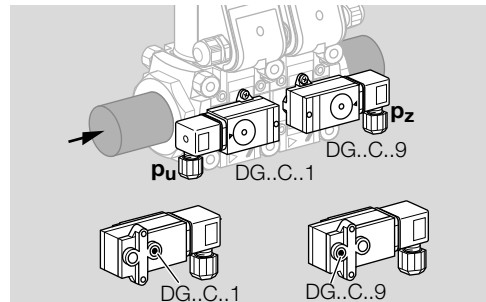

- When retrofitting the pressure switch for gas, see enclosed operating instructions "Pressure switches for gas DG..C", section entitled "Mounting the DG..C.. on valVario gas solenoid valves".
- The switching point is adjustable via hand wheel.

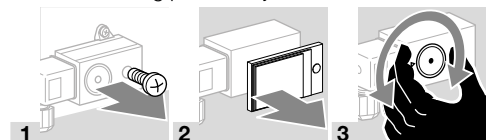

Type	Adjusting range (adjusting tolerance = ± 15% of the scale value)		Mean switching differential at min. and max. setting	
	[mbar]	["WC]	[mbar]	["WC]
DG 17VC	2–17	0.8–6.8	0.7–1.7	0.3–0.8
DG 40VC	5–40	2–16	1–2	0.4–1
DG 110VC	30–110	12–44	3–8	0.8–3.2
DG 300VC	100–300	40–120	6–15	2.4–8

→ Deviation from the switching point during testing pursuant to EN 1854 Gas pressure switches: ± 15%.

### 11.3 Tightness control TC 1V

- 1 Disconnect the system from the electrical power supply.
  - 2 Shut off the gas supply.
- The solenoid actuator cannot be rotated on solenoid valves with proof of closure switch VCx..S or VCx..G.
- Connect the TC to the inlet pressure connection  $p_u$  and the interspace pressure connection  $p_z$  of the inlet valve. Ensure that connections  $p_u$  and  $p_z$  on the TC and the gas solenoid valve are not reversed.
- TC and bypass/pilot gas valve cannot be fitted together on the same side of the double block valve.
- In the case of a VCx combination, it is recommended to always install the bypass/pilot gas valve on the rear of the second valve and the tightness control on the viewing side of the first valve, together with the connection box.
- The TC is secured using two captive, self-tapping combination Torx screws T20 (M4) inside the housing.

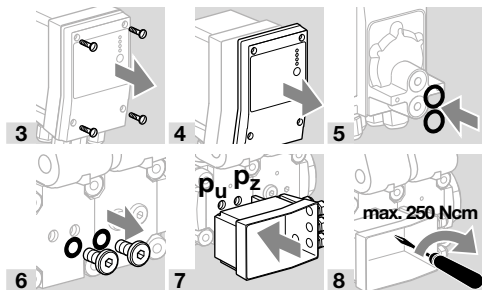
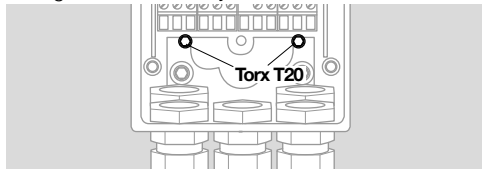

→ For more information on wiring, testing the tightness and commissioning, see enclosed "Tightness control TC 1, TC 2, TC 3" operating instructions.

9 After completing the wiring, tightness test and commissioning for the TC, refit the housing cover on the TC.

### 11.4 Cable gland set

When wiring double solenoid valve VCx 1–3, the connection boxes are to be connected using a cable gland set. The cable gland set can only be used if the connection boxes are at the same height and on the same side and if both valves are equipped either with or without a proof of closure switch.

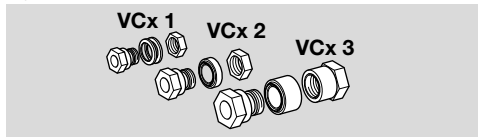

VA 1, Order No. 74921985,

VA 2, Order No. 74921986,

VA 3, Order No. 74921987.

→ We recommend preparing the connection boxes before the double solenoid valve is installed in the pipework. Alternatively, one of the actuators must be dismantled as described below and reinstalled rotated by 90° in preparation for installation of the double solenoid valve.

1 Disconnect the system from the electrical power supply.

2 Close the gas supply.

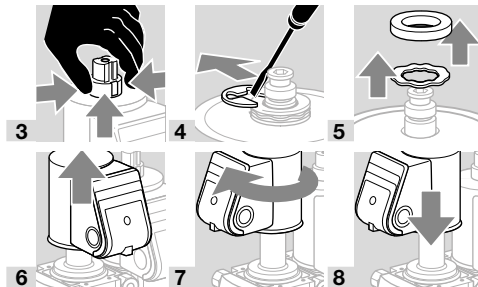

→ In both connection boxes, push through the knock-out for the cable gland set – then remove the covers. The covers must not be taken off before pushing through the knock-outs as it prevents damage to the connection boxes.

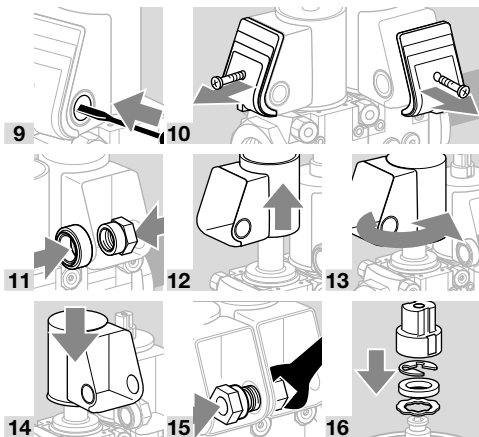

**17** Connect the valves to the electrical power supply, see section entitled "Wiring".

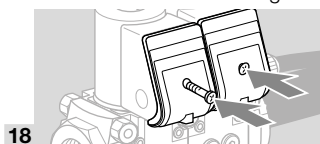

### 11.5 Attachment block VA 1-3

For locked installation of pressure gauge or other accessories on the gas solenoid valve VAS 1-3.

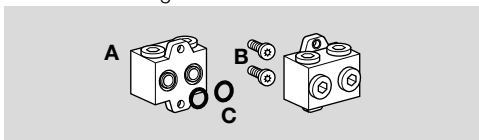

Attachment block Rp 1/4, Order No. 74922228,  
Attachment block 1/4 NPT, Order No. 74926048.

Scope of delivery:

- A** 1 x attachment block,
- B** 2 x self-tapping screws for installation,
- C** 2 x O-rings.

- 1** Disconnect the system from the electrical power supply.
  - 2** Close the gas supply.
- Use the enclosed self-tapping screws for installation.

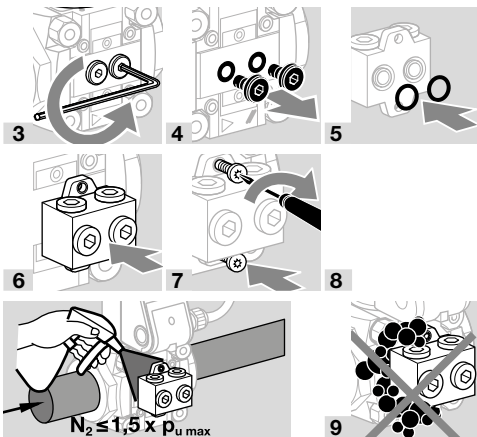

**10** Shut off the downstream gas pipeline close to the solenoid valve.

**11** Open the solenoid valve.

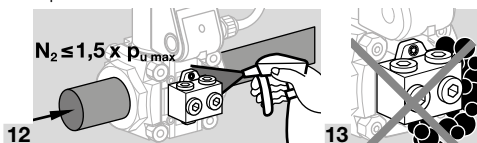

### 11.6 Bypass/pilot gas valves

Prepare the installed main valve.

- 1** Disconnect the system from the electrical power supply.
  - 2** Close the gas supply.
- Turn the actuator so that the side on which the bypass/pilot gas valve is to be installed is accessible.

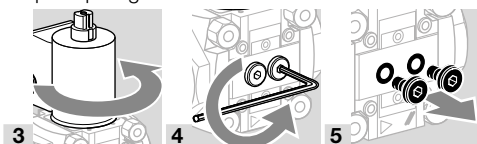

#### 11.6.1 VBY for VAX 1

Ambient temperature: 0 to +60°C (32 to 140°F), no condensation permitted.  
Enclosure: IP 54.

Scope of delivery

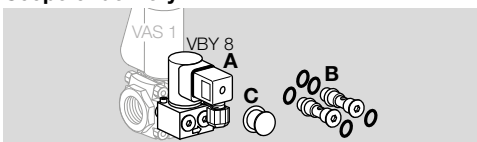

### VBY 8I as bypass valve

**A** 1 x bypass valve VBY 8I

**B** 2 x retaining screws with 4 x O-rings: both retaining screws have a bypass orifice

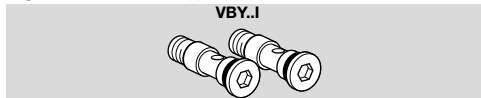

**C** 1 x grease for O-rings

→ The screw plug at the outlet remains in place.

### VBY 8R as pilot gas valve

**A** 1 x pilot gas valve VBY 8R

**B** 2 x retaining screws with 5 x O-rings: one retaining screw has a bypass orifice (2 x O-rings), the other does not (3 x O-rings)

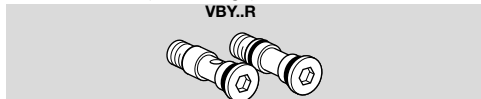

**C** 1 x grease for O-rings

→ Remove the screw plug at the outlet and connect the Rp 1/4 pilot gas supply line.

### Mounting the VBY

**1** Grease O-rings.

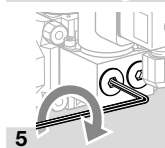
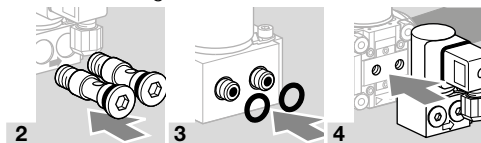

→ Tighten the retaining screws alternately so that VBY and VAX are flush.

### Setting the flow rate

→ The flow rate can be set by turning the flow rate restrictor (4 mm hexagon socket) 1/4 of a turn.

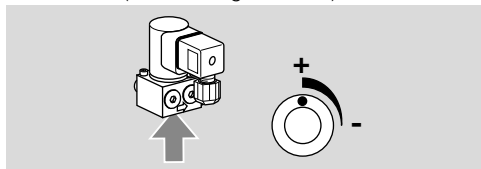

→ Only adjust the flow rate restrictor in the marked range, otherwise the required gas volume will not be reached.

**6** Wire the socket, see section entitled "Wiring".

**7** Check for tightness, see accessories, "Checking the bypass/pilot gas valve for tightness".

### 11.6.2 VAS 1 for VAX 1, VAX 2, VAX 3

#### Scope of delivery

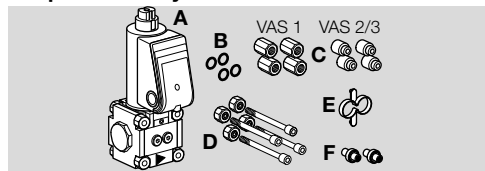

**A** 1 x bypass/pilot gas valve VAS 1,

**B** 4 x O-rings,

**C** 4 x double nuts for VAS 1 → VAX 1,

**C** 4 x spacer sleeves for VAS 1 → VAX 2/VAX 3,

**D** 4 x connection parts,

**E** 1 x mounting aid.

Pilot gas valve VAS 1:

**F** 1 x connection pipe, 1 x sealing plug, if the pilot gas valve has a threaded flange on the outlet side.

Bypass valve VAS 1:

**F** 2 x connection pipes, if the bypass valve has a blind flange on the outlet side.

Standard: Ø 10 mm.

→ Always use a connection pipe **F** at the inlet of the main valve.

→ For a bypass valve: use connection pipe **F** Ø 10 mm (0.39") at the outlet of the main valve if the bypass valve's outlet flange is designed as a blind flange.

→ For the pilot gas valve: insert sealing plug **F** at the outlet of the main valve if the pilot gas valve's outlet flange is designed as a threaded flange.

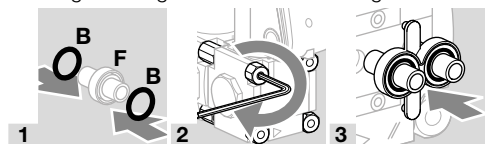

**4** Remove the sealing plugs on the mounting side of the bypass valve.

### Mounting the VAS 1 to VAX 1

**a** Remove the nuts from the connection parts on the mounting side of the main valve.

**b** Remove the connection parts of the bypass/pilot gas valve.

→ Use the new connection parts **C** and **D** from the scope of delivery for the bypass/pilot gas valve.

→ Note the recommended tightening torques for the connection parts. See page 14 (12.2.1 Tightening torque).

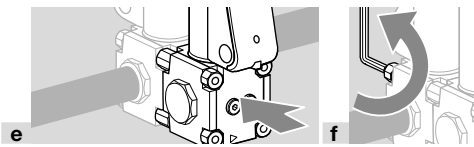
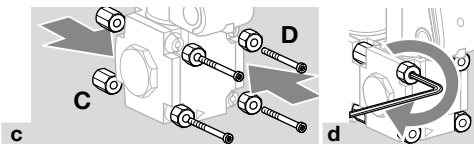

**g** Wire the bypass/pilot gas valve VAS 1, see section entitled "Wiring".

**h** Check for tightness, see accessories, "Checking the bypass/pilot gas valve for tightness".

### Mounting the VAS 1 to VAx 2 or VAx 3

→ The connection parts of the main valve remain mounted.

**a** Remove the connection parts of the bypass/pilot gas valve.

**b** Use the new connection parts **C** and **D** from the scope of delivery for the bypass/pilot gas valve. For VAx 2 and VAx 3, the connection parts consist of self-tapping screws.

→ Note the recommended tightening torques for the connection parts. See page 14 (12.2.1 Tightening torque).

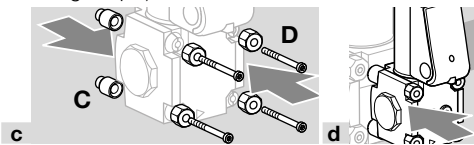

**f** Wire the bypass/pilot gas valve VAS 1, see section entitled "Wiring".

**g** Check for tightness, see accessories, "Checking the bypass/pilot gas valve for tightness".

### 11.6.3 Checking the bypass/pilot gas valve for tightness

**1** To be able to check the tightness, shut off the downstream pipeline as close as possible to the valve.

**2** Close the main valve.

**3** Close the bypass/pilot gas valve.

#### ⚠ CAUTION

Possible leakage!

– If the actuator of the VBY is rotated, the tightness can no longer be guaranteed. To ensure that there are no leaks, check the actuator of the VBY for tightness.

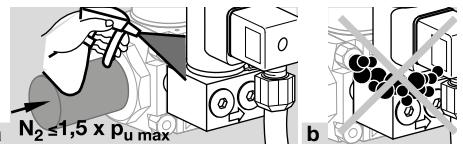

**a**  $N_2 \leq 1,5 \times p_{u \max}$

Check the bypass/pilot gas valve for tightness at the inlet and outlet.

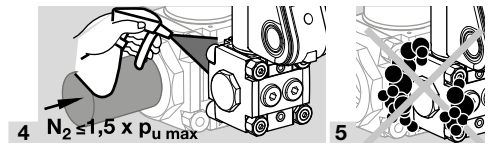

**4**  $N_2 \leq 1,5 \times p_{u \max}$



**7** Open the bypass or pilot gas valve.

#### Bypass valve

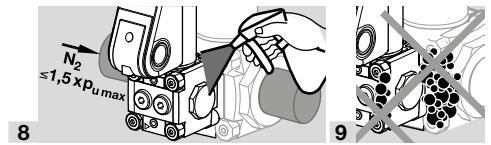

**8**  $N_2 \leq 1,5 \times p_{u \max}$

#### Pilot gas valve

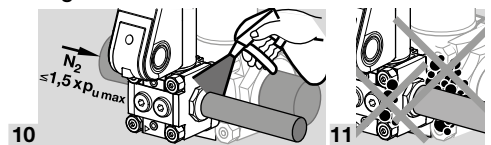

**10**  $N_2 \leq 1,5 \times p_{u \max}$



**12**

## 12 TECHNICAL DATA

### 12.1 Ambient conditions

Icing, condensation and dew in and on the unit are not permitted.

Avoid direct sunlight or radiation from red-hot surfaces on the unit. Note the maximum medium and ambient temperatures!

Avoid corrosive influences, e.g. salty ambient air or SO<sub>2</sub>. The unit may only be stored/installed in enclosed rooms/buildings.

The unit is suitable for a maximum installation height of 2000 m AMSL.

Ambient temperature: -20 to +60°C (-4 to +140°F), no condensation permitted.

Long-term use in the upper ambient temperature range accelerates the ageing of the elastomer materials and reduces the service life (please contact manufacturer).

Storage temperature = transport temperature: -20 to +40°C (-4 to +104°F).

Enclosure: IP 65.

This unit is not suitable for cleaning with a high-pressure cleaner and/or cleaning products.

### 12.2 Mechanical data

Gas types: natural gas, LPG (gaseous), biogas (max. 0.1 %-by-vol. H<sub>2</sub>S) or clean air; other types of gas on request. The gas must be clean and dry in all temperature conditions and must not contain condensate.

Medium temperature = ambient temperature.

CE and FM approved, UL listed, max. inlet pressure p<sub>in</sub>: 500 mbar (7.25 psig).

FM approved, non operational pressure: 700 mbar (10 psig).

ANSI/CSA approved: 350 mbar (5 psig).

Flow adjustment limits the maximum flow rate to between approx. 20 and 100%.

Adjustment of the start gas rate: 0 to approx. 70%.

Opening times:

VAS.../N quick opening: < 1 s;

VAS.../L slow opening: up to max. 10 s.

Closing time:

VAS.../N, VAS.../L quick closing: < 1 s.

Switching frequency:

VAS.../N: any, max. 30 x per minute.

VAS.../L: max. 2 x per minute. There should be a period of 20 seconds between switching off and on again so that the damping is fully effective.

Safety valve:

Class A, Group 2 pursuant to EN 13611 and EN 161,

Factory Mutual (FM) Research Class: 7400 and 7411,

ANSI Z21.21 and CSA 6.5.

Valve housing: aluminium, valve seal: NBR.

Connection flanges:

up to size 3: Rp internal thread to ISO 7-1, NPT to ANSI/ASME;

size 2 and higher: with PN 16 ISO flange (pursuant to ISO 7005),

size 6 and higher: with ANSI flange pursuant to ANSI 150.

Cable gland: M20 x 1.5.

Electrical connection: cable with max. 2.5 mm<sup>2</sup> (AWG 12) or plug with socket to EN 175301-803.

Duty cycle: 100%.

Power factor of the solenoid coil: cos φ = 0.9.

### 12.2.1 Tightening torque

Recommended tightening torques for the connection parts:

Connection parts	Tightening torque [Ncm]
VAX 1: M5	500 ± 50
VAX 2: M6	800 ± 50
VAX 3: M8	1400 ± 100

### 12.3 Electrical data for VAS 1-3/VCS 1-3

Mains voltage:

230 V AC, +10/-15%, 50/60 Hz;

200 V AC, +10/-15%, 50/60 Hz;

120 V AC, +10/-15%, 50/60 Hz;

100 V AC, +10/-15%, 50/60 Hz;

24 V DC, ±20%.

Power consumption:

Type	Voltage	Power
VAS 1	24 V DC	25 W
VAS 1	100 V AC	25 W (26 VA)
VAS 1	120 V AC	25 W (26 VA)
VAS 1	200 V AC	25 W (26 VA)
VAS 1	230 V AC	25 W (26 VA)
VAS 2, VAS 3	24 V DC	36 W
VAS 2, VAS 3	100 V AC	36 W (40 VA)
VAS 2, VAS 3	120 V AC	40 W (44 VA)
VAS 2, VAS 3	200 V AC	40 W (44 VA)
VAS 2, VAS 3	230 V AC	40 W (44 VA)
VBY	24 V DC	8 W
VBY	120 V AC	8 W
VBY	230 V AC	9.5 W

Contact rating of proof of closure switch:

Type	Voltage	Current (resistive load)	
		min.	max.
VAS..S,VCS..S	12–250 V AC, 50/60 Hz	100 mA	3 A
VAS..G,VCS..G	12–30 V DC	2 mA	0.1 A

Switching frequency of proof of closure switch: max. 5 x per minute.

Switching current	Switching cycles*	
	cos $\phi$ = 1	cos $\phi$ = 0.6
0.1	500,000	500,000
0.5	300,000	250,000
1	200,000	100,000
3	100,000	–

\* Limited to max. 200,000 cycles for heating systems.

### 13 AIR FLOW RATE Q

Air flow rate Q for a pressure loss of  $\Delta p = 1$  mbar (0.4 "WC):

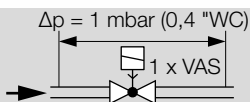

	Air flow rate	
	Q [m³/h]	Q [SCFH]
VAS 110	4.4	155.4
VAS 115	5.6	197.7
VAS 120	8.4	296.6
VAS 125	9.5	335.5
VAS 225	16.7	589.7
VAS 232	21	741.5
VAS 240	23.2	819.2
VAS 250	23.7	836.8
VAS 340	33.6	1,186.4
VAS 350	36.4	1285.3
VAS 365	37.9	1338.2

Air flow rate Q for a pressure loss of  $\Delta p = 10$  mbar (4 "WC):

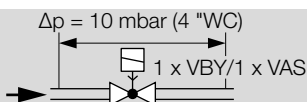

	Air flow rate	
	Q [m³/h]	Q [SCFH]
Bypass valve VBY	0.85	30.01
Pilot gas valve VBY	0.89	31.43

Bypass valve VAS 1: Air flow rate			
Ø [mm]	Q [m³/h]	Ø ["]	Q [m³/h]
1	0.2	0.04	7.8
2	0.5	0.08	17.7
3	0.8	0.12	28.2
4	1.5	0.16	53.1
5	2.3	0.20	81.2
6	3.1	0.24	109.5
7	3.9	0.28	137.7
8	5.1	0.31	180.1
9	6.2	0.35	218.9
10	7.2	0.39	254.2

Pilot gas valve VAS 1: Air flow rate			
Ø [mm]	Q [m³/h]	Ø ["]	Q [m³/h]
10	8.4	0.39	296.6

### 14 DESIGNED LIFETIME

This information on the designed lifetime is based on using the product in accordance with these operating instructions. Once the designed lifetime has been reached, safety-relevant products must be replaced. Designed lifetime (based on date of manufacture) in accordance with EN 13611, EN 161 for VAS, VCS:

Type	Designed lifetime	
	Switching cycles	Time (years)
VAS 110 to 225	500,000	10
VAS 232 to 365	200,000	10
VAS/VCS 665 to 780	100,000	10
VAS/VCS 8100 to 9125	50,000	10

You can find further explanations in the applicable rules and regulations and on the afecor website ([www.afecor.org](http://www.afecor.org)).

This procedure applies to heating systems. For thermoprocessing equipment, observe local regulations.

## 15 CERTIFICATION

### 15.1 Certificate download

Certificates – see [www.docuthek.com](http://www.docuthek.com)

### 15.2 Declaration of conformity



We, the manufacturer, hereby declare that the products VAS/VCS 1–3 with product ID No. CE-0063BO1580 comply with the requirements of the listed Directives and Standards.

Directives:

- 2014/35/EU – LVD
- 2014/30/EU – EMC
- 2011/65/EU – RoHS II
- 2015/863/EU – RoHS III

Regulation:

- (EU) 2016/426 – GAR

Standards:

- EN 161:2011+A3:2013

The relevant product corresponds to the tested type sample.

The production is subject to the surveillance procedure pursuant to Regulation (EU) 2016/426 Annex III paragraph 3.

Elster GmbH

### 15.3 SIL and PL

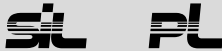

Safety-specific characteristic values, see Safety manual/Technical Information VAS (D, GB, F) – [www.docuthek.com](http://www.docuthek.com).

### 15.4 UKCA certified



Gas Appliances (Product Safety and Metrology etc. (Amendment etc.) (EU Exit) Regulations 2019)

BS EN 161:2011+A3:2013

BS EN 13611:2015

### 15.5 FM listed

Approval does not apply for 100 V AC and 200 V AC.



Factory Mutual (FM) Research Class: 7400 and 7411 Safety overpressure slam shut valves. Designed for applications pursuant to NFPA 85 and NFPA 86.

### 15.6 ANSI/CSA approved

Approval does not apply for 100 V AC and 200 V AC.



Canadian Standards Association – ANSI Z21.21 and CSA 6.5

### 15.7 VAS 1–3 (120 V AC): UL listed



Underwriters Laboratories – UL 429 “Electrically operated valves”.

### 15.8 AGA listed

Approval does not apply for 100 V AC and 200 V AC.



Australian Gas Association, Approval No.: 3968.

### 15.9 Eurasian Customs Union



The products VAS 1–3 meet the technical specifications of the Eurasian Customs Union.

### 15.10 REACH Regulation

The device contains substances of very high concern which are listed in the Candidate List of the European REACH Regulation No. 1907/2006. See Reach list HTS at [www.docuthek.com](http://www.docuthek.com).

### 15.11 China RoHS

Directive on the restriction of the use of hazardous substances (RoHS) in China. Scan of the Disclosure Table China RoHS2, see certificates at [www.docuthek.com](http://www.docuthek.com).

## 16 LOGISTICS

### Transport

Protect the unit from external forces (blows, shocks, vibration).

Transport temperature: see page 14 (12 Technical data).

Transport is subject to the ambient conditions described.

Report any transport damage on the unit or packaging without delay.

Check that the delivery is complete.

### Storage

Storage temperature: see page 14 (12 Technical data).

Storage is subject to the ambient conditions described. Storage time: 6 months in the original packaging before using for the first time. If stored for longer than this, the overall service life will be reduced by the corresponding amount of extra storage time.



## 17 DISPOSAL

Devices with electronic components:

### **WEEE Directive 2012/19/EU – Waste Electrical and Electronic Equipment Directive**



At the end of the product life (number of operating cycles reached), dispose of the packaging and product in a corresponding recycling centre. Do not dispose of the unit with the usual domestic refuse. Do not burn the product. On request, old units may be returned carriage paid to the manufacturer in accordance with the relevant waste legislation requirements.

## FOR MORE INFORMATION

The Honeywell Thermal Solutions family of products includes Honeywell Combustion Safety, Eclipse, Exothermics, Hauck, Kromschroder and Maxon. To learn more about our products, visit [ThermalSolutions.honeywell.com](http://ThermalSolutions.honeywell.com) or contact your Honeywell Sales Engineer.

Elster GmbH  
Strotheweg 1, D-49504 Lotte  
T +49 541 1214-0  
[hts.lotte@honeywell.com](mailto:hts.lotte@honeywell.com)  
[www.kromschroeder.com](http://www.kromschroeder.com)

Global centralized service deployment coordination:  
T +49 541 1214-365 or -555  
[hts.service.germany@honeywell.com](mailto:hts.service.germany@honeywell.com)

Translation from the German  
© 2022 Elster GmbH

**Honeywell**  
**krom**  
**schroder**