

TC10

TEMPERATURE CONTROLLER



Engineering Manual

Code: IM 05C01E81-02EN

Fifth edition: February 2020

Yokogawa Electric Corporation

2-9-32 Nakacho, Musashino-shi, Tokyo 180-8750 Japan

www.yokogawa.com

1. OUTLINE DIMENSIONS (mm)

1.1 INSTRUMENT DIMENSIONS

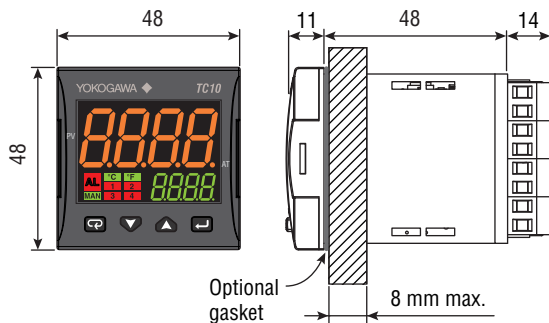

1.2 PANEL CUT-OUT

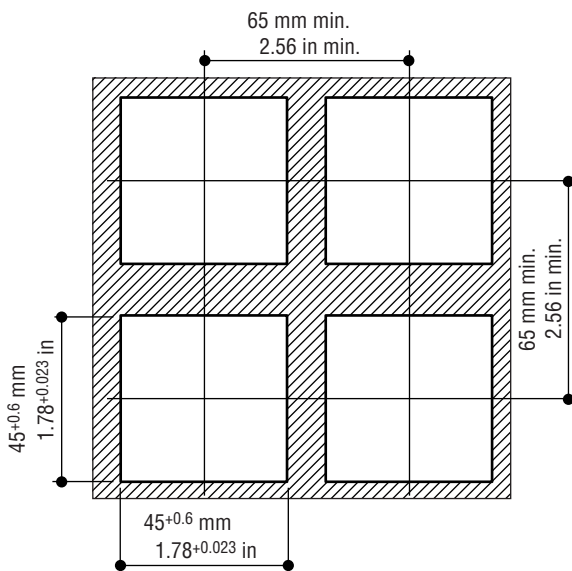

1.3 MOUNTING REQUIREMENTS

This instrument is intended for permanent installation, for indoor use only, in an electrical panel which encloses the rear housing, exposed terminals and wiring on the back.

Select a mounting location having the following characteristics:

1. It should be easily accessible;
2. There is minimum vibrations and no impact;
3. There are no corrosive gases;
4. There are no water or other fluids (i.e. condensation);
5. The ambient temperature is in accordance with the operative temperature (0 to 50°C);
6. The relative humidity is in accordance with the instrument specifications (20 to 90%);

The instrument can be mounted on panel with a maximum thickness of 8 mm.

When the maximum front protection (IP65) is desired, the optional gasket must be mounted.

2. CONNECTION DIAGRAM

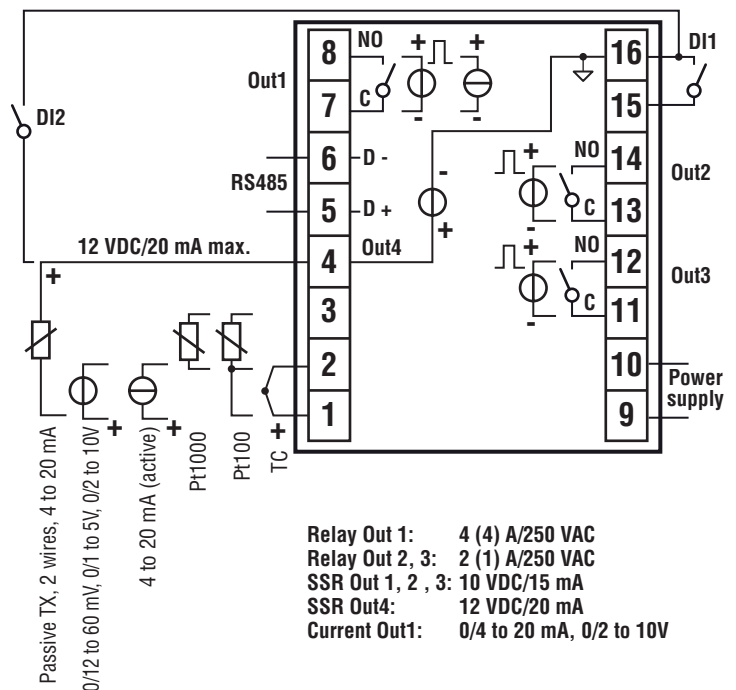

2.1 GENERAL NOTES ABOUT WIRING

1. Do not run input wires together with power cables.
2. External components (like zener barriers, etc.) connected between sensor and input terminals may cause errors in measurement due to excessive and/or not balanced line resistance or possible leakage currents.
3. When a shielded cable is used, it should be connected at one point only.
4. Pay attention to the line resistance; a high line resistance may cause measurement errors.

2.2 INPUTS

2.2.1 Thermocouple Input

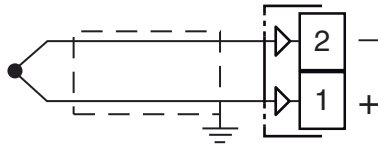

- External resistance:** 100Ω max., maximum error 25 μV.
- Cold junction:** automatic compensation between 0 to 50°C.
- Cold junction accuracy:** 0.05°C/°C after a warm-up of 20 minutes.
- Input impedance:** > 1 MΩ.
- Calibration:** According to EN 60584-1.
- Note:** For TC wiring use proper compensating cable preferable shielded.

2.2.2 RTD Pt 100 Input

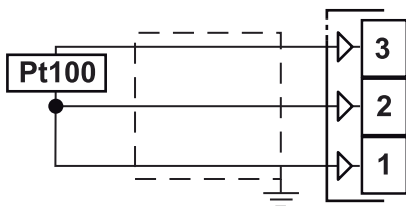

- Input circuit:** Current injection (135 μA).
- Line resistance:** Automatic compensation up to 20Ω/wire with maximum error ±0.1% of the input span.
- Calibration:** According to EN 60751/A2.
- Note:** The resistance of the 3 wires must be the same.

2.2.3 RTD Pt 1000 Input

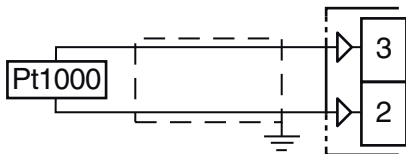

- Line resistance:** Not compensated.
- Pt 1000 input circuit:** Current injection (15 μA).
- Pt 1000 calibration:** According to EN 60751/A2.

2.2.4 V and mV Input

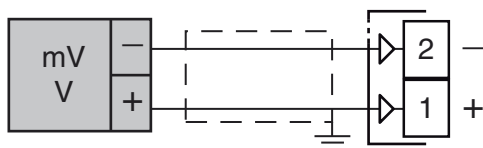

- Input impedance:** > 1 MΩ for mV Input
500 kΩ for Volt Input.

2.2.5 mA Input

0/4 to 20 mA input wiring for passive transmitter using the auxiliary pws

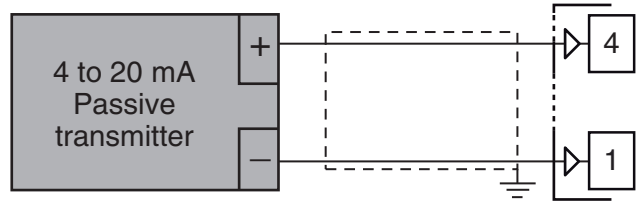

- Input impedance:** < 53Ω.
- Internal auxiliary PWS:** 12 VDC (±10%), 20 mA max..

0/4 to 20 mA input wiring for passive transmitter using an external pws

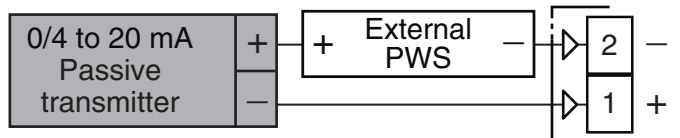

0/4 to 20 mA input wiring for active transmitter

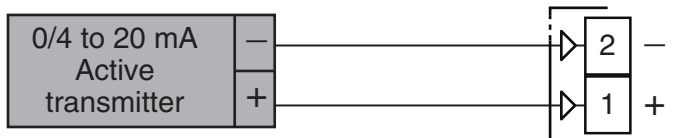

2.2.6 Logic Inputs

Safety notes:

- Do not run logic input wiring together with power cables;
- The instrument needs 150 ms to recognize a contact status variation;
- Logic inputs are **NOT** isolated by the measuring input. A double or reinforced isolation between logic inputs and power line must be assured by the external elements.

Logic inputs driven by dry contact

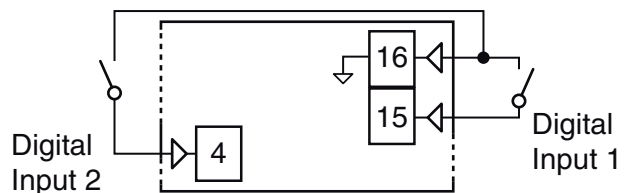

- Maximum contact resistance:** 100Ω.
- Contact rating:** DI1 = 10 V, 6 mA;
DI2 = 12 V, 30 mA.

Logic input driven by 24 VDC

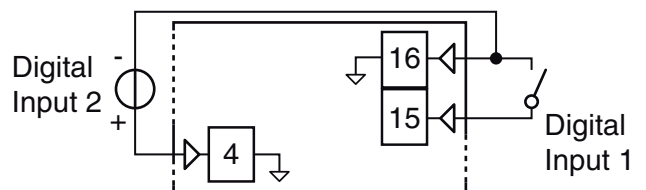

- Logic status 1:** 6 to 24 VDC;
- Logic status 0:** 0 to 3 VDC.

2.3 OUTPUTS

Safety notes:

- To avoid electrical shocks, connect power line at last.
- For supply connections use No. 16 AWG or larger wires rated for at least 75°C.
- Use copper conductors only.
- SSR outputs are not isolated. A reinforced isolation must be assured by the external solid state relays.
- For SSR, mA and V outputs if the line length is longer than 30 m use a shielded wire.
- Do not short-circuit the terminals of the SSR output.

WARNING! Before connecting the output actuators, we recommend to configure the parameters to suit your application (e.g.: input type, Control strategy, alarms, etc.).

2.3.1 Output 1 (OP1)

Relay Output

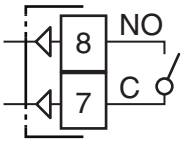

Contact rating: • 4 A /250 V $\cos\phi = 1$;
• 1 A /250 V $\cos\phi = 0.4$.

Operation: 1×10^5 .

SSR Output

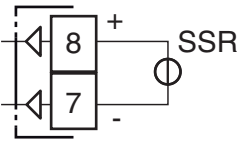

Logic level 0: $V_{out} < 0.5 \text{ VDC}$;
Logic level 1: $12 \text{ V} \pm 20\%$, 15 mA max..

Current Analog Output

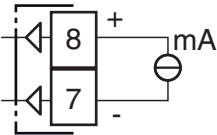

mA output: 0/4... 20 mA, galvanically isolated, R_L max. 600Ω.

Voltage Analog Output

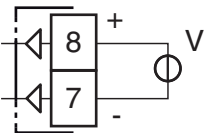

V output: 0/2... 10 V, galvanically isolated, R_L min.: 500Ω.

2.3.2 Output 2 (OP2)

Relay Output

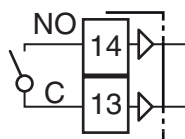

Contact rating: • 2 A /250 V $\cos\phi = 1$;
• 1 A /250 V $\cos\phi = 0.4$.

Operation: 1×10^5 .

SSR Output

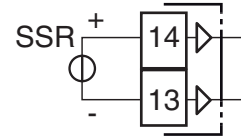

Logic level 0: $V_{out} < 0.5 \text{ VDC}$;

Logic level 1: $12 \text{ V} \pm 20\%$, 15 mA max..

2.3.3 Output 3 (OP3)

Relay Output

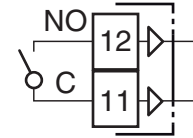

Contact rating: • 2 A /250 V $\cos\phi = 1$;
• 1 A /250 V $\cos\phi = 0.4$.

Operation: 1×10^5 .

SSR Output

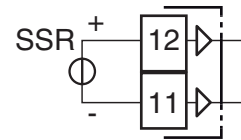

Logic level 0: $V_{out} < 0.5 \text{ VDC}$;

Logic level 1: $12 \text{ V} \pm 20\%$, 15 mA max..

2.3.4 Output 4 (OP4)

SSR Output

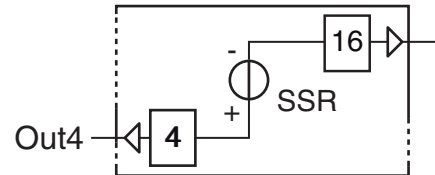

Logic level 0: $V_{out} < 0.5 \text{ VDC}$;

Logic level 1: $12 \text{ V} \pm 20\%$, 20 mA max..

Note: Overload protected.

2.4 SERIAL INTERFACE

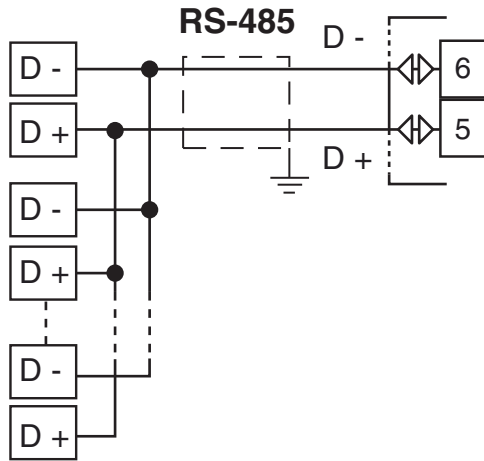

Interface type: Isolated (50 V) RS-485;
Voltage levels: According to EIA standard;
Protocol type: Modbus RTU;
Byte format: 8 bit with no parity;
Stop bit: 1 (one);
Baud rate: Programmable between 1200 to 38400 baud;
Address: Programmable between 1 to 254.

Notes: 1. RS-485 interface allows to connect up to 30 devices with one remote master unit.
 2. The cable length must not exceed 1.5 km at 9600 baud.

2.5 POWER SUPPLY

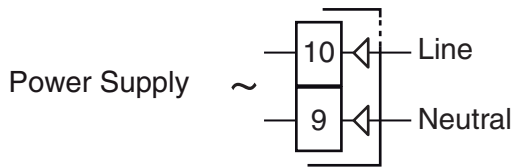

Supply Voltage: • 24 VAC/DC ($\pm 10\%$);
 • 100 to 240 VAC (-15 to $+10\%$) 50/60 Hz.

Notes: 1. Before connecting the instrument to the power line, make sure that line voltage is equal to the voltage shown on the identification label;
 2. The polarity of the power supply has no importance;
 3. The power supply input is NOT fuse protected. Please, provide a T type 1A, 250 V fuse externally.

3. TECHNICAL CHARACTERISTICS

3.1 TECHNICAL SPECIFICATION

Case: Plastic, self-extinguishing degree: V-0 according to UL 94;

Front protection: IP 65 (when the optional panel gasket is mounted) for indoor locations according to EN 60070-1;

Terminals protection: IP 20 according to EN 60070-1;

Installation: Panel mounting;

Terminal block: 16 screw terminals for cables of 0.25 to 2.5 mm² (AWG22 to AWG14) with connection diagram, tightening torque 0.5 Nm;

Dimensions: 48 x 48, depth 73 mm, (1.89 x 1.89 x 2.87 in.)

Panel cutout: 45_[-0, +0.6] x 45_[-0, +0.6] mm
 (1.78_[-0.000, +0.023] x 1.78_[-0.000, +0.023] in.)

Weight: 180 g max..

Power supply: • 24 VAC/DC ($\pm 10\%$ of the nominal value);
 • 100 to 240 VAC (-15 to $+10\%$ of the nominal value) 50/60 Hz;

Power consumption: 5.5 VA max. (24 VAC/DC)
 6.5 VA max. (100 to 240 VAC);

Insulation voltage: 2300 V rms according to EN 61010-1;

Display updating time: 500 ms;

Sampling time: 130 ms;

Resolution: 30000 counts;

Total Accuracy: $\pm 0.5\%$ F.S.V. ± 1 digit @ 25°C of room temperature;

Electromagnetic compatibility and safety requirements

Compliance: directive EMC 2004/108/CE (EN 61326-1),
 directive LV 2006/95/CE (EN 61010-1),
 UL 61010-1 CSA 61010-1;

Note: During the test, the instrument continues to operate at the measurement accuracy within specification.

Installation category: II;

Pollution category: 2;

Installation altitude: Less than 2000 m on sea level

Temperature drift: It is part of the global accuracy;

Operating temperature: 0 to 50°C (32 to 122°F);

Operating humidity: 20 to 90% RH, not condensing.

Storage temperature: -20 to +70°C (-4 to +158°F);

Storage humidity: 20 to 95% RH, not condensing.

4. MODEL AND SUFFIX CODES

Model Code	Suffix codes	Description
TC10	-N □ C □ □ □ □ D □ F	Temperature Controller
Fixed code	-N	Always "-N"
Power supply	L : H :	24 VAC/DC (Custom order) 100 to 240 VAC
Fixed code	C	Always "C"
OUT1 - 3	R : N : N	Relay output for on/off control
	R : R : R	Relay output with 2 alarm relays, for ON/OFF or Heat/Cool control with 1 alarm
	V : N : N	DC Output for SSR
	V : R : R	DC Output for SSR with 2 alarm relays or DCV and relay output for Heat/Cool control with 1 alarm
	V : V : R	2 DCV outputs for SSR with 1 relay (Custom order)
	A : R : R	Analog output with 2 alarm relays, or analog output and relay output for Heat/Cool control with 1 alarm
IN/OUT4 (Fixed code)	D :	Always "D" - Selectable I/O (logic input/12 V SSR drive output/12VDC 20 mA transmitter power supply)
Serial communication	S :	RS485 Modbus
	N :	None
Fixed code	F	Always "F"
Option Code	/GK	Panel gasket for IP65

5. CONFIGURATION PROCEDURE

5.1 INTRODUCTION

When the instrument is powered, it starts immediately to work according to the parameters values loaded in its memory.

The instrument behaviour and its performance are governed by the value of the stored parameters.

At the first start up the instrument will use a “default” parameter set (factory parameter set); this set is a generic one (e.g. a TC J input is programmed).

WARNING! Before connecting the output actuators, we recommend to configure the parameters to suit your application (e.g.: input type, Control strategy, alarms, etc.).

To change these parameters you need to enter the “Configuration mode”.



5.2 INSTRUMENT BEHAVIOUR AT POWER ON

At power ON the instrument can start in one of the following mode depending on its configuration:

Auto mode

- The upper display shows the measured value;
- The lower display shows the Set point value;
- The decimal figure of the less significant digit of the lower display is OFF;
- The instrument is performing the standard closed loop control.

Manual mode (OPLO)

- The upper display shows the measured value;
- The lower display shows the power output [preceded by H (for heating) or C (for cooling)]. The MAN LED is lit;
- The instrument does not perform Automatic control;
- The control output is equal to 0% and can be manually modified by  and  buttons.

Stand by mode (St.bY)

- The upper display shows the measured value;
- The lower display shows alternately the set point value and the message *St.bY* or *o.d*;
- The instrument performs no control (the control outputs are OFF);
- The instrument is working as an indicator.

We define all the above described conditions as “**Standard Display**”.

5.3 HOW TO ENTER THE “CONFIGURATION MODES”

Note: The TC10 is equipped with two different “configuration” methods:

- A)** The “code” configuration method;
- B)** The “complete” configuration method.

The “**code**” configuration method is really fast but modifies only the most common configuration parameters.

The “**complete**” configuration method allows to take advantage of all instrument features, giving more capabilities it requires more actions and time.

Note that you can take advantage by both methods because if you use the code configuration and then you enter in the complete configuration, all selections made by code are still valid. In both cases the instrument have one complete parameter set. We call this set “configuration parameter set” (or “configuration parameters”).

When code configuration method is used all the parameters not modified by the code will maintain their default values.

In both cases the access to the configuration parameters is protected by a password (a specific password for each method).

Note: The instrument will show only the parameters consistent with the specific hardware and in accordance with the value assigned to the previous parameters (e.g.: if you set an output as “not used” the instrument will mask all other parameters related to this output).





5.3.1 “Code” configuration procedure

The controller configuration (Input type, Control mode, etc.) can be made entering two 4-digit codes.

Before to enter into code configuration we suggest you to prepare the two codes according to the tables that follow.

- Notes:**
1. During the Code configuration procedure there is no timeout.
 2. To leave, at any time, the Configuration session **without saving** the settings made, press the  button.

To enter into code configuration proceed as follows:

1. Push the  button for more than 3 seconds. The upper display will show *PASS* (flashing) while the lower display will show *0*;
2. Using  and  buttons set the password programmed in parameter [120] *PAS4*. The factory default password for Code configuration is **300**;
3. Push the  button;
If the password is correct the instrument will show one of the following conditions:
 - If no code is present, the display shows *codE* on the upper display and *oFF* on the lower display. Push the  button to continue. The upper display will flash *cod 1* while the lower display shows *0000*.
 - If a previous code was stored, the upper display will flash *cod 1* while the lower display shows the value of *cod 1* stored in memory.

4. Using and buttons set the code 1 value according to the following tables.

Prepare your code 1

L	M	N	O
<input type="text"/>	<input type="text"/>	<input type="text"/>	<input type="text"/>

Input Type and Range	L	M
TC J	-50 to +1000°C	0 0
TC K	-50 to +1370°C	0 1
TC S	-50 to 1760°C	0 2
TC R	-50 to +1760°C	0 3
TC T	-70 to +400°C	0 4
PT 100	-200 to +850°C	0 7
PT 1000	-200 to +850°C	0 8
Linear 0 to 60 mV		0 9
Linear 12 to 60 mV		1 0
Linear 0 to 20 mA (this selection forces Out 4 = TX)		1 1
Linear 4 to 20 mA (this selection forces Out 4 = TX)		1 2
Linear 0 to 5 V		1 3
Linear 1 to 5 V		1 4
Linear 0 to 10 V		1 5
Linear 2 to 10 V		1 6
TC J	-58 to +1832°F	1 7
TC K	-58 to +2498°F	1 8
TC S	-58 to 3200°F	1 9
TC R	-58 to +3200°F	2 0
TC T	-94 to +752°F	2 1
PT 100	-328 to +1562°F	2 4
PT 1000	-328 to +1562°F	2 5

Code 1:

L	M	N	O
<input type="text"/>	<input type="text"/>	<input type="text"/>	<input type="text"/>

Control mode	OP1	OP2	OP3	OP4	N	O
ON/OFF heating = H	H	AL1	AL2	AL3	0	0
	NU	AL1	AL2	H	0	1
ON/OFF cooling = C	C	AL1	AL2	AL3	0	2
	NU	AL1	AL2	C	0	3
ON/OFF with neutral zone (H/C)	H	C	AL2	AL3	0	4
	H	AL1	AL2	C	0	5
	C	H	AL2	AL3	0	6
	NU	H	AL2	C	0	7
	C	AL1	AL2	H	0	8
	NU	C	AL2	H	0	9
PID heating = H	H	AL1	AL2	AL3	1	0
	NU	AL1	AL2	H	1	1
PID cooling = C	C	AL1	AL2	AL3	1	2
	NU	AL1	AL2	C	1	3
PID double action (H/C)	H	C	AL2	AL3	1	4
	H	AL1	AL2	C	1	5
	C	H	AL2	AL3	1	6
	NU	H	AL2	C	1	7
	C	AL1	AL2	H	1	8
	NU	C	AL2	H	1	9

5. Push the button.

The upper display shows *cod2* flashing while the lower display shows 0000 or the *cod2* value stored in memory.

6. Using and buttons set the code 2 value according to the following tables.

Prepare your code 2

P	Q	R	S
<input type="text"/>	<input type="text"/>	<input type="text"/>	<input type="text"/>

Alarm 3			R
Alarm 2			Q
Alarm 1			P
Not used			0 0 0
Sensor break			1 1 1
Absolute	High		2 2 2
	Low		3 3 3
Absolute High/Low	External High/Low		4 4 4
	Internal High/Low		5 5 5
Deviation	Deviation high		6 6 6
	Deviation low		7 7 7
Band	External band		8 8 8
	Internal band		9 9 9

Code 2:

P	Q	R	S
<input type="text"/>	<input type="text"/>	<input type="text"/>	<input type="text"/>

Auxiliary functions activation	S
None	0
Wattmeter (instantaneous power expressed in W)	1
Wattmeter (energy expressed in Wh)	2
Absolute worked time (expressed in days)	3
Absolute worked time (expressed in hours)	4

7. Push the button.

If the just entered codes are accepted, the upper display shows *codE* while the lower display shows *Ecod*.



8. Push the button to save the configuration code and exit the Code configuration procedure.

Note: After using the “Code configuration” method, it will always be possible to modify the parameters using the “Complete configuration” method. If the value of a parameter among those included in the configuration codes (*cod 1 - cod 2*) gets modified, the instrument will acquire the change while maintaining all the other parameters.

WARNING! After a parameter change made as described in the previous “Note”, when retrieving the configuration codes (*cod 1 - cod 2*), the lower display will show “OFF” to alert the operator that one of the parameters has been changed.

5.3.2 Complete configuration procedure

The configuration parameters are collected in various groups. Every group defines all parameters related with a specific function (e.g.: control, alarms, output functions).

1. Push the  button for more than 3 seconds. The upper display will show *PASS* while the lower display will show *0*.
2. Using  and  buttons set the programmed password.

Notes: 1. The factory default password for configuration parameters is equal to 30.
2. During parameter modification the instrument continue to perform the control.
In certain conditions, when a configuration change can produce a heavy bump to the process, it is advisable to temporarily stop the controller from controlling during the programming procedure (control output will be OFF).
A password equal to 2000 + the programmed value (e.g. 2000 + 30 = 2030).
The control will restart automatically when the configuration procedure will be manually closed.

Push the  button

If the password is correct the display will show the acronym of the first parameter group preceded by the symbol: .

In other words the upper display will show:  *inP* (group of the **Input parameters**).

The instrument is in configuration mode.



5.4 HOW TO EXIT THE “CONFIGURATION MODE”



Push  button for more than 3 seconds, the instrument will come back to the “standard display”.



5.5 KEYBOARD FUNCTIONS DURING PARAMETER CHANGING

 A short press allows to exit from the current parameter group and select a new parameter group.
A long press allows you to close the configuration parameter procedure (the instrument will come back to the “standard display”).

 When the upper display is showing a group and the lower display is blank, this key allows to enter in the selected group.
When the upper display is showing a parameter and the lower display is showing its value, this key allows to store the selected value for the current parameter and access the next parameter within the same group.

 Allows to increase the value of the selected parameter.
 Allows to decrease the value of the selected parameter.

 +  These two keys allow to return to the previous group. Proceed as follows:

Push the  button and maintaining the pressure, then push the  button; release both the buttons.

Note: The group selection is cyclic as well as the selection of the parameters in a group.





5.6 FACTORY RESET - DEFAULT PARAMETERS LOADING PROCEDURE

Sometime, e.g. when you re-configure an instrument previously used for other works or from other people or when you have made too many errors during configuration and you decided to re-configure the instrument, it is possible to restore the factory configuration.

This action allows to put the instrument in a defined condition (the same it was at the first power ON).

The default data are those typical values loaded in the instrument prior to ship it from factory.

To load the factory default parameter set, proceed as follows:

1. Press the  button for more than 5 seconds. The upper display will show *PASS* while the lower display shows *0*;
2. Using  and  buttons set the value -481;
3. Push  button;
4. The instrument will turn OFF all LEDs for a few seconds, then the upper display will show *dFLt* (default) and then all LEDs are turned ON for 2 seconds. At this point the instrument restarts as for a new power ON.

The procedure is complete.

Note: The complete list of the default parameters is available in Appendix A.

5.7 CONFIGURING ALL THE PARAMETERS

In the following pages we will describe all the parameters of the instrument. However, the instrument will only show the parameters applicable to its hardware options in accordance with the specific instrument configuration (i.e. setting *AL 1t* [Alarm 1 type] to *none* [not used], all parameters related to alarm 1 will be skipped).

inP Group - Main and auxiliary input configuration

[1] *SEnS* - Input type

Available: Always

Range: J = TC J
crAL = TC K
S = TC S
r = TC R
t = TC T
Pt1 = RTD Pt 100
Pt10 = RTD Pt 1000
0.60 = 0 to 60 mV linear
12.60 = 12 to 60 mV linear
0.20 = 0 to 20 mA linear
4.20 = 4 to 20 mA linear
0.5 = 0 to 5 V linear
1.5 = 1 to 5 V linear
0.10 = 0 to 10 V linear
2.10 = 2 to 10 V linear

- Notes:** 1. When a TC input is selected and a decimal figure is programmed (see the next parameter) the max. displayed value becomes 999.9°C or 999.9°F.
2. Every change of the *SEnS* parameter setting will force the [2] *dP* = 0 and it will change all parameters related with *dP* (e.g. set points, proportional band, etc.).

[2] dP - Decimal point position

Available: Always.

Range: 0 to 3 when [1] SenS = Linear input;
0 or 1 when [1] SenS different from linear input.

Note: Every change of the dP parameter setting will produce a change of the parameters related with it (e.g.: set points, proportional band, etc.).

[3] SSc - Initial scale read-out for linear inputs

Available: When a linear input is selected by [1] SEnS.

Range: -1999 to 9999.

Notes: 1. SSc allows the scaling of the analog input to set the minimum displayed/measured value. The instrument will show a measured value less than SSC value for a certain range and than it will show an underrange error or a sensor break error.
E.g.:
0 mA = 0 mBar and 20 mA = -1000 mBar (vacuum).

[4] FSc - Full scale read-out for linear input

Available: When a linear input is selected by [1] SEnS.

Range: -1999 to 9999.

Notes: 1. Fsc allows the scaling of the analog input to set the maximum displayed/measured value. The instrument will show a measured value higher than FSc value for a certain range and than it will show an overrange error or a sensor break error.
2. It is possible to set a full scale read-out lower than the initial scale read-out in order to obtain a reverse read-out scaling.
E.g.:
0 mA = 0 mBar and 20 mA = -1000 mBar (vacuum).

[5] unit - Engineering unit

Available: When a temperature sensor is selected by [1] SEnS parameter.

Range: °C = Celsius;
°F = Fahrenheit.

[6] FiL - Digital filter on the measured value

Available: Always.

Range: oFF (No filter);
0.1 to 20.0 s.

Note: This is a first order digital filter applied on the measured value. For this reason it will affect the measured value but also the control action and the alarms behaviour.

[7] inE - Selection of the Sensor Out of Range type that will enable the safety output value

Available: Always.

Range: **our** = When an overrange or an underrange is detected, the power output will be forced to the value of [8] oPE parameter;
or = When an overrange is detected, the power output will be forced to the value of [8] oPE parameter;
ur = When an underrange is detected, the power output will be forced to the value of [8] oPE parameter.

[8] oPE - Safety output value

Available: Always.

Range: -100 to 100 % (of the output).

Notes: 1. When the instrument is programmed with one control action only (heat or cool), setting a value outside of the available output range, the instrument will use Zero.

E.g.: When heat action only has been programmed, and oPE is equal to -50% (cooling) the instrument will use Zero.

2. When ON/OFF control is programmed and an out of range is detected, the instrument will perform the safety output value using a fixed cycle time equal to 20 seconds.

[9] io4.F - I/O4 function selection

Available: Always.



Range: on = Out4 will be ever ON (used as a transmitter power supply);
out4 = Used as digital output 4;
dG2.c = Digital input 2 for contact closure;
dG2.U = Digital input 2 driven by 12 to 24 VDC.

Notes: 1. Setting [9] io4.F = dG2.C or dG2.U, the [25] O4F parameter becomes not visible while [11] diF2 parameter will become visible.
2. Setting [9] io4.F = on the [25] O4F parameter and the [11] diF2 parameter will NOT be visible.
3. Setting [9] io4.F different from dG2.c or dG2.U, the instrument will force [13] diF2 parameter equal to nonE. If [11] diF1 was equal to (SP4 or UPDN) it will be forced to nonE.
4. The transfer from [9] io4.F = ON to [9] io4.F = Out4 will make the [25] O4F parameter visible equal to nonE.

[10] diF1 - Digital input 1 function

Available: Always.

Range: oFF = No function;



- 1 Alarm Reset [status];
- 2 Alarm acknowledge (ACK) [status];
- 3 Hold of the measured value [status]
When the contact is closed the instrument operates in hold of the measured value;
- 4 Stand by mode of the instrument [status]
When the contact is closed the instrument operates in stand by mode;
- 5 Manual mode
When the contact is closed the instrument operates in manual mode;
- 6 HEAt with SP1 and Cool with "SP2" [status]
(see "Note about digital inputs");
- 7 to 17 Reserved;
- 18 Sequential set point selection [transition]
(see "Note about digital inputs");
- 19 SP1/SP2 selection [status];
- 20 Binary selection of the set point made by digital input 1 (less significant bit) and digital input 2 (most significant bit) [status];
- 21 Digital input 1 will work in parallel with  button while digital input 2 will work in parallel with the  button.

Note: When [11] diF2 is not available, items 20 and 21 are not visible.

[11] diF2 - Digital input 2 function

Available: When [9] Io4.F = diG2.

Range: oFF = No function;

- 1 Alarm Reset [status];
- 2 Alarm acknowledge (ACK) [status];
- 3 Hold of the measured value [status]
When the contact is closed the instrument operates in hold of the measured value;
- 4 Stand by mode of the instrument [status]
When the contact is closed the instrument operates in stand by mode;
- 5 Manual mode
When the contact is closed the instrument operates in manual mode;
- 6 HEAt with SP1 and Cool with "SP2" [status] (see "Note about digital inputs");
- 7 Timer Run/Hold/Reset [transition]
Short closure allows to start timer execution and to suspend it while a long closure (longer than 10 seconds) allows to reset the timer;
- 7 to 17 Reserved;
- 18 Sequential set point selection [transition] (see "Note about digital inputs");
- 19 SP1/SP2 selection [status];
- 20 Binary selection of the set point made by digital input 1 (less significant bit) and digital input 2 (most significant bit) [status];
- 21 Digital input 1 will work in parallel with the  button while digital input 2 will work in parallel with the  button.

- Notes:**
1. When [10] diF1 or [11] diF2 (e.g. diF1) are equal to 6 the instrument operates as follows:
 - When the contact is open, the control action is an heating action and the active set point is SP.
 - When the contact is closed, the control action is a cooling action and the active set point is SP2.
 2. When [10] diF1 = 20, [11] diF2 setting is forced to 20 and diF2 cannot perform another function.
 3. When [10] diF1 = 20 and [11] diF2 = 20, the set point selection will be in accordance with the following table:

Dig In1	Dig. In2	Operative set point
Off	Off	Set point 1
On	Off	Set point 2
Off	On	Set point 3
On	On	Set point 4

4. When [10] diF1 is equal to 21, [11] diF2 setting is forced to up.du (21 value) and cannot perform another function.
5. When a "Sequential set point selection" is used (diF1 or diF2 = 18), every closure of of the logic input increase the value of SPAT (active set point) of one step. The selection is cyclic:
SP -> SP2 -> SP3 -> SP4.

[12] di.A - Digital Inputs Action

Available: Always.

Range: 0 = DI1 Direct action,
DI2 (if configured) Direct action;
1 = DI1 Reverse action,
DI2 (if configured) Direct action;

2 = DI1 Direct action,
DI2 (if configured) Reverse action;
3 = DI1 Reverse action,
DI2 (if configured) Reverse action.

Out Group - Output parameters

[13] o1.t - Out 1 type

Available: When the out 1 is a linear output.

Range: 0.200 to 20 mA;
4.20 4 to 20 mA;
0.10 0 to 10 V;
2.10 2 to 10 V.

[14] o1.F - Out 1 function

Available: Always.

Range: • When the out 1 is a linear output:

nonE = Output not used. With this setting the status of this output can be driven directly from serial link;
H.rEG = Heating output;
c.rEG = Cooling output;
r.inP = Measured value Analog retransmission.
r.Err = Analog retransmission of the measured error (PV-SP);
r.SP = Analog retransmission of the operative set point;
r.SEr = Analog retransmission of a value coming from serial link;

• When the out 1 is a digital output (relay or SSR):
nonE = Output not used. With this setting the status of this output can be driven directly from serial link;

H.rEG = Heating output;
c.rEG = Cooling output;
AL = Alarm output;
t.out = Reserved;
t.HoF = Reserved;
P.End = Reserved;
P.HLd = Reserved;
P.uit = Reserved;
P.run = Reserved;
P.Et1 = Reserved;
P.Et2 = Reserved;
or.bo = Out-of-range or burn out indicator;
P.FAL = Power failure indicator;
bo.PF = Out-of-range, Burnout and Power failure indicator;
St.By = Stand By status indicator;
diF1 = Repeats the digital input 1 status;
diF2 = Repeats the digital input 2 status;
on = Out1 always ON;
riSP = Inspection request.

- Notes:**
1. When two or more outputs are programmed in the same way, these outputs will be driven in parallel.
 2. The power failure indicator will be reset when the instrument detect an alarm reset command by  key, digital input or serial link.
 3. When no control output is programmed, all the relative alarm (when present) will be forced to nonE (not used).

[15] A.o1L - Initial scale value of the analog retransmission

Available: When Out 1 is a linear output and [14] O1F is equal to r.inp, r.Err, r.SP or r.SEr

Range: -1999 to [16] Ao1H.

[16] A.o1H - Full scale value of the analog retransmission

Available: When Out 1 is a linear output and [14] O1F is equal to r.inp, r.Err, r.SP or r.SEr.

Range: [15] Ao1L to 9999.

[17] o1.AL - Alarms linked up with the out 1

Available: When [14] o1F = AL.

Range: 0 to 63 with the following rules:

- +1 = Alarm 1;
- +2 = Alarm 2;
- +4 = Alarm 3;
- +8 = Loop break alarm;
- +16 = Sensor break (burn out);
- +32 = Overload on Out4 (short circuit on the Out4).

Example 1: Setting 3 (2+1) the output will be driven by the alarm 1 and 2 (OR condition).

Example 2: Setting 13 (8+4+1) the output will be driven by alarm 1 + alarm 3 + loop break alarm.

[18] o1.Ac - Out 1 action

Available: When [14] o1F is different from "nonE".

Range: dir = Direct action;
rEU = Reverse action;
dir.r = Direct action with revers LED indication;
rEU.r = Reverse action with reverse LED indication.

Notes: 1. Direct action: the output repeats the status of the driven element.

E.g.: The output is an alarm output with direct action. When the alarm is ON, the relay will be energized (logic output 1).

2. Reverse action: the output status is the opposite of the status of the driven element.

E.g.: The output is an alarm output with reverse action. When the alarm is OFF, the relay will be energized (logic output 1). This setting is usually named "fail-safe" and it is generally used in dangerous process in order to generate an alarm when the instrument power supply goes OFF or the internal watchdog starts.

[19] o2F - Out 2 function

Available: When the instrument has out 2 option.

Range: nonE = Output not used. With this setting the status of the this output can be driven directly from serial link;

- H.rEG = Heating output (see warning);
- c.rEG = Cooling output;
- AL = Alarm output;
- t.out = Reserved;
- t.HoF = Reserved;
- P.End = Reserved;
- P.HLd = Reserved;
- P.uit = Reserved;
- P.run = Reserved;
- P.Et1 = Reserved;
- P.Et2 = Reserved;
- or.bo = Out-of-range or burn out indicator;
- P.FAL = Power failure indicator;

bo.PF = Out-of-range, Burnout and Power failure indicator;

St.By = Stand By status indicator;

diF1 = Out2 repeats the digital input 1 status;

diF2 = Out2 repeats the digital input 2 status;

on = Out 2 always ON;

riSP = Inspection request. For other details see [14] O1F parameter.

[20] o2.AL - Alarms linked up with Out 2

Available: When [18] o2F = AL.

Range: 0 to 63 with the following rule:

- +1 = Alarm 1;
- +2 = Alarm 2;
- +4 = Alarm 3;
- +8 = Loop break alarm;
- +16 = Sensor break (burn out);
- +32 = Overload on Out 4 (short circuit on OP4).

For more details see [17] o1.AL parameter.

[21] o2Ac - Out 2 action

Available: When [19] o2F is different from "nonE".

Range: dir = Direct action;
rEU = Reverse action;
dir.r = Direct action with revers LED indication;
rEU.r = Reverse action with reverse LED indication.

For more details see [18] o1.Ac parameter.

[22] o3F - Out 3 function

Available: When the instrument has out 3 option.

Range: nonE = Output not used. With this setting the status of the this output can be driven directly from serial link;

- H.rEG = Heating output;
- c.rEG = Cooling output;
- AL = Alarm output;
- t.out = Reserved;
- t.HoF = Reserved;
- P.End = Reserved;
- P.HLd = Reserved;
- P.uit = Reserved;
- P.run = Reserved;
- P.Et1 = Reserved;
- P.Et2 = Reserved;

or.bo = Out-of-range or burn out indicator;

P.FAL = Power failure indicator;

bo.PF = Out-of-range, burn out and Power failure indicator;

St.By = Stand By status indicator

diF1 = The output repeats the digital input 1 status;

diF2 = The output repeats the digital input 2 status;

on = Out 3 always ON;

riSP = Inspection request.

For other details see [14] O1F parameter.

[23] o3.AL - Alarms linked up with Out 3

Available: When [21] o3F = AL.

Range: 0 to 63 with the following rule:

- +1 = Alarm 1;
- +2 = Alarm 2;
- +4 = Alarm 3;
- +8 = Loop break alarm;
- +16 = Sensor break (burn out);
- +32 = Overload on Out 4 (short circuit on OP 4).

For more details see [17] o1.AL parameter.

[24] o3Ac - Out 3 action

Available: when [21] o3F is different from “nonE”.

Range: dir = Direct action;
 rEU = Reverse action;
 dir.r = Direct action with revers LED indication;
 rEU.r = Reverse action with reverse LED indication.

For more details see [18] o1.Ac parameter.

[25] o4F - Out 4 function

Available: When the [9] io4.F = Out4.

Range: nonE = Output not used. With this setting the status of the this output can be driven directly from serial link.

H.rEG = Heating output;
 c.rEG = Cooling output;
 AL = Alarm output;
 t.out = Reserved;
 t.HoF = Reserved;
 P.End = Reserved;
 P.HLd = Reserved;
 P.uit = Reserved;
 P.run = Reserved;
 P.Et1 = Reserved;
 P.Et2 = Reserved;
 or.bo = Out-of-range or burn out indicator;
 P.FAL = Power failure indicator;
 bo.PF = Out-of-range, burn out and Power failure indicator;
 St.By = Stand By status indicator.

For other details see [14] O1F parameter.

[26] o4.AL - Alarms linked up with Out 4

Available: When [25] o4F = AL.

Range: 0 to 63 with the following rule.
 +1 = Alarm 1;
 +2 = Alarm 2;
 +4 = Alarm 3;
 +8 = loop break alarm;
 +16 = Sensor break (burn out);
 +32 = overload on Out 4 (short circuit on OP4).

For more details see [17] o1.AL parameter.

[27] o4Ac - Out 4 action

Available: When [25] o4F is different from “nonE”.

Range: dir = Direct action;
 rEU = Reverse action;
 dir.r = Direct action with revers LED indication;
 rEU.r = Reverse action with reverse LED indication.

For more details see [18] o1.Ac parameter.

AL1 Group - Alarm 1 parameters

[28] AL1t - Alarm 1 type

Available: Always.

Range: • When one or more outputs are programmed as control output:
 nonE = Alarm not used;
 LoAb = Absolute low alarm;
 HiAb = Absolute high alarm;
 LHAo = Absolute band alarm with alarm indication out of the band;
 LHAi = Absolute band alarm with alarm indication inside the band;
 SE.br = Sensor break;

LodE = Deviation low alarm (relative);
 HidE = Deviation high alarm (relative);
 LHdo = Relative band alarm with alarm indication out of the band;
 LHdi = Relative band alarm with alarm indication inside the band.
 • When no output is programmed as control output:
 nonE = Alarm not used;
 LoAb = Absolute low alarm;
 HiAb = Absolute high alarm;
 LHAo = Absolute band alarm with alarm indication out of the band;
 LHAi = Absolute band alarm with alarm indication inside the band;
 SE.br = Sensor break.

Notes: 1. The relative and deviation alarms are “relative” to the operative set point value.

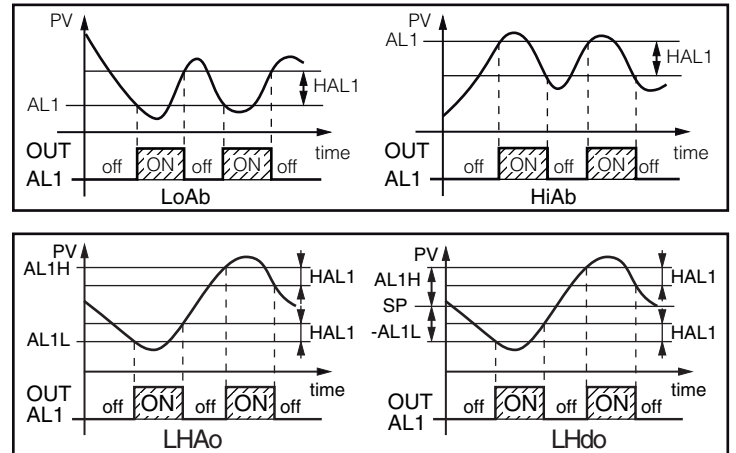

2. The (SE.br) sensor break alarm will be ON when the display shows - - - - indication.

[29] Ab1 - Alarm 1 function

Available: When [28] AL1t is different from “nonE”.

Range: 0 to 15 with the following rule:
 +1 = Not active at power up;
 +2 = Latched alarm (manual reset);
 +4 = Acknowledgeable alarm;
 +8 = Relative alarm not active at set point change.

Example: Setting Ab1 equal to 5 (1+4) the alarm 1 will be “not active at power up” and “Acknowledgeable”.

Notes: 1. The “not active at power up” selection allows to inhibit the alarm function at instrument power up or when the instrument detects a transfer from:
 • Manual mode (oplo) to auto mode;
 • Stand-by mode to auto mode.

The alarm will be automatically enabled when the measured value reaches, for the first time, the alarm threshold ± hysteresis (in other words, when the initial alarm condition disappears).

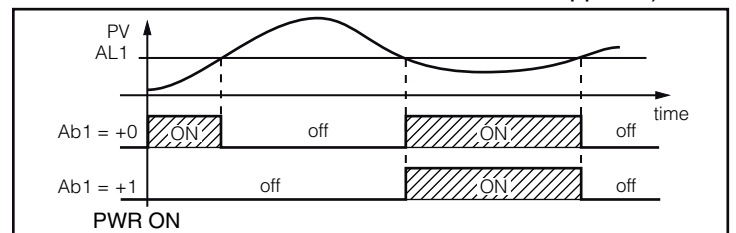

2. A “Latched alarm” (manual reset) is an alarm that will remain active even if the conditions that generated the alarm no longer persist. Alarm

reset can be done only by an external command (☐ button, digital inputs or serial link).

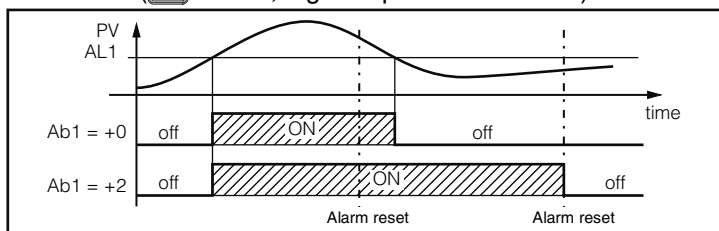

3. An “Acknowledgeable” alarm is an alarm that can be reset even if the conditions that generated the alarm are still present. Alarm acknowledge can be done only by an external command (☐ button, digital inputs or serial link).

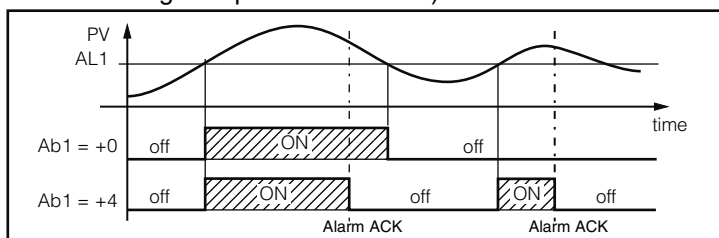

A “relative alarm not active at set point change” is an alarm that masks the alarm condition after a set point change until process variable reaches the alarm threshold \pm hysteresis.

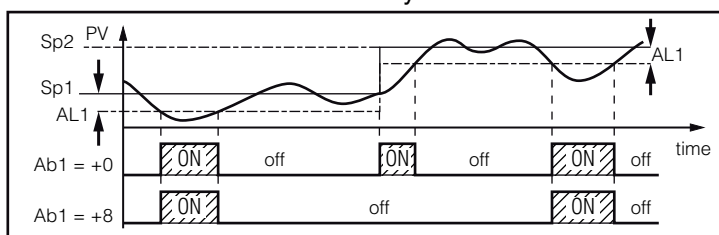

4. The instrument does not store in EEPROM the alarm status. For this reason, the alarm status will be lost if a power down occurs.

[30] AL1L- For High and low alarms it is the low limit of the AL1 threshold
- For band alarm it is low alarm threshold

Available: When [28] AL1t is different from “nonE” or [28] AL1t is different from “SE.br”.

Range: From -1999 to [31] AL1H engineering units.

[31] AL1H- For High and low alarms, it is the high limit of the AL1 threshold
- For band alarm, it is the high alarm threshold

Available: When [28] AL1t is different from “nonE” or [28] AL1t is different from “SE.br”.

Range: From [30] AL1L to 9999 engineering units.

[32] AL1- Alarm 1 threshold

Available: When:

- [28] AL1t = LoAb - Absolute low alarm;
- [28] AL1t = HiAb - Absolute high alarm;
- [28] AL1t = LodE - Deviation low alarm (relative);
- [28] AL1t = LidE - Deviation high alarm (relative).

Range: From [30] AL1L to [31] AL1H engineering units.

[33] HAL1 - Alarm 1 hysteresis

Available: When [28] AL1t is different from “nonE” or [28] AL1t is different from “SE.br”.

Range: 1 to 9999 engineering units.

Notes: 1. The hysteresis value is the difference between

the Alarm threshold value and the point the Alarm automatically resets.

2. When the alarm threshold plus or minus the hysteresis is out of input range, the instrument will not be able to reset the alarm.

Example: Input range 0 to 1000 (mBar).

- Set point equal to 900 (mBar);
- Deviation low alarm equal to 50 (mBar);
- Hysteresis equal to 160 (mBar) the theoretical reset point is $900 - 50 + 160 = 1010$ (mBar) but this value is out of range. The reset can be made only by turning the instrument OFF, removing the condition that generate the alarm and then turn the instrument ON again;
- All band alarms use the same hysteresis value for both thresholds;
- When the hysteresis of a band alarm is bigger than the programmed band, the instrument will not be able to reset the alarm.

Example: Input range 0 to 500 (°C).

- Set point equal to 250 (°C);
- Relative band alarm;
- Low threshold equal to 10 (°C);
- High threshold equal to 10 (°C);
- Hysteresis equal to 25 (°C).

[34] AL1d - Alarm 1 delay

Available: When [28] AL1t is different from “nonE”.

Range: From OFF (0) to 9999 seconds.

Note: The alarm goes ON only when the alarm condition persists for a time longer than [34] AL1d time but the reset is immediate.

[35] AL1o- Alarm 1 enabling during Stand-by mode and out of range indications

Available: When [28] AL1t is different from “nonE”.

- Range:** 0 = Never;
- 1 = During stand by;
 - 2 = During overrange and underrange;
 - 3 = During overrange, underrange and stand-by;

AL2 Group - Alarm 2 parameters

[36] AL2t - Alarm 2 type

Available: Always.

Range: • When one or more outputs are programmed as control output:

- nonE = Alarm not used;
- LoAb = Absolute low alarm;
- HiAb = Absolute high alarm;
- LHAo = Absolute band alarm with alarm indication out of the band;
- LHAi = Absolute band alarm with alarm indication inside the band;
- SE.br = Sensor break;
- LodE = Deviation low alarm (relative);
- HidE = Deviation high alarm (relative);
- LHdo = Relative band alarm with alarm indication out of the band;
- LHdi = Relative band alarm with alarm indication inside the band;

- When no output is programmed as control output: nonE = Alarm not used;

LoAb = Absolute low alarm;
 HiAb = Absolute high alarm;
 LHAo = Absolute band alarm with alarm indication out of the band;
 LHAi = Absolute band alarm with alarm indication inside the band;
 SE.br = Sensor break.

Note: The relative alarm are “relative” to the current set point (this may be different from the Target setpoint if you are using the ramp to set point function).

[37] Ab2 - Alarm 2 function

Available: When [36] AL2t is different from “nonE”.

Range: 0 to 15 with the following rule:

+1 = Not active at power up;
 +2 = Latched alarm (manual reset);
 +4 = Acknowledgeable alarm;
 +8 = Relative alarm not active at set point change.

Example: Setting Ad2 equal to 5 (1+4) the alarm 2 will be “not active at power up” and “Acknowledgeable”.

Note: For other details see [28] Ab1 parameter.

[38] AL2L - For High and low alarms it is the low limit of the AL2 threshold - For band alarm it is low alarm threshold

Available: When [36] AL2t is different from “nonE” or [36] AL2t is different from “SE.br”.

Range: -1999 to [39] AL2H engineering units.

[39] AL2H- For High and low alarms it is the high limit of the AL2 threshold - For band alarm it is high alarm threshold

Available: When [36] AL2t is different from “nonE” or [36] AL2t is different from “SE.br”.

Range: From [38] AL2L to 9999 engineering units.

[40] AL2 - Alarm 2 threshold

Available: When:

[36] AL2t = LoAb Absolute low alarm;
 [36] AL2t = HiAb Absolute high alarm;
 [36] AL2t = LodE Deviation low alarm (relative);
 [36] AL2t = LidE Deviation high alarm (relative).

Range: From [38] AL2L to [39] AL2H engineering units.

[41] HAL2 - Alarm 2 hysteresis

Available: When [36] AL2t is different to “nonE” or [36] AL2t is different from “SE.br”.

Range: 1 to 9999 engineering units.

Note: For other details see [33] HAL1 parameter.

[42] AL2d - Alarm 2 delay

Available: When [36] AL2t different form “nonE”.

Range: From OFF (0) to 9999 seconds.

Note: The alarm goes ON only when the alarm condition persist for a time longer than [42] AL2d time but the reset is immediate.

[43] AL2o- Alarm 2 enabling during Stand-by mode and out of range indications

Available: When [36] AL2t different from “nonE”.

Range: 0 = Never;
 1 = During stand by;
 2 = During overrange and underrange;
 3 = During overrange, underrange and stand-by.

AL3 Group - Alarm 3 parameters

[44] AL3t - Alarm 3 type

Available: Always.

Range: • When one or more outputs are programmed as control output:

nonE = Alarm not used;
 LoAb = Absolute low alarm;
 HiAb = Absolute high alarm;
 LHAo = Absolute band alarm with alarm indication out of the band;
 LHAi = Absolute band alarm with alarm indication inside the band;
 SE.br = Sensor break;
 LodE = Deviation low alarm (relative);
 HidE = Deviation high alarm (relative);
 LHdo = Relative band alarm with alarm indication out of the band;
 LHdi = Relative band alarm with alarm indication inside the band.

• When no output is programmed as control output:
 nonE = Alarm not used;
 LoAb = Absolute low alarm;
 HiAb = Absolute high alarm;
 LHAo = Absolute band alarm with alarm indication out of the band;
 LHAi = Absolute band alarm with alarm indication inside the band;
 SE.br = Sensor break.

Note: The relative alarm are “relative” to the current set point (this may be different to the Target set point if you are using the ramp to set point function).

[45] Ab3 - Alarm 3 function

Available: When [43] AL3t is different from “nonE”.

Range: 0 to 15 with the following rule:

+1 = Not active at power up;
 +2 = Latched alarm (manual reset);
 +4 = Acknowledgeable alarm;
 +8 = Relative alarm not active at set point change.

Example: Setting Ad3 equal to 5 (1+4) the alarm 3 will be “not active at power up” and “Acknowledgeable”.

Note: For other details see [29] Ab1 parameter.

[46] AL3L - For High and low alarms it is the low limit of the AL3 threshold - For band alarm, it is low alarm threshold

Available: When [44] AL3t is different from “nonE” or [44] AL3t is different from “SE.br”.

Range: -1999 to [47] AL3H engineering units.

[47] AL3H- For High and low alarms it is the high limit of the AL3 threshold - For band alarm it is high alarm threshold

Available: When [44] AL3t is different from “nonE” or [44] AL3t is different from “SE.br”.

Range: From [46] AL3L to 9999 engineering units.

[48] AL3 - Alarm 3 threshold

Available: When:

• [44] AL3t = LoAb Absolute low alarm;
 • [44] AL3t = HiAb Absolute high alarm;
 • [44] AL3t = LodE Deviation low alarm (relative);
 • [44] AL3t = LidE Deviation high alarm (relative).

Range: From [46] AL3L to [47] AL3H engineering units.

[49] HAL3 - Alarm 3 hysteresis

Available: When [44] AL3t is different to "nonE" or [44] AL3t is different from "SE.br".

Range: 1 to 9999 engineering units.

Note: For other details see [33] HAL1 parameter.

[50] AL3d - Alarm 3 delay

Available: When [44] AL3t different form "nonE".

Range: From OFF (0) to 9999 seconds.

Note: The alarm goes ON only when the alarm condition persist for a time longer than [50] AL3d time but the reset is immediate.

[51] AL3o- Alarm 3 enabling during Stand-by mode and out of range indications

Available: When [44] AL3t is different from "nonE" or [44] AL3t is different from "SE.br".

Range: 0 = Never;
1 = During stand by;
2 = During overrange and underrange;
3 = During overrange, underrange and stand-by.

▢ LbA group - Loop break alarm

General note about LBA alarm

The LBA operate as follows: applying the 100% of the power output to a process, the process variable, after a time due to the process inertia, begins to change in a known direction (increases for an heating action or decreases for a cooling action).

Example: If I apply 100% of the power output to a furnace, the temperature must go up unless one of the component in the loop is faulty (heater, sensor, power supply, fuse, etc.)

The same philosophy can be applied to the minimum power. In our example, when I turn OFF the power to a furnace, the temperature must go down, if not the SSR is in short circuit, the valve is jammed, etc..

LBA function is automatically enabled when the PID requires the maximum or the minimum power.

When the process response is slower than the programmed limit the instrument generates an alarm.

- Notes:**
1. When the instrument is in manual mode, the LBA function is disabled.
 2. When LBA alarm is ON the instrument continues to perform the standard control. If the process response comes back into the programmed limit, the instrument automatically resets the LBA alarm.
 3. This function is available only when the programmed control algorithm is equal to PID (Cont = PID).

[52] LbAt - LBA time

Available: When [56] Cont = PID.

Range: OFF = LBA not used;
1 to 9999 seconds.

[53] LbSt - Delta measure used by LBA during Soft start

Available: When [52] LbAt is different from OFF.

Range: OFF = loop break alarm is inhibit during soft start;
1 to 9999 engineering units.

[54] LbAS- Delta measure used by loop break alarm (loop break alarm step)

Available: When [52] LbAt is different from OFF.

Range: 1 to 9999 engineering units.

[55] LbcA - Condition for LBA enabling

Available: when [52] LbAt is different from OFF.

Range: uP = Enabled when the PID requires the maximum power only;
dn = Enabled when the PID requires the minimum power only;
both = Enabled in both condition (when the PID requires the maximum or the minimum power).

LBA application example:

LbAt (LBA time) = 120 seconds (2 minutes);

LbAS (delta LBA) = 5°C.

The machine has been designed in order to reach 200°C in 20 minutes (20°C/min);

When the PID demands 100% power, the instrument starts the time count.

During time count if the measured value increases more than 5°C, the instrument restarts the time count. Otherwise if the measured value does not reach the programmed delta (5°C in 2 minutes) the instrument will generate the alarm.

▢ rEG group - Control parameters

The rEG group will be available only when at least one output is programmed as control output (H.rEG or C.rEG).

[56] cont - Control type:

Available: When at least one output is programmed as control output (H.rEG or C.rEG).

Range: • When two control action (heat & cool) are programmed:

Pid = PID (heat and cool);

nr = Heat/Cool ON/OFF control with neutral zone.

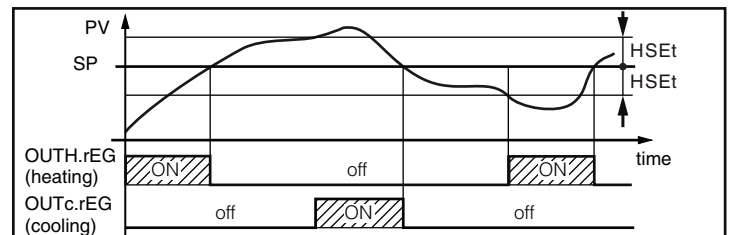

• When one control action (heat or cool) is programmed:

Pid = PID (heat or cool);

On.FA = ON/OFF asymmetric hysteresis;

On.FS = ON/OFF symmetric hysteresis;

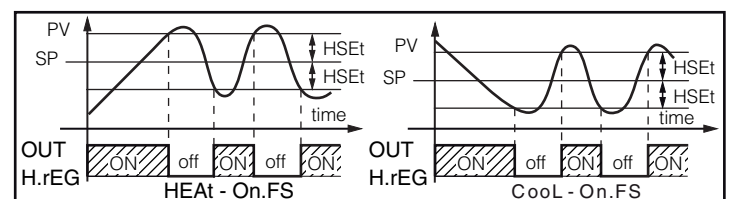
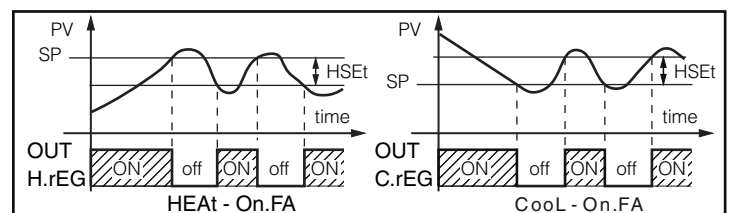

Notes: 1. ON/OFF control with asymmetric hysteresis:

- OFF when $PV \geq SP$;
- ON when $PV \leq (SP - \text{hysteresis})$.

2. ON/OFF control with symmetric hysteresis:

- OFF when $PV \geq (SP + \text{hysteresis})$;
- ON when $PV \leq (SP - \text{hysteresis})$.

[57] Auto - Auto tune selection

There are three auto-tune algorithms:

- Oscillating auto-tune;
- Fast auto-tune;
- EvoTune.

1. The **oscillating** auto-tune is the usual auto-tune and:
 - It is more accurate;
 - Can start even if PV is close to the set point;
 - Can be used even if the set point is close to the ambient temperature.
2. The **fast type** is suitable when:
 - The process is very slow and you want to be operative in a short time;
 - When an overshoot is not acceptable;
 - In multi loop machinery where the fast method reduces the calculation error due to the effect of the other loops.
3. The **EvoTune** type is suitable when:
 - You have no information about your process;
 - You can not be sure about the end user skills;
 - You desire an auto tune calculation independently from the starting conditions (e.g. set point change during tune execution, etc).

Note: Fast auto-tune can start only when the measured value (PV) is lower than (SP + 1/2 SP).

Available: When [56] cont = PID

Range: -4 to 8 where:

- 4 = Oscillating auto-tune with automatic restart at all set point change;
- 3 = Oscillating auto-tune with manual start;
- 2 = Oscillating auto-tune with automatic start at the first power up only;
- 1 = Oscillating auto-tune with automatic restart at every power up;
- 0 = Not used;
- 1 = Fast auto tuning with automatic restart at every power up;
- 2 = Fast auto-tune with automatic start at the first power up only;
- 3 = FAST auto-tune with manual start;
- 4 = FAST auto-tune with automatic restart at all set point change.
- 5 = EvoTune with automatic restart at every power up;
- 6 = EvoTune with automatic start at the first power up only;
- 7 = EvoTune with manual start;
- 8 = EvoTune with automatic restart at all set point change.

[58] tunE - Manual start of the auto-tune

Available: When [56] cont = PID.

Range: oFF = The instrument is not performing the auto-tune;
on = The instrument is performing the auto-tune.

[59] Reserved

[60] HSEt - Hysteresis of the ON/OFF control

Available: When [56] cont is different from PID.

Range: 0 to 9999 engineering units.

[61] cPdt - Time for compressor protection

Available: When [56] cont = nr.

Range: OFF = Protection disabled
1 to 9999 seconds.

[62] Pb - Proportional band

Available: When [56] cont = PID.

Range: 1 to 9999 engineering units.

Note: Auto-tune functions calculate this value.

[63] ti - Integral time

Available: When [56] cont = PID.

Range: • OFF = Integral action excluded;
• 1 to 9999 seconds;
• inF= Integral action excluded.

Note: Auto-tune functions calculate this value.

[64] td - Derivative time

Available: When [56] cont = PID.

Range: • oFF - derivative action excluded;
• 1 to 9999 seconds.

Note: Auto-tune functions calculate this value.

[65] Fuoc - Fuzzy overshoot control

This parameter reduces the overshoot usually present at instrument start up or after a set point change and it will be active only in this two cases.

Setting a value between 0.00 and 1.00 it is possible to slow down the instrument action during set point approach.

Setting **Fuoc = 1** this function is disabled.

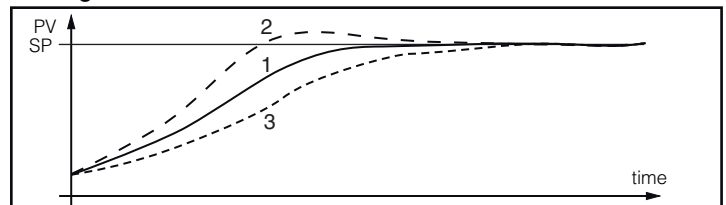

Available: When [56] cont = PID.

Range: 0 to 2.00.

Note: Fast auto-tune calculates the Fuoc parameter while the oscillating one sets it equal to 0.5.

[66] tcH - Cycle time of the heating output

Available: When at least one output is programmed in order to be the heating output (H.rEG),
[56] cont = PID.

Range: 1.0 to 130.0 seconds.

[67] rcG - Power ratio between heating and cooling action (relative cooling gain)

The instrument uses the same PID parameter set for heat and for cool action but the efficiency of the two actions are usually different.

This parameter allows to define the ratio between the efficiency of the heating system and the efficiency of the cooling one.

An example will help us to explain you the philosophy.

Consider one loop of a plastic extruder. The working temperature is equal to 250°C.

When you want to increase the temperature from 250 to 270°C ($\Delta T = 20^\circ C$) using 100% of the heating power (resistor), you will need 60 seconds.

On the contrary, when you want to decrease the temperature from 250 to 230°C ($\Delta T = 20^\circ C$) using 100% of the cooling power (fan), you will need 20 seconds only.

In our example the ratio is equal to 60/20 = 3 ([67] rcG = 3) and it say that the efficiency of the cooling system is 3 time more efficient of the heating one.

Available: When two control action are programmed

(H.rEG and c.rEG) and [56] cont = PID.

Range: 0.01 to 99.99.

Note: auto-tune functions calculate this value.

[68] tcc - Cycle time of the cooling output

Available: When at least one output is programmed in order to be the cooling output (c.rEG), [56] cont = PID.

Range: 1.0 to 130.0 seconds.

[69] rS - Manual reset (integral pre-load)

It allows to drastically reduce the undershoot due to a hot restart. When your process is steady, the instrument operates with a steady power output (e.g.: 30%).

If a short power down occurs, the process restarts with a process variable close to the set point while the instrument starts with an integral action equal to zero.

Setting a manual reset equal to the average power output (in our example 30%) the instrument will start with a power output equal to the value it will use at steady state (instead of zero) and the undershoot will become very little (in theory equal to zero).

Available: When [56] cont = PID.

Range: -100.0 to +100.0%.

[70] Reserved

[71] Reserved

[72] od - Delay at power up

Available: When at least one output is programmed as control output.

Range: oFF: Function not used;
0.01 to 99.59 hh.mm.

- Notes:**
1. This parameter defines the time during which (after a power up) the instrument remains in stand by mode before to start all other function (control, alarms, program, etc.).
 2. When a program with automatic start at power up and od function are programmed, the instrument performs od function before to start the program.
 3. When an auto-tune with automatic start at power up and od function are programmed, the autotune will start at the end of od delay.

[73] St.P - Maximum power output used during soft start

Available: When at least one output is programmed as control output.

Range: -100 to +100%.

- Notes:**
1. When St.P parameter have a positive value, the limit will be applied to the heating output(s) only.
 2. When St.P parameter have a negative value, the limit will be applied to the cooling output(s) only.
 3. When a program with automatic start at power up and soft start function are programmed, the instrument performs the soft start and than the program function.
 4. The auto-tune function will be performed after soft start function.
 5. The Soft start function is available also when ON/OFF contro I is used.

[74] SSt - Soft start time

Available: When at least one output is programmed as control output.

Range: oFF = Function not used;
0.01 to 7.59 hh.mm;

inF = Soft start always active.

[75] SS.tH - Threshold for soft start disabling

Available: When at least one output is programmed as control output.

Range: -1999 to 9999 engineering units.

- Notes:**
1. When the power limiter have a positive value (the limit is applied to the heating action) the soft start function will be aborted when the measured value is greater or equal to SS.tH parameter.
 2. When the power limiter have a negative value (the limit is applied to the cooling action) the soft start function will be aborted when the measured value is lower or equal to SS.tH parameter.

SP Group - Set point parameters

The SP group will be available only when at least one output is programmed as control output (H.rEG or C.rEG).

[76] nSP - Number of used set points

Available: When at least one output is programmed as control output.

Range: 1 to 4.

Note: When you change the value of this parameter, the instrument operates as follows:

- [83] A.SP parameter will be forced to SP.
- The instrument verifies that all used set point are within the limits programmed by [77] SPLL and [78] SPHL. If an SP is out of this range, the instrument forces it to the maximum acceptable value

[77] SPLL - Minimum set point value

Available: When at least one output is programmed as control output.

Range: From -1999 to [78] SPHL engineering units.

- Notes:**
1. When you change the [77] SPLL value, the instrument checks all local set points (SP, SP2, SP3 and SP4 parameters) and all set points of the program ([97] Pr.S1, [102] Pr.S2, [107] Pr.S3, [112] Pr.S4 parameters). If an SP is out of this range, the instrument forces it to the maximum acceptable value
 2. A [77] SPLL change produces the following actions:
 - When [84] SP.rt = SP the remote set point will be forced to be equal to the active set point
 - When [84] SP.rt = trim the remote set point will be forced to zero
 - When [84] SP.rt = PErc the remote set point will be forced to zero

[78] SPHL - Maximum set point value

Available: When at least one output is programmed as control output.

Range: From [78] SPLL to 9999 engineering units.

Note: For other details see [78] SPLL parameter.

[79] SP - Set Point 1

Available: When at least one output is programmed as control output.

Range: From [77] SPLL to [78] SPHL engineering units.

[80] SP 2 - Set Point 2

Available: When at least one output is programmed as control output and [76] nSP ≥ 2.

Range: From [77] SPLL to [78] SPHL engineering units.

[81] SP 3 - Set Point 3

Available: When at least one output is programmed as control output and [76] nSP \geq 3.

Range: From [77] SPLL to [78] SPHL engineering units.

[82] SP 4 - Set Point 4

Available: When at least one output is programmed as control output and [76] nSP =4.

Range: From [77] SPLL to [78] SPHL engineering units.

[83] A.SP - Selection of the active Set point

Available: When at least one output is programmed as control output.

Range: From "SP" to [76] nSP.

Notes: 1. A [83] A.SP change produces the following actions:

- When [84] SP.rt = SP - the remote set point will be forced to be equal to the active set point;
- When [84] SP.rt = trin - the remote set point will be forced to zero;
- When [84] SP.rt = PErc - the remote set point will be forced to zero.

2. SP2, SP3 and SP4 selection will be shown only when the relative set point is enabled (see [76] nSP parameter).

[84] SP.rt - Remote set point type

These instruments will communicate with each other, using RS 485 serial interface without a PC. An instrument can be set as a Master while the other are (as usual) Slave units. The Master unit can send his operative set point to the slave units.

In this way, for example, is possible to change simultaneously the set point of 20 instruments by changing the set point of the master unit (e.g. hot runner application).

SP.rt parameter defines how the slaves units will use the value coming from serial link.

[133] tr.SP parameter [selection of the value to be retransmitted (Master)] allows to define the value sent by master unit.

Available: When at least one output is e programmed as control output and the serial interface is present.

Range: rSP = The value coming from serial link is used as remote set point (RSP);

trin = The value coming from serial link will be algebraically added to the local set point selected by A.SP and the sum becomes the operative set point;

PErc = The value coming from serial will be scaled on the input range and this value will be used as remote set point.

Note: A [84] SPrt change produces the following actions:

- When [84] SP.rt = rSP - the remote set point will be forced to be equal to the active set point;
- When [84] SP.rt = trin - the remote set point will be forced to zero;
- When [84] SP.rt = PErc - the remote set point will be forced to zero.

Example: A 6 zone reflow-oven for PCB.

The master unit sends its set point value to 5 other zones (slave controllers).

The Slave zones use it as a set point trim.

The first zone is the master zone and it uses a set point equal to 210°C.

The second zone has a local set point equal to -45°C.

The third zone has a local set point equal to -45 (°C).

The fourth zone has a local set point equal to -30.

The fifth zone has a local set point equal to +40.

The sixth zone has a local set point equal to +50.

In this way, the thermal profile will be the following:

– Master SP = 210°C;

– Second zone SP = 210 -45 = 165°C;

– Third zone SP = 210 -45 = 165°C;

– Fourth zone SP = 210 - 30 = 180°C;

– Fifth zone SP = 210 + 40 = 250°C;

– Sixth zone SP = 210 + 50 = 260°C.

Changing the SP of the master unit, all the other slave units will immediately change their operative set point.

[85] SPLr - Local/remote set point selection

Available: When at least one output is programmed as control output.

Range: Loc = Local set point selected by [83] A.SP;
rEn = Remote set point (coming from serial link).

[86] SP.u - Rate of rise for positive set point change (ramp up)

Available: When at least one output is e programmed as control output.

Range: • 0.01 to 99.99 units per minute;
• inF = ramp disabled (step transfer).

[87] SP.d - Rate of rise for negative set point change (ramp down)

Available: When at least one output is e programmed as control output.

Range: 0.01 to 99.99 units per minute;
inF = ramp disabled (step transfer).

General note about remote set point: when the remote set point (RSP) with trim action is programmed, the local set point range becomes the following:

from [77] SPLL+ RSP to [78] SPHL - RSP

▯ PAn group - Operator HMI

[118] PAS2 - Level 2 password: Limited access level

Available: Always.

Range: oFF = Level 2 not protected by password (as level 1 = Operator level);
1 to 200.

[119] PAS3- Level 3 password: Complete configuration level

Available: Always.

Range: 3 to 200.

Note: Setting [118] PAS2 equal to [119] PAS3, the level 2 will be masked.

[120] PAS4- Level 4 password: CODE configuration level

Available: Always.



Range: 201 to 400.

[121] uSrb - button function during RUN TIME

Available: Always.

Range: nonE = No function;

- tunE = Auto-tune/self-tune enabling. A single press (longer than 1) starts the auto-tune;
- oPLo = Manual mode. The first pressure puts the instrument in manual mode (OPLO) while a second one puts the instrument in Auto mode;
- AAc = Alarm reset;
- ASi = Alarm acknowledge;
- chSP = Sequential set point selection (note);
- St.by = Stand by mode. The first press puts the instrument in stand by mode while a second one puts the instrument in Auto mode;
- Str.t = Reserved;
- P.run = Reserved;
- P.rES = Reserved;
- P.r.H.r = Reserved.

- Notes:**
1. When "Sequential set point selection" is used, every press of the  button (longer than 1 second) increase the value of A.SP (active set point) of one step.
The selection is cyclic: SP -> SP2 -> SP3 -> SP4
When a new set point is selected using the  key, the display will show for 2 seconds the acronym of the new set point (e.g. SP2).
 2. When "Sequential set point selection" is used, the number of set points selectable is limited by [74] nSP.

[122] diSP - Display management

Available: Always.

Range: nonE = Standard display;

- Pou = Power output;
- SPF = Final set point;
- SPo = Operative set point;
- AL1 = Alarm 1 threshold;
- AL2 = Alarm 2 threshold;
- AL3 = Alarm 3 threshold;;
- Pr.tu = Reserved;
- Pr.td = Reserved;
- P.t.tu = Reserved;
- P.t.td = Reserved;
- ti.uP = Reserved;
- ti.du = Reserved;
- PErc = Percent of the power output used during soft start (when the soft start time is equal to infinite, the limit is ever active and it can be used also when ON/OFF control is selected);
- PoS = Reserved.

[123] di.CL - Display color

Available: Always.

- Range:** 0 = The display color is used to show the actual deviation (PV - SP);
- 1 = Display red (fix);
 - 2 = Display green (fix);
 - 3 = Display orange (fix).

[124] AdE - Deviation for display color management

Available: When [123] di.CL = 0.

Range: 1 to 9999 engineering units.

[125] diS.t - Display time out

Available: Always.

Range: oFF = The display is ever ON;
0.1 to 99.59 minutes and seconds.

Note: This function allows to turn OFF the display when no alarm is present and no action is made on the instrument. When diS.t is different from OFF and no button is pressed for more than the programmed time out, the display goes OFF and only 4 segments of the less significant digit are turned ON in sequence in order to show that the instrument is working correctly. If an alarm occurs or a button is pressed, the display will come back to the normal operation.

[126] FiLd - Filter on the displayed value

Available: Always.

Range: oFF = Filter disabled;
From 0 (oFF) to 100 engineering units.

Note: This is a "window filter" related to the set point; it is applied to the displayed value only and it have no effect on the other functions of the instrument (control, alarms, etc.).

[127] dSPu - Reserved

[128] dSPu - Status of the instrument at power up

Available: Always.

Range: AS.Pr = Starts in the same way it was prior to the power down;

- Auto = Starts in Auto mode;
- oP.0 = Starts in manual mode with a power output equal to zero.
- St.bY = Starts in stand-by mode

- Notes:**
1. When you change the value of [129] oPr.E, the instrument forces [130] oPEr parameter to Auto.
 2. If the "[128] dSPu" parameter is different from "AS.Pr" the memorization function is inhibited.

[129] oPr.E - Operative modes enabling

Available: Always.

Range: ALL = All modes will be selectable by the next parameter;

- Au.oP = Auto and manual (OPLO) mode only will be selectable by the next parameter;
- Au.Sb = Auto and Stand-by modes only will be selectable by the next parameter.

Note: When you change the value of [129] oPr.E, the instrument forces [130] oPEr parameter equal to Auto.

[130] oPEr - Operative mode selection

Available: Always.

Range:

- When [129] oPr.E = ALL:
 - Auto = Auto mode;
 - oPLo = Manual mode;
 - St.bY = Stand by mod.e
- When [129] oPr.E = Au.oP:
 - Auto = Auto mode;
 - oPLo = Manual mode.
- When [129] oPr.E = Au.Sb:
 - Auto = Auto mode;
 - St.bY = Stand by mode.

³Ser group - Serial link parameter

[131] Add - Instrument address

Available: Always.

Range: oFF = Serial interface not used;
1 to 254.

[132] bAud - Baud rate

Available: When [131] Add different from oFF.

Range: 1200 = 1200 baud;
2400 = 2400 baud;
9600 = 9600 baud;
19.2 = 19200 baud;
38.4 = 38400 baud.

[133] trSP - Selection of the value to be retransmitted (Master)

Available: When [131] Add different from oFF.

Range: nonE = Retransmission not used (the instrument is a slave);
rSP = The instrument become a Master and it retransmits the operative set point;
PErc = The instrument become a Master and it retransmits the power output.

Note: For more details see [84] SP.rt (Remote set point type) parameter.

CO Group - Consumption parameters

[134] Co.tY - Count type

Available: Always.

Range: oFF Not used;

- 1 Instantaneous power (kW);
- 2 Consumed energy (kWh);
- 3 Reserved;
- 4 Total worked days: number of hours the instrument is turned ON divided by 24;
- 5 Total worked hours: number of hours that the instrument is turned ON;
- 6 Total worked days with threshold: number of hours the instrument is turned ON divided by 24, the controller is forced in stand-by when Co.ty value reaches the threshold set in [137] h.Job;
- 7 Total worked hours with threshold: number of hours that the instrument is turned ON, the controller is forced in stand-by when Co.ty value reaches the threshold set in [137] h.Job;
- 8 Totalizer of control relay worked days: number of hours the control relay has been in ON condition, divided by 24;
- 9 Totalizer of control relay worked hours: number of hours the control relay has been in ON condition;
- 10 Totalizer of control relay worked days with threshold: number of hours the control relay has been in ON condition divided by 24, the controller is forced in stand-by when Co.ty value reaches the threshold set in [137] h.Job;
- 11 Totalizer of control relay worked hours with threshold: number of hours the control relay has been in ON condition, the controller is forced in stand-by when Co.ty value reaches the threshold set in [137] h.Job.

Notes: 1. Selections 4 to 11 represent an internal count: these modes calculate the instrument work in hours or days. When the count reaches the threshold set with parameter [137] h.Job the display shows "r.iSP" (Inspection Requested). The count reset (with r.iSP cancellation) can be done only by changing the threshold value -

parameter [137] h.Job.

Using counting methods 6, 7, 10, 11, the count reset causes the controller to exit the stand-by status returning to the control status.

[135] UoLt - Nominal Voltage of the load

Available: When [134] Co.tY = ist or
[134] Co.tY = h or
[134] Co.tY = S.S.

Range: 1 to 9999 (V).

[136] cur - Nominal current of the load

Available: When [134] Co.tY = ist or
[134] Co.tY = h or
[134] Co.tY = S.S.

Range: 1 to 999 (A).

[137] h.Job - Threshold of the working period

Available: When [134] Co.tY = tot.d or
[134] Co.tY = tot.H.

Range: oFF = Threshold not used
1 to 9999 days when [134] Co.tY = 4;
1 to 9999 hours when [134] Co.tY = 5.

[138] t.Job - Worked time (not resettable)

Available: Always.

Range: 1 to 9999 days.

CAL group - User calibration group

This function allows to calibrate the complete measuring chain and to compensate the errors due to:

- Sensor location;
- Sensor class (sensor errors);
- Instrument accuracy.

[139] A.L.P - Adjust Low Point

Available: Always.

Range: -1999 to (AH.P - 10) engineering units.

Note: The minimum difference between AL.P and AH.P is equal to 10 Engineering Units.

[140] A.L.o - Adjust Low Offset

Available: Always.

Range: -300 to +300 engineering units.

[141] A.H.P - Adjust High Point

Available: Always.

Range: From (AL.P + 10) to 9999 engineering units.

Note: The minimum difference between AL.P and AH.P is equal to 10 Engineering Units.

[142] A.H.o - Adjust High Offset

Available: Always.

Range: -300 to +300 Engineering Units.

Example: Environmental chamber with an operative range: 10 to 100°C.

1. Insert in the chamber a reference sensor connected with a reference instrument (usually a calibrator).
2. Start the control of the instrument, and set a set point equal to the minimum value of the operative range (e.g.: 10°C). When the temperature in the chamber is steady, take note of the temperature measured by the reference system (e.g.: 9°C).
3. Set [139] A.L.P = 10 (low working point) and [140] A.L.o = -1 (it is the difference between the reading of the instrument and the reading of the reference system). Note that after this set the measured value of the instrument is

equal to the measured value of the reference system.

4. Set a set point equal to the maximum value of the operative range (e.g. 100°C). When the temperature in the chamber is steady, take note of the temperature measured by the reference system (e.g. 98°C).
5. Set [141] A.H.P = 100 (low working point) and [142] A.H.o = +2 (it is the difference between the reading of the instrument and the reading of the reference system). Note that after this set the measured value of the instrument is equal to the measured value of the reference system.

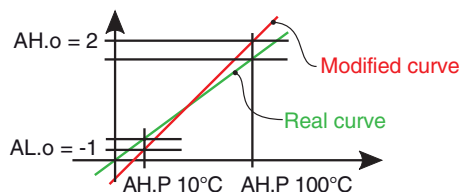

The most important step of the configuration procedure is completed.

In order to exit from configuration parameter procedure, proceed as follows:

- Push button.
- Push button for more than 3 s. The instrument will come back to the “standard display”.

6. PARAMETER PROMOTION

Another important step of the instrument configuration is due to the possibility to create a custom HMI (interface) in order to make the instrument easy to use for the operator and comfortable for the assistance.

By a special procedure, named promotion, the OEM can create two parameter subsets.

The first one is the “limited access” level. This subset is protected by the password programmed by [118] PAS2 parameter.

The last subset is the “Operator” set (Level1). This level is NOT password protected.

- Notes:**
1. The “limited access” parameter are collected in a list.
 2. The sequence of the “limited access” parameters is programmable and can be made according to your needs.
 3. The parameter sequence of the operator level is the same programmed for “limited access” level but only specified parameters can be displayed and modified. This set must be create according to your requirements.

6.1 PARAMETER PROMOTION PROCEDURE

The limited access parameter set is a list, so that, before to start promotion procedure, we suggest to operate as follows:

1. Prepare the exact parameter list you want to make accessible for limited access.
2. Number the desired parameters in the same sequence you want to have in the limited access.
3. Define which of the selected parameter will be available in Operator level also.







Example: I would like to obtain the following limited access list:

OPeR	Operative mode selection;
SP	First set point;
SP2	Second set point;
A.SP	Set point selection;
AL1	Alarm 1 threshold;
AL2	Alarm 2 threshold;
Pb	Proportional band;
ti	Integral time;
td	Derivative time;
Aut.r	Manual start of the auto-tune.



But I want that the operator to be able to change: the operative mode, the SP value and the AL1 value. In this case the promotion will be the following:

Parameter	Promotion	Limited Access	Operator
- OPeR -	o 1	OPeR	OPeR
- SP -	o 2	SP	SP
- SP2 -	A 3	SP2	
- A.SP -	A 4	A.SP	
- AL1 -	o 5	AL1	AL1
- AL2 -	A 6	AL2	
- Pb -	A 7	Pb	
- ti -	A 8	ti	
- td -	A 9	td	
- Aut.r -	A 10	Aut.r	



Now, proceed as follows:

1. Push the  button for more than 3 seconds.
2. The upper display will show *PASS* while the lower display will show 0.
3. By  and  buttons set a password equal to *-B 1*.
4. Push  button.
The instrument will show the acronym of the first configuration parameter group "*OP*".
5. By  button select the group of the first parameter of your list.
6. By  button select the first parameter of your list
7. The upper display will show the acronym of the parameter while the lower display will show his current promotion level. The promotion level is defined by a letter followed by a number.

The letter can be:

- c: It shows that this parameter is **NOT** promoted and it is present only in configuration.
In this case the number is forced to zero.
 - R: It shows that this parameter has been promoted to the limited access level.
The number will show the position in the limited access list.
 - o: It shows that the parameter has been promoted to the Operator level.
The number will show the position in the limited access list.
8. By  and  buttons assign to this parameter the desired position.

Note: Setting a value different from 0 the letter *c* will change automatically to *R* and the parameter is automatically promoted to the limited access level.

9. In order to modify the level from limited access to operator and vice versa, push  button and, maintaining the pressure, push  button.
The letter will change from *R* to *o* and vice versa.
10. Select the second parameter that you want to add to the assistance level and repeat step 6, 7 and 8.
11. Repeat step 5, 6, 7, 8 until the list has been completed.
12. When you need to exit from promotion procedure, push  button and maintain the pressure for more than 10 s.
The instrument will show the "standard display".

Note: When you set the some number to two parameter, the instrument will use only the last programmed parameter.

Example: In the previous example, I have set for SP2 a promotion value equal to A3.

If now I set for SP3 a promotion value equal to o3, the Limited Access list and the operator list becomes.

Parameter	Promotion	Limited Access	Operator
- OPEr -	o 1	OPEr	OPEr
- SP -	o 2	SP	SP
- SP3 -	o 3	SP3	SP3
- A.SP -	A 4	A.SP	
- AL1 -	o 5	AL1	AL1

7. OPERATIVE MODES

As we said at paragraph 4.1, when the instrument is powered, it starts immediately to work according to the memorized parameter value.

In other words, the instrument has one status only, the "run time" status.





During "run time" we can force the instrument to operate in three different modes: Automatic mode, Manual mode or Stand by mode:

- In **Automatic mode** the instrument drives automatically the control output according to the parameter value set and the set point/measured value.
- In **Manual mode** the the upper display shows the measured value while the lower display shows the power output The lower display shows the power output [preceded by *H* (for heating) or *C* (for cooling)], MAN is lit and the instrument allows you to set manually the control output power.
No Automatic action will be made.
- In **Stand by mode** the instrument operates as an indicator. It will show on the upper display the measured value and on the lower display the set point alternately to the "St.bY" messages and forces the control outputs to zero.

As we have seen, it is always possible to modify the value assigned to a parameter independently from the operative modes selected.

7.1 MODIFY A PARAMETER DURING "OPERATOR LEVEL"



The instrument is showing the "standard display".

1. Press the  button.
2. The upper display will show the acronym of the first parameter promoted to this level while the lower display will show its value.
3. By  and  button assign to this parameter the desired value.
4. Press the  button in order to memorize the new value and go to the next parameter.
5. When you want to come back to the "standard display" push the  button for more than 3 seconds.

Note: The parameter modification of the Operator level is subject to a time out. If no button is pressed for more than 10 seconds, the instrument goes back to the "standard display" and the new value of the last selected parameter will be lost.

7.2 ENTER THE "LIMITED ACCESS LEVEL"

The instrument is showing the "standard display".

1. Press the  button for more than 3 seconds;
2. The upper display will show *PASS* while the lower display will show 0;
3. By  and  buttons set the value assigned to [118] PAS2 (Level 2 password).





Notes:

1. The factory default password for configuration parameters is equal to 20.
2. All parameter modification are protected by a time out. If no button is pressed for more than 10 second the instrument comes automatically back to the Standard display, the new value of the last selected parameter is lost and the parameter

modification procedure is closed.

When you desire to remove the time out (e.g. for the first configuration of an instrument) you can use a password equal to 1000 plus the programmed password (e.g. 1000 + 20 [default] = 1020).







It is always possible to manually End the parameter configuration procedure (see below).

3. During parameter modification the instrument continues to perform the control.
In certain conditions (e.g. when a parameter change can produces a heavy bump to the process) it is advisable to temporarily stop the controller from controlling during the programming procedure (its control output will be Off). A password equal to 2000 + the programmed value (e.g. 2000 + 20 = 2020) will switch the control out off during configuration. The control will restart automatically when the parameter modification procedure will be manually ended.
4. Push  button.
5. The instrument will show on the upper display the acronym of the first parameter promoted to this level and on the lower display its value.
6. By  and  buttons assign to this parameter the desired value.
7. Press the  button in order to memorize the new value and go to the next parameter.
8. When you want to come back to the “standard display” push the  button for more than 3 s.

7.3 HOW TO SEE BUT NOT MODIFY THE “LIMITED ACCESS PARAMETERS”



Sometime it is necessary to give to the operator the possibility to see the value assigned to the parameter promoted in the Limited Access level but it is important that all changes are made by authorized personnel only.



In this cases, proceed as follows:

1. Press the  button for more than 3 seconds;
2. The upper display will show *PASS* while the lower display will show *0*;
3. By  and  button set the value - *18* ;
4. Push  button;
5. The upper display will show the acronym of the first parameter promoted to the level 2 and lower display will show its value;
6. Using  button it is possible to see the value assigned to all parameter present in level 2 but it will not be possible to modify it;
7. It is possible to come back to the “standard display” by pushing the  button for more than 3 seconds or by pushing no pushbutton for more than 10 seconds.

7.4 AUTOMATIC MODE

7.4.1 Keyboard function when the instrument is in Auto mode





-  Performs the action programmed by [121] uSrb ( button function during RUN TIME) parameter.
-  Allows to enter the parameter modification procedures.

-  Allows to start the “Direct set point modification” function (see below).
-  Allows to display the “additional informations” (see below).

7.4.2 Direct set point modification

This function allows to modify rapidly the set point value selected by [83] A.SP (selection of the active Set point).

The instrument is showing the “standard display”.

1. Push  button.
The upper display shows the acronym of the selected set point (e.g. SP2) and the lower display will show its value.
2. By  and  buttons, assign to this parameter the desired value.
3. Do not push any button for more than 10 second or push the  button.





In both cases the instrument memorize the new value and come back to the “standard display”.

Note: If the selected set point has not been promoted to the Operator level, the instrument allows you to see the value but not to modify it.

7.4.3 Additional information

This instrument is able to show you some additional informations that can help you to manage your system.

The additional informations are related to how the instrument is programmed, hence in many cases, only part of this information is available.

1. When the instrument is showing the “standard display” push  button.
The lower display will show *H* or *c* followed by a number. This value is the current power output applied to the process. The *H* show you that the action is a Heating action while the *c* show you that the action is a Cooling action.
2. Push  button again. When the wattmeter function is running the lower display will show *U* followed by the measured energy.
Note: The energy calculation will be in accordance with the [134] Co.tY parameter setting.
3. Push  button again. When the “Worked time count” is running the lower display will show *d* for days or *h* for hours followed by the measured time.
4. Push  button again. The instrument returns to the “standard display”.

Note: The additional information visualization is subject to a time out. If no button is pressed for more than 5 second the instrument comes automatically back to the Standard display.

7.4.4 Display management

This instrument allows you to program (see parameter [125] diS.t the time out of the display.

This function allows to turn OFF the display when no alarm is present and no action is made on the instrument.

When [125] diS.t is different to OFF (display ever ON) and no button is pressed for more than the programmed time out, the display goes OFF and only 4 segments of the less significant digit are turned ON in sequence in order to show that the instrument is working correctly.

If an alarm occurs or a button is pressed, the display will come back to the normal operation.

7.4.5 The display colour shows the Deviation

This instrument allows to program the deviation (PV - SP) for colour display change (see parameter [124] AdE).



In this way the upper display will be:

- Amber when PV is lower than SP - AdE.
- Green when (SP - AdE) < PV < SP + AdE
- Red when PV is higher than SP + AdE

7.5 MANUAL MODE

This operative mode allows you to deactivate automatic control and manually program the percentage power output to the process.

When the instrument is in manual mode, the upper display will show the measured value while the lower display will show alternately the power output [preceded by *H* (for heating action) or *C* (for cooling action)] and the message *oPLo* (open loop).

When manual control is selected, the instrument will start to operate with the same power output as the last one supplied by automatic mode and can be modified using the  and  buttons.

In case of ON/OFF control, 0% corresponds to the deactivated output while any value different from 0 corresponds to the activated output.

As in the case of visualization, the programmable values range from H100 (100% output power with reverse action) to C100 (100% output power with direct action).

- Notes:**
1. During manual mode, the alarms are operative.
 2. If you set manual modes during self-tune execution, the self-tune function will be aborted.
 3. During manual mode, all functions not related with the control (wattmeter, independent timer, “worked time”, etc) continue to operate normally.

7.6 STAND BY MODE

This operative mode also deactivates the automatic control but forces the control output to zero.

In this mode the instrument operates as an indicator.

When the instrument is in stand by mode the upper display will show the measured value while the lower display will show alternately the set point and the message “St.bY”.

- Notes:**
1. During stand by mode, the relative alarms are disabled while the absolute alarms are operative or not according to the ALx0 (Alarm x enabling during Stand-by mode) parameter setting.
 2. If you set stand by mode during program execution, the program will be aborted.
 3. If you set stand by mode during self-tune execution, the self-tune function will be aborted.
 4. During stand by mode, all functions not related with the control (wattmeter, independent timer, “worked time”, etc) continue to operate normally.
 5. When the instrument is swapped from stand by to auto modes, the instrument will start automatically the alarm masking, the soft start functions and the auto-tune (if programmed).

8. ERROR MESSAGES

8.1 OUT OF RANGE SIGNALS

The upper display shows the OVER-RANGE and UNDER-RANGE conditions with the following indications:

Over-range



Under-range



The sensor break will be signalled as an out of range



Note: When an over-range or an under-range is detected, the alarms operate as in presence of the maximum or the minimum measurable value respectively.

To check the out of span Error condition, proceed as follows:

1. Check the input signal source and the connecting line.
2. Make sure that the input signal is in accordance with the instrument configuration. Otherwise, modify the input configuration (see section 4).
3. If no error is detected, send the instrument to your supplier to be checked.

8.2 LIST OF POSSIBLE ERRORS

ErRE Fast Auto-tune cannot start. The measure value is too close to the set point.

Push the  button in order to delete the error message.

oULd Overload on the out 4

The messages shows that a short circuit is present on the Out 4 when it is used as output or as a transmitter power supply.

When the short circuit disappears the output restart to operate.

noRE Auto-tune not finished within 12 hours.

ErEP Possible problem of the instrument memory.

The messages disappears automatically.

When the error continues, send the instrument to your supplier.

ronE Possible problem of the firmware memory.

When this error is detected, send the instrument to your supplier.

ErRE Possible problem of the calibration memory.

When this error is detected, send the instrument to your supplier.

9. GENERAL NOTES

9.1 PROPER USE

Every possible use not described in this manual must be considered as an improper use.

This instrument is in compliance with EN 61010-1 "Safety requirements for electrical equipment for measurement, control and laboratory use"; for this reason it could not be used as a safety equipment.

Whenever a failure or a malfunction of the control device may cause dangerous situations for persons, things or animals, please remember that the plant has to be equipped with additional safety devices.

Yokogawa Electric Corporation and its legal representatives do not assume any responsibility for any damage to people, things or animals deriving from violation, wrong or improper use or in any case not in compliance with the instrument's features.

9.2 WARRANTY

This product is under warranty against manufacturing defects or faulty materials that are found within 18 months from manufacturing date. The warranty is limited to the replacement of the instrument.

The tampering of the instrument or an improper use of the product will bring about the immediate withdrawal of the warranty's effects.

In the event of a faulty instrument, either within the period of warranty, or further to its expiry, please contact our sales department to obtain authorisation for sending the instrument to our company.

9.3 DISPOSAL

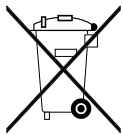

Waste Electrical and Electronic Equipment (WEEE) Directive (This directive is valid in the EU member states).

This product complies with the WEEE Directive marking requirements.

The following marking indicates that you must not discard this electrical/electronic product in domestic household waste.

Product category



With reference to the equipment type in the WEEE directive, this product is classified as a "Monitoring and control instruments".

Do not dispose of this product in domestic household waste.

When disposing of product in the UE, contact your Yokogawa European B.V. office

Appendix A

inP GROUP - Main and auxiliary input configuration

no.	Param.	Description	Dec. Point	Values	Default
1	SEnS	Sensor selection	0	J = TC J, crAL = TC K, S = TC S, r = TC R, t = TC T, Pt1 = RTD Pt100, Pt10 = RTD Pt1000, 0.60 = 0 to 60 mV, 12.60 = 12 to 60 mV, 0.20 = 0 to 20 mA, 4.20 = 4 to 20 mA, 0.5 = 0 to 5 V, 1.5 = 1 to 5 V, 0.10 = 0 to 10 V, 2.10 = 2 to 10 V	J
2	dp	Decimal Point Position (linear inputs)	0	0 to 3	0
		Decimal Point Position (different than linear inputs)		0/1	
3	SSC	Initial scale read-out for linear inputs	dp	-1999 to 9999	0
4	FSc	Full Scale Readout for linear inputs	dp	-1999 to 9999	1000
5	unit	Engineer unit		°C/°F	°C
6	Fil	Digital filter on the measured value	1	0 (= OFF) to 20.0 s	1.0
7	inE	Sensor error used to enable the safety output value		or = Over range ur = Under range our = Over and under range	our
8	oPE	Safety output value (% of the output)		-100 to 100	0
9	IO4.F	I/O 4 function		on = Output used as PWS for TX, out4 = Output 4 (digital output 4), dG2c = Digital input 2 driven by contact, dG2U = Digital input 2 driven by voltage	out4
10	diF1	Digital Input 1 function		oFF = Not used, 1 = Alarm reset, 2 = Alarm acknowledge (ACK), 3 = Hold of the measured value, 4 = Stand by mode, 5 = Manual mode, 6 = HEAt with SP1 and Cool with SP2, 7 to 17 = No action	oFF
11	diF2	Digital Input 2 function		18 = Sequential SP selection, 19 = SP1 - SP2 selection, 20 = SP1 to SP4 binary selection, 21 = Digital inputs in parallel to  and  keys	oFF
12	di.A	Digital Inputs Action (DI2 only if configured)		0 = DI1 direct action, DI2 direct action 1 = DI1 reverse action, DI2 direct action 2 = DI1 direct action, DI2 reverse action 3 = DI1 reverse action, DI2 reverse action	0

Out group

no.	Param.	Description	Dec. Point	Values	Default
13	o1.t	Output 1 type (when Out 1 is an analog output)		0.20 = 0 to 20 mA; 4.20 = 4 to 20 mA; 0.10 = 0 to 10 V; 2.10 = 2 to 10 V.	0-20
14	o1F	Out 1 function (when Out 1 is an analog output)	0	nonE = Output not used; H.rEG = Heating output; c.rEG = Cooling output; r.inP = Measure retransmission; r.Err = Error (SP - PV) retransmission; r.SP = Set point retransmission ; r.SEr = Serial value retransmission.	H.rEG
		Out 1 function	0	nonE = Output not used H.rEG = Heating output c.rEG = Cooling output AL = Alarm output t.out = Reserved t.HoF = Reserved P.End = Reserved P.HLd = Reserved P.uit = Reserved P.run = Reserved P.Et1 = Reserved P.Et2 = Reserved or.bo = Out-of-range or burn out indicator P.FAL = Power failure indicator bo.PF = Out-of-range, burn out and Power failure indicator St.bY = Stand by status indicator diF1 = The output repeats the digital input 1 status diF2 = The output repeats the digital input 2 status on = Out 1 always ON riSP = Inspection requested (the worked hours/days counter has reached the programmed threshold)	
15	Ao1L	Initial scale value of the analog retransmission (when Out 1 is an analog output)	dP	-1999 ... Ao1H	-1999
16	Ao1H	Full scale value of the analog retransmission (when Out 1 is an analog output)	dP	Ao1L ... 9999.	9999
17	o1AL	Alarms linked up with the out 1	0	0 to 63 +1 = Alarm 1 +2 = Alarm 2 +4 = Alarm 3 +8 = Loop break alarm +16 = Sensor Break +32 = Overload on output 4	1
18	o1Ac	Out 1 action	0	dir = Direct action rEU = Reverse action dir.r = Direct with reversed LED rEU.r = Reverse with reversed LED	dir
19	o2F	Out 2 function	0	nonE = Output not used H.rEG = Heating output c.rEG = Cooling output AL = Alarm output t.out = Reserved t.HoF = Reserved P.End = Reserved P.HLd = Reserved P.uit = Reserved P.run = Reserved P.Et1 = Reserved P.Et2 = Reserved or.bo = Out-of-range or burn out indicator P.FAL = Power failure indicator bo.PF = Out-of-range, burn out and Power failure indicator St.bY = Stand by status indicator diF1 = The output repeats the digital input 1 status diF2 = The output repeats the digital input 2 status on = Out 2 always ON riSP = Inspection requested (the worked hours/days counter has reached the programmed threshold)	AL
20	o2AL	Alarms linked up with the out 2	0	0 to 63 +1 = Alarm 1 +2 = Alarm 2 +4 = Alarm 3 +8 = Loop break alarm +16 = Sensor Break +32 = Overload on output 4	AL1

no.	Param.	Description	Dec. Point	Values	Default
21	o2Ac	Out 2 action	0	dir = Direct action rEU = Reverse action dir.r = Direct with reversed LED rEU.r = Reverse with reversed LED	dir
22	o3F	Out 3 function	0	nonE = Output not used H.rEG = Heating output c.rEG = Cooling output AL = Alarm output t.out = Reserved t.HoF = Reserved P.End = Reserved P.HLd = Reserved P.uit = Reserved P.run = Reserved P.Et1 = Reserved P.Et2 = Reserved or.bo = Out-of-range or burn out indicator P.FAL = Power failure indicator bo.PF = Out-of-range, burn out and Power failure indicator St.bY = Stand by status indicator diF1 = The output repeats the digital input 1 status diF2 = The output repeats the digital input 2 status on = Out 3 always ON riSP = Inspection requested (the worked hours/days counter has reached the programmed threshold)	AL
23	o3AL	Alarms linked up with the out 3	0	0 to 63 +1 = Alarm 1 +2 = Alarm 2 +4 = Alarm 3 +8 = Loop break alarm +16 = Sensor Break +32 = Overload on output 4	AL2
24	o3Ac	Out 3 action	0	dir = Direct action rEU = Reverse action dir.r = Direct with reversed LED rEU.r = Reverse with reversed LED	dir
25	o4F	Out 4 function	0	nonE = Output not used H.rEG = Heating output c.rEG = Cooling output AL = Alarm output t.out = Reserved t.HoF = Reserved P.End = Reserved P.HLd = Reserved P.uit = Reserved P.run = Reserved P.Et1 = Reserved P.Et2 = Reserved or.bo = Out-of-range or burn out indicator P.FAL = Power failure indicator bo.PF = Out-of-range, burn out and Power failure indicator St.bY = Stand by status indicator	AL
26	o4AL	Alarms linked up with the out 4	0	0 to 63 +1 = Alarm 1 +2 = Alarm 2 +4 = Alarm 3 +8 = Loop break alarm +16 = Sensor Break +32 = Overload on output 4	AL1 + AL2
27	o4Ac	Out 4 action	0	dir = Direct action rEU = Reverse action dir.r = Direct with reversed LED rEU.r = Reverse with reversed LED	dir

AL1 group

no.	Param.	Description	Dec. Point	Values	Default
28	AL1t	Alarm 1 type	0	nonE = Alarm not used LoAb = Absolute low alarm HiAb = Absolute high alarm LHAo = Windows alarm in alarm outside the windows LHAi = Windows alarm in alarm inside the windows SE.br = Sensor Break LodE = Deviation low alarm (relative) HidE = Deviation high alarm (relative) LHdo = Relative band alarm in alarm out of the band LHdi = Relative band alarm in alarm inside the band	HiAb
29	Ab1	Alarm 1 function	0	0 to 15 +1 = Not active at power up +2 = Latched alarm (manual reset) +4 = Acknowledgeable alarm +8 = Relative alarm not active at set point change	0
30	AL1L	- For High and low alarms, it is the low limit of the AL1 threshold; - For band alarm, it is low alarm threshold	dp	From -1999 to AL1H (E.U.)	-1999
31	AL1H	- For High and low alarms, it is the high limit of the AL1 threshold; - For band alarm, it is high alarm threshold	dp	From AL1L to 9999 (E.U.)	9999
32	AL1	AL1 threshold	dp	From AL1L to AL1H (E.U.)	0
33	HAL1	AL1 hysteresis	dp	1 to 9999 (E.U.)	1
34	AL1d	AL1 delay	0	From 0 (oFF) to 9999 (s)	oFF
35	AL1o	Alarm 1 enabling during Stand-by mode and out of range conditions	0	0 = Alarm 1 disabled during Stand by and out of range 1 = Alarm 1 enabled in stand by mode 2 = Alarm 1 enabled in out of range condition 3 = Alarm 1 enabled in stand by mode and in overrange condition	0

AL2 group

no.	Param.	Description	Dec. Point	Values	Default
36	AL2t	Alarm 2 type	0	nonE = Alarm not used LoAb = Absolute low alarm HiAb = Absolute high alarm LHAo = Windows alarm in alarm outside the windows LHAi = Windows alarm in alarm inside the windows SE.br = Sensor Break LodE = Deviation low alarm (relative) HidE = Deviation high alarm (relative) LHdo = Relative band alarm in alarm out of the band LHdi = Relative band alarm in alarm inside the band	Loab
37	Ab2	Alarm 2 function	0	0 to 15 +1 = Not active at power up +2 = Latched alarm (manual reset) +4 = Acknowledgeable alarm +8 = Relative alarm not active at set point change	0
38	AL2L	- For High and low alarms, it is the low limit of the AL2 threshold; - For band alarm, it is low alarm threshold	dp	From -1999 to AL2H (E.U.)	-1999
39	AL2H	- For High and low alarms, it is the high limit of the AL2 threshold; - For band alarm, it is high alarm threshold	dp	From AL2L to 9999 (E.U.)	9999
40	AL2	AL2 threshold	dp	From AL2L to AL2H (E.U.)	0
41	HAL2	AL2 hysteresis	dp	1 to 9999 (E.U.)	1
42	AL2d	AL2 delay	0	From 0 (oFF) to 9999 (s)	oFF
43	AL2o	Alarm 2 enabling during Stand-by mode and out of range conditions	0	0 = Alarm 2 disabled during Stand by and out of range 1 = Alarm 2 enabled in stand by mode 2 = Alarm 2 enabled in out of range condition 3 = Alarm 2 enabled in stand by mode and in overrange condition	0

AL3 group

no.	Param.	Description	Dec. Point	Values	Default
44	AL3t	Alarm 3 type	0	nonE = Alarm not used LoAb = Absolute low alarm HiAb = Absolute high alarm LHAo = Windows alarm in alarm outside the windows LHAi = Windows alarm in alarm inside the windows SE.br = Sensor Break LodE = Deviation low alarm (relative) HidE = Deviation high alarm (relative) LHdo = Relative band alarm in alarm out of the band LHdi = Relative band alarm in alarm inside the band	nonE
45	Ab3	Alarm 3 function	0	0 to 15 +1 = Not active at power up +2 = Latched alarm (manual reset) +4 = Acknowledgeable alarm +8 = Relative alarm not active at set point change	0
46	AL3L	- For High and low alarms, it is the low limit of the AL3 threshold; - For band alarm, it is low alarm threshold	dp	From -1999 to AL3H (E.U.)	-1999
47	AL3H	- For High and low alarms, it is the high limit of the AL3 threshold; - For band alarm, it is high alarm threshold	dp	From AL3L to 9999 (E.U.)	9999
48	AL3	AL3 threshold	dp	From AL3L to AL3H (E.U.)	0
49	HAL3	AL3 hysteresis	dp	1 to 9999 (E.U.)	1
50	AL3d	AL3 delay	0	From 0 (oFF) to 9999 (s)	oFF
51	AL3o	Alarm 3 enabling during Stand-by mode and out of range conditions	0	0 = Alarm 3 disabled during Stand by and out of range 1 = Alarm 3 enabled in stand by mode 2 = Alarm 3 enabled in out of range condition 3 = Alarm 3 enabled in stand by mode and in overrange condition	0

LbA group - Loop Break Alarm Parameters

no.	Param.	Description	Dec. Point	Values	Default
52	LbAt	LBA time	0	From 0 (oFF) to 9999 (s)	oFF
53	LbSt	Delta measure used by LBA during Soft start	dP	From 0 (oFF) to 9999 (E.U.)	10
54	LbAS	Delta measure used by LBA	dP	1 to 9999 (E.U.)	20
55	LbcA	Condition for LBA enabling	0	uP = Active when Pout = 100% dn = Active when Pout = -100% both = Active in both cases	both

rEG group - Control Parameters

no.	Param.	Description	Dec. Point	Values	Default
56	cont	Control type	0	Pid = PID (heat and/or) On.FA = ON/OFF asymmetric hysteresis On.FS = ON/OFF symmetric hysteresis nr = Heat/Cool ON/OFF control with neutral zone	Pid
57	Auto	Autotuning selection	0	-4 = Oscillating auto-tune with automaticrestart at power up and after all point change -3 = Oscillating auto-tune with manual start -2 = Oscillating -tune with auto-matic start at the first power up only -1 = Oscillating auto-tune with auto-matic restart at every power up 0 = Not used 1 = Fast auto tuning with automatic restart at every power up 2 = Fast auto-tune with automatic start the first power up only 3 = FAST auto-tune with manual start 4 = FAST auto-tune with automatic restart at power up and after a set point change 5 = Evo-tune with automatic restart at every power up 6 = Evo-tune with automatic start the first power up only 7 = Evo-tune with manual start 8 = Evo-tune with automatic restart at power up and after a set point change	7
58	tunE	Manual start of the Autotuning	0	oFF = Not active on = Active	oFF
59		Reserved			

no.	Param.	Description	Dec. Point	Values	Default
60	HSEt	Hysteresis of the ON/OFF control	dP	0 to 9999 (E.U.)	1
61	cPdt	Time for compressor protection	0	From 0 (oFF) to 9999 (s)	oFF
62	Pb	Proportional band	dP	1 to 9999 (E.U.)	50
63	ti	Integral time	0	From 0 (oFF) to 9999 (s)	200
64	td	Derivative time	0	From 0 (oFF) to 9999 (s)	50
65	Fuoc	Fuzzy overshoot control	2	0.00 to 2.00	0.50
66	tcH	Heating output cycle time	1	0.1 to 130.0 (s)	20.0
67	rcG	Power ratio between heating and cooling action	2	0.01 to 99.99	1.00
68	tcc	Cooling output cycle time	1	0.1 to 130.0 (s)	20.0
69	rS	Manual reset (Integral pre-load)	1	-100.0 to +100.0 (%)	0.0
70	Str.t	Reserved			
71	db.S	Reserved			
72	od	Delay at power up	2	From 0.00 (oFF) to 99.59 (hh.mm)	oFF
73	St.P	Maximum power output used during soft start	0	-100 to 100 (%)	0
74	SSt	Soft start time	2	- 0.00 (oFF); - 0.01 to 7.59 (hh.mm); - inF (always ON).	oFF
75	SStH	Threshold for soft start disabling	dP	-1999 to +9999 (E.U.)	9999

³ SP group - Set point parameters

no.	Param.	Description	Dec. Point	Values	Default
76	nSP	Number of used set points	0	1 to 4	1
77	SPLL	Minimum set point value	dP	From -1999 to SPHL	-1999
78	SPHL	Maximum set point value	dP	From SPLL to 9999	9999
79	SP	Set point 1	dP	From SPLL to SPLH	0
80	SP 2	Set point 2	dP	From SPLL to SPLH	0
81	SP 3	Set point 3	dP	From SPLL to SPLH	0
82	SP 4	Set point 4	dP	From SPLL to SPLH	0
83	A.SP	Selection of the active set point	0	From SP to SPn where n is equal to [76] nSP value	1
84	SP.rt	Remote set point type	0	rSP = The value coming from serial link is used as remote set point; trin = The value will be added to the local set point selected by A.SP and the sum becomes the operative set point; PErc = The value will be scaled on the input range and this value will be used as remote SP.	trin
85	SP.Lr	Local/remote set point selection	0	Loc = local; rEn = remote.	Loc
86	SP.u	Rate of rise for POSITIVE set point change (ramp UP)	2	0.01 to 99.99 (inF) Eng. units per minute	inF
87	SP.d	Rate of rise for NEGATIVE set point change (ramp DOWN)	2	0.01 to 99.99 (inF) Eng. units per minute	inF

NOTE: parameters from [88] to [117] are reserved.

PAAn group - Operator HMI parameters

no.	Param.	Description	Dec. Point	Values	Default
118	PAS2	Level 2 password (limited access level)	0	- oFF (Level 2 not protected by password); - 1 to 200.	20
119	PAS3	Level 3 password (complete configuration level)	0	3 to 200	30
120	PAS4	Level 4 password (CODE configuration level)	0	201 to 400	300
121	uSrb	 button function during RUN TIME		nonE = No function; tunE = Auto-tune/self-tune enabling. A single press (longer than 1 second) starts the auto-tune; oPLo = Manual mode. The first pressure puts the instrument in manual mode (OPLO) while a second one puts the instrument in Auto mode; AAc = Alarm reset; ASi = Alarm acknowledge; chSP = Sequential set point selection; St.by = Stand by mode. The first press puts the instrument in stand by mode while a second one puts the instrument in Auto mode; Str.t = Reserved; P.run = Reserved; P.rES = Reserved; P.r.H.r = Reserved. HE.co = Reserved	tunE
122	diSP	Display management		nonE = Standard display; Pou = Power output; SPF = Final set point; SPo = Operative set point; AL1 = Alarm 1 threshold; AL2 = Alarm 2 threshold; AL3 = Alarm 3 threshold; Pr.tu = Reserved; Pr.td = Reserved; P.t.tu = Reserved; P.t.td = Reserved; ti.uP = Reserved; ti.du = Reserved; PErc = Percent of the power output used during soft start (when the soft start time is equal to infinite, the limit is ever active and it can be used also when ON/OFF control is selected); PoS = Reserved.	SPo
123	di.cL	Display colour		0 = The display colour is used to show the actual deviation (PV - SP); 1 = Display red (fix); 2 = Display green (fix); 3 = Display orange (fix).	0
124	AdE	Deviation for display colour management		1 to 999 (E.U.)	5
125	diS.t	Display Timeout	2	- oFF (display always ON); - 0.1 to 99.59 (mm.ss).	oFF
126	FiLd	Filter on the displayed value	0	- oFF (filter disabled) - From 0 (oFF) to 100 (E.U.)	oFF
127		Reserved			
128	dSPu	Instrument status at power ON		AS.Pr = Starts in the same way it was prior to the power down; Auto = Starts in Auto mode; oP.0 = Starts in manual mode with a power output equal to zero; St.bY = Starts in stand-by mode.	AS.Pr
129	oPr.E	Operative modes enabling		ALL = All modes will be selectable by the next parameter; Au.oP = Auto and manual (OPLO) mode only will be selectable by the next parameter; Au.Sb = Auto and Stand-by modes only will be selectable by the next parameter.	ALL
130	oPEr	Operative mode selection		If oPr.E = ALL: - Auto = Auto mode; - oPLo = Manual mode; - St.bY = Stand by mode. If oPr.E = Au.oP: - Auto = Auto mode; - oPLo = Manual mode. If oPr.E = Au.Sb: - Auto = Auto mode; - St.bY = Stand by mode.	Auto

SEr group - Serial link parameters

no.	Param.	Description	Dec. Point	Values	Default
131	Add	Instrument address		- oFF - 1 to 254	1
132	bAud	baud rate		1200 = 1200 baud 2400 = 2400 baud 9600 = 9600 baud 19.2 = 19200 baud 38.4 = 38400 baud	9600
133	trSP	Selection of the value to be retransmitted (Master)		nonE = Retransmission not used (the instrument is a slave); rSP = The instrument becomes a Master and retransmits the operative set point; PErc = The instrument become a Master and it retransmits the power output.	nonE

COn group - Consumption parameters

no.	Param.	Description	Dec. Point	Values	Default
134	Co.tY	Count type		oFF = Not used; 1 = Instantaneous power (kW); 2 = Power consumption (kW/h); 3 = Reserved; 4 = Total worked days: number of hours the instrument is turned ON divided by 24; 5 = Total worked hours: number of hours the instrument is turned ON; 6 = Total worked days with threshold: number of hours the instrument is turned ON divided by 24, the controller is forced in stand-by when Co.ty value reaches the threshold set in [137] h.Job; 7 = Total worked hours with threshold: number of hours the instrument is turned ON, the controller is forced in stand-by when Co.ty value reaches the threshold set in [137] h.Job; 8 = Totalizer of control relay worked days: number of hours the control relay has been in ON condition, divided by 24; 9 = Totalizer of control relay worked hours: number of hours the control relay has been in ON condition; 10 = Totalizer of control relay worked days with threshold: number of hours the control relay has been in ON condition divided by 24, the controller is forced in stand-by when Co.ty value reaches the threshold set in [137] h.Job; 11 = Totalizer of control relay worked hours with threshold: number of hours the control relay has been in ON condition, the controller is forced in stand-by when Co.ty value reaches the threshold set in [137] h.Job.	oFF
135	UoLt	Nominal Voltage of the load		1 to 9999 (V)	230
136	cur	Nominal current of the load		1 to 999 (A)	10
137	h.Job	Threshold of the working period		oFF = threshold not used 0 to 9999 days (when [133] cotY = 4) 0 to 9999 hours (when [133] cotY = 5)	0
138	t.Job	Worked time (not resettable)		0 to 9999 days	

CAL group - User calibration parameters

no.	Param.	Description	Dec. Point	Values	Default
139	A.L.P	Adjust Low Point		From -1999 to (AH.P - 10) in engineering units	0
140	A.L.o	Adjust Low Offset		-300 to +300 (E.U.)	0
141	A.H.P	Adjust High Point		From (AL.P + 10) to 9999 engineering units	9999
142	A.H.o	Adjust High Offset		-300 to +300	0

