

UV sensors UVS 5, UVS 10

TECHNICAL INFORMATION

- Virtually immune to interference due to its insensitivity to daylight, infrared radiation and incandescent bulbs
- Maximum safety thanks to protection against discontinuity or short-circuit on the flame signal cable
- Suit industrial needs due to robust design
- Comply with the requirements of EN 298 in conjunction with Kromschroder automatic burner control units and burner control units



Contents

| | |
|---|-----------|
| Contents | 2 |
| 1 Application | 3 |
| 2 Certification | 4 |
| 2.1 Eurasian Customs Union | 4 |
| 3 Function | 5 |
| 3.1 Part designations | 6 |
| 3.2 Electrical connection | 7 |
| 4 Replacement possibilities | 8 |
| 5 Selection | 9 |
| 5.1 ProFi | 9 |
| 5.2 Type code | 9 |
| 6 Project planning information | 10 |
| 6.1 Installation | 10 |
| 6.2 Weak UV radiation | 10 |
| 6.3 Purge air/Cooling air | 11 |
| 6.4 Electrical connection | 11 |
| 7 Accessories | 12 |
| 7.1 UV tube for UVS 5 | 12 |
| 7.2 UV tube for UVS 10 | 12 |
| 7.3 Adapter UVS 1 for UVS 10 | 12 |
| 7.4 Cooling air adapter for UVS 10 | 12 |
| 7.5 Quartz glass disc for UVS 10 | 13 |
| 8 Technical data | 14 |
| 8.1 UVS 5 | 14 |
| 8.2 UVS 10 | 15 |
| 9 Maintenance cycles | 16 |
| For more information | 17 |

1 Application

For monitoring gas burners of unlimited capacity with or without fan, on hot-air furnaces, gas-fired boilers, industrial furnaces and excess-gas flaring installations in conjunction with Kromschroder automatic burner control units and burner control units. The UV sensors monitor the gas burners in intermittent operation. The burners can either be ignited directly or operated as pilot and main burners.

UVS 5



An old UVS 5 (with non-detachable PVC cable) can be replaced with the new UVS 5G1 (with cable gland and spring force terminals).

UVS 10



UV sensors UVS 1, UVS 6 and UVS 8 can be replaced by using various adapters with a heat guard made of quartz glass.



2 Certification



For certification, see Technical Information of the corresponding automatic burner control unit or burner control unit that the UV sensors UVS 5 or UVS 10 are to be used with.

2.1 Eurasian Customs Union



The products UVS 5, UVS 10 meet the technical specifications of the Eurasian Customs Union.

3 Function

The UV tube detects the ultraviolet light of a flame. In the case of incident UV light, alternating current flows through the UV tube and is converted into a DC signal by the UV sensor. The DC signal can be processed by a flame signal amplifier.

The UV tube does not respond to daylight, incandescent bulb light or infrared radiation emitted by hot workpieces or red-hot furnace walls.

The designed lifetime of the UV tube is approximately 10,000 operating hours. For safety reasons, it must be replaced after this period.

UVS 10

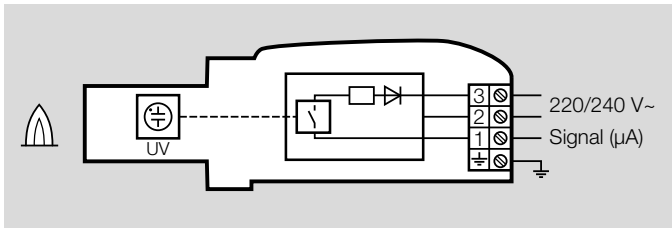

A quartz glass heat guard insulates the UV tube against the hot furnace atmosphere and protects against moisture, dirt and heat.

UVS 5

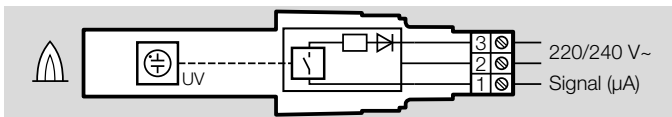

Protect the UV sensor against electrostatic charging by grounding the combustion chamber or the bracket.

3.1 Part designations

UVS 5

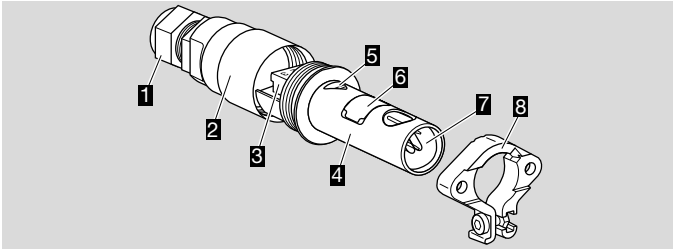

- 1 M20 cable gland
- 2 Housing
- 3 Spring force terminals (trm. 1, trm. 2, trm. 3)
- 4 Sensor head
- 5 Positioning aid
- 6 Sticker
- 7 UV tube
- 8 Bracket

UVS 10

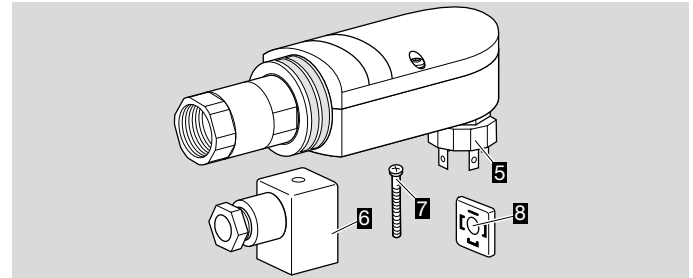
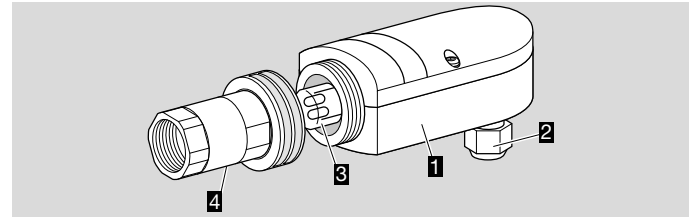

- 1 Housing
- 2 Cable gland
- 3 UV tube
- 4 Adapter with quartz glass
- 5 Plug
- 6 Socket
- 7 Retaining screw
- 8 Seal

3.2 Electrical connection

Example: electrical connection to automatic burner control unit IFD 258

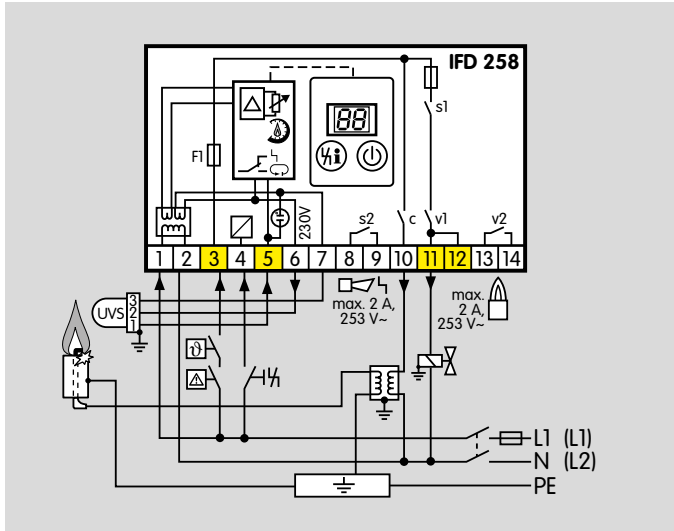

4 Replacement possibilities

UVS 1, UVS 6 and UVS 8 will be replaced by UVS 10D,

UVS 5 will be replaced by UVS 5G1.

| UV sensor | | Note |
|-----------|--------------------------|---|
| Old | New | |
| UVS 1 | UVS 10D0G1 ¹⁾ | Replaces UVS 1 with heat guard. UVS 1 connection cable can continue to be used. |
| UVS 5 | UVS 5G1 | Old bracket, clamping collar and PVC connection cable can continue to be used. |
| UVS 6 | UVS 10D0G1 | UVS 6 connection cable can continue to be used. |
| UVS 8 | UVS 10D2 | UVS 8 connection cable can continue to be used. |

¹⁾ With Rp 1/2 internal thread

5 Selection

UV sensors UVS 5, UVS 10D0, UVS 10D1, UVS 10D4, UVS 10L0 and UVS 10L1 can be equipped with an M20 cable gland for electrical connection.

5.1 ProFi

A web app selecting the correct product is available at www.adlatus.org.

5.2 Type code

| | |
|------------|--|
| UVS | UV sensor |
| 5 | Series 5 |
| 10 | Series 10 |
| D | Quartz glass heat guard |
| L | Quartz glass heat guard lens |
| 0 | Rp 1/2 internal thread |
| 1 | Rp 1/2 internal thread and cooling air connection |
| 2 | 1/2 NPT internal thread |
| 3 | 1/2 NPT internal thread and cooling air connection |
| 4 | UVS 1 adapter (28 mm (1.1")) |
| G1 | M20 cable gland |

6 Project planning information

6.1 Installation

The UV sensor may only be exposed to the UV light of its own flame. It should be protected from other sources of ultraviolet light. These could be, for example: neighbouring flames (this must be observed when monitoring pilot and main burners in particular), ignition sparks, arcs from welding devices or lamps emitting ultraviolet light.

Do not expose the UV sensor viewing opening to direct sunlight to avoid incorrect flame signals.

Direct the UV sensor at the flame inclined from above or in the horizontal so that no dirt collects in front of the UV sensor.

UVS 5

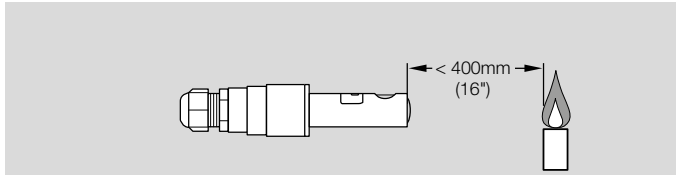

The sensor is mounted using the bracket supplied which is attached to the burner.

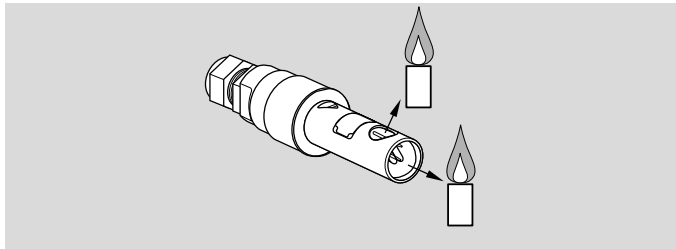

The UV tube can be directed towards the flame from the side or front with the help of the viewing openings in the sensor head.

UVS 10

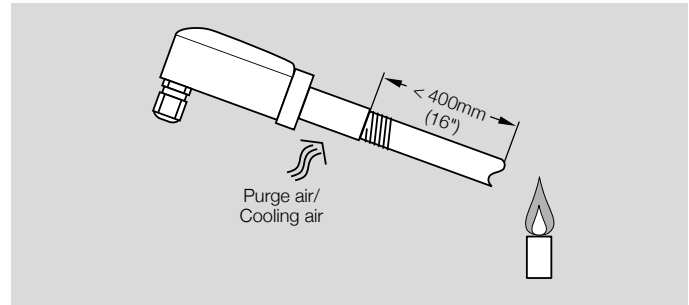

The sensor is mounted to a ½" viewing tube using the adapter (supplied) with integrated quartz glass heat guard. The viewing tube should be directed at the first flame third, as this is where the highest UV radiation is generally found. The inside of the steel tube should not be coated.

Supply cooling air to cool and protect the optical system from soiling and condensation.

6.2 Weak UV radiation

UVS 10

In order to concentrate weak UV radiation more effectively and to achieve a stronger UV signal, a quartz glass lens is available for the UVS 10, see page 13 (7.5 Quartz glass disc for UVS 10). When installing, ensure that the lens curvature points towards the flame. Thereby, the UV sensor must be precisely directed at the flame.

6.3 Purge air/Cooling air

UVS 10

The UVS 10 can be supplied with cooling or purge air through a cooling air adapter for cooling purposes and to protect the lens from soiling and condensation. Various nozzles for the cooling air adapter can be supplied for adjusting the air volume and the O₂ content perfectly to the site conditions, see page 12 (7.4 Cooling air adapter for UVS 10).

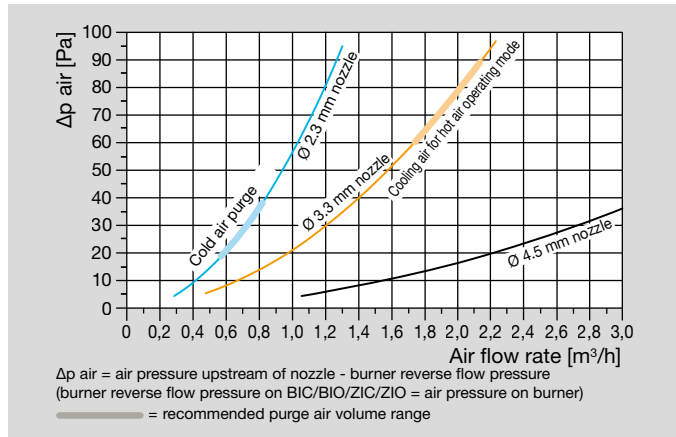

A purge air nozzle is not required for Kromschroder burners (BIO, BIC, ZIO, ZIC) if they are used with cold combustion air.

A nozzle with a diameter of 4.5 mm can be used for processes which are not O₂ critical.

6.4 Electrical connection

The UV sensor is operated with an alternating voltage of 220/240 V. The voltage is provided by the automatic burner control unit or the flame detector.

Wire the UV sensor according to the connection diagram of the relevant automatic burner control unit or flame detector. A grounded mains is not required.

7 Accessories

7.1 UV tube for UVS 5

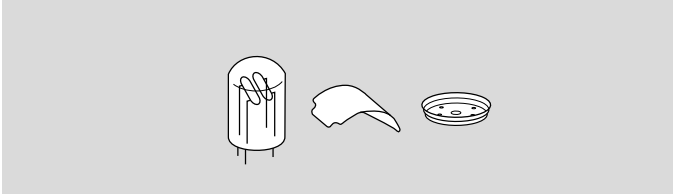

With sticker and seal

Order No.: 7 496 068 7

7.2 UV tube for UVS 10

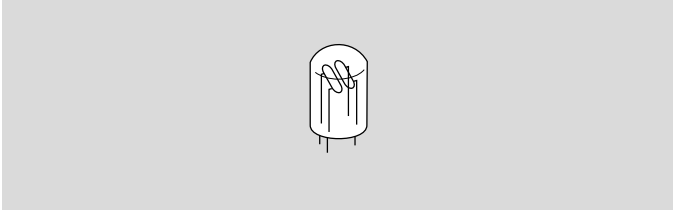

Order No.: 7 496 044 5

7.3 Adapter UVS 1 for UVS 10

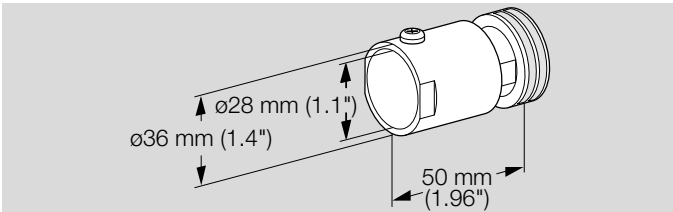

With quartz glass heat guard

Order No.: 7 496 061 5

7.4 Cooling air adapter for UVS 10

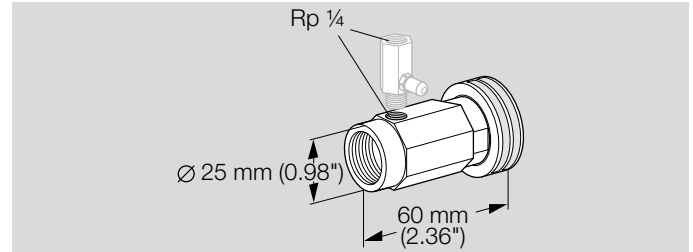

With quartz glass heat guard

Rp 1/2, Order No.: 7 496 061 4

1/2 NPT, Order No.: 7 496 061 3

Nozzle for cooling air adapter, Order No.: 7 496 061 6

7.5 Quartz glass disc for UVS 10

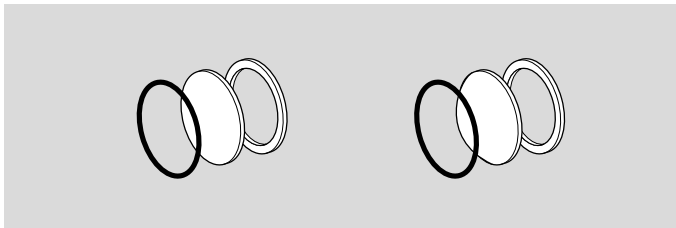

To protect the UV tube

Quartz glass disc with seal,

Order No.: 7 496 061 2

Quartz glass lens with seal

When installing, ensure that the lens curvature points towards the flame. Precisely align the UV sensor. The gap between the UV sensor and the flame can be increased to approximately 600 to 1200 mm (23" to 47").

Order No.: 7 496 061 1

8 Technical data

8.1 UVS 5

Ambient conditions

Condensation and dew in and on the unit are not permitted.

Avoid direct sunlight or radiation from red-hot surfaces on the unit.

Avoid corrosive influences, e.g. salty ambient air or SO₂.

Ambient temperature:

-40 to +80°C (-40 to +176°F).

Storage temperature:

-40 to +80°C (-40 to +176°F).

Transport temperature = ambient temperature.

Enclosure: IP 54 (Nema 3),

IP 40 around the viewing openings with fitted tube and seal.

Permitted operating altitude: < 2000 m AMSL.

Mechanical data

Plastic housing with connection terminals.

Designed lifetime of the UV tube:

approx. 10,000 operating hours.

Distance between UV sensor and flame:

max. 400 mm (max. 16").

Weight: 70 g (0.15 lbs).

Max. length of cable between UV sensor and automatic

burner control unit:

see instructions for automatic burner control unit.

Electrical data

Cable gland for cable diameters:

7 to 13 mm.

UV tube: P578,
spectral range: 190–270 nm,
max. sensitivity: 210 nm ± 10 nm.

Min. DC signal: 1 µA.

Dimensions

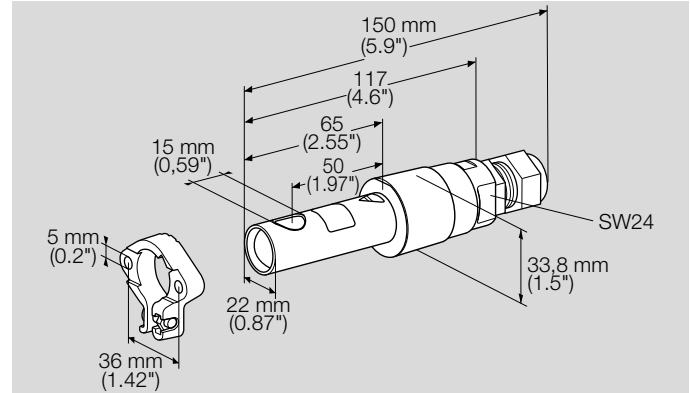

8.2 UVS 10

Ambient conditions

Condensation and dew in and on the unit are not permitted.

Avoid direct sunlight or radiation from red-hot surfaces on the unit.

Avoid corrosive influences, e.g. salty ambient air or SO₂.

Ambient temperature:

-40 to +80°C (-40 to +176°F).

Storage temperature:

-40 to +80°C (-40 to +176°F).

Transport temperature = ambient temperature.

Enclosure: IP 65.

Permitted operating altitude: < 2000 m AMSL.

Mechanical data

Aluminium housing with integrated heat guard, with connection terminals.

Designed lifetime of the UV tube:

approx. 10,000 operating hours.

Distance between UV sensor and flame:

300–400 mm (12 to 16"),

with quartz glass lens:

approx. 600 to 1200 mm (23 to 47").

Weight: 280 g (0.6 lbs).

Max. length of cable between UV sensor and automatic burner control unit:

see instructions for automatic burner control unit.

Electrical data

UV tube: P578,

spectral range: 190–270 nm,

max. sensitivity: 210 nm ± 10 nm.

Min. DC signal: 1 µA.

Dimensions

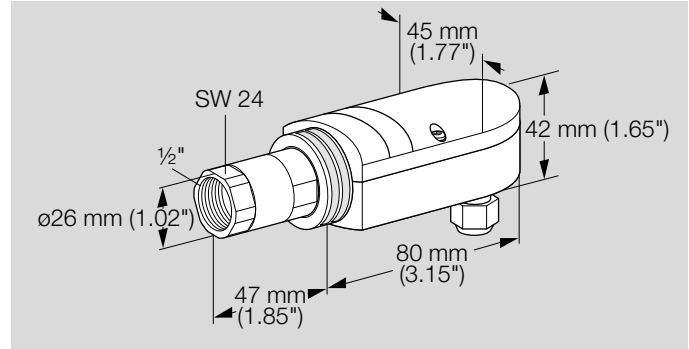

9 Maintenance cycles

Designed lifetime of the UV tube: 10,000 operating hours.

The UV tube must be replaced after this period, see page 12 (7.1 UV tube for UVS 5) or page 12 (7.2 UV tube for UVS 10).

For more information

The Honeywell Thermal Solutions family of products includes Honeywell Combustion Safety, Eclipse, Exothermics, Hauck, Kromschroder and Maxon. To learn more about our products, visit ThermalSolutions.honeywell.com or contact your Honeywell Sales Engineer.

Elster GmbH
Strotheweg 1, D-49504 Lotte
T +49 541 1214-0
hts.lotte@honeywell.com
www.kromschroeder.com

© 2023 Elster GmbH

We reserve the right to make technical modifications in the interests of progress.

