



Instruction Manual

**ZIRCONIA OXYGEN
ANALYZER CONVERTER**
transmission specification
<RS485 MODBUS>
<HART>

TYPE: ZKMA, B

CONTENTS

1. COMMUNICATION FUNCTION.....	1
1.1 Outline.....	1
2. SPECIFICATIONS.....	2
2.1 Communication specifications.....	2
3. CONNECTION.....	3
3.1 Terminal allocation.....	3
3.2 Connection.....	4
4. SETTING OF COMMUNICATION CONDITION (RS485).....	6
4.1 Setting item.....	6
4.2 Setting operation.....	6
5. MODBUS COMMUNICATION PROTOCOL (RS485).....	7
5.1 Outline.....	7
5.2 Composition of Message.....	8
5.3 Response of Slave Station.....	9
5.4 Function Code.....	10
5.5 Calculation of Error Check Code (CRC-16).....	11
5.6 Transmission Control Procedure.....	13
6. DETAILS OF MESSAGE (MODBUS).....	15
6.1 Word data readout [Function code: 03 _H].....	15
6.2 Reading Read-Only Word Data [Function Code: 04 _H].....	16
6.3 Writing Word Data (unit of 1 word) [function code: 06 _H].....	17
6.4 Writing Continuous Word Data [Function code: 10 _H].....	18
7. ADDRESS MAP AND DATA FORMAT (MODBUS).....	19
7.1 Data format.....	19
7.1.1 Transmission data format.....	19
7.1.2 Handling of decimal point position and measurement unit.....	19
7.1.3 Handling at measurement data over-range.....	19
7.2 Address map (MODBUS).....	20
8. HART COMMUNICATION.....	34
8.1 HART communicator menu trees.....	34
8.1.1 Menu tree 1 (generic).....	34
8.1.2 Menu tree 2 (specific to ZKM).....	35

1. COMMUNICATION FUNCTION

1.1 Outline

- This instrument optionally provides a communication function through RS-485 or HART which allows data transmit to or receive from the host computer and other devices.

<RS485>

- The communication system is composed of a master and slave relationship.
Up to 31 of slave station (present instrument) can be connected per master station (host computer, programmable controller, graphic display panel, etc.) through RS485 interface.
- Because the master station can communicate with only one slave station at a time, the destination can be identified by the “Station No.” set for each slave station.
- To establish a communication between a master and slaves, their data format must be the same. Data format of ZKM is specified by MODBUS protocol.

<HART communication >

The HART Protocol enables data communication between ZKM and communication tools (*) using a HART communication wavelength that is superimposed on the 4-20 mA analog signals.

*Communication tools include: HART master (host device), HART handheld communicator, etc.

- **Functionality**

You can operate some of the functions of ZKM through HART communication.

See “8.1 HART communicator menu trees” for available functions.

*ZKM HART communication does not support burst mode.

*HART (Highway Addressable Remote Transducer) is a registered trademark of the HART Communication Foundation.

2. SPECIFICATIONS

2.1 Communication specifications

(a) RS-485 interface

Item	SPECIFICATIONS	
Electrical specification	Based on EIA RS-485	
Communication method	2-wire, semi-duplicate	
Synchronizing method	Start-stop synchronous system	
Connection format	1:N	
Number connectable units	31 units	
Communication distance	Maximum 500m (total extension)	
Baud rate	38400 bps	
Data Format	Data length	8 bits
	Stop bit	1 bits
	Parity	None
	X flow control	None
Transmission code	HEX value (MODBUS RTU mode)	
Error detection	CRC-16	
Isolation	Isolation from internal circuit Functional isolation between signal line and ground	

(b) HART interface

Compliant with HART (Highway Addressable Remote Transducer) protocol.

HART Protocol version: 7

Manufacturer ID: 000015 (Hex)

Device type: 0020 (Hex)

3. CONNECTION

⚠ WARNING

Do not turn on the power supply until all wiring have been completed to avoid electric shock and malfunctions.

3.1 Terminal allocation

(a) RS-485 Interface

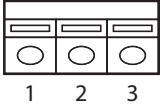
Terminal number	Signal name	Pin connection
1	Singnal ground	
2	TRx+	
3	TRx-	

(b) HART Interface

4-20mA analog output (AO) terminal (between the terminal 5 and the terminal 6).

3.2 Connection

(a) RS-485 Interface

- Please use a shielded twist pair cable.
(Recommended cable: KPEV-SB (made by The Furukawa Electric Co., Ltd.))
- The total extension length of the cable is up to 500 m. One master and up to thirty-one micro controllers (slaves) can be connected per circuit.
- Both ends of the cable should terminate with terminating resistors 100Ω ($1/2W$ or more).
- Ground the shielded cable once towards the master side.

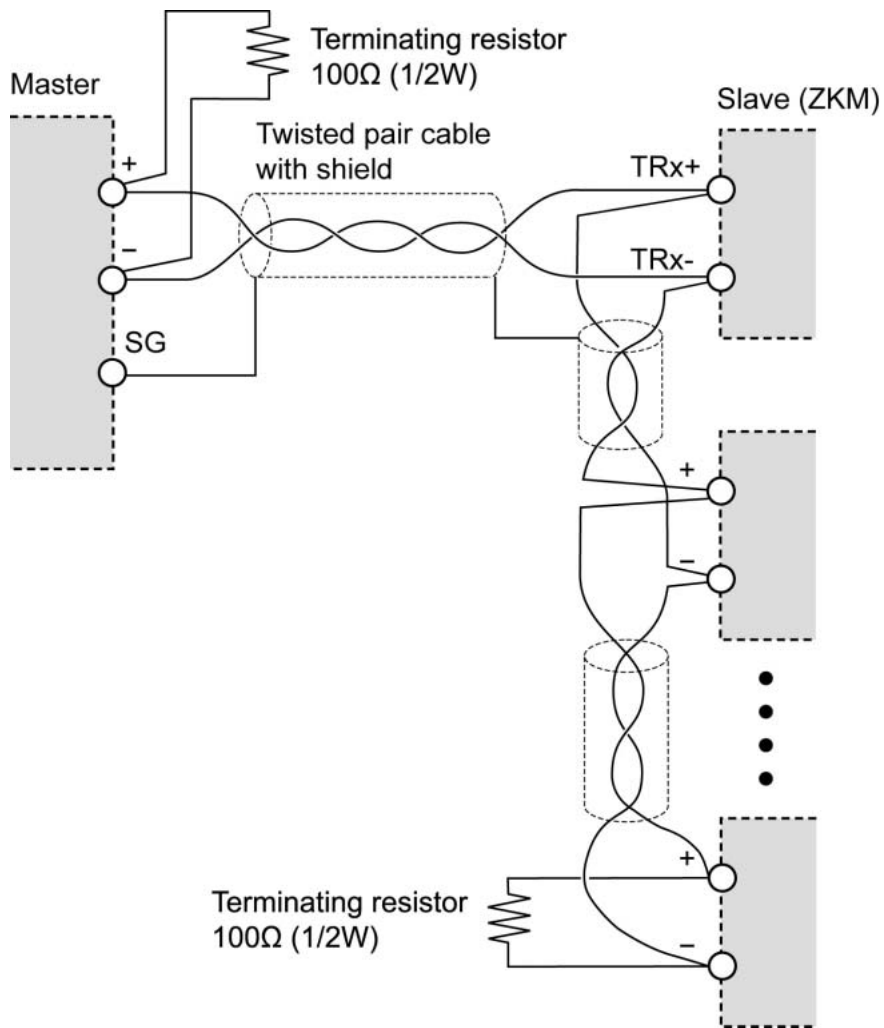

- SG does not have to be connected, but it can be used as an effective countermeasure against communication errors due to noise.
- When using the micro controller in an area where the imposed noise level is expected to exceed 500V, we recommend using a noise filter on the master side as seen in the figure below.
[Noise filter] (Recommended): ZRAC2203-11 (made by TDK Corporation)

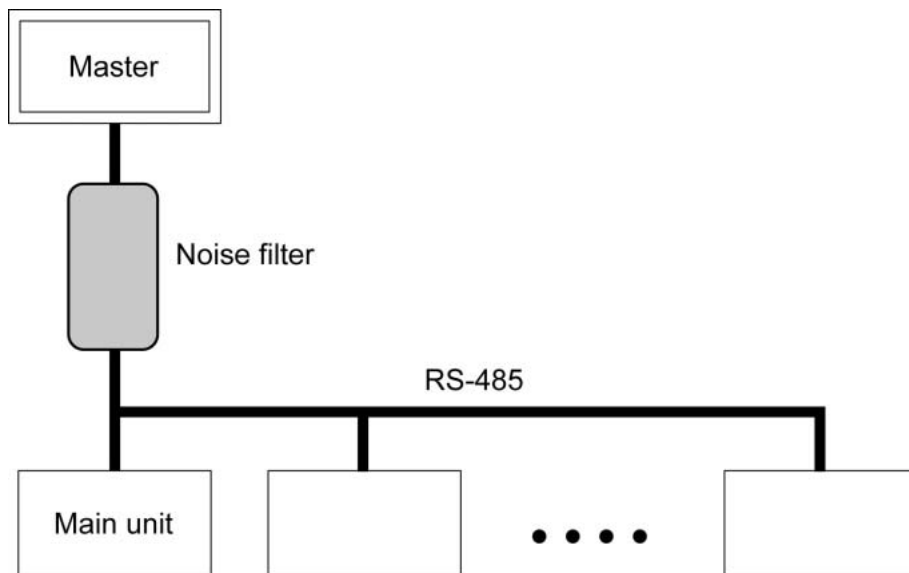

- If there are problems with EMC during communication, the noise level can be reduced by using a communication cable with a ferrite core.
Ferrite core (recommended): ZCAT series (made by TDK Corporation)
MSFC series (made by Morimiya Electric Co., Ltd.)

(b) HART Interface

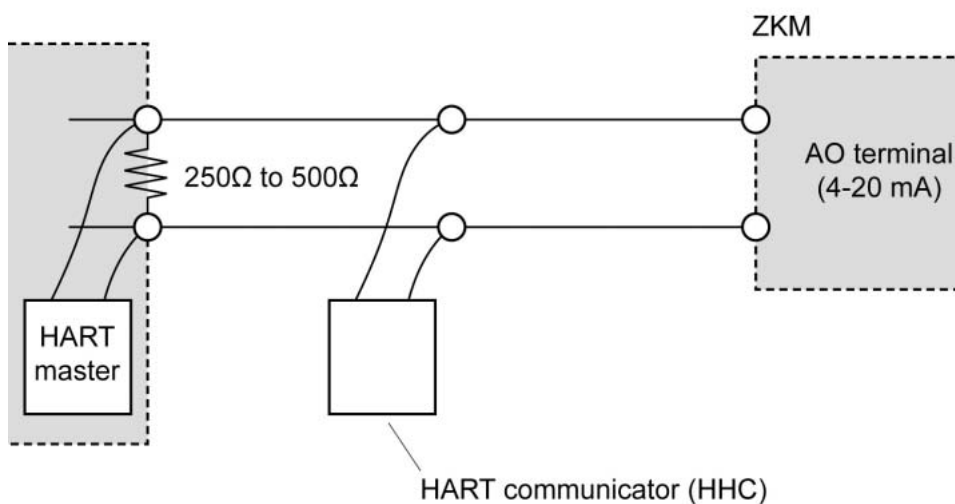

* Burst mode are not supported.

4. SETTING OF COMMUNICATION CONDITION (RS485)

To establish communication between a master device and ZKMs, the following conditions must be satisfied.

- All communication condition settings of the master station are the same as those of ZKMs.
- All ZKMs connected on a line are set to “Station No.” which are different from each other. (Any “Station No.” is not shared by more than one instrument.)

4.1 Setting item

The parameters to be set are shown in the following table.

Set them by operating keys on the screen.

Item	Factory shipment default	Settable range	Remarks
Baud rate	38400 bps	Fixed (can not be changed)	Set the same communication condition to the master station and all slave stations.
Data length	8 bits	Fixed (can not be changed)	
Stop bit	1 bit	Fixed (can not be changed)	
Parity setting	None	Fixed (can not be changed)	
Station No.	1	0 to 31 (0: Communication function stops)	Set a different value to each station.

4.2 Setting operation

Set the station No. on the parameter screen. (Refer to the instruction manual)

There is no item to be configured for HART communication.

5. MODBUS COMMUNICATION PROTOCOL (RS485)

5.1 Outline

The communication system by the MODBUS protocol is that the communication is always started from the master station and a slave station responds to the received message.

Transmission procedures are as shown below.

- 1) The master station sends a command message to a slave station.
- 2) The slave station checks that the station No. in the received message matches with the own station No. or not.
- 3) If matched, the slave station executes the command and sends back the response message.
- 4) If mismatched, the slave station leaves the message and wait for the next command message.

- (a) In case when the station No. in the received command message matches with the own slave station No.

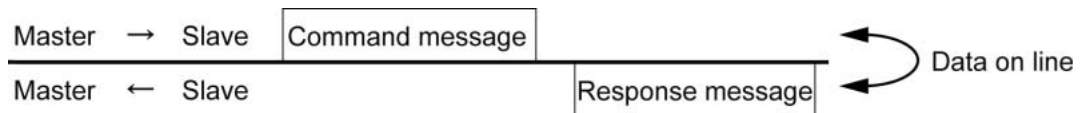

- (b) In case when the station No. in the received command message matches with the own slave station No.

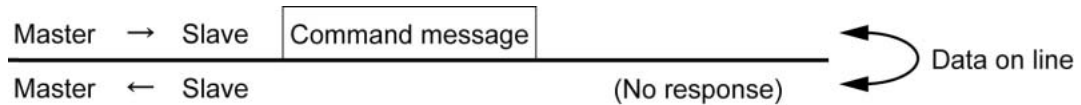

The master is connected to the same line by specifying the station No. in the command message. For multiple slaves, it is possible to communicate individually.

5.2 Composition of Message

Command message and response message consist of 4 fields; Station No., Function code, Data and Error check code. And these are sent in this order.

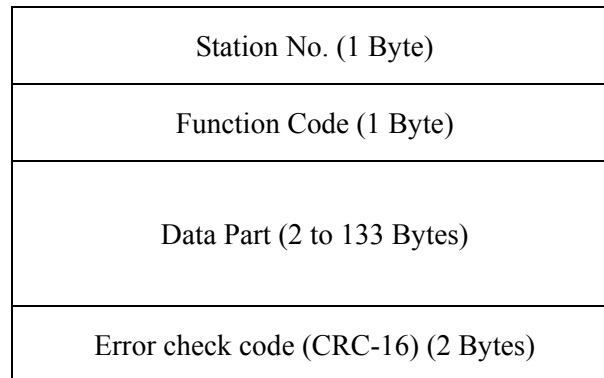

Fig. 5-1 Composition of message

In the following, each field is explained.

(1) Station No.

Station No. is the number specifying a slave station. Only a slave station that corresponds to a value to which “Station No.” is set on the analyzer maintenance mode display executes a command.

(2) Function code

This is a code to designate the function executed at a slave station.

For details, refer to section 5.4.

(3) Data part

Data are the data required for executing function codes. The composition of the data part is different depending on the function code. For details, refer to chapter 6.

A register number is assigned to each data in the analyzer. For reading/writing the data by communication, designate the register number.

$$\boxed{\text{Relative address}} = \left(\text{Last 4 digits of } \boxed{\text{Coil number or register number}} \right) - 1$$

For example, the register number specified by certain function code = in case of 4003

$$\begin{aligned} \text{Relative address} &= (\text{Lower 4 digits of } 4003) - 1 \\ &= 0002 \end{aligned}$$

The message above will be used.

(4) Error check code

This is the code to detect message errors (change in bit) in the signal transmission.

MODBUS protocol (RTU mode) uses CRC16 (Cyclic Redundancy Check).

For CRC calculation method, refer to section 5.5.

5.3 Response of Slave Station

(1) Response for normal command

To a relevant message, the slave station creates and sends back a response message which corresponds to the command message. The composition of message in this case is the same as in Section 5.2.

Contents of the data field depend on the function code. For details, refer to chapter 6.

(2) Response for abnormal command

If there are problems (such as specification of a nonexistent function code) with the contents of the command message other than transmission error, the slave creates and replies with an error response message without following the command.

The composition of response message at error detection is as shown in Fig. 5-2 the value used for function code field is function code of command message plus 80_H.

Table 5-1 gives error codes.

Station No. (1 byte)
Function code + 80 _H (1 byte)
Error code (1 byte)
Error check code (CRC-16) (2 bytes)

Fig. 5-2 Response message at error detection

Table 5-1 Error Code

Error code	Contents	Explanation
01 _H	Illegal function code	Non-actual function code is designated. Check for the function code.
02 _H	Faulty address for coil or register	A relative address of a coil number or register number to which the designated function code can not be used.
03 _H	Illegal data value	Because the designation of number is too much, the area where register numbers do not exist is designated.

(3) No response

Under any of the following items, the slave station takes no action of the command message and sends back no response.

- A station number transmitted in the command message differs from the station number specified to the slave station.
- An error check code is not matched, or a transmission error (parity error, etc.) is detected.
- The time interval between the composition data of the message becomes longer than the time corresponding to 24 bits. (Refer to Section 5.6 Transmission Control Procedure)

5.4 Function Code

According to MODBUS protocol, register numbers are assigned by function codes. Each function code acts on specific register number.

This correspondence is shown in Table 5-2, and the message length by function is shown in Table 5-3.

Table 5-2 Correspondence between function codes and objective address

Function Code			Register No.	
No.	Function	Remedy	No.	Contents
03 _H	reading (continuance)	Holding register	4xxxx	Reading/writing Word data
04 _H	reading (continuance)	Input register	3xxxx	Reading Word data
06 _H	Writing	Holding register	4xxxx	Reading/writing Word data
10 _H	Writing (continuance)	Holding register	4xxxx	Reading/writing Word data

Table 5-3 Function code and message length

[UNIT: byte]

Function Code	Contents	Designated data	Command message		Response message	
			Mini.	Max.	Mini.	Max.
03 _H	Read word data	64 words	8	8	7	133
04 _H	Read word (Read only)	64 words	8	8	7	133
06 _H	Write word data	1 word	8	8	8	8
10 _H	Write continuous word data	64 words	11	137	8	8

5.5 Calculation of Error Check Code (CRC-16)

CRC-16 is the 2-byte (16-bits) error check code. From the top of the message (station No.) to the end of the data field are calculated.

The slave calculates the CRC of the received message and ignores the message if this value is not the same as the received CRC code.

The following shows the calculation procedure for CRC-16.

- (a) Store FFFFH into 16 bits register (CRC register)
- (b) Subject the 1st byte (8 bits) of transmit message and CRC register contents to an exclusive logical summation (XOR), and store the result into the CRC register.
- (c) Shift the CRC register contents 1 bit to the right. Store 0 at MSB.
- (d) If LSB before shifting is 0, do nothing.
If LSB before shifting is 1, subject it and A001H to XOR, and store the result into the CRC register.
- (e) Repeat the steps (c) and (d) 8 times (shift by 8 bits).
- (f) Execute steps (b) to (e) for the next byte of the transmit message.
Likewise, successively repeat the steps to each byte of the transmit message.
- (g) The CRC code that is retained is the value of CRC register that stands when the processing has ended for latest byte (latest data except error code) of the transmit message.
- (h) As error check code of the transmit message, store this CRC value in the order of lower 8 bits and upper 8 bits.

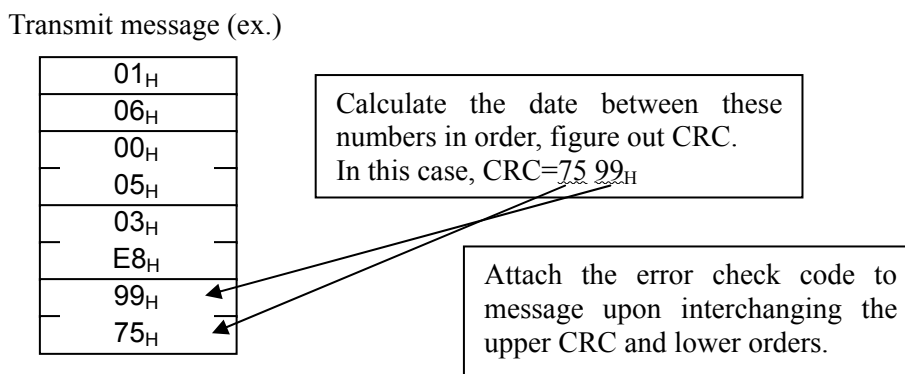

Fig. 5-3 Shows the flow of the CRC-16 calculation system.

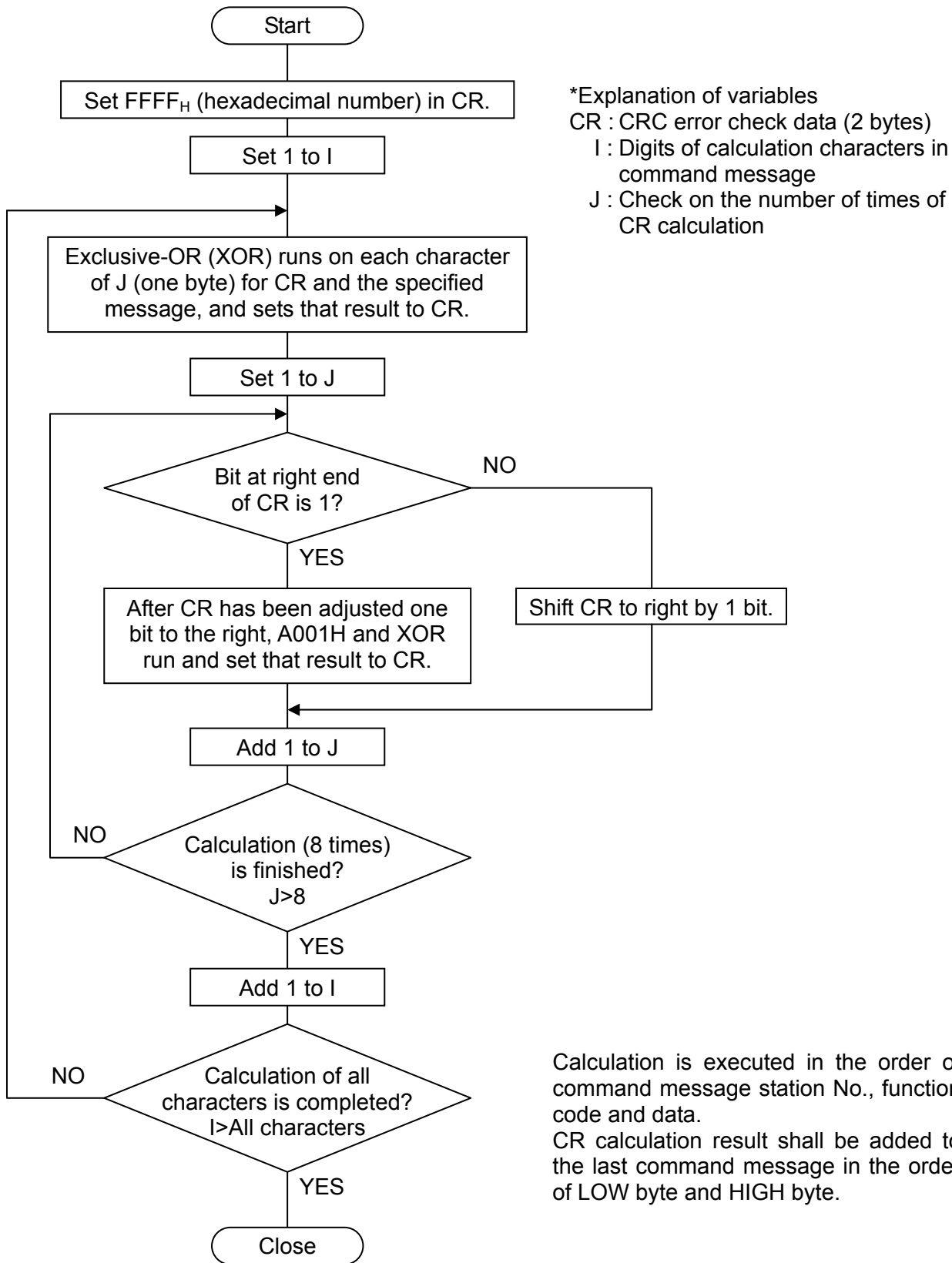

Fig. 5-4 Flow of CRC-16 calculation

5.6 Transmission Control Procedure

(1) Transmission procedure of master station

The master station must proceed to a communication upon conforming to the following items.

- (1-1) The command message, must be sent after an empty space of at least 48 bit time.
- (1-2) Interval between bytes of 1 command message is smaller than 24 bits time.
- (1-3) After sending a command message, for less than 24 bit time the master will enter receiving standby.
- (1-4) After receiving the response message, the next command message must be sent after at least 48 bit time. [Same as in (1-1)]
- (1-5) For safety reasons, create a framework where the master checks the response message, and if there is no response or an error occurs, retry at least three times.

Note) The definitions written above are for the minimum required value. For safety reasons, we recommend creating a master side program that keeps margins two to three times as large. Concretely, it is advised to arrange the program for 38400 bps with 5ms or more for vacant statues (1-1), and within 1ms for byte interval (1-2) and changeover from sending to receiving (1-3).

(2) Explanation

1) Frame detection

The status on the line of the communication system is one of the 2 below.

- (a) Vacant status (no data on line)
- (b) Communication status (data is existing)

The units connected on the circuit start in receiving state and monitor the circuit. When a blank state appears on the circuit for at least 24 bit time, the unit detects the end of the previous frame, and within the next 24 bit time, enters receiving standby. When data appears on the circuit, the unit begins receiving data, and once another blank state of at least 24 bit time is detected, that frame is ended. In other words, the data on the circuit from the first time that a 24 bit time blank state appears to the second time one appears is loaded as one frame (a bundle of data).

Therefore, one frame (command message) must be sent while following the rules below.

(1-1) The command message must be sent after an empty space of at least 48 bit time.

(1-2) Interval between bytes of 1 command message is smaller than 24 bits time.

2) Response of this instrument

After the PUM detects the frame (detects blank states at least 24 bit times long), that frame is used to send a command message. If the command message is destined to the own station, a response message is returned. Its processing time is 1 to 30 ms (The time may change depending on the contents of the command message.)

Therefore, one frame (command message) must be sent while following the rules below.

(1-3) After sending a command message, for less than 24 bit time the master will enter receiving standby.

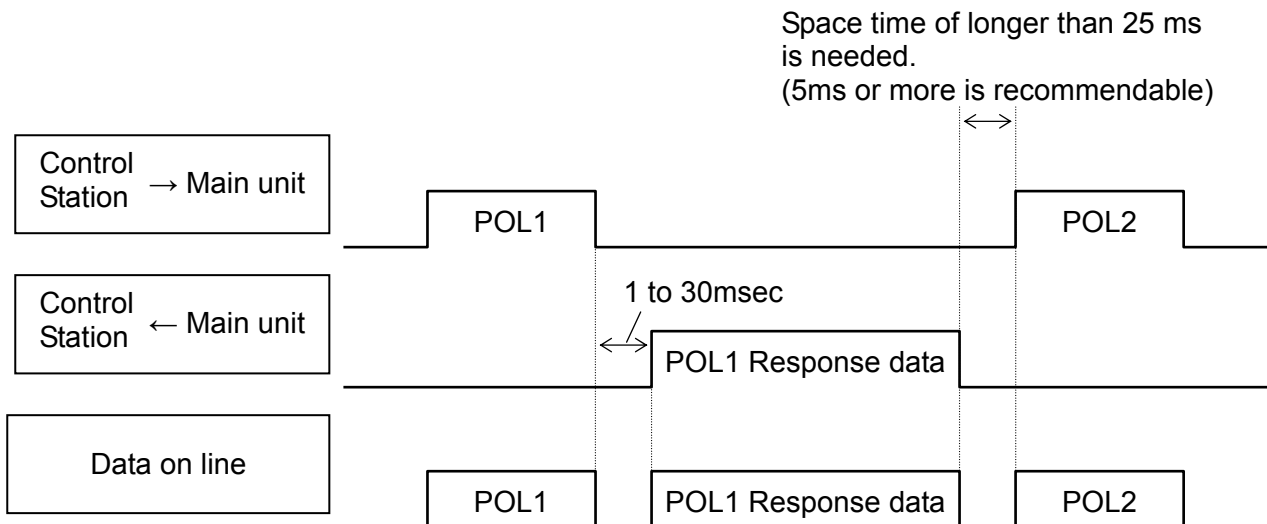

6. DETAILS OF MESSAGE (MODBUS)

6.1 Word data readout [Function code: 03_H]

Function code	Max. number of words to read in one message	Relative address	{Register No.	Contents
03 _H	64 words	0000 to 0081	40001 to 40082	Setting data

(1) Composition of Message

Command message composition (byte)

Station No.		} 1 to 60
Function code		
Readout start number (Relative address)	Upper	
	Lower	
Readout Word number	Upper	
	Lower	
CRC data	Upper	
	Lower	

Response message composition (byte)

Station No.		} Readout word number × 2
Function code		
Readout byte number		
Contents of the first word data	Upper	
	Lower	
Contents of the next word data	Upper	
	Lower	
~		
Contents of the last word data	Upper	
	Lower	
CRC data	Upper	
	Lower	

Arrangement of read-out word data

MSB	LSB
Upper byte of contents of the first word data	
Lower byte of contents of the first word data	
Upper byte of contents of the next word data	
Lower byte of contents of the next word data	
~	
Upper byte of contents of the last word data	
Lower byte of contents of the last word data	

(2) Explanation of Function

Word data of continuous word numbers from the read-out start No. can be read. Read-out word data are transmitted from the slave station in the order of upper and lower bytes.

6.2 Reading Read-Only Word Data [Function Code: 04_H]

Function code	Max. number of words to read in one message	Relative address	{Register No.	Contents
04 _H	64 words	0000 to 0081	30001 to 30079	Internal data
		1000 to 1049	31001 to 31044	Error history data
		2000 to 2049	32001 to 32044	Alarm history data
		3000 to 3049	33001 to 33044	Operation history data

(1) Composition of message

Command message composition (byte)

Station No.	
Function code	
Readout start number (Relative address)	Upper
	Lower
Readout Word number	Upper
	Lower
CRC data	Upper
	Lower

} 1 to 60

Response message composition (byte)

Station No.		Readout word number × 2
Function code		
Readout byte number		
Contents of the first word data	Upper	
	Lower	
Contents of the next word data	Upper	
	Lower	
~		
Contents of the last word data	Upper	
	Lower	
CRC data	Upper	
	Lower	

Arrangement of read-out word data

MSB	LSB
Upper byte of contents of the first word data	
Lower byte of contents of the first word data	
Upper byte of contents of the next word data	
Lower byte of contents of the next word data	
~	
Upper byte of contents of the last word data	
Lower byte of contents of the last word data	

(2) Description of functions

Word data of continuous word numbers from the read-out start No. can be read. Read-out word data are transmitted from the slave station in the order of upper and lower bytes.

6.3 Writing Word Data (unit of 1word) [function code: 06_H]

Function code	Max. number of words to read in one message	Relative address	{Register No.	Contents
06 _H	1 words	0000 to 0081	40001 to 40082	Setting data

(1) Composition of message

Command message composition (byte)

Station No.	
Function code	
Write in designation No. (Relative address)	Upper
	Lower
Write in word data	Upper
	Lower
CRC data	Upper
	Lower

Response message composition (byte)

Station No.	
Function code	
Write in designation No. (Relative address)	Upper
	Lower
Write in word data	Upper
	Lower
CRC data	Upper
	Lower

(2) Description of function

Designated word data is written in write-in designate No. The master sends the data to be written from the upper number of bytes to the lower number.

6.4 Writing Continuous Word Data [Function code: 10_H]

Function code	Max. number of words to read in one message	Relative address	{Register No.	Contents
10 _H	64 words	0000 to 0081	40001 to 40082	Setting data

(1) Composition of message

Command message composition (byte)

Station No.	
Function code	
Write in start No. (Relative address)	Upper
	Lower
Write in word number	Upper
	Lower
Write in byte number	
First write in word data	Upper
	Lower
Next write in word data	Upper
	Lower
Last write in word data	Upper
	Lower
CRC data	Upper
	Lower

} 1 to 60

} Write in word number × 2

Response message composition (byte)

Station No.	
Function code	
Write in start number (Relative address)	Upper
	Lower
Write in word number	Upper
	Lower
CRC data	Upper
	Lower

Arrangement of write in word data

MSB	LSB
Upper byte of contents of the first word data	
Lower byte of contents of the first word data	
Upper byte of contents of the next word data	
Lower byte of contents of the next word data	
Upper byte of contents of the last word data	
Lower byte of contents of the last word data	

(2) Description of functions

Word data of continuous word number is written from write-in start address. The master sends the data to be written from the upper number of bytes to the lower number.

7. ADDRESS MAP AND DATA FORMAT (MODBUS)

7.1 Data format

7.1.1 Transmission data format

The MODBUS protocol used in this instrument is RTU (Remote Terminal Unit) mode. Transmitted data is “numeric value” and not ASCII code.

7.1.2 Handling of decimal point position and measurement unit

When transmitted, the calibration concentration setting, alarm's high and low limits and measurement concentration data have no decimal point nor measurement unit. Calculate exact values of data upon point positioning as shown below. Refer to the contents of each “read out/ write in data”.

7.1.3 Handling at measurement data over-range

Even if the measurement data is at over-range, with “---” displayed on the screen, the measurement value at the time is transmitted.

7.2 Address map (MODBUS)

Word data [read-out/write-in]: Function code [03_H, 06_H, 10_H]

Relative address	Registration number	Data type	Memory contents	Read out /write in data	Default value
0	40001	WORD	Unit {Upper}	0: vol%	0
			Decimal point position of range {Lower}	0: <0.000> 1: <00.00>	1
1	40002	WORD	Range	0 to 9999 (When the decimal point position "00.00" is 0200 to 5000, when "0.000" is 2000 to 9999)	2500
2	40003	WORD	Unit {Upper}	0: vol%	0
			Decimal position of range {Lower}	0: <0.000> 1: <00.00>	1
3	40004	WORD	Range	0 to 9999 (When the decimal point position "00.00" is 0200 to 5000, when "0.000" is 2000 to 9999)	2500
4	40005	WORD	Max.value/Mini.value calculation time [time]	0 to 240	24
5	40006	WORD	Setting flag	2 bits: Inhabitation of all calibration (0: enable, 1: unenable)	0
6	40007	WORD	Year of automatic calibration start {Upper}	00 to 99	99
			Month of automatic calibration start {Lower}	1 to 12	1
7	40008	WORD	Date of automatic calibration start {Upper}	1 to 31	1
			Time of automatic calibration start {Lower}	0 to 23	0
8	40009	WORD	Minute of automatic calibration start {Upper}	0 to 59	0
			Unused	0	0
9	40010	WORD	Auto calibration cycle (Date) {Upper}	0 to 99	7
			Auto calibration cycle (Time) {Lower}	0 to 99	0
10	40011	DWORD	Calibration span gas concentration {Upper} (Range 1)	00010 to 50000 (1 digit = 0.001 vol%)	206000
11	40012		Calibration span gas concentration {Lower} (Range 1)		
12	40013	DWORD	Calibration span gas concentration {Upper} (Range 1)	00010 to 25000 (1 digit = 0.001 vol%)	20000
13	40014		Calibration zero gas concentration {Lower} (Range 1)		

Relative address	Registration number	Data type	Memory contents	Read out /write in data	Default value
14	40015	DWORD	Calibration span gas concentration {Upper} (Range 2)	00010 to 50000 (1 digit = 0.001 vol%)	206000
15	40016		Calibration span gas concentration {Lower} (Range 2)		
16	40017	DWORD	Calibration zero gas concentration {Upper} (Range 2)	00010 to 25000 (1 digit = 0.001 vol%)	20000
17	40018		Calibration zero gas concentration {Lower} (Range 2)		
18	40019	WORD	Year of automatic blow back start {Upper}	00 to 99	99
			Month of automatic blow back start {Lower}	1 to 12	1
19	40020	WORD	Date of automatic blow back start {Upper}	1 to 31	1
			Time of automatic blow back start {Lower}	0 to 23	0
20	40021	WORD	Minute of automatic blow back start {Upper}	0 to 59	0
			Unused	0	0
21	40022	WORD	Automatic blow cycle (time) {Upper}	0 to 99	24
			Automatic blow cycle (minute) {Lower}	0 to 99	0
22	40023	WORD	Blow time [second]	0 to 999	
23	40024	WORD	Unused		
24	40025	WORD	Unused		
25	40026	WORD	Unused		
26	40027	WORD	Digital input 1 Setting value	0: Unused 1: Blow down 2: Heater off 3: Inhabitation of calibration 4: Remote calibration 5: Remote AO hold 6: Maximum & Minimum calculation reset 7: Range selection	0
			Digital input 2 Setting value	Same as digital input 1 setting value	0
27	40028	WORD	Digital input 3 Setting value	Same as digital input 1 setting value	0
			Unused	0	0
28	40029	WORD	Alarm contact output setting value	0: Unused 1: Upper limit alarm 2: Lower limit alarm 3: Upper2 limit alarm 4: Lower2 limit alarm 5: Upper Lower limit alarm 6: Upper2/ Lower2 limit alarm	0

Relative address	Registrarion number	Data type	Memory contents	Read out /weite in data	Default value
29	40030	WORD	Error conditions of heater temperature [°C] {Upper}	0 to 100	70
			Hysteresis width of heater temperature error condition [%] {Lower}	0 to 20	1
30	40031	DWORD	O ₂ concentration alarm upper limit [vol%] {Upper} (Range 1)	1 to 550000 (1digit = 0.0001 vol%)	550000
31	40032		O ₂ concentration alarm upper limit [vol%] {Lower} (Range 1)		
32	40033	DWORD	O ₂ concentration alarm lower limit [vol%] {Upper} (Range 1)	1 to 550000 (1digit = 0.0001 vol%)	500000
33	40034		O ₂ concentration alarm lower limit [vol%] {Lower} (Range 1)		
34	40035	DWORD	O ₂ concentration alarm upper2 limit [vol%] {Upper} (Range 1)	1 to 550000 (1digit = 0.0001 vol%)	200
35	40036		O ₂ concentration alarm upper2 limit [vol%] {Lower} (Range 1)		
36	40037	DWORD	O ₂ concentration alarm lower2 limit [vol%] {Upper} (Range 1)	1 to 550000 (1digit = 0.0001 vol%)	100
37	40038		O ₂ concentration alarm lower2 limit [vol%] {Lower} (Range 1)		
38	40039	WORD	O ₂ hysteresis width of concentration alarm condition [%] (Range 1)	0 to 20	10
39	40040	DWORD	O ₂ concentration alarm upper limit value [vol%] {Upper} (Range 2)	1 to 550000 (1digit = 0.0001 vol%)	550000
40	40041		O ₂ concentration alarm upper limit value [vol%] {Lower} (Range 2)		
41	40042	DWORD	O ₂ concentration alarm lower limit[vol%]{Upper}(Range 2)	1 to 550000 (1digit = 0.0001 vol%)	500000
42	40043		O ₂ concentration alarm lower limit [vol%]{Lower}(Range 2)		
43	40044	DWORD	O ₂ concentration alarm upper2 limit value [vol%] {Upper} (Range 2)	1 to 550000 (1digit = 0.0001 vol%)	200
44	40045		O ₂ concentration alarm upper2 limit value [vol%] {Lower} (Range 2)		
45	40046	DWORD	O ₂ concentration alarm lower2 limit value [vol%] {Upper} (Range 2)	1 to 550000 (1digit = 0.0001 vol%)	100
46	40047		O ₂ concentration alarm lower limit alarm value [vol%] {Lower} (Range 2)		
47	40048	WORD	Hysteresis width of O ₂ concentration alarm condition [%] (Range 2)	0 to 20	10

Relative address	Registrarion number	Data type	Memory contents	Read out /weite in data	Default value
48	40049	WORD	AO Hold setting type [Upper]	1: Valid, 0: Invalid	0
			AO Hold selection value {Lower}	0: 0% 1: 100% 2: last time calculated value 3: User specified	0
49	40050	WORD	AO Hold setting value	0 to 100	0
50	40051	WORD	Measurement return time [Second]	0 to 300	10
51	40052	WORD	Factory default setting flag	8 bits: Key lock (0:Invalid, 1:Valid)	0
52	40053	WORD	LCD Automatic OFF time of the backlight [Minute]	0 to 99	10
53	40054	WORD	Warm-up operation monitoring time [Minute]	0 to 60	45
54	40055	WORD	Average time of movement [Seconds]	0 to 60	2
55	40056	WORD	Heater control system setting (Controlled temperature)	700 to 900	800
56	40057	WORD	Heater control system setting (cryogenic thermometry)	0 to 300	200
57	40058	WORD	Heater control system setting (cryogenic temperature)	0 to 60	0
58	40059	WORD	Unused	-	
59	40060	WORD	4mA (0V) Adjustment value (Analog output)	0 to 65535	5250
60	40061	WORD	20mA(1V) Adjustment value (Analog output)	0 to 65535	27000
61	40062	DWORD	Zero coefficient {Upper} (Range 1)	0 to 4294967295 (1digit = 0.001)	1000
62	40063		Zero coefficient {Lower} (Range 1)		
63	40064	DWORD	Span coefficient {Upper} (Range 1)	0 to 4294967295	0
64	40065		Span coefficient {Lower} (Range 1)		
65	40066	DWORD	Zero coefficient {Upper} (Range 2)	0 to 4294967295 (1digit = 0.001)	1000
66	40067		Zero coefficient {Lower} (Range 2)		
67	40068	DWORD	Span coefficient {Upper} (Range 2)	0 to 4294967295	0
68	40069		Span coefficient {Lower} (Range 2)		
69	40070	DWORD	AD1 adjustment value (Low) {Upper}	0 to 4294967295	7700
70	40071		AD1 adjustment value (Low) {Lower}		

Relative address	Registrarion number	Data type	Memory contents	Read out /weite in data	Default value
71	40072	DWORD	AD1 adjustment value (High) {Upper}	0 to 4294967295	25000
72	40073		AD1 adjustment value (High) {Lower}		
73	40074	DWORD	AD2 adjustment value (Low) {Upper}	0 to 4294967295	2000
74	40075		AD2 adjustment value (Low) {Lower}		
75	40076	DWORD	AD2 adjustment value (High) {Upper}	0 to 4294967295	32000
76	40077		AD2 adjustment value (High) {Lower}		
77	40078	DWORD	AD3 adjustment value (Low) {Upper}	0 to 4294967295	2000
78	40079		AD3 adjustment value (Low) {Lower}		
79	40080	DWORD	AD3 adjustment value (High) {Upper}	0 to 4294967295	32000
80	40081		AD3 adjustment value (High) {Lower}		
81	40082	DWORD	AD4 adjustment value (Low) {Upper}	0 to 4294967295	2000
82	40083		AD4 adjustment value (Low) {Lower}		
83	40084	DWORD	AD4 adjustment value (High) {Upper}	0 to 4294967295	32000
84	40085		AD4 adjustment value (High) {Lower}		
85	40086	WORD	Unused		
86	40087	WORD	Contact AB setting {Upper}	0 bit: Zero valve contact (DO) 1 bit: Span valve contact (DO) 2 bits: Blow down contact (DO) 3 bit: Output contact during maintenance (DO) 4 bits: Error contact (FAULT) (DO) 5 bits: Alarm contact (ALARM) (DO) (0:A 1:B)	0
			Contact AB setting {Lower}	0 bit: DI1 contact (DI) 1 bit: DI2 contact (DI) 2 bits: DI3 contact (DI) (0:A 1:B)	
87	40088	WORD	Waiting time of calibration [Seconds]	0 to 60	10
88	40089	WORD	PID control parameter: P	0 to 65535	20
89	40090	WORD	PID control parameter: I	0 to 65535	3000

Relative address	Registrarion number	Data type	Memory contents	Read out /weite in data	Default value
90	40091	WORD	PID control parameter: D	0 to 65535	600
91	40092	WORD	Unused		
92	40093	WORD	Unused	-	-
93	40094	WORD	Unused	-	-
94	40095	WORD	Unused		
95	40096	WORD	Unused		
96	40097	WORD	Station number {Upper} {Lower}is Unused	0 to 99	
97	40098	WORD	Unused		
98	40099	WORD	Combustion efficiency display function	0 to 199	70
99	40100	WORD	secure judgment time (Second)	0 to 600	420
100	40101	WORD	Monitoring time of calibration factor determination (Second)	0 to 600	32
101	40102	WORD	Range flag	0/1: Range 1/ Rnage2	0
102	40103	WORD	Calibration range of interlock flag	0/1: Interlock range/ range display	0

Read-Only Word Data: Function code [04_H]

Relative address	Register number (H)	Data type	Memory contents	Readout data
0	30001	DWORD	Oxygen concentration (%) after moving average {Upper}	0 to 0xFFFFFFFF (1 digit = 0.0001 vol%)
1	30002		Oxygen concentration (%) after moving average {Lower}	
2	30003	DWORD	mV corresponding value of Oxygen {Upper}	0 to 0xFFFFFFFF (1digit = 0.001 mV)
3	30004		mV corresponding value of Oxygen {Lower}	
4	30005	WORD	Heater temperature (°C)	0 to 0xFFFF (1digit = 0.1 °C)
5	30006	WORD	Combustion efficiency display function (%)	0 to 0xFFFF (1digit = 0.1 %)
6	30007	DWORD	Maximum value of Oxygen concentration {Upper}	0 to 0xFFFFFFFF (1digit = 0.0001 vol%)
7	30008		Maximum value of Oxygen concentration {Lower}	
8	30009	DWORD	Minimum value of Oxygen concentration {Upper}	0 to 0xFFFFFFFF (1digit = 0.0001 vol%)
9	30010		Minimum value of Oxygen concentration {Lower}	
10	30011	WORD	Second of corrent date {Upper}	0 to 59
			Minute of corrent date {Lower}	0 to 59
11	30012	WORD	Time of corrent date {Upper}	0 to 23
			Day of corrent date {Lower}	1:Sun, 2:Mon, 4:Tue, 8:Wed, 16:Thu, 32:Fri, 64:Sat
12	30013	WORD	Date of corrent date {Upper}	1 to 31
			Month of corrent date {Lower}	1 to 12
13	30014	WORD	Year of corrent date {Upper}	00 to 99
			Unused	0
14	30015	WORD	Year of starting date for next time auto calibration {Upper}	00 to 99
			Month of starting date for next time auto calibration {Lower}	1 to 12
15	30016	WORD	Date of starting date for next time auto calibration {Upper}	1 to 31
			Time of starting date for next time auto calibration {Lower}	0 to 23
16	30017	WORD	Minute of starting date for next time auto calibration {Upper}	0 to 59
			Unused	0
17	30018	WORD	Year of starting date for next time auto blowdown {Upper}	00 to 99
			Month of starting date for next time auto blowdown {Lower}	1 to 12

Relative address	Register number (H)	Data type	Memory contents	Readout data
18	30019	WORD	Day of starting date for next time auto blowdown {Upper}	1 to 31
			Time of starting date for next time auto blowdown {Lower}	0 to 23
19	30020	WORD	Minute of starting date for next time auto blowdown {Upper}	0 to 59
			Unused	0
20	30021	WORD	Unused	-
21	30022	WORD	Unused	-
22	30023	WORD	Unused	-
23	30024	WORD	Event parameter {Upper}	0 bit: Zero input adjustment 1 bit: Span input adjustment 2 bits: input adjustment of zero temperature 3 bits: input adjustment of temperature span 4 bits: input adjustment auxiliary zero 5 bits: input adjustment of auxiliary span 6 bits: 4 mA adjustment flag 7 bits: 20 mA adjustment flag (0: None, 1: Active)
			Event parameter {Lower}	0 bit: Manual span calibration 1 bit: Auto span calibration 2 bits: Auto zero calibration 3 bits: Auto zero calibration 4 bits: Manual batch calibration 5 bits: Auto calibration start 6 bits: Auto blowdown 7 bits: Manual blowdown (0: None, 1: Active)
24	30025	WORD	Event parameter {Upper}	0 bit: Manual sensor diagnosis 1 bit: Sensor diagnosis (during calibration) 3 bits: Manual reactivated sensor 4 bits: Unused 6 bits: Unused 7 bits: High-temperature sensor (0: None, 1: Active)

Relative address	Register number (H)	Data type	Memory contents	Readout data
24	30025	WORD	Event parameter {Lower}	0 bit :Write calibration factor to EEPROM 1 bit :Span valve switching (1: Open, 0: Close) 2 bits:Zero valve switching (1: Open, 0: Close) 4 bits:Calculation reset 5 bits:Monitoring flag for backlight off time 6 bits:Keylock status 7 bits:Inhibition of calibration status (0: None 1: Active)
25	30026	WORD	Event parameter {Upper}	0 bit:Heater control 1 bit:Hold signal 2 bits:Warm up operation HOLD 4 bits:Key input for backlight off 5 bits: Unused 6 bits:Auto blow start 7 bits:Manual batch calibration (0: None 1: Active)
			Event parameter {Lower}	0 bit: During remote heater OFF 1 bit: Holding remote analog output 2 bits: Unused 3 bits: Unused 4 bits: Unused 5 bits: Low temperature warm-up operation 6 bits: Remote calibration 7 bits: Remote blow (0: None, 1: Active)

Relative address	Register number (H)	Data type	Memory contents	Readout data
26	30027	WORD	Parameter for alarm control {Upper}	0 bit: Disconnection of sensor 1 bit: Disconnection of thermocouple line for temperature control 2 bits: Disconnection of thermocouple for combustion management 3 bits: Unused 4 bits: Sensor abnormal 5 bits: O ₂ scale over (0:Normal, 1: Abnormal)
			Parameter for alarm control {Lower}	0 bit: Secured error of span gas calibration 1 bit: Span calibration error 2 bits: Secured error of zero gas calibration 3 bits: Zero calibration error 4 bits: Calibration error 6 bits: Timeout of high-temperature setting of heater (0: Normal, 1: Abnormal)
27	30028	WORD	Parameter for alarm control {Upper}	0 bit: Warm-up operation error 1 bit: Heater temperature error 2 bits: A/D saturated error 5 bits: O ₂ error (0: Normal 1:Abnormal)
			Parameter for alarm control {Lower}	0 bit: O ₂ upper2 limit value alarm 1 bit: O ₂ upper limit value alarm 2 bits: O ₂ lower limit value alarm 3 bits: O ₂ lower2 limit value alarm 4 bits: Alarm information 5 bits: Fault information 7 bits: Rich mode (0: Normal, 1: Abnormal)
28	30029	WORD	Digital contact input start {Upper} Remote calibration	0: Unexecute remote calibration 1: Execute remote calibration
			Digital contact input calibration {Lower} Inhabitation of	0: Calibration valid 1: Inhibition of calibration

Relative address	Register number (H)	Data type	Memory contents	Readout data
29	30030	WORD	Digital contact input Blow down {Upper}	0: Unexecute remote blowdown 1: Execute remote blow down
			Digital contact input Calculation reset {Lower}	0: Unexecute calculation reset 1: Execute calculation reset
30	30031	WORD	Digital contact input (1) Status {Upper}	0: Digital input 1 is ON 1: Digital input 1 is OFF
			Digital contact input (2) Status {Lower}	0: Digital input 2 is ON 1: Digital input 2 is OFF
31	30032	WORD	Digital contact input (3) Status {Upper}	0: Digital input 3 is ON 1: Digital input 3 is OFF
			Spare	-
32	30033	DWORD	110% of Input value of AO {Upper}	0 to 0xFFFFFFFF
33	30034		110% of Input value of AO {Lower}	
34	30035	DWORD	AD1 (O ₂ concentration) {Upper}	0 to 0xFFFFFFFF
35	30036		AD1 (O ₂ concentration) {Lower}	
36	30037	DWORD	AD2 (Heater temperature control) {Upper}	0 to 0xFFFFFFFF
37	30038		AD2 (Heater temperature control) {Lower}	
38	30039	DWORD	AD3 (combustion control) {Upper}	0 to 0xFFFFFFFF
39	30040		AD3 (combustion control) {Lower}	
40	30041	DWORD	AD4 (Thermocouple ambient temperature) {Upper}	0 to 0xFFFFFFFF
41	30042		AD4 (Thermocouple ambient temperature) {Lower}	
42	30043	DWORD	Oxygen concentration (%)mv -> % after conversion {Upper}	0 to 0xFFFFFFFF (1 digit = 0.0001 vol%)
43	30044		Oxygen concentration (%)mv -> % after conversion {Lower}	
44	30045	WORD	Oxygen concentration (%) for analog out	0 to 0xFFFF
45	30046	DWORD	Sensor temperature (counter value) {Upper}	0 to 0xFFFFFFFF
46	30047		Sensor temperature (counter value) {Lower}	
47	30048	DWORD	mV conversion value of heater temperature {Upper}	0 to 0xFFFFFFFF (1 digit = 0.001 mv)
48	30049		mV conversion value of heater temperature {Lower}	
49	30050	DWORD	mV conversion value of heater temperature {Upper}	0 to 0xFFFFFFFF (1 digit = 0.001 mv)
50	30051		Average heater temperature mV {Lower}	
51	30052	WORD	Heater temperature (°C) (After temperature compensation, after Linearization)	0 to 0xFFFF (1 digit = 1 °C)

Relative address	Register number (H)	Data type	Memory contents	Readout data
52	30053	DWORD	mV conversion value of auxiliary input temperature {Upper}	0 to 0xFFFFFFFF (1 digit = 0.001 mv)
53	30054		mV conversion value of auxiliary input temperature {Lower}	
54	30055	DWORD	Average of mV combustion control {Upper}	0 to 0xFFFFFFFF (1 digit = 0.001 mv)
55	30056		Average of mV combustion control {Lower}	
56	30057	WORD	Combustion efficiency temperature	0 to 0xFFFF (1 digit = 0.1 °C)
57	30058	DWORD	Thermocouple (RCJ) (AD value) {Upper}	0 to 0xFFFFFFFF
58	30059		Thermocouple (RCJ) (AD value) {Lower}	
59	30060	DWORD	Average value of thermocouple (RCJ) {Upper}	0 to 0xFFFFFFFF
60	30061		Average value of thermocouple (RCJ) {Lower}	
61	30062	DWORD	Heater temperature input zero {Upper}	0 to 0xFFFFFFFF
62	30063		Heater temperature input zero {Lower}	
63	30064	DWORD	Heater temperature input span {Upper}	0 to 0xFFFFFFFF
64	30065		Heater temperature input span {Lower}	
65	30066	WORD	PWM oncounter	0 to 50
66	30067	DWORD	Deviation of heater temperature {Upper}	0 to 0xFFFFFFFF (1 digit = 0.0001 °C)
67	30068		Deviation of heater temperature {Lower}	
68	30069	DWORD	Previous deviation of heater temperature {Upper}	0 to 0xFFFFFFFF (1 digit = 0.0001 °C)
69	30070		Previous deviation of heater temperature {Lower}	
70	30071	DWORD	Last deviation but one of heater temperature {Upper}	0 to 0xFFFFFFFF (1 digit = 0.0001 °C)
71	30072		Last deviation but one of heater temperature {Lower}	
72	30073	DWORD	Manipulating value (%) {Upper}	0 to 10000
73	30074		Manipulating value (%) {Lower}	
74	30075	DWORD	MAX MIN calculated time (countdown) {Upper}	0 to 0xFFFFFFFF
75	30076		MAX MIN calculated time (countdown) {Lower}	

Read-Only Word Data (Function Code: 04_H)

Information of error history

Relative address	Register number (H)	Data type	Memory contents	Readout data	Default value
1000	31001	WORD	Stored number of error history {Upper}	0 to 12	0
			Next storage pointer {Lower}	0 to 11	0
1001	31002	WORD	Data stored of head pointer (Latest) {Upper}	0 to 11	0
			Data stored of end pointer (Oldest) {Lower}	0 to 11	0
1002	31003	WORD	Error code of data storage position 0 {Upper}	0 to 255	0
			Error code of data storage position 1 {Lower}	0 to 255	0
~	~	~	~	~	~
1007	31008	WORD	Error code of data storage position 10 {Upper}	0 to 255	0
			Error code of data storage position 11 {Lower}	0 to 255	0
1008	31009	WORD	Year of data storage position 0 at error generation date {Upper}	00 to 99	0
			Month of data storage position 0 at error generation date {Lower}	1 to 12	1
1009	31010	WORD	Day of data storage position 0 at error generation date {Upper}	1 to 31	1
			Time of data storage position 0 at error generation date {Lower}	0 to 23	0
1010	31011	WORD	Minute of data storage position 0 at error generation date {Upper}	0 to 59	0
			Second of data storage position 0 at error generation date {Lower}	0 to 99	0
~	~	~	~	~	~
1041	31042	WORD	Year of data storage position 11 at error generation date {Upper}	00 to 99	0
			Month of data storage position 11 at error generation date {Lower}	1 to 12	1
1042	31043	WORD	Day of data storage position 11 at error generation date {Upper}	1 to 31	1
			Year of data storage position 11 at error generation date {Lower}	0 to 23	0
1043	31044	WORD	Minute of data storage position 11 at error generation date {Upper}	0 to 59	0
			Second of data storage position 11 at error generation date {Lower}	0 to 99	0

Read-Only Word Data (Function Code: 04_H)

Information of alarm history

Relative address	Register number (H)	Data type	Memory contents	Readout data	Default value
2000	32001	WORD	Stored number of alarm history {Upper}	0 to 12	0
			Next storage pointer {Lower}	0 to 11	0
2001	32002	WORD	Data stored of end pointer (Latest) {Upper}	0 to 11	0
			Data stored of head pointer (Oldest) {Lower}	0 to 11	0
2002	32003	WORD	Error code of data storage position 0 {Upper}	0 to 255	0
			Error code of data storage position 1 {Lower}	0 to 255	0
~	~	~	~	~	~
2007	32008	WORD	Error code of data storage position 10 {Upper}	0 to 255	0
			Error code of data storage position 11 {Lower}	0 to 255	0
2008	32009	WORD	Year of data storage position 0 at alarm generation date {Upper}	00 to 99	0
			Month of data storage position 0 at alarm generation date {Lower}	1 to 12	1
2009	32010	WORD	Day of data storage position 0 at alarm generation date {Upper}	1 to 31	1
			Time of data storage position 0 at alarm generation date {Lower}	0 to 23	0
2010	32011	WORD	Minute of data storage position 0 at alarm generation date {Upper}	0 to 59	0
			Second of data storage position 0 at alarm generation date {Lower}	0 to 99	0
~	~	~	~	~	~
2041	32042	WORD	Year of data storage position 11 at alarm generation date {Upper}	00 to 99	0
			Month of data storage position 11 at alarm generation date {Lower}	1 to 12	1
2042	32043	WORD	Day of data storage position 11 at alarm generation date {Upper}	1 to 31	1
			Time of data storage position 11 at alarm generation date {Lower}	0 to 23	0
2043	32044	WORD	Minute of data storage position 11 at alarm generation date {Upper}	0 to 59	0
			Second of data storage position 11 at alarm generation date {Lower}	0 to 99	0

8. HART COMMUNICATION

Communication with HART-enabled field devices is available by installing the configuration data called DD (device description) on the HART master or the HART communicator.

DD is to be prepared by customer or to be downloaded from our website.

8.1 HART communicator menu trees

8.1.1 Menu tree 1 (generic)

Example of HART communicator (Meriam MFC5150)

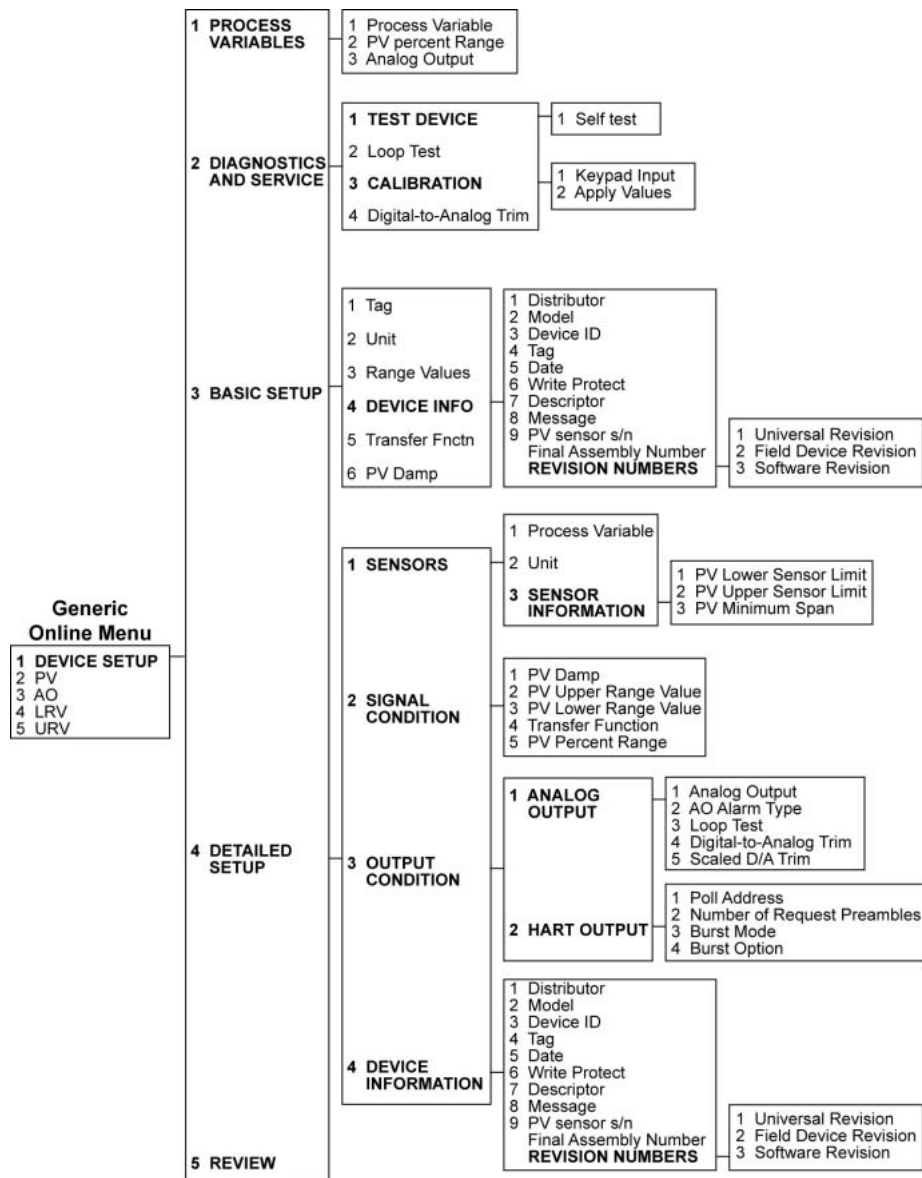

8.1.2 Menu tree 2 (specific to ZKM)

Example of HART communicator (Merriam MFC5150)

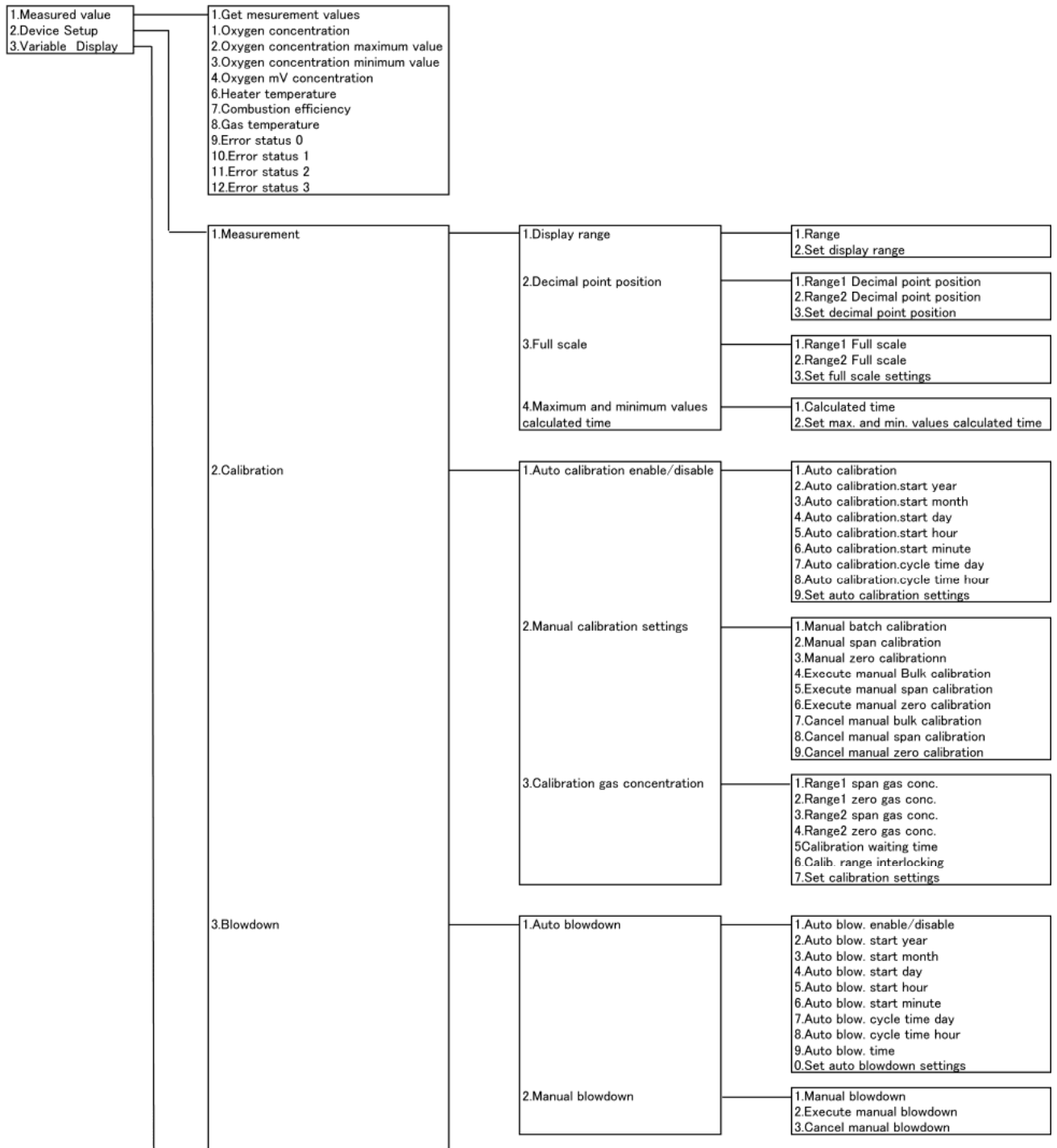

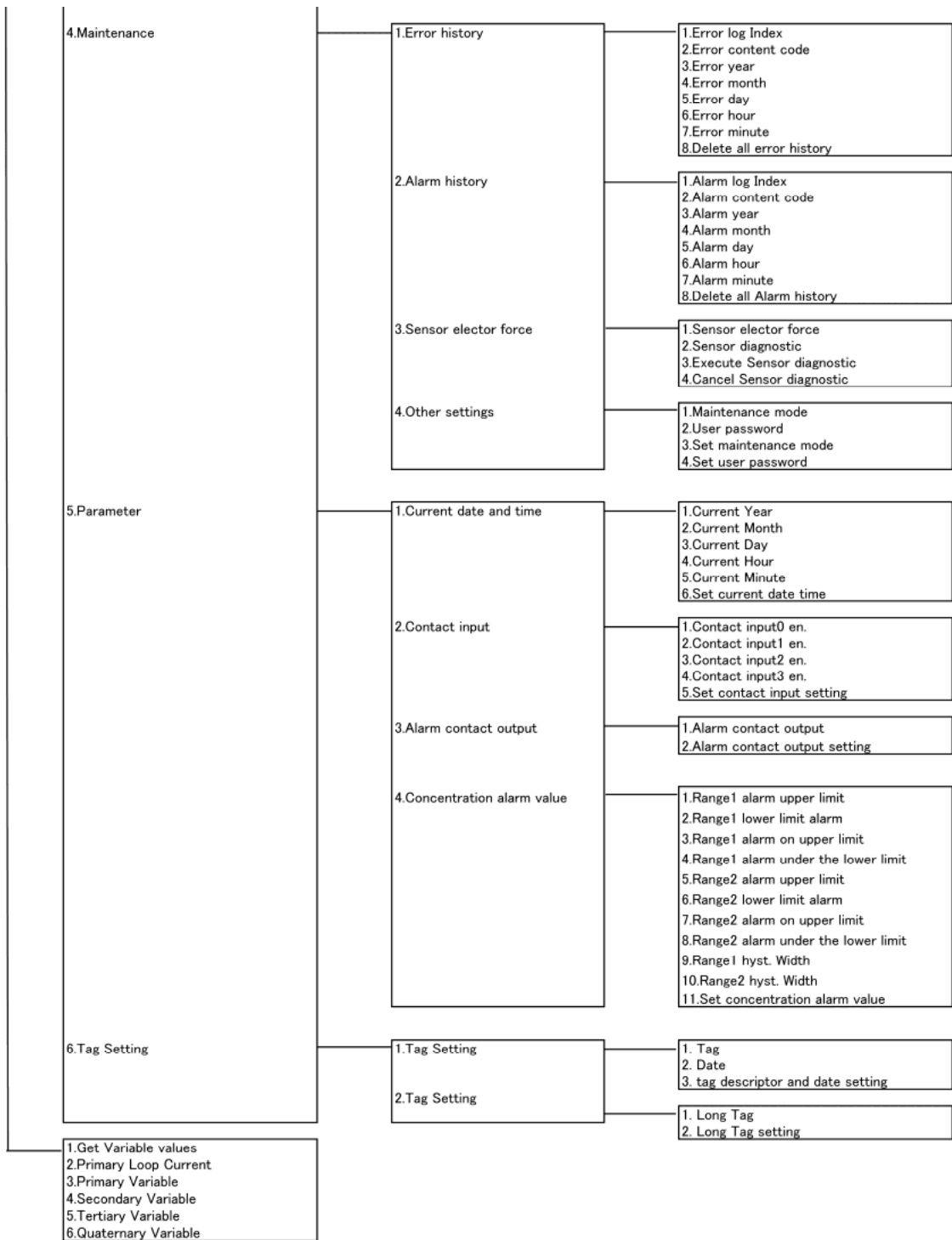

 Fuji Electric Co., Ltd.

Global Sales Section

Instrumentation & Sensors Planning Dept.

1, Fuji-machi, Hino-city, Tokyo 191-8502, Japan

<http://www.fujielectric.com>

Phone: +81-42-514-8930 Fax: +81-42-583-8275

<http://www.fujielectric.com/products/instruments/>
