



Programming Guide

VLT[®] HVAC Drive FC 102



Contents

1 Introduction	4
1.1 Definitions	6
1.1.1 Frequency Converter	6
1.1.2 Input	6
1.1.3 Motor	6
1.1.4 References	7
1.1.5 Miscellaneous	7
2 How to Programme	10
2.1 Local Control Panel	10
2.1.1 How to Operate Graphical LCP (GLCP)	10
2.1.2 How to Operate Numeric LCP (NLCP)	14
2.1.3 Quick Transfer of Parameter Settings between Multiple Frequency Converters	16
2.1.4 Parameter Set-Up	16
2.1.5 Quick Menu Mode	16
2.1.6 Function Set-ups	18
2.1.7 Main Menu Mode	21
2.1.8 Parameter Selection	22
2.1.9 Changing Data	22
2.1.10 Changing a Text Value	22
2.1.11 Changing a Group of Numeric Data Values	22
2.1.12 Value, Step-by-step	23
2.1.13 Read out and Programming of Indexed Parameters	23
2.1.14 Initialisation to Default Settings	23
3 Parameter Descriptions	24
3.1 Parameter Selection	24
3.2 Parameters: 0-** Operation and Display	25
3.3 Parameters: 1-** Load and Motor	37
3.4 Parameters: 2-** Main Menu - Brakes	54
3.5 Parameters: 3-** Main Menu - Reference/Ramps	58
3.6 Parameters: 4-** Main Menu - Limits/Warnings	65
3.7 Parameters: 5-** Main Menu - Digital In/Out	69
3.8 Parameters: 6-** Main Menu - Analog In/Out	82
3.9 Parameters: 8-** Main Menu - Communications and Options	89
3.10 Parameters: 9-** Main Menu - PROFIBUS	96
3.11 Parameters: 10-** Main Menu - CAN Fieldbus	102
3.12 Parameters: 11-** Main Menu - LonWorks	105
3.13 Parameters: 13-** Main Menu - Smart Logic	106
3.14 Parameters: 14-** Main Menu - Special Functions	118

3.15 Parameters: 15-** Main Menu - Drive Information	124
3.16 Parameters: 16-** Main Menu - Data Readouts	130
3.17 Parameters: 18-** Main Menu - Data Readouts 2	137
3.18 Parameters: 20-** Main Menu - FC Closed Loop	139
3.19 Parameters: 21-** Main Menu - Extended Closed Loop	151
3.20 Parameters: 22-** Application Functions	159
3.21 Parameters: 23-** Time-based Functions	173
3.22 Parameters: 24-** Application Functions 2	184
3.23 Parameters: 25-** Cascade Controller	190
3.24 Parameters: 26-** Analog I/O Option MCB 109	200
3.25 Parameters: 30-** Special Features	208
4 Troubleshooting	209
4.1 Troubleshooting	209
4.1.1 Alarm Words	213
4.1.2 Warning Words	214
4.1.3 Extended Status Words	215
5 Parameter Lists	223
5.1 Parameter Options	223
5.1.1 Default Settings	223
5.1.2 0-** Operation and Display	224
5.1.3 1-** Load / Motor	225
5.1.4 2-** Brakes	226
5.1.5 3-** Reference / Ramps	227
5.1.6 4-** Limits / Warnings	227
5.1.7 5-** Digital In / Out	228
5.1.8 6-** Analog In / Out	229
5.1.9 8-** Communication and Options	230
5.1.10 9-** Profibus	231
5.1.11 10-** CAN Fieldbus	232
5.1.12 11-** LonWorks	233
5.1.13 13-** Smart Logic Controller	233
5.1.14 14-** Special Functions	233
5.1.15 15-** Drive Information	234
5.1.16 16-** Data Readouts	235
5.1.17 18-** Info & Readouts	237
5.1.18 20-** FC Closed Loop	237
5.1.19 21-** Ext. Closed Loop	238
5.1.20 22-** Application Functions	240
5.1.21 23-** Time Based Functions	241

5.1.22 24-** Application Functions 2	242
5.1.24 26-** Analog I / O Option MCB 109	243
5.1.25 30-** Special Features	244
Index	245

1 Introduction

VLT® HVAC Drive
FC 102 Series



This guide can be used with all
VLT® HVAC Drive frequency
converters with software version
4.x.
The actual software version
number can be read from
parameter 15-43 Software Version.

Table 1.1 Software Version

This publication contains information proprietary to Danfoss. By accepting and using this manual, the user agrees that the information contained herein is used solely for operating equipment from Danfoss, or equipment from other vendors if such equipment is intended for communication with Danfoss equipment over a serial communication link. This publication is protected under the Copyright laws of Denmark and most other countries.

Danfoss does not warrant that a software program produced according to the guidelines provided in this manual functions properly in every physical, hardware, or software environment.

Although Danfoss has tested and reviewed the documentation within this manual, Danfoss makes no warranty or representation, neither expressed nor implied, with respect to this documentation, including its quality, performance, or fitness for a particular purpose.

In no event shall Danfoss be liable for direct, indirect, special, incidental, or consequential damages arising out of the use, or the inability to use information contained in this manual, even if advised of the possibility of such damages. In particular, Danfoss is not responsible for any costs, including but not limited to those incurred as a result of lost profits or revenue, loss or damage of equipment, loss of computer programs, loss of data, the costs to substitute these, or any claims by third parties.

Danfoss reserves the right to revise this publication at any time and to make changes to its contents without prior notice or any obligation to notify former or present users of such revisions or changes.

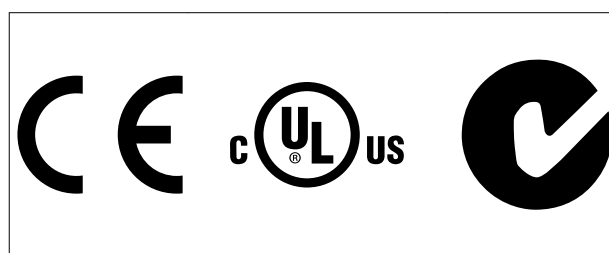

The following symbols are used in this manual.

▲WARNING

Indicates a potentially hazardous situation which could result in death or serious injury.

▲CAUTION

Indicates a potentially hazardous situation which could result in minor or moderate injury. It may also be used to alert against unsafe practices.

NOTICE

Indicates important information, including situations that may result in damage to equipment or property.

60° AVM	60° asynchronous vector modulation
A	Ampere/AMP
AC	Alternating current
AD	Air discharge
AEO	Automatic energy optimisation
AI	Analog input
AMA	Automatic motor adaptation
AWG	American wire gauge
°C	Degrees celsius
CD	Constant discharge
CDM	Complete drive module: the frequency converter, its feeding section and its auxiliaries
CM	Common mode
CT	Constant torque
DC	Direct current
DI	Digital input
DM	Differential mode
D-TYPE	Drive dependent
EMC	Electromagnetic compatibility
EMF	Electromotive force
ETR	Electronic thermal relay

f_{JOG}	Motor frequency when jog function is activated.
f_M	Motor frequency
f_{MAX}	Maximum output frequency, the frequency converter applies on its output.
f_{MIN}	Minimum motor frequency from the frequency converter
$f_{M,N}$	Nominal motor frequency
FC	Frequency converter
g	Gramme
Hiperface®	Hiperface® is a registered trademark by Stegmann
HO	High overload
hp	Horse power
HTL	HTL encoder (10–30 V) pulses - High-voltage transistor logic
Hz	Hertz
I_{INV}	Rated inverter output current
I_{LIM}	Current limit
$I_{M,N}$	Nominal motor current
$I_{VLT,MAX}$	Maximum output current
$I_{VLT,N}$	Rated output current supplied by the frequency converter
kHz	Kilohertz
LCP	Local control panel
lsb	Least significant bit
m	Meter
mA	Milliamper
MCM	Mille circular mil
MCT	Motion control tool
mH	Inductance in milli Henry
min	Minute
mm	Millimeter
ms	Millisecond
msb	Most significant bit
η_{VLT}	Efficiency of the frequency converter defined as ratio between power output and power input.
nF	Capacitance in nano Farad
NLCP	Numerical local control panel
Nm	Newton meter
NO	Normal overload
n_s	Synchronous motor speed
Online/Offline Parameters	Changes to online parameters are activated immediately after the data value is changed.
$P_{br,cont.}$	Rated power of the brake resistor (average power during continuous braking).
PCB	Printed circuit board
PCD	Process data
PDS	Power drive system: a CDM and a motor
PELV	Protective extra low voltage
P_m	Frequency converter nominal output power as high overload (HO).
$P_{M,N}$	Nominal motor power

PM motor	Permanent magnet motor
Process PID	PID (Proportional Integrated Differential) regulator that maintains the desired speed, pressure, temperature, and so on.
$R_{br,nom}$	Nominal resistor value that ensures a brake power on motor shaft of 150/160% for 1 minute
RCD	Residual current device
Regen	Regenerative terminals
R_{min}	Minimum permissible brake resistor value by frequency converter
RMS	Root mean square
RPM	Revolutions per minute
R_{rec}	Recommended brake resistor resistance of Danfoss brake resistors
s	Second
SFAVM	Stator flux-oriented asynchronous vector modulation
STW	Status word
SMPS	Switch mode power supply
THD	Total harmonic distortion
T_{LIM}	Torque limit
TTL	TTL encoder (5 V) pulses - transistor transistor logic
$U_{M,N}$	Nominal motor voltage
V	Volts
VT	Variable torque
VVC+	Voltage vector control plus

Table 1.2 Abbreviations

Conventions

Numbered lists indicate procedures.

Bullet lists indicate other information and description of illustrations.

Italicised text indicates:

- Cross reference
- Link
- Footnote
- Parameter name, parameter group name, parameter option

All dimensions are in mm (inch).

* indicates a default setting of a parameter.

- *VLT® HVAC Drive FC 102 Operating Instructions* provides information on mechanical and electrical installation of the frequency converter.
- *VLT® HVAC Drive FC 102 Design Guide* holds all technical information about the frequency converter, customer design, and applications.
- *VLT® HVAC Drive FC 102 Programming Guide* provides information on how to programme and includes complete parameter descriptions.
- *Application Note, Temperature Derating Guide.*

- MCT 10 Set-up Software Operating Instructions enables the user to configure the frequency converter from a Windows™-based PC environment.
- Danfoss VLT® Energy Box software at www.danfoss.com/BusinessAreas/DrivesSolutions, then select PC Software Download.
- VLT® HVAC Drive BACnet, Operating Instructions.
- VLT® HVAC Drive Metasys, Operating Instructions.
- VLT® HVAC Drive FLN, Operating Instructions.

Danfoss technical literature is available in print from local Danfoss Sales Offices, or as electronic copies at: www.vlt-drives.danfoss.com/Products/Detail/Technical-Documents---contextless/

1.1 Definitions

1.1.1 Frequency Converter

I_{VLT, MAX}

Maximum output current.

I_{VLT, N}

Rated output current supplied by the frequency converter.

U_{VLT, MAX}

Maximum output voltage.

1.1.2 Input

Control command

Start and stop the connected motor with LCP and digital inputs.

Functions are divided into 2 groups.

Functions in group 1 have higher priority than functions in group 2.

Group 1	Reset, coast stop, reset and coast stop, quick stop, DC brake, stop, the [OFF] key.
Group 2	Start, pulse start, reversing, start reversing, jog, freeze output.

Table 1.3 Function Groups

1.1.3 Motor

Motor running

Torque generated on output shaft and speed from 0 RPM to maximum speed on motor.

f_{JOG}

Motor frequency when the jog function is activated (via digital terminals).

f_M

Motor frequency.

f_{MAX}

Maximum motor frequency.

f_{MIN}

Minimum motor frequency.

f_{M,N}

Rated motor frequency (nameplate data).

I_M

Motor current (actual).

I_{M,N}

Rated motor current (nameplate data).

n_{M,N}

Nominal motor speed (nameplate data).

n_s

Synchronous motor speed

$$n_s = \frac{2 \times \text{par. } 1 - 23 \times 60 \text{ s}}{\text{par. } 1 - 39}$$

n_{slip}

Motor slip.

P_{M,N}

Rated motor power (nameplate data in kW or hp).

T_{M,N}

Rated torque (motor).

U_M

Instantaneous motor voltage.

U_{M,N}

Rated motor voltage (nameplate data).

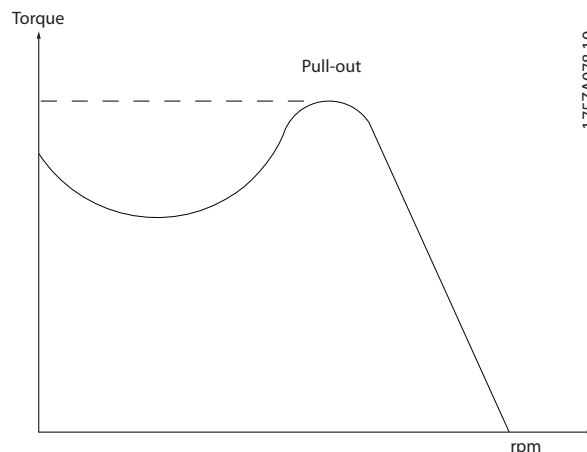

Illustration 1.1 Break-away Torque

Break-away torque

η_{VLT}

The efficiency of the frequency converter is defined as the ratio between the power output and the power input.

Start-disable command

A stop command belonging to Group 1 control commands - see Table 1.3.

Stop command

A stop command belonging to Group 1 control commands - see Table 1.3.

1.1.4 References

Analog reference

A signal transmitted to the analog inputs 53 or 54 (voltage or current).

Binary reference

A signal transmitted to the serial communication port.

Preset reference

A defined preset reference to be set from -100% to +100% of the reference range. Selection of 8 preset references via the digital terminals.

Pulse reference

A pulse frequency signal transmitted to the digital inputs (terminal 29 or 33).

Ref_{MAX}

Determines the relationship between the reference input at 100% full scale value (typically 10 V, 20 mA) and the resulting reference. The maximum reference value is set in *parameter 3-03 Maximum Reference*.

Ref_{MIN}

Determines the relationship between the reference input at 0% value (typically 0 V, 0 mA, 4 mA) and the resulting reference. The minimum reference value is set in *3-02 Minimum Reference*.

1.1.5 Miscellaneous

Analog inputs

The analog inputs are used for controlling various functions of the frequency converter.

There are 2 types of analog inputs:

Current input, 0–20 mA and 4–20 mA

Voltage input, -10 to +10 V DC.

Analog outputs

The analog outputs can supply a signal of 0–20 mA, 4–20 mA.

Automatic motor adaptation, AMA

AMA algorithm determines the electrical parameters for the connected motor at standstill.

Brake resistor

The brake resistor is a module capable of absorbing the brake power generated in regenerative braking. This regenerative brake power increases the DC-link voltage and a brake chopper ensures that the power is transmitted to the brake resistor.

CT characteristics

Constant torque characteristics used for all applications such as conveyor belts, displacement pumps, and cranes.

Digital inputs

The digital inputs can be used for controlling various functions of the frequency converter.

Digital outputs

The frequency converter features 2 solid-state outputs that can supply a 24 V DC (maximum 40 mA) signal.

DSP

Digital signal processor.

ETR

Electronic thermal relay is a thermal load calculation based on present load and time. Its purpose is to estimate the motor temperature.

Hiperface®

Hiperface® is a registered trademark by Stegmann.

Initialising

If initialising is carried out (*14-22 Operation Mode*), the frequency converter returns to the default setting.

Intermittent duty cycle

An intermittent duty rating refers to a sequence of duty cycles. Each cycle consists of an on-load and an off-load period. The operation can be either periodic duty or non-periodic duty.

LCP

The local control panel makes up a complete interface for control and programming of the frequency converter. The control panel is detachable and can be installed up to 3 m from the frequency converter, that is, in a front panel with the installation kit option.

NLCP

Numerical local control panel interface for control and programming of the frequency converter. The display is numerical and the panel is used to display process values. The NLCP has no storage and copy functions.

lsb

Least significant bit.

msb

Most significant bit.

MCM

Short for mille circular mil, an American measuring unit for cable cross-section. 1 MCM = 0.5067 mm².

Online/offline parameters

Changes to online parameters are activated immediately after the data value is changed. Press [OK] to activate changes to off-line parameters.

Process PID

The PID control maintains the desired speed, pressure, temperature, and so on, by adjusting the output frequency to match the varying load.

PCD

Process control data

Power cycle

Switch off the mains until display (LCP) is dark – then turn power on again.

Pulse input/incremental encoder

An external, digital pulse transmitter used for feeding back information on motor speed. The encoder is used in applications where great accuracy in speed control is required.

RCD

Residual current device.

Set-up

Save parameter settings in 4 set-ups. Change between the 4 parameter set-ups and edit 1 set-up, while another set-up is active.

SFAVM

Switching pattern called stator flux-oriented asynchronous vector modulation (*14-00 Switching Pattern*).

Slip compensation

The frequency converter compensates for the motor slip by giving the frequency a supplement that follows the measured motor load keeping the motor speed almost constant.

SLC

The SLC (smart logic control) is a sequence of user-defined actions executed when the associated user-defined events are evaluated as true by the SLC. (Parameter group).

STW

Status word.

FC standard bus

Includes RS485 bus with FC protocol or MC protocol. See *8-30 Protocol*.

THD

Total harmonic distortion states the total contribution of harmonic.

Thermistor

A temperature-dependent resistor placed on the frequency converter or the motor.

Trip

A state entered in fault situations, for example if the frequency converter is subject to an overtemperature or when the frequency converter is protecting the motor, process or mechanism. The frequency converter prevents a restart until the cause of the fault has disappeared. Restart the frequency converter to cancel the trip state. Do not use the trip state for personal safety.

Trip lock

The frequency converter enters this state in fault situations to protect itself. The frequency converter requires physical intervention, for example when there is a short circuit on the output. A trip lock can only be cancelled by disconnecting mains, removing the cause of the fault, and reconnecting the frequency converter. Restart is prevented until the trip state is cancelled by activating reset or, in some cases, by being programmed to reset automatically. Do not use the trip lock state for personal safety.

VT characteristics

Variable torque characteristics used for pumps and fans.

VVC+

If compared with standard voltage/frequency ratio control, voltage vector control (VVC+) improves the dynamics and the stability, both when the speed reference is changed and in relation to the load torque.

60° AVM

60° asynchronous vector modulation (*14-00 Switching Pattern*).

Power factor

The power factor is the relation between I_1 and I_{RMS} .

$$\text{Power factor} = \frac{\sqrt{3} \times U \times I_1 \cos\phi}{\sqrt{3} \times U \times I_{RMS}}$$

The power factor for 3-phase control:

$$= \frac{I_1 \times \cos\phi}{I_{RMS}} = \frac{I_1}{I_{RMS}} \text{ since } \cos\phi = 1$$

The power factor indicates to which extent the frequency converter imposes a load on the mains supply.

The lower the power factor, the higher the I_{RMS} for the same kW performance.

$$I_{RMS} = \sqrt{I_1^2 + I_5^2 + I_7^2 + \dots + I_n^2}$$

In addition, a high-power factor indicates that the different harmonic currents are low.

The DC coils in the frequency converters produce a high-power factor, which minimises the imposed load on the mains supply.

Safety regulations

1. Disconnect mains supply to the frequency converter whenever repair work is to be carried out. Check that the mains supply has been disconnected and that the necessary time has elapsed before removing motor and mains supply plugs. For information about the discharge time, see .
2. [Off] does not disconnect the mains supply and must not be used as a safety switch.
3. Ground the equipment properly, protect the user against supply voltage, and protect the motor against overload in accordance with applicable national and local regulations.
4. The ground leakage current exceeds 3.5 mA. Ensure the correct grounding of the equipment by a certified electrical installer.
5. Do not remove the plugs for the motor and mains supply while the frequency converter is connected to mains. Check that the mains supply has been disconnected and that the necessary time has elapsed before removing motor and mains plugs.
6. The frequency converter has more voltage sources than L1, L2, and L3, when load sharing

(linking of DC intermediate circuit) or external 24 V DC is installed. Check that all voltage sources have been disconnected and that the necessary time has elapsed before commencing repair work. For information about the discharge time, see .

NOTICE

When using the Safe Torque Off, always follow the instructions in *VLT® Frequency Converters - Safe Torque Off Operating Instructions*.

NOTICE

Control signals from, or internally within, the frequency converter may in rare cases be activated in error, be delayed, or fail to occur entirely. When used in situations where safety is critical, for example, when controlling the electromagnetic brake function of a hoist application, these control signals must not be relied on exclusively.

NOTICE

Hazardous situations must be identified by the machine builder/integrator who is responsible for taking necessary preventive means into consideration. More monitoring and protective devices may be included, always according to valid national safety regulations, for example, law on mechanical tools, regulations for the prevention of accidents.

Crane, lifts, and hoists

The controlling of external brakes must always have a redundant system. The frequency converter can in no circumstances be the primary safety circuit. Comply with relevant standards, for example:
Hoists and cranes: IEC 60204-32
Lifts: EN 81

Protection mode

Once a hardware limit on motor current or DC-link voltage is exceeded, the frequency converter enters the protection mode. Protection mode means a change of the PWM modulation strategy and a low switching frequency to minimise losses. This continues for 10 s after the last fault and increases the reliability and the robustness of the frequency converter while re-establishing full control of the motor.

In hoist applications, protection mode is not usable because the frequency converter is unable to leave this mode again and therefore it extends the time before activating the brake, which is not recommended. Protection mode can be disabled by setting *14-26 Trip Delay at Inverter Fault* to zero, which means that the frequency converter trips immediately if 1 of the hardware limits is exceeded.

NOTICE

Disabling protection mode in hoisting applications (*14-26 Trip Delay at Inverter Fault=0*) is recommended.

2

2 How to Programme

2.1 Local Control Panel

2.1.1 How to Operate Graphical LCP (GLCP)

The GLCP is divided into 4 functional groups:

1. Graphical display with status lines.
2. Menu keys and indicator lights (LEDs) - selecting mode, changing parameters and switching between display functions.
3. Navigation keys and indicator lights (LEDs).
4. Operation keys and indicator lights (LEDs).

Graphical display

The LCD display is backlit with a total of 6 alpha-numeric lines. All data is displayed on the LCP, which can show up to 5 operating variables while in Status mode.

Display lines:

- a. **Status line**
Status messages displaying icons and graphics.
- b. **Line 1–2**
Operator data lines displaying data and variables defined or selected by the user. Press [Status] to add 1 extra line.
- c. **Status line**
Status messages displaying text.

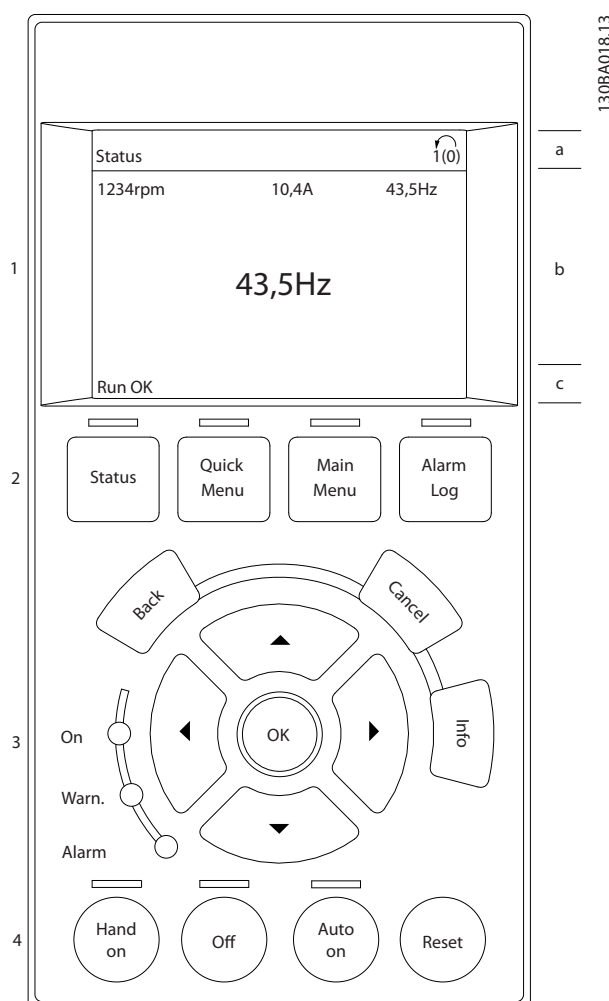

Illustration 2.1 LCP

The display is divided into 3 sections:

Top section

(a) shows the status when in Status mode, or up to 2 variables when not in Status mode, and in the case of alarm/warning.

The number of the active set-up (selected as the active set-up in *parameter 0-10 Active Set-up*) is shown. When programming in another set-up than the active set-up, the number of the set-up being programmed appears to the right in brackets.

Middle section

(b) shows up to 5 variables with related unit, regardless of status. In case of alarm/warning, the warning is shown instead of the variables.

Bottom section

(c) always shows the state of the frequency converter in status mode.

Press [Status] to toggle between 3 status readout displays.

Operating variables with different formatting are shown in each status screen.

Several values or measurements can be linked to each of the displayed operating variables. Define the values/measurements to be displayed via

- Parameter 0-20 Display Line 1.1 Small
- 0-21 Display Line 1.2 Small
- 0-22 Display Line 1.3 Small
- 0-23 Display Line 2 Large
- 0-24 Display Line 3 Large

which can be accessed via [Quick Menu], Q3 Function Set-ups, Q3-1 General Settings, Q3-13 Display Settings.

Each value/measurement readout parameter selected in parameter 0-20 Display Line 1.1 Small to 0-24 Display Line 3 Large has its own scale and number of digits after a possible decimal point. Larger numeric values are displayed with few digits after the decimal point.

Ex.: Current readout
5.25 A; 15.2 A 105 A.

Status display I

This readout state is standard after start-up or initialisation. Press [INFO] to obtain information about the value/measurement linked to the displayed operating variables (1.1, 1.2, 1.3, 2, and 3).

See the operating variables shown in the display in Illustration 2.2. 1.1, 1.2 and 1.3 are shown in small size. 2 and 3 are shown in medium size.

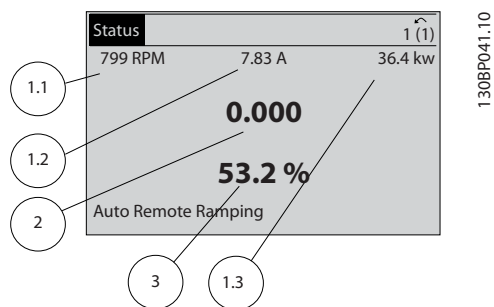

Illustration 2.2 Example of Status Display I

Status display II

See the operating variables (1.1, 1.2, 1.3, and 2) shown in the display in Illustration 2.3.

In the example, speed, motor current, motor power and frequency are selected as variables in the first and second lines.

1.1, 1.2 and 1.3 are shown in small size. 2 is shown in large size.

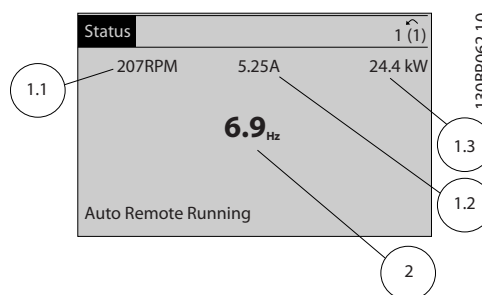

Illustration 2.3 Example of Status Display II

Status display III

This state displays the event and action of the smart logic control.

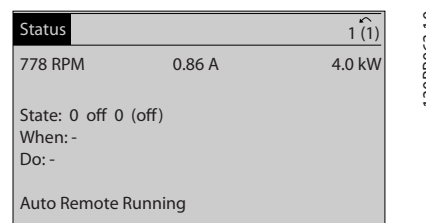

Illustration 2.4 Example of Status Display III

Display contrast adjustment

Press [Status] and [▲] for darker display.
Press [Status] and [▼] for brighter display.

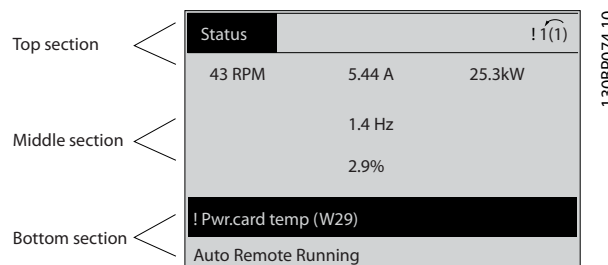

Illustration 2.5 Display Sections

Indicator lights (LEDs)

If certain threshold values are exceeded, the alarm and/or warning LED lights up. A status and alarm text appear in the display.

The On LED is activated when the frequency converter receives power from mains voltage, a DC bus terminal, or a 24 V external supply. At the same time, the backlight is on.

- Green LED/On: Control section is working.
- Yellow LED/Warn.: Indicates a warning.
- Flashing Red LED/Alarm: Indicates an alarm.

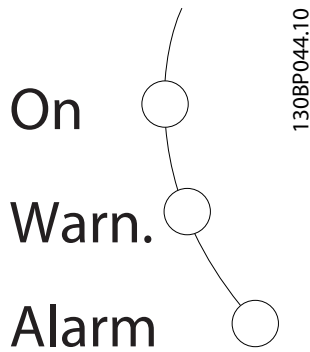

Illustration 2.6 Indicator Lights

GLCP keys
Menu keys

The menu keys are divided into functions. The keys below the display and indicator lights are used for parameter set-up, including selection of display indication during normal operation.



Illustration 2.7 Menu Keys

[Status]

[Status] indicates the status of the frequency converter and/or the motor. 3 different readouts can be selected by pressing the [Status] key:

- 5-line readouts
- 4-line readouts
- Smart logic control.

Press [Status] to select the display mode or for changing back to *Display* mode from either *Quick Menu* mode, *Main Menu* mode, or *Alarm* mode. Also press [Status] to toggle between single or double readout mode.

[Quick Menu]

[Quick Menu] allows quick set-up of the frequency converter. The most common HVAC functions can be programmed here.

The Quick Menu consists of

- My personal menu
- Quick set-up
- Function set-up
- Changes made
- Loggings

The *Function Set-up* provides quick and easy access to all parameters required for most HVAC applications including:

- Most VAV and CAV supply and return fans.
- Cooling tower fans.
- Primary, secondary and condenser water pumps.
- Other pump, fan and compressor applications.

Among other features, it also includes parameters for selecting which variables to display in the LCP, digital preset speeds, scaling of analog references, closed loop single-zone and multi-zone applications, and specific functions related to fans, pumps and compressors.

The Quick Menu parameters can be accessed immediately unless a password has been created via

- *Parameter 0-60 Main Menu Password*
- *Parameter 0-61 Access to Main Menu w/o Password*
- *Parameter 0-65 Personal Menu Password*
- *Parameter 0-66 Access to Personal Menu w/o Password*

It is possible to switch directly between *Quick Menu* mode and *Main Menu* mode.

[Main Menu]

Press [Main Menu] to programme all parameters. The main menu parameters can be accessed immediately unless a password has been created via

- *Parameter 0-60 Main Menu Password*
- *Parameter 0-61 Access to Main Menu w/o Password*
- *Parameter 0-65 Personal Menu Password*
- *Parameter 0-66 Access to Personal Menu w/o Password*

For most HVAC applications, it is not necessary to access the main menu parameters. Instead, the *Quick Menu*, *Quick Set-up* and *Function Set-up* provide the simplest and quickest access to the most required parameters.

It is possible to switch directly between *Main Menu* mode and *Quick Menu* mode.

Parameter shortcut can be carried out by pressing [Main Menu] for 3 s. The parameter shortcut allows direct access to any parameter.

[Alarm Log]

[Alarm Log] displays an alarm list of the 10 most recent alarms (numbered A1-A10). To obtain more details about an alarm, press the navigation keys to manoeuvre to the alarm number and press [OK]. Information is displayed about the condition of the frequency converter before it enters the alarm mode.

The [Alarm Log] key on the LCP allows access to both alarm log and maintenance log.

[Back]

[Back] reverts to the previous step or layer in the navigation structure.



Illustration 2.8 Back Key

[Cancel]

[Cancel] cancels the last change or command as long as the display has not been changed.



Illustration 2.9 Cancel Key

[Info]

[Info] displays information about a command, parameter, or function in any display window. [Info] provides detailed information when needed. Exit Info mode by pressing either [Info], [Back], or [Cancel].



Illustration 2.10 Info Key

Navigation Keys

The 4 navigation keys are used to navigate between the different options available in the Quick Menu, Main Menu and Alarm Log. Press the keys to move the cursor.

[OK]

Press [OK] to select a parameter marked by the cursor and for enabling the change of a parameter.

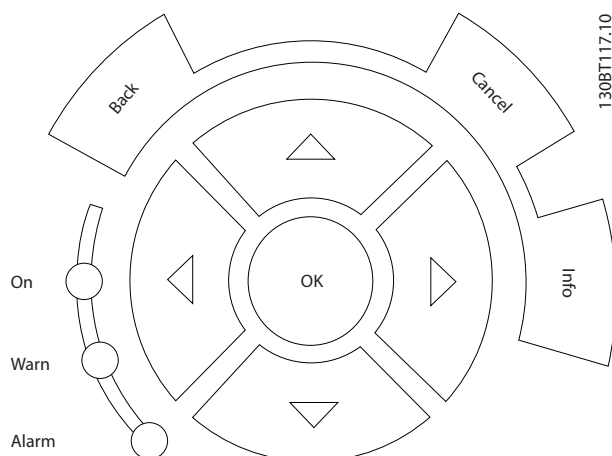

Illustration 2.11 Navigation Keys

Operation keys

Operation keys for local control are found at the bottom of the control panel.

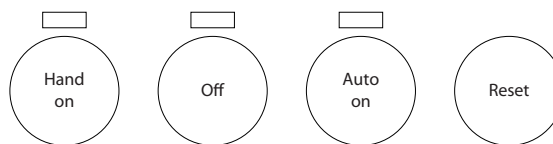

Illustration 2.12 Operation Keys

130BP046.10

[Hand On]

[Hand On] enables control of the frequency converter via the GLCP. [Hand On] also starts the motor and allows entering the motor speed data with the navigation keys. The key can be selected as [1] Enable or [0] Disable via parameter 0-40 [Hand on] Key on LCP.

The following control signals are still active when [Hand On] is activated:

- [Hand On] - [Off] - [Auto On].
- Reset.
- Coasting stop inverse.
- Reversing.
- Set-up select lsb - Set-up select msb.
- Stop command from serial communication.
- Quick stop.
- DC brake.

NOTICE

External stop signals activated with control signals or a fieldbus override a start command via the LCP.

[Off]

[Off] stops the connected motor. The key can be selected as [1] Enabled or [0] Disabled via parameter 0-41 [Off] Key on LCP. If no external stop function is selected and the [Off] key is inactive, the motor can only be stopped by disconnecting the mains supply.

[Auto On]

[Auto On] enables the frequency converter to be controlled via the control terminals and/or serial communication. When a start signal is applied on the control terminals and/or the bus, the frequency converter starts. The key can be selected as [1] Enabled or [0] Disabled via parameter 0-42 [Auto on] Key on LCP.

NOTICE

An active HAND-OFF-AUTO signal via the digital inputs has higher priority than the control keys [Hand On] – [Auto On].

[Reset]

Press [Reset] to reset the frequency converter after an alarm (trip). It can be selected as [1] Enable or [0] Disable via parameter 0-43 [Reset] Key on LCP.

The parameter shortcut can be carried out by pressing the [Main Menu] key for 3 s. The parameter shortcut allows direct access to any parameter.

2.1.2 How to Operate Numeric LCP (NLCP)

The control panel is divided into 4 functional groups:

1. Numeric display.
2. Menu key and indicator lights (LEDs) - changing parameters and switching between display functions.
3. Navigation keys and indicator lights (LEDs).
4. Operation keys and indicator lights (LEDs).

NOTICE

Parameter copy is not possible with NLCP (LCP101).

Select 1 of the following modes:

Status mode: Displays the status of the frequency converter or the motor.

If an alarm occurs, the NLCP automatically switches to Status mode.

A number of alarms can be displayed.

Quick Set-up or Main Menu mode: Display parameters and parameter settings.

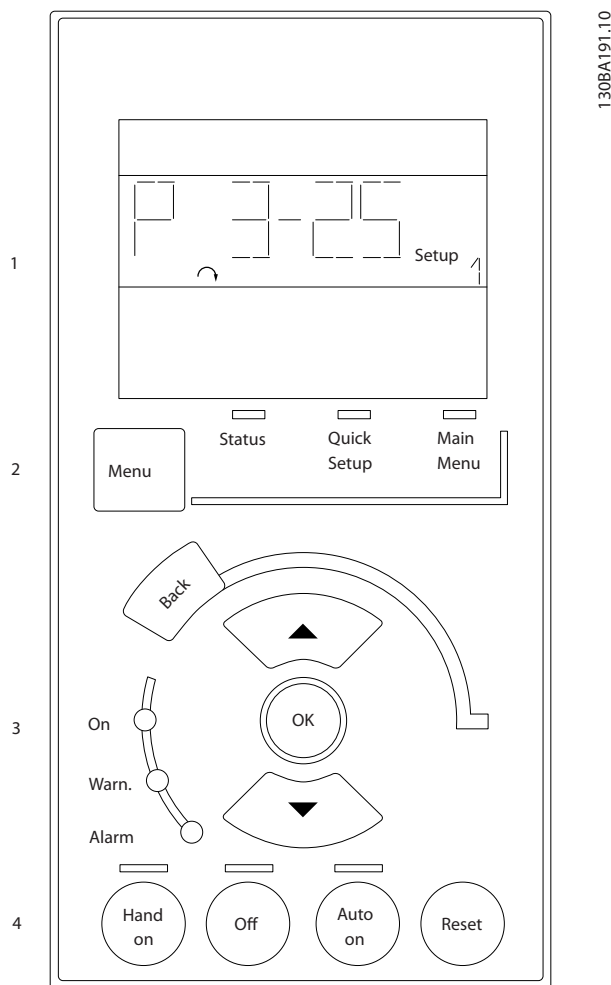

Illustration 2.13 Numerical LCP (NLCP)



Illustration 2.14 Status Display Example

Indicator lights (LEDs):

- Green LED/On: Indicates if control section is on.
- Yellow LED/Warn.: Indicates a warning.
- Flashing red LED/Alarm: Indicates an alarm.



Illustration 2.15 Alarm Display Example

Menu key

[Menu] Select 1 of the following modes:

- Status
- Quick Setup
- Main Menu

Main Menu is used for programming all parameters. The parameters can be accessed immediately unless a password has been created via:

- Parameter 0-60 Main Menu Password,
- Parameter 0-61 Access to Main Menu w/o Password,
- Parameter 0-65 Personal Menu Password,
- Parameter 0-66 Access to Personal Menu w/o Password.

Quick Setup is used to set up the frequency converter using only the most essential parameters.

The parameter values can be changed using the [▼] [▲] when the value is flashing.

Select Main Menu by pressing the [Menu] key a number of times until the Main Menu LED is lit.

Select the parameter group [xx-__] and press [OK].

Select the parameter [__-xx] and press [OK].

If the parameter is an array parameter select the array number and press [OK].

Select the wanted data value and press [OK].

Press [Back] to step backwards.

Arrow [▼] [▲] keys are used for manoeuvring between parameter groups, parameters, and within parameters.

Press [OK] is used for choosing a parameter marked by the cursor, and for enabling the change of a parameter.

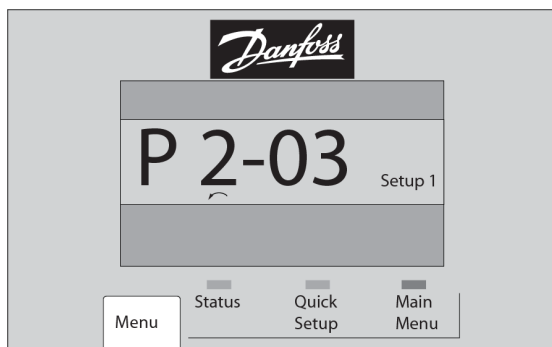
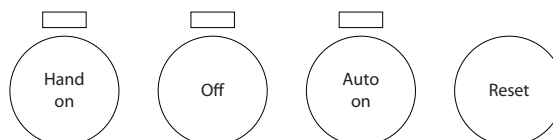

Illustration 2.16 Menu Display

130BP079.10

Operation Keys

Keys for local control are found at the bottom of the control panel.



130BP046.10

Illustration 2.17 Operation Keys of the Numerical LCP (NLCP)

[Hand On] enables control of the frequency converter via the LCP. [Hand On] also starts the motor. Press the navigation keys [▲] [▼] [▶] [◀] to enter motor speed data. The key can be selected as [1] Enable or [0] Disable via parameter 0-40 [Hand on] Key on LCP.

External stop signals activated by control signals or a serial bus override a start command via the LCP.

The following control signals are still active when [Hand on] is activated:

- [Hand On] - [Off] - [Auto On]
- Reset
- Coasting stop inverse
- Reversing
- Set-up select lsb - Set-up select msb
- Stop command from serial communication
- Quick stop
- DC brake

[Off] stops the connected motor. The key can be selected as [1] Enable or [0] Disable via parameter 0-41 [Off] Key on LCP.

If no external stop function is selected and the [Off] key is inactive, the motor can be stopped by disconnecting the mains supply.

[Auto On] enables the control terminals and/or serial communication to control the frequency converter. When a start signal is applied on the control terminals and/or the bus, the frequency converter starts. The key can be selected as [1] Enable or [0] Disable via parameter 0-42 [Auto on] Key on LCP.

NOTICE

An active HAND-OFF-AUTO signal via the digital inputs has higher priority than the control keys [Hand On] [Auto On].

[Reset] is used for resetting the frequency converter after an alarm (trip). It can be selected as [1] Enable or [0] Disable via parameter 0-43 [Reset] Key on LCP.

2.1.3 Quick Transfer of Parameter Settings between Multiple Frequency Converters

Once the set-up of a frequency converter is complete, store the data in the LCP or on a PC via MCT 10 Set-up Software Tool.

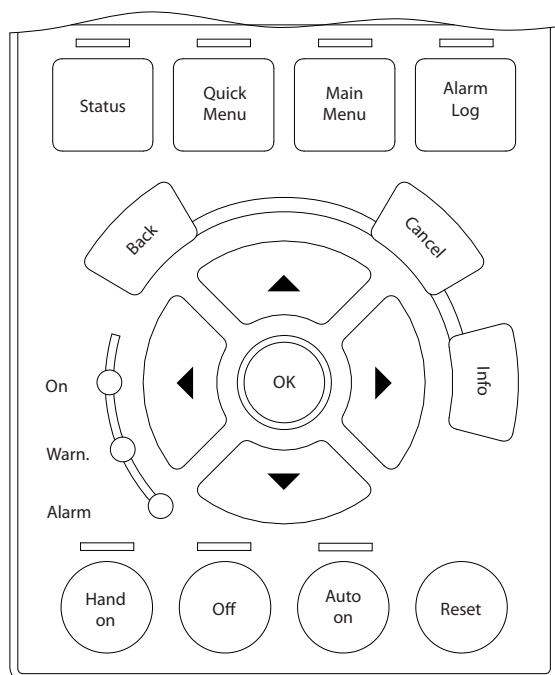

Illustration 2.18 LCP

Data storage in LCP

NOTICE

Stop the motor before performing this operation.

To store the data in the LCP:

1. Go to *parameter 0-50 LCP Copy*.
2. Press the [OK] key.
3. Select [1] *All to LCP*.
4. Press the [OK] key.

All parameter settings are now stored in the LCP indicated by the progress bar. When 100% is reached, press [OK].

Connect the LCP to another frequency converter and copy the parameter settings to this frequency converter as well.

Data transfer from LCP to frequency converter

NOTICE

Stop the motor before performing this operation.

To transfer the data from the LCP to the frequency converter:

1. Go to *parameter 0-50 LCP Copy*.
2. Press the [OK] key.

3. Select [2] *All from LCP*.
4. Press the [OK] key.

The parameter settings stored in the LCP are now transferred to the frequency converter indicated by the progress bar. When 100% is reached, press [OK].

2.1.4 Parameter Set-Up

The frequency converter can be used for practically all assignments, thus offering a significant number of parameters. The series offers a choice between 2 programming modes - the *Quick Menu* mode and the *Main Menu* mode.

The latter provides access to all parameters. The former takes the user through a few parameters making it possible to program the majority of HVAC applications. Regardless of the programming mode, parameters can be changed in both *Quick Menu* mode and in *Main Menu* mode.

2.1.5 Quick Menu Mode

Parameter data

The graphical display (GLCP) provides access to all parameters listed in the *Quick Menu*. The numeric display (NLCP) only provides access to the *Quick Set-up* parameters. To set parameters pressing [Quick Menu] - enter or change parameter data or settings in accordance with the following procedure:

1. Press [Quick Menu].
2. Press [▲] or [▼] to find the parameter to change.
3. Press [OK].
4. Press [▲] or [▼] to select the correct parameter setting.
5. Press [OK].
6. To move to a different digit within a parameter setting, use the [◀] and [▶].
7. Highlighted area indicates digit selected for change.
8. Press [Cancel] to disregard change, or press [OK] to accept change and enter the new setting.

Example of changing parameter data

Assume *parameter 22-60 Broken Belt Function* is set to [0] *Off*. To monitor the fan-belt condition, non-broken or broken, follow this procedure:

1. Press [Quick Menu].
2. Press [▼] to select *Function Set-ups*.
3. Press [OK].
4. Press [▼] to select *Application Settings*.
5. Press [OK].

6. Press [OK] again for *Fan Functions*.
7. Press [OK] to select *Broken Belt Function*.
8. Press [▼], to select [2] *Trip*.

If a broken fan-belt is detected, the frequency converter trips.

Select Q1 My Personal Menu to display personal parameters

For example, an AHU or pump OEM may have pre-programmed personal parameters to be in *My Personal Menu* during factory commissioning to make on-site commissioning/fine-tuning simpler. These parameters are selected in *parameter 0-25 My Personal Menu*. Up to 20 different parameters can be programmed in this menu.

Select Changes Made to obtain information about:

- The last 10 changes. Press [▲] and [▼] to scroll between the last 10 changed parameters.
- The changes made since default setting.

Loggings

Loggings show information about the display line readouts. The information is shown as graphs. Only display parameters selected in *parameter 0-20 Display Line 1.1 Small* and *0-24 Display Line 3 Large* can be viewed. Up to 120 samples can be stored in the memory for later reference.

Quick Set-up

Efficient parameter set-up for HVAC applications

The parameters can easily be set up for most HVAC applications only by using the *Quick Set-up*. After pressing [Quick Menu], the different options in the *Quick Menu* are listed. See also *Illustration 2.19* and *Table 2.2* to *Table 2.5*.

Example of using the Quick Set-up

To set the ramp-down time to 100 s, follow this procedure:

1. Select *Quick Set-up. Parameter 0-01 Language* in Quick Set-up appears.
2. Press [▼] repeatedly until *parameter 3-42 Ramp 1 Ramp Down Time* appears with the default setting of 20 s.
3. Press [OK].
4. Press [◀] to highlight the third digit before the comma.
5. Change 0 to 1 by pressing [▲].
6. Press [▶] to highlight the digit 2.
7. Change 2 to 0 by pressing [▼].
8. Press [OK].

The new ramp-down time is now set to 100 s.

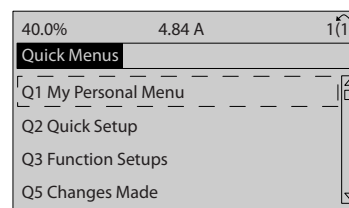

Illustration 2.19 Quick Menu View

Access the 18 most important set-up parameters of the frequency converter via *Quick Set-up*. After programming, the frequency converter is ready for operation. The 18 *Quick Set-up* parameters are shown in *Table 2.1*.

Parameter	[Units]
Parameter 0-01 Language	
Parameter 1-20 Motor Power [kW]	[kW]
Parameter 1-21 Motor Power [HP]	[Hp]
Parameter 1-22 Motor Voltage ¹⁾	[V]
Parameter 1-23 Motor Frequency	[Hz]
Parameter 1-24 Motor Current	[A]
Parameter 1-25 Motor Nominal Speed	[RPM]
Parameter 1-28 Motor Rotation Check	[Hz]
Parameter 3-41 Ramp 1 Ramp Up Time	[s]
Parameter 3-42 Ramp 1 Ramp Down Time	[s]
Parameter 4-11 Motor Speed Low Limit [RPM]	[RPM]
Parameter 4-12 Motor Speed Low Limit [Hz] ¹⁾	[Hz]
Parameter 4-13 Motor Speed High Limit [RPM]	[RPM]
Parameter 4-14 Motor Speed High Limit [Hz] ¹⁾	[Hz]
Parameter 3-19 Jog Speed [RPM]	[RPM]
Parameter 3-11 Jog Speed [Hz] ¹⁾	[Hz]
5-12 Terminal 27 Digital Input	
Parameter 5-40 Function Relay ²⁾	

Table 2.1 Quick Set-up Parameters

1) The information shown in the display depends on the selections made in *parameter 0-02 Motor Speed Unit* and *parameter 0-03 Regional Settings*. The default settings of *parameter 0-02 Motor Speed Unit* and *parameter 0-03 Regional Settings* depend on which region of the world the frequency converter is supplied to, but can be reprogrammed as required.
 2) *Parameter 5-40 Function Relay* is an array. Select between [0] Relay1 or [1] Relay2. Standard setting is [0] Relay1 with the default option [9] Alarm.

For detailed information about settings and programming, see *chapter 3 Parameter Descriptions*.

NOTICE

If [0] *No Operation* is selected in *5-12 Terminal 27 Digital Input*, no connection to +24 V on terminal 27 is necessary to enable start.
 If [2] *Coast Inverse* (factory default value) is selected in *5-12 Terminal 27 Digital Input*, a connection to +24 V is necessary to enable start.

2

2.1.6 Function Set-ups

The *Function Set-up* provides quick and easy access to all parameters required for most HVAC applications including:

- Most VAV and CAV supply and return fans.
- Cooling tower fans.
- Primary pumps.
- Secondary pumps.
- Condenser water pumps.
- Other pump, fan and compressor applications.

How to access *Function Set-up* - example

1. Turn on the frequency converter (yellow LED lights).

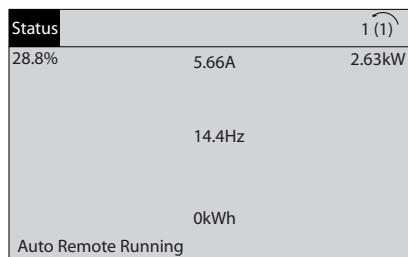

130BT110.11

Illustration 2.20 Frequency Converter Turned On

2. Press [Quick Menus].

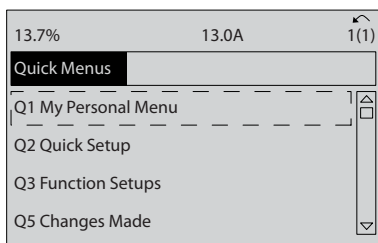

130BT111.10

Illustration 2.21 Quick Menu Selected

3. Press [▲] and [▼] to scroll down to *Function Set-ups*. Press [OK].

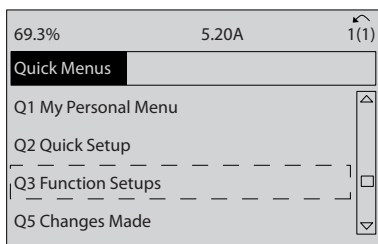

130BT112.10

Illustration 2.22 Scrolling to Function Set-up

4. *Function Set-ups* options appear. Select *Q3-1 General Settings*. Press [OK].

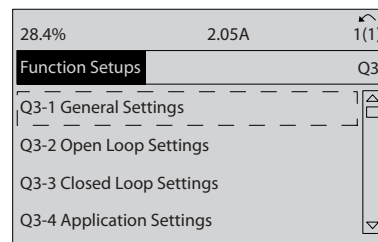

130BT113.10

Illustration 2.23 Function Set-ups Options

5. Press [▲] and [▼] to scroll down to *Q3-11 Analog Outputs*. Press [OK].

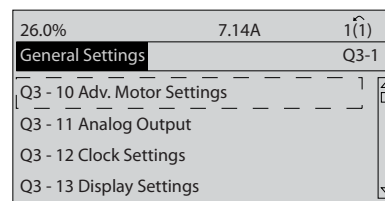

130BT114.10

Illustration 2.24 General Settings Options

6. Select *parameter 6-50 Terminal 42 Output*. Press [OK].

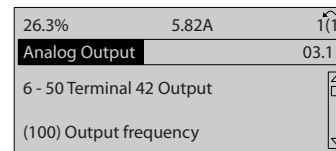

130BA115.10

Illustration 2.25 Parameter 6-50 Terminal 42 Output Selected

7. Press [▲] and [▼] to select between the different options. Press [OK].

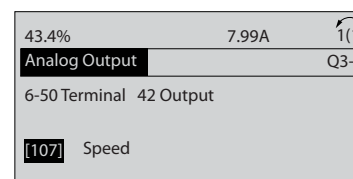

130BT116.10

Illustration 2.26 Setting a Parameter

Function Set-ups parameters

The *Function Set-ups* parameters are grouped in the following way:

Q3-10 Adv. motor settings	Q3-11 Analog output	Q3-12 Clock settings	Q3-13 Display settings
Parameter 1-90 Motor Thermal Protection	Parameter 6-50 Terminal 42 Output	Parameter 0-70 Date and Time	Parameter 0-20 Display Line 1.1 Small
Parameter 1-93 Thermistor Source	Parameter 6-51 Terminal 42 Output Min Scale	Parameter 0-71 Date Format	0-21 Display Line 1.2 Small
Parameter 1-29 Automatic Motor Adaptation (AMA)	Parameter 6-52 Terminal 42 Output Max Scale	Parameter 0-72 Time Format	0-22 Display Line 1.3 Small
Parameter 14-01 Switching Frequency	–	Parameter 0-74 DST/Summertime	0-23 Display Line 2 Large
Parameter 4-53 Warning Speed High	–	Parameter 0-76 DST/Summertime Start	0-24 Display Line 3 Large
–	–	Parameter 0-77 DST/Summertime End	Parameter 0-37 Display Text 1
–	–	–	Parameter 0-38 Display Text 2
–	–	–	Parameter 0-39 Display Text 3

Table 2.2 Q3-1 General Settings

Q3-20 Digital reference	Q3-21 Analog reference
Parameter 3-02 Minimum Reference	Parameter 3-02 Minimum Reference
3-03 Maximum Reference	3-03 Maximum Reference
Parameter 3-10 Preset Reference	Parameter 6-10 Terminal 53 Low Voltage
Parameter 5-13 Terminal 29 Digital Input	Parameter 6-11 Terminal 53 High Voltage
Parameter 5-14 Terminal 32 Digital Input	Parameter 6-12 Terminal 53 Low Current
5-15 Terminal 33 Digital Input	Parameter 6-13 Terminal 53 High Current
–	Parameter 6-14 Terminal 53 Low Ref./Feedb. Value
–	Parameter 6-15 Terminal 53 High Ref./Feedb. Value

Table 2.3 Q3-2 Open-loop Settings

Q3-30 Single zone int. setpoint	Q3-31 Single zone ext. setpoint	Q3-32 Multi zone/adv
Parameter 1-00 Configuration Mode	Parameter 1-00 Configuration Mode	Parameter 1-00 Configuration Mode
20-12 Reference/Feedback Unit	20-12 Reference/Feedback Unit	Parameter 3-15 Reference 1 Source
Parameter 20-13 Minimum Reference/Feedb. Value	Parameter 20-13 Minimum Reference/Feedb. Value	Parameter 3-16 Reference 2 Source
Parameter 20-14 Maximum Reference/Feedb. Value	Parameter 20-14 Maximum Reference/Feedb. Value	Parameter 20-00 Feedback 1 Source
Parameter 6-22 Terminal 54 Low Current	Parameter 6-10 Terminal 53 Low Voltage	Parameter 20-01 Feedback 1 Conversion
Parameter 6-24 Terminal 54 Low Ref./Feedb. Value	Parameter 6-11 Terminal 53 High Voltage	Parameter 20-02 Feedback 1 Source Unit
Parameter 6-25 Terminal 54 High Ref./Feedb. Value	Parameter 6-12 Terminal 53 Low Current	Parameter 20-03 Feedback 2 Source
Parameter 6-26 Terminal 54 Filter Time Constant	Parameter 6-13 Terminal 53 High Current	Parameter 20-04 Feedback 2 Conversion
Parameter 6-27 Terminal 54 Live Zero	Parameter 6-14 Terminal 53 Low Ref./Feedb. Value	20-05 Feedback 2 Source Unit
Parameter 6-00 Live Zero Timeout Time	Parameter 6-15 Terminal 53 High Ref./Feedb. Value	Parameter 20-06 Feedback 3 Source
Parameter 6-01 Live Zero Timeout Function	Parameter 6-22 Terminal 54 Low Current	Parameter 20-07 Feedback 3 Conversion
Parameter 20-21 Setpoint 1	Parameter 6-24 Terminal 54 Low Ref./Feedb. Value	Parameter 20-08 Feedback 3 Source Unit
Parameter 20-81 PID Normal/ Inverse Control	Parameter 6-25 Terminal 54 High Ref./Feedb. Value	20-12 Reference/Feedback Unit
Parameter 20-82 PID Start Speed [RPM]	Parameter 6-26 Terminal 54 Filter Time Constant	Parameter 20-13 Minimum Reference/Feedb. Value

Q3-30 Single zone int. setpoint	Q3-31 Single zone ext. setpoint	Q3-32 Multi zone/adv
Parameter 20-83 PID Start Speed [Hz]	Parameter 6-27 Terminal 54 Live Zero	Parameter 20-14 Maximum Reference/Feedb.
Parameter 20-93 PID Proportional Gain	Parameter 6-00 Live Zero Timeout Time	Parameter 6-10 Terminal 53 Low Voltage
Parameter 20-94 PID Integral Time	Parameter 6-01 Live Zero Timeout Function	Parameter 6-11 Terminal 53 High Voltage
Parameter 20-70 Closed Loop Type	Parameter 20-81 PID Normal/ Inverse Control	Parameter 6-12 Terminal 53 Low Current
Parameter 20-71 PID Performance	Parameter 20-82 PID Start Speed [RPM]	Parameter 6-13 Terminal 53 High Current
Parameter 20-72 PID Output Change	Parameter 20-83 PID Start Speed [Hz]	Parameter 6-14 Terminal 53 Low Ref./Feedb. Value
Parameter 20-73 Minimum Feedback Level	Parameter 20-93 PID Proportional Gain	Parameter 6-15 Terminal 53 High Ref./Feedb. Value
Parameter 20-74 Maximum Feedback Level	Parameter 20-94 PID Integral Time	Parameter 6-16 Terminal 53 Filter Time Constant
Parameter 20-79 PID Autotuning	Parameter 20-70 Closed Loop Type	Parameter 6-17 Terminal 53 Live Zero
–	Parameter 20-71 PID Performance	Parameter 6-20 Terminal 54 Low Voltage
–	Parameter 20-72 PID Output Change	Parameter 6-21 Terminal 54 High Voltage
–	Parameter 20-73 Minimum Feedback Level	Parameter 6-22 Terminal 54 Low Current
–	Parameter 20-74 Maximum Feedback Level	Parameter 6-23 Terminal 54 High Current
–	Parameter 20-79 PID Autotuning	Parameter 6-24 Terminal 54 Low Ref./Feedb. Value
–	–	Parameter 6-25 Terminal 54 High Ref./Feedb. Value
–	–	Parameter 6-26 Terminal 54 Filter Time Constant
–	–	Parameter 6-27 Terminal 54 Live Zero
–	–	Parameter 6-00 Live Zero Timeout Time
–	–	Parameter 6-01 Live Zero Timeout Function
–	–	Parameter 4-56 Warning Feedback Low
–	–	Parameter 4-57 Warning Feedback High
–	–	Parameter 20-20 Feedback Function
–	–	Parameter 20-21 Setpoint 1
–	–	Parameter 20-22 Setpoint 2
–	–	Parameter 20-81 PID Normal/ Inverse Control
–	–	Parameter 20-82 PID Start Speed [RPM]
–	–	Parameter 20-83 PID Start Speed [Hz]
–	–	Parameter 20-93 PID Proportional Gain
–	–	Parameter 20-94 PID Integral Time
–	–	Parameter 20-70 Closed Loop Type
–	–	Parameter 20-71 PID Performance
–	–	Parameter 20-72 PID Output Change
–	–	Parameter 20-73 Minimum Feedback Level
–	–	Parameter 20-74 Maximum Feedback Level
–	–	Parameter 20-79 PID Autotuning

Table 2.4 Q3-3 Closed-loop Settings

Q3-40 Fan functions	Q3-41 Pump functions	Q3-42 Compressor functions
Parameter 22-60 Broken Belt Function	Parameter 22-20 Low Power Auto Set-up	Parameter 1-03 Torque Characteristics
Parameter 22-61 Broken Belt Torque	Parameter 22-21 Low Power Detection	Parameter 1-71 Start Delay
Parameter 22-62 Broken Belt Delay	Parameter 22-22 Low Speed Detection	Parameter 22-75 Short Cycle Protection
Parameter 4-64 Semi-Auto Bypass Set-up	Parameter 22-23 No-Flow Function	Parameter 22-76 Interval between Starts
Parameter 1-03 Torque Characteristics	Parameter 22-24 No-Flow Delay	Parameter 22-77 Minimum Run Time
Parameter 22-22 Low Speed Detection	Parameter 22-40 Minimum Run Time	Parameter 5-01 Terminal 27 Mode
Parameter 22-23 No-Flow Function	Parameter 22-41 Minimum Sleep Time	Parameter 5-02 Terminal 29 Mode
Parameter 22-24 No-Flow Delay	Parameter 22-42 Wake-up Speed [RPM]	5-12 Terminal 27 Digital Input
Parameter 22-40 Minimum Run Time	Parameter 22-43 Wake-up Speed [Hz]	Parameter 5-13 Terminal 29 Digital Input
Parameter 22-41 Minimum Sleep Time	Parameter 22-44 Wake-up Ref./FB Difference	Parameter 5-40 Function Relay
Parameter 22-42 Wake-up Speed [RPM]	Parameter 22-45 Setpoint Boost	Parameter 1-73 Flying Start
Parameter 22-43 Wake-up Speed [Hz]	Parameter 22-46 Maximum Boost Time	Parameter 1-86 Trip Speed Low [RPM]
Parameter 22-44 Wake-up Ref./FB Difference	Parameter 22-26 Dry Pump Function	Parameter 1-87 Trip Speed Low [Hz]
Parameter 22-45 Setpoint Boost	Parameter 22-27 Dry Pump Delay	–
Parameter 22-46 Maximum Boost Time	Parameter 22-80 Flow Compensation	–
Parameter 2-10 Brake Function	Parameter 22-81 Square-linear Curve Approximation	–
2-16 AC brake Max. Current	Parameter 22-82 Work Point Calculation	–
Parameter 2-17 Over-voltage Control	Parameter 22-83 Speed at No-Flow [RPM]	–
Parameter 1-73 Flying Start	Parameter 22-84 Speed at No-Flow [Hz]	–
Parameter 1-71 Start Delay	Parameter 22-85 Speed at Design Point [RPM]	–
Parameter 1-80 Function at Stop	Parameter 22-86 Speed at Design Point [Hz]	–
Parameter 2-00 DC Hold/Preheat Current	Parameter 22-87 Pressure at No-Flow Speed	–
Parameter 4-10 Motor Speed Direction	Parameter 22-88 Pressure at Rated Speed	–
–	Parameter 22-89 Flow at Design Point	–
–	Parameter 22-90 Flow at Rated Speed	–
–	Parameter 1-03 Torque Characteristics	–
–	Parameter 1-73 Flying Start	–

Table 2.5 Q3-4 Application Settings

2.1.7 Main Menu Mode

Press [Main Menu] to Select the *Main Menu* mode. The below read out appears on the display. The middle and bottom sections on the display show a list of parameter groups which can be selected by toggling the [▲] and [▼] keys.

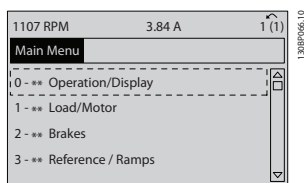

Illustration 2.27 Main Menu Mode

Each parameter has a name and number which remain the same regardless of the programming mode. In the *Main Menu* mode, the parameters are divided into groups. The first digit of the parameter number (from the left) indicates the parameter group number.

All parameters can be changed in the Main Menu. However, depending on the configuration (*parameter 1-00 Configuration Mode*), some parameters can be hidden.

2

2.1.8 Parameter Selection

In the *Main Menu* mode, the parameters are divided into groups. Press the navigation keys to select parameter group.

The following parameter groups are accessible:

Group no.	Parameter group
0	Operation/Display
1	Load/Motor
2	Brakes
3	References/Ramps
4	Limits/Warnings
5	Digital In/Out
6	Analog In/Out
8	Comm. and Options
9	Profibus
10	CAN Fieldbus
11	LonWorks
12	Ethernet IP / Modbus TCP / PROFINET
13	Smart Logic
14	Special Functions
15	Drive Information
16	Data Readouts
18	Data Readouts 2
20	Drive Closed Loop
21	Ext. Closed Loop
22	Application Functions
23	Time-based Functions
25	Cascade Controller
26	Analog I/O Option MCB 109

Table 2.6 Parameter Selection

After selecting a parameter group, press the navigation keys to select a parameter.

The middle section on the display shows the parameter number and name, as well as the selected parameter value.

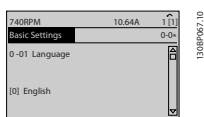

Illustration 2.28 Parameter Selection

2.1.9 Changing Data

Press [OK] to change the selected parameter. The procedure for changing data depends on whether the selected parameter represents a numerical data value or a text value.

2.1.10 Changing a Text Value

If the selected parameter is a text value, change the text value with the [▲] [▼] keys.

Place the cursor on the value that should be saved and press [OK].

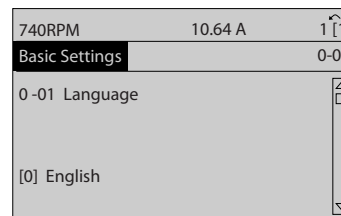

1308P068.10

Illustration 2.29 Changing a Text Value

2.1.11 Changing a Group of Numeric Data Values

If the selected parameter represents a numeric data value, change the data value pressing the [◀] [▶] navigation keys, as well as the [▲] [▼] navigation keys. Press [◀] [▶] keys to move the cursor horizontally.

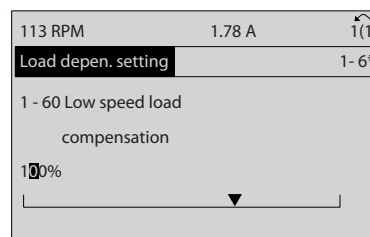

1308P069.10

Illustration 2.30 Changing a Group of Numeric Data Values

Press the [▲] [▼] keys to change the data value. [▲] increases the data value, and [▼] decreases the data value. Place the cursor on the value to save and press [OK].

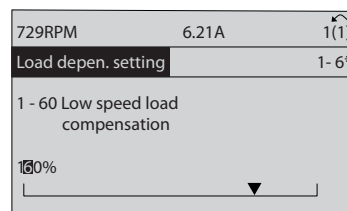

1308P070.10

Illustration 2.31 Changing a Group of Numeric Data Values

2.1.12 Value, Step-by-step

Certain parameters can be changed step-by-step. This applies to

- *Parameter 1-20 Motor Power [kW],*
- *Parameter 1-22 Motor Voltage,*
- *Parameter 1-23 Motor Frequency*

The parameters are changed both as a group of numeric data values and as numeric data values that are infinitely varying.

2.1.13 Read out and Programming of Indexed Parameters

Parameters are indexed when placed in a rolling stack. *Parameter 15-30 Alarm Log: Error Code* to *parameter 15-33 Alarm Log: Date and Time* contain a fault log which can be read out. Select a parameter, press [OK], and use the [▲]/[▼] navigation keys to scroll through the value log.

Use *parameter 3-10 Preset Reference* as another example: Select the parameter, press [OK], and use the [▲]/[▼] navigation keys to scroll through the indexed values. To change the parameter value, select the indexed value and press [OK]. Change the value by using the [▲]/[▼] keys. Press [OK] to accept the new setting. Press [Cancel] to abort. Press [Back] to leave the parameter.

2.1.14 Initialisation to Default Settings

Initialise the frequency converter to default settings in 2 ways.

Recommended initialisation (via *parameter 14-22 Operation Mode*)

1. Select *parameter 14-22 Operation Mode*.
2. Press [OK].
3. Select [2] Initialisation.
4. Press [OK].
5. Cut off the mains supply and wait until the display turns off.
6. Reconnect the mains supply - the frequency converter is now reset.
7. Change *parameter 14-22 Operation Mode* back to [0] Normal Operation.

NOTICE

Resets parameters selected in Personal Menu with default factory setting.

Parameter 14-22 Operation Mode initialises all except

Parameter 14-50 RFI Filter

Parameter 8-30 Protocol

Parameter 8-31 Address

Parameter 8-32 Baud Rate

Parameter 8-35 Minimum Response Delay

Parameter 8-36 Maximum Response Delay

Parameter 8-37 Maximum Inter-Char Delay

Parameter 15-00 Operating hours to

parameter 15-05 Over Volt's

Parameter 15-20 Historic Log: Event to

parameter 15-22 Historic Log: Time

Parameter 15-30 Alarm Log: Error Code to

parameter 15-32 Alarm Log: Time

Manual initialisation

1. Disconnect from mains and wait until the display turns off.
2.
 - 2a Press [Status] - [Main Menu] - [OK] at the same time while power up for LCP 102, Graphical Display.
 - 2b Press [Menu] while power up for LCP 101, Numerical Display.
3. Release the keys after 5 s.
4. The frequency converter is now programmed according to default settings.

This procedure initialises all except:

- *Parameter 15-00 Operating hours;*
- *Parameter 15-03 Power Up's;*
- *Parameter 15-04 Over Temp's;*
- *Parameter 15-05 Over Volt's.*

NOTICE

Manual initialisation:

- **Resets serial communication.**
- **Resets *parameter 14-50 RFI Filter* and fault log settings.**
- **Removes parameters selected in *parameter 25-00 Cascade Controller*.**

NOTICE

After initialisation and power cycling, the display does not show any information until after a couple of minutes.

3 Parameter Descriptions

3

3.1 Parameter Selection

3.1.1 Main Menu Structure

Parameters for the frequency converter are grouped into various parameter groups for easy selection of the correct parameters for optimised operation of the frequency converter.

To programme most VLT® HVAC Drive applications, press [Quick Menu] and select the parameters under *Quick Set-up* and *Function Set-ups*.

Descriptions and default settings of parameters may be found in *chapter 5 Parameter Lists*.

*Chapter 3.2 Parameters: 0-** Operation and Display*

*Chapter 3.3 Parameters: 1-** Load and Motor*

*Chapter 3.4 Parameters: 2-** Main Menu - Brakes*

*Chapter 3.5 Parameters: 3-** Main Menu - Reference/Ramps*

*Chapter 3.6 Parameters: 4-** Main Menu - Limits/Warnings*

*Chapter 3.7 Parameters: 5-** Main Menu - Digital In/Out*

*Chapter 3.8 Parameters: 6-** Main Menu - Analog In/Out*

*Chapter 3.9 Parameters: 8-** Main Menu - Communications and Options*

*Chapter 3.10 Parameters: 9-** Main Menu - PROFIBUS*

*Chapter 3.11 Parameters: 10-** Main Menu - CAN Fieldbus*

*Chapter 3.12 Parameters: 11-** Main Menu - LonWorks*

*Chapter 3.13 Parameters: 13-** Main Menu - Smart Logic*

*Chapter 3.14 Parameters: 14-** Main Menu - Special Functions*

*Chapter 3.15 Parameters: 15-** Main Menu - Drive Information*

*Chapter 3.16 Parameters: 16-** Main Menu - Data Readouts*

*Chapter 3.17 Parameters: 18-** Main Menu - Data Readouts 2*

*Chapter 3.18 Parameters: 20-** Main Menu - FC Closed Loop*

*Chapter 3.19 Parameters: 21-** Main Menu - Extended Closed Loop*

*Chapter 3.20 Parameters: 22-** Application Functions*

*Chapter 3.21 Parameters: 23-** Time-based Functions*

*Chapter 3.22 Parameters: 24-** Application Functions 2*

*Chapter 3.23 Parameters: 25-** Cascade Controller*

*Chapter 3.24 Parameters: 26-** Analog I/O Option MCB 109*

*Chapter 3.25 Parameters: 30-** Special Features*

3.2 Parameters: 0-** Operation and Display

Parameters related to the fundamental functions of the frequency converter, function of the LCP keys and configuration of the LCP display.

3.2.1 0-0* Basic Settings

0-01 Language		
Option:	Function:	
		Defines the language to be used in the display. The frequency converter can be delivered with 2 different language packages. English and German are included in both packages. English cannot be erased or manipulated.
[0] *	English	Part of Language packages 1 - 2
[1]	Deutsch	Part of Language packages 1 - 2
[2]	Francais	Part of Language package 1
[3]	Dansk	Part of Language package 1
[4]	Spanish	Part of Language package 1
[5]	Italiano	Part of Language package 1
[6]	Svenska	Part of Language package 1
[7]	Nederlands	Part of Language package 1
[10]	Chinese	Language package 2
[20]	Suomi	Part of Language package 1
[22]	English US	Part of Language package 1
[27]	Greek	Part of Language package 1
[28]	Bras.port	Part of Language package 1
[36]	Slovenian	Part of Language package 1
[39]	Korean	Part of Language package 2
[40]	Japanese	Part of Language package 2
[41]	Turkish	Part of Language package 1
[42]	Trad.Chinese	Part of Language package 2
[43]	Bulgarian	Part of Language package 1
[44]	Srpski	Part of Language package 1
[45]	Romanian	Part of Language package 1
[46]	Magyar	Part of Language package 1
[47]	Czech	Part of Language package 1
[48]	Polski	Part of Language package 1
[49]	Russian	Part of Language package 1
[50]	Thai	Part of Language package 2
[51]	Bahasa Indonesia	Part of Language package 2

0-01 Language		
Option:	Function:	
[52]	Hrvatski	Part of Language package 2

0-02 Motor Speed Unit		
Option:	Function:	
		<p>NOTICE</p> <p>This parameter cannot be adjusted while the motor is running.</p> <p>The information shown in the display depends on settings in <i>parameter 0-02 Motor Speed Unit</i> and <i>parameter 0-03 Regional Settings</i>. The default settings of <i>parameter 0-02 Motor Speed Unit</i> and <i>parameter 0-03 Regional Settings</i> depend on to which region of the world the frequency converter is supplied. It can be reprogrammed as required.</p> <p>NOTICE</p> <p>Changing the motor speed unit resets certain parameters to their initial value. Select the motor speed unit before modifying other parameters.</p>
[0]	RPM	Selects display of motor speed variables and parameters (that is references, feedbacks, and limits) in terms of motor speed (RPM).
[1] *	Hz	Selects display of motor speed variables and parameters (that is references, feedbacks, and limits) in terms of output frequency to the motor (Hz).

0-03 Regional Settings		
Option:	Function:	
		<p>WARNING</p> <p>This parameter cannot be adjusted while the motor is running.</p> <p>The display showing depends on the settings in <i>parameter 0-02 Motor Speed Unit</i> and <i>parameter 0-03 Regional Settings</i>. The default settings of <i>parameter 0-02 Motor Speed Unit</i> and <i>parameter 0-03 Regional Settings</i> depends on which region of the world the frequency converter is supplied to, but can be re-programmed as required.</p> <p>The settings not used are made invisible.</p>
[0]	International	Sets <i>parameter 1-20 Motor Power [kW]</i> units to [kW] and the default value of <i>parameter 1-23 Motor Frequency</i> [50 Hz].
[1]	North America	Sets <i>parameter 1-21 Motor Power [HP]</i> units to [hp] and the default value of <i>parameter 1-23 Motor Frequency</i> to 60 Hz.

0-04 Operating State at Power-up		
Option:	Function:	
		Select the operating mode upon reconnection of the frequency converter to mains voltage after power-down when operating in Hand (local) mode.
[0] *	Resume	Resumes operation of the frequency converter maintaining the same local reference and the same start/stop condition (applied by [Hand On]/[Off] on the LCP or Hand Start via a digital input as before the frequency converter was powered down.
[1]	Forced stop, ref=old	Stops the frequency converter, but at the same time retains the local speed reference before power-down in the memory. After mains voltage is reconnected and after receiving a start command (pressing [Hand On] or Hand Start command via a digital input), the frequency converter restarts and operates at the retained speed reference.

3.2.2 0-1* Set-up Operations

Define and control the individual parameter set-ups. The frequency converter has 4 parameter set-ups that can be programmed independently of each other. This makes the frequency converter very flexible and able to meet the requirements of many different HVAC system control schemes, often saving the cost of external control equipment. For example, these can be used to program the frequency converter to operate according to 1 control scheme in 1 set-up (for example daytime operation) and another control scheme in another set-up (for example night set back). Alternatively, they can be used by an AHU or packaged unit OEM to identically program all their factory fitted frequency converters for different equipment models within a range to have the same parameters, and then during production/commissioning simply select a specific set-up depending on which model within that range the frequency converter is installed on.

The active set-up (that is the set-up in which the frequency converter is currently operating) can be selected in *parameter 0-10 Active Set-up* and is displayed in the LCP. Using *[9] Multi set-up* it is possible to switch between set-ups with the frequency converter running or stopped, via digital input or serial communication commands (for example for night set back). If it is necessary to change setups while running, ensure that *parameter 0-12 This Set-up Linked to* is programmed as required. For most HVAC applications it is not necessary to program *parameter 0-12 This Set-up Linked to* even if change of set up while running is required, but for very complex applications, using the full flexibility of the multiple set-ups, it may be required. Using *parameter 0-11 Programming Set-up* it is possible to edit parameters within any of the set-ups while continuing the frequency converter

operation in its active set-up which can be a different set-up to the one being edited. Using *parameter 0-51 Set-up Copy* it is possible to copy parameter settings between the set-ups to enable quicker commissioning if similar parameter settings are required in different set-ups. If a set-up is changed via a fieldbus, it takes up to 5 s before the new values are reflected via the fieldbus.

0-10 Active Set-up		
Option:	Function:	
		Select the set-up in which the frequency converter is to operate. Use <i>parameter 0-51 Set-up Copy</i> to copy a set-up to 1 or all other set-ups. To avoid conflicting settings of the same parameter within 2 different set-ups, link the set-ups using <i>parameter 0-12 This Set-up Linked to</i> . Stop the frequency converter before switching between set-ups where parameters marked <i>not changeable during operation</i> have different values. Parameters which are <i>not changeable during operation</i> are marked FALSE in <i>chapter 5 Parameter Lists</i> .
[0]	Factory setup	Cannot be changed. It contains the Danfoss data set, and can be used as a data source when returning the other set-ups to a known state.
[1] *	Set-up 1	<i>[1] Set-up 1 to [4] Set-up 4</i> are the 4 parameter set-ups within which all parameters can be programmed.
[2]	Set-up 2	
[3]	Set-up 3	
[4]	Set-up 4	
[9]	Multi Set-up	Is used for remote selection of set-ups using digital inputs and the serial communication port. This set-up uses the settings from <i>parameter 0-12 This Set-up Linked to</i> .

0-11 Programming Set-up		
Option:	Function:	
		Select the set-up to be edited (that is programmed) during operation; either the active set-up or 1 of the inactive set-ups. The set-up number being edited is displayed in the LCP in brackets.
[0]	Factory setup	Cannot be edited, but it is useful as a data source to return the other set-ups to a known state.
[1]	Set-up 1	[1] Set-up 1 to [4] Set-up 4 can be edited freely during operation, independently of the active set-up.
[2]	Set-up 2	
[3]	Set-up 3	
[4]	Set-up 4	
[9] *	Active Set-up	(I.e. the set-up in which the frequency converter is operating) can also be edited during operation. Editing parameters in the selected set-up would normally be done from the LCP, but it is also possible from any of the serial communication ports.

0-12 This Set-up Linked to		
Option:	Function:	
		This parameter only needs to be programmed if changing set-ups is required while the motor is running. It ensures that parameters which are 'not changeable during operation' have the same setting in all relevant set-ups.
		To enable conflict-free changes from 1 set-up to another while the frequency converter is running, link set-ups containing parameters which are not changeable during operation. The link ensures synchronising of the <i>not changeable during operation</i> parameter values when moving from 1 set-up to another during operation. <i>Not changeable during operation</i> parameters can be identified by the label FALSE in the parameter lists in <i>chapter 5 Parameter Lists</i> .
		The <i>parameter 0-12 This Set-up Linked to</i> feature is used when [9] <i>Multi set-up</i> in <i>parameter 0-10 Active Set-up</i> is selected. [9] <i>Multi set-up</i> can be used to move from 1 set-up to another during operation while the motor runs. example: Use [9] <i>Multi set-up</i> to shift from set-up 1 to set-up 2 while the motor runs. Programme parameters in set-up 1 first, then ensure that set-up 1 and set-up 2 are synchronised (or linked). Synchronisation can be performed in 2 ways:

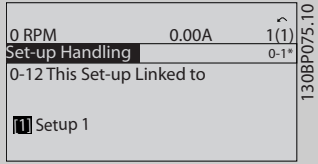
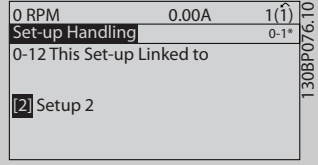
0-12 This Set-up Linked to		
Option:	Function:	
		<ul style="list-style-type: none"> Change the edit set-up to [2] Set-up 2 in <i>parameter 0-11 Programming Set-up</i> and set <i>parameter 0-12 This Set-up Linked to</i> to [1] Set-up 1. This starts the linking (synchronising) process.
		 <p>130BP07/5.10</p> <p>Illustration 3.1 Set-up Handling</p>
		OR
		<ul style="list-style-type: none"> While still in set-up 1, using <i>parameter 0-50 LCP Copy</i>, copy set-up 1 to set-up 2. Then set <i>parameter 0-12 This Set-up Linked to</i> to [2] Set-up 2. This starts the linking process.
		 <p>130BP07/6.10</p> <p>Illustration 3.2 Set-up Handling</p>
		After the link is complete, <i>parameter 0-13 Readout: Linked Set-ups</i> reads set-ups 1 and 2 to indicate that all <i>not changeable during operation</i> parameters are now the same in set-up 1 and set-up 2. If there are changes to a <i>not changeable during operation</i> parameter, for example <i>parameter 1-30 Stator Resistance (Rs)</i> , in set-up 2, they are also changed automatically in set-up 1. A switch between set-up 1 and set-up 2 during operation is now possible.
[0] *	Not linked	
[1]	Set-up 1	
[2]	Set-up 2	
[3]	Set-up 3	
[4]	Set-up 4	

0-13 Readout: Linked Set-ups														
Range:	Function:													
0* [0 - 255]	View a list of all the set-ups linked by means of <i>parameter 0-12 This Set-up Linked to</i> . The parameter has 1 index for each parameter set-up. The parameter value displayed for each index represents which set-ups are linked to that parameter set-up.													
	<table border="1"> <thead> <tr> <th>Index</th> <th>LCP value</th> </tr> </thead> <tbody> <tr> <td>0</td> <td>{0}</td> </tr> <tr> <td>1</td> <td>{1,2}</td> </tr> <tr> <td>2</td> <td>{1,2}</td> </tr> <tr> <td>3</td> <td>{3}</td> </tr> <tr> <td>4</td> <td>{4}</td> </tr> </tbody> </table>	Index	LCP value	0	{0}	1	{1,2}	2	{1,2}	3	{3}	4	{4}	
Index	LCP value													
0	{0}													
1	{1,2}													
2	{1,2}													
3	{3}													
4	{4}													
	Table 3.2 Example: Set-up 1 and Set-up 2 are linked													

0-14 Readout: Prog. Set-ups / Channel		
Range:	Function:	
0* [-2147483648 - 2147483647]	View the setting of <i>parameter 0-11 Programming Set-up</i> for each of the 4 different communication channels. When the number is displayed in hex, as it is in the LCP, each number represents 1 channel. Numbers 1-4 represent a set-up number; F means factory setting, and A means active set-up. The channels are, from right to left: LCP, FC-bus, USB, HPFB1.5. Example: The number AAAAAA21h means that the FC-bus selected set-up 2 in <i>parameter 0-11 Programming Set-up</i> , the LCP selected set-up 1, and all others used the active set-up.	

3.2.3 0-2* LCP Display

Define the variables displayed in the LCP.

NOTICE

For information on how to write display texts, refer to

- *Parameter 0-37 Display Text 1*
- *Parameter 0-38 Display Text 2*
- *Parameter 0-39 Display Text 3*

0-20 Display Line 1.1 Small		
Option:	Function:	
		Select a variable for display in line 1, left position.
[0]	None	No display value selected

0-20 Display Line 1.1 Small		
Option:	Function:	
[37]	Display Text 1	Enables an individual text string to be written, for display in the LCP, or to be read via serial communication.
[38]	Display Text 2	Enables an individual text string to be written, for display in the LCP, or to be read via serial communication.
[39]	Display Text 3	Enables an individual text string to be written, for display in the LCP, or to be read via serial communication.
[89]	Date and Time Readout	Displays the current date and time.
[953]	Profibus Warning Word	Displays Profibus communication warnings.
[1005]	Readout Transmit Error Counter	View the number of CAN control transmission errors since the last power-up.
[1006]	Readout Receive Error Counter	View the number of CAN control receipt errors since the last power-up.
[1007]	Readout Bus Off Counter	View the number of bus off-events since the last power-up.
[1013]	Warning Parameter	View a DeviceNet-specific warning word. 1 separate bit is assigned to every warning.
[1115]	LON Warning Word	Shows the LON-specific warnings.
[1117]	XIF Revision	Shows the version of the external interface file of the Neuron C chip on the LON option.
[1118]	LonWorks Revision	Shows the software version of the application program of the Neuron C chip on the LON option.
[1230]	Warning Parameter	
[1397]	Alert Alarm Word	
[1398]	Alert Warning Word	
[1399]	Alert Status Word	
[1501]	Running Hours	View the number of running hours of the motor.
[1502]	kWh Counter	View the mains power consumption in kWh.
[1580]	Fan Running Hours	
[1600]	Control Word	View the control word sent from the frequency converter via the serial communication port in hex code.

0-20 Display Line 1.1 Small		
Option:	Function:	
[1601]	Reference [Unit]	Total reference (sum of digital/analog/preset/bus/freeze ref./catch up and slow-down) in selected unit.
[1602] *	Reference [%]	Total reference (sum of digital/analog/preset/bus/freeze ref./catch up and slow-down) in percent.
[1603]	Status Word	Present status word
[1605]	Main Actual Value [%]	View the 2-byte word sent with the status word to the bus master reporting the main actual value.
[1609]	Custom Readout	View the user-defined readouts as defined in <ul style="list-style-type: none"> Parameter 0-30 Custom Readout Unit, Parameter 0-31 Custom Readout Min Value, Parameter 0-32 Custom Readout Max Value.
[1610]	Power [kW]	Actual power consumed by the motor in kW.
[1611]	Power [hp]	Actual power consumed by the motor in hp.
[1612]	Motor Voltage	Voltage supplied to the motor.
[1613]	Frequency	Motor frequency, that is the output frequency from the frequency converter in Hz.
[1614]	Motor current	Phase current of the motor measured as effective value.
[1615]	Frequency [%]	Motor frequency, that is the output frequency from the frequency converter in percent.
[1616]	Torque [Nm]	Present motor load as a percentage of the rated motor torque.
[1617]	Speed [RPM]	Motor speed reference. Actual speed depends on slip compensation being used (compensation set in <i>parameter 1-62 Slip Compensation</i>). If not used, actual speed is the value read in the display minus motor slip.
[1618]	Motor Thermal	Thermal load on the motor, calculated by the ETR function. See also parameter group <i>1-9* Motor Temperature</i> .
[1620]	Motor Angle	
[1622]	Torque [%]	Shows the actual torque produced, in percentage.
[1623]	Motor Shaft Power [kW]	

0-20 Display Line 1.1 Small		
Option:	Function:	
[1624]	Calibrated Stator Resistance	
[1626]	Power Filtered [kW]	
[1627]	Power Filtered [hp]	
[1630]	DC Link Voltage	Intermediate circuit voltage in the frequency converter.
[1632]	Brake Energy /s	Present brake power transferred to an external brake resistor. Stated as an instantaneous value.
[1633]	Brake Energy Average	Brake power transferred to an external brake resistor. The mean power is calculated continuously for the most recent 120 s.
[1634]	Heatsink Temp.	Present heat sink temperature of the frequency converter. The cut-out limit is 95 ± 5 °C; cutting back in occurs at 70 ± 5 °C.
[1635]	Inverter Thermal	Percentage load of the inverters.
[1636]	Inv. Nom. Current	Nominal current of the frequency converter.
[1637]	Inv. Max. Current	Maximum current of the frequency converter.
[1638]	SL Controller State	State of the event executed by the control.
[1639]	Control Card Temp.	Temperature of the control card.
[1643]	Timed Actions Status	See parameter group <i>23-0* Timed Actions</i> .
[1650]	External Reference	Sum of the external reference as a percentage, that is the sum of analog/pulse/bus.
[1652]	Feedback[Unit]	Reference value from programmed digital input(s).
[1653]	Digi Pot Reference	View the contribution of the digital potentiometer to the actual reference feedback.
[1654]	Feedback 1 [Unit]	View the value of feedback 1. See also parameter group <i>20-0* FC Closed Loop</i> .
[1655]	Feedback 2 [Unit]	View the value of feedback 2. See also parameter group <i>20-0* FC Closed Loop</i> .
[1656]	Feedback 3 [Unit]	View the value of feedback 3. See also parameter group <i>20-0* FC Closed Loop</i> .
[1658]	PID Output [%]	Returns the drive closed loop PID controller output value in percent.
[1660]	Digital Input	Displays the status of the digital inputs. Signal low=0; Signal high=1.

0-20 Display Line 1.1 Small		
Option:	Function:	
		Regarding order, see <i>parameter 16-60 Digital Input</i> . Bit 0 is at the extreme right.
[1661]	Terminal 53 Switch Setting	Setting of input terminal 53. Current=0; Voltage=1.
[1662]	Analog Input 53	Actual value at input 53 either as a reference or protection value.
[1663]	Terminal 54 Switch Setting	Setting of input terminal 54. Current=0; Voltage=1.
[1664]	Analog Input 54	Actual value at input 54 either as reference or protection value.
[1665]	Analog Output 42 [mA]	Actual value at output 42 in mA. Use <i>parameter 6-50 Terminal 42 Output</i> to select the variable to be represented by output 42.
[1666]	Digital Output [bin]	Binary value of all digital outputs.
[1667]	Pulse Input #29 [Hz]	Actual value of the frequency applied at terminal 29 as a pulse input.
[1668]	Pulse Input #33 [Hz]	Actual value of the frequency applied at terminal 33 as a pulse input.
[1669]	Pulse Output #27 [Hz]	Actual value of pulses applied to terminal 27 in digital output mode.
[1670]	Pulse Output #29 [Hz]	Actual value of pulses applied to terminal 29 in digital output mode.
[1671]	Relay Output [bin]	View the setting of all relays.
[1672]	Counter A	View the present value of counter A.
[1673]	Counter B	View the present value of counter B.
[1675]	Analog In X30/11	Actual value of the signal on input X30/11 (general purpose I/O card. Optional).
[1676]	Analog In X30/12	Actual value of the signal on input X30/12 (general purpose I/O card. Optional).
[1677]	Analog Out X30/8 [mA]	Actual value at output X30/8 (general purpose I/O card. Optional). Use <i>parameter 6-60 Terminal X30/8 Output</i> to select the variable to be shown.
[1678]	Analog Out X45/1 [mA]	
[1679]	Analog Out X45/3 [mA]	
[1680]	Fieldbus CTW 1	Control word (CTW) received from the bus master.
[1682]	Fieldbus REF 1	Main reference value sent with control word via the serial communications

0-20 Display Line 1.1 Small		
Option:	Function:	
		network, for example from the BMS, PLC, or other master controller.
[1684]	Comm. Option STW	Extended fieldbus communication option status word.
[1685]	FC Port CTW 1	Control word (CTW) received from the bus master.
[1686]	FC Port REF 1	Status word (STW) sent to the bus master.
[1690]	Alarm Word	1 or more alarms in a hex code (used for serial communications).
[1691]	Alarm Word 2	1 or more alarms in a hex code (used for serial communications).
[1692]	Warning Word	1 or more warnings in a hex code (used for serial communications).
[1693]	Warning Word 2	1 or more warnings in a hex code (used for serial communications).
[1694]	Ext. Status Word	1 or more status conditions in a hex code (used for serial communications).
[1695]	Ext. Status Word 2	1 or more status conditions in a hex code (used for serial communications).
[1696]	Maintenance Word	The bits reflect the status for the programmed preventive maintenance events in parameter group 23-1* <i>Maintenance</i>
[1830]	Analog Input X42/1	Shows the value of the signal applied to terminal X42/1 on the analog I/O card.
[1831]	Analog Input X42/3	Shows the value of the signal applied to terminal X42/3 on the analog I/O card.
[1832]	Analog Input X42/5	Shows the value of the signal applied to terminal X42/5 on the analog I/O card.
[1833]	Analog Out X42/7 [V]	Shows the value of the signal applied to terminal X42/7 on the analog I/O card.
[1834]	Analog Out X42/9 [V]	Shows the value of the signal applied to terminal X42/9 on the analog I/O card.
[1835]	Analog Out X42/11 [V]	Shows the value of the signal applied to terminal X42/11 on the analog I/O card.
[1836]	Analog Input X48/2 [mA]	
[1837]	Temp. Input X48/4	
[1838]	Temp. Input X48/7	

0-20 Display Line 1.1 Small		
Option:	Function:	
[1839]	Temp. Input X48/10	
[1850]	Sensorless Readout [unit]	
[1860]	Digital Input 2	
[2117]	Ext. 1 Reference [Unit]	The value of the reference for extended closed loop controller 1
[2118]	Ext. 1 Feedback [Unit]	The value of the feedback signal for extended closed loop controller 1
[2119]	Ext. 1 Output [%]	The value of the output from extended closed loop controller 1
[2137]	Ext. 2 Reference [Unit]	The value of the reference for extended closed loop controller 2
[2138]	Ext. 2 Feedback [Unit]	The value of the feedback signal for extended closed loop controller 2
[2139]	Ext. 2 Output [%]	The value of the output from extended closed loop controller 2
[2157]	Ext. 3 Reference [Unit]	The value of the reference for extended closed loop controller 3
[2158]	Ext. 3 Feedback [Unit]	The value of the feedback signal for extended closed loop controller 3
[2159]	Ext. 3 Output [%]	The value of the output from extended closed loop controller 3
[2230]	No-Flow Power	The calculated no-flow power for the actual operating speed
[2316]	Maintenance Text	
[2580]	Cascade Status	Status for the operation of the cascade controller
[2581]	Pump Status	Status for the operation of each individual pump controlled by the cascade controller
[3110]	Bypass Status Word	
[3111]	Bypass Running Hours	
[9913]	Idle time	
[9914]	Paramdb requests in queue	
[9920]	HS Temp. (PC1)	
[9921]	HS Temp. (PC2)	
[9922]	HS Temp. (PC3)	
[9923]	HS Temp. (PC4)	
[9924]	HS Temp. (PC5)	
[9925]	HS Temp. (PC6)	
[9926]	HS Temp. (PC7)	
[9927]	HS Temp. (PC8)	
[9951]	PC Debug 0	

0-20 Display Line 1.1 Small		
Option:	Function:	
[9952]	PC Debug 1	
[9953]	PC Debug 2	
[9954]	PC Debug 3	
[9955]	PC Debug 4	
[9956]	Fan 1 Feedback	
[9957]	Fan 2 Feedback	
[9958]	PC Auxiliary Temp	
[9959]	Power Card Temp.	

0-21 Display Line 1.2 Small

Select a variable for display in line 1, middle position.

Option:	Function:	
[1614] *	Motor Current	The options are the same as those listed in <i>parameter 0-20 Display Line 1.1 Small</i> .

0-22 Display Line 1.3 Small

Select a variable for display in line 1, right position.

Option:	Function:	
[1610] *	Power [kW]	The options are the same as those listed in <i>parameter 0-20 Display Line 1.1 Small</i> .

0-23 Display Line 2 Large

Select a variable for display in line 2.

Option:	Function:	
[1613] *	Frequency	The options are the same as those listed in <i>parameter 0-20 Display Line 1.1 Small</i> .

0-24 Display Line 3 Large

Select a variable for display in line 3.

0-25 My Personal Menu

Array [20]

Range:	Function:	
Size related* [0 - 9999]	<p>Define up to 20 parameters to appear in the Q1 Personal Menu, accessible via the [Quick Menu] key on the LCP. The parameters will be displayed in the Q1 Personal Menu in the order they are programmed into this array parameter. Delete parameters by setting the value to '0000'.</p> <p>For example, this can be used to provide quick, simple access to just 1 or up to 20 parameters which require changing on a regular basis (e.g. for plant maintenance reasons) or by an OEM to enable simple commissioning of their equipment.</p>	

3.2.4 0-3* LCP Custom Readout

It is possible to customise the display elements for various purposes:

- Custom Readout. Value proportional to speed (linear, squared or cubed depending on unit selected in *parameter 0-30 Custom Readout Unit*).
- Display Text. Text string stored in a parameter.

Custom readout

The calculated value to be displayed is based on the settings in:

- *Parameter 0-30 Custom Readout Unit.*
- *Parameter 0-31 Custom Readout Min Value* (linear only).
- *Parameter 0-32 Custom Readout Max Value.*
- *Parameter 4-13 Motor Speed High Limit [RPM].*
- *Parameter 4-14 Motor Speed High Limit [Hz]*
- Actual speed.

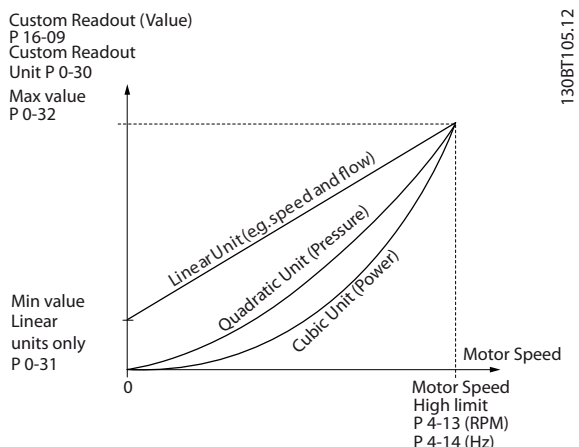

Illustration 3.3 Custom Readout

The relation depends on the type of unit selected in *parameter 0-30 Custom Readout Unit*:

Unit type	Speed relation
Dimensionless	Linear
Speed	
Flow, volume	
Flow, mass	
Velocity	
Length	
Temperature	
Pressure	Quadratic
Power	Cubic

Table 3.3 Speed Relations for Different Unit Types

0-30 Custom Readout Unit		
Option:	Function:	
		Programme a value to be shown in the LCP display. The value has a linear, squared or cubed relation to speed. This relation depends on the unit selected (see Table 3.3). The actual calculated value can be read in <i>parameter 16-09 Custom Readout</i> , and/or shown in the display by selecting [1609 Custom Readout] in <i>parameter 0-20 Display Line 1.1 Small</i> to <i>0-24 Display Line 3 Large</i> .
[0]	None	
[1] *	%	
[5]	PPM	
[10]	1/min	
[11]	RPM	
[12]	Pulse/s	
[20]	l/s	
[21]	l/min	
[22]	l/h	
[23]	m ³ /s	
[24]	m ³ /min	
[25]	m ³ /h	
[30]	kg/s	
[31]	kg/min	
[32]	kg/h	
[33]	t/min	
[34]	t/h	
[40]	m/s	
[41]	m/min	
[45]	m	
[60]	°C	
[70]	mbar	
[71]	bar	
[72]	Pa	
[73]	kPa	
[74]	m WG	
[75]	mm Hg	
[80]	kW	
[120]	GPM	
[121]	gal/s	
[122]	gal/min	
[123]	gal/h	
[124]	CFM	
[125]	ft ³ /s	
[126]	ft ³ /min	
[127]	ft ³ /h	
[130]	lb/s	
[131]	lb/min	
[132]	lb/h	
[140]	ft/s	
[141]	ft/min	
[145]	ft	
[160]	°F	
[170]	psi	

0-30 Custom Readout Unit		
Option:	Function:	
[171]	lb/in ²	
[172]	in WG	
[173]	ft WG	
[174]	in Hg	
[180]	HP	

0-31 Custom Readout Min Value		
Range:	Function:	
Size related* [-999999.99 - 100.00 CustomReadoutUnit]	This parameter allows selection of the minimum value of the custom-defined readout (occurs at zero speed). It is only possible to select a value different to 0 when selecting a linear unit in <i>parameter 0-30 Custom Readout Unit</i> . For quadratic and cubic units the minimum value is 0.	

0-32 Custom Readout Max Value		
Range:	Function:	
100 Custom-ReadoutUnit* [par. 0-31 - 999999.99 CustomReadoutUnit]	This parameter sets the max. value to be shown when the speed of the motor has reached the set value for <i>parameter 4-13 Motor Speed High Limit [RPM]</i> or <i>parameter 4-14 Motor Speed High Limit [Hz]</i> (depends on setting in <i>parameter 0-02 Motor Speed Unit</i>).	

0-37 Display Text 1		
Range:	Function:	
0* [0 - 25]	<p>In this parameter, it is possible to write an individual text string for display in the LCP or to be read via serial communication. If to be displayed permanently, select [37] <i>Display Text 1</i> in</p> <ul style="list-style-type: none"> • <i>Parameter 0-20 Display Line 1.1 Small</i> • <i>0-21 Display Line 1.2 Small</i> • <i>0-22 Display Line 1.3 Small</i> • <i>0-23 Display Line 2 Large</i> • <i>0-24 Display Line 3 Large</i> • <i>Parameter 0-37 Display Text 1</i> <p>is linked to <i>12-08 Host Name</i>. Changing <i>12-08 Host Name</i> changes <i>Parameter 0-37 Display Text 1</i> - but not vice versa.</p>	

0-38 Display Text 2		
Range:	Function:	
0* [0 - 25]	<p>In this parameter, it is possible to write an individual text string for display in the LCP, or to be read via serial communication. If to be displayed permanently, select [38] <i>Display Text 2</i> in:</p> <ul style="list-style-type: none"> • <i>Parameter 0-20 Display Line 1.1 Small</i> • <i>0-21 Display Line 1.2 Small</i> • <i>0-22 Display Line 1.3 Small</i> • <i>0-23 Display Line 2 Large</i> • <i>0-24 Display Line 3 Large</i> <p>Press [▲] or [▼] to change a character. Press [◀] and [▶] to move the cursor. When a character is highlighted by the cursor, this character can be changed. A character can be inserted by placing the cursor between 2 characters and pressing [▲] or [▼].</p>	

0-39 Display Text 3		
Range:	Function:	
0* [0 - 25]	<p>In this parameter it is possible to write an individual text string for display in the LCP or to be read via serial communication. If to be displayed permanently select <i>Display Text 3</i> in <i>parameter 0-20 Display Line 1.1 Small</i>, <i>0-21 Display Line 1.2 Small</i>, <i>0-22 Display Line 1.3 Small</i>, <i>0-23 Display Line 2 Large</i> or <i>0-24 Display Line 3 Large</i>. Press [▲] or [▼] to change a character. Press [◀] and [▶] to move the cursor. When a character is highlighted by the cursor, this character can be changed. A character can be inserted by placing the cursor between 2 characters and pressing [▲] or [▼].</p>	

3.2.5 0-4* LCP Keypad

Enable, disable and password protect individual keys on the LCP.

0-40 [Hand on] Key on LCP		
Option:	Function:	
[0]	Disabled	Avoid accidental usage of the key.
[1] *	Enabled	[Hand On] key enabled.
[2]	Password	Avoid unauthorised start in Hand mode. If <i>parameter 0-40 [Hand on] Key on LCP</i> is included in <i>My Personal Menu</i> , define the password in <i>parameter 0-65 Personal Menu Password</i> . Otherwise, define the password in <i>parameter 0-60 Main Menu Password</i> .

0-41 [Off] Key on LCP		
Option:	Function:	
[0]	Disabled	Key disabled avoids accidental usage of the key.
[1] *	Enabled	[Off] key is enabled.
[2]	Password	Avoid unauthorised stop. If <i>parameter 0-41 [Off] Key on LCP</i> is included in <i>My Personal Menu</i> , define the password in <i>parameter 0-65 Personal Menu Password</i> . Otherwise, define the password in <i>parameter 0-60 Main Menu Password</i> .

0-42 [Auto on] Key on LCP		
Option:	Function:	
[0]	Disabled	Key disabled avoids accidental usage of the [Auto On] key.
[1] *	Enabled	[Auto On] key is enabled.
[2]	Password	Avoid unauthorised start in Auto mode. If <i>parameter 0-42 [Auto on] Key on LCP</i> is included in <i>My Personal Menu</i> , define the password in <i>parameter 0-65 Personal Menu Password</i> . Otherwise, define the password in <i>parameter 0-60 Main Menu Password</i> .

0-43 [Reset] Key on LCP		
Option:	Function:	
[0]	Disabled	Key disabled avoids accidental usage of the [Reset] key.
[1] *	Enabled	[Reset] key is enabled.
[2]	Password	Avoid unauthorised resetting. If <i>parameter 0-43 [Reset] Key on LCP</i> is included in <i>parameter 0-25 My Personal Menu</i> , define the password in <i>parameter 0-65 Personal Menu Password</i> . Otherwise, define the password in <i>parameter 0-60 Main Menu Password</i> .
[3]	Enabled without OFF	
[4]	Password without OFF	
[5]	Enabled with OFF	Pressing the key resets the frequency converter, but does not start it.
[6]	Password with OFF	Prevents unauthorised reset. Upon authorised reset, the frequency converter does not start. See option [2] <i>Password</i> for information on how to set the password.

3.2.6 0-5* Copy/Save

Copy parameters from and to the LCP. Use these parameters for saving and copying set-ups from 1 frequency converter to another.

0-50 LCP Copy		
Option:	Function:	
[0] *	No copy	No function.
[1]	All to LCP	Copies all parameters in all set-ups from the frequency converter memory to the LCP memory. For service purposes it is recommended to copy all parameters to the LCP after commissioning.
[2]	All from LCP	Copies all parameters in all set-ups from the LCP memory to the frequency converter memory.
[3]	Size indep. from LCP	Copies only the parameters that are independent of the motor size. The latest selection can be used to programme several frequency converters with the same function without disturbing motor data which are already set.
[10]	Delete LCP copy data	

0-51 Set-up Copy		
Option:	Function:	
[0] *	No copy	No function.
[1]	Copy to set-up 1	Copies all parameters in the present programming set-up (defined in <i>parameter 0-11 Programming Set-up</i>) to set-up 1.
[2]	Copy to set-up 2	Copies all parameters in the present programming set-up (defined in <i>parameter 0-11 Programming Set-up</i>) to set-up 2.
[3]	Copy to set-up 3	Copies all parameters in the present programming set-up (defined in <i>parameter 0-11 Programming Set-up</i>) to set-up 3.
[4]	Copy to set-up 4	Copies all parameters in the present programming set-up (defined in <i>parameter 0-11 Programming Set-up</i>) to set-up 4.
[9]	Copy to all	Copies the parameters in the present set-up to each of the set-ups 1 to 4.

3.2.7 0-6* Password

0-60 Main Menu Password		
Range:	Function:	
100*	[-9999 - 9999]	Define the password for access to the Main Menu via the [Main Menu] key. If <i>parameter 0-61 Access to Main Menu w/o Password</i> is set to [0] <i>Full access</i> , this parameter is ignored.

0-61 Access to Main Menu w/o Password		
Option:	Function:	
[0] *	Full access	Disables password defined in <i>parameter 0-60 Main Menu Password</i> .
[1]	LCP: Read only	Prevents unauthorised editing of Main Menu parameters.
[2]	LCP: No access	Prevents unauthorised viewing and editing of Main Menu parameters.
[3]	Bus: Read only	
[4]	Bus: No access	
[5]	All: Read only	
[6]	All: No access	

If [0] Full access is selected, *parameter 0-60 Main Menu Password*, *parameter 0-65 Personal Menu Password*, and *parameter 0-66 Access to Personal Menu w/o Password* are ignored.

0-65 Personal Menu Password		
Range:	Function:	
200*	[-9999 - 9999]	Define the password for access to My Personal Menu via the [Quick Menu] key. If <i>parameter 0-66 Access to Personal Menu w/o Password</i> is set to [0] Full access, this parameter is ignored.

0-66 Access to Personal Menu w/o Password		
Option:	Function:	
[0] *	Full access	Disables password defined in <i>parameter 0-65 Personal Menu Password</i> .
[1]	LCP: Read only	Prevents unauthorised editing of <i>My Personal Menu</i> -parameters.
[2]	LCP: No access	Prevents unauthorised viewing and editing of <i>My Personal Menu</i> -parameters.
[3]	Bus: Read only	
[4]	Bus: No access	
[5]	All: Read only	
[6]	All: No access	

If *parameter 0-61 Access to Main Menu w/o Password* is set to [0] Full access, this parameter is ignored.

0-67 Bus Password Access		
Range:	Function:	
0*	[0 - 9999]	Use this parameter to unlock the frequency converter via fieldbus or MCT 10 Set-up Software.

3.2.8 0-7* Clock Settings

Set the time and date of the internal clock. The internal clock can be used for for example timed actions, energy log, trend analysis, date/time stamps on alarms, logged data, and preventive maintenance.

It is possible to program the clock for daylight saving time/summertime, weekly working days/non-working days including 20 exceptions (holidays etc.). Although the clock settings can be set via the LCP, they can also be set along with timed actions and preventative maintenance functions using the MCT 10 software tool.

NOTICE

The frequency converter has no back-up of the clock function and the set date/time resets to default (2000-01-01 00:00) after a power-down unless a real time clock-module with back-up is installed. If no module with back up is installed, only use the clock function if the frequency converter is integrated into the BMS using serial communications, with the BMS maintaining synchronisation of control equipment clock times. In *parameter 0-79 Clock Fault* it is possible to program for a warning if in case the clock has not been set properly, for example after a power down.

NOTICE

If mounting an analog I/O MCB 109 option card, a battery back-up of the date and time is included.

0-70 Date and Time		
Range:	Function:	
Size related*	[0 - 0]	Sets the date and time of the internal clock. The format to be used is set in <i>parameter 0-71 Date Format</i> and <i>parameter 0-72 Time Format</i> .

0-71 Date Format		
Option:	Function:	
		Sets the date format to be used in the LCP.
[0]	YYYY-MM-DD	
[1]	DD-MM-YYYY	
[2]	MM/DD/YYYY	

0-72 Time Format		
Option:	Function:	
		Sets the time format to be used in the LCP.
[0]	24 h	
[1]	12 h	

0-74 DST/Summertime		
Option:	Function:	
		Select how daylight saving time/summertime should be handled. For manual setting of DST/summertime, enter the start date and end date in <i>parameter 0-76 DST/Summertime Start</i> and <i>parameter 0-77 DST/Summertime End</i> .
[0] *	Off	
[2]	Manual	

0-76 DST/Summertime Start		
Range:	Function:	
Size related*	[0 - 0]	Sets the date and time when DST/summertime starts. The date is programmed in the format selected in <i>parameter 0-71 Date Format</i> .

0-77 DST/Summertime End		
Range:	Function:	
Size related*	[0 - 0]	Sets the date and time when DST/summertime ends. The date is programmed in the format selected in <i>parameter 0-71 Date Format</i> .

0-79 Clock Fault		
Option:	Function:	
		Enables or disables the clock warning when the clock has not been set, or has been reset due to a power-down and no back-up is installed. If MCB 109 is installed, [1] <i>Enabled</i> is default.
[0]	Disabled	
[1]	Enabled	

0-81 Working Days		
Array with 7 elements [0] - [6] displayed below the parameter number in the display. Press [OK] and step between elements with [▲] and [▼].		
Option:	Function:	
		Set for each weekday if it is a working day or a non-working day. First element of the array is Monday. The working days are used for timed actions.
[0]	No	
[1]	Yes	

0-82 Additional Working Days		
Array with 5 elements [0] - [4] displayed below the parameter number in the display. Press [OK] and step between elements with [▲] and [▼].		
Range:	Function:	
Size related*	[0 - 0]	Defines dates for additional working days that would normally be non-working days according to <i>parameter 0-81 Working Days</i> .

0-83 Additional Non-Working Days		
Array with 15 elements [0] - [14] displayed below the parameter number in the display. Press [OK] and step between elements with [▲] and [▼].		
Range:	Function:	
Size related*	[0 - 0]	Defines dates for additional working days that would normally be non-working days according to <i>parameter 0-81 Working Days</i> .

0-89 Date and Time Readout		
Range:	Function:	
0*	[0 - 25]	Displays the current date and time. The date and time is updated continuously. The clock does not begin counting until a setting different from default has been made in <i>parameter 0-70 Date and Time</i> .

3.3 Parameters: 1-** Load and Motor

3.3.1 1-0* General Settings

Define whether the frequency converter operates in open loop or closed loop.

1-00 Configuration Mode		
Option:	Function:	
	<p>NOTICE</p> <p>This parameter cannot be adjusted while the motor is running.</p> <p>NOTICE</p> <p>When set for closed loop, the commands reversing and start reversing do not reverse the motor direction.</p>	
[0]	Open Loop	<p>Motor speed is determined by applying a speed reference or by setting desired speed when in <i>Hand mode</i>.</p> <p>Open loop is also used if the frequency converter is part of a closed-loop control system based on an external PID controller providing a speed reference signal as output.</p>
[3]	Closed Loop	<p>Motor speed is determined by a reference from the built-in PID controller varying the motor speed as of a closed-loop control process (for example, constant pressure or flow). Configure the PID controller in parameter group 20-** <i>Feedback</i> or via the <i>Function Set-ups</i> accessed by pressing [Quick Menu].</p>

1-03 Torque Characteristics		
Option:	Function:	
[0]	Compressor torque	For speed control of screw and scroll compressors. Provides a voltage which is optimised for a constant torque load characteristic of the motor in the entire range down to 10 Hz.
[1]	Variable torque	For speed control of centrifugal pumps and fans. Also to be used when controlling more than 1 motor from the same frequency converter (for example, multiple condenser fans or cooling tower fans). Provides a voltage which is optimised for a squared torque load characteristic of the motor.
[2]	Auto Energy Optim. CT	For optimum energy-efficient speed control of screw and scroll compressors. Provides a voltage which is optimised for a constant torque load characteristic of the motor in the entire range down to 15 Hz. In addition, the AEO feature adapts the voltage exactly to the current load situation, thereby reducing

1-03 Torque Characteristics		
Option:	Function:	
		<p>energy consumption and audible noise from the motor. To obtain optimum performance, set the motor power factor cos phi correctly. This value is set in <i>parameter 14-43 Motor Cosphi</i>. The parameter has a default value which is automatically adjusted when the motor data is programmed. These settings ensure optimum motor voltage. If the motor power factor cos phi requires tuning, an AMA function can be carried out using <i>parameter 1-29 Automatic Motor Adaptation (AMA)</i>. It is rarely necessary to adjust the motor power factor parameter manually.</p>
[3]	Auto Energy Optim. VT	<p>For optimum energy-efficient speed control of centrifugal pumps and fans. Provides a voltage optimised for a squared torque load characteristic of the motor. In addition, the AEO feature adapts the voltage exactly to the current load situation, thereby reducing energy consumption and audible noise from the motor. To obtain optimum performance, set the motor power factor cos phi correctly. This value is set in <i>parameter 14-43 Motor Cosphi</i>. The parameter has a default value and is automatically adjusted when the motor data is programmed. These settings ensure optimum motor voltage. If the motor power factor cos phi requires tuning, an AMA function can be carried out using <i>parameter 1-29 Automatic Motor Adaptation (AMA)</i>. It is rarely necessary to adjust the motor power factor parameter manually.</p>

1-06 Clockwise Direction		
Option:	Function:	
		<p>NOTICE</p> <p>This parameter cannot be adjusted while the motor is running.</p> <p>This parameter defines the term <i>clockwise</i> corresponding to the LCP direction arrow. Used for easy change of direction of shaft rotation without swapping motor wires.</p>
[0]	* Normal	The motor shaft turns in clockwise direction when the frequency converter is connected U→U, V→V, and W→W to the motor.
[1]	Inverse	Motor shaft turns in counterclockwise direction when the frequency converter is connected U→U, V→V, and W→W to the motor.

3.3.2 1-10 - 1-13 Motor Selection

NOTICE

This parameter group cannot be adjusted while the motor is running.

The following parameters are active ('x') depending on the setting of *parameter 1-10 Motor Construction*

<i>Parameter 1-10 Motor Construction</i>	[0] Asynchron	[1] PM Motor non salient
<i>Parameter 1-00 Configuration Mode</i>	x	x
<i>Parameter 1-03 Torque Characteristics</i>	x	
<i>1-06 Clockwise Direction</i>	x	x
<i>Parameter 1-14 Damping Gain</i>		x
<i>Parameter 1-15 Low Speed Filter Time Const.</i>		x
<i>Parameter 1-16 High Speed Filter Time Const.</i>		x
<i>Parameter 1-17 Voltage filter time const.</i>		x
<i>Parameter 1-20 Motor Power [kW]</i>	x	
<i>Parameter 1-21 Motor Power [HP]</i>	x	
<i>Parameter 1-22 Motor Voltage</i>	x	
<i>Parameter 1-23 Motor Frequency</i>	x	
<i>Parameter 1-24 Motor Current</i>	x	x
<i>Parameter 1-25 Motor Nominal Speed</i>	x	x
<i>Parameter 1-26 Motor Cont. Rated Torque</i>		x
<i>Parameter 1-28 Motor Rotation Check</i>	x	x
<i>Parameter 1-29 Automatic Motor Adaptation (AMA)</i>	x	
<i>Parameter 1-30 Stator Resistance (Rs)</i>	x	x
<i>1-31 Rotor Resistance (Rr)</i>	x	
<i>Parameter 1-35 Main Reactance (Xh)</i>	x	
<i>Parameter 1-37 d-axis Inductance (Ld)</i>		x
<i>Parameter 1-39 Motor Poles</i>	x	x
<i>Parameter 1-40 Back EMF at 1000 RPM</i>		x
<i>Parameter 1-50 Motor Magnetisation at Zero Speed</i>	x	
<i>Parameter 1-51 Min Speed Normal Magnetising [RPM]</i>	x	
<i>Parameter 1-52 Min Speed Normal Magnetising [Hz]</i>	x	
<i>Parameter 1-58 Flying Start Test Pulses Current</i>	x	x
<i>Parameter 1-59 Flying Start Test Pulses Frequency</i>	x	x

<i>Parameter 1-10 Motor Construction</i>	[0] Asynchron	[1] PM Motor non salient
<i>Parameter 1-60 Low Speed Load Compensation</i>	x	
<i>Parameter 1-61 High Speed Load Compensation</i>	x	
<i>Parameter 1-62 Slip Compensation</i>	x	
<i>Parameter 1-63 Slip Compensation Time Constant</i>	x	
<i>Parameter 1-64 Resonance Dampening</i>	x	
<i>Parameter 1-65 Resonance Dampening Time Constant</i>	x	
<i>Parameter 1-66 Min. Current at Low Speed</i>		x
<i>Parameter 1-70 PM Start Mode</i>		x
<i>Parameter 1-71 Start Delay</i>	x	x
<i>Parameter 1-72 Start Function</i>	x	x
<i>Parameter 1-73 Flying Start</i>	x	x
<i>Parameter 1-77 Compressor Start Max Speed [RPM]</i>	x	
<i>Parameter 1-78 Compressor Start Max Speed [Hz]</i>	x	
<i>Parameter 1-79 Compressor Start Max Time to Trip</i>	x	
<i>Parameter 1-80 Function at Stop</i>	x	x
<i>Parameter 1-81 Min Speed for Function at Stop [RPM]</i>	x	x
<i>Parameter 1-82 Min Speed for Function at Stop [Hz]</i>	x	x
<i>Parameter 1-86 Trip Speed Low [RPM]</i>	x	x
<i>Parameter 1-87 Trip Speed Low [Hz]</i>	x	x
<i>Parameter 1-90 Motor Thermal Protection</i>	x	x
<i>Parameter 1-91 Motor External Fan</i>	x	x
<i>Parameter 1-93 Thermistor Source</i>	x	x
<i>Parameter 2-00 DC Hold/Preheat Current</i>	x	
<i>Parameter 2-01 DC Brake Current</i>	x	x
<i>Parameter 2-02 DC Braking Time</i>	x	
<i>Parameter 2-03 DC Brake Cut In Speed [RPM]</i>	x	
<i>Parameter 2-04 DC Brake Cut In Speed [Hz]</i>	x	
<i>Parameter 2-06 Parking Current</i>		x
<i>Parameter 2-07 Parking Time</i>		x
<i>Parameter 2-10 Brake Function</i>	x	x
<i>Parameter 2-11 Brake Resistor (ohm)</i>	x	x
<i>Parameter 2-12 Brake Power Limit (kW)</i>	x	x
<i>Parameter 2-13 Brake Power Monitoring</i>	x	x
<i>Parameter 2-15 Brake Check</i>	x	x
<i>2-16 AC brake Max. Current</i>	x	

Parameter 1-10 Motor Construction	[0] Asynchron	[1] PM Motor non salient
Parameter 2-17 Over-voltage Control	x	
Parameter 4-10 Motor Speed Direction	x	x
Parameter 4-11 Motor Speed Low Limit [RPM]	x	x
Parameter 4-12 Motor Speed Low Limit [Hz]	x	x
Parameter 4-13 Motor Speed High Limit [RPM]	x	x
Parameter 4-14 Motor Speed High Limit [Hz]	x	x
Parameter 4-16 Torque Limit Motor Mode	x	x
Parameter 4-17 Torque Limit Generator Mode	x	x
Parameter 4-18 Current Limit	x	x
Parameter 4-19 Max Output Frequency	x	x
4-58 Missing Motor Phase Function	x	
Parameter 14-40 VT Level	x	
Parameter 14-41 AEO Minimum Magnetisation	x	
Parameter 14-42 Minimum AEO Frequency	x	
Parameter 14-43 Motor Cosphi	x	

Table 3.4 Motor Selection Parameter

3.3.3 SynRM Motor Set-up with VVC+

This section describes how to set up a SynRM motor with VVC+.

NOTICE

The SmartStart wizard covers the basic configuration of SynRM motors.

Initial programming steps

To activate SynRM motor operation, select [5] *Sync. Reluctance* in 1-10 Motor Construction.

Programming motor data

After performing the initial programming steps, the SynRM motor-related parameters in parameter groups 1-2* *Motor Data*, 1-3* *Adv. Motor Data*, and 1-4* *Adv. Motor Data II* are active. Use the motor nameplate data and the motor datasheet to programme the following parameters in the order listed:

- 1-23 Motor Frequency.
- 1-24 Motor Current.
- 1-25 Motor Nominal Speed.
- 1-26 Motor Cont. Rated Torque.

Run a complete AMA using 1-29 *Automatic Motor Adaptation (AMA)* [1] *Enable Complete AMA* or enter the following parameters manually:

- 1-30 Stator Resistance (Rs).
- 1-37 d-axis Inductance (Ld).
- 1-44 d-axis Inductance Sat. (LdSat).
- 1-45 q-axis Inductance Sat. (LqSat).
- 1-48 Inductance Sat. Point.

Application-specific adjustments

Start the motor at nominal speed. If the application does not run well, check the VVC+ SynRM settings. Table 3.5 provides application-specific recommendations:

Application	Settings
Low-inertia applications $I_{Load}/I_{Motor} < 5$	Increase parameter 1-17 <i>Voltage filter time const.</i> by factor 5 to 10. Reduce parameter 1-14 <i>Damping Gain</i> . Reduce parameter 1-66 <i>Min. Current at Low Speed (<100%)</i> .
Low-inertia applications $50 > I_{Load}/I_{Motor} > 5$	Keep the default values.
High-inertia applications $I_{Load}/I_{Motor} > 50$	Increase parameter 1-14 <i>Damping Gain</i> , 1-15 <i>Low Speed Filter Time Const.</i> , and 1-16 <i>High Speed Filter Time Const.</i>
High-load at low speed <30% (rated speed)	Increase parameter 1-17 <i>Voltage filter time const.</i> Increase parameter 1-66 <i>Min. Current at Low Speed</i> to adjust the starting torque. 100% current provides nominal torque as starting torque. This parameter is independent of 30-20 <i>High Starting Torque Time [s]</i> and 30-21 <i>High Starting Torque Current [%]</i> . Working at a current level higher than 100% for a prolonged time can cause the motor to overheat.
Dynamic applications	Increase 14-41 <i>AEO Minimum Magnetisation</i> for highly dynamic applications. Adjusting 14-41 <i>AEO Minimum Magnetisation</i> ensures a good balance between energy efficiency and dynamics. Adjust 14-42 <i>Minimum AEO Frequency</i> to specify the minimum frequency at which the frequency converter should use minimum magnetisation.
Motor sizes less than 18 kW	Avoid short ramp-down times.

Table 3.5 Recommendations for Various Applications

If the motor starts oscillating at a certain speed, increase 1-14 *Damping Gain*. Increase the damping gain value in

small steps. Depending on the motor, this parameter can be set to 10–100% higher than the default value.

1-10 Motor Construction	
Select the motor construction type.	
Option:	Function:
[0] * Asynchron	For asynchronous motors.
[1] PM, non salient SPM	Use for non-salient PM motors.
[5] Sync. Reluctance	Use for synchronous reluctance motors. NOTICE This option has the following firmware version limitations: <ul style="list-style-type: none"> Version 4.2x and earlier – do not use this option. There is a risk of damage to the frequency converter. Version 4.3x – use this option only when flying start is enabled in parameter <i>parameter 1-73 Flying Start</i>.

3.3.4 1-14 to 1-17 VVC+ PM

The default control parameters for VVC+ PM motor control core are optimised for HVAC applications and inertia load in the range of $50 > J_l/J_m > 5$, where J_l is load inertia from the application and J_m is machine inertia.

For low inertia applications ($J_l/J_m < 5$), it is recommended that *1-17 Voltage filter time const.* is increased with a factor of 5–10 and, in some cases, *14-08 Damping Gain Factor* should also be reduced to improve performance and stability.

For high inertia applications ($J_l/J_m > 50$), it is recommended that *1-15 Low Speed Filter Time Const.*, *1-16 High Speed Filter Time Const.*, and *14-08 Damping Gain Factor* are increased to improve performance and stability.

For high load at low speed (<30% of rated speed), it is recommended that *1-17 Voltage filter time const.* is increased due to non-linearity in the inverter at low speed.

1-14 Damping Gain	
Range:	Function:
120 %* [0 - 250 %]	The damping gain stabilises the PM machine in order to run the PM machine smooth and stable. The value of damping gain controls the dynamic performance of the PM machine. High damping gain gives low dynamic performance, and low damping gain gives high dynamic performance. The dynamic performance is related to the machine data and load type. If the damping gain is too high or low, the control becomes unstable.

1-15 Low Speed Filter Time Const.	
Range:	Function:
Size related* [0.01 - 20 s]	High-pass filter damping time constant determines the response time to load steps. Obtain quick control through a short damping time constant. However, if this value is too low, the control becomes unstable. This time constant is used below 10% rated speed.

1-16 High Speed Filter Time Const.	
Range:	Function:
Size related* [0.01 - 20 s]	High-pass filter damping time constant determines the response time to load steps. Obtain quick control through a short damping time constant. However, if this value is too low, the control becomes unstable. This time constant is used above 10% rated speed.

1-17 Voltage filter time const.	
Range:	Function:
Size related* [0.001 - 1 s]	Machine supply voltage filter time constant is used for reducing the influence of high-frequency ripples and system resonances in the calculation of machine supply voltage. Without this filter, the ripples in the currents can distort the calculated voltage and affect the stability of the system.

3.3.5 1-2* Motor Data

This parameter group contains input data from the nameplate on the connected motor.

NOTICE

Changing the value of these parameters affects the setting of other parameters.

NOTICE

Parameter 1-20 Motor Power [kW], parameter 1-21 Motor Power [HP], parameter 1-22 Motor Voltage, and parameter 1-23 Motor Frequency have no effect when *parameter 1-10 Motor Construction* is set to [1] PM, non-salient SPM, [2] PM, salient IPM, [5] Sync. Reluctance.

1-20 Motor Power [kW]		
Range:		Function:
Size related*	[0.09 - 3000.00 kW]	Enter the nominal motor power in kW according to the motor nameplate data. The default value corresponds to the nominal rated output of the unit. Depending on the selections made in <i>parameter 0-03 Regional Settings</i> , either <i>parameter 1-20 Motor Power [kW]</i> or <i>parameter 1-21 Motor Power [HP]</i> is made invisible.

1-21 Motor Power [HP]		
Range:		Function:
Size related*	[0.09 - 3000.00 hp]	Enter the nominal motor power in hp according to the motor nameplate data. The default value corresponds to the nominal rated output of the unit. Depending on the selections made in <i>parameter 0-03 Regional Settings</i> , either <i>parameter 1-20 Motor Power [kW]</i> or <i>parameter 1-21 Motor Power [HP]</i> is made invisible.

1-22 Motor Voltage		
Range:		Function:
Size related*	[10 - 1000 V]	Enter the nominal motor voltage according to the motor nameplate data. The default value corresponds to the nominal rated output of the frequency converter.

1-23 Motor Frequency		
Range:		Function:
Size related*	[20 - 1000 Hz]	Select the motor frequency value from the motor nameplate data. For 87 Hz operation with 230/400 V motors, set the nameplate data for 230 V/50 Hz. Adapt <i>parameter 4-13 Motor Speed High Limit [RPM]</i> and <i>3-03 Maximum Reference</i> to the 87 Hz application.

1-24 Motor Current		
Range:		Function:
Size related*	[0.10 - 10000.00 A]	Enter the nominal motor current value from the motor nameplate data. The data are used for calculating motor torque, thermal motor protection and so on.

1-25 Motor Nominal Speed		
Range:		Function:
Size related*	[100 - 60000 RPM]	Enter the nominal motor speed value from the motor nameplate data. The data are used for calculating automatic motor compensations.

1-26 Motor Cont. Rated Torque		
Range:		Function:
Size related*	[0.1 - 10000 Nm]	Enter the value from the motor nameplate data. The default value corresponds to the nominal rated output. This parameter is available when <i>parameter 1-10 Motor Construction</i> is set to [1] PM, non-salient SPM, that is the parameter is valid for PM and non-salient SPM motors only.

1-28 Motor Rotation Check		
Option:	Function:	
	<p>⚠ WARNING</p> <p>Remove mains power before disconnecting motor phase cables.</p> <p>NOTICE</p> <p>Once the motor rotation check is enabled the display shows: <i>Note! Motor may run in wrong direction.</i> Pressing [OK], [Back] or [Cancel] dismisses the message and displays a new message: Press [Hand On] to start the motor. Press [Cancel] to abort. Pressing [Hand On] starts the motor at 5 Hz in forward direction and the display shows: <i>Motor is running.</i> Check if motor rotation direction is correct. Press [Off] to stop the motor. Pressing [Off] stops the motor and resets <i>parameter 1-28 Motor Rotation Check</i>. If motor rotation direction is incorrect, interchange 2 motor phase cables.</p> <p>Following installation and connection of the motor, this function allows the correct motor rotation direction to be verified. Enabling this function overrides any bus commands or digital inputs, except external interlock and Safe Torque Off (STO) (if included).</p>	
[0]	Off	Motor rotation check is not active.
*		
[1]	Enabled	Motor rotation check is enabled.

1-29 Automatic Motor Adaptation (AMA)		
Option:	Function:	
		NOTICE This parameter cannot be adjusted while the motor is running. The AMA function optimises dynamic motor performance by automatically optimising the advanced motor parameters (1-30 Stator Resistance (R_s) to 1-35 Main Reactance (X_h)) at motor standstill.
[0] *	Off	No function.
[1]	Enable Complete AMA	Performs AMA of the stator resistance R_s , the rotor resistance R_r , the stator leakage reactance X_1 , the rotor leakage reactance X_2 and the main reactance X_h .
[2]	Enable Reduced AMA	Performs a reduced AMA of the stator resistance R_s in the system only. Select this option if an LC filter is used between the frequency converter and the motor.

Activate the AMA function by pressing [Hand On] after selecting [1] Enable complete AMA or [2] Enable reduced AMA. See also the section Automatic Motor Adaptation in the design guide. After a normal sequence, the display reads: Press [OK] to finish AMA. After pressing [OK], the frequency converter is ready for operation.

NOTICE

- For the best adaptation of the frequency converter, run AMA on a cold motor.
- AMA cannot be performed while the motor is running.

NOTICE

Avoid generating external torque during AMA.

NOTICE

If one of the settings in parameter group 1-2* Motor Data is changed, parameter 1-30 Stator Resistance (R_s) to parameter 1-39 Motor Poles return to default settings.

NOTICE

Only run complete AMA without filter, and only run reduced AMA with filter.

See section: Application Examples > Automatic Motor Adaptation in the design guide.

3.3.6 1-3* Adv. Motor Data

Parameters for advanced motor data. The motor data in parameter 1-30 Stator Resistance (R_s) to parameter 1-39 Motor Poles must match the relevant motor to run the motor optimally. The default settings are figures based on common motor parameter values from normal standard motors. If the motor parameters are not set correctly, a malfunction of the frequency converter system may occur. If the motor data is not known, running an AMA (automatic motor adaptation) is recommended. See the Automatic Motor Adaptation section. The AMA sequence adjusts all motor parameters except the moment of inertia of the rotor and the iron loss resistance (parameter 1-36 Iron Loss Resistance (R_{fe})).

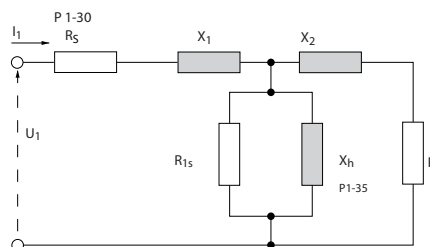
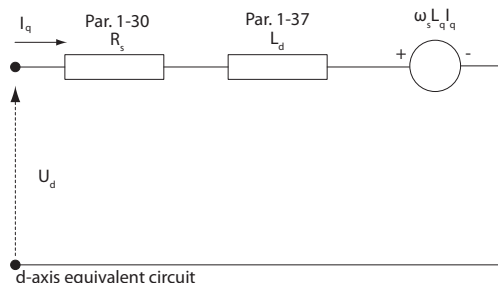
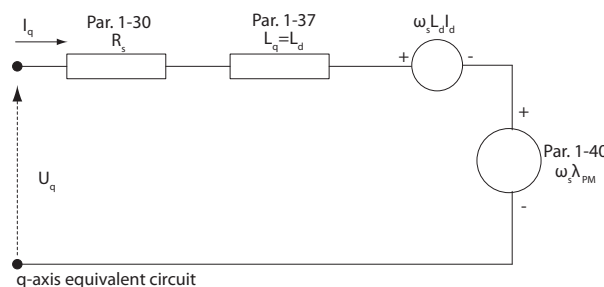

Illustration 3.4 Motor Equivalent Diagram for an Asynchronous Motor



d-axis equivalent circuit



q-axis equivalent circuit

Illustration 3.5 Motor Equivalent Circuit Diagram for a PM Non-salient Motor

1-30 Stator Resistance (Rs)		
Range:		Function:
Size related*	[0.0140 - 140.0000 Ohm]	Set the stator resistance value. Enter the value from a motor data sheet or perform an AMA on a cold motor.

1-31 Rotor Resistance (Rr)		
Range:		Function:
Size related*	[0.0100 - 100.0000 Ohm]	Fine-tuning R _r will improve shaft performance. Set the rotor resistance value using one of these methods: <ol style="list-style-type: none"> Run an AMA on a cold motor. The frequency converter will measure the value from the motor. All compensations are reset to 100%. Enter the R_r value manually. Obtain the value from the motor supplier. Use the R_r default setting. The frequency converter establishes the setting on the basis of the motor nameplate data.

1-35 Main Reactance (Xh)		
Range:		Function:
Size related*	[1.0000 - 10000.0000 Ohm]	<p>NOTICE</p> <p>Parameter 1-35 Main Reactance (Xh) does not have effect when parameter 1-10 Motor Construction=[1] PM, non salient SPM.</p> <p>Set the main reactance of the motor using 1 of these methods:</p> <ul style="list-style-type: none"> Run an AMA on a cold motor. The frequency converter measures the value from the motor. Enter the X_h value manually. Obtain the value from the motor supplier. Use the X_h default setting. The frequency converter establishes the setting on the basis of the motor name plate data.

1-36 Iron Loss Resistance (Rfe)		
Range:		Function:
Size related*	[0 - 10000.000 Ohm]	<p>NOTICE</p> <p>This parameter cannot be adjusted while the motor is running.</p> <p>Enter the equivalent iron-loss resistance (R_{Fe}) value to compensate for iron losses in the motor. The R_{Fe} value cannot be found by performing an AMA. The R_{Fe} value is especially important in torque control applications. If R_{Fe} is unknown, leave <i>parameter 1-36 Iron Loss Resistance (Rfe)</i> on default setting.</p>

1-37 d-axis Inductance (Ld)		
Range:		Function:
Size related*	[0.000 - 1000.000 mH]	<p>NOTICE</p> <p>This parameter is only active when parameter 1-10 Motor Construction is set to [1] PM, non-salient SPM.</p> <p>Enter the value of the d-axis inductance. Obtain the value from the PM motor data sheet.</p>

For asynchronous motor, stator resistance and d-axis inductance values are normally, described in technical specifications as between line and common (starpoint). For PM motors, they are typically described in technical specifications as between line-line. PM motors are typically built for star connection.

Parameter 1-30 Stator Resistance (Rs) (Line to common)	This parameter gives stator winding resistance (R _s) similar to asynchronous motor stator resistance. The stator resistance is defined for line-to-common measurement. For line-line data, where stator resistance is measured between any 2 lines, divide by 2.
Parameter 1-37 d-axis Inductance (Ld) (Line to common)	This parameter gives direct axis inductance of the PM motor. The d-axis inductance is defined for phase-to-common measurement. For line-line data, where stator resistance is measured between any 2 lines, divide by 2.

Parameter 1-40 Back EMF at 1000 RPM RMS (Line to Line Value)	This parameter gives back EMF across stator terminal of PM Motor at 1000 RPM mechanical speed specifically. It is defined between line-to-line and expressed in RMS value.
---	--

Table 3.6 Parameters Related to PM Motors

NOTICE

Motor manufacturers provide values for stator resistance (parameter 1-30 Stator Resistance (Rs)) and d-axis inductance (parameter 1-37 d-axis Inductance (Ld)) in technical specifications as between line and common (starpoint) or between line-line. There is no general standard. The different set-ups of stator winding resistance and induction are shown in *Illustration 3.6*. Danfoss frequency converters always require the line to common value. The back EMF of a PM motor is defined as induced EMF developed across any of 2 phases of stator winding of free-running Motor-Danfoss frequency converters always require the line to line RMS value measured at 1000 RPM, mechanical speed of rotation. This is shown in *Illustration 3.7*.

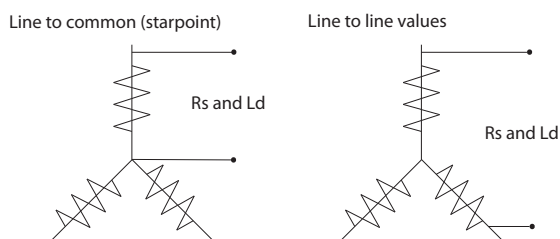

Illustration 3.6 Stator Winding Set-Ups

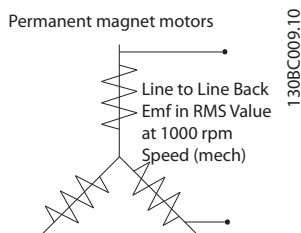

Illustration 3.7 Machine Parameter Definitions of Back EMF of PM Motors

1-39 Motor Poles														
Range:	Function:													
Size related* [2 - 100]	NOTICE This parameter cannot be adjusted while the motor is running. Enter the number of motor poles.													
	<table border="1"> <thead> <tr> <th>Poles</th> <th>~n_n@ 50 Hz</th> <th>~n_n@ 60 Hz</th> </tr> </thead> <tbody> <tr> <td>2</td> <td>2700-2880</td> <td>3250-3460</td> </tr> <tr> <td>4</td> <td>1350-1450</td> <td>1625-1730</td> </tr> <tr> <td>6</td> <td>700-960</td> <td>840-1153</td> </tr> </tbody> </table>	Poles	~n _n @ 50 Hz	~n _n @ 60 Hz	2	2700-2880	3250-3460	4	1350-1450	1625-1730	6	700-960	840-1153	
Poles	~n _n @ 50 Hz	~n _n @ 60 Hz												
2	2700-2880	3250-3460												
4	1350-1450	1625-1730												
6	700-960	840-1153												
	<p>Table 3.7 Pole Counts and Related Frequencies</p> <p>Table 3.7 shows the number of poles for normal speed ranges of various motor types. Define motors designed for other frequencies separately. The motor pole value is always an even number, because it refers to the total number of poles, not pairs of poles. The frequency converter creates the initial setting of parameter 1-39 Motor Poles based on parameter 1-23 Motor Frequency and parameter 1-25 Motor Nominal Speed.</p>													

1-40 Back EMF at 1000 RPM		
Range:	Function:	
Size related* [10 - 9000 V]	Set the nominal back EMF for the motor when running at 1000 RPM. This parameter is only active when parameter 1-10 Motor Construction is set to [1] PM, non salient SPM.	

1-46 Position Detection Gain		
Range:	Function:	
100 %* [20 - 200 %]	Adjusts the amplitude of the test pulse during position detection at start. Adjust this parameter to improve the position measurement.	

3.3.7 1-5* Load Indep. Setting

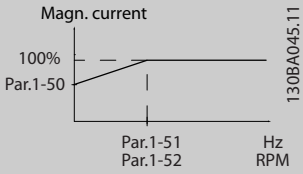
1-50 Motor Magnetisation at Zero Speed		
This parameter is not visible on the LCP.		
Range:	Function:	
100 %*	[0 - 300 %]	<p>NOTICE</p> <p><i>Parameter 1-50 Motor Magnetisation at Zero Speed has no effect when parameter 1-10 Motor Construction=[1] PM, non-salient SPM.</i></p> <p>Use this parameter along with parameter 1-51 Min Speed Normal Magnetising [RPM] to obtain a different thermal load on the motor when running at low speed. Enter a value which is a percentage of the rated magnetising current. If the setting is too low, the torque on the motor shaft may be reduced.</p>  <p>Illustration 3.8 Motor Magnetisation</p>

1-51 Min Speed Normal Magnetising [RPM]		
This parameter is not visible on the LCP.		
Range:	Function:	
Size related*	[10 - 300 RPM]	<p>NOTICE</p> <p><i>Parameter 1-51 Min Speed Normal Magnetising [RPM] has no effect when parameter 1-10 Motor Construction=[1] PM, non-salient SPM.</i></p> <p>Set the required speed for normal magnetising current. If the speed is set lower than the motor slip speed, parameter 1-50 Motor Magnetisation at Zero Speed and parameter 1-51 Min Speed Normal Magnetising [RPM] are of no significance. Use this parameter along with parameter 1-50 Motor Magnetisation at Zero Speed. See Table 3.7.</p>

1-52 Min Speed Normal Magnetising [Hz]		
This parameter is not visible on the LCP.		
Range:	Function:	
Size related*	[0.3 - 10.0 Hz]	<p>NOTICE</p> <p><i>Parameter 1-52 Min Speed Normal Magnetising [Hz] will not have effect when parameter 1-10 Motor Construction=[1] PM, non-salient SPM.</i></p> <p>Set the required frequency for normal magnetising current. If the frequency is set lower than the motor slip frequency, parameter 1-50 Motor Magnetisation at Zero Speed and parameter 1-51 Min Speed Normal Magnetising [RPM] are inactive. Use this parameter along with parameter 1-50 Motor Magnetisation at Zero Speed. See Table 3.7.</p>

1-58 Flying Start Test Pulses Current		
Range:	Function:	
Size related*	[0 - 200 %]	<p>Set the magnitude of the magnetising current for the pulses used to detect the motor direction. Higher values result in more accurate results when the frequency converter is oversized compared to the motor. The value range and function depend on parameter 1-10 Motor Construction: [0] Asynchron: [0-200%] Reducing this value reduces the generated torque. 100% means full nominal motor current. In this case, the default value is 30%. [1] PM non salient: [0-40%] A general setting of 20% is recommended on PM motors. Higher values can give increased performance. However, on motors with back EMF higher than 300 VLL (rms) at nominal speed and high winding inductance (more than 10 mH) a lower value is recommended to avoid wrong speed estimation. The parameter is active when parameter 1-73 Flying Start is enabled.</p>

1-59 Flying Start Test Pulses Frequency		
Range:	Function:	
Size related*	[0 - 500 %]	<p>NOTICE</p> <p><i>See description of parameter 1-70 PM Start Mode for an overview of the relation between the PM Flying Start parameters.</i></p> <p>The parameter is active when parameter 1-73 Flying Start is enabled. The</p>

1-59 Flying Start Test Pulses Frequency	
Range:	Function:
	<p>value range and function depends on <i>parameter 1-10 Motor Construction</i>: [0] Asynchron: [0-500%] Control the percentage of the frequency for the pulses used to detect the motor direction. Increasing this value reduces the generated torque. In this mode, 100% means 2 times the slip frequency. [1] PM non salient: [0-10%] This parameter defines the motor speed (in % of nominal motor speed) below which the parking function (see <i>parameter 2-06 Parking Current</i> and <i>parameter 2-07 Parking Time</i> becomes active. This parameter is only active when <i>parameter 1-70 PM Start Mode</i> is set to [1] <i>Parking</i> and only after starting the motor.</p>

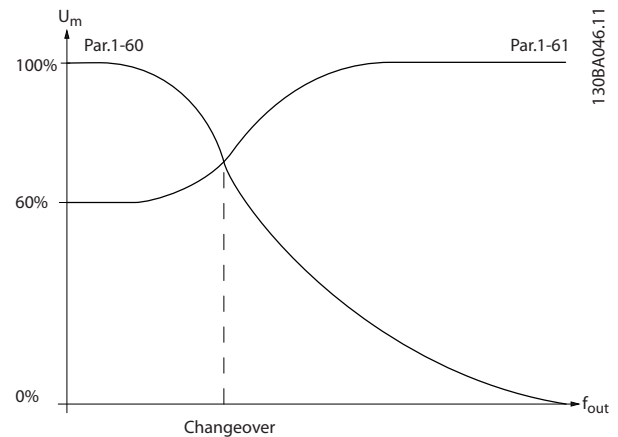

Illustration 3.9 Low Speed Load Compensation

3.3.8 1-6* Load Depend. Setting

1-60 Low Speed Load Compensation									
This parameter is not visible on the LCP.									
Range:	Function:								
100 %* [0 - 300 %]	<p>NOTICE <i>Parameter 1-60 Low Speed Load Compensation</i> not have effect when <i>parameter 1-10 Motor Construction</i>=[1] PM, non-salient SPM.</p> <p>Enter the % value to compensate voltage in relation to load when the motor is running at low speed, and obtain the optimum U/f characteristic. The motor size determines the frequency range within which this parameter is active.</p> <table border="1"> <thead> <tr> <th>Motor size [kW]</th> <th>Change-over [Hz]</th> </tr> </thead> <tbody> <tr> <td>0.25-7.5</td> <td><10</td> </tr> <tr> <td>11-45</td> <td><5</td> </tr> <tr> <td>55-550</td> <td><3-4</td> </tr> </tbody> </table> <p>Table 3.8 Low Speed Load Compensation</p>	Motor size [kW]	Change-over [Hz]	0.25-7.5	<10	11-45	<5	55-550	<3-4
Motor size [kW]	Change-over [Hz]								
0.25-7.5	<10								
11-45	<5								
55-550	<3-4								

1-61 High Speed Load Compensation					
This parameter is not visible on the LCP.					
Range:	Function:				
100 %* [0 - 300 %]	<p>NOTICE <i>Parameter 1-61 High Speed Load Compensation</i> does not have effect when <i>parameter 1-10 Motor Construction</i>=[1] PM, non-salient SPM.</p> <p>Enter the % value to compensate voltage in relation to load when the motor is running at high speed, and obtain the optimum U/f characteristic. The motor size determines the frequency range within which this parameter is active.</p> <table border="1"> <thead> <tr> <th>Motor size</th> <th>Change-over</th> </tr> </thead> <tbody> <tr> <td>1.1-7.5 kW</td> <td>> 10 Hz</td> </tr> </tbody> </table>	Motor size	Change-over	1.1-7.5 kW	> 10 Hz
Motor size	Change-over				
1.1-7.5 kW	> 10 Hz				

1-62 Slip Compensation	
Range:	Function:
0 %* [-500 - 500 %]	<p>NOTICE <i>Parameter 1-62 Slip Compensation</i> does not have effect when <i>parameter 1-10 Motor Construction</i>=[1] PM, non-salient SPM.</p> <p>Enter the % value for slip compensation, to compensate for tolerances in the value of $n_{M,N}$. Slip compensation is calculated automatically, that is on the basis of the rated motor speed $n_{M,N}$.</p>

1-63 Slip Compensation Time Constant		
Range:		Function:
Size related*	[0.05 - 5 s]	<p>NOTICE</p> <p><i>Parameter 1-63 Slip Compensation Time Constant has no effect when parameter 1-10 Motor Construction=[1] PM, non-salient SPM.</i></p> <p>Enter the slip compensation reaction speed. A high value results in slow reaction, and a low value results in quick reaction. If low-frequency resonance problems arise, use a longer time setting.</p>

1-64 Resonance Dampening		
Range:		Function:
100 %*	[0 - 500 %]	<p>NOTICE</p> <p><i>Parameter 1-64 Resonance Dampening has no effect when parameter 1-10 Motor Construction=[1] PM, non-salient SPM.</i></p> <p>Enter the resonance damping value. Set parameter 1-64 Resonance Dampening and parameter 1-65 Resonance Dampening Time Constant to help eliminate high frequency resonance problems. To reduce resonance oscillation, increase the value of parameter 1-64 Resonance Dampening.</p>

1-65 Resonance Dampening Time Constant		
Range:		Function:
5 ms*	[5 - 50 ms]	<p>NOTICE</p> <p><i>Parameter 1-65 Resonance Dampening Time Constant has no effect when parameter 1-10 Motor Construction=[1] PM, non-salient SPM.</i></p> <p>Set parameter 1-64 Resonance Dampening and parameter 1-65 Resonance Dampening Time Constant to help eliminate high frequency resonance problems. Enter the time constant that provides the best dampening.</p>

1-66 Min. Current at Low Speed		
Range:		Function:
Size related*	[1 - 200 %]	<p>NOTICE</p> <p><i>Parameter 1-66 Min. Current at Low Speed does not have effect if parameter 1-10 Motor Construction=[0] Asynchron</i></p> <p>Enter the minimum motor current at low speed.</p>

1-66 Min. Current at Low Speed		
Range:		Function:
		Increasing this current improves developed motor torque at low speed. Low speed is here defined as speeds below 6% of the nominal motor speed (parameter 1-25 Motor Nominal Speed) in VVC+ PM Control.

3.3.9 1-7* Start Adjustments

1-70 PM Start Mode		
Option:		Function:
[0]	Rotor Detection	Suitable for all applications where the motor is known to be standing still when starting (for example conveyors, pumps, and non-wind milling fans).
[1] *	Parking	If the motor turns at a low speed (that is lower than 2-5% of the nominal speed), for example due to fans with light wind milling, select [1] Parking and adjust parameter 2-06 Parking Current and parameter 2-07 Parking Time accordingly.

1-71 Start Delay		
Range:		Function:
00 s*	[0 - 120 s]	Enter the time delay between the start command and the time when the frequency converter supplies the power to the motor. This parameter is related to the start function selected in 1-72 Start Function.

1-72 Start Function		
Option:		Function:
		Select the start function during the start delay. This parameter is linked to parameter 1-71 Start Delay.
[0]	DC Hold/ Motor Preheat	Energizes motor with a DC holding current (parameter 2-00 DC Hold/Preheat Current) during the start delay time.
[2]	Coast	Releases shaft coasted converter during the start delay time (inverter off). Available selections depend on parameter 1-10 Motor Construction: [0] Asynchron: [2] Coast [0] DC-hold [1] PM non-salient: [2] coast

1-73 Flying Start		
Option:	Function:	
		This function enables catching a motor which is spinning freely due to a mains drop-out. When <i>parameter 1-73 Flying Start</i> is enabled, <i>parameter 1-71 Start Delay</i> has no function. Search direction for flying start is linked to the setting in <i>parameter 4-10 Motor Speed Direction</i> . [0] <i>Clockwise</i> : Flying start searches in clockwise direction. If not successful, a DC brake is activated. [2] <i>Both Directions</i> : The flying start first makes a search in the direction determined by the last reference (direction). If the speed is not found, it makes a search in the other direction. If not successful, a DC brake is activated in the time set in <i>parameter 2-02 DC Braking Time</i> . Start then takes place from 0 Hz.
[0]	Disabled	Select [0] <i>Disable</i> if this function is not required.
[1]	Enabled	Select [1] <i>Enable</i> to enable the frequency converter to catch and control a spinning motor. The parameter is always set to [1] <i>Enable</i> when <i>parameter 1-10 Motor Construction</i> =[1] PM non-salient. Important related parameters: <ul style="list-style-type: none"> • <i>Parameter 1-58 Flying Start Test Pulses Current</i> • <i>Parameter 1-59 Flying Start Test Pulses Frequency</i> • <i>Parameter 1-70 PM Start Mode</i> • <i>Parameter 2-06 Parking Current</i> • <i>Parameter 2-07 Parking Time</i> • <i>Parameter 2-03 DC Brake Cut In Speed [RPM]</i> • <i>Parameter 2-04 DC Brake Cut In Speed [Hz]</i> • <i>Parameter 2-06 Parking Current</i> • <i>Parameter 2-07 Parking Time</i>
[2]	Enabled Always	
[3]	Enabled Ref. Dir.	
[4]	Enab. Always Ref. Dir.	

The flying-start function used for PM motors is based on an initial speed estimation. The speed is always estimated as the first thing after an active start signal is given. Based on the setting of *parameter 1-70 PM Start Mode* the following happens:

Parameter 1-70 PM Start Mode=[0] *Rotor Detection*:

If the speed estimate appears as greater than 0 Hz, the frequency converter catches the motor at that speed and

resumes normal operation. Otherwise, the frequency converter estimates the rotor position and start normal operation from there.

Parameter 1-70 PM Start Mode=[1] *Parking*:

A speed estimate lower than the setting in *parameter 1-59 Flying Start Test Pulses Frequency* engages the parking function (see *parameter 2-06 Parking Current* and *parameter 2-07 Parking Time*). Otherwise, the frequency converter catches the motor at that speed and resumes normal operation. Refer to the description of *parameter 1-70 PM Start Mode* for recommended settings.

Current limitations of the flying-start principle used for PM motors:

- The speed range is up to 100% nominal speed or the field weakening speed (whichever is lowest).
- PMSM with high back EMF (>300 VLL(rms)) and high winding inductance (>10 mH) needs more time for reducing short-circuit current to 0 and may be susceptible to error in estimation.
- Current testing limited to a speed range up to 300 Hz. For certain units, the limit is 250 Hz; all 200–240 V units up to and including 2.2 kW and all 380–480 V units up to and including 4 kW.
- For high-inertia applications (that is, where the load inertia is more than 30 times larger than the motor inertia), use a brake resistor to avoid overvoltage trip during high-speed engagement of the flying-start function.

1-77 Compressor Start Max Speed [RPM]		
Range:	Function:	
Size related*	[0 - par. 4-13 RPM]	<p>NOTICE</p> <p><i>Parameter 1-77 Compressor Start Max Speed [RPM]</i> has no effect when <i>parameter 1-10 Motor Construction</i>=[1] PM, non-salient SPM.</p> <p>The parameter enables high starting torque. This is a function, where the current limit and torque limit are ignored during start of the motor. The time, from the start signal is given until the speed exceeds the speed set in this parameter, becomes a "start-zone" where the current limit and motoric torque limit is set to what is maximum possible for the frequency converter/motor combination. This parameter is normally set to the same value as <i>parameter 4-11 Motor Speed Low Limit [RPM]</i>. When set to zero the function is inactive. In this starting-zone, <i>parameter 3-82 Starting Ramp Up Time</i> is active instead of <i>parameter 3-40 Ramp 1 Type</i> to ensure extra acceleration during the start and to minimise</p>

1-77 Compressor Start Max Speed [RPM]	
Range:	Function:
	<p>the time where the motor is operated under the minimum speed for the application. The time without protection from the current limit and torque limit must not exceed the value set in <i>parameter 1-79 Compressor Start Max Time to Trip</i>. If the value in <i>parameter 1-79 Compressor Start Max Time to Trip</i> is exceeded, the frequency converter trips with <i>alarm 18, Start failed</i>.</p> <p>When this function is activated to get a fast start, <i>parameter 1-86 Trip Speed Low [RPM]</i> is also activated to protect the application from running below minimum motor speed, for example when in current limit.</p> <p>This function allows high starting torque and use of a fast starting ramp. To ensure the build-up of a high torque during the start, various tricks can be done through clever use of start delay/start speed/start current.</p>

1-78 Compressor Start Max Speed [Hz]	
Range:	Function:
Size related* [0 - par. 4-14 Hz]	<p>NOTICE</p> <p>Parameter 1-78 Compressor Start Max Speed [Hz] has no have effect when parameter 1-10 Motor Construction=[1] PM, non-salient SPM.</p> <p>The parameter enables high starting torque. This is a function, where the current limit and torque limit are ignored during start of the motor. The time, from the start signal is given until the speed exceeds the speed set in this parameter, becomes a start-zone where the current limit and motoric torque limit is set to what is maximum possible for the frequency converter/motor combination. This parameter is normally set to the same value as <i>parameter 4-11 Motor Speed Low Limit [RPM]</i>. When set to zero the function is inactive. In this starting-zone, <i>parameter 3-82 Starting Ramp Up Time</i> is active instead of <i>parameter 3-41 Ramp 1 Ramp Up Time</i> to ensure extra acceleration during the start, and to minimise the time where the motor is operated under the minimum speed for the application. The time without protection from the current limit and torque limit must not exceed the value set in <i>parameter 1-79 Compressor Start Max Time to Trip</i>. If the value of <i>parameter 1-79 Compressor Start Max Time to Trip</i> is exceeded, the frequency converter trips with <i>alarm 18 Start failed</i>.</p>

1-78 Compressor Start Max Speed [Hz]	
Range:	Function:
	<p>When this function is activated to get a fast start, <i>parameter 1-86 Trip Speed Low [RPM]</i> is also activated to protect the application from running below minimum motor speed, for example when in current limit.</p> <p>This function allows high starting torque and use of a fast starting ramp. To ensure the build-up of a high torque during the start, various tricks can be done through clever use of start delay/start speed/start current.</p>

1-79 Compressor Start Max Time to Trip	
Range:	Function:
5 s* [0 - 10 s]	<p>NOTICE</p> <p>Parameter 1-79 Compressor Start Max Time to Trip has no effect when parameter 1-10 Motor Construction=[1] PM, non-salient SPM.</p> <p>The time, from the start signal is given until the speed exceeds the speed set in <i>parameter 1-77 Compressor Start Max Speed [RPM]</i> must not exceed the time set in the parameter. If the time set is exceeded the frequency converter trips with <i>Alarm 18, Start failed</i>. Any time set in <i>parameter 1-71 Start Delay</i> for use of a start function must be executed within the time limit.</p>

3.3.10 1-8* Stop Adjustments

1-80 Function at Stop		
Option:	Function:	
		Select the frequency converter function after a stop command or after the speed is ramped down to the settings in <i>parameter 1-81 Min Speed for Function at Stop [RPM]</i> . Available selections depend on <i>parameter 1-10 Motor Construction</i> : [0] Asynchronous: <ul style="list-style-type: none"> [0] Coast [1] DC hold [2] Motor check, warning [6] Motor check, alarm [1] PM non-salient: <ul style="list-style-type: none"> [0] Coast
[0] *	Coast	Leaves motor in free mode.
[1]	DC Hold/ Motor Preheat	Energises motor with a DC hold current (see <i>parameter 2-00 DC Hold/Preheat Current</i>).
[2]	Motor check, warning	The frequency converter issues a warning if 1 or more phases are missing.
[6]	Motor check, alarm	The frequency converter issues an alarm if 1 or more phases are missing.

1-81 Min Speed for Function at Stop [RPM]		
Range:	Function:	
Size related*	[0 - 600 RPM]	Set the speed at which to activate <i>parameter 1-80 Function at Stop</i> .

1-82 Min Speed for Function at Stop [Hz]		
Range:	Function:	
Size related*	[0 - 20.0 Hz]	Set the output frequency at which to activate <i>parameter 1-80 Function at Stop</i> .

3.3.11 Trip at Motor Speed Low Limit

In *parameter 4-11 Motor Speed Low Limit [RPM]* and *parameter 4-12 Motor Speed Low Limit [Hz]* it is possible to set a minimum speed for the motor to ensure proper oil distribution.

In some cases, for example if operating in current limit because of a defect in the compressor, the output motor speed can be suppressed below motor speed low limit. To prevent damage to the compressor, it is possible to set a trip limit. If the motor speed drops below this limit, the frequency converter trips and issues *alarm (A49)*.

Reset takes place according to the selected function in *parameter 14-20 Reset Mode*.

If the trip must take place at a rather exact speed (RPM), set *parameter 0-02 Motor Speed Unit* for RPM and use slip compensation, which can be set in *parameter 1-62 Slip Compensation*.

NOTICE

To achieve the highest accuracy with the slip compensation, an Automatic motor adaptation (AMA) should be performed. To be enabled in *parameter 1-29 Automatic Motor Adaptation (AMA)*.

NOTICE

Trip is not active when using a normal stop- or coast command.

1-86 Trip Speed Low [RPM]		
Range:	Function:	
Size related*	[0 - par. 4-13 RPM]	NOTICE This parameter is only available if <i>parameter 0-02 Motor Speed Unit</i> is set to [RPM]. Enter the low limit for the motor speed at which the frequency converter trips. If the value is 0, the function is not active. If the speed at any time after the start (or during a stop) drops below the value in the parameter, the frequency converter trips with <i>alarm 49 Speed Limit</i> .

1-87 Trip Speed Low [Hz]		
Range:	Function:	
Size related*	[0 - par. 4-14 Hz]	NOTICE This parameter is only available if <i>parameter 0-02 Motor Speed Unit</i> is set to [Hz]. Enter the low limit for the motor speed at which the frequency converter trips. If the value is 0, the function is not active. If the speed at any time after the start (or during a stop) drops below the value in the parameter, the frequency converter trips with <i>alarm 49 Speed Limit</i> .

3.3.12 1-9* Motor Temperature

NOTICE

When using multiple motors, VLT® HVAC Drive FC 102 electronic thermal relay cannot be used to provide individual motor protection. Supply a separate motor overload for each motor.

1-90 Motor Thermal Protection		
Option:	Function:	
	The frequency converter determines the motor temperature for motor overload protection in 2 different ways: <ul style="list-style-type: none"> Via a thermistor sensor connected to 1 of the analog or digital inputs (<i>parameter 1-93 Thermistor Source</i>). See <i>chapter 3.3.13.1 PTC Thermistor Connection</i>. Via calculation (ETR=electronic thermal relay) of the thermal load, based on the actual load and time. The calculated thermal load is compared with the rated motor current $I_{M,N}$ and the rated motor frequency $f_{M,N}$. The calculations estimate the need for a lower load at lower speed due to less cooling from the fan incorporated in the motor. See <i>chapter 3.3.13.2 ETR</i>. Via a mechanical thermal switch (Klixon type). See <i>chapter 3.3.13.3 Klixon</i>. The ETR provides class 20 motor overload protection in accordance with NEC. 	
[0]	No protection	If the motor is continuously overloaded, and no warning or trip of frequency converter is wanted.
[1]	Thermistor warning	Activates a warning when the connected thermistor in the motor reacts in the event of motor overtemperature.
[2]	Thermistor trip	Stops (trips) the frequency converter when the connected thermistor in the motor reacts in the event of motor overtemperature.
[3]	ETR warning 1	
[4]	ETR trip 1	
[5]	ETR warning 2	
[6]	ETR trip 2	
[7]	ETR warning 3	
[8]	ETR trip 3	

1-90 Motor Thermal Protection		
Option:	Function:	
[9]	ETR warning 4	
[10]	ETR trip 4	

ETR functions 1-4 calculate the load when the set-up where they were selected is active. For example ETR-3 starts calculating when set-up 3 is selected. For the North American market: The ETR functions provide class 20 motor overload protection in accordance with NEC.

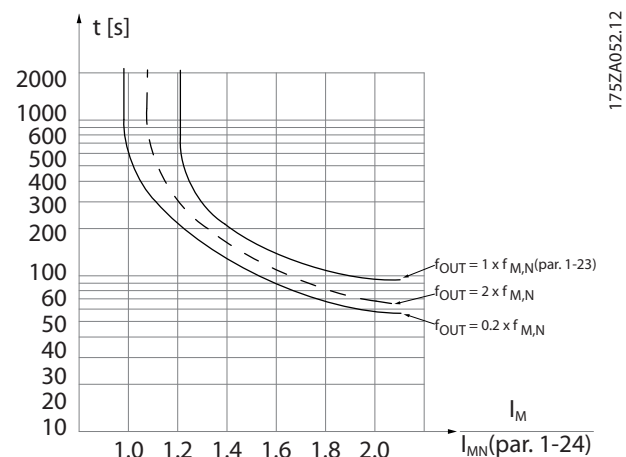

Illustration 3.10 Thermal Motor Protection

NOTICE

If the temperature of the motor is monitored through a thermistor or a KTY Sensor, the PELV is not complied with in case of short circuits between motor windings and the sensor. To comply with PELV, the sensor must be isolated appropriately.

NOTICE

Danfoss recommends using 24 V DC as thermistor supply voltage.

NOTICE

The ETR timer function does not work when *parameter 1-10 Motor Construction*=[1] PM, non-salient SPM.

NOTICE

For correct operation of the ETR function, the setting in *parameter 1-03 Torque Characteristics* must fit the application (see description of *parameter 1-03 Torque Characteristics*).

3.3.13.1 PTC Thermistor Connection

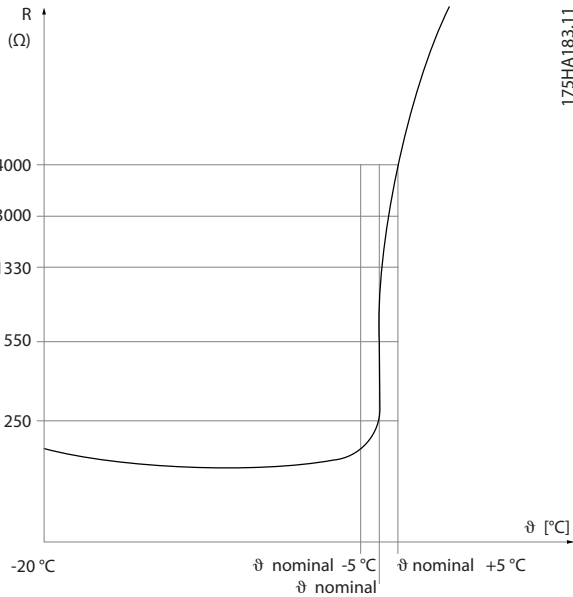

Illustration 3.11 PTC Profile

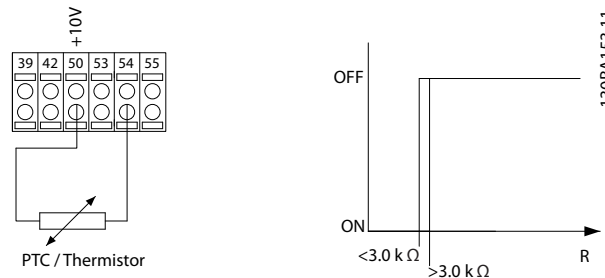

Illustration 3.13 PTC Thermistor Connection - Analog Input

Input digital/analog	Supply voltage	Threshold cut out values.
Digital	10 V	<math><800\ \Omega \rightarrow 2.7\text{ k}\Omega</math>
Analog	10 V	<math><3.0\text{ k}\Omega \rightarrow 3.0\text{ k}\Omega</math>

Table 3.9 Threshold Cut Out Values

NOTICE

Check that the selected supply voltage follows the specification of the used thermistor element.

Using a digital input and 10 V as supply:

Example: The frequency converter trips when the motor temperature is too high.

Parameter set-up:

- Set 1-90 Motor Thermal Protection to [2] Thermistor Trip.
- Set parameter 1-93 Thermistor Source to [6] Digital Input.

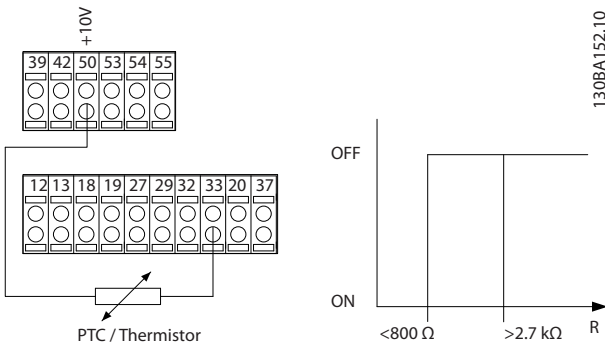

Illustration 3.12 PTC Thermistor Connection - Digital Input

3.3.13.2 ETR

The calculations estimate the need for a lower load at lower speed due to less cooling from the fan incorporated in the motor.

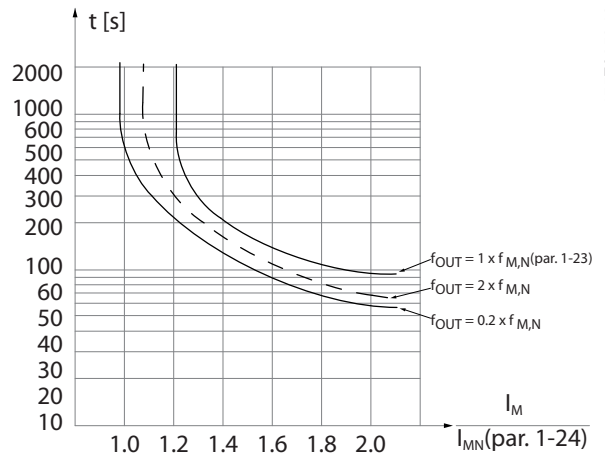

Illustration 3.14 ETR Profile

Using an analog input and 10 V as supply:

Example: The frequency converter trips when the motor temperature is too high.

Parameter set-up:

- Set 1-90 Motor Thermal Protection to [2] Thermistor Trip.
- Set parameter 1-93 Thermistor Source to [2] Analog Input 54.

3.3.13.3 Klixon

The Klixon type thermal circuit breaker uses a KLIXON® metal dish. At a predetermined overload, the heat caused by the current through the disc causes a trip.

Using a digital input and 24 V as supply:

Example: The frequency converter trips when the motor temperature is too high.

Parameter set-up:

- Set 1-90 Motor Thermal Protection to [2] Thermistor Trip.
- Set parameter 1-93 Thermistor Source to [6] Digital Input.

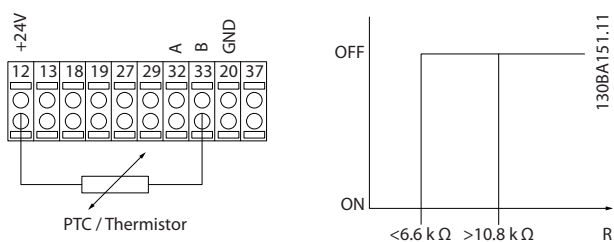

Illustration 3.15 Thermistor Connection

1-93 Thermistor Source	
Option:	Function:
[0] *	None
[1]	Analog Input 53
[2]	Analog Input 54
[3]	Digital input 18
[4]	Digital input 19
[5]	Digital input 32
[6]	Digital input 33

3

1-91 Motor External Fan	
Option:	Function:
[0] *	No No external fan is required, that is the motor is derated at low speed.
[1]	Yes Applies an external motor fan (external ventilation), so no derating of the motor is required at low speed. The upper curve in <i>Illustration 3.14</i> ($f_{out} = 1 \times f_{M,N}$) is followed if the motor current is lower than nominal motor current (see <i>parameter 1-24 Motor Current</i>). If the motor current exceeds nominal current, the operation time still decreases as if no fan was installed.

1-93 Thermistor Source	
Option:	Function:
	<p>NOTICE</p> <p>This parameter cannot be adjusted while the motor is running.</p> <p>NOTICE</p> <p>Set digital input to [0] PNP - Active at 24 V in <i>parameter 5-00 Digital I/O Mode</i>.</p> <p>Select the input to which the thermistor (PTC sensor) should be connected. An analog input option [1] <i>Analog Input 53</i> or [2] <i>Analog Input 54</i> cannot be selected if the analog input is already in use as a reference source (selected in <i>parameter 3-15 Reference 1 Source</i>,</p>

3.4 Parameters: 2-** Main Menu - Brakes

3.4.1 2-0* DC-Brakes

Parameter group for configuring the DC brake and DC hold functions.

3

2-00 DC Hold/Preheat Current		
Range:	Function:	
50 %* [0 - 160 %]	<p>NOTICE</p> <p>Parameter 2-00 DC Hold/Preheat Current has no effect when <i>parameter 1-10 Motor Construction</i>=[1] PM, non-salient SPM.</p> <p>NOTICE</p> <p>The maximum value depends on the rated motor current. Avoid 100% current for too long. It may damage the motor.</p> <p>Enter a value for holding current as a percentage of the rated motor current $I_{M,N}$ set in <i>parameter 1-24 Motor Current</i>. 100% DC hold current corresponds to $I_{M,N}$.</p> <p>This parameter holds the motor (holding torque) or preheats the motor.</p> <p>This parameter is active if [1] DC hold/Motor Preheat is selected in <i>parameter 1-80 Function at Stop</i>.</p>	

2-01 DC Brake Current		
Range:	Function:	
50 %* [0 - 1000 %]	<p>NOTICE</p> <p>The maximum value depends on the rated motor current. Avoid 100 % current for too long. It may damage the motor.</p> <p>Enter a value for current as a percentage of the rated motor current $I_{M,N}$, see <i>parameter 1-24 Motor Current</i>. 100% DC braking current corresponds to $I_{M,N}$.</p> <p>DC brake current is applied on a stop command, when the speed is lower than the limit set in</p> <ul style="list-style-type: none"> • <i>Parameter 2-03 DC Brake Cut In Speed [RPM]</i>. • <i>Parameter 2-04 DC Brake Cut In Speed [Hz]</i>; when the DC brake inverse function is active; or via the serial communication port. <p>The braking current is active during the time period set in <i>parameter 2-02 DC Braking Time</i>.</p>	

2-02 DC Braking Time		
Range:	Function:	
10 s* [0 - 60 s]	<p>Set the duration of the DC brake current set in <i>parameter 2-01 DC Brake Current</i>, once activated.</p>	

2-03 DC Brake Cut In Speed [RPM]		
Range:	Function:	
Size related* [0 - 0 RPM]	<p>NOTICE</p> <p>Parameter 2-03 DC Brake Cut In Speed [RPM] has no effect when <i>parameter 1-10 Motor Construction</i>=[1] PM, non-salient SPM.</p> <p>Set the DC brake cut-in speed for activation of the DC braking current set in <i>parameter 2-01 DC Brake Current</i>, upon a stop command.</p> <p>When <i>parameter 1-10 Motor Construction</i> is set to [1] PM non-salient SPM, this value is limited to 0 rpm (OFF)</p>	

2-04 DC Brake Cut In Speed [Hz]		
Range:	Function:	
Size related* [0 - 0.0 Hz]	<p>NOTICE</p> <p>Parameter 2-04 DC Brake Cut In Speed [Hz] has no effect when <i>parameter 1-10 Motor Construction</i>=[1] PM, non-salient SPM.</p> <p>This parameter is for setting the DC brake cut-in speed at which the DC braking current (<i>parameter 2-01 DC Brake Current</i>) is to be active in connection with a stop command.</p>	

2-06 Parking Current		
Range:	Function:	
50 %* [0 - 1000 %]	<p>NOTICE</p> <p>Parameter 2-06 Parking Current and <i>parameter 2-07 Parking Time</i>: Only active if PM motor construction is selected in <i>parameter 1-10 Motor Construction</i>.</p> <p>Set current as percentage of rated motor current, <i>parameter 1-24 Motor Current</i>. Active in connection with <i>parameter 1-73 Flying Start</i>. The parking current is active during the time period set in <i>parameter 2-07 Parking Time</i>.</p>	

2-07 Parking Time		
Range:	Function:	
3 s* [0.1 - 60 s]	Set the duration of the parking current time set in <i>parameter 2-06 Parking Current</i> . Active in connection with <i>parameter 1-73 Flying Start</i> .	
	<p>NOTICE</p> <p>Parameter 2-07 Parking Time is only active when [1] PM, non-salient SPM is selected in 1-10 Motor Construction.</p>	

3.4.2 2-1* Brake Energy Funct.

Parameter group for selecting dynamic brake parameters. Only valid for frequency converters with brake chopper.

2-10 Brake Function		
Option:	Function:	
	Available selections depend on <i>parameter 1-10 Motor Construction</i> : [0] Asynchron: [0] Off [1] Resistor brake [2] AC brake [1] PM non-salient: [0] Off [1] Resistor brake	
[0]	Off	No brake resistor installed.
[1]	Resistor brake	Brake resistor incorporated in the system, for dissipation of surplus brake energy as heat. Connecting a brake resistor allows a higher DC-link voltage during braking (generating operation). The resistor brake function is only active in frequency converters with an integral dynamic brake.
[2]	AC brake	AC brake only works in compressor torque mode in <i>parameter 1-03 Torque Characteristics</i> .

2-11 Brake Resistor (ohm)		
Range:	Function:	
Size related* [5.00 - 65535.00 Ohm]	Set the brake resistor value in Ω. This value is used for monitoring the power to the brake resistor in <i>parameter 2-13 Brake Power Monitoring</i> . This parameter is only active in frequency converters with an integral dynamic brake. Use this parameter for values without decimals. For a selection with 2 decimals, use <i>30-81 Brake Resistor (ohm)</i> .	

2-12 Brake Power Limit (kW)		
Range:	Function:	
Size related* [0.001 - 2000.000 kW]	<p><i>Parameter 2-12 Brake Power Limit (kW)</i> is the expected average power dissipated in the brake resistor over a period of 120 s. It is used as the monitoring limit for <i>16-33 Brake Energy Average</i> and thereby specifies when a warning/alarm is to be given.</p> <p>To calculate <i>parameter 2-12 Brake Power Limit (kW)</i>, the following formula can be used.</p> $P_{br,avg} [W] = \frac{U_{br}^2 [V] \times t_{br} [s]}{R_{br} [\Omega] \times T_{br} [s]}$ <p>$P_{br,avg}$ is the average power dissipated in the brake resistor, R_{br} is the resistance of the brake resistor. t_{br} is the active breaking time within the 120 s period, T_{br}.</p> <p>U_{br} is the DC voltage where the brake resistor is active. This depends on the unit as follows: T2 units: 390 V T4 units: 778 V T5 units: 810 V T6 units: 943 V/1099 V for D – F frames T7 units: 1099 V</p> <p>NOTICE</p> <p>If R_{br} is not known, or if T_{br} is different from 120 s, the practical approach is to run the brake application, readout <i>16-33 Brake Energy Average</i> and then enter this + 20% in <i>2-12 Brake Power Limit (kW)</i>.</p>	

2-13 Brake Power Monitoring		
Option:	Function:	
		<p>NOTICE</p> <p>This parameter is only active in frequency converters with an integral dynamic brake.</p> <p>This parameter enables monitoring of the power to the brake resistor. The power is calculated on the basis of the resistance (<i>parameter 2-11 Brake Resistor (ohm)</i>), the DC link voltage, and the resistor duty time.</p> <p>If power monitoring is set to [0] Off or [1] Warning, the brake function remains active even if the monitoring limit is exceeded. This may lead to thermal overload of the resistor. It is also possible to generate a warning via a relay/digital output. The measuring accuracy of the power monitoring depends on the accuracy of the resistance of the resistor (better than ±20%).</p>
[0] *	Off	No brake power monitoring is required.
[1]	Warning 120s	<p>Activates a warning in the display when the power transmitted over 120 s exceeds 100% of the monitoring limit (<i>parameter 2-12 Brake Power Limit (kW)</i>).</p> <p>The warning disappears when the transmitted power falls below 80% of the monitoring limit.</p>
[2]	Trip 120s	Trips the frequency converter and displays an alarm when the calculated power exceeds 100% of the monitoring limit.
[3]	Warning & trip 120s	Activates both of the above, including warning, trip and alarm.
[4]	Warning 30s	
[5]	Trip 30s	
[6]	Warning & trip 30s	
[7]	Warning 60s	
[8]	Trip 60s	
[9]	Warning & trip 60s	
[10]	Warning 300s	
[11]	Trip 300s	
[12]	Warning & trip 300s	
[13]	Warning 600s	
[14]	Trip 600s	
[15]	Warning & trip 600s	

2-15 Brake Check		
Option:	Function:	
		<p>NOTICE</p> <p>Remove a warning arising in connection with [0] Off or [1] Warning by cycling the mains supply. The fault must be corrected first. For [0] Off or [1] Warning, the frequency converter keeps running even if a fault is located.</p> <p>Select type of test and monitoring function to check the connection to the brake resistor, or whether a brake resistor is present, and then display a warning or an alarm in the event of a fault. The brake resistor disconnection function is tested during power-up. However, the brake IGBT test is performed when there is no braking. A warning or trip disconnects the brake function. The testing sequence is as follows:</p> <ol style="list-style-type: none"> 1. Measure the DC link ripple amplitude for 300 ms without braking. 2. Measure the DC link ripple amplitude for 300 ms with the brake turned on. 3. If the DC link ripple amplitude while braking is lower than the DC link ripple amplitude before braking +1%. If brake check fails, a warning or alarm is returned. 4. If the DC link ripple amplitude while braking is higher than the DC link ripple amplitude before braking +1%. Brake check OK.
[0] *	Off	Monitors brake resistor and brake IGBT for a short-circuit during operation. If a short-circuit occurs, a warning appears.
[1]	Warning	Monitors brake resistor and brake IGBT for a short-circuit, and runs a test for brake resistor disconnection during power-up.
[2]	Trip	Monitors for a short-circuit or disconnection of the brake resistor, or a short-circuit of the brake IGBT. If a fault occurs, the frequency converter cuts out while displaying an alarm (trip locked).
[3]	Stop and trip	Monitors for a short-circuit or disconnection of the brake resistor, or a short-circuit of the brake IGBT. If a fault occurs, the frequency converter ramps down to coast and then trips. A trip lock alarm is displayed.
[4]	AC brake	Monitors for a short-circuit or disconnection of the brake resistor, or a short-circuit of the brake IGBT. If a fault occurs, the frequency converter performs a controlled ramp-down.

2-16 AC brake Max. Current		
Range:		Function:
100 %*	[0 - 1000.0 %]	<p>NOTICE</p> <p><i>Parameter 2-16 AC brake Max. Current does not have effect when parameter 1-10 Motor Construction=[1] PM, non-salient SPM.</i></p> <p>Enter the maximum permissible current when using AC brake to avoid overheating of motor windings.</p>

2-17 Over-voltage Control		
<p>Over voltage control (OVC) reduces the risk of the frequency converter tripping due to an over voltage on the DC link caused by generative power from the load.</p>		
Option:		Function:
		<p>NOTICE</p> <p>The ramp time is automatically adjusted to avoid tripping of the frequency converter.</p>
[0]	Disabled	No OVC required.
[2] *	Enabled	Activates OVC.

3.5 Parameters: 3-** Main Menu - Reference/Ramps

3.5.1 3-0* Reference Limits

Parameters for setting the reference unit, limits, and ranges.

See also parameter group 20-0* FC Closed Loop for information on settings in closed loop.

3-02 Minimum Reference		
Range:	Function:	
Size related* [-999999.999 - par. 3-03 ReferenceFeed-backUnit]	Enter the minimum reference. The minimum reference is the lowest value obtainable by summing all references. The minimum reference value and unit match the configuration made in <i>parameter 1-00 Configuration Mode</i> and <i>20-12 Reference/Feedback Unit</i> .	
<p>NOTICE</p> <p>This parameter is used in open loop only.</p>		

3-03 Maximum Reference		
Range:	Function:	
Size related* [par. 3-02 - 999999.999 ReferenceFeed-backUnit]	Enter the maximum reference. The maximum reference is the highest value obtainable by summing all references. The maximum reference unit matches:	
<ul style="list-style-type: none"> The configuration selected in <i>1-00 Configuration Mode</i>: for [1] <i>Speed closed loop</i>, RPM; for [2] <i>Torque</i>, Nm. The unit selected in <i>3-00 Reference Range</i>. 		

3-04 Reference Function		
Option:	Function:	
[0]	Sum	Sums both external and preset reference sources.
[1]	External/Preset	Use either the preset or the external reference source. Shift between external and preset via a command on a digital input.

3.5.2 3-1* References

Select the preset reference(s). Select *Preset ref. bit 0/1/2 [16], [17] or [18]* for the corresponding digital inputs in parameter group *5-1* Digital Inputs*.

3-10 Preset Reference		
Array [8]		
Range:	Function:	
0 %* [-100 - 100 %]	Enter up to 8 different preset references (0-7) in this parameter, using array programming. The preset reference is stated as a percentage of the value Ref _{MAX} (<i>3-03 Maximum Reference</i> , for closed loop see <i>parameter 20-14 Maximum Reference/Feedb.</i>). When using preset references, select <i>Preset ref. bit 0/1/2 [16], [17] or [18]</i> for the corresponding digital inputs in parameter group <i>5-1* Digital Inputs</i> .	

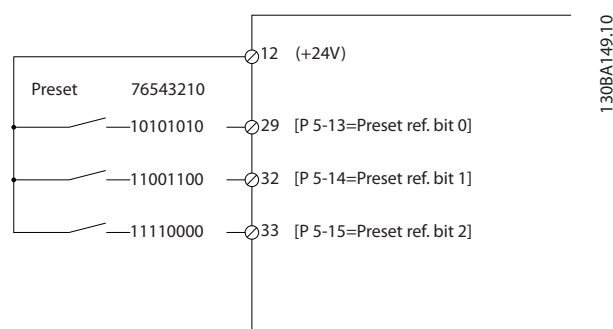
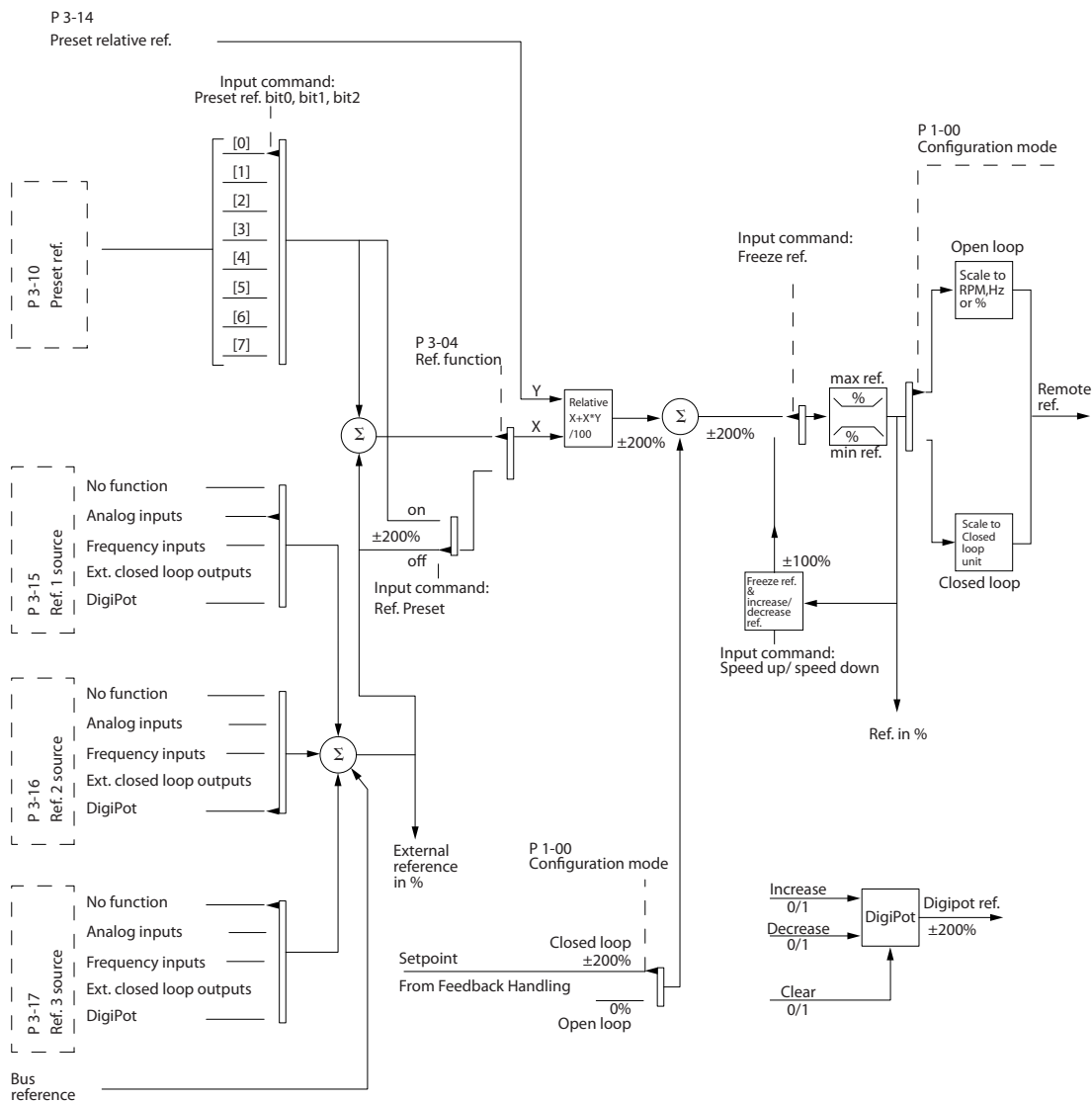

Illustration 3.16 Preset Reference Scheme

130BA149.10



130BA357.12

3

Illustration 3.17 Example of Open Loop and Closed Loop Operation

3-11 Jog Speed [Hz]		
Range:	Function:	
Size related*	[0 - par. 4-14 Hz]	The jog speed is a fixed output speed at which the frequency converter is running when the jog function is activated. See also <i>parameter 3-19 Jog Speed [RPM]</i> and <i>parameter 3-80 Jog Ramp Time</i> .

3-13 Reference Site		
Option:	Function:	
		Select which reference site to activate.
[0] *	Linked to Hand / Auto	Use local reference when in <i>Hand</i> mode, or remote reference when in <i>Auto</i> mode.
[1]	Remote	Use remote reference in both <i>Hand</i> mode and <i>Auto</i> mode.
[2]	Local	Use local reference in both <i>Hand</i> mode and <i>Auto</i> mode. NOTICE When set to [2] <i>Local</i> , the frequency converter starts with this setting again following a power-down.
[3]	Linked to H/A MCO	Select this option to enable the FFACC factor in 32-66 <i>Acceleration Feed-Forward</i> . Enabling FFACC reduces jitter and makes the transmission from the motion controller to the control card of the frequency converter faster. This leads to faster response times for dynamic applications and position control. For more information about FFACC, see <i>Programmable Motion Controller MCO 305 Operating Instructions</i> .

3-14 Preset Relative Reference		
Range:	Function:	
0 %* [-100 - 100 %]	The actual reference, X, is increased or decreased with the percentage Y, set in <i>parameter 3-14 Preset Relative Reference</i> . This results in the actual reference Z. Actual reference (X) is the sum of the inputs selected in <i>parameter 3-15 Reference 1 Source</i> , <i>parameter 3-16 Reference 2 Source</i> , <i>parameter 3-17 Reference 3 Source</i> , and <i>parameter 8-02 Control Source</i> .	

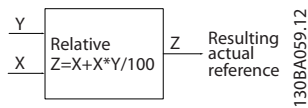

Illustration 3.18 Preset Relative Reference

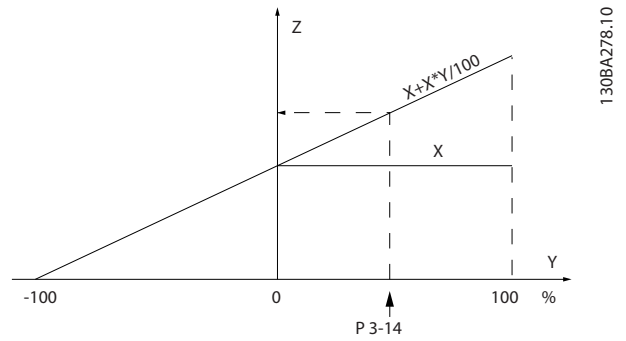

Illustration 3.19 Actual Reference

3-15 Reference 1 Source		
Option:	Function:	
	NOTICE This parameter cannot be adjusted while the motor is running. Select the reference input to be used for the first reference signal.	
	<ul style="list-style-type: none"> Parameter 3-15 Reference 1 Source. Parameter 3-16 Reference 2 Source. Parameter 3-17 Reference 3 Source. define up to 3 different reference signals. The sum of these reference signals defines the actual reference.	
[0]	No function	
[1] *	Analog Input 53	
[2]	Analog Input 54	
[7]	Pulse input 29	
[8]	Pulse input 33	
[20]	Digital pot.meter	
[21]	Analog input X30/11	
[22]	Analog input X30/12	
[23]	Analog Input X42/1	
[24]	Analog Input X42/3	
[25]	Analog Input X42/5	
[29]	Analog Input X48/2	
[30]	Ext. Closed Loop 1	
[31]	Ext. Closed Loop 2	

3-15 Reference 1 Source	
Option:	Function:
[32] Ext. Closed Loop 3	

3-16 Reference 2 Source	
Option:	Function:
	<p>NOTICE</p> <p>This parameter cannot be adjusted while the motor is running.</p> <p>Select the reference input to be used for the second reference signal.</p> <ul style="list-style-type: none"> Parameter 3-15 Reference 1 Source. Parameter 3-16 Reference 2 Source. Parameter 3-17 Reference 3 Source. <p>define up to 3 different reference signals. The sum of these reference signals defines the actual reference.</p>
[0] No function	
[1] Analog Input 53	
[2] Analog Input 54	
[7] Pulse input 29	
[8] Pulse input 33	
[20] * Digital pot.meter	
[21] Analog input X30/11	
[22] Analog input X30/12	
[23] Analog Input X42/1	
[24] Analog Input X42/3	
[25] Analog Input X42/5	
[29] Analog Input X48/2	
[30] Ext. Closed Loop 1	
[31] Ext. Closed Loop 2	
[32] Ext. Closed Loop 3	

3-17 Reference 3 Source	
Option:	Function:
	<p>NOTICE</p> <p>This parameter cannot be adjusted while the motor is running.</p> <p>Select the reference input to be used for the third reference signal.</p> <ul style="list-style-type: none"> Parameter 3-15 Reference 1 Source. Parameter 3-16 Reference 2 Source. Parameter 3-17 Reference 3 Source. <p>define up to 3 different reference signals. The sum of these reference signals defines the actual reference.</p>
[0] * No function	
[1] Analog Input 53	
[2] Analog Input 54	
[7] Pulse input 29	
[8] Pulse input 33	
[20] Digital pot.meter	
[21] Analog input X30/11	
[22] Analog input X30/12	
[23] Analog Input X42/1	
[24] Analog Input X42/3	
[25] Analog Input X42/5	
[29] Analog Input X48/2	
[30] Ext. Closed Loop 1	
[31] Ext. Closed Loop 2	
[32] Ext. Closed Loop 3	

3-19 Jog Speed [RPM]	
Range:	Function:
Size related* [0 - par. 4-13 RPM]	<p>Enter a value for the jog speed n_{JOG}, which is a fixed output speed. The frequency converter runs at this speed when the jog function is activated. The maximum limit is defined in <i>parameter 4-13 Motor Speed High Limit [RPM]</i>.</p> <p>See also <i>parameter 3-11 Jog Speed [Hz]</i> and <i>parameter 3-80 Jog Ramp Time</i>.</p>

3.5.3 3-4* Ramp 1

Configure the ramp times for each of the 2 ramps (parameter group 3-4* Ramp 1 and parameter group 3-5* Ramp 2).

3

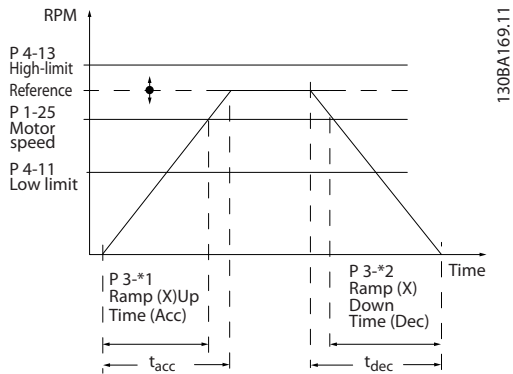

Illustration 3.20 Ramp 1

3-41 Ramp 1 Ramp Up Time	
Range:	Function:
	$par. 3 - 41 = \frac{t_{acc} \times nnom [par. 1 - 25]}{ref [RPM]} [s]$

3-42 Ramp 1 Ramp Down Time	
Range:	Function:
Size related* [1.00 - 3600 s]	Enter the ramp-down time, i.e. the deceleration time from <i>parameter 1-25 Motor Nominal Speed</i> to 0 RPM. Select a ramp-down time preventing overvoltage from arising in the inverter due to regenerative operation of the motor. The ramp-down time should also be long enough to prevent that the generated current exceeds the current limit set in <i>parameter 4-18 Current Limit</i> . See ramp-up time in <i>parameter 3-41 Ramp 1 Ramp Up Time</i> .

$$par. 3 - 42 = \frac{t_{dec} \times nnom [par. 1 - 25]}{ref [RPM]} [s]$$

3-40 Ramp 1 Type	
Option:	Function:
	<p>NOTICE</p> <p>If [1] S-ramp Const Jerk is selected and the reference during ramping is changed, the ramp time may be prolonged to realise a jerk-free movement, which may result in a longer start or stop time. Additional adjustment of the S-ramp ratios or switching initiators may be necessary.</p> <p>Select the ramp type, depending on requirements for acceleration/deceleration. A linear ramp gives constant acceleration during ramping. An S-ramp gives non-linear acceleration, compensating for jerk in the application.</p>
[0] *	Linear
[1]	S-ramp Const Jerk Acceleration with lowest possible jerk.
[2]	S-ramp Const Time S-ramp based on the values set in 3-41 Ramp 1 Ramp Up Time and 3-42 Ramp 1 Ramp Down Time.

3.5.4 3-5* Ramp 2

To select ramp parameters, see parameter group 3-4* Ramp 1.

3-51 Ramp 2 Ramp Up Time	
Range:	Function:
Size related* [1.00 - 3600 s]	Enter the ramp-up time, that is the acceleration time from 0 RPM to <i>parameter 1-25 Motor Nominal Speed</i> . Select a ramp-up time such that the output current does not exceed the current limit in <i>parameter 4-18 Current Limit</i> during ramping. See ramp-down time in <i>parameter 3-52 Ramp 2 Ramp Down Time</i> .
	$par. 3 - 51 = \frac{t_{acc} \times nnom [par. 1 - 25]}{ref [rpm]} [s]$

3-52 Ramp 2 Ramp Down Time	
Range:	Function:
Size related* [1.00 - 3600 s]	Enter the ramp-down time, i.e. the deceleration time from <i>parameter 1-25 Motor Nominal Speed</i> to 0 RPM. Select a ramp-down time such that no overvoltage arises in the inverter due to regenerative operation of the motor, and such that the generated current does not exceed the current limit set in <i>parameter 4-18 Current Limit</i> . See ramp-up time in <i>parameter 3-51 Ramp 2 Ramp Up Time</i> .
	$par. 3 - 52 = \frac{t_{dec} \times nnom [par. 1 - 25]}{ref [rpm]} [s]$

3-41 Ramp 1 Ramp Up Time	
Range:	Function:
Size related* [1.00 - 3600 s]	Enter the ramp-up time, i.e. the acceleration time from 0 RPM to <i>parameter 1-25 Motor Nominal Speed</i> . Select a ramp-up time such that the output current does not exceed the current limit in <i>parameter 4-18 Current Limit</i> during ramping. See ramp-down time in <i>parameter 3-42 Ramp 1 Ramp Down Time</i> .

3.5.5 3-8* Other Ramps

3-80 Jog Ramp Time		
Range:	Function:	
Size related*	[1 - 3600 s]	Enter the jog ramp time, i.e. the acceleration/ deceleration time between 0 RPM and the rated motor speed ($n_{M,N}$) (set in <i>parameter 1-25 Motor Nominal Speed</i>). Ensure that the resulting output current required for the given jog ramp time does not exceed the current limit in <i>parameter 4-18 Current Limit</i> . The jog ramp time starts upon activation of a jog signal via the control panel, a selected digital input, or the serial communication port.
	$par. 3-80 = \frac{t_{jog} \times n_{nom} [par. 1-25]}{jog\ speed [par. 3-19]} [s]$	

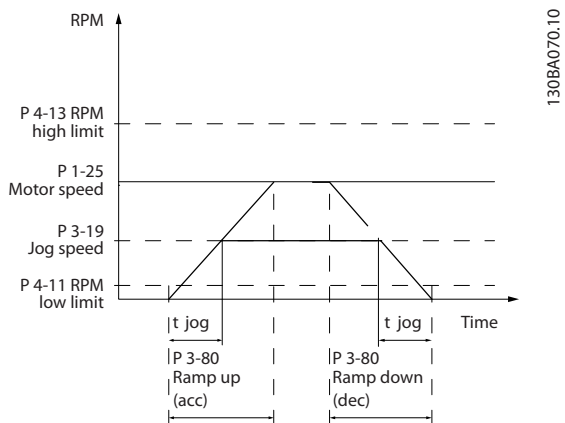

Illustration 3.21 Jog Ramp Time

3-82 Starting Ramp Up Time		
Range:	Function:	
Size related*	[0.01 - 3600 s]	The ramp-up time is the acceleration time from 0 RPM to the nominal motor speed set in <i>parameter 3-82 Starting Ramp Up Time</i> when [0] Compressor Torque is active in <i>parameter 1-03 Torque Characteristics</i> .

3.5.6 3-9* Digital Pot.Meter

Use the digital potentiometer function to increase or decrease the actual reference by adjusting the set-up of the digital inputs using the functions INCREASE, DECREASE or CLEAR. To activate the function, at least 1 digital input must be set to INCREASE or DECREASE.

3-90 Step Size		
Range:	Function:	
0.10 %*	[0.01 - 200 %]	Enter the increment size required for increase/decrease as a percentage of the synchronous motor speed, n_s . If INCREASE/ DECREASE is activated, the resulting reference is increased/decreased by the amount set in this parameter.

3-91 Ramp Time		
Range:	Function:	
1 s	[0 - 3600 s]	Enter the ramp time, that is the time for adjustment of the reference from 0% to 100% of the specified digital potentiometer function (INCREASE, DECREASE or CLEAR). If increase/decrease is activated for longer than the ramp delay period specified in <i>parameter 3-95 Ramp Delay</i> , the actual reference is ramped up/down according to this ramp time. The ramp time is defined as the time spent to adjust the reference by the step size specified in <i>parameter 3-90 Step Size</i> .

3-92 Power Restore		
Option:	Function:	
[0] * Off	Resets the digital potentiometer reference to 0% after power-up.	
[1] On	Restores the most recent digital potentiometer reference at power-up.	

3-93 Maximum Limit		
Range:	Function:	
100 %*	[-200 - 200 %]	Set the maximum permissible value for the resultant reference. This is advisable if the digital potentiometer is used for fine-tuning of the resulting reference.

3-94 Minimum Limit		
Range:	Function:	
0 %*	[-200 - 200 %]	Set the minimum permissible value for the resultant reference. This is advisable if the digital potentiometer is used for fine-tuning of the resulting reference.

3

3-95 Ramp Delay		
Range:	Function:	
Size related*	[0.000 - 0.000]	Enter the delay required from activation of the digital potentiometer function until the frequency converter starts to ramp the reference. With a delay of 0 ms, the reference starts to ramp as soon as increase/decrease is activated. See also <i>parameter 3-91 Ramp Time</i> .

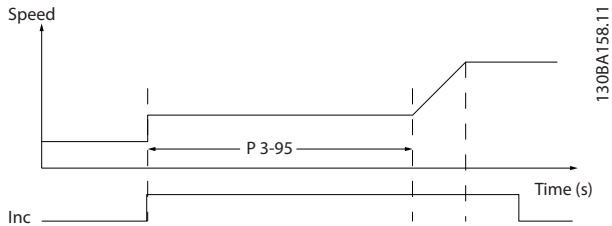

Illustration 3.22 Ramp Delay Case 1

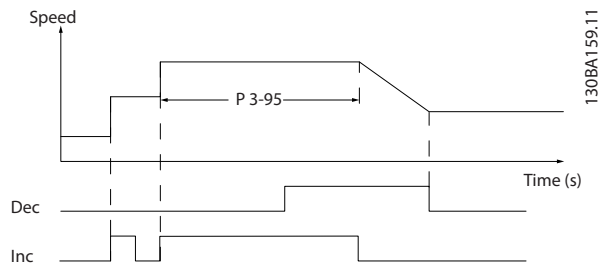

Illustration 3.23 Ramp Delay Case 2

3.6 Parameters: 4-** Main Menu - Limits/Warnings

3.6.1 4-1* Motor Limits

Define torque, current and speed limits for the motor, and the reaction of the frequency converter when the limits are exceeded.

A limit may generate a message in the display. A warning always generates a message in the display or on the fieldbus. A monitoring function may initiate a warning or a trip, upon which the frequency converter stops and generates an alarm message.

4-10 Motor Speed Direction		
Option:	Function:	
		<p>NOTICE</p> <p>The setting in <i>parameter 4-10 Motor Speed Direction</i> has impact on the flying start in <i>parameter 1-73 Flying Start</i>.</p> <p>Selects the motor speed direction required. Use this parameter to prevent unwanted reversing.</p>
[0]	Clockwise	Only operation in clockwise direction is allowed.
[2] *	Both directions	Operation in both clockwise and counter-clockwise direction is allowed.

4-11 Motor Speed Low Limit [RPM]		
Range:	Function:	
Size related* [0 - par. 4-13 RPM]	Enter the minimum limit for motor speed in RPM. The motor speed low limit can be set to correspond to the manufacturer's recommended minimum motor speed. The motor speed low limit must not exceed the setting in <i>parameter 4-13 Motor Speed High Limit [RPM]</i> .	

4-12 Motor Speed Low Limit [Hz]		
Range:	Function:	
Size related* [0 - par. 4-14 Hz]	Enter the minimum limit for motor speed in Hz. The motor speed low limit can be set to correspond to the minimum output frequency of the motor shaft. The speed low limit must not exceed the setting in <i>parameter 4-14 Motor Speed High Limit [Hz]</i> .	

4-13 Motor Speed High Limit [RPM]		
Range:	Function:	
Size related* [par. 4-11 - 60000 RPM]	<p>NOTICE</p> <p>Any changes in <i>parameter 4-13 Motor Speed High Limit [RPM]</i> reset the value in <i>parameter 4-53 Warning Speed High</i> to the value set in <i>parameter 4-13 Motor Speed High Limit [RPM]</i>.</p> <p>NOTICE</p> <p>Max. output frequency cannot exceed 10% of the inverter switching frequency (<i>parameter 14-01 Switching Frequency</i>).</p> <p>Enter the maximum limit for motor speed in RPM. The motor speed high limit can be set to correspond to the manufacturer's maximum rated motor. The motor speed high limit must exceed the setting in <i>parameter 4-11 Motor Speed Low Limit [RPM]</i>. The parameter name appears as either <i>parameter 4-11 Motor Speed Low Limit [RPM]</i> or <i>parameter 4-12 Motor Speed Low Limit [Hz]</i>, depending on:</p> <ul style="list-style-type: none"> The settings of other parameters in the <i>Main Menu</i>. Default settings based on geographical location. 	

4-14 Motor Speed High Limit [Hz]		
Range:	Function:	
Size related* [par. 4-12 - par. 4-19 Hz]	Enter the maximum limit for motor speed in Hz. <i>Parameter 4-14 Motor Speed High Limit [Hz]</i> can be set to correspond to the manufacturer's recommended maximum motor speed. The motor speed high limit must exceed the value in <i>parameter 4-12 Motor Speed Low Limit [Hz]</i> . The output frequency must not exceed 10% of the switching frequency (<i>parameter 14-01 Switching Frequency</i>).	

4-16 Torque Limit Motor Mode		
Range:	Function:	
Size related* [0 - 1000.0 %]	Enter the maximum torque limit for motor operation. The torque limit is active in the speed range up to and including the rated motor speed set in <i>parameter 1-25 Motor Nominal Speed</i> . To protect the motor from reaching the stalling torque, the default setting is 1.1 x the rated motor torque (calculated value). See also <i>parameter 14-25 Trip Delay at Torque Limit</i> for further details. If a setting in <i>parameter 1-00 Configuration Mode</i> to <i>parameter 1-28 Motor Rotation Check</i> is changed, <i>parameter 4-16 Torque Limit Motor Mode</i> is not automatically reset to the default setting.	

4-17 Torque Limit Generator Mode		
Range:	Function:	
100 %* [0 - 1000.0 %]	Enter the maximum torque limit for generator-mode operation. The torque limit is active in the speed range up to and including the rated motor speed (<i>parameter 1-25 Motor Nominal Speed</i>). Refer to <i>parameter 14-25 Trip Delay at Torque Limit</i> for further details. If a setting in <i>parameter 1-00 Configuration Mode</i> to <i>parameter 1-28 Motor Rotation Check</i> is changed, <i>parameter 4-17 Torque Limit Generator Mode</i> is not automatically reset to the default settings.	

4-18 Current Limit		
Range:	Function:	
Size related* [1.0 - 1000.0 %]	Enter the current limit for motor and generator operation. To protect the motor from reaching the stalling torque, the default setting is 1.1 x the rated motor current (set in <i>parameter 1-24 Motor Current</i>). If a setting in <i>parameter 1-00 Configuration Mode</i> to <i>parameter 1-28 Motor Rotation Check</i> is changed, <i>parameter 4-16 Torque Limit Motor Mode</i> to <i>parameter 4-18 Current Limit</i> are not automatically reset to the default settings.	

4-19 Max Output Frequency		
Range:	Function:	
Size related* [1 - 590 Hz]	Enter the maximum output frequency value. <i>Parameter 4-19 Max Output Frequency</i> specifies the absolute limit on the frequency converter output frequency for improved safety in applications where accidental over-speeding must be avoided. This absolute limit applies to all configurations and is independent of the setting in <i>parameter 1-00 Configuration Mode</i> .	

4-19 Max Output Frequency		
Range:	Function:	
	This parameter cannot be adjusted while the motor is running. When <i>parameter 1-10 Motor Construction</i> is set to [1] PM non-salient SPM, the maximum value is limited to 300 Hz.	

3.6.2 4-5* Adj. Warnings

Define adjustable warning limits for current, speed, reference and feedback.

NOTICE

Not visible in the display, only in MCT 10 Set-up Software.

4-50 Warning Current Low		
Range:	Function:	
0 A* [0 - par. 4-51 A]	Warnings are shown on the display, programmed output or serial bus.	
	<p style="text-align: center;">Illustration 3.24 Low Current Limit</p>	
	Enter the I_{LOW} value. When the motor current drops below this limit (I_{LOW}), the display reads CURRENT LOW. The signal outputs can be programmed to produce a status signal on terminal 27 or 29 and on relay output 01 or 02. Refer to <i>Illustration 3.24</i> .	

4-51 Warning Current High		
Range:	Function:	
Size related* [par. 4-50 - par. 16-37 A]	Enter the I_{HIGH} value. When the motor current exceeds this limit (I_{HIGH}), the display reads <i>Current high</i> . The signal outputs can be programmed to produce a status signal on terminal 27 or 29, and on relay output 01 or 02. Refer to <i>Illustration 3.24</i> .	

4-52 Warning Speed Low		
Range:	Function:	
0 RPM*	[0 - par. 4-53 RPM]	

4-53 Warning Speed High		
Range:		Function:
Size related*	[par. 4-52 - 60000 RPM]	<p>NOTICE</p> <p>Any changes in <i>parameter 4-13 Motor Speed High Limit [RPM]</i> reset the value in <i>parameter 4-53 Warning Speed High</i> to the same value as set in <i>parameter 4-13 Motor Speed High Limit [RPM]</i>.</p> <p>If a different value is needed in <i>parameter 4-53 Warning Speed High</i>, it must be set after programming of <i>parameter 4-13 Motor Speed High Limit [RPM]</i>.</p> <p>Enter the n_{HIGH} value. When the motor speed exceeds this limit (n_{HIGH}), the display reads <i>Speed high</i>. The signal outputs can be programmed to produce a status signal on terminal 27 or 29, and on relay output 01 or 02. Programme the upper signal limit of the motor speed, n_{HIGH}, within the normal working range of the frequency converter. Refer to <i>Illustration 3.24</i>.</p>

4-54 Warning Reference Low		
Range:		Function:
-999999.999*	[-999999.999 - par. 4-55]	Enter the lower reference limit. When the actual reference drops below this limit, the display indicates Ref_{Low} . The signal outputs can be programmed to produce a status signal on terminal 27 or 29, and on relay output 01 or 02.

4-55 Warning Reference High		
Range:		Function:
999999.999*	[par. 4-54 - 999999.999]	Enter the upper reference limit. When the actual reference exceeds this limit, the display reads Ref_{High} . The signal outputs can be programmed to produce a status signal on terminal 27 or 29, and on relay output 01 or 02.

4-56 Warning Feedback Low		
Range:		Function:
-999999.999 ProcessCtrlUnit*	[-999999.999 - par. 4-57 ProcessCtrlUnit]	Enter the lower feedback limit. When the feedback drops below this limit, the display reads $Feedb_{Low}$. The signal outputs can be programmed to produce a status signal on terminal

4-56 Warning Feedback Low		
Range:		Function:
		27 or 29, and on relay output 01 or 02.

4-57 Warning Feedback High		
Range:		Function:
999999.999 ProcessCtrlUnit*	[par. 4-56 - 999999.999 ProcessCtrlUnit]	Enter the upper feedback limit. When the feedback exceeds this limit, the display reads $Feedb_{High}$. The signal outputs can be programmed to produce a status signal on terminal 27 or 29, and on relay output 01 or 02.

4-58 Missing Motor Phase Function		
Option:		Function:
		<p>NOTICE</p> <p>This parameter cannot be adjusted while the motor is running.</p> <p>Displays an alarm if motor phase is missing.</p>
[0]	Disabled	No alarm is displayed if a missing motor phase occurs.
[1]	Trip 100 ms	An alarm is displayed if a missing motor phase occurs.
[2]	Trip 1000 ms	
[3]	Trip 100ms 3ph detec.	
[5]	Motor Check	

3.6.3 4-6* Speed Bypass

Some systems require that certain output frequencies or speeds are avoided, due to resonance problems in the system. A maximum of 4 frequency or speed ranges can be avoided.

4-60 Bypass Speed From [RPM]		
Array [4]		
Range:		Function:
Size related*	[0 - par. 4-13 RPM]	Some systems require that certain output frequencies or speeds are avoided due to resonance problems in the system. Enter the lower limits of the speeds to be avoided.

4-61 Bypass Speed From [Hz]		
Array [4]		
Range:		Function:
Size related*	[0 - par. 4-14 Hz]	Some systems require that certain output frequencies or speeds are avoided due to resonance problems in the system. Enter the lower limits of the speeds to be avoided.

4-62 Bypass Speed To [RPM]		
Array [4]		
Range:		Function:
Size related*	[0 - par. 4-13 RPM]	Some systems require that certain output frequencies or speeds are avoided due to resonance problems in the system. Enter the upper limits of the speeds to be avoided.

4-63 Bypass Speed To [Hz]		
Array [4]		
Range:		Function:
Size related*	[0 - par. 4-14 Hz]	Some systems require that certain output frequencies or speeds are avoided due to resonance problems in the system. Enter the upper limits of the speeds to be avoided.

deceleration. The actual frequencies registered when pressing [OK] are stored in *parameter 4-60 Bypass Speed From [RPM]* or *parameter 4-61 Bypass Speed From [Hz]*.

- When the motor has ramped down to stop, press [OK]. *Parameter 4-64 Semi-Auto Bypass Set-up* automatically resets to Off. The frequency converter stays in *Hand* mode until [Off] or [Auto On] is pressed on the LCP.

If the frequencies for a certain resonance band are not registered in the right order (frequency values stored in *Bypass Speed To* are higher than those in *Bypass Speed From*), or if they do not have the same numbers of registrations for the *Bypass From* and *Bypass To*, all registrations are cancelled and the following message is displayed: *Collected speed areas overlapping or not completely determined. Press [Cancel] to abort.*

4-64 Semi-Auto Bypass Set-up		
Option:	Function:	
[0] *	Off	No function.
[1]	Enabled	Starts the semi-automatic bypass set-up and continues with the procedure described above.

3.6.4 Semi-Automatic Bypass Speed Set-up

Use the semi-automatic bypass speed set-up to facilitate the programming of the frequencies to be skipped due to resonances in the system.

Carry out following process:

- Stop the motor.
- Select [1] Enabled in *parameter 4-64 Semi-Auto Bypass Set-up*.
- Press [Hand On] on the LCP to start the search for frequency bands causing resonances. The motor ramps up according to the ramp set.
- When sweeping through a resonance band, press [OK] on the LCP when leaving the band. The actual frequency is stored as the first element in *parameter 4-62 Bypass Speed To [RPM]* or *parameter 4-63 Bypass Speed To [Hz]* (array). Repeat this for each resonance band identified at the ramp-up (maximum 4 can be adjusted).
- When maximum speed has been reached, the motor automatically begins to ramp down. Repeat the above procedure when speed is leaving the resonance bands during the

3.7 Parameters: 5-** Main Menu - Digital In/Out

3.7.1 5-0* Digital I/O Mode

Parameters for configuring the input and output using NPN and PNP.

5-00 Digital I/O Mode		
Option:	Function:	
		NOTICE This parameter cannot be adjusted while the motor is running. Digital inputs and programmed digital outputs are pre-programmable for operation either in PNP or NPN systems.
[0] *	PNP - Active at 24V	Action on positive directional pulses (0). PNP systems are pulled down to GND.
[1]	NPN - Active at 0V	Action on negative directional pulses (1). NPN systems are pulled up to +24 V, internally in the frequency converter.

5-01 Terminal 27 Mode		
Option:	Function:	
		NOTICE This parameter cannot be adjusted while the unit is running.
[0] *	Input	Defines terminal 27 as a digital input.
[1]	Output	Defines terminal 27 as a digital output.

5-02 Terminal 29 Mode		
Option:	Function:	
		NOTICE This parameter cannot be adjusted while the motor is running.
[0] *	Input	Defines terminal 29 as a digital input.
[1]	Output	Defines terminal 29 as a digital output.

3.7.2 5-1* Digital Inputs

Parameters for configuring the input functions for the input terminals.

The digital inputs are used for selecting various functions in the frequency converter. All digital inputs can be set to the following functions:

Digital input function	Select	Terminal
No operation	[0]	All terminal 19, 32, 33

Digital input function	Select	Terminal
Reset	[1]	All
Coast inverse	[2]	27
Coast and reset inverse	[3]	All
DC brake inverse	[5]	All
Stop inverse	[6]	All
External interlock	[7]	All
Start	[8]	All terminal 18
Latched start	[9]	All
Reversing	[10]	All
Start reversing	[11]	All
Jog	[14]	All terminal 29
Preset reference on	[15]	All
Preset ref bit 0	[16]	All
Preset ref bit 1	[17]	All
Preset ref bit 2	[18]	All
Freeze reference	[19]	All
Freeze output	[20]	All
Speed up	[21]	All
Speed down	[22]	All
Set-up select bit 0	[23]	All
Set-up select bit 1	[24]	All
Pulse input	[32]	Terminal 29, 33
Ramp bit 0	[34]	All
Mains failure inverse	[36]	All
Fire mode	[37]	All
Run permissive	[52]	All
Hand start	[53]	All
Auto start	[54]	All
DigiPot increase	[55]	All
DigiPot decrease	[56]	All
DigiPot clear	[57]	All
Counter A (up)	[60]	29, 33
Counter A (down)	[61]	29, 33
Reset counter A	[62]	All
Counter B (up)	[63]	29, 33
Counter B (down)	[64]	29, 33
Reset counter B	[65]	All
Sleep mode	[66]	All
Reset maintenance word	[78]	All
PTC card 1	[80]	All
Lead pump start	[120]	All
Lead pump alternation	[121]	All
Pump 1 interlock	[130]	All
Pump 2 interlock	[131]	All
Pump 3 interlock	[132]	All

All=Terminals 18, 19, 27, 29, 32, 33, X30/2, X30/3, X30/4.
X30/ are the terminals on MCB 101.

Functions dedicated to only one digital input are stated in the associated parameter.

All digital inputs can be programmed to these functions

[0]	No operation	No reaction to signals transmitted to terminal.
[1]	Reset	Resets frequency converter after a trip/alarm. Not all alarms can be reset.
[2]	Coast inverse	Leaves motor in free mode. Logic 0⇒coasting stop. (Default Digital input 27): Coasting stop, inverted input (NC).
[3]	Coast and reset inverse	Reset and coasting stop, inverted input (NC). Leaves motor in free mode and resets the frequency converter. Logic 0⇒coasting stop and reset.
[5]	DC-brake inverse	Inverted input for DC braking (NC). Stops motor by energising it with a DC current for a certain time period. See <i>parameter 2-01 DC Brake Current</i> to <i>parameter 2-03 DC Brake Cut In Speed [RPM]</i> . The function is only active when the value in <i>parameter 2-02 DC Braking Time</i> is different from 0. Logic 0⇒DC braking. This selection is not possible when <i>parameter 1-10 Motor Construction</i> is set to [1] PM non-salient SPM.
[6]	Stop inverse	Stop inverted function. Generates a stop function when the selected terminal goes from logical level 1 to 0. The stop is performed according to the selected ramp time <ul style="list-style-type: none"> • <i>Parameter 3-42 Ramp 1 Ramp Down Time</i> • <i>Parameter 3-52 Ramp 2 Ramp Down Time</i> <p>NOTICE</p> <p>When the frequency converter is at the torque limit and has received a stop command, it may not stop by itself. To ensure that the frequency converter stops, configure a digital output to [27] Torque limit & stop and connect this digital output to a digital input that is configured as coast.</p>
[7]	External Interlock	Same function as coasting inverse and stop inverse, but this option generates the alarm message <i>External fault</i> on the display when the terminal programmed for coast inverse has signal 0. The alarm message is also active via digital outputs and relay outputs, if programmed for external interlock. When the external interlock is removed, the alarm can be reset using a digital input or the [RESET] key. A delay can be programmed in <i>parameter 22-00 External Interlock Delay</i> . After applying a signal to the input, the reaction

		described above is delayed with the time set in <i>parameter 22-00 External Interlock Delay</i> .																																				
[8]	Start	Select start for a start/stop command. Logic 1=start, logic 0=stop. (Default: Digital input 18).																																				
[9]	Latched start	The motor starts, if a pulse is applied for minimum. 2 ms. The motor stops when stop inverse is activated.																																				
[10]	Reversing	Changes direction of motor shaft rotation. Select Logic 1 to reverse. The reversing signal only changes the direction of rotation. It does not activate the start function. Select both directions in <i>parameter 4-10 Motor Speed Direction</i> . (Default: Digital input 19).																																				
[11]	Start reversing	Used for start/stop and for reversing on the same wire. Signals on start are not allowed at the same time.																																				
[14]	Jog	Used for activating jog speed. See <i>parameter 3-11 Jog Speed [Hz]</i> . (Default: Digital input 29)																																				
[15]	Preset reference on	Used for shifting between external reference and preset reference. It is assumed that <i>External/preset [1]</i> has been selected in <i>parameter 3-04 Reference Function</i> . Logic 0=external reference active; logic 1=1 of the 8 preset references is active.																																				
[16]	Preset ref bit 0	Enables a choice between 1 of the 8 preset references according to <i>Table 3.10</i> .																																				
[17]	Preset ref bit 1	Enables a choice between 1 of the 8 preset references according to <i>Table 3.10</i> .																																				
[18]	Preset ref bit 2	Enables a choice between 1 of the 8 preset references according to <i>Table 3.10</i> . <table border="1" data-bbox="1029 1339 1449 1668"> <thead> <tr> <th>Preset ref. bit</th> <th>2</th> <th>1</th> <th>0</th> </tr> </thead> <tbody> <tr> <td>Preset ref. 0</td> <td>0</td> <td>0</td> <td>0</td> </tr> <tr> <td>Preset ref. 1</td> <td>0</td> <td>0</td> <td>1</td> </tr> <tr> <td>Preset ref. 2</td> <td>0</td> <td>1</td> <td>0</td> </tr> <tr> <td>Preset ref. 3</td> <td>0</td> <td>1</td> <td>1</td> </tr> <tr> <td>Preset ref. 4</td> <td>1</td> <td>0</td> <td>0</td> </tr> <tr> <td>Preset ref. 5</td> <td>1</td> <td>0</td> <td>1</td> </tr> <tr> <td>Preset ref. 6</td> <td>1</td> <td>1</td> <td>0</td> </tr> <tr> <td>Preset ref. 7</td> <td>1</td> <td>1</td> <td>1</td> </tr> </tbody> </table> <p>Table 3.10 Digital Inputs Preset Reference Bit</p>	Preset ref. bit	2	1	0	Preset ref. 0	0	0	0	Preset ref. 1	0	0	1	Preset ref. 2	0	1	0	Preset ref. 3	0	1	1	Preset ref. 4	1	0	0	Preset ref. 5	1	0	1	Preset ref. 6	1	1	0	Preset ref. 7	1	1	1
Preset ref. bit	2	1	0																																			
Preset ref. 0	0	0	0																																			
Preset ref. 1	0	0	1																																			
Preset ref. 2	0	1	0																																			
Preset ref. 3	0	1	1																																			
Preset ref. 4	1	0	0																																			
Preset ref. 5	1	0	1																																			
Preset ref. 6	1	1	0																																			
Preset ref. 7	1	1	1																																			
[19]	Freeze ref	Freezes actual reference. The frozen reference is now the point of enable/condition for speed up and speed down to be used. If speed up/down is used, the speed change always follows ramp 2 (<i>parameter 3-51 Ramp 2 Ramp Up Time</i> and <i>parameter 3-52 Ramp 2 Ramp Down Time</i>) in the range 0 – 3-03 Maximum Reference. (For																																				

		closed loop, see <i>parameter 20-14 Maximum Reference/Feedb.</i> .
[20]	Freeze output	Freezes actual motor frequency (Hz). The frozen motor frequency is now the point of enable/condition for Speed up and Speed down to be used. If speed up/down is used, the speed change always follows ramp 2 (<i>parameter 3-51 Ramp 2 Ramp Up Time</i> and <i>parameter 3-52 Ramp 2 Ramp Down Time</i>) in the range 0 – <i>parameter 1-23 Motor Frequency</i> . NOTICE When <i>Freeze output</i> is active, the frequency converter cannot be stopped via a low [13] start signal. Stop the frequency converter via a terminal programmed for [2] <i>Coasting inverse</i> or [3] <i>Coast and reset, inverse</i> .
[21]	Speed up	Select [21] <i>Speed up</i> and [22] <i>Speed down</i> if digital control of the up/down speed is desired (motor potentiometer). Activate this function by selecting either [19] <i>Freeze ref</i> or [20] <i>Freeze output</i> . When speed up/down is activated for less than 400 ms, the resulting reference is increased/decreased by 0.1%. If speed up/down is activated for more than 400 ms, the resulting reference follows the setting in ramping up/down parameter 3-x1/3-x2.
[22]	Speed down	Same as [21] <i>Speed up</i> .
[23]	Set-up select bit 0	Selects one of the 4 set-ups. Set par. 0-10 to [9] <i>Multi Set-up</i> .
[24]	Set-up select bit 1	Same as [23] <i>Set-up select bit 0</i> .
[32]	Pulse input	Select [32] <i>Pulse input</i> when using a pulse sequence as either reference or feedback. Scaling is done in parameter group 5-5*.
[34]	Ramp bit 0	Select which ramp to use. Logic 0 selects ramp 1, while logic 1 selects ramp 2.
[36]	Mains failure inverse	Activates the function selected in <i>parameter 14-10 Mains Failure</i> . Mains failure is active in the logic 0 situation.
[37]	Fire mode	A signal applied puts the frequency converter into Fire mode and all other commands are disregarded. See 24-0* <i>Fire Mode</i> .
[52]	Run Permissive	The input terminal, for which the run permissive has been programmed must be logic 1 before a start command can be accepted. Run permissive has a logic AND function related to the terminal which is programmed for [8] <i>Start</i> , [14] <i>Jog</i> or [20] <i>Freeze Output</i> . To start running the motor, both conditions must be fulfilled. If Run Permissive is programmed on multiple terminals, [52] <i>Run permissive</i> needs only be

		logic 1 on 1 of the terminals to carry out the function. The digital output signal for Run Request ([8] <i>Start</i> , [14] <i>Jog</i> or [20] <i>Freeze output</i>) programmed in parameter group 5-3* <i>Digital Outputs</i> , or parameter group 5-4* <i>Relays</i> , is not affected by run permissive. NOTICE If no run permissive signal is applied, but either Run, Jog or Freeze commands are activated, the status line in the display shows either Run Requested, Jog Requested, or Freeze Requested.
[53]	Hand start	A signal applied puts the frequency converter into <i>Hand</i> mode as if [Hand On] was pressed on the LCP has been pressed and a normal stop command is overridden. If disconnecting the signal, the motor stops. To make any other start commands valid, another digital input must be assigned to [54] <i>Auto Start</i> and a signal applied to this. The [Hand On] and [Auto On] keys on the LCP have no impact. The [Off] key on the LCP overrides [53] <i>Hand Start</i> and [54] <i>Auto Start</i> . Press either [Hand On] or [Auto On] to make [53] <i>Hand Start</i> and [54] <i>Auto Start</i> active again. If no signal on neither [53] <i>Hand Start</i> nor [54] <i>Auto Start</i> , the motor stops regardless of any normal start command applied. If signals are applied to both [53] <i>Hand Start</i> and [54] <i>Auto Start</i> , the function is <i>Auto Start</i> . If pressing [Off] on the LCP, the motor stops regardless of signals on [53] <i>Hand Start</i> and [54] <i>Auto Start</i> .
[54]	Auto start	A signal applied puts the frequency converter into <i>Auto</i> mode as if [Auto On] has been pressed. See also [53] <i>Hand Start</i> .
[55]	DigiPot Increase	Uses the input as an increase signal to the digital potentiometer function described in parameter group 3-9*.
[56]	DigiPot Decrease	Uses the input as a decrease signal to the digital potentiometer function described in parameter group 3-9*.
[57]	DigiPot Clear	Uses the input to clear the digital potentiometer reference described in parameter group 3-9*
[60]	Counter A (up)	(Terminal 29 or 33 only). Input for increment counting in the SLC counter.
[61]	Counter A (down)	(Terminal 29 or 33 only). Input for decrement counting in the SLC counter.
[62]	Reset Counter A	Input for reset of counter A.
[63]	Counter B (up)	(Terminal 29 and 33 only). Input for increment counting in the SLC counter.
[64]	Counter B (down)	(Terminal 29 and 33 only). Input for decrement counting in the SLC counter.

[65]	Reset Counter B	Input for reset of counter B.
[66]	Sleep Mode	Forces frequency converter into Sleep mode (see parameter group 22-4*). Reacts on the rising edge of signal applied.
[68]	Timed Actions Disabled	Timed actions are disabled. See parameter group 23-0* <i>Timed Actions</i> .
[69]	Constant OFF	<i>Timed Actions</i> are set for <i>Constant OFF</i> . See parameter group 23-0* <i>Timed Actions</i> .
[70]	Constant ON	<i>Timed Actions</i> are set for <i>Constant ON</i> . See parameter group 23-0* <i>Timed Actions</i> .
[78]	Reset Preventive Maintenance Word	Resets all data in <i>parameter 16-96 Maintenance Word</i> to 0.
[80]	PTC Card 1	ALI digital inputs can be set to [80] <i>PTC Card 1</i> . However, only 1 digital input must be set to this option.

5-10 Terminal 18 Digital Input

The parameter contains all options and functions listed in parameter group 5-1* *Digital Inputs* except for option [32] *Pulse input*.

5-11 Terminal 19 Digital Input

The parameter contains all options and functions listed in parameter group 5-1* *Digital Inputs* except for option [32] *Pulse input*.

5-12 Terminal 27 Digital Input

Option: **Function:**

[2] *	Coast inverse	Functions are described under parameter group 5-1* <i>Digital Inputs</i> .
-------	---------------	--

5-13 Terminal 29 Digital Input

Option: **Function:**

		Select the function from the available digital input range and the additional options [60] <i>Counter A (up)</i> , [61] <i>Counter A (down)</i> , [63] <i>Counter B (up)</i> and [64] <i>Counter B (down)</i> . Counters are used in smart logic control functions.
[14] *	Jog	Functions are described under parameter group 5-1* <i>Digital Inputs</i>

5-14 Terminal 32 Digital Input

The parameter contains all options and functions listed in parameter group 5-1* *Digital Inputs* except for option [32] *Pulse input*.

5-15 Terminal 33 Digital Input

The parameter contains all options and functions listed in parameter group 5-1* *Digital Inputs*.

5-16 Terminal X30/2 Digital Input

Option: **Function:**

[0] *	No operation	This parameter is active when option module MCB 101 is installed in the frequency converter. The parameter contains all options and functions listed in parameter group 5-1* <i>Digital Inputs</i> except for option [32] <i>Pulse input</i> .
-------	--------------	--

5-17 Terminal X30/3 Digital Input

Option: **Function:**

[0] *	No operation	This parameter is active when option module MCB 101 is installed in the frequency converter. The parameter contains all options and functions listed in parameter group 5-1* <i>Digital Inputs</i> except for option [32] <i>Pulse input</i> .
-------	--------------	--

5-18 Terminal X30/4 Digital Input

Option: **Function:**

[0] *	No operation	This parameter is active when option module MCB 101 is installed in the frequency converter. The parameter contains all options and functions listed in parameter group 5-1* <i>Digital Inputs</i> except for option [32] <i>Pulse input</i> .
-------	--------------	--

5-19 Terminal 37 Safe Stop

Use this parameter to configure the Safe Torque Off functionality. A warning message makes the frequency converter coast the motor and enables the automatic restart. An alarm message makes the frequency converter coast the motor and requires a manual restart (via a fieldbus, Digital I/O, or by pressing [RESET] on the LCP). When the VLT[®] *PTC Thermistor Card MCB 112* is mounted, configure the PTC options to get the full benefit from the alarm handling.

Option: **Function:**

[1]	Safe Stop Alarm	Coasts frequency converter when Safe Torque Off is activated. Manual reset from LCP, digital input, or fieldbus.
[3]	Safe Stop Warning	Coasts the frequency converter when Safe Torque Off is activated (terminal 37 off). When the safe-stop circuit is re-established, the frequency converter continues without manual reset.
[4]	PTC 1 Alarm	Coasts frequency converter when Safe Torque Off is activated. Manual reset from LCP, digital input, or fieldbus.
[5]	PTC 1 Warning	Coasts frequency converter when Safe Torque Off is activated (terminal 37 off). When Safe Torque Off circuit is re-established, the frequency

5-19 Terminal 37 Safe Stop		
Use this parameter to configure the Safe Torque Off functionality. A warning message makes the frequency converter coast the motor and enables the automatic restart. An alarm message makes the frequency converter coast the motor and requires a manual restart (via a fieldbus, Digital I/O, or by pressing [RESET] on the LCP). When the <i>VLT® PTC Thermistor Card MCB 112</i> is mounted, configure the PTC options to get the full benefit from the alarm handling.		
Option:	Function:	
		converter continues without manual reset, unless a digital input set to [80] <i>PTC Card 1</i> is still enabled.
[6]	PTC 1 & Relay A	This option is used when the PTC option gates with a stop key through a safety relay to terminal 37. Coasts frequency converter when Safe Torque Off is activated. Manual reset from LCP, digital input, or fieldbus.
[7]	PTC 1 & Relay W	This option is used when the PTC option gates with a stop key through a safety relay to terminal 37. Coasts frequency converter when Safe Torque Off is activated (terminal 37 off). When safe-stop circuit is re-established, the frequency converter continues without manual reset, unless a digital input set to [80] <i>PTC Card 1</i> is still enabled.
[8]	PTC 1 & Relay A/W	This option makes it possible to use a combination of Alarm and Warning.
[9]	PTC 1 & Relay W/A	This option makes it possible to use a combination of Alarm and Warning.

NOTICE

Options [4] *PTC 1 Alarm* to [9] *PTC 1 & Relay W/A* are only available when the MCB 112 is connected.

NOTICE

Selecting *Auto Reset/Warning* enables automatic restart of the frequency converter.

Function	Number	PTC	Relay
No Function	[0]	-	-
Safe Torque Off Alarm	[1]*	-	Safe Torque Off [A68]
Safe Torque Off Warning	[3]	-	Safe Torque Off [W68]
PTC 1 Alarm	[4]	PTC 1 Safe Torque Off [A71]	-
PTC 1 Warning	[5]	PTC 1 Safe Torque Off [W71]	-
PTC 1 & Relay A	[6]	PTC 1 Safe Torque Off [A71]	Safe Torque Off [A68]
PTC 1 & Relay W	[7]	PTC 1 Safe Torque Off [W71]	Safe Torque Off [W68]
PTC 1 & Relay A/W	[8]	PTC 1 Safe Torque Off [A71]	Safe Torque Off [W68]
PTC 1 & Relay W/A	[9]	PTC 1 Safe Torque Off [W71]	Safe Torque Off [A68]

Table 3.11 Overview of Functions, Alarms, and Warnings

W means warning and *A* means alarm. For further information, see *Alarms and Warnings* in the *Troubleshooting* section in the *Design Guide* or the *Operating Instructions*.

A dangerous failure related to Safe Torque Off issues *Alarm 72 Dangerous Failure*.

Refer to *Table 4.3*.

3.7.3 5-3* Digital Outputs

Parameters for configuring the output functions for the output terminals. The 2 solid-state digital outputs are common for terminals 27 and 29. Set the I/O function for terminal 27 in *parameter 5-01 Terminal 27 Mode* and set the I/O function for terminal 29 in *parameter 5-02 Terminal 29 Mode*. These parameters cannot be adjusted while the motor is running.

		The digital outputs can be programmed with these functions:
[0]	No operation	Default for all digital outputs and relay outputs.
[1]	Control ready	The control board receives supply voltage.
[2]	Drive ready	The frequency converter is ready for operation and applies a supply signal on the control board.
[3]	Drive ready / remote control	The frequency converter is ready for operation and is in <i>Auto On</i> mode.
[4]	Stand-by / no warning	The frequency converter is ready for operation. No start or stop command is given (start/disable). There are no warnings.
[5]	Running	The motor is running.

[6]	Running / no warning	The output speed is higher than the speed set in <i>parameter 1-81 Min Speed for Function at Stop [RPM]</i> . The motor is running and there are no warnings.
[8]	Run on reference / no warning	The motor runs at reference speed.
[9]	Alarm	An alarm activates the output. There are no warnings.
[10]	Alarm or warning	An alarm or a warning activates the output.
[11]	At torque limit	The torque limit set in <i>parameter 4-16 Torque Limit Motor Mode</i> or <i>parameter 4-13 Motor Speed High Limit [RPM]</i> has been exceeded.
[12]	Out of current range	The motor current is outside the range set in <i>parameter 4-18 Current Limit</i> .
[13]	Below current, low	The motor current is lower than set in <i>parameter 4-50 Warning Current Low</i> .
[14]	Above current, high	The motor current is higher than set in <i>4-51 Warning Current High</i> .
[16]	Below speed, low	The output speed is lower than the setting in <i>parameter 4-52 Warning Speed Low</i> .
[17]	Above speed, high	The output speed is higher than the setting in <i>parameter 4-53 Warning Speed High</i> .
[18]	Out of feedback range	The feedback is outside the range set in <i>parameter 4-56 Warning Feedback Low</i> and <i>parameter 4-57 Warning Feedback High</i> .
[19]	Below feedback low	The feedback is below the limit set in <i>parameter 4-56 Warning Feedback Low</i> .
[20]	Above feedback high	The feedback is above the limit set in <i>parameter 4-57 Warning Feedback High</i> .
[21]	Thermal warning	The thermal warning turns on when the temperature exceeds the limit in the motor, the frequency converter, the brake resistor, or the thermistor.
[25]	Reverse	The motor runs (or is ready to run) clockwise when there is a logic 0 signal and counterclockwise when there is a logic 1 signal. The output changes as soon as the reversing signal is applied.
[26]	Bus OK	Active communication (no time-out) via the serial communication port.
[27]	Torque limit and stop	Use this option to perform a coasting stop and in torque limit condition. If the frequency converter has received a stop signal and is at the torque limit, the signal is logic 0.
[28]	Brake, no warning	The brake is active and there are no warnings.
[29]	Brake ready, no fault	The brake is ready for operation and there are no faults.
[30]	Brake fault (IGBT)	The output is logic 1 when the brake IGBT is short-circuited. Use this function to protect the frequency converter if there is

		a fault on the brake modules. Use the output/relay to cut out the main voltage from the frequency converter.
[35]	External Interlock	The external interlock function has been activated via one of the digital inputs.
[40]	Out of ref range	
[41]	Below reference low	
[42]	Above reference high	
[45]	Bus Ctrl	
[46]	Bus Ctrl 1 if timeout	
[47]	Bus Ctrl 0 if timeout	
[60]	Comparator 0	See parameter group 13-1* Comparators. If comparator 0 is evaluated as TRUE, the output goes high. Otherwise, it is low.
[61]	Comparator 1	See parameter group 13-1* Comparators. If comparator 2 is evaluated as TRUE, the output goes high. Otherwise, it is low.
[62]	Comparator 2	See parameter group 13-1* Comparators. If comparator 2 is evaluated as TRUE, the output goes high. Otherwise, it is low.
[63]	Comparator 3	See parameter group 13-1* Comparators. If comparator 3 is evaluated as TRUE, the output goes high. Otherwise, it is low.
[64]	Comparator 4	See parameter group 13-1* Comparators. If comparator 4 is evaluated as TRUE, the output goes high. Otherwise, it is low.
[65]	Comparator 5	See parameter group 13-1* Comparators. If comparator 5 is evaluated as TRUE, the output goes high. Otherwise, it is low.
[70]	Logic Rule 0	See parameter group 13-4* Logic Rules. If logic rule 0 is evaluated as TRUE, the output goes high. Otherwise, it is low.
[71]	Logic Rule 1	See parameter group 13-4* Logic Rules. If logic rule 1 is evaluated as TRUE, the output goes high. Otherwise, it is low.
[72]	Logic Rule 2	See parameter group 13-4* Logic Rules. If logic rule 2 is evaluated as TRUE, the output goes high. Otherwise, it is low.
[73]	Logic Rule 3	See parameter group 13-4* Logic Rules. If logic rule 3 is evaluated as TRUE, the output goes high. Otherwise, it is low.
[74]	Logic Rule 4	See parameter group 13-4* Logic Rules. If logic rule 4 is evaluated as TRUE, the output goes high. Otherwise, it is low.
[75]	Logic Rule 5	See parameter group 13-4* Logic Rules. If logic rule 5 is evaluated as TRUE, the output goes high. Otherwise, it is low.
[80]	SL Digital Output A	See <i>parameter 13-52 SL Controller Action</i> . The input will go high whenever the smart logic action [38] <i>Set dig. out. A high</i> is

		executed. The input goes low whenever the smart logic action [32] Set dig. out. A low is executed.
[81]	SL Digital Output B	See <i>parameter 13-52 SL Controller Action</i> . The input goes high whenever the smart logic action [39] Set dig. out. B high is executed. The input goes low whenever the smart logic action [33] Set dig. out. B low is executed.
[82]	SL Digital Output C	See <i>parameter 13-52 SL Controller Action</i> . The input goes high whenever the smart logic action [40] Set dig. out. C high is executed. The input goes low whenever the smart logic action [34] Set dig. out. C low is executed.
[83]	SL Digital Output D	See <i>parameter 13-52 SL Controller Action</i> . The input goes high whenever the smart logic action [41] Set dig. out. D high is executed. The input goes low whenever the smart logic action [35] Set dig. out. D low is executed.
[84]	SL Digital Output E	See <i>parameter 13-52 SL Controller Action</i> . The input goes high whenever the smart logic action [42] Set dig. out. E high is executed. The input goes low whenever the smart logic action [36] Set dig. out. E low is executed.
[85]	SL Digital Output F	See <i>parameter 13-52 SL Controller Action</i> . The input goes high whenever the smart logic action [43] Set dig. out. F high is executed. The input goes low whenever the smart logic action [37] Set dig. out. F low is executed.
[160]	No alarm	The output is high when no alarm is present.
[161]	Running reverse	The output is high when the frequency converter is running counter clockwise (the logical product of the status bits running AND reverse).
[165]	Local reference active	The output is high when 3-13 Reference Site=[2] Local or when 3-13 Reference Site=[0] Linked to hand auto at the same time as the LCP is in Hand mode.
[166]	Remote reference active	The output is high when 3-13 Reference Site = [1] Remote or [0] Linked to hand/auto while the LCP is in Auto onmode.
[167]	Start command active	The output is high when there is an active start command (that is via digital input, bus connection, [Hand on] or [Auto on]), and no stop command is active.
[168]	Drive in hand mode	The output is high when the frequency converter is in Hand mode (as indicated by the LED light above [Hand On]).
[169]	Drive in auto mode	The output is high when the frequency converter is in Hand mode (as indicated by the LED light above [Auto on]).

[180]	Clock Fault	The clock function has been reset to default (2000-01-01) because of a power failure.
[181]	Preventive Maintenance	1 or more of the preventive maintenance events programmed in <i>parameter 23-10 Maintenance Item</i> has passed the time for the specified action in <i>parameter 23-11 Maintenance Action</i> .
[193]	Sleep Mode	The frequency converter/system has turned into sleep mode. See parameter group 22-4* Sleep Mode.
[194]	Broken Belt	A broken belt condition has been detected. This function must be enabled in <i>parameter 22-60 Broken Belt Function</i> .
[196]	Fire Mode	The frequency converter is operating in Fire mode. See parameter group 24-0* Fire Mode.
[198]	Drive Bypass	To be used as signal for activating an external electromechanical bypass, switching the motor direct on line. See 24-1* Drive Bypass. CAUTION If enabling the drive bypass function, the frequency converter is no longer safety certified (for using the Safe Torque Off in versions where included).

The below setting options are all related to the cascade controller.

Wiring diagrams and settings for parameter, see parameter group 25-** Cascade Pack Controller for more details.

[200]	Full Capacity	All pumps running and at full speed.
[201]	Pump1 Running	1 or more of the pumps controlled by the cascade controller are running. The function also depends on <i>parameter 25-06 Number of Pumps</i> . If set to [0] No, Pump 1 refers to the pump controlled by relay RELAY1 etc. If set to [1] Yes, Pump 1 refers to the pump controlled by the frequency converter only (without any of the built-in relays involved), and Pump 2 to the pump controlled by the relay RELAY1. See Table 3.12.
[202]	Pump2 Running	See [201] Pump1 Running
[203]	Pump3 Running	See [201] Pump1 Running

Setting in parameter group 5-3* Digital Outputs	Setting in parameter 25-06 Number of Pumps	
	[0] No	[1] Yes
[200] Pump 1 Running	Controlled by RELAY1	Frequency converter controlled
[201] Pump 2 Running	Controlled by RELAY2	Controlled by RELAY1
[203] Pump 3 Running	Controlled by RELAY3	Controlled by RELAY2

Table 3.12 Settings

5-30 Terminal 27 Digital Output

This parameter has the options described in *chapter 3.7.3 5-3* Digital Outputs* *chapter 3.7.4 5-3* Digital Outputs*.

Option: **Function:**

[0] *	No operation	
-------	--------------	--

5-31 Terminal 29 Digital Output

This parameter has the options described in *chapter 3.7.3 5-3* Digital Outputs* *chapter 3.7.4 5-3* Digital Outputs*.

Option: **Function:**

[0] *	No operation	
-------	--------------	--

This parameter has the options described in *chapter 3.7.3 5-3* Digital Outputs* *chapter 3.7.4 5-3* Digital Outputs*.

5-32 Term X30/6 Digi Out (MCB 101)

Option: **Function:**

[0] *	No operation	This parameter is active when option module MCB 101 is mounted in the frequency converter.
-------	--------------	--

5-33 Term X30/7 Digi Out (MCB 101)

Option: **Function:**

[0] *	No operation	This parameter is active when option module MCB 101 is mounted in the frequency converter. Same options and functions as parameter group 5-3* Digital Outputs.
-------	--------------	--

3.7.4 5-4* Relays

Parameters for configuring the timing and the output functions for the relays.

5-40 Function Relay

Array [8]
(Relay 1 [0], Relay 2 [1])
Option MCB 105: Relay 7 [6], Relay 8 [7] and Relay 9 [8]).
Select options to define the function of the relays.
The selection of each mechanical relay is realised in an array parameter.

Option: **Function:**

[0]	No operation	
-----	--------------	--

5-40 Function Relay		
Array [8] (Relay 1 [0], Relay 2 [1]) Option MCB 105: Relay 7 [6], Relay 8 [7] and Relay 9 [8]). Select options to define the function of the relays. The selection of each mechanical relay is realised in an array parameter.		
Option:		Function:
[1]	Control Ready	
[2]	Drive ready	
[3]	Drive rdy/rem ctrl	
[4]	Standby / no warning	
[5]	Running	Default setting for relay 2.
[6]	Running / no warning	
[8]	Run on ref/no warn	
[9]	Alarm	Default setting for relay 1.
[10]	Alarm or warning	
[11]	At torque limit	
[12]	Out of current range	
[13]	Below current, low	
[14]	Above current, high	
[15]	Out of speed range	
[16]	Below speed, low	
[17]	Above speed, high	
[18]	Out of feedb. range	
[19]	Below feedback, low	
[20]	Above feedback, high	
[21]	Thermal warning	
[25]	Reverse	
[26]	Bus OK	
[27]	Torque limit & stop	
[28]	Brake, no brake war	
[29]	Brake ready, no fault	
[30]	Brake fault (IGBT)	
[31]	Relay 123	
[33]	Safe stop active	
[35]	External Interlock	
[36]	Control word bit 11	
[37]	Control word bit 12	
[40]	Out of ref range	
[41]	Below reference, low	
[42]	Above ref, high	
[45]	Bus ctrl.	
[46]	Bus ctrl, 1 if timeout	
[47]	Bus ctrl, 0 if timeout	
[60]	Comparator 0	
[61]	Comparator 1	
[62]	Comparator 2	
[63]	Comparator 3	
[64]	Comparator 4	
[65]	Comparator 5	
[70]	Logic rule 0	

5-40 Function Relay		
Array [8] (Relay 1 [0], Relay 2 [1]) Option MCB 105: Relay 7 [6], Relay 8 [7] and Relay 9 [8]). Select options to define the function of the relays. The selection of each mechanical relay is realised in an array parameter.		
Option:	Function:	
[71]	Logic rule 1	
[72]	Logic rule 2	
[73]	Logic rule 3	
[74]	Logic rule 4	
[75]	Logic rule 5	
[80]	SL digital output A	
[81]	SL digital output B	
[82]	SL digital output C	
[83]	SL digital output D	
[84]	SL digital output E	
[85]	SL digital output F	
[160]	No alarm	
[161]	Running reverse	
[165]	Local ref active	
[166]	Remote ref active	
[167]	Start command activ	
[168]	Hand / Off	
[169]	Auto mode	
[180]	Clock Fault	
[181]	Prev. Maintenance	
[188]	AHF Capacitor Connect	
[189]	External Fan Control	
[190]	No-Flow	
[191]	Dry Pump	
[192]	End Of Curve	
[193]	Sleep Mode	
[194]	Broken Belt	
[195]	Bypass Valve Control	
[196]	Fire Mode	
[197]	Fire Mode was Act.	
[198]	Drive Bypass	
[211]	Cascade Pump 1	
[212]	Cascade Pump 2	
[213]	Cascade Pump 3	

5-41 On Delay, Relay		
Array [2], (Relay 1 [0], Relay 2 [1])		
Range:	Function:	
0.01 s*	[0.01 - 600 s]	Enter the delay of the relay cut-in time. Select 1 of 2 internal mechanical relays in an array function. See 5-40 Function Relay for details.

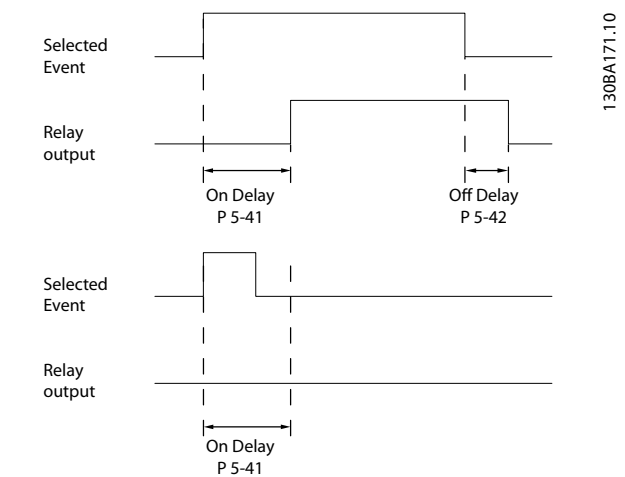

Illustration 3.25 On Delay, Relay

5-42 Off Delay, Relay		
Array[2]: Relay1[0], Relay2[1]		
Range:	Function:	
0.01 s*	[0.01 - 600 s]	Enter the delay of the relay cut out time. Select 1 of 2 internal mechanical relays in an array function. See 5-40 Function Relay for details. If the selected event condition changes before a delay timer expires, the relay output is unaffected.

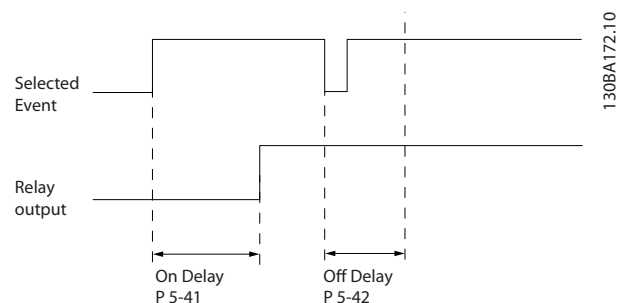

Illustration 3.26 Off Delay, Relay

If the selected event condition changes before the on delay or off delay timer expires, the relay output is unaffected.

3.7.5 5-5* Pulse Input

The pulse input parameters are used to define an appropriate window for the impulse reference area by configuring the scaling and filter settings for the pulse inputs. Input terminal 29 or 33 acts as frequency reference inputs. Set terminal 29 (parameter 5-13 Terminal 29 Digital Input) or terminal 33 (5-15 Terminal 33 Digital Input) to [32] Pulse input. If terminal 29 is used as an input, set parameter 5-02 Terminal 29 Mode to [0] Input.

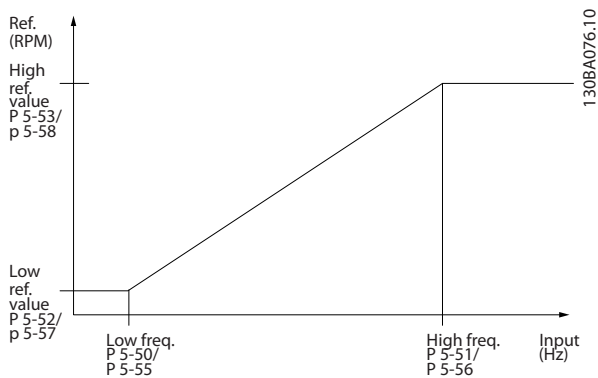

Illustration 3.27 Pulse Input

5-50 Term. 29 Low Frequency		
Range:	Function:	
100 Hz*	[0 - 110000 Hz]	Enter the low frequency limit corresponding to the low motor shaft speed (that is low reference value) in <i>parameter 5-52 Term. 29 Low Ref./Feedb. Value</i> . Refer to <i>Illustration 3.27</i> in this section.

5-51 Term. 29 High Frequency		
Range:	Function:	
100 Hz*	[0 - 110000 Hz]	Enter the high frequency limit corresponding to the high motor shaft speed (that is high reference value) in <i>parameter 5-53 Term. 29 High Ref./Feedb. Value</i> .

5-52 Term. 29 Low Ref./Feedb. Value		
Range:	Function:	
0*	[-999999.999 - 999999.999]	Enter the low reference value limit for the motor shaft speed [RPM]. This is also the lowest feedback value, see also <i>parameter 5-57 Term. 33 Low Ref./Feedb. Value</i> .

5-53 Term. 29 High Ref./Feedb. Value		
Range:	Function:	
100*	[-999999.999 - 999999.999]	Enter the high reference value [RPM] for the motor shaft speed and the high feedback value, see also <i>parameter 5-58 Term. 33 High Ref./Feedb. Value</i> .

5-54 Pulse Filter Time Constant #29		
Range:	Function:	
100 ms*	[1 - 1000 ms]	NOTICE This parameter cannot be adjusted while the motor is running.

5-54 Pulse Filter Time Constant #29		
Range:	Function:	
		Enter the pulse filter time constant. The pulse filter dampens oscillations of the feedback signal, which is an advantage if there is a lot of noise in the system. A high time constant value results in better dampening, but also increases the time delay through the filter.

5-55 Term. 33 Low Frequency		
Range:	Function:	
100 Hz*	[0 - 110000 Hz]	Enter the low frequency corresponding to the low motor shaft speed (that is low reference value) in <i>parameter 5-57 Term. 33 Low Ref./Feedb. Value</i> .

5-56 Term. 33 High Frequency		
Range:	Function:	
100 Hz*	[0 - 110000 Hz]	Enter the high frequency corresponding to the high motor shaft speed (that is high reference value) in <i>parameter 5-58 Term. 33 High Ref./Feedb. Value</i> .

5-57 Term. 33 Low Ref./Feedb. Value		
Range:	Function:	
0*	[-999999.999 - 999999.999]	Enter the low reference value [RPM] for the motor shaft speed. This is also the low feedback value, see also <i>parameter 5-52 Term. 29 Low Ref./Feedb. Value</i> .

5-58 Term. 33 High Ref./Feedb. Value		
Range:	Function:	
100*	[-999999.999 - 999999.999]	Enter the high reference value [RPM] for the motor shaft speed. See also <i>parameter 5-53 Term. 29 High Ref./Feedb. Value</i> .

5-59 Pulse Filter Time Constant #33		
Range:	Function:	
100 ms*	[1 - 1000 ms]	Enter the pulse filter time constant. The low-pass filter reduces the influence, and dampens oscillations on the feedback signal from the control. This is an advantage if there is a great amount of noise in the system.

3.7.6 5-6* Pulse Outputs

Parameters for configuring the scaling and output functions of pulse outputs. The pulse outputs are designated to terminals 27 or 29. Select terminal 27 output in *parameter 5-01 Terminal 27 Mode* and terminal 29 output in *parameter 5-02 Terminal 29 Mode*.

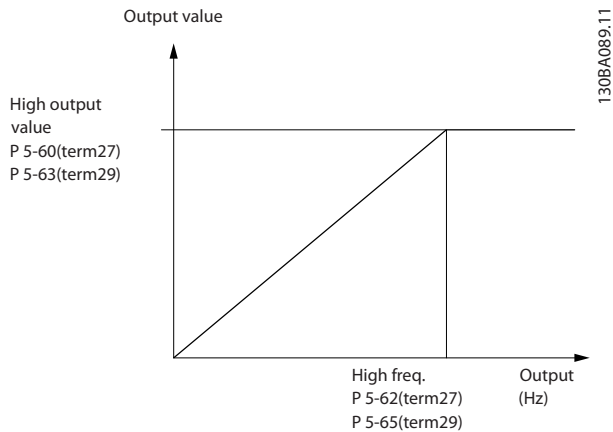

Illustration 3.28 Pulse Outputs

Options for readout output variables

- [0] No operation
- [45] Bus ctrl.
- [48] Bus ctrl. timeout
- [100] Output frequency
- [101] Reference
- [102] Feedback
- [103] Motor current
- [104] Torque relative to limit
- [105] Torque relative to rated
- [106] Power
- [107] Speed
- [113] Ext. Closed Loop
- [114] Ext. Closed Loop
- [115] Ext. Closed Loop

Select the operation variable assigned for terminal 27 readouts.

This meter cannot be adjusted while the motor is running. Same options and functions as parameter group 5-6* Pulse Output.

[0] *	No operation	
-------	--------------	--

5-60 Terminal 27 Pulse Output Variable		
Option:	Function:	
[0] *	No operation	
[45]	Bus ctrl.	

5-60 Terminal 27 Pulse Output Variable		
Option:	Function:	
[48]	Bus ctrl., timeout	
[100]	Output freq. 0-100	
[101]	Reference Min-Max	
[102]	Feedback +-200%	
[103]	Motor cur. 0-lmax	
[104]	Torque 0-Tlim	
[105]	Torque 0-Tnom	
[106]	Power 0-Pnom	
[107]	Speed 0-HighLim	
[113]	Ext. Closed Loop 1	
[114]	Ext. Closed Loop 2	
[115]	Ext. Closed Loop 3	

5-62 Pulse Output Max Freq #27		
Range:	Function:	
		NOTICE This parameter cannot be adjusted while the motor is running.
5000 Hz*	[0 - 32000 Hz]	Set the maximum frequency for terminal 27 corresponding to the output variable selected in <i>parameter 5-60 Terminal 27 Pulse Output Variable</i> .

5-63 Terminal 29 Pulse Output Variable		
Option:	Function:	
		NOTICE This parameter cannot be adjusted while the motor is running. Select the variable for viewing on the terminal 29 display. Same options and functions as parameter group 5-6* Pulse Output.
[0] *	No operation	
[45]	Bus ctrl.	
[48]	Bus ctrl., timeout	
[100]	Output freq. 0-100	
[101]	Reference Min-Max	
[102]	Feedback +-200%	
[103]	Motor cur. 0-lmax	
[104]	Torque 0-Tlim	
[105]	Torque 0-Tnom	
[106]	Power 0-Pnom	
[107]	Speed 0-HighLim	
[113]	Ext. Closed Loop 1	
[114]	Ext. Closed Loop 2	
[115]	Ext. Closed Loop 3	

5-65 Pulse Output Max Freq #29		
Range:		Function:
5000 Hz*	[0 - 32000 Hz]	Set the maximum frequency for terminal 29 corresponding to the output variable set in <i>parameter 5-63 Terminal 29 Pulse Output Variable</i> .

5-66 Terminal X30/6 Pulse Output Variable		
Select the variable for readout on terminal X30/6.		
This parameter is active when option module MCB 101 is installed in the frequency converter.		
Same options and functions as parameter group 5-6* <i>Pulse Outputs</i> .		
Option:	Function:	
[0] *	No operation	
[45]	Bus ctrl.	
[48]	Bus ctrl., timeout	
[100]	Output freq. 0-100	
[101]	Reference Min-Max	
[102]	Feedback +-200%	
[103]	Motor cur. 0-Imax	
[104]	Torque 0-Tlim	
[105]	Torque 0-Tnom	
[106]	Power 0-Pnom	
[107]	Speed 0-HighLim	
[113]	Ext. Closed Loop 1	
[114]	Ext. Closed Loop 2	
[115]	Ext. Closed Loop 3	

5-68 Pulse Output Max Freq #X30/6		
Range:		Function:
Size related*	[0 - 32000 Hz]	Select the maximum frequency on terminal X30/6 referring to the output variable in <i>parameter 5-66 Terminal X30/6 Pulse Output Variable</i> . This parameter is active when option module MCB 101 is installed in the frequency converter.

3.7.7 5-8* I/O Options

5-80 AHF Cap Reconnect Delay		
Range:		Function:
25 s*	[1 - 120 s]	Guarantees a minimum off-time for the capacitors. The timer starts once the AHF capacitor disconnects and needs to expire before the output is allowed to be on again. It only turns on again if the drive power is between 20% and 30%.

3.7.8 5-9* Bus-Controlled

This parameter group selects digital and relay outputs via a fieldbus setting.

5-90 Digital & Relay Bus Control		
Range:		Function:
0*	[0 - 2147483647]	This parameter holds the state of the digital outputs and relays that is controlled by bus. A logical '1' indicates that the output is high or active. A logical '0' indicates that the output is low or inactive.
Bit 0	CC digital output terminal 27	
Bit 1	CC digital output terminal 29	
Bit 2	GPIO digital output terminal X 30/6	
Bit 3	GPIO digital output terminal X 30/7	
Bit 4	CC relay 1 output terminal	
Bit 5	CC relay 2 output terminal	
Bit 6	Option B relay 1 output terminal	
Bit 7	Option B relay 2 output terminal	
Bit 8	Option B relay 3 output terminal	
Bit 9-15	Reserved for future terminals	
Bit 16	Option C relay 1 output terminal	
Bit 17	Option C relay 2 output terminal	
Bit 18	Option C relay 3 output terminal	
Bit 19	Option C relay 4 output terminal	
Bit 20	Option C relay 5 output terminal	
Bit 21	Option C relay 6 output terminal	
Bit 22	Option C relay 7 output terminal	
Bit 23	Option C relay 8 output terminal	
Bit 24-31	Reserved for future terminals	

Table 3.13 Digital Output Bits

5-93 Pulse Out #27 Bus Control		
Range:		Function:
0 %*	[0 - 100 %]	Contains the frequency to apply to the digital output terminal 27 when it is configured as bus-controlled.

5-94 Pulse Out #27 Timeout Preset		
Range:		Function:
0 %*	[0 - 100 %]	Contains the frequency to apply to the digital output terminal 27, when it is configured as bus-controlled time-out and timeout is detected.

5-95 Pulse Out #29 Bus Control		
Range:		Function:
0 %*	[0 - 100 %]	Contains the frequency to apply to the digital output terminal 29, when it is configured as bus-controlled.

5-96 Pulse Out #29 Timeout Preset		
Range:		Function:
0 %*	[0 - 100 %]	Contains the frequency to apply to the digital output terminal 29, when it is configured as bus-controlled timeout and timeout is detected

5-97 Pulse Out #X30/6 Bus Control		
Range:		Function:
0 %*	[0 - 100 %]	Contains the frequency to apply to the digital output terminal 27, when it is configured as bus-controlled.

5-98 Pulse Out #X30/6 Timeout Preset		
Range:		Function:
0 %*	[0 - 100 %]	Contains the frequency to apply to the digital output terminal 6, when it is configured as bus-controlled timeout and timeout is detected.

3.8 Parameters: 6-** Main Menu - Analog In/Out

3.8.1 6-0* Analog I/O Mode

Parameter group for setting up the analog I/O configuration.

The frequency converter is equipped with 2 analog inputs:

- Terminals 53
- Terminals 54

The analog inputs can be allocated freely to either voltage (0–10 V) or current input (0/4–20 mA).

NOTICE

Thermistors may be connected to either an analog or a digital input.

6-00 Live Zero Timeout Time		
Range:	Function:	
10 s* [1 - 99 s]	Enter the live zero time-out time period. Live zero time-out time is active for analog inputs, i.e. terminal 53 or terminal 54, used as reference or feedback sources. If the reference signal value associated with the selected current input drops below 50% of the value set in <ul style="list-style-type: none"> • Parameter 6-10 Terminal 53 Low Voltage. • Parameter 6-12 Terminal 53 Low Current. • Parameter 6-20 Terminal 54 Low Voltage. • Parameter 6-22 Terminal 54 Low Current. For a time period longer than the time set in parameter 6-00 Live Zero Timeout Time, the function selected in parameter 6-01 Live Zero Timeout Function is activated.	

6-01 Live Zero Timeout Function		
Option:	Function:	
	Select the timeout function. The function set in 6-01 Live Zero Timeout Function is activated, if the input signal on terminal 53 or 54 is below 50% of the value in <ul style="list-style-type: none"> • 6-10 Terminal 53 Low Voltage. • 6-12 Terminal 53 Low Current. • 6-20 Terminal 54 Low Voltage. • 6-22 Terminal 54 Low Current. or for a time period defined in parameter 6-00 Live Zero Timeout Time. If several time-outs occur simultaneously, the frequency converter prioritises the time-out functions as follows:	

6-01 Live Zero Timeout Function		
Option:	Function:	
	1. 6-01 Live Zero Timeout Function. 2. 8-04 Control Word Timeout Function.	
[0] *	Off	
[1]	Freeze output	Frozen at the present value.
[2]	Stop	Overruled to stop.
[3]	Jogging	Overruled to jog speed.
[4]	Max. speed	Overruled to max. speed.
[5]	Stop and trip	Overruled to stop with subsequent trip.

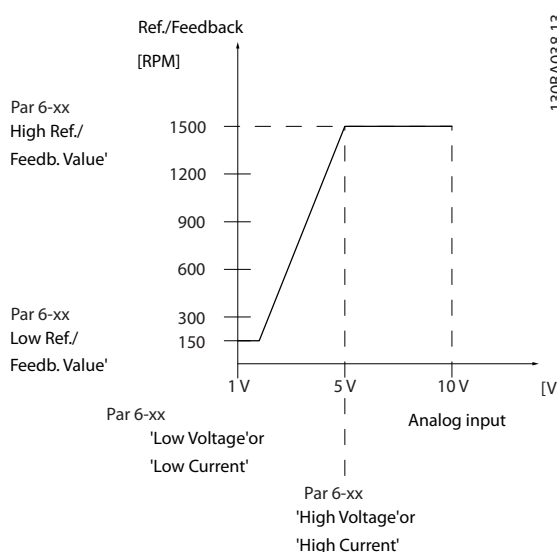

Illustration 3.29 Live Zero Conditions

6-02 Fire Mode Live Zero Timeout Function		
Option:	Function:	
	Select the time-out function when Fire mode is active. The function set in this parameter is activated if the input signal on analog inputs is lower than 50% of the low value for a time period defined in parameter 6-00 Live Zero Timeout Time.	
[0] *	Off	
[1]	Freeze output	Frozen at the present value.
[2]	Stop	Overruled to stop.
[3]	Jogging	Overruled to jog speed.
[4]	Max. speed	Overruled to max. speed.

3.8.2 6-1* Analog Input 1

Parameters for configuring the scaling and limits for analog input 1 (terminal 53).

6-10 Terminal 53 Low Voltage		
Range:	Function:	
0.07 V* [0 - par. 6-11 V]	Enter the low-voltage value. This analog input scaling value should correspond to the low reference/feedback value set in <i>parameter 6-14 Terminal 53 Low Ref./Feedb. Value</i> .	

6-11 Terminal 53 High Voltage		
Range:	Function:	
10 V* [par. 6-10 - 10 V]	Enter the high-voltage value. This analog input scaling value should correspond to the high reference/feedback value set in <i>parameter 6-15 Terminal 53 High Ref./Feedb. Value</i> .	

6-12 Terminal 53 Low Current		
Range:	Function:	
4 mA* [0 - par. 6-13 mA]	Enter the low current value. This reference signal should correspond to the low reference/feedback value, set in <i>parameter 6-14 Terminal 53 Low Ref./Feedb. Value</i> . Set the value at >2 mA to activate the live zero timeout function in <i>parameter 6-01 Live Zero Timeout Function</i> .	

6-13 Terminal 53 High Current		
Range:	Function:	
20 mA* [par. 6-12 - 20 mA]	Enter the high current value corresponding to the high reference/feedback set in <i>parameter 6-15 Terminal 53 High Ref./Feedb. Value</i> .	

6-14 Terminal 53 Low Ref./Feedb. Value		
Range:	Function:	
0* [-999999.999 - 999999.999]	Enter the analog input scaling value that corresponds to the low voltage/low current set in <i>parameter 6-10 Terminal 53 Low Voltage</i> and <i>parameter 6-12 Terminal 53 Low Current</i> .	

6-15 Terminal 53 High Ref./Feedb. Value		
Range:	Function:	
Size related* [-999999.999 - 999999.999]	Enter the analog input scaling value that corresponds to the high voltage/high current value set in <i>parameter 6-11 Terminal 53 High Voltage</i> and <i>parameter 6-13 Terminal 53 High Current</i> .	

6-16 Terminal 53 Filter Time Constant		
Range:	Function:	
0.001 s* [0.001 - 10 s]	<p>NOTICE</p> <p>This parameter cannot be adjusted while the motor is running.</p> <p>Enter the filter time constant. This constant is a first-order digital low-pass filter time for suppressing electrical noise in terminal 53. A high value improves dampening, but also increases the delay through the filter.</p>	

6-17 Terminal 53 Live Zero		
Option:	Function:	
[0]	Disabled	Disables the live zero monitoring, for example if the analog outputs are used as part of a decentral I/O system (that is if these are used to feed a building management system with data, and not as part of any control functions related to the frequency converter).
[1] *	Enabled	

3.8.3 6-2* Analog Input 2

Parameters for configuring the scaling and limits for analog input 2 (terminal 54).

6-20 Terminal 54 Low Voltage		
Range:	Function:	
0.07 V* [0 - par. 6-21 V]	Enter the low-voltage value. This analog input scaling value should correspond to the low reference/feedback value, set in <i>parameter 6-24 Terminal 54 Low Ref./Feedb. Value</i> .	

6-21 Terminal 54 High Voltage		
Range:	Function:	
10 V* [par. 6-20 - 10 V]	Enter the high-voltage value. This analog input scaling value should correspond to the high reference/feedback value set in <i>parameter 6-25 Terminal 54 High Ref./Feedb. Value</i> .	

6-22 Terminal 54 Low Current		
Range:	Function:	
4 mA* [0 - par. 6-23 mA]	Enter the low current value. This reference signal should correspond to the low reference/feedback value, set in <i>parameter 6-24 Terminal 54 Low Ref./Feedb. Value</i> . Set the value at >2 mA to activate the live zero timeout function in <i>parameter 6-01 Live Zero Timeout Function</i> .	

6-23 Terminal 54 High Current		
Range:	Function:	
20 mA* [par. 6-22 - 20 mA]	Enter the high current value corresponding to the high reference/feedback value set in <i>parameter 6-25 Terminal 54 High Ref./Feedb. Value</i> .	

6-24 Terminal 54 Low Ref./Feedb. Value		
Range:	Function:	
0* [-999999.999 - 999999.999]	Enter the analog input scaling value that corresponds to the low voltage/low current value set in <i>parameter 6-20 Terminal 54 Low Voltage</i> and <i>parameter 6-22 Terminal 54 Low Current</i> .	

6-25 Terminal 54 High Ref./Feedb. Value		
Range:	Function:	
100* [-999999.999 - 999999.999]	Enter the analog input scaling value that corresponds to the high voltage/high current value set in <i>parameter 6-21 Terminal 54 High Voltage</i> and <i>parameter 6-23 Terminal 54 High Current</i> .	

6-26 Terminal 54 Filter Time Constant		
Range:	Function:	
0.001 s* [0.001 - 10 s]	<p>NOTICE</p> <p>This parameter cannot be adjusted while the motor is running.</p> <p>Enter the filter time constant. This is a first-order digital low-pass filter time constant for suppressing electrical noise in terminal 54. A high time constant value improves dampening but also increases the time delay through the filter.</p>	

6-27 Terminal 54 Live Zero		
Option:	Function:	
[0]	Disabled	Disables the live zero-monitoring, for example if the analog outputs are used as part of a decentral I/O system (that is if these are used to feed a building management system with data, and not as part of any control functions related to the frequency converter).
[1] *	Enabled	

3.8.4 6-3* Analog Input 3 MCB 101

Parameter group for configuring the scale and limits for analog input 3 (X30/11) placed on option module MCB 101.

6-30 Terminal X30/11 Low Voltage		
Range:	Function:	
0.07 V* [0 - par. 6-31 V]	Sets the analog input scaling value to correspond to the low reference/feedback value (set in <i>parameter 6-34 Term. X30/11 Low Ref./Feedb. Value</i>).	

6-31 Terminal X30/11 High Voltage		
Range:	Function:	
10 V* [par. 6-30 - 10 V]	Sets the analog input scaling value to correspond to the high reference/feedback value (set in <i>parameter 6-35 Term. X30/11 High Ref./Feedb. Value</i>).	

6-34 Term. X30/11 Low Ref./Feedb. Value		
Range:	Function:	
0* [-999999.999 - 999999.999]	Sets the analog input scaling value to correspond to the low voltage value (set in <i>parameter 6-30 Terminal X30/11 Low Voltage</i>).	

6-35 Term. X30/11 High Ref./Feedb. Value		
Range:	Function:	
100* [-999999.999 - 999999.999]	Sets the analog input scaling value to correspond to the high voltage value (set in <i>parameter 6-31 Terminal X30/11 High Voltage</i>).	

6-36 Term. X30/11 Filter Time Constant		
Range:	Function:	
0.001 s* [0.001 - 10 s]	<p>NOTICE</p> <p>This parameter cannot be adjusted while the motor is running.</p> <p>Enter the filter time constant. This constant is a first-order digital low-pass filter time for suppressing electrical noise in terminal X30/11. A high value improves dampening, but also increases the delay through the filter.</p>	

6-37 Term. X30/11 Live Zero		
Option:	Function:	
		This parameter makes it possible to disable the live zero-monitoring. For example, to be used if the analog outputs are used in a decentral I/O system (for example when not of any frequency converter related control functions, but feeding a building management system with data).
[0]	Disabled	
[1] *	Enabled	

3.8.5 6-4* Analog Input 4 MCB 101

Parameter group for configuring the scale and limits for analog input 4 (X30/12) placed on option module MCB 101.

6-40 Terminal X30/12 Low Voltage		
Range:	Function:	
0.07 V* [0 - par. 6-41 V]	Sets the analog input scaling value to correspond to the low reference/feedback value set in <i>parameter 6-44 Term. X30/12 Low Ref./Feedb. Value.</i>	

6-41 Terminal X30/12 High Voltage		
Range:	Function:	
10 V* [par. 6-40 - 10 V]	Sets the analog input scaling value to correspond to the high reference/feedback value set in <i>parameter 6-45 Term. X30/12 High Ref./Feedb. Value.</i>	

6-44 Term. X30/12 Low Ref./Feedb. Value		
Range:	Function:	
0* [-999999.999 - 999999.999]	Sets the analog output scaling value to correspond to the low voltage value set in <i>parameter 6-40 Terminal X30/12 Low Voltage.</i>	

6-45 Term. X30/12 High Ref./Feedb. Value		
Range:	Function:	
100* [-999999.999 - 999999.999]	Sets the analog input scaling value to correspond to the high voltage value set in <i>parameter 6-41 Terminal X30/12 High Voltage.</i>	

6-46 Term. X30/12 Filter Time Constant		
Range:	Function:	
0.001 s* [0.001 - 10 s]	<p>NOTICE</p> <p>This parameter cannot be adjusted while the motor is running.</p> <p>Enter the filter time constant. This constant is a first-order digital low-pass filter time for suppressing electrical noise</p>	

6-46 Term. X30/12 Filter Time Constant		
Range:	Function:	
	in terminal X30/12. A high value improves dampening, but also increases the delay through the filter.	

6-47 Term. X30/12 Live Zero		
Option:	Function:	
	This parameter makes it possible to disable the live zero-monitoring. For Example to be used if the analog outputs are used in a decentral I/O system (For example when not of any frequency converter related control functions, but feeding a building management system with data).	
[0]	Disabled	
[1] *	Enabled	

3.8.6 6-5* Analog Output 1

Parameters for configuring the scaling and limits for analog output 1, that is terminal 42. Analog outputs are current outputs: 0/4–20 mA. Common terminal (terminal 39) is the same terminal and has the same electrical potential for analog common and digital common connection. Resolution on analog output is 12 bit.

6-50 Terminal 42 Output		
Option:	Function:	
	<p>NOTICE</p> <p>Values for setting the minimum reference are found in open loop <i>parameter 3-02 Minimum Reference</i> and for closed loop <i>parameter 20-13 Minimum Reference/Feedb.</i> - values for maximum reference for open loop are found in <i>3-03 Maximum Reference</i> and for closed loop <i>parameter 20-14 Maximum Reference/Feedb.</i></p> <p>This parameter enables the function of terminal 42 as an analog current output. Depending on the option selected, the output is either 0–20 mA or 4–20 mA. The current value can be read out in the LCP in <i>parameter 16-65 Analog Output 42 [mA]</i>.</p>	
[0]	No operation	
[100]	Output freq. 0-100	0–100 Hz, (0–20 mA).
[101]	Reference Min-Max	Minimum reference – Maximum reference, (0–20 mA).

6-50 Terminal 42 Output		
Option:	Function:	
[102]	Feedback +-200%	-200% to +200% of <i>parameter 20-14 Maximum Reference/Feedb.</i> , (0–20 mA).
[103]	Motor cur. 0- I _{max}	0–Inverter Max. Current (<i>parameter 16-37 Inv. Max. Current</i>), (0–20 mA).
[104]	Torque 0-Tlim	0–Torque limit (<i>parameter 4-16 Torque Limit Motor Mode</i>), (0–20 mA).
[105]	Torque 0- T _{nom}	0–Motor rated torque, (0–20 mA).
[106]	Power 0-P _{nom}	0–Motor rated power, (0–20 mA).
[107]	Speed 0- HighLim	0–Speed High Limit (<i>parameter 4-13 Motor Speed High Limit [RPM]</i> and <i>parameter 4-14 Motor Speed High Limit [Hz]</i>), (0–20 mA).
[113]	Ext. Closed Loop 1	0–100%, (0–20 mA).
[114]	Ext. Closed Loop 2	0–100%, (0–20 mA).
[115]	Ext. Closed Loop 3	0–100%, (0–20 mA).
[130]	Out frq 0-100 4-20mA	0–100 Hz.
[131]	Reference 4-20mA	Minimum reference - Maximum reference.
[132]	Feedback 4-20mA	-200% to +200% of <i>parameter 20-14 Maximum Reference/Feedb.</i>
[133]	Motor cur. 4-20mA	0–Inverter Maximum current (<i>parameter 16-37 Inv. Max. Current</i>).
[134]	Torq.0-lim 4-20 mA	0–Torque limit (<i>parameter 4-16 Torque Limit Motor Mode</i>).
[135]	Torq.0-nom 4-20mA	0–Motor rated torque.
[136]	Power 4-20mA	0–Motor rated power.
[137]	Speed 4-20mA	0–Speed high limit (<i>parameter 4-13 Motor Speed High Limit [RPM]</i> and <i>parameter 4-14 Motor Speed High Limit [Hz]</i>).
[139]	Bus ctrl.	0–100%, (0–20 mA).
[140]	Bus ctrl. 4-20 mA	0–100%.
[141]	Bus ctrl t.o.	0–100%, (0–20 mA).
[142]	Bus ctrl t.o. 4-20mA	0–100%.
[143]	Ext. CL 1 4-20mA	0–100%.
[144]	Ext. CL 2 4-20mA	0–100%.
[145]	Ext. CL 3 4-20mA	0–100%.

6-50 Terminal 42 Output		
Option:	Function:	
[184]	Mirror AI53 mA	
[185]	Mirror AI54 mA	

6-51 Terminal 42 Output Min Scale		
Range:	Function:	
0 %* [0 - 200 %]		Scale for the minimum output (0 mA or 4 mA) of the analog signal at terminal 42. Set the value to be the percentage of the full range of the variable selected in <i>parameter 6-50 Terminal 42 Output</i> .

6-52 Terminal 42 Output Max Scale		
Range:	Function:	
100 %* [0 - 200 %]		Scale for the maximum output (20 mA) of the analog signal at terminal 42. Set the value to be the percentage of the full range of the variable selected in <i>parameter 6-50 Terminal 42 Output</i> .
<p>Illustration 3.30 Output Current vs Reference Variable</p> <p>It is possible to obtain a value lower than 20 mA at full scale by programming values >100% by using a formula as follows:</p> $20 \text{ mA} / \text{desired maximum current} \times 100 \%$ <p>i. e. $10 \text{ mA} : \frac{20 \text{ mA}}{10 \text{ mA}} \times 100 \% = 200 \%$</p>		

Example 1:

Variable value=OUTPUT FREQUENCY, range=0–100 Hz.
 Range needed for output=0–50 Hz.
 Output signal 0 mA or 4 mA is needed at 0 Hz (0% of range). Set *parameter 6-51 Terminal 42 Output Min Scale* to 0%.
 Output signal 20 mA is needed at 50 Hz (50% of range). Set *parameter 6-52 Terminal 42 Output Max Scale* to 50%.

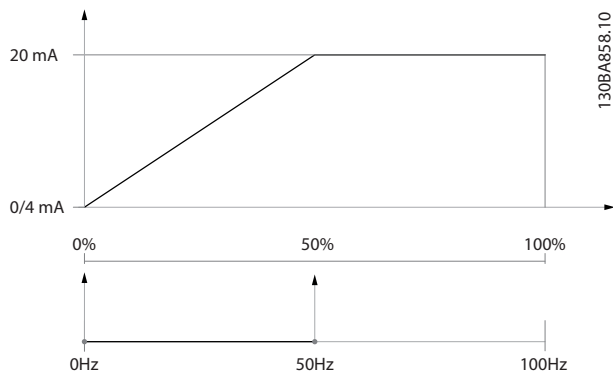

Illustration 3.31 Example 1

Example 2:

Variable=FEEDBACK, range=-200% to +200%.
 Range needed for output=0–100%.
 Output signal 0 mA or 4 mA is needed at 0% (50% of range). Set *parameter 6-51 Terminal 42 Output Min Scale* to 50%.
 Output signal 20 mA is needed at 100% (75% of range). Set *parameter 6-52 Terminal 42 Output Max Scale* to 75%.

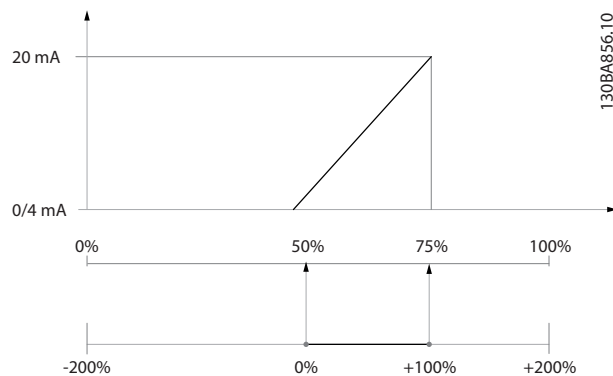

Illustration 3.32 Example 2

Example 3:

Variable value=REFERENCE, range=Minimum ref–maximum ref.
 Range needed for output=Minimum ref (0%)–Maximum ref (100%), 0–10 mA.
 Output signal 0 mA or 4 mA is needed at minimum ref. Set *parameter 6-51 Terminal 42 Output Min Scale* to 0%.
 Output signal 10 mA is needed at maximum ref (100% of range). Set *parameter 6-52 Terminal 42 Output Max Scale* to 200%.
 (20 mA/10 mA x 100%=200%).

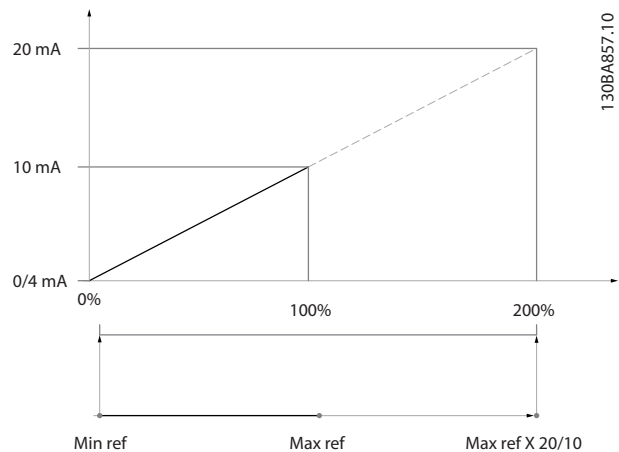

Illustration 3.33 Example 3

3

6-53 Terminal 42 Output Bus Control

Range:	Function:
0 %* [0 - 100 %]	Holds the level of output 42 if controlled by bus.

6-54 Terminal 42 Output Timeout Preset

Range:	Function:
0 %* [0 - 100 %]	Holds the preset level of output 42. If a time-out function is selected in <i>parameter 6-50 Terminal 42 Output</i> , the output is preset to this level if a bus time-out occurs.

6-55 Analog Output Filter

Option:	Function:
[0] *	Off
[1]	On

The following readout analog parameters from selection in *6-50 Terminal 42 Output* have a filter selected when *parameter 6-55 Analog Output Filter* is on:

Selection	0-20 mA	4-20 mA
Motor current (0–I _{max})	[103]	[133]
Torque limit (0–T _{lim})	[104]	[134]
Rated torque (0–T _{nom})	[105]	[135]
Power (0–P _{nom})	[106]	[136]
Speed (0–Speed _{max})	[107]	[137]

Table 3.14 Readout Analog Parameters

3.8.7 6-6* Analog Output 2 MCB 101

Analog outputs are current outputs: 0/4–20 mA. Common terminal (terminal X30/8) is the same terminal and electrical potential for analog common connection. Resolution on analog output is 12 bit.

6-60 Terminal X30/8 Output

Same options and functions as *parameter 6-50 Terminal 42 Output*.

6-61 Terminal X30/8 Min. Scale

Range:	Function:
0 %* [0 - 200 %]	Scales the minimum output of the selected analog signal on terminal X30/8. Scale the minimum value as a percentage of the maximum signal value, that is 0 mA (or 0 Hz) is desired at 25% of the maximum output value and 25% is programmed. The value can never be higher than the corresponding setting in <i>parameter 6-62 Terminal X30/8 Max. Scale</i> if the value is below 100%. This parameter is active when option module MCB 101 is mounted in the frequency converter.

6-62 Terminal X30/8 Max. Scale

Range:	Function:
100 %* [0 - 200 %]	Scales the maximum output of the selected analog signal on terminal X30/8. Scale the value to the desired maximum value of the current signal output. Scale the output to give a lower current than 20 mA at full scale, or 20 mA at an output below 100% of the maximum signal value. If 20 mA is the desired output current at a value between 0–100% of the full-scale output, programme the percentage value in the parameter, that is 50%=20 mA. If a current between 4 and 20 mA is desired at maximum output (100%), calculate the percentage value as follows: $20 \text{ mA} / \text{desired maximum current} \times 100 \%$ i.e. $10 \text{ mA} : \frac{20 \text{ mA}}{10 \text{ mA}} \times 100 \% = 200 \%$

6-63 Terminal X30/8 Output Bus Control

Range:	Function:
0 %* [0 - 100 %]	Contains the value to apply to the output terminal, when it is configured as bus-controlled.

6-64 Terminal X30/8 Output Timeout Preset

Range:	Function:
0 %* [0 - 100 %]	Contains the value to apply to the output terminal, when it is configured as bus-controlled timeout and timeout is detected.

3.9 Parameters: 8-** Main Menu - Communications and Options

3.9.1 8-0* General Settings

8-01 Control Site		
Option:	Function:	
		The setting in this parameter overrides the settings in <i>parameter 8-50 Coasting Select</i> to <i>parameter 8-56 Preset Reference Select</i> .
[0]	Digital and ctrl.word	Control by using both digital input and control word.
[1]	Digital only	Control by using digital inputs only.
[2]	Controlword only	Control by using control word only.

8-02 Control Source		
Option:	Function:	
		NOTICE This parameter cannot be adjusted while the motor is running.
		Select the source of the control word: 1 of 2 serial interfaces, or 4 installed options. During initial power-up, the frequency converter automatically sets this parameter to [3] <i>Option A</i> if it detects a valid fieldbus option installed in slot A. If the option is removed, the frequency converter detects a change in the configuration, sets <i>parameter 8-02 Control Source</i> back to default setting [01] <i>FC Port</i> , and the frequency converter then trips. If an option is installed after initial power-up, the setting of <i>parameter 8-02 Control Source</i> does not change but the frequency converter trips and displays: <i>Alarm 67, Option Changed</i> .
[0]	None	
[1]	FC Port	
[2]	USB Port	
[3]	Option A	
[4]	Option B	
[5]	Option C0	
[6]	Option C1	
[30]	External Can	

8-03 Control Timeout Time		
Range:	Function:	
Size related*	[0.5 - 18000 s]	Enter the maximum time expected to pass between the reception of 2 consecutive telegrams. If this time is exceeded, it indicates that the serial communication has stopped. The function selected in <i>parameter 8-04 Control Timeout Function</i> <i>Control Time-out Function</i> is then carried out.

8-03 Control Timeout Time		
Range:	Function:	
		In BACnet, the control timeout is only triggered if some specific objects are written. The object list holds information on the objects that triggers the control timeout: <ul style="list-style-type: none"> • Analog outputs • Binary outputs • AV0 • AV1 • AV2 • AV4 • BV1 • BV2 • BV3 • BV4 • BV5 • Multistate outputs

8-04 Control Timeout Function		
Option:	Function:	
		Select the timeout function. The timeout function is activated when the control word fails to be updated within the time period specified in <i>parameter 8-03 Control Timeout Time</i> . [20] <i>N2 Override Release</i> only appears after setting the Metasys N2 protocol.
[0] *	Off	
[1]	Freeze output	
[2]	Stop	
[3]	Jogging	
[4]	Max. speed	
[5]	Stop and trip	
[7]	Select setup 1	
[8]	Select setup 2	
[9]	Select setup 3	
[10]	Select setup 4	
[20]	N2 Override Release	
[27]	Forced stop and trip	

8-05 End-of-Timeout Function		
Option:	Function:	
		Select the action after receiving a valid control word following a time-out. This parameter is active only when <i>parameter 8-04 Control Timeout Function</i> is set to

8-05 End-of-Timeout Function		
Option:	Function:	
		<ul style="list-style-type: none"> [7] Set-up 1. [8] Set-up 2. [9] Set-up 3. [10] Set-up 4.
[0]	Hold set-up	Retains the set-up selected in <i>parameter 8-04 Control Timeout Function</i> and displays a warning, until <i>parameter 8-06 Reset Control Timeout</i> toggles. Then the frequency converter resumes its original set-up.
[1] *	Resume set-up	Resumes the set-up active before the time-out.

8-06 Reset Control Timeout		
Option:	Function:	
		This parameter is active only when option [0] <i>Hold set-up</i> has been selected in <i>parameter 8-05 End-of-Timeout Function</i> .
[0] *	Do not reset	Retains the set-up specified in <i>parameter 8-04 Control Timeout Function</i> : <ul style="list-style-type: none"> [7] Set-up 1 [8] Set-up 2 [9] Set-up 3 [10] Set-up 4
[1]	Do reset	Returns the frequency converter to the original set-up following a control word timeout. When the value is set to [1] <i>Do reset</i> , the frequency converter performs the reset and immediately reverts to the [0] <i>Do not reset</i> setting.

8-07 Diagnosis Trigger		
Option:	Function:	
		Select [0] <i>Disable</i> to send no extended diagnosis data (EDD). Select [1] <i>Trigger on alarms</i> to send EDD upon alarms or [2] <i>Trigger alarm/warn.</i> to send EDD upon alarms, or warnings. Not all fieldbusses support the diagnosis functions. This parameter has no function for BACnet.
[0] *	Disable	
[1]	Trigger on alarms	
[2]	Trigger alarm/warn.	

8-08 Readout Filtering		
If the speed feedback value readouts on fieldbus are fluctuating, this function is used. Select filtered, if the function is required. A power cycle is required for changes to take effect.		
Option:	Function:	
[0]	Motor Data Std-Filt.	Normal bus readouts.
[1]	Motor Data LP-Filter	Filtered bus readouts of the following parameters: 16-10 Power [kW] 16-11 Power [hp] 16-12 Motor Voltage 16-14 Motor current 16-16 Torque [Nm] 16-17 Speed [RPM] 16-22 Torque [%] 16-25 Torque [Nm] High

3.9.2 8-1* Ctrl. Word Settings

8-10 Control Profile		
Option:	Function:	
		Select the interpretation of the control and status words corresponding to the installed fieldbus. Only the selections valid for the fieldbus installed in slot A are visible in the LPC display.
[0] *	FC profile	
[1]	PROFIdrive profile	
[5]	ODVA	Available only with MCA 104 DeviceNet, MCA 121 Ethernet/IP.
[7]	CANopen DSP 402	

8-13 Configurable Status Word STW		
Option:	Function:	
		This parameter enables configuration of bits 12–15 in the status word.
[0]	No function	
[1] *	Profile Default	Function corresponds to the profile default selected in <i>parameter 8-10 Control Profile</i> .
[2]	Alarm 68 Only	Only set in case of an Alarm 68.
[3]	Trip excl. Alarm 68	Set in case of a trip, except if Alarm 68 executes the trip.
[10]	T18 DI status.	The bit indicates the status of terminal 18. 0 indicates that the terminal is low. 1 indicates that the terminal is high.
[11]	T19 DI status.	The bit indicates the status of terminal 19. 0 indicates that the terminal is low. 1 indicates that the terminal is high.
[12]	T27 DI status.	The bit indicates the status of terminal 27. 0 indicates that the terminal is low.

8-13 Configurable Status Word STW

Option:	Function:
	1 indicates that the terminal is high.
[13] T29 DI status.	The bit indicates the status of terminal 29. 0 indicates that the terminal is low. 1 indicates that the terminal is high.
[14] T32 DI status.	The bit indicates the status of terminal 32. 0 indicates that the terminal is low. 1 indicates that the terminal is high.
[15] T33 DI status.	The bit indicates the status of terminal 33. 0 indicates that the terminal is low. 1 indicates that the terminal is high.
[16] T37 DI status	The bit indicates the status of terminal 37. 0 indicates terminal 37 is low (Safe Torque stop). 1 indicates terminal 37 is high (normal).
[21] Thermal warning	The thermal warning turns on when the temperature exceeds the limit in the motor, the frequency converter, the brake resistor, or the thermistor.
[30] Brake fault (IGBT)	Output is logic 1 when the brake IGBT is short-circuited. Use this function to protect the frequency converter if there is a fault on the brake modules. Use the output/relay to cut out the main voltage from the frequency converter.
[40] Out of ref. range	
[60] Comparator 0	See parameter group 13-1* Comparators. If comparator 0 is evaluated as TRUE, the output goes high. Otherwise, it is low.
[61] Comparator 1	See parameter group 13-1* Comparators. If comparator 1 is evaluated as TRUE, the output goes high. Otherwise, it is low.
[62] Comparator 2	See parameter group 13-1* Comparators. If comparator 2 is evaluated as TRUE, the output goes high. Otherwise, it is low.
[63] Comparator 3	See parameter group 13-1* Comparators. If comparator 3 is evaluated as TRUE, the output goes high. Otherwise, it is low.
[64] Comparator 4	See parameter group 13-1* Comparators. If comparator 4 is evaluated as TRUE, the output goes high. Otherwise, it is low.
[65] Comparator 5	See parameter group 13-1* Comparators. If comparator 5 is evaluated as TRUE, the output goes high. Otherwise, it is low.
[70] Logic Rule 0	See parameter group 13-4* Logic Rules. If logic rule 0 is evaluated as TRUE, the output goes high. Otherwise, it is low.
[71] Logic Rule 1	See parameter group 13-4* Logic Rules. If logic rule 1 is evaluated as TRUE, the output goes high. Otherwise, it is low.
[72] Logic Rule 2	See parameter group 13-4* Logic Rules. If logic rule 2 is evaluated as TRUE, the output goes high. Otherwise, it is low.

8-13 Configurable Status Word STW

Option:	Function:
[73] Logic Rule 3	See parameter group 13-4* Logic Rules. If logic rule 3 is evaluated as TRUE, the output goes high. Otherwise, it is low.
[74] Logic Rule 4	See parameter group 13-4* Logic Rules. If logic rule 4 is evaluated as TRUE, the output goes high. Otherwise, it is low.
[75] Logic Rule 5	See parameter group 13-4* Logic Rules. If logic rule 5 is evaluated as TRUE, the output goes high. Otherwise, it is low.
[80] SL Digital Output A	See parameter 13-52 SL Controller Action. The output goes high whenever the smart logic action [38] Set digital out A high is executed. The output goes low whenever the smart logic action [32] Set digital out A low is executed.
[81] SL Digital Output B	See parameter 13-52 SL Controller Action. The input goes high whenever the smart logic action [39] Set digital out B high is executed. The input goes low whenever the smart logic action [33] Set digital out B low is executed.
[82] SL Digital Output C	See parameter 13-52 SL Controller Action. The input goes high whenever the smart logic action [40] Set digital out C high is executed. The input goes low whenever the smart logic action [34] Set digital out C low is executed.
[83] SL Digital Output D	See parameter 13-52 SL Controller Action. The input goes high whenever the smart logic action [41] Set digital out D high is executed. The input goes low whenever the smart logic action [35] Set digital out D low is executed.
[84] SL Digital Output E	See parameter 13-52 SL Controller Action. The input goes high whenever the smart logic action [42] Set digital out E high is executed. The input goes low whenever the smart logic action [36] Set digital out E low is executed.
[85] SL Digital Output F	See parameter 13-52 SL Controller Action. The input goes high whenever the smart logic action [43] Set digital out F high is executed. The input goes low whenever the smart logic action [37] Set digital out F low is executed.

3.9.3 8-3* FC Port Settings

8-30 Protocol		
Option:	Function:	
		<p>NOTICE</p> <p>Further details can be found in the VLT® HVAC Drive FC 102 Metasys Operating Instructions.</p> <p>Protocol selection for the integrated FC (standard) Port (RS485) on the control card.</p> <p>Parameter group 8-7* BACnet is only visible when [9] FC Option is selected.</p>
[0]	FC	Communication according to the FC Protocol as described in the VLT® HVAC Drive FC 102 Design Guide, RS485 Installation and Set-up.
[1]	FC MC	Same as [0] FC but to be used when downloading SW to the frequency converter or uploading dll file (covering information regarding parameters available in the frequency converter and their inter-dependencies) to Motion Control Tool MCT 10 Set-up Software.
[2]	Modbus RTU	Communication according to the Modbus RTU protocol as described in the VLT® HVAC Drive FC 102 Design Guide, RS485 Installation and Set-up.
[3]	Metasys N2	Communication protocol. The N2 software protocol is designed to be general in nature to accommodate the unique properties each device may have. See VLT® HVAC Drive Metasys operating system.
[4]	FLN	Communication according to the Apogee FLN P1 protocol.
[5]	BACnet	Communication according to an open data communications protocol (building automation and control network), American National Standard (ANSI/ASHRAE 135-1995).
[9]	FC Option	<p>To be used when a gateway is connected to the integrated RS485 port, for example the BACnet gateway.</p> <p>Following changes take place:</p> <ul style="list-style-type: none"> Address for the FC port is set to 1, and <i>parameter 8-31 Address</i>, is now used to set the address for the gateway on the network, for example BACnet. See VLT® HVAC Drive BACnet Operating Instruction. Baud rate for the FC port is set to a fixed value (115.200 Baud), and <i>parameter 8-32 Baud Rate</i>, is now used to set the baud rate for the network port (for example BACnet) on the gateway.
[20]	LEN	

8-31 Address		
Range:	Function:	
Size related*	[1 - 255]	Enter the address for the frequency converter (standard) port. Valid range: 1–126.

8-32 Baud Rate		
Option:	Function:	
		Baud rates 9600, 19200, 38400 and 76800 baud are valid for BACnet only. The default value depends on the FC Protocol.
[0]	2400 Baud	
[1]	4800 Baud	
[2]	9600 Baud	
[3]	19200 Baud	
[4]	38400 Baud	
[5]	57600 Baud	
[6]	76800 Baud	
[7]	115200 Baud	

8-33 Parity / Stop Bits		
Option:	Function:	
		Parity and stop bits for the protocol <i>parameter 8-30 Protocol</i> using the FC port. For some of the protocols, not all options are visible. Default depends on the protocol selected.
[0]	Even Parity, 1 Stop Bit	
[1]	Odd Parity, 1 Stop Bit	
[2]	No Parity, 1 Stop Bit	
[3]	No Parity, 2 Stop Bits	

8-34 Estimated cycle time		
Range:	Function:	
0 ms*	[0 - 1000000 ms]	In noisy environments, the interface may be blocked due to overload or bad frames. This parameter specifies the time between 2 consecutive frames on the network. If the interface does not detect valid frames in that time, it flushes the receive buffer.

8-35 Minimum Response Delay		
Range:	Function:	
Size related*	[5 - 10000 ms]	Specify the minimum delay time between receiving a request and transmitting a response. This is used for overcoming modem turnaround delays.

8-36 Maximum Response Delay		
Range:		Function:
Size related*	[11 - 10001 ms]	Specify the maximum permissible delay time between transmitting a request and receiving a response. Exceeding this delay time causes control word timeout.

8-37 Maximum Inter-Char Delay		
Range:		Function:
Size related*	[0.00 - 35.00 ms]	Specify the maximum permissible time interval between receipt of 2 bytes. This parameter activates timeout if transmission is interrupted.

3.9.4 8-4* Telegram Selection

8-40 Telegram Selection		
Option:	Function:	
		Enables use of freely configurable telegrams or standard telegrams for the FC Port.
[1] *	Standard telegram 1	
[101]	PPO 1	
[102]	PPO 2	
[103]	PPO 3	
[104]	PPO 4	
[105]	PPO 5	
[106]	PPO 6	
[107]	PPO 7	
[108]	PPO 8	
[200]	Custom telegram 1	

8-42 PCD Write Configuration		
Range:		Function:
Size related*	[0 - 9999]	Select the parameters to be assigned to the PCD's telegrams. The number of available PCDs depends on the telegram type. The values in the PCDs are then written to the selected parameters as data values.

8-43 PCD Read Configuration		
Range:		Function:
Size related*	[0 - 9999]	Select the parameters to be assigned to the PCDs of the telegrams. The number of available PCDs depends on the telegram type. PCDs contain the actual data values of the selected parameters.

3.9.5 8-5* Digital/Bus

Parameters for configuring the control word digital/bus merging.

NOTICE

These parameters are active only when parameter 8-01 Control Site is set to [0] Digital and control word.

8-50 Coasting Select		
Option:	Function:	
		Select control of the coasting function via the terminals (digital input) and/or via the bus.
[0]	Digital input	Activates start command via a digital input.
[1]	Bus	Activates start command via the serial communication port or fieldbus option.
[2]	Logic AND	Activates start command via the fieldbus/serial communication port, AND 1 additional digital input.
[3] *	Logic OR	Activates start command via the fieldbus/serial communication port OR via 1 of the digital inputs.

8-52 DC Brake Select		
Option:	Function:	
		Select control of the DC brake via the terminals (digital input) and/or via the fieldbus. NOTICE When parameter 1-10 Motor Construction is set to [1] PM non-salient SPM, only selection [0] Digital input is available.
[0]	Digital input	Activates start command via a digital input.
[1]	Bus	Activates start command via the serial communication port or fieldbus option.
[2]	Logic AND	Activates start command via the fieldbus/serial communication port, AND additionally via 1 of the digital inputs.
[3]	Logic OR	Activates start command via the fieldbus/serial communication port OR via one of the digital inputs.

8-53 Start Select		
Option:	Function:	
		Select control of the frequency converter start function via the terminals (digital input) and/or via the fieldbus.
[0]	Digital input	Activates a start command via a digital input.

8-53 Start Select		
Option:	Function:	
[1]	Bus	Activates a start command via the serial communication port or fieldbus option.
[2]	Logic AND	Activates a start command via the fieldbus/serial communication port, AND additionally via 1 of the digital inputs.
[3] *	Logic OR	Activates a start command via the fieldbus/serial communication port, OR via 1 of the digital inputs.

8-54 Reversing Select		
Option:	Function:	
		<p>NOTICE</p> <p>This parameter is active only when parameter 8-01 Control Site is set to [0] Digital and control word.</p> <p>Select control of the frequency converter reverse function via the terminals (digital input) and/or via the fieldbus.</p>
[0]	Digital input	Activates reverse command via a digital input.
[1]	Bus	Activates reverse command via the serial communication port or fieldbus option.
[2]	Logic AND	Activates reverse command via the fieldbus/serial communication port, AND via 1 of the digital inputs.
[3]	Logic OR	Activates reverse command via the fieldbus/serial communication port OR via 1 of the digital inputs.

8-55 Set-up Select		
Option:	Function:	
		Select control of the frequency converter set-up selection via the terminals (digital input) and/or via the fieldbus.
[0]	Digital input	Activates the set-up selection via a digital input.
[1]	Bus	Activates the set-up selection via the serial communication port, or fieldbus option.
[2]	Logic AND	Activates the set-up selection via the fieldbus/serial communication port, AND via 1 of the digital inputs.
[3] *	Logic OR	Activates the set-up selection via the fieldbus/serial communication port OR via 1 of the digital inputs.

8-56 Preset Reference Select		
Option:	Function:	
		Select control of the preset reference selection via the terminals (digital input) and/or via the fieldbus.

8-56 Preset Reference Select		
Option:	Function:	
[0]	Digital input	Activates preset reference selection via a digital input.
[1]	Bus	Activates preset reference selection via the serial communication port, or fieldbus option.
[2]	Logic AND	Activates preset reference selection via the fieldbus/serial communication port, AND via 1 of the digital inputs.
[3] *	Logic OR	Activates the preset reference selection via the fieldbus/serial communication port, OR via 1 of the digital inputs.

3.9.6 8-7* BACnet

NOTICE

Parameters in this group are active only when parameter 8-30 Protocol is set to [5] BACnet.

8-70 BACnet Device Instance		
Range:	Function:	
1*	[0 - 4194302]	Enter a unique ID number for the BACnet device.

8-72 MS/TP Max Masters		
Range:	Function:	
127*	[1 - 127]	Define the address of the master which holds the highest address in this network. Decreasing this value optimises polling for the token.

8-73 MS/TP Max Info Frames		
Range:	Function:	
1*	[1 - 65534]	Define how many info/data frames the device is allowed to send while holding the token.

8-74 "I-Am" Service		
Option:	Function:	
[0] *	Send at power-up	
[1]	Continuously	Select whether the device should send the "I-Am" service message only at power-up, or continuously with an interval of approximately 1 min.

8-75 Initialisation Password		
Range:	Function:	
Size related*	[1 - 20]	

3.9.7 8-8* FC Port Diagnostics

These parameters are used for monitoring the bus communication via the frequency converter port.

8-80 Bus Message Count		
Range:	Function:	
0*	[0 - 0]	This parameter shows the number of valid telegrams detected on the bus.

8-81 Bus Error Count		
Range:	Function:	
0*	[0 - 0]	This parameter shows the number of telegrams with faults (for example CRC fault), detected on the bus.

8-82 Slave Messages Rcvd		
Range:	Function:	
0*	[0 - 0]	This parameter shows the number of valid telegrams addressed to the slave, sent by the frequency converter.

8-83 Slave Error Count		
Range:	Function:	
0*	[0 - 0]	This parameter shows the number of error telegrams, which could not be executed by the frequency converter.

8-84 Slave Messages Sent		
Range:	Function:	
0*	[0 - 0]	This parameter shows the number of messages sent from this frequency converter.

8-85 Slave Timeout Errors		
Range:	Function:	
0*	[0 - 0]	This parameter shows the number of messages suppressed due to time-out.

3.9.8 8-9* Bus Jog

8-90 Bus Jog 1 Speed		
Range:	Function:	
100 RPM*	[0 - par. 4-13 RPM]	Enter the jog speed. Activate this fixed jog speed via the serial port or fieldbus option.

8-91 Bus Jog 2 Speed		
Range:	Function:	
200 RPM*	[0 - par. 4-13 RPM]	Enter the jog speed. Activate this fixed jog speed via the serial port or fieldbus option.

8-94 Bus Feedback 1		
Range:	Function:	
0*	[-200 - 200]	Write a feedback to this parameter via the serial communication port or fieldbus option. This parameter must be selected in <i>parameter 20-00 Feedback 1 Source</i> , <i>parameter 20-03 Feedback 2 Source</i> or <i>parameter 20-06 Feedback 3 Source</i> as a feedback source.

8-95 Bus Feedback 2		
Range:	Function:	
0*	[-200 - 200]	See <i>parameter 8-94 Bus Feedback 1</i> for further details.

8-96 Bus Feedback 3		
Range:	Function:	
0*	[-200 - 200]	See <i>parameter 8-94 Bus Feedback 1</i> for further details.

3.10 Parameters: 9-** Main Menu - PROFIBUS

Parameters in this section are only visible with the VLT® PROFIBUS DP MCA 101 option installed.

For PROFIBUS parameter descriptions, see the VLT® PROFIBUS DP MCA 101 Programming Guide.

9-15 PCD Write Configuration		
Array [10]		
Option:	Function:	
[0]	None	Select the parameters to be assigned to PCD 3 to 10 of the telegrams. The number of available PCDs depends on the telegram type. The values in PCD 3 to 10 are then written to the selected parameters as data values. Alternatively, specify a standard PROFIBUS telegram in <i>parameter 9-22 Telegram Selection</i> .
[302]	Minimum Reference	
[303]	Maximum Reference	
[341]	Ramp 1 Ramp Up Time	
[342]	Ramp 1 Ramp Down Time	
[351]	Ramp 2 Ramp Up Time	
[352]	Ramp 2 Ramp Down Time	
[380]	Jog Ramp Time	
[381]	Quick Stop Ramp Time	
[411]	Motor Speed Low Limit [RPM]	
[412]	Motor Speed Low Limit [Hz]	
[413]	Motor Speed High Limit [RPM]	
[414]	Motor Speed High Limit [Hz]	
[416]	Torque Limit Motor Mode	
[417]	Torque Limit Generator Mode	
[553]	Term. 29 High Ref./Feedb. Value	
[558]	Term. 33 High Ref./Feedb. Value	
[590]	Digital & Relay Bus Control	
[593]	Pulse Out #27 Bus Control	
[595]	Pulse Out #29 Bus Control	
[597]	Pulse Out #X30/6 Bus Control	

9-15 PCD Write Configuration		
Array [10]		
Option:	Function:	
[615]	Terminal 53 High Ref./Feedb. Value	
[625]	Terminal 54 High Ref./Feedb. Value	
[653]	Terminal 42 Output Bus Control	
[663]	Terminal X30/8 Output Bus Control	
[673]	Terminal X45/1 Bus Control	
[683]	Terminal X45/3 Bus Control	
[890]	Bus Jog 1 Speed	
[891]	Bus Jog 2 Speed	
[894]	Bus Feedback 1	
[895]	Bus Feedback 2	
[896]	Bus Feedback 3	
[1680]	Fieldbus CTW 1	
[1682]	Fieldbus REF 1	
[1685]	FC Port CTW 1	
[1686]	FC Port REF 1	

9-16 PCD Read Configuration		
Option:	Function:	
[0]	None	Select the parameters to be assigned to PCD 3 to 10 of the telegrams. The number of available PCDs depends on the telegram type. PCDs 3 to 10 contain the actual data values of the selected parameters. For standard PROFIBUS telegram, see <i>parameter 9-22 Telegram Selection</i> .
[894]	Bus Feedback 1	
[895]	Bus Feedback 2	
[896]	Bus Feedback 3	
[1397]	Alert Alarm Word	
[1398]	Alert Warning Word	
[1399]	Alert Status Word	
[1500]	Operating hours	
[1501]	Running Hours	
[1502]	kWh Counter	
[1600]	Control Word	
[1601]	Reference [Unit]	
[1602]	Reference [%]	
[1603]	Status Word	
[1605]	Main Actual Value [%]	
[1609]	Custom Readout	
[1610]	Power [kW]	

9-16 PCD Read Configuration		
Option:	Function:	
[1611]	Power [hp]	
[1612]	Motor Voltage	
[1613]	Frequency	
[1614]	Motor current	
[1615]	Frequency [%]	
[1616]	Torque [Nm]	
[1617]	Speed [RPM]	
[1618]	Motor Thermal	
[1622]	Torque [%]	
[1623]	Motor Shaft Power [kW]	
[1624]	Calibrated Stator Resistance	
[1626]	Power Filtered [kW]	
[1627]	Power Filtered [hp]	
[1630]	DC Link Voltage	
[1632]	Brake Energy /s	
[1633]	Brake Energy Average	
[1634]	Heatsink Temp.	
[1635]	Inverter Thermal	
[1638]	SL Controller State	
[1639]	Control Card Temp.	
[1650]	External Reference	
[1652]	Feedback[Unit]	
[1653]	Digi Pot Reference	
[1654]	Feedback 1 [Unit]	
[1655]	Feedback 2 [Unit]	
[1656]	Feedback 3 [Unit]	
[1660]	Digital Input	
[1661]	Terminal 53 Switch Setting	
[1662]	Analog Input 53	
[1663]	Terminal 54 Switch Setting	
[1664]	Analog Input 54	
[1665]	Analog Output 42 [mA]	
[1666]	Digital Output [bin]	
[1667]	Pulse Input #29 [Hz]	
[1668]	Pulse Input #33 [Hz]	
[1669]	Pulse Output #27 [Hz]	
[1670]	Pulse Output #29 [Hz]	
[1671]	Relay Output [bin]	
[1672]	Counter A	
[1673]	Counter B	
[1675]	Analog In X30/11	
[1676]	Analog In X30/12	
[1677]	Analog Out X30/8 [mA]	
[1678]	Analog Out X45/1 [mA]	
[1679]	Analog Out X45/3 [mA]	
[1684]	Comm. Option STW	
[1685]	FC Port CTW 1	
[1690]	Alarm Word	
[1691]	Alarm Word 2	
[1692]	Warning Word	
[1693]	Warning Word 2	
[1694]	Ext. Status Word	

9-16 PCD Read Configuration		
Option:	Function:	
[1695]	Ext. Status Word 2	
[1696]	Maintenance Word	
[1830]	Analog Input X42/1	
[1831]	Analog Input X42/3	
[1832]	Analog Input X42/5	
[1833]	Analog Out X42/7 [V]	
[1834]	Analog Out X42/9 [V]	
[1835]	Analog Out X42/11 [V]	
[1836]	Analog Input X48/2 [mA]	
[1837]	Temp. Input X48/4	
[1838]	Temp. Input X48/7	
[1839]	Temp. Input X48/10	
[1850]	Sensorless Readout [unit]	
[1860]	Digital Input 2	

9-18 Node Address		
Range:	Function:	
126*	[0 - 126]	Enter the station address in this parameter or alternatively in the hardware switch. In order to adjust the station address in <i>parameter 9-18 Node Address</i> , the hardware switch must be set to 126 or 127 (that is, all switches set to 'on'). Otherwise this parameter displays the actual setting of the switch.

9-22 Telegram Selection		
Option:	Function:	
		Select a standard PROFIBUS telegram configuration for the frequency converter, as an alternative to using the freely configurable telegrams in <i>parameter 9-15 PCD Write Configuration</i> and <i>parameter 9-16 PCD Read Configuration</i> .
[1]	Standard telegram 1	
[101]	PPO 1	
[102]	PPO 2	
[103]	PPO 3	
[104]	PPO 4	
[105]	PPO 5	
[106]	PPO 6	
[107]	PPO 7	
[108] *	PPO 8	

9-23 Parameters for Signals		
Array [1000]		
Option:	Function:	
		This parameter contains a list of signals available for selection in

9-23 Parameters for Signals		
Array [1000]		
Option:		Function:
		<i>parameter 9-15 PCD Write Configuration and parameter 9-16 PCD Read Configuration.</i>
[0] *	None	
[302]	Minimum Reference	
[303]	Maximum Reference	
[341]	Ramp 1 Ramp Up Time	
[342]	Ramp 1 Ramp Down Time	
[351]	Ramp 2 Ramp Up Time	
[352]	Ramp 2 Ramp Down Time	
[380]	Jog Ramp Time	
[381]	Quick Stop Ramp Time	
[411]	Motor Speed Low Limit [RPM]	
[412]	Motor Speed Low Limit [Hz]	
[413]	Motor Speed High Limit [RPM]	
[414]	Motor Speed High Limit [Hz]	
[416]	Torque Limit Motor Mode	
[417]	Torque Limit Generator Mode	
[553]	Term. 29 High Ref./Feedb. Value	
[558]	Term. 33 High Ref./Feedb. Value	
[590]	Digital & Relay Bus Control	
[593]	Pulse Out #27 Bus Control	
[595]	Pulse Out #29 Bus Control	
[597]	Pulse Out #X30/6 Bus Control	
[615]	Terminal 53 High Ref./Feedb. Value	
[625]	Terminal 54 High Ref./Feedb. Value	
[653]	Terminal 42 Output Bus Control	
[663]	Terminal X30/8 Output Bus Control	
[673]	Terminal X45/1 Bus Control	
[683]	Terminal X45/3 Bus Control	
[890]	Bus Jog 1 Speed	
[891]	Bus Jog 2 Speed	
[894]	Bus Feedback 1	
[895]	Bus Feedback 2	
[896]	Bus Feedback 3	
[1397]	Alert Alarm Word	
[1398]	Alert Warning Word	
[1399]	Alert Status Word	
[1500]	Operating hours	
[1501]	Running Hours	
[1502]	kWh Counter	
[1600]	Control Word	
[1601]	Reference [Unit]	
[1602]	Reference [%]	
[1603]	Status Word	
[1605]	Main Actual Value [%]	
[1609]	Custom Readout	
[1610]	Power [kW]	
[1611]	Power [hp]	

9-23 Parameters for Signals		
Array [1000]		
Option:		Function:
[1612]	Motor Voltage	
[1613]	Frequency	
[1614]	Motor current	
[1615]	Frequency [%]	
[1616]	Torque [Nm]	
[1617]	Speed [RPM]	
[1618]	Motor Thermal	
[1622]	Torque [%]	
[1623]	Motor Shaft Power [kW]	
[1624]	Calibrated Stator Resistance	
[1626]	Power Filtered [kW]	
[1627]	Power Filtered [hp]	
[1630]	DC Link Voltage	
[1632]	Brake Energy /s	
[1633]	Brake Energy Average	
[1634]	Heatsink Temp.	
[1635]	Inverter Thermal	
[1638]	SL Controller State	
[1639]	Control Card Temp.	
[1650]	External Reference	
[1652]	Feedback[Unit]	
[1653]	Digi Pot Reference	
[1654]	Feedback 1 [Unit]	
[1655]	Feedback 2 [Unit]	
[1656]	Feedback 3 [Unit]	
[1660]	Digital Input	
[1661]	Terminal 53 Switch Setting	
[1662]	Analog Input 53	
[1663]	Terminal 54 Switch Setting	
[1664]	Analog Input 54	
[1665]	Analog Output 42 [mA]	
[1666]	Digital Output [bin]	
[1667]	Pulse Input #29 [Hz]	
[1668]	Pulse Input #33 [Hz]	
[1669]	Pulse Output #27 [Hz]	
[1670]	Pulse Output #29 [Hz]	
[1671]	Relay Output [bin]	
[1672]	Counter A	
[1673]	Counter B	
[1675]	Analog In X30/11	
[1676]	Analog In X30/12	
[1677]	Analog Out X30/8 [mA]	
[1678]	Analog Out X45/1 [mA]	
[1679]	Analog Out X45/3 [mA]	
[1680]	Fieldbus CTW 1	
[1682]	Fieldbus REF 1	
[1684]	Comm. Option STW	
[1685]	FC Port CTW 1	
[1686]	FC Port REF 1	
[1690]	Alarm Word	
[1691]	Alarm Word 2	

9-23 Parameters for Signals		
Array [1000]		
Option:	Function:	
[1692]	Warning Word	
[1693]	Warning Word 2	
[1694]	Ext. Status Word	
[1695]	Ext. Status Word 2	
[1696]	Maintenance Word	
[1830]	Analog Input X42/1	
[1831]	Analog Input X42/3	
[1832]	Analog Input X42/5	
[1833]	Analog Out X42/7 [V]	
[1834]	Analog Out X42/9 [V]	
[1835]	Analog Out X42/11 [V]	
[1836]	Analog Input X48/2 [mA]	
[1837]	Temp. Input X48/4	
[1838]	Temp. Input X48/7	
[1839]	Temp. Input X48/10	
[1850]	Sensorless Readout [unit]	
[1860]	Digital Input 2	
[2013]	Minimum Reference/Feedb.	
[2014]	Maximum Reference/Feedb.	
[2021]	Setpoint 1	
[2022]	Setpoint 2	
[2023]	Setpoint 3	
[2643]	Terminal X42/7 Bus Control	
[2653]	Terminal X42/9 Bus Control	
[2663]	Terminal X42/11 Bus Control	

9-27 Parameter Edit		
Option:	Function:	
		Parameters can be edited via PROFIBUS, the standard RS485 interface, or the LCP.
[0]	Disabled	Disables editing via PROFIBUS.
[1] *	Enabled	Enables editing via PROFIBUS.

9-28 Process Control		
Option:	Function:	
		Process control (setting of control word, speed reference, and process data) is possible via either PROFIBUS or standard fieldbus, but not both simultaneously. Local control is always possible via the LCP. Control via process control is possible via either terminals or fieldbus depending on the settings in <i>parameter 8-50 Coasting Select</i> to <i>parameter 8-56 Preset Reference Select</i> .
[0]	Disable	Disables process control via PROFIBUS, and enables process control via standard fieldbus or PROFIBUS master class 2.
[1]	Enable cyclic master	Enables process control via PROFIBUS master class 1, and disables process control via standard fieldbus or PROFIBUS master class 2.

9-53 Profibus Warning Word		
Read only		
Range:	Function:	
0*	[0 - 65535]	This parameter displays PROFIBUS communication warnings. Refer to the <i>PROFIBUS Operating Instructions</i> for further information.

Bit	Meaning
0	Connection with DP-master is not OK.
1	Not used.
2	FDL (fieldbus data link layer) is not OK.
3	Clear data command received.
4	Actual value is not updated.
5	Baudrate search.
6	PROFIBUS ASIC is not transmitting.
7	Initialisation of PROFIBUS is not OK.
8	Frequency converter is tripped.
9	Internal CAN error.
10	Wrong configuration data from PLC.
11	Wrong ID sent by PLC.
12	Internal error occurred.
13	Not configured.
14	Time-out active.
15	Warning 34 active.

Table 3.15 PROFIBUS Warning Word

9-63 Actual Baud Rate		
Option:	Function:	
		This parameter displays the actual PROFIBUS baud rate. The PROFIBUS master automatically sets the baud rate.
[0]	9,6 kbit/s	
[1]	19,2 kbit/s	
[2]	93,75 kbit/s	
[3]	187,5 kbit/s	
[4]	500 kbit/s	
[6]	1500 kbit/s	
[7]	3000 kbit/s	
[8]	6000 kbit/s	
[9]	12000 kbit/s	
[10]	31,25 kbit/s	
[11]	45,45 kbit/s	
[255] *	No baudrate found	

9-65 Profile Number		
Range:	Function:	
0*	[0 - 0]	This parameter contains the profile identification. Byte 1 contains the profile number and byte 2 the version number of the profile.

9-70 Programming Set-up		
This parameter is unique for LCP and fieldbus. See <i>parameter 0-11 Programming Set-up</i> .		
Option:	Function:	
	Select the set-up to be edited.	
[0]	Factory setup	Uses default data. This option can be used as a data source to return the other set-ups to a known state.
[1]	Set-up 1	Edits Set-up 1.
[2]	Set-up 2	Edits Set-up 2.
[3]	Set-up 3	Edits Set-up 3.
[4]	Set-up 4	Edits Set-up 4.
[9] *	Active Set-up	Follows the active set-up selected in <i>parameter 0-10 Active Set-up</i> .

9-71 Profibus Save Data Values		
Option:	Function:	
	Parameter values changed via PROFIBUS are not automatically stored in non-volatile memory. Use this parameter to activate a function that stores parameter values in the EEPROM non-volatile memory, so changed parameter values are retained at power-down.	
[0] *	Off	Deactivates the non-volatile storage function.
[1]	Store all setups	Stores all parameter values for all set-ups in the non-volatile memory. When all parameter values have been stored, the selection returns to [0] Off.
[2]	Store all setups	Stores all parameter values for all set-ups in the non-volatile memory. When all parameter values have been stored, the selection returns to [0] Off.

9-72 ProfibusDriveReset		
Option:	Function:	
[0] *	No action	
[1]	Power-on reset	Resets the frequency converter upon power-up, as for power-cycle.
[3]	Comm option reset	Resets the PROFIBUS option only, useful after changing certain settings in parameter group 9-** Profibus, for example, <i>parameter 9-18 Node Address</i> . When reset, the frequency converter disappears from the fieldbus, which may cause a communication error from the master.

9-80 Defined Parameters (1)		
Array [116]		
No LCP access		
Read only		
Range:	Function:	
0*	[0 - 9999]	This parameter displays a list of all the defined frequency converter parameters available for PROFIBUS.

9-81 Defined Parameters (2)		
Array [116]		
No LCP access		
Read only		
Range:	Function:	
0*	[0 - 9999]	This parameter displays a list of all the defined frequency converter parameters available for PROFIBUS.

9-82 Defined Parameters (3)		
Array [116]		
No LCP access		
Read only		
Range:	Function:	
0*	[0 - 9999]	This parameter displays a list of all the defined frequency converter parameters available for PROFIBUS.

9-83 Defined Parameters (4)		
Array [116]		
No LCP access		
Read only		
Range:	Function:	
0*	[0 - 9999]	This parameter displays a list of all the defined frequency converter parameters available for PROFIBUS.

9-90 Changed Parameters (1)		
Array [116]		
No LCP access		
Read only		
Range:	Function:	
0*	[0 - 9999]	This parameter displays a list of all the frequency converter parameters deviating from default setting.

9-91 Changed Parameters (2)		
Array [116]		
No LCP access		
Read only		
Range:	Function:	
0*	[0 - 9999]	This parameter displays a list of all the frequency converter parameters deviating from default setting.

9-92 Changed Parameters (3)		
Array [116] No LCP access Read only		
Range:		Function:
0*	[0 - 9999]	This parameter displays a list of all the frequency converter parameters deviating from default setting.

9-94 Changed Parameters (5)		
Array [116] No LCP Address Read only		
Range:		Function:
0*	[0 - 9999]	This parameter displays a list of all the frequency converter parameters deviating from default setting.

3.11 Parameters: 10-** Main Menu - CAN Fieldbus

For DeviceNet parameter descriptions, see the *DeviceNet Operating Instructions*.

3.11.1 10-** DeviceNet and CAN Fieldbus

3.11.2 10-0* Common Settings

10-00 CAN Protocol		
Option:	Function:	
[1] *	DeviceNet	<p>NOTICE</p> <p>The parameter options depend on installed option.</p> <p>View the active CAN protocol.</p>

10-01 Baud Rate Select		
Option:	Function:	
		Select the fieldbus transmission speed. The selection must correspond to the transmission speed of the master and the other fieldbus nodes.
[16]	10 Kbps	
[17]	20 Kbps	
[18]	50 Kbps	
[19]	100 Kbps	
[20]	125 Kbps	
[21]	250 Kbps	
[22]	500 Kbps	
[23]	800 Kbps	
[24]	1000 Kbps	

10-02 MAC ID		
Range:	Function:	
Size related*	[0 - 63]	Selection of station address. Every station connected to the same DeviceNet network must have an unambiguous address.

10-05 Readout Transmit Error Counter		
Range:	Function:	
0*	[0 - 255]	View the number of CAN control transmission errors since the last power-up.

10-06 Readout Receive Error Counter		
Range:	Function:	
0*	[0 - 255]	View the number of CAN control receipt errors since the last power-up.

10-07 Readout Bus Off Counter		
Range:	Function:	
0*	[0 - 255]	View the number of bus off events since the last power-up.

3.11.3 10-1* DeviceNet

10-10 Process Data Type Selection		
Option:	Function:	
		<p>Select the instance (telegram) for data transmission. The instances available depend on the setting of <i>parameter 8-10 Control Profile</i>.</p> <p>When <i>parameter 8-10 Control Profile</i> is set to [0] FC profile, <i>parameter 10-10 Process Data Type Selection</i> options [0] INSTANCE 100/150 and [1] INSTANCE 101/151 are available.</p> <p>When <i>parameter 8-10 Control Profile</i> is set to [5] ODVA, <i>parameter 10-10 Process Data Type Selection</i> options [2] INSTANCE 20/70 and [3] INSTANCE 21/71 are available.</p> <p>Instances 100/150 and 101/151 are Danfoss-specific. Instances 20/70 and 21/71 are ODVA-specific AC Drive profiles.</p> <p>For guidelines in telegram selection, refer to the <i>VLT DeviceNet® Operating Instructions</i>.</p> <p>NOTICE</p> <p>A change to this parameter is executed immediately.</p>
[0]	INSTANCE 100/150	
[1]	INSTANCE 101/151	
[2]	INSTANCE 20/70	
[3]	INSTANCE 21/71	

10-11 Process Data Config Write		
Option:	Function:	
		Select the process write data for I/O assembly instances 101/151. Elements [2] and [3] of this array can be selected. Elements [0] and [1] of the array are fixed.
[0]	None	
[302]	Minimum Reference	
[303]	Maximum Reference	
[341]	Ramp 1 Ramp Up Time	
[342]	Ramp 1 Ramp Down Time	

10-11 Process Data Config Write		
Option:	Function:	
[351]	Ramp 2 Ramp Up Time	
[352]	Ramp 2 Ramp Down Time	
[380]	Jog Ramp Time	
[381]	Quick Stop Ramp Time	
[411]	Motor Speed Low Limit [RPM]	
[412]	Motor Speed Low Limit [Hz]	
[413]	Motor Speed High Limit [RPM]	
[414]	Motor Speed High Limit [Hz]	
[416]	Torque Limit Motor Mode	
[417]	Torque Limit Generator Mode	
[553]	Term. 29 High Ref./Feedb. Value	
[558]	Term. 33 High Ref./Feedb. Value	
[590]	Digital & Relay Bus Control	
[593]	Pulse Out #27 Bus Control	
[595]	Pulse Out #29 Bus Control	
[597]	Pulse Out #X30/6 Bus Control	
[615]	Terminal 53 High Ref./Feedb. Value	
[625]	Terminal 54 High Ref./Feedb. Value	
[653]	Terminal 42 Output Bus Control	
[663]	Terminal X30/8 Output Bus Control	
[673]	Terminal X45/1 Bus Control	
[683]	Terminal X45/3 Bus Control	
[890]	Bus Jog 1 Speed	
[891]	Bus Jog 2 Speed	
[894]	Bus Feedback 1	
[895]	Bus Feedback 2	
[896]	Bus Feedback 3	
[1680]	Fieldbus CTW 1	
[1682]	Fieldbus REF 1	
[1685]	FC Port CTW 1	
[1686]	FC Port REF 1	

10-12 Process Data Config Read		
Option:	Function:	
		Select the process read data for I/O assembly instances 101/151. Elements [2] and [3] of this array can be selected. Elements [0] and [1] of the array are fixed.

10-13 Warning Parameter		
Range:	Function:	
0*	[0 - 65535]	View a DeviceNet-specific warning word. One bit is assigned to every warning. Refer to the <i>VLT® DeviceNet Operating Instructions</i> for further information.

Bit	Description
0	Bus not active.
1	Explicit connection timeout.
2	I/O connection.
3	Retry limit reached.
4	Actual is not updated.
5	CAN bus off.

Bit	Description
6	I/O send error.
7	Initialisation error.
8	No bus supply.
9	Bus off.
10	Error passive.
11	Error warning.
12	Duplicate MAC ID error.
13	RX queue overrun.
14	TX queue overrun.
15	CAN overrun.

Table 3.16 Warning Bits

10-14 Net Reference		
Read only from LCP.		
Option:	Function:	
		Select the reference source in instances 21/71 and 20/70.
[0] *	Off	Enables reference via analog/digital inputs.
[1]	On	Enables reference via the fieldbus.

10-15 Net Control		
Read only from LCP.		
Option:	Function:	
		Select the control source in instances 21/71 and 20/70.
[0] *	Off	Enables control via analog/digital inputs.
[1]	On	Enable control via the fieldbus.

3.11.4 10-2* COS Filters

10-20 COS Filter 1		
Range:	Function:	
0*	[0 - 65535]	Enter the value for COS filter 1 to set up the filter mask for the status word. When operating in COS (change-of-state), this function filters out bits in the status word that should not be sent if they change.

10-21 COS Filter 2		
Range:	Function:	
0*	[0 - 65535]	Enter the value for COS filter 2, to set up the filter mask for the Main Actual Value. When operating in COS (change-of-state), this function filters out bits in the Main Actual Value that should not be sent if they change.

10-22 COS Filter 3		
Range:		Function:
0*	[0 - 65535]	Enter the value for COS filter 3, to set up the filter mask for PCD 3. When operating in COS (change-of-state), this function filters out bits in PCD 3 that should not be sent if they change.

10-23 COS Filter 4		
Range:		Function:
0*	[0 - 65535]	Enter the value for COS filter 4 to set up the filter mask for PCD 4. When operating in COS (change-of-state), this function filters out bits in PCD 4 that should not be sent if they change.

3.11.5 10-3* Parameter Access

Parameter group providing access to indexed parameters and defining programming set-up.

10-31 Store Data Values		
Option:	Function:	
		Parameter values changed via DeviceNet are not automatically stored in non-volatile memory. Use this parameter to activate a function that stores parameter values in the EEPROM non-volatile memory, so changed parameter values are retained at power-down.
[0] *	Off	Deactivates the non-volatile storage function.
[1]	Store all setups	Stores all parameter values from the active set-up in the non-volatile memory. The selection returns to [0] Off when all values have been stored.
[2]	Store all setups	Stores all parameter values for all set-ups in the non-volatile memory. The selection returns to [0] Off when all parameter values have been stored.

10-33 Store Always		
Option:	Function:	
[0] *	Off	Deactivates non-volatile storage of data.
[1]	On	Stores parameter data received via DeviceNet in EEPROM non-volatile memory as default.

3.12 Parameters: 11-** Main Menu - LonWorks

Parameter group for all LonWorks specific parameters. Parameters related to LonWorks ID.

11-00 Neuron ID		
Range:	Function:	
0*	[0 - 0]	View the Neuron chip's unique Neuron ID number.

11-10 Drive Profile		
Option:	Function:	
		This parameter allows selecting between LONMARK functional profiles.
[0] *	VSD profile	The Danfoss Profile and the Node Object are common for all profiles.

11-15 LON Warning Word		
Range:	Function:	
0*	[0 - 65535]	This parameter contains the LON specific warnings.

Bit	Status
0	Internal fault
1	Internal fault
2	Internal fault
3	Internal fault
4	Internal fault
5	Reserved
6	Reserved
7	Reserved
8	Reserved
9	Changeable types
10	Initialisation error
11	Internal communication error
12	Software revision mismatch
13	Bus not active
14	Option not present
15	LON input (nvi/nci) exceeds limits

Table 3.17 LON Warning Word

11-17 XIF Revision		
Range:	Function:	
0*	[0 - 5]	This parameter contains the version of the external interface file on the Neuron C chip on the LON option.

11-18 LonWorks Revision		
Range:	Function:	
0*	[0 - 5]	This parameter contains the software version of the application program on the Neuron C chip on the LON option.

11-21 Store Data Values

Option:	Function:	
		This parameter is used to activate storing of data in the non-volatile memory.
[0] *	Off	Store function is inactive.
[2]	Store all setups	Stores all parameter values in the E ² PROM. The value returns to <i>Off</i> when all parameter values have been stored.



3.13 Parameters: 13-** Main Menu - Smart Logic

3.13.1 13-** Prog. Features

Smart logic control (SLC) is a sequence of user-defined actions (see *parameter 13-52 SL Controller Action [x]*) executed by the SLC when the associated user-defined event (see *parameter 13-51 SL Controller Event [x]*) is evaluated as TRUE by the SLC. Events and actions are each numbered and linked together in pairs. This means that when [0] event is fulfilled (attains the value TRUE), [0] action is executed. After this, the conditions of [1] event are evaluated and if evaluated TRUE, [1] action is executed and so on. Only 1 event is evaluated at any time. If an event is evaluated as FALSE, nothing happens (in the SLC) during the current scan interval and no other events are evaluated. This means that when the SLC starts, it evaluates [0] event (and only [0] event) at each scan interval. Only when [0] event is evaluated TRUE, the SLC executes [0] action and starts evaluating [1] event. It is possible to programme from 1 to 20 events and actions. When the last event/action has been executed, the sequence starts over again from [0] event/[0] action.

Illustration 3.34 shows an example with three event/actions

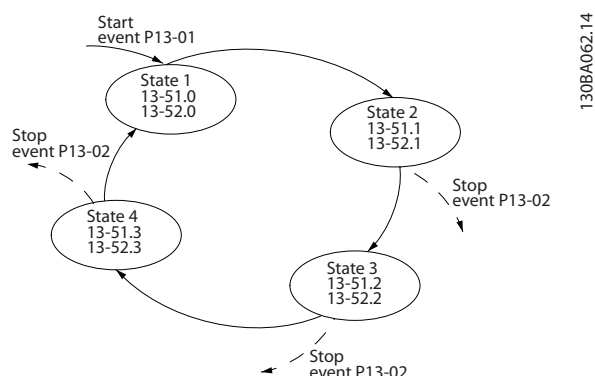

Illustration 3.34 Example with Three Events/Actions

Starting and stopping the SLC:

Starting and stopping the SLC can be done by selecting [1] On or [0] Off in *parameter 13-00 SL Controller Mode*. The SLC always starts in state 0 (where it evaluates [0] event). The SLC starts when the start event (defined in *parameter 13-01 Start Event*) is evaluated as TRUE (provided that [1] On is selected in *parameter 13-00 SL Controller Mode*). The SLC stops when the stop event (*parameter 13-02 Stop Event*) is TRUE. *Parameter 13-03 Reset SLC* resets all SLC parameters and starts programming from scratch.

3.13.2 13-0* SLC Settings

Use the SLC settings to activate, deactivate, and reset the smart logic control sequence. The logic functions and comparators are always running in the background, which opens for separate control of digital inputs and outputs.

13-00 SL Controller Mode		
Option:	Function:	
[0]	Off	Disables the Smart Logic Controller.
[1]	On	Enables the Smart Logic Controller.

13-01 Start Event		
Option:	Function:	
		Select the boolean (TRUE or FALSE) input to activate smart logic control.
[0]	False	Enters the fixed value of FALSE in the logic rule.
[1]	True	Enters the fixed value TRUE in the logic rule.
[2]	Running	See parameter group 5-3* <i>Digital Outputs</i> for further description.
[3]	In range	See parameter group 5-3* <i>Digital Outputs</i> for further description.
[4]	On reference	See parameter group 5-3* <i>Digital Outputs</i> for further description.
[5]	Torque limit	See parameter group 5-3* <i>Digital Outputs</i> for further description.
[6]	Current Limit	See parameter group 5-3* <i>Digital Outputs</i> for further description.
[7]	Out of current range	See parameter group 5-3* <i>Digital Outputs</i> for further description.
[8]	Below I low	See parameter group 5-3* <i>Digital Outputs</i> for further description.
[9]	Above I high	See parameter group 5-3* <i>Digital Outputs</i> for further description.
[10]	Out of speed range	
[11]	Below speed low	See parameter group 5-3* <i>Digital Outputs</i> for further description.
[12]	Above speed high	See parameter group 5-3* <i>Digital Outputs</i> for further description.
[13]	Out of feedb. range	
[14]	Below feedb. low	
[15]	Above feedb. high	
[16]	Thermal warning	See parameter group 5-3* <i>Digital Outputs</i> for further description.
[17]	Mains out of range	See parameter group 5-3* <i>Digital Outputs</i> for further description.

13-01 Start Event		
Option:	Function:	
[18]	Reversing	See parameter group 5-3* <i>Digital Outputs</i> for further description.
[19]	Warning	See parameter group 5-3* <i>Digital Outputs</i> for further description.
[20]	Alarm (trip)	See parameter group 5-3* <i>Digital Outputs</i> for further description.
[21]	Alarm (trip lock)	See parameter group 5-3* <i>Digital Outputs</i> for further description.
[22]	Comparator 0	Use the result of comparator 0 in the logic rule.
[23]	Comparator 1	Use the result of comparator 1 in the logic rule.
[24]	Comparator 2	Use the result of comparator 2 in the logic rule.
[25]	Comparator 3	Use the result of comparator 3 in the logic rule.
[26]	Logic rule 0	Use the result of logic rule 0 in the logic rule.
[27]	Logic rule 1	Use the result of logic rule 1 in the logic rule.
[28]	Logic rule 2	Use the result of logic rule 2 in the logic rule.
[29]	Logic rule 3	Use the result of logic rule 3 in the logic rule.
[33]	Digital input DI18	Use the value of DI18 in the logic rule (High=TRUE).
[34]	Digital input DI19	Use the value of DI19 in the logic rule (High=TRUE).
[35]	Digital input DI27	Use the value of DI27 in the logic rule (High=TRUE).
[36]	Digital input DI29	Use the value of DI29 in the logic rule (High=TRUE).
[37]	Digital input DI32	Use the value of DI32 in the logic rule (High=TRUE).
[38]	Digital input DI33	Use the value of DI33 in the logic rule (High=TRUE).
[39]	Start command	This event is TRUE if the frequency converter is started (either via digital input, fieldbus or other).
[40]	Drive stopped	This event is TRUE if the frequency converter is stopped or coasted (either via digital input, fieldbus or other).
[41]	Reset Trip	This event is TRUE if the frequency converter is tripped (but not trip-locked) and [Reset] is pressed.

13-01 Start Event		
Option:	Function:	
[42]	Auto Reset Trip	This event is TRUE if the frequency converter is tripped (but not trip-locked) and an automatic reset is issued.
[43]	OK Key	This event is TRUE if [OK] is pressed.
[44]	Reset Key	This event is TRUE if [Reset] is pressed.
[45]	Left Key	This event is TRUE if [◀] is pressed.
[46]	Right Key	This event is TRUE if [▶] is pressed.
[47]	Up Key	This event is TRUE if [▲] is pressed.
[48]	Down Key	This event is TRUE if [▼] is pressed.
[50]	Comparator 4	Use the result of comparator 4 in the logic rule.
[51]	Comparator 5	Use the result of comparator 5 in the logic rule.
[60]	Logic rule 4	Use the result of logic rule 4 in the logic rule.
[61]	Logic rule 5	Use the result of logic rule 5 in the logic rule.
[76]	Digital Input x30 2	
[77]	Digital Input x30 3	
[78]	Digital Input x30 4	
[90]	ECB Drive Mode	
[91]	ECB Bypass Mode	
[92]	ECB Test Mode	
[100]	Fire Mode	See 13-15 RS-FF Operand S, 13-16 RS-FF Operand R.

13-02 Stop Event		
Option:	Function:	
		Select the boolean (TRUE or FALSE) input to deactivate smart logic control.
[0]	False	Enters the fixed value of FALSE in the logic rule.
[1]	True	Enters the fixed value TRUE in the logic rule.
[2]	Running	See parameter group 5-3* <i>Digital Outputs</i> for further description.
[3]	In range	See parameter group 5-3* <i>Digital Outputs</i> for further description.
[4]	On reference	See parameter group 5-3* <i>Digital Outputs</i> for further description.
[5]	Torque limit	See parameter group 5-3* <i>Digital Outputs</i> for further description.

13-02 Stop Event		
Option:	Function:	
[6]	Current Limit	See parameter group 5-3* <i>Digital Outputs</i> for further description.
[7]	Out of current range	See parameter group 5-3* <i>Digital Outputs</i> for further description.
[8]	Below I low	See parameter group 5-3* <i>Digital Outputs</i> for further description.
[9]	Above I high	See parameter group 5-3* <i>Digital Outputs</i> for further description.
[10]	Out of speed range	
[11]	Below speed low	See parameter group 5-3* <i>Digital Outputs</i> for further description.
[12]	Above speed high	See parameter group 5-3* <i>Digital Outputs</i> for further description.
[13]	Out of feedb. range	See parameter group 5-3* <i>Digital Outputs</i> for further description.
[14]	Below feedb. low	See parameter group 5-3* <i>Digital Outputs</i> for further description.
[15]	Above feedb. high	See parameter group 5-3* <i>Digital Outputs</i> for further description.
[16]	Thermal warning	See parameter group 5-3* <i>Digital Outputs</i> for further description.
[17]	Mains out of range	See parameter group 5-3* <i>Digital Outputs</i> for further description.
[18]	Reversing	See parameter group 5-3* <i>Digital Outputs</i> for further description.
[19]	Warning	See parameter group 5-3* <i>Digital Outputs</i> for further description.
[20]	Alarm (trip)	See parameter group 5-3* <i>Digital Outputs</i> for further description.
[21]	Alarm (trip lock)	See parameter group 5-3* <i>Digital Outputs</i> for further description.
[22]	Comparator 0	Use the result of comparator 0 in the logic rule.
[23]	Comparator 1	Use the result of comparator 1 in the logic rule.
[24]	Comparator 2	Use the result of comparator 2 in the logic rule.
[25]	Comparator 3	Use the result of comparator 3 in the logic rule.
[26]	Logic rule 0	Use the result of logic rule 0 in the logic rule.
[27]	Logic rule 1	Use the result of logic rule 1 in the logic rule.
[28]	Logic rule 2	Use the result of logic rule 2 in the logic rule.

13-02 Stop Event		
Option:	Function:	
[29]	Logic rule 3	Use the result of logic rule 3 in the logic rule.
[30]	SL Time-out 0	Use the result of timer 0 in the logic rule.
[31]	SL Time-out 1	Use the result of timer 1 in the logic rule.
[32]	SL Time-out 2	Use the result of timer 2 in the logic rule.
[33]	Digital input DI18	Use the value of DI18 in the logic rule (High=TRUE).
[34]	Digital input DI19	Use the value of DI19 in the logic rule (High=TRUE).
[35]	Digital input DI27	Use the value of DI27 in the logic rule (High=TRUE).
[36]	Digital input DI29	Use the value of DI29 in the logic rule (High=TRUE).
[37]	Digital input DI32	Use the value of DI32 in the logic rule (High=TRUE).
[38]	Digital input DI33	Use the value of DI33 in the logic rule (High=TRUE).
[39]	Start command	This event is TRUE if the frequency converter is started (either via digital input, fieldbus or other).
[40]	Drive stopped	This event is TRUE if the frequency converter is stopped or coasted (either via digital input, fieldbus or other).
[41]	Reset Trip	This event is TRUE if the frequency converter is tripped (but not trip-locked) and [Reset] is pressed.
[42]	Auto Reset Trip	This event is TRUE if the frequency converter is tripped (but not trip-locked) and an automatic reset is issued.
[43]	OK Key	This event is TRUE if [OK] is pressed.
[44]	Reset Key	This event is TRUE if [Reset] is pressed.
[45]	Left Key	This event is TRUE if [◀] is pressed.
[46]	Right Key	This event is TRUE if [▶] is pressed.
[47]	Up Key	This event is TRUE if [▲] is pressed.
[48]	Down Key	This event is TRUE if [▼] is pressed.
[50]	Comparator 4	Use the result of comparator 4 in the logic rule.
[51]	Comparator 5	Use the result of comparator 5 in the logic rule.
[60]	Logic rule 4	Use the result of logic rule 4 in the logic rule.

13-02 Stop Event		
Option:	Function:	
[61]	Logic rule 5	Use the result of logic rule 5 in the logic rule.
[70]	SL Time-out 3	Use the result of timer 3 in the logic rule.
[71]	SL Time-out 4	Use the result of timer 4 in the logic rule.
[72]	SL Time-out 5	Use the result of timer 5 in the logic rule.
[73]	SL Time-out 6	Use the result of timer 6 in the logic rule.
[74]	SL Time-out 7	Use the result of timer 7 in the logic rule.
[76]	Digital Input x30 2	
[77]	Digital Input x30 3	
[78]	Digital Input x30 4	
[80]	No Flow	
[81]	Dry Pump	
[82]	End of Curve	
[83]	Broken Belt	
[90]	ECB Drive Mode	
[91]	ECB Bypass Mode	
[92]	ECB Test Mode	
[100]	Fire Mode	See 13-15 RS-FF Operand S, 13-16 RS-FF Operand R.

13-03 Reset SLC		
Option:	Function:	
[0] *	Do not reset SLC	Retains programmed settings in all parameter group 13-** Smart Logic Control.
[1]	Reset SLC	Resets all parameters in parameter group 13-** Smart Logic Control to default settings.

3.13.3 13-1* Comparators

Comparators are used for comparing continuous variables (that is output frequency, output current, analog input and so on.) to fixed preset values.

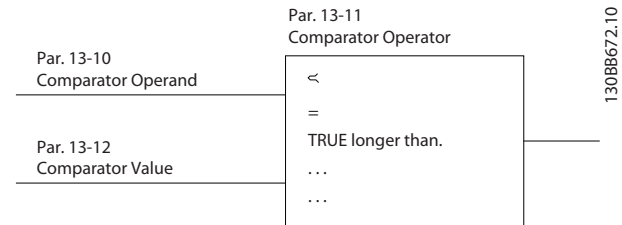

Illustration 3.35 Comparators

There are digital values that are compared to fixed time values. See explanation in 13-10 Comparator Operand. Comparators are evaluated once in each scan interval. Use the result (TRUE or FALSE) directly. All parameters in this parameter group are array parameters with index 0 to 5. Select index 0 to programme comparator 0, select index 1 to programme comparator 1, and so on.

13-10 Comparator Operand		
Option:	Function:	
		Select the variable to be monitored by the comparator.
[0]	DISABLED	
[1]	Reference %	
[2]	Feedback %	
[3]	Motor speed	
[4]	Motor Current	
[5]	Motor torque	
[6]	Motor power	
[7]	Motor voltage	
[8]	DC-link voltage	
[9]	Motor Thermal	
[10]	Drive thermal	
[11]	Heat sink temp.	
[12]	Analog input AI53	
[13]	Analog input AI54	
[14]	Analog input AIFB10	
[15]	Analog input AIS24V	
[17]	Analog input AICCT	
[18]	Pulse input FI29	
[19]	Pulse input FI33	
[20]	Alarm number	
[21]	Warning number	
[22]	Analog input x30 11	
[23]	Analog input x30 12	
[24]	Sensorless Flow	
[25]	Sensorless Pressure	
[30]	Counter A	

13-10 Comparator Operand		
Array [4]		
Option:	Function:	
[31]	Counter B	
[34]	Analog Input x48/2	
[35]	Temp Input x48/4	
[36]	Temp Input x48/7	
[37]	Temp Input x48/10	
[40]	Analog input x42/1	
[41]	Analog input x42/3	
[42]	Analog input x42/5	
[50]	FALSE	
[51]	TRUE	
[52]	Control ready	
[53]	Drive ready	
[54]	Running	
[55]	Reversing	
[56]	In range	
[60]	On reference	
[61]	Below reference, low	
[62]	Above ref, high	
[65]	Torque limit	
[66]	Current Limit	
[67]	Out of current range	
[68]	Below I low	
[69]	Above I high	
[70]	Out of speed range	
[71]	Below speed low	
[72]	Above speed high	
[75]	Out of feedback range	
[76]	Below feedback low	
[77]	Above feedback high	
[80]	Thermal warning	
[82]	Mains out of range	
[85]	Warning	
[86]	Alarm (trip)	
[87]	Alarm (trip lock)	
[90]	Bus OK	
[91]	Torque limit & stop	
[92]	Brake fault (IGBT)	
[93]	Mech. brake control	
[94]	Safe stop active	
[100]	Comparator 0	
[101]	Comparator 1	
[102]	Comparator 2	
[103]	Comparator 3	
[104]	Comparator 4	
[105]	Comparator 5	
[110]	Logic rule 0	
[111]	Logic rule 1	
[112]	Logic rule 2	
[113]	Logic rule 3	
[114]	Logic rule 4	
[115]	Logic rule 5	

13-10 Comparator Operand		
Array [4]		
Option:	Function:	
[120]	SL Time-out 0	
[121]	SL Time-out 1	
[122]	SL Time-out 2	
[123]	SL Time-out 3	
[124]	SL Time-out 4	
[125]	SL Time-out 5	
[126]	SL Time-out 6	
[127]	SL Time-out 7	
[130]	Digital input DI18	
[131]	Digital input DI19	
[132]	Digital input DI27	
[133]	Digital input DI29	
[134]	Digital input DI32	
[135]	Digital input DI33	
[150]	SL digital output A	
[151]	SL digital output B	
[152]	SL digital output C	
[153]	SL digital output D	
[154]	SL digital output E	
[155]	SL digital output F	
[160]	Relay 1	
[161]	Relay 2	
[180]	Local reference active	
[181]	Remote reference active	
[182]	Start command	
[183]	Drive stopped	
[185]	Drive in hand mode	
[186]	Drive in auto mode	
[187]	Start command given	
[190]	Digital input x30/2	
[191]	Digital input x30/3	
[192]	Digital input x30/4	

13-11 Comparator Operator		
Array [6]		
Option:	Function:	
[0]	<	Select [0] < for the result of the evaluation to be TRUE, when the variable selected in <i>parameter 13-10 Comparator Operand</i> is smaller than the fixed value in <i>parameter 13-12 Comparator Value</i> . The result is FALSE, if the variable selected in <i>parameter 13-10 Comparator Operand</i> is greater than the fixed value in <i>parameter 13-12 Comparator Value</i> .
[1]	≈ (equal)	Select [1] ≈ for the result of the evaluation to be TRUE, when the variable selected in <i>parameter 13-10 Comparator Operand</i> is approxi-

13-11 Comparator Operator		
Array [6]		
Option:		Function:
		imately equal to the fixed value in <i>parameter 13-12 Comparator Value</i> .
[2]	>	Select [2] > for the inverse logic of option [0] <.
[5]	TRUE longer than..	
[6]	FALSE longer than..	
[7]	TRUE shorter than..	
[8]	FALSE shorter than..	

13-12 Comparator Value		
Array [6]		
Range:		Function:
Size related*	[-100000 - 100000]	Enter the trigger level for the variable that is monitored by this comparator. This is an array parameter containing comparator values 0 to 5.

3.13.4 13-2* Timers

Use the result (TRUE or FALSE) from *timers* directly to define an *event* (see *parameter 13-51 SL Controller Event*), or as boolean input in a *logic rule* (see *parameter 13-40 Logic Rule Boolean 1*, *parameter 13-42 Logic Rule Boolean 2*, or *parameter 13-44 Logic Rule Boolean 3*). A timer is only FALSE when started by an action (for example [29] *Start timer 1*) until the timer value entered in this parameter has elapsed. Then it becomes TRUE again.

All parameters in this parameter group are array parameters with index 0 to 2. Select index 0 to programme timer 0, select index 1 to programme timer 1, and so on.

13-20 SL Controller Timer		
Array [3]		
Range:		Function:
Size related*	[0 - 0]	Enter the value to define the duration of the FALSE output from the programmed timer. A timer is only FALSE if it is started by an action (for example [29] <i>Start timer 1</i>) and until the given timer value has elapsed.

3.13.5 13-4* Logic Rules

Combine up to 3 boolean inputs (TRUE/FALSE inputs) from timers, comparators, digital inputs, status bits, and events using the logical operators AND, OR, and NOT. Select boolean inputs for the calculation in *parameter 13-40 Logic Rule Boolean 1*, *parameter 13-42 Logic Rule Boolean 2*, and *parameter 13-44 Logic Rule Boolean 3*. Define the operators used to logically combine the selected inputs in *parameter 13-41 Logic Rule Operator 1* and *parameter 13-43 Logic Rule Operator 2*.

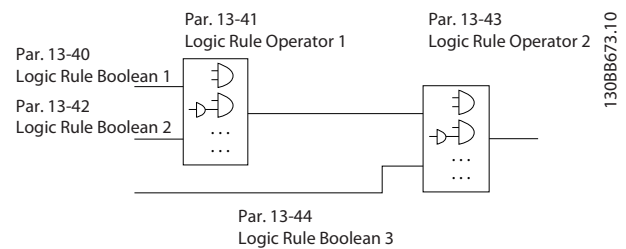

Illustration 3.36 Logic Rules

Priority of calculation

The results of *parameter 13-40 Logic Rule Boolean 1*, *parameter 13-41 Logic Rule Operator 1*, and *parameter 13-42 Logic Rule Boolean 2* are calculated first. The outcome (TRUE/FALSE) of this calculation is combined with the settings of *parameter 13-43 Logic Rule Operator 2* and *parameter 13-44 Logic Rule Boolean 3*, yielding the final result (TRUE/FALSE) of the logic rule.

13-40 Logic Rule Boolean 1		
Array [6]		
Option:		Function:
[0]	False	Enters the fixed value of FALSE in the logic rule.
[1]	True	Enters the fixed value TRUE in the logic rule.
[2]	Running	See <i>chapter 3.7.3 5-3* Digital Outputs</i> for further description.
[3]	In range	See <i>chapter 3.7.3 5-3* Digital Outputs</i> for further description.
[4]	On reference	See <i>chapter 3.7.3 5-3* Digital Outputs</i> for further description.
[5]	Torque limit	See <i>chapter 3.7.3 5-3* Digital Outputs</i> for further description.
[6]	Current Limit	See <i>chapter 3.7.3 5-3* Digital Outputs</i> for further description.
[7]	Out of current range	See <i>chapter 3.7.3 5-3* Digital Outputs</i> for further description.
[8]	Below I low	See <i>chapter 3.7.3 5-3* Digital Outputs</i> for further description.

13-40 Logic Rule Boolean 1		
Array [6]		
Option:	Function:	
[9]	Above l high	See <i>chapter 3.7.3 5-3* Digital Outputs</i> for further description.
[10]	Out of speed range	
[11]	Below speed low	See <i>chapter 3.7.3 5-3* Digital Outputs</i> for further description.
[12]	Above speed high	See <i>chapter 3.7.3 5-3* Digital Outputs</i> for further description.
[13]	Out of feedb. range	See <i>chapter 3.7.3 5-3* Digital Outputs</i> for further description.
[14]	Below feedb. low	See <i>chapter 3.7.3 5-3* Digital Outputs</i> for further description.
[15]	Above feedb. high	See <i>chapter 3.7.3 5-3* Digital Outputs</i> for further description.
[16]	Thermal warning	See <i>chapter 3.7.3 5-3* Digital Outputs</i> for further description.
[17]	Mains out of range	See <i>chapter 3.7.3 5-3* Digital Outputs</i> for further description.
[18]	Reversing	See <i>chapter 3.7.3 5-3* Digital Outputs</i> for further description.
[19]	Warning	See <i>chapter 3.7.3 5-3* Digital Outputs</i> for further description.
[20]	Alarm (trip)	See <i>chapter 3.7.3 5-3* Digital Outputs</i> for further description.
[21]	Alarm (trip lock)	See <i>chapter 3.7.3 5-3* Digital Outputs</i> for further description.
[22]	Comparator 0	Use the result of comparator 0 in the logic rule.
[23]	Comparator 1	Use the result of comparator 1 in the logic rule.
[24]	Comparator 2	Use the result of comparator 2 in the logic rule.
[25]	Comparator 3	Use the result of comparator 3 in the logic rule.
[26]	Logic rule 0	Use the result of logic rule 0 in the logic rule.
[27]	Logic rule 1	Use the result of logic rule 1 in the logic rule.
[28]	Logic rule 2	Use the result of logic rule 2 in the logic rule.
[29]	Logic rule 3	Use the result of logic rule 3 in the logic rule.
[30]	SL Time-out 0	Use the result of timer 0 in the logic rule.

13-40 Logic Rule Boolean 1		
Array [6]		
Option:	Function:	
[31]	SL Time-out 1	Use the result of timer 1 in the logic rule.
[32]	SL Time-out 2	Use the result of timer 2 in the logic rule.
[33]	Digital input DI18	Use the value of DI18 in the logic rule (High=TRUE).
[34]	Digital input DI19	Use the value of DI19 in the logic rule (High=TRUE).
[35]	Digital input DI27	Use the value of DI27 in the logic rule (High=TRUE).
[36]	Digital input DI29	Use the value of DI29 in the logic rule (High=TRUE).
[37]	Digital input DI32	Use the value of DI32 in the logic rule (High=TRUE).
[38]	Digital input DI33	Use the value of DI33 in the logic rule (High=TRUE).
[39]	Start command	This logic rule is TRUE if the frequency converter is started either via digital input, fieldbus, or other.
[40]	Drive stopped	This logic rule is TRUE if the frequency converter is stopped or coasted either via digital input, fieldbus, or other.
[41]	Reset Trip	This logic rule is TRUE if the frequency converter is tripped (but not trip-locked) and [Reset] is pressed.
[42]	Auto Reset Trip	This logic rule is TRUE if the frequency converter is tripped (but not trip-locked) and an automatic reset is issued.
[43]	OK Key	This logic rule is TRUE if [OK] is pressed.
[44]	Reset Key	This logic rule is TRUE if [Reset] is pressed.
[45]	Left Key	This logic rule is TRUE if [◀] is pressed.
[46]	Right Key	This logic rule is TRUE if [▶] is pressed.
[47]	Up Key	This logic rule is TRUE if [▲] is pressed.
[48]	Down Key	This logic rule is TRUE if [▼] is pressed.
[50]	Comparator 4	Use the result of comparator 4 in the logic rule.
[51]	Comparator 5	Use the result of comparator 5 in the logic rule.
[60]	Logic rule 4	Use the result of logic rule 4 in the logic rule.
[61]	Logic rule 5	Use the result of logic rule 5 in the logic rule.

13-40 Logic Rule Boolean 1		
Array [6]		
Option:	Function:	
[70]	SL Time-out 3	Use the result of timer 3 in the logic rule.
[71]	SL Time-out 4	Use the result of timer 4 in the logic rule.
[72]	SL Time-out 5	Use the result of timer 5 in the logic rule.
[73]	SL Time-out 6	Use the result of timer 6 in the logic rule.
[74]	SL Time-out 7	Use the result of timer 7 in the logic rule.
[76]	Digital Input x30 2	
[77]	Digital Input x30 3	
[78]	Digital Input x30 4	
[80]	No Flow	
[81]	Dry Pump	
[82]	End of Curve	
[83]	Broken Belt	
[90]	ECB Drive Mode	
[91]	ECB Bypass Mode	
[92]	ECB Test Mode	
[100]	Fire Mode	See 13-15 RS-FF Operand S, 13-16 RS-FF Operand R.

13-41 Logic Rule Operator 1		
Array [6]		
Option:	Function:	
	Select the first logical operator to use on the boolean inputs from <i>parameter 13-40 Logic Rule Boolean 1</i> and <i>parameter 13-42 Logic Rule Boolean 2</i> . Parameter numbers in square brackets stand for the boolean inputs of parameters in group 13-** <i>Smart Logic Control</i> .	
[0]	DISABLED	Ignores <ul style="list-style-type: none"> Parameter 13-42 Logic Rule Boolean 2. Parameter 13-43 Logic Rule Operator 2. Parameter 13-44 Logic Rule Boolean 3.
[1]	AND	Evaluates the expression [13-40] AND [13-42].
[2]	OR	Evaluates the expression [13-40] OR [13-42].
[3]	AND NOT	Evaluates the expression [13-40] AND NOT [13-42].
[4]	OR NOT	Evaluates the expression [13-40] OR NOT [13-42].

13-41 Logic Rule Operator 1		
Array [6]		
Option:	Function:	
[5]	NOT AND	Evaluates the expression NOT [13-40] AND [13-42].
[6]	NOT OR	Evaluates the expression NOT [13-40] OR [13-42].
[7]	NOT AND NOT	Evaluates the expression NOT [13-40] AND NOT [13-42].
[8]	NOT OR NOT	Evaluates the expression NOT [13-40] OR NOT [13-42].

13-42 Logic Rule Boolean 2		
Array [6]		
Option:	Function:	
	Select the second boolean (TRUE or FALSE) input for the selected logic rule. See <i>parameter 13-40 Logic Rule Boolean 1</i> for further descriptions of options and their functions.	
[0]	False	
[1]	True	
[2]	Running	
[3]	In range	
[4]	On reference	
[5]	Torque limit	
[6]	Current Limit	
[7]	Out of current range	
[8]	Below I low	
[9]	Above I high	
[10]	Out of speed range	
[11]	Below speed low	
[12]	Above speed high	
[13]	Out of feedb. range	
[14]	Below feedb. low	
[15]	Above feedb. high	
[16]	Thermal warning	
[17]	Mains out of range	
[18]	Reversing	
[19]	Warning	
[20]	Alarm (trip)	
[21]	Alarm (trip lock)	
[22]	Comparator 0	
[23]	Comparator 1	
[24]	Comparator 2	
[25]	Comparator 3	
[26]	Logic rule 0	
[27]	Logic rule 1	
[28]	Logic rule 2	
[29]	Logic rule 3	
[30]	SL Time-out 0	

13-42 Logic Rule Boolean 2		
Array [6]		
Option:	Function:	
[31]	SL Time-out 1	
[32]	SL Time-out 2	
[33]	Digital input DI18	
[34]	Digital input DI19	
[35]	Digital input DI27	
[36]	Digital input DI29	
[37]	Digital input DI32	
[38]	Digital input DI33	
[39]	Start command	
[40]	Drive stopped	
[41]	Reset Trip	
[42]	Auto Reset Trip	
[43]	OK Key	
[44]	Reset Key	
[45]	Left Key	
[46]	Right Key	
[47]	Up Key	
[48]	Down Key	
[50]	Comparator 4	
[51]	Comparator 5	
[60]	Logic rule 4	
[61]	Logic rule 5	
[70]	SL Time-out 3	
[71]	SL Time-out 4	
[72]	SL Time-out 5	
[73]	SL Time-out 6	
[74]	SL Time-out 7	
[76]	Digital Input x30 2	
[77]	Digital Input x30 3	
[78]	Digital Input x30 4	
[80]	No Flow	
[81]	Dry Pump	
[82]	End of Curve	
[83]	Broken Belt	
[90]	ECB Drive Mode	
[91]	ECB Bypass Mode	
[92]	ECB Test Mode	
[100]	Fire Mode	See 13-15 RS-FF Operand S, 13-16 RS-FF Operand R.

13-43 Logic Rule Operator 2		
Array [6]		
Option:	Function:	
	Select the second logical operator to be used on the boolean input calculated in	
	<ul style="list-style-type: none"> Parameter 13-40 Logic Rule Boolean 1 Parameter 13-41 Logic Rule Operator 1 Parameter 13-42 Logic Rule Boolean 2 	

13-43 Logic Rule Operator 2		
Array [6]		
Option:	Function:	
	and the boolean input coming from parameter 13-42 Logic Rule Boolean 2. [13-44] signifies the boolean input of parameter 13-44 Logic Rule Boolean 3. [13-40/13-42] signifies the boolean input calculated in	
	<ul style="list-style-type: none"> Parameter 13-40 Logic Rule Boolean 1 Parameter 13-41 Logic Rule Operator 1 Parameter 13-42 Logic Rule Boolean 2 	
[0]	DISABLED	Select this option to ignore parameter 13-44 Logic Rule Boolean 3
[1]	AND	
[2]	OR	
[3]	AND NOT	
[4]	OR NOT	
[5]	NOT AND	
[6]	NOT OR	
[7]	NOT AND NOT	
[8]	NOT OR NOT	

13-44 Logic Rule Boolean 3		
Array [6]		
Option:	Function:	
	Select the third boolean (TRUE or FALSE) input for the selected logic rule.	
	See parameter 13-40 Logic Rule Boolean 1 for further descriptions of options and their functions.	
[0]	False	
[1]	True	
[2]	Running	
[3]	In range	
[4]	On reference	
[5]	Torque limit	
[6]	Current Limit	
[7]	Out of current range	
[8]	Below I low	
[9]	Above I high	
[10]	Out of speed range	
[11]	Below speed low	
[12]	Above speed high	
[13]	Out of feedb. range	
[14]	Below feedb. low	
[15]	Above feedb. high	
[16]	Thermal warning	
[17]	Mains out of range	
[18]	Reversing	

13-44 Logic Rule Boolean 3		
Array [6]		
Option:	Function:	
[19]	Warning	
[20]	Alarm (trip)	
[21]	Alarm (trip lock)	
[22]	Comparator 0	
[23]	Comparator 1	
[24]	Comparator 2	
[25]	Comparator 3	
[26]	Logic rule 0	
[27]	Logic rule 1	
[28]	Logic rule 2	
[29]	Logic rule 3	
[30]	SL Time-out 0	
[31]	SL Time-out 1	
[32]	SL Time-out 2	
[33]	Digital input DI18	
[34]	Digital input DI19	
[35]	Digital input DI27	
[36]	Digital input DI29	
[37]	Digital input DI32	
[38]	Digital input DI33	
[39]	Start command	
[40]	Drive stopped	
[41]	Reset Trip	
[42]	Auto Reset Trip	
[43]	OK Key	
[44]	Reset Key	
[45]	Left Key	
[46]	Right Key	
[47]	Up Key	
[48]	Down Key	
[50]	Comparator 4	
[51]	Comparator 5	
[60]	Logic rule 4	
[61]	Logic rule 5	
[70]	SL Time-out 3	
[71]	SL Time-out 4	
[72]	SL Time-out 5	
[73]	SL Time-out 6	
[74]	SL Time-out 7	
[76]	Digital Input x30 2	
[77]	Digital Input x30 3	
[78]	Digital Input x30 4	
[80]	No Flow	
[81]	Dry Pump	
[82]	End of Curve	
[83]	Broken Belt	
[90]	ECB Drive Mode	
[91]	ECB Bypass Mode	
[92]	ECB Test Mode	
[100]	Fire Mode	See 13-15 RS-FF Operand S, 13-16 RS-FF Operand R.

3.13.6 13-5* States

13-51 SL Controller Event		
Array [20]		
Option:	Function:	
		Select the boolean input (TRUE or FALSE) to define the smart logic controller event. See <i>parameter 13-02 Stop Event</i> for further descriptions of options and their functions.
[0]	False	
[1]	True	
[2]	Running	
[3]	In range	
[4]	On reference	
[5]	Torque limit	
[6]	Current Limit	
[7]	Out of current range	
[8]	Below I low	
[9]	Above I high	
[10]	Out of speed range	
[11]	Below speed low	
[12]	Above speed high	
[13]	Out of feedb. range	
[14]	Below feedb. low	
[15]	Above feedb. high	
[16]	Thermal warning	
[17]	Mains out of range	
[18]	Reversing	
[19]	Warning	
[20]	Alarm (trip)	
[21]	Alarm (trip lock)	
[22]	Comparator 0	
[23]	Comparator 1	
[24]	Comparator 2	
[25]	Comparator 3	
[26]	Logic rule 0	
[27]	Logic rule 1	
[28]	Logic rule 2	
[29]	Logic rule 3	
[30]	SL Time-out 0	
[31]	SL Time-out 1	
[32]	SL Time-out 2	
[33]	Digital input DI18	
[34]	Digital input DI19	
[35]	Digital input DI27	
[36]	Digital input DI29	
[37]	Digital input DI32	
[38]	Digital input DI33	
[39]	Start command	
[40]	Drive stopped	
[41]	Reset Trip	

13-51 SL Controller Event		
Array [20]		
Option:	Function:	
[42]	Auto Reset Trip	
[43]	OK Key	
[44]	Reset Key	
[45]	Left Key	
[46]	Right Key	
[47]	Up Key	
[48]	Down Key	
[50]	Comparator 4	
[51]	Comparator 5	
[60]	Logic rule 4	
[61]	Logic rule 5	
[70]	SL Time-out 3	
[71]	SL Time-out 4	
[72]	SL Time-out 5	
[73]	SL Time-out 6	
[74]	SL Time-out 7	
[76]	Digital Input x30 2	
[77]	Digital Input x30 3	
[78]	Digital Input x30 4	
[80]	No Flow	
[81]	Dry Pump	
[82]	End of Curve	
[83]	Broken Belt	
[90]	ECB Drive Mode	
[91]	ECB Bypass Mode	
[92]	ECB Test Mode	
[100]	Fire Mode	See 13-15 RS-FF Operand S, 13-16 RS-FF Operand R.

13-52 SL Controller Action		
Array [20]		
Option:	Function:	
		Select the action corresponding to the SLC event. Actions are executed when the corresponding event (defined in <i>parameter 13-51 SL Controller Event</i>) is evaluated as true. The following actions are available for selection:
[0]	Disabled	
[1]	No action	
[2]	Select set-up 1	Changes the active set-up (<i>parameter 0-10 Active Set-up</i>) to 1.
[3]	Select set-up 2	Changes the active set-up (<i>parameter 0-10 Active Set-up</i>) to 2.
[4]	Select set-up 3	Changes the active set-up (<i>parameter 0-10 Active Set-up</i>) to 3.
[5]	Select set-up 4	Changes the active set-up (<i>parameter 0-10 Active Set-up</i>) to 4. If the set-up is changed, it merges with other

13-52 SL Controller Action		
Array [20]		
Option:	Function:	
		set-up commands coming from either the digital inputs or via a fieldbus.
[10]	Select preset ref 0	Selects preset reference 0.
[11]	Select preset ref 1	Selects preset reference 1.
[12]	Select preset ref 2	Selects preset reference 2.
[13]	Select preset ref 3	Selects preset reference 3.
[14]	Select preset ref 4	Selects preset reference 4.
[15]	Select preset ref 5	Selects preset reference 5.
[16]	Select preset ref 6	Selects preset reference 6.
[17]	Select preset ref 7	Selects preset reference 7. If the active preset reference is changed, it merges with other preset reference commands coming from either the digital inputs or via a fieldbus.
[18]	Select ramp 1	Selects ramp 1.
[19]	Select ramp 2	Selects ramp 2.
[22]	Run	Issues a start command to the frequency converter.
[23]	Run reverse	Issues a start reverse command to the frequency converter.
[24]	Stop	Issues a stop command to the frequency converter.
[26]	DC Brake	Issues a DC stop command to the frequency converter.
[27]	Coast	The frequency converter coasts immediately. All stop commands including the coast command stop the SLC.
[28]	Freeze output	Freezes the output frequency of the frequency converter.
[29]	Start timer 0	Starts timer 0, see <i>parameter 13-20 SL Controller Timer</i> for further description.
[30]	Start timer 1	Starts timer 1, see <i>parameter 13-20 SL Controller Timer</i> for further description.
[31]	Start timer 2	Starts timer 2, see <i>parameter 13-20 SL Controller Timer</i> for further description.
[32]	Set digital out A low	Any output with digital output 1 selected is low (off).
[33]	Set digital out B low	Any output with digital output 2 selected is low (off).

13-52 SL Controller Action		
Array [20]		
Option:		Function:
[34]	Set digital out C low	Any output with digital output 3 selected is low (off).
[35]	Set digital out D low	Any output with digital output 4 selected is low (off).
[36]	Set digital out E low	Any output with digital output 5 selected is low (off).
[37]	Set digital out F low	Any output with digital output 6 selected is low (off).
[38]	Set digital out A high	Any output with digital output 1 selected is high (closed).
[39]	Set digital out B high	Any output with digital output 2 selected is high (closed).
[40]	Set digital out C high	Any output with digital output 3 selected is high (closed).
[41]	Set digital out D high	Any output with digital output 4 selected is high (closed).
[42]	Set digital out E high	Any output with digital output 5 selected is high (closed).
[43]	Set digital out F high	Any output with digital output 6 selected is high (closed).
[60]	Reset Counter A	Resets counter A to zero.
[61]	Reset Counter B	Resets counter B to zero.
[62]	Counter A (up)	
[63]	Counter A (down)	
[64]	Counter B (up)	
[65]	Counter B (down)	
[70]	Start Timer 3	Starts timer 3, see <i>parameter 13-20 SL Controller Timer</i> for further description.
[71]	Start Timer 4	Starts timer 4, see <i>parameter 13-20 SL Controller Timer</i> for further description.
[72]	Start Timer 5	Starts timer 5, see <i>parameter 13-20 SL Controller Timer</i> for further description.
[73]	Start Timer 6	Starts timer 6, see <i>parameter 13-20 SL Controller Timer</i> for further description.
[74]	Start Timer 7	Starts timer 7, see <i>parameter 13-20 SL Controller Timer</i> for further description.
[80]	Sleep Mode	Starts the sleep mode.
[90]	Set ECB Bypass Mode	
[91]	Set ECB Drive Mode	
[100]	Reset Alarms	

3.14 Parameters: 14-** Main Menu - Special Functions

3.14.1 14-0* Inverter Switching

14-00 Switching Pattern		
Option:	Function:	
	Select the switching pattern: 60° AVM or SFAVM.	
[0]	60 AVM	
[1]	SFAVM	

14-01 Switching Frequency		
Option:	Function:	
	Select the inverter switching frequency. Changing the switching frequency can help reduce acoustic noise from the motor.	
	<p>NOTICE</p> <p>The output frequency value of the frequency converter must never exceed 1/10 of the switching frequency. When the motor is running, adjust the switching frequency in <i>parameter 14-01 Switching Frequency</i> until the motor is as noiseless as possible. See also <i>parameter 14-00 Switching Pattern</i>. For information about derating, see the relevant design guide.</p>	
[0]	1.0 kHz	
[1]	1.5 kHz	
[2]	2.0 kHz	
[3]	2.5 kHz	
[4]	3.0 kHz	
[5]	3.5 kHz	
[6]	4.0 kHz	
[7]	5.0 kHz	
[8]	6.0 kHz	
[9]	7.0 kHz	
[10]	8.0 kHz	
[11]	10.0 kHz	
[12]	12.0kHz	
[13]	14.0 kHz	
[14]	16.0kHz	

14-03 Overmodulation		
Option:	Function:	
[0] *	Off	Selects no overmodulation of the output voltage to avoid torque ripple on the motor shaft.
[1]	On	The overmodulation function generates an extra voltage of up to 8% of U_{max} output voltage without overmodulation. This extra voltage results in an extra torque of 10-12% in the middle of the oversynchronous range (from 0% at nominal speed rising to approximately 12% at double nominal speed).

14-04 PWM Random		
Option:	Function:	
[0] *	Off	No change of the acoustic motor switching noise.
[1]	On	Transforms the acoustic motor switching noise from a clear ringing tone to a less noticeable white noise. This is achieved by slightly and randomly altering the synchronism of the pulse width modulated output phases.

3.14.2 14-1* Mains On/Off

Parameters for configuring mains failure monitoring and handling.

14-10 Mains Failure		
Option:	Function:	
	Select the function at which the frequency converter must act, when the threshold set in <i>parameter 14-11 Mains Voltage at Mains Fault</i> has been reached or a <i>Mains Failure Inverse</i> command is activated via one of the digital inputs (parameter group 5-1* Digital Inputs). Only selection [0] No function, [3] Coasting or [6] Alarm is available when <i>parameter 1-10 Motor Construction</i> is set to [1] PM non-salient SPM	
[0]	No function	The energy left in the capacitor bank is used to drive the motor, but is discharged.
[1]	Ctrl. ramp-down	The frequency converter performs a controlled ramp down. <i>Parameter 2-10 Brake Function</i> must be set to [0] Off.
[3]	Coasting	The inverter turns off and the capacitor bank backs up the control card. Backing up control card ensures a faster restart when mains reconnected (at short power zags).
[4]	Kinetic back-up	The frequency converter rides through by controlling speed for generative operation of the motor utilising the moment of inertia of the system as long as sufficient energy is present.
[6]	Alarm	

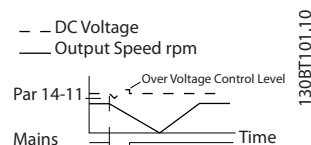

Illustration 3.37 Controlled Ramp Down - Short Mains Failure.

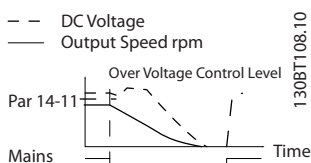

Illustration 3.38 Controlled Ramp Down, Longer Mains Failure.

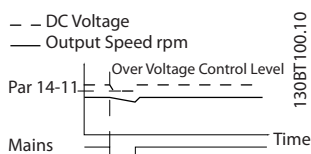

Illustration 3.39 Kinetic Back-up, Short Mains Failure.

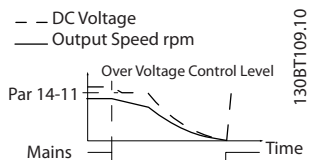

Illustration 3.40 Kinetic Back-Up, Longer Mains Failure.

14-11 Mains Voltage at Mains Fault		
Range:	Function:	
Size related*	[180 - 600 V]	This parameter defines the threshold voltage at which the selected function in <i>parameter 14-10 Mains Failure</i> should be activated. The detection level is at a factor $\sqrt{2}$ of the value in this parameter.

14-12 Function at Mains Imbalance		
Option:	Function:	
		Operation under severe mains imbalance conditions reduces the lifetime of the motor. Conditions are considered severe if the motor is operated continuously near nominal load (for example a pump or fan running near full speed). When a severe mains imbalance is detected, select 1 of the available functions.
[0] *	Trip	Trips the frequency converter.
[1]	Warning	Issues a warning.
[2]	Disabled	No action.
[3]	Derate	Derates the frequency converter.

3.14.3 14-2* Trip Reset

Parameters for configuring auto reset handling, special trip handling, and control card self-test or initialisation.

14-20 Reset Mode		
Option:	Function:	
		NOTICE Automatic reset is also active for resetting the Safe Torque Off function.
		NOTICE The setting in <i>parameter 14-20 Reset Mode</i> is disregarded if Fire Mode being active (see parameter group 24-0* Fire Mode). Select the reset function after tripping. Once reset, the frequency converter can be restarted.
[0]	Manual reset	Select [0] <i>Manual reset</i> , to perform a reset via [RESET] or via the digital inputs.
[1]	Automatic reset x 1	Select [1]-[12] <i>Automatic reset x 1...x20</i> to perform between 1 and 20 automatic resets after tripping.
[2]	Automatic reset x 2	
[3]	Automatic reset x 3	
[4]	Automatic reset x 4	
[5]	Automatic reset x 5	
[6]	Automatic reset x 6	
[7]	Automatic reset x 7	
[8]	Automatic reset x 8	
[9]	Automatic reset x 9	
[10]	Automatic reset x 10	
[11]	Automatic reset x 15	
[12]	Automatic reset x 20	
[13]	Infinite auto reset	Select [13] <i>Infinite Automatic Reset</i> for continuous resetting after tripping.

14-21 Automatic Restart Time		
Range:	Function:	
10 s*	[0 - 600 s]	Enter the time interval from trip to start of the automatic reset function. This parameter is active when <i>parameter 14-20 Reset Mode</i> is set to [1]-[13] <i>Automatic reset</i> .

3

14-22 Operation Mode		
Option:	Function:	
		<p>Use this parameter to specify normal operation, to perform tests, or to initialise all parameters except</p> <ul style="list-style-type: none"> Parameter 15-03 Power Up's. Parameter 15-04 Over Temp's. Parameter 15-05 Over Volt's. <p>This function is active only when the power is cycled (power off/power on) to the frequency converter.</p>
[0] *	Normal operation	Normal operation of the frequency converter with the motor in the selected application.
[1]	Control card test	<p>Tests the analog and digital inputs and outputs and the +10 V control voltage. The test requires a test connector with internal connections.</p> <p>Use the following procedure for the control card test:</p> <ol style="list-style-type: none"> Select [1] Control card test. Disconnect the mains supply and wait for the light in the display to go out. Set switches S201 (A53) and S202 (A54)=ON/I. Insert the test plug (see <i>Illustration 3.41</i>). Connect to mains supply. Carry out various tests. The results are shown in the display and the frequency converter moves into an infinite loop. Parameter 14-22 Operation Mode is automatically set to [0] Normal operation. Carry out a power cycle to start up in normal operation after a control card test. <p>If the test is OK LCP readout: Control Card OK. Disconnect the mains supply and remove the test plug. The green LED on the control card lights up.</p> <p>If the test fails LCP readout: Control Card I/O failure. Replace the frequency converter or control card. The red LED on the control card is turned on. To test the plugs, connect/group the following terminals as shown in <i>Illustration 3.41</i>:</p> <ul style="list-style-type: none"> (18 - 27 - 32) (19 - 29 - 33) (42 - 53 - 54)

14-22 Operation Mode		
Option:	Function:	
		<p>Illustration 3.41 Wiring Control Card Test</p>
[2]	Initialisation	<p>Resets all parameter values to default settings, except for</p> <ul style="list-style-type: none"> Parameter 15-03 Power Up's. Parameter 15-04 Over Temp's. Parameter 15-05 Over Volt's. <p>The frequency converter resets during the next power-up. Parameter 14-22 Operation Mode also reverts to the default setting [0] Normal operation.</p>
[3]	Boot mode	
[4]	Initialize all parameters	Select this option to reset all parameters (including bus and motor parameters) to default values.

14-25 Trip Delay at Torque Limit		
Range:	Function:	
60 s* [0 - 60 s]		Enter the torque limit trip delay in seconds. When the output torque reaches the torque limits (parameter 4-16 Torque Limit Motor Mode and parameter 4-17 Torque Limit Generator Mode), a warning is triggered. When the torque limit warning has been continuously present for the period specified in this parameter, the frequency converter trips. Disable the trip delay by setting the parameter to 60 s=OFF. Thermal frequency converter monitoring remains active.

14-26 Trip Delay at Inverter Fault		
Range:	Function:	
Size related*	[0 - 35 s]	When the frequency converter detects an overvoltage in the set time, trip is effected after the set time.

14-29 Service Code		
Range:	Function:	
0*	[-2147483647 - 2147483647]	Service use only.

3.14.4 14-3* Current Limit Control

The frequency converter features an integral current limit controller which is activated when the motor current, and thus the torque, is higher than the torque limits set in *parameter 4-16 Torque Limit Motor Mode* and *parameter 4-17 Torque Limit Generator Mode*.

When the current limit is reached during motor operation or regenerative operation, the frequency converter tries to reduce torque below the preset torque limits as quickly as possible without losing control of the motor.

While the current control is active, the frequency converter can only be stopped by setting a digital input to [2] *Coast inverse* or [3] *Coast and reset inv.* Any signal on terminals 18 to 33 are not active until the frequency converter is no longer near the current limit.

By using a digital input set to [2] *Coast inverse* or [3] *Coast and reset inv.*, the motor does not use the ramp down time, since the frequency converter is coasted.

14-30 Current Lim Ctrl, Proportional Gain		
Range:		Function:
100 %*	[0 - 500 %]	Enter the proportional gain value for the current limit controller. Selection of a high value makes the controller react faster. Too high a setting leads to controller instability.

14-31 Current Lim Ctrl, Integration Time		
Range:		Function:
Size related*	[0.002 - 2 s]	Controls the current limit control integration time. Setting it to a lower value makes it react faster. A setting too low leads to control instability.

14-32 Current Lim Ctrl, Filter Time		
Range:		Function:
Size related*	[1 - 100 ms]	Sets a time constant for the current limit controller low-pass filter.

3.14.5 14-4* Energy Optimising

Parameters for adjusting the energy optimisation level in both variable torque (VT) and automatic energy optimisation (AEO) mode.

Automatic Energy Optimization is only active if *parameter 1-03 Torque Characteristics*, is set for either [2] *Auto Energy Optim. Compressor* or [3] *Auto Energy Optim. VT*.

14-40 VT Level		
Range:		Function:
66 %*	[40 - 90 %]	<p>NOTICE</p> <p>This parameter cannot be adjusted while the motor is running.</p> <p>NOTICE</p> <p>This parameter is not active when <i>parameter 1-10 Motor Construction</i> is set to [1] <i>PM non-salient SPM</i>.</p> <p>Enter the level of motor magnetisation at low speed. Selection of a low value reduces energy loss in the motor, but also reduces load capability.</p>

14-41 AEO Minimum Magnetisation		
Range:		Function:
Size related*	[40 - 200 %]	<p>NOTICE</p> <p>This parameter is not active when <i>parameter 1-10 Motor Construction</i> is set to [1] <i>PM non-salient SPM</i>.</p> <p>Enter the minimum allowable magnetisation for AEO. Selection of a low value reduces energy loss in the motor, but can also reduce resistance to sudden load changes.</p>

14-42 Minimum AEO Frequency		
Range:		Function:
Size related*	[5 - 40 Hz]	<p>NOTICE</p> <p>This parameter is not active when <i>parameter 1-10 Motor Construction</i> is set to [1] <i>PM non-salient SPM</i>.</p> <p>Enter the minimum frequency at which the automatic energy optimisation (AEO) is to be active.</p>

14-43 Motor Cosphi		
Range:		Function:
Size related*	[0.40 - 0.95]	The Cos(phi) setpoint is automatically set for optimum AEO performance during AMA. This parameter should normally not be altered. However, in some situations it may be necessary to enter a new value to fine-tune.

3.14.6 14-5* Environment

These parameters help the frequency converter to operate under special environmental conditions.

14-50 RFI Filter		
Option:	Function:	
[0]	Off	Select [0] Off if the frequency converter is fed by an isolated mains source (IT mains). If a filter is used, select [0] Off during charging to prevent a high leakage current making the RCD switch. In this mode, the internal RFI filter capacitors between chassis and the mains RFI filter circuit are cut-out to reduce the ground capacity currents.
[1] *	On	Select [1] On to ensure that the frequency converter complies with EMC standards.

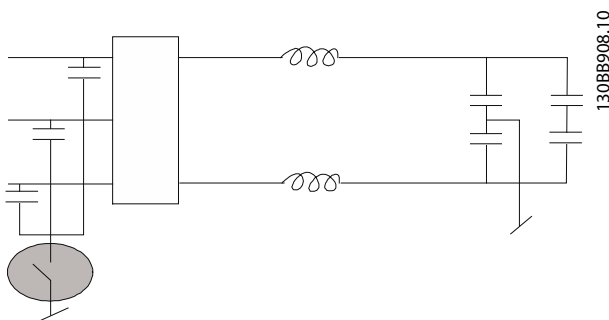

Illustration 3.42 RFI Filter

14-51 DC Link Compensation		
Option:	Function:	
		The rectified AC-DC voltage in the frequency converter's DC link is associated with voltage ripples. These ripples can increase in magnitude with increased load. These ripples are undesirable because they can generate current and torque ripples. A compensation method is used to reduce these voltage ripples in the DC link. In general, DC Link Compensation is recommended for most applications, but pay attention when operating in field weakening as it can generate speed oscillations at the motor shaft. In field weakening, it is recommended to turn off DC-link compensation.
[0]	Off	Disables DC-link compensation.
[1]	On	Enables DC-link compensation.

14-52 Fan Control		
Option:	Function:	
		Select the minimum speed of the main fan.
[0] *	Auto	Select [0] Auto to run the fan only when the internal temperature of the frequency converter is in the range +35 °C to approximately +55 °C. The fan runs at low speed at +35 °C and at full speed at approximately +55 °C.
[1]	On 50%	
[2]	On 75%	
[3]	On 100%	

14-52 Fan Control		
Option:	Function:	
[4]	Auto (Low temp env.)	

14-53 Fan Monitor		
Option:	Function:	
		Select the frequency converter action if a fan fault is detected.
[0]	Disabled	
[1] *	Warning	
[2]	Trip	

14-55 Output Filter		
Option:	Function:	
[0] *	No Filter	
[2]	Sine Wave Filter Fixed	

14-59 Actual Number of Inverter Units		
This parameter is only relevant for high power frequency converters.		
Range:	Function:	
Size related*	[1 - 1]	Sets the actual number of operating inverter units.

3.14.7 14-6* Auto Derate

This group contains parameters for derating the frequency converter in case of high temperature.

14-60 Function at Over Temperature		
Option:	Function:	
		If either heatsink or control card temperature exceeds a factory-programmed temperature limit, a warning is activated. If the temperature increases further, select whether the frequency converter should trip (trip lock) or derate the output current.
[0] *	Trip	The frequency converter trips (trip lock) and generate an alarm. Cycle Power to reset the alarm. The motor restarts when the heat sink temperature has dropped below the alarm limit.
[1]	Derate	If the critical temperature is exceeded, the output current is reduced until the allowable temperature has been reached.

3.14.8 No Trip at Inverter Overload

In some pump systems, the frequency converter has not been sized properly to yield the current needed in all points of the operational flow-head characteristic. At these points, the pump needs a current higher than the rated current of the frequency converter. The frequency converter can yield 110% of the rated current continuously

for 60 s. If still overloaded, the frequency converter normally trips (causing the pump to stop by coasting) and issues an alarm.

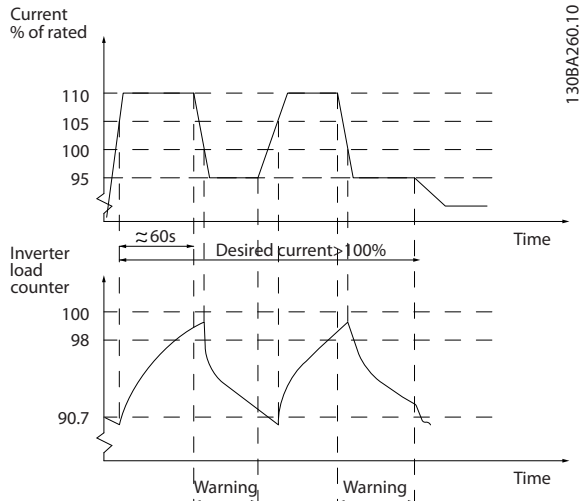

Illustration 3.43 Output Current in Overload Condition

If the pump is unable to run continuously with the demanded capacity, run it at reduced speed for a while.

Select *parameter 14-61 Function at Inverter Overload* to automatically reduce pump speed until the output current is below 100% of the rated current (set in *parameter 14-62 Inv. Overload Derate Current*). *Parameter 14-61 Function at Inverter Overload* is an alternative to letting the frequency converter trip.

The frequency converter estimates the load on the power section with an inverter load counter, which causes a warning at 98% and a reset of the warning at 90%. At the value 100%, the frequency converter trips and issue an alarm.

Status for the counter can be read in *parameter 16-35 Inverter Thermal*.

If *parameter 14-61 Function at Inverter Overload* is set to [3] *Derate*, the pump speed is reduced when the counter exceeds 98%, and stays reduced until the counter has dropped below 90.7%.

If *parameter 14-62 Inv. Overload Derate Current* is set to for example 95%, a steady overload causes the pump speed to fluctuate between values corresponding to 110% and 95% of rated output current for the frequency converter.

14-61 Function at Inverter Overload	
Option:	Function:
	Is used in case of steady overload beyond the thermal limits (110% for 60 s).
[0] *	Trip Select [0] Trip to make the frequency converter trip and issue an alarm.
[1]	Derate [1] Derate to reduce pump speed to decrease the load on the power section and allowing this to cool down.

14-62 Inv. Overload Derate Current	
Range:	Function:
95 %* [50 - 100 %]	Defines the desired current level (in % of rated output current for the frequency converter) when running with reduced pump speed after load on the frequency converter has exceeded the allowable limit (110% for 60 s).

14-90 Fault Level	
Use this parameter to customise fault levels.	
Option:	Function:
[0]	Off Use [0] Off with caution as it ignores all warnings and alarms for the selected source.
[1]	Warning
[2]	Trip Changing a fault level from default option [3] Trip Lock to [2] Trip leads to the automatic reset of the alarm. For alarms involving overcurrent, the frequency converter has a hardware protection that issues a 3-minute recovery after 2 consecutive overcurrent incidents, this hardware protection cannot be overruled.
[3]	Trip Lock
[4]	Trip w. delayed reset

Failure	Alarm	Off	Warning	Trip	Trip Lock
Inverter overloaded	9		X	X	
Overcurrent	13			X	D
Current limit	59		X		

Table 3.18 Selection of Choice of Action when Selected Alarm Appears

3.15 Parameters: 15-** Main Menu - Drive Information

Parameter group containing frequency converter information such as operating data, hardware configuration, and software versions.

3.15.1 15-0* Operating Data

15-00 Operating hours		
Range:	Function:	
0 h* [0 - 2147483647 h]	View how many hours the frequency converter has run. The value is saved when the frequency converter is turned off.	

15-01 Running Hours		
Range:	Function:	
0 h* [0 - 2147483647 h]	View how many hours the motor has run. Reset the counter in <i>parameter 15-07 Reset Running Hours Counter</i> . The value is saved when the frequency converter is turned off.	

15-02 kWh Counter		
Range:	Function:	
0 kWh* [0 - 2147483647 kWh]	Registers the power consumption of the motor as a mean value over 1 hour. Reset the counter in <i>parameter 15-06 Reset kWh Counter</i> .	

15-03 Power Up's		
Range:	Function:	
0* [0 - 2147483647]	View the number of times the frequency converter has been powered up.	

15-04 Over Temp's		
Range:	Function:	
0* [0 - 65535]	View the number of frequency converter temperature faults, which have occurred.	

15-05 Over Volt's		
Range:	Function:	
0* [0 - 65535]	View the number of frequency converter overvoltages, which have occurred.	

15-06 Reset kWh Counter		
Option:	Function:	
[0] * Do not reset	NOTICE The reset is carried out by pressing [OK]. No reset of the kWh counter is desired.	

15-06 Reset kWh Counter		
Option:	Function:	
[1]	Reset counter	Press [OK] to reset the kWh counter to zero (see <i>parameter 15-02 kWh Counter</i>).

15-07 Reset Running Hours Counter		
Option:	Function:	
[0] *	Do not reset	No reset of the running hours counter is desired.
[1]	Reset counter	Select [1] <i>Reset counter</i> and press [OK] to reset the running hours counter (<i>parameter 15-01 Running Hours</i>) and <i>parameter 15-08 Number of Starts</i> to zero (see also <i>parameter 15-01 Running Hours</i>).

15-08 Number of Starts		
Range:	Function:	
0* [0 - 2147483647]	This is a readout parameter only. The counter shows the number of starts and stops caused by a normal Start/Stop command and/or when entering/leaving sleep mode.	

3.15.2 15-1* Data Log Settings

The data log enables continuous logging of up to 4 data sources (*parameter 15-10 Logging Source*) at individual rates (*parameter 15-11 Logging Interval*). A trigger event (*parameter 15-12 Trigger Event*) and window (*parameter 15-14 Samples Before Trigger*) are used to start and stop the logging conditionally.

15-10 Logging Source		
Array [4]		
Option:	Function:	
[0] *	None	Select which variables are to be logged.
[1397]	Alert Alarm Word	
[1398]	Alert Warning Word	
[1399]	Alert Status Word	
[1600]	Control Word	
[1601]	Reference [Unit]	
[1602]	Reference [%]	
[1603]	Status Word	
[1610]	Power [kW]	
[1611]	Power [hp]	
[1612]	Motor Voltage	
[1613]	Frequency	
[1614]	Motor current	
[1616]	Torque [Nm]	
[1617]	Speed [RPM]	
[1618]	Motor Thermal	
[1622]	Torque [%]	

15-10 Logging Source		
Array [4]		
Option:	Function:	
[1624]	Calibrated Stator Resistance	
[1626]	Power Filtered [kW]	
[1627]	Power Filtered [hp]	
[1630]	DC Link Voltage	
[1632]	Brake Energy /s	
[1633]	Brake Energy Average	
[1634]	Heatsink Temp.	
[1635]	Inverter Thermal	
[1650]	External Reference	
[1652]	Feedback[Unit]	
[1654]	Feedback 1 [Unit]	
[1655]	Feedback 2 [Unit]	
[1656]	Feedback 3 [Unit]	
[1660]	Digital Input	
[1662]	Analog Input 53	
[1664]	Analog Input 54	
[1665]	Analog Output 42 [mA]	
[1666]	Digital Output [bin]	
[1675]	Analog In X30/11	
[1676]	Analog In X30/12	
[1677]	Analog Out X30/8 [mA]	
[1690]	Alarm Word	
[1691]	Alarm Word 2	
[1692]	Warning Word	
[1693]	Warning Word 2	
[1694]	Ext. Status Word	
[1695]	Ext. Status Word 2	
[1830]	Analog Input X42/1	
[1831]	Analog Input X42/3	
[1832]	Analog Input X42/5	
[1833]	Analog Out X42/7 [V]	
[1834]	Analog Out X42/9 [V]	
[1835]	Analog Out X42/11 [V]	
[1850]	Sensorless Readout [unit]	
[1860]	Digital Input 2	
[3110]	Bypass Status Word	

15-11 Logging Interval		
Array [4]		
Range:	Function:	
Size related*	[0.000 - 0.000]	Enter the interval in ms between each sampling of the variables to be logged.

15-12 Trigger Event		
Option:	Function:	
		Selects the trigger event. When the trigger event occurs, a window is applied to freeze the log. The log then retains a specified percentage of samples before the occurrence of the

15-12 Trigger Event		
Option:	Function:	
		trigger event (parameter 15-14 Samples Before Trigger).
[0] *	False	
[1]	True	
[2]	Running	
[3]	In range	
[4]	On reference	
[5]	Torque limit	
[6]	Current Limit	
[7]	Out of current range	
[8]	Below I low	
[9]	Above I high	
[10]	Out of speed range	
[11]	Below speed low	
[12]	Above speed high	
[13]	Out of feedb. range	
[14]	Below feedb. low	
[15]	Above feedb. high	
[16]	Thermal warning	
[17]	Mains out of range	
[18]	Reversing	
[19]	Warning	
[20]	Alarm (trip)	
[21]	Alarm (trip lock)	
[22]	Comparator 0	
[23]	Comparator 1	
[24]	Comparator 2	
[25]	Comparator 3	
[26]	Logic rule 0	
[27]	Logic rule 1	
[28]	Logic rule 2	
[29]	Logic rule 3	
[33]	Digital input DI18	
[34]	Digital input DI19	
[35]	Digital input DI27	
[36]	Digital input DI29	
[37]	Digital input DI32	
[38]	Digital input DI33	
[50]	Comparator 4	
[51]	Comparator 5	
[60]	Logic rule 4	
[61]	Logic rule 5	

15-13 Logging Mode		
Option:	Function:	
[0] *	Log always	Select [0] Log always for continuous logging.
[1]	Log once on trigger	Select [1] Log once on trigger to conditionally start and stop logging using parameter 15-12 Trigger Event and parameter 15-14 Samples Before Trigger.

15-14 Samples Before Trigger		
Range:		Function:
50*	[0 - 100]	Enter the percentage of all samples before a trigger events which is to be retained in the log. See also <i>parameter 15-12 Trigger Event</i> and <i>parameter 15-13 Logging Mode</i> .

3.15.3 15-2* Historic Log

View up to 50 logged data items via the array parameters in this parameter group. For all parameters in the group, [0] is the most recent data, and [49] is the oldest data. Data is logged every time an *event* occurs (not to be confused with SLC events). *Events* in this context are defined as a change in 1 of the following areas:

- Digital input.
- Digital outputs.
- Warning word.
- Alarm word.
- Status word.
- Control word.
- Extended status word.

Events are logged with value and time stamp in ms. The time interval between 2 events depends on how often *events* occur (maximum once every scan time). Data logging is continuous, but if an alarm occurs, the log is saved and the values can be viewed on the display. This feature is useful, for example when carrying out service following a trip. View the historic log contained in this parameter via the serial communication port or via the display.

15-20 Historic Log: Event		
Array [50]		
Range:		Function:
0*	[0 - 255]	View the event type of the logged events.

15-21 Historic Log: Value		
Array [50]		
Range:		Function:
0*	[0 - 2147483647]	View the value of the logged event. Interpret the event values according to this table:
	Digital input	Decimal value. See <i>parameter 16-60 Digital Input</i> for description after converting to binary value.

15-21 Historic Log: Value		
Array [50]		
Range:		Function:
	Digital output (not monitored in this SW release)	Decimal value. See <i>16-66 Digital Output [bin]</i> for a description after converting to binary value.
	Warning word	Decimal value. See <i>16-92 Warning Word</i> for a description.
	Alarm word	Decimal value. See <i>16-90 Alarm Word</i> for a description.
	Status word	Decimal value. See <i>parameter 16-03 Status Word</i> for a description after converting to binary value.
	Control word	Decimal value. See <i>parameter 16-00 Control Word</i> for a description.
	Extended status word	Decimal value. See <i>16-94 Ext. Status Word</i> for a description.

15-22 Historic Log: Time		
Array [50]		
Range:		Function:
0 ms*	[0 - 2147483647 ms]	View the time at which the logged event occurred. Time is measured in ms since frequency converter start. The maximum value corresponds to approximately 24 days, which means that the count restarts at zero after this time period.

15-23 Historic log: Date and Time		
Array [50]		
Range:		Function:
Size related*	[0 - 0]	Array parameter; Date & Time 0–49: This parameter shows at which time the logged event occurred.

3.15.4 15-3* Alarm Log

Parameters in this group are array parameters, where up to 10 fault logs can be viewed. [0] is the most recent logged data, and [9] is the oldest. Fault codes, values, and time stamp can be viewed for all logged data.

15-30 Alarm Log: Error Code		
Array [10]		
Range:	Function:	
0*	[0 - 255]	View the error code and look up its meaning in <i>chapter 4 Troubleshooting</i> .

15-31 Alarm Log: Value		
Array [10]		
Range:	Function:	
0*	[-32767 - 32767]	View an extra description of the error. This parameter is mostly used in combination with <i>alarm 38 internal fault</i> .

15-32 Alarm Log: Time		
Array [10]		
Range:	Function:	
0 s*	[0 - 2147483647 s]	View the time when the logged event occurred. Time is measured in seconds from frequency converter start-up.

15-33 Alarm Log: Date and Time		
Array [10]		
Range:	Function:	
Size related*	[0 - 0]	Array parameter; Date & Time 0–9: This parameter shows at which time the logged event occurred.

3.15.5 15-4* Drive Identification

Parameters containing read-only information about the hardware and software configuration of the frequency converter.

15-40 FC Type		
Range:	Function:	
0*	[0 - 6]	View the FC type. The readout is identical to the frequency converter series power field of the type code definition, characters 1–6.

15-41 Power Section		
Range:	Function:	
0*	[0 - 20]	View the FC type. The readout is identical to the frequency converter series power field of the type code definition, characters 7–10.

15-42 Voltage		
Range:	Function:	
0*	[0 - 20]	View the FC type. The readout is identical to the frequency converter series power field of the type code definition, characters 11–12.

15-43 Software Version		
Range:	Function:	
0*	[0 - 5]	View the combined SW version (or package version) consisting of power SW and control SW.

15-44 Ordered Typecode String		
Range:	Function:	
0*	[0 - 40]	View the type code string used for reordering the frequency converter in its original configuration.

15-45 Actual Typecode String		
Range:	Function:	
0*	[0 - 40]	View the actual type code string.

15-46 Frequency Converter Ordering No		
Range:	Function:	
0*	[0 - 8]	View the 8-digit ordering number used for re-ordering the frequency converter in its original configuration.

15-47 Power Card Ordering No		
Range:	Function:	
0*	[0 - 8]	View the power card ordering number.

15-48 LCP Id No		
Range:	Function:	
0*	[0 - 20]	View the LCP ID number.

15-49 SW ID Control Card		
Range:	Function:	
0*	[0 - 20]	View the control card software version number.

15-50 SW ID Power Card		
Range:	Function:	
0*	[0 - 20]	View the power card software version number.

15-51 Frequency Converter Serial Number		
Range:	Function:	
0*	[0 - 10]	View the frequency converter serial number.

15-53 Power Card Serial Number		
Range:	Function:	
0*	[0 - 19]	View the power card serial number.

15-59 CSIV Filename		
Range:	Function:	
Size related*	[0 - 16]	CSIV Filename readout.

3.15.6 15-6* Option Ident.

This read-only parameter group contains information about the hardware and software configuration of the options installed in slots A, B, C0 and C1.

15-60 Option Mounted		
Array [8]		
Range:	Function:	
0*	[0 - 30]	View the installed option type.

15-61 Option SW Version		
Array [8]		
Range:	Function:	
0*	[0 - 20]	View the installed option software version.

15-62 Option Ordering No		
Array [8]		
Range:	Function:	
0*	[0 - 8]	Shows the ordering number for the installed options.

15-63 Option Serial No		
Array [8]		
Range:	Function:	
0*	[0 - 18]	View the installed option serial number.

15-70 Option in Slot A		
Range:	Function:	
0*	[0 - 30]	View the type code string for the option installed in slot A, and a translation of the type code string. For example, for type code string AX, the translation is No option.

15-71 Slot A Option SW Version		
Range:	Function:	
0*	[0 - 20]	View the software version for the option installed in slot A.

15-72 Option in Slot B		
Range:	Function:	
0*	[0 - 30]	View the type code string for the option installed in slot B, and a translation of the type code string. For example, for type code string BX, the translation is No option.

15-73 Slot B Option SW Version		
Range:	Function:	
0*	[0 - 20]	View the software version for the option installed in slot B.

15-74 Option in Slot C0/E0		
Range:	Function:	
0*	[0 - 30]	View the type code string for the option installed in slot C, and a translation of the type code string. For example, for type code string CXXXX, the translation is No option.

15-75 Slot C0/E0 Option SW Version		
Range:	Function:	
0*	[0 - 20]	View the software version for the option installed in slot C.

15-76 Option in Slot C1/E1		
Range:	Function:	
0*	[0 - 30]	Shows the typecode string for the options (CXXXX if no option) and the translation is, for example, No option.

15-77 Slot C1/E1 Option SW Version		
Range:	Function:	
0*	[0 - 20]	Software version for the installed option in option slot C.

15-80 Fan Running Hours		
Range:	Function:	
0 h*	[0 - 2147483647 h]	View how many hours the heat sink fan has run (increments for each hour). The value is saved when the frequency converter is turned off.

15-81 Preset Fan Running Hours		
Range:	Function:	
0 h*	[0 - 99999 h]	Enter value to preset the fan running hours counter, see <i>parameter 15-80 Fan Running Hours</i> . This parameter cannot be selected via the serial port, RS485.

3.15.7 15-9* Parameter Info

15-92 Defined Parameters		
Array [1000]		
Range:	Function:	
0*	[0 - 9999]	View a list of all defined parameters in the frequency converter. The list ends with 0.

15-93 Modified Parameters		
Array [1000]		
Range:	Function:	
0*	[0 - 9999]	View a list of the parameters that have been changed from their default setting. The list ends with 0. Changes may not be visible until up to 30 s after implementation.

15-98 Drive Identification		
Range:		Function:
0*	[0 - 40]	

15-99 Parameter Metadata		
Array [23]		
Range:		Function:
0*	[0 - 9999]	This parameter contains data used by the MCT 10 Set-up Software tool.

3.16 Parameters: 16-** Main Menu - Data Readouts

3.16.1 16-0* General Status

16-00 Control Word		
Range:	Function:	
0* [0 - 65535]	View the control word sent from the frequency converter via the serial communication port in hex code.	

16-01 Reference [Unit]		
Range:	Function:	
0 ReferenceFeed-backUnit*	[-999999 - 999999 ReferenceFeed-backUnit]	View the present reference value applied on impulse or analog basis in the unit resulting from the configuration selected in <i>parameter 1-00 Configuration Mode</i> (Hz, Nm, or RPM).

16-02 Reference [%]		
Range:	Function:	
0 %* [-200 - 200 %]	View the total reference. The total reference is the sum of digital, analog, preset, bus, and freeze references, plus catch up and slow down.	

16-03 Status Word		
Range:	Function:	
0* [0 - 65535]	View the status word sent from the frequency converter via the serial communication port in hex code.	

16-05 Main Actual Value [%]		
Range:	Function:	
0 %* [-100 - 100 %]	View the 2-byte word sent with the status word to the bus master reporting the main actual value.	

16-09 Custom Readout		
Range:	Function:	
0 CustomReadoutUnit*	[-999999.99 - 999999.99 CustomReadoutUnit]	View the user-defined readouts as defined in <i>parameter 0-30 Custom Readout Unit</i> , <i>parameter 0-31 Custom Readout Min Value</i> , and <i>parameter 0-32 Custom Readout Max Value</i> .

3.16.2 16-1* Motor Status

16-10 Power [kW]		
Range:	Function:	
0 kW* [0 - 10000 kW]	Displays motor power in kW. The value shown is calculated based on the actual motor voltage and motor current. The value is filtered, and therefore approximately 1.3 s may pass from when an input value changes to when the data readout values change. The resolution of readout value on fieldbus is in 10 W steps.	

16-11 Power [hp]		
Range:	Function:	
0 hp* [0 - 10000 hp]	View the motor power in hp. The value shown is calculated based on the actual motor voltage and motor current. The value is filtered, and therefore approximately 1.3 ms may pass from when an input value changes to when the data readout values change.	

16-12 Motor Voltage		
Range:	Function:	
0 V* [0 - 6000 V]	View the motor voltage, a calculated value used for controlling the motor.	

16-13 Frequency		
Range:	Function:	
0 Hz* [0 - 6500 Hz]	View the motor frequency, without resonance damping.	

16-14 Motor current		
Range:	Function:	
0 A* [0 - 10000 A]	View the motor current measured as a mean value, I_{RMS} . The value is filtered, and thus approximately 1.3 s may pass from when an input value changes to when the data readout values change.	

16-15 Frequency [%]		
Range:	Function:	
0 %* [-100 - 100 %]	View a 2-byte word reporting the actual motor frequency (without resonance dampening) as a percentage (scale 0000-4000 hex) of <i>parameter 4-19 Max Output Frequency</i> . Set <i>parameter 9-16 PCD Read Configuration</i> index 1 to send it with the status word instead of the MAV.	

16-16 Torque [Nm]		
Range:	Function:	
0 Nm*	[-30000 - 30000 Nm]	View the torque value with sign, applied to the motor shaft. Linearity is not exact between 110% motor current and torque in relation to the rated torque. Some motors supply more than 160% torque. Consequently, the min. value and maximum values depend on the maximum motor current as well as the motor used. The value is filtered, and thus approximately 1.3 s may pass from when an input changes value to when the data readout values change.

16-17 Speed [RPM]		
Range:	Function:	
0 RPM*	[-30000 - 30000 RPM]	View the actual motor RPM.

16-18 Motor Thermal		
Range:	Function:	
0 %*	[0 - 100 %]	View the calculated thermal load on the motor. The cut-out limit is 100%. The basis for calculation is the ETR function selected in <i>parameter 1-90 Motor Thermal Protection</i> .

16-22 Torque [%]		
Range:	Function:	
0 %*	[-200 - 200 %]	This is a read-out parameter only. Shows the actual torque yielded in percentage of the rated torque, based on the setting of the motor size and rated speed in <i>parameter 1-20 Motor Power [kW]</i> or <i>parameter 1-21 Motor Power [HP]</i> , and <i>parameter 1-25 Motor Nominal Speed</i> . This is the value monitored by the <i>Broken Belt Function</i> set in parameter group 22-6* Broken Belt Detection.

16-26 Power Filtered [kW]		
Range:	Function:	
0 kW*	[0 - 10000 kW]	Motor power consumption. The value shown is calculated on basis of the actual motor voltage and motor current. The value is filtered, and a few seconds may pass from when an input value changes to when the data readout values change.

16-27 Power Filtered [hp]		
Range:	Function:	
0 hp*	[0 - 10000 hp]	Motor power in hp. The value shown is calculated on the basis of actual motor voltage and motor current. The value is filtered, and a few seconds may pass from when an input value changes to when the data readout values change.

3.16.3 16-3* Drive Status

16-30 DC Link Voltage		
Range:	Function:	
0 V*	[0 - 10000 V]	View a measured value. The value is filtered with a 30 ms time constant.

16-32 Brake Energy /s		
Range:	Function:	
0 kW*	[0 - 10000 kW]	View the brake power transmitted to an external brake resistor, stated as an instantaneous value.

16-33 Brake Energy Average		
Range:	Function:	
0 kW*	[0 - 10000 kW]	View the brake power transmitted to an external brake resistor. The mean power is calculated on an average level based on the selected time period within <i>2-13 Brake Power Monitoring</i> .

16-34 Heatsink Temp.		
Range:	Function:	
0 °C*	[0 - 255 °C]	View the frequency converter heat sink temperature. The cut-out limit is 90 ± 5 °C, and the motor cuts back in at 60 ± 5 °C.

16-35 Inverter Thermal		
Range:	Function:	
0 %*	[0 - 100 %]	View the thermal load on the inverter. The cut-out limit is 100%.

16-36 Inv. Nom. Current		
Range:	Function:	
Size related*	[0.01 - 10000 A]	View the inverter nominal current, which should match the nameplate data on the connected motor. The data is used for calculation of torque, motor protection, and so on.

16-37 Inv. Max. Current		
Range:	Function:	
Size related*	[0.01 - 10000 A]	View the inverter maximum current, which should match the nameplate data on the connected motor. The data is used for calculation of torque, motor protection, and so on.

16-38 SL Controller State		
Range:	Function:	
0*	[0 - 100]	View the state of the event under execution by the SL controller.

16-39 Control Card Temp.		
Range:	Function:	
0 °C* [0 - 100 °C]	View the temperature on the control card, stated in °C.	

16-40 Logging Buffer Full		
Option:	Function:	
	View whether the logging buffer is full (see parameter group 15-1* <i>Data Log Settings</i>). The logging buffer is never full when <i>parameter 15-13 Logging Mode</i> is set to [0] <i>Log always</i> .	
[0] *	No	
[1]	Yes	

16-43 Timed Actions Status		
View the timed actions mode.		
Option:	Function:	
[0] *	Timed Actions Auto	
[1]	Timed Actions Disabled	
[2]	Constant On Actions	
[3]	Constant Off Actions	

16-49 Current Fault Source		
Range:	Function:	
0* [0 - 8]	The Value indicates source of current fault, including: <ul style="list-style-type: none"> Short circuit. Overcurrent Phase imbalance (from left): [1-4] Inverter, [5-8] Rectifier, [0] No fault recorded. 	

After a short-circuit alarm (I_{max2}) or overcurrent alarm (I_{max1} or phase imbalance), this contains the power card number associated with the alarm. It only holds 1 number indicating the highest priority power card number (master first). The value persists on power cycle, but if a new alarm occurs it is overwritten by the new power card number (even if it is a lower priority number). The value is only cleared when the alarm log is cleared (that is a 3-finger reset would reset the readout to 0).

3.16.4 16-5* Ref. & Feedb.

16-50 External Reference		
Range:	Function:	
0* [-200 - 200]	View the total reference, the sum of digital, analog, preset, bus and freeze references, plus catch-up and slow-down.	

16-52 Feedback[Unit]		
Range:	Function:	
0 ProcessCtrlUnit* [-999999.999 - 999999.999 ProcessCtrlUnit]	View value of resulting feedback value after processing of feedback 1-3 see <ul style="list-style-type: none"> Parameter 16-54 Feedback 1 [Unit]. Parameter 16-55 Feedback 2 [Unit]. Parameter 16-56 Feedback 3 [Unit]. in the feedback manager. See parameter group 20-0* <i>Feedback</i> . The value is limited by settings in <i>parameter 20-13 Minimum Reference/Feedb.</i> , and <i>parameter 20-14 Maximum Reference/Feedb.</i> Units as set in <i>20-12 Reference/Feedback Unit</i> .	

16-53 Digi Pot Reference		
Range:	Function:	
0* [-200 - 200]	View the contribution of the digital potentiometer to the actual reference.	

16-54 Feedback 1 [Unit]		
Range:	Function:	
0 ProcessCtrlUnit* [-999999.999 - 999999.999 ProcessCtrlUnit]	View value of Feedback 1, see parameter group 20-0* <i>Feedback</i> . The value is limited by settings in <i>parameter 20-13 Minimum Reference/Feedb.</i> and <i>parameter 20-14 Maximum Reference/Feedb.</i> Units as set in <i>20-12 Reference/Feedback Unit</i> .	

16-55 Feedback 2 [Unit]		
Range:	Function:	
0 ProcessCtrlUnit* [-999999.999 - 999999.999 ProcessCtrlUnit]	View value of feedback 2, see parameter group 20-0* <i>Feedback</i> . The value is limited by settings in <i>parameter 20-13 Minimum Reference/Feedb.</i> and <i>parameter 20-14 Maximum Reference/Feedb.</i> Units as set in <i>20-12 Reference/Feedback Unit</i> .	

16-56 Feedback 3 [Unit]		
Range:	Function:	
0 ProcessCtrlUnit*	[-999999.999 - 999999.999 ProcessCtrlUnit]	View value of Feedback 3, see parameter group 20-0* <i>Feedback</i> . The value is limited by settings in <i>parameter 20-13 Minimum Reference/Feedb.</i> and <i>parameter 20-14 Maximum Reference/Feedb.</i> Units as set in <i>20-12 Reference/Feedback Unit</i> .

16-58 PID Output [%]		
Range:	Function:	
0 %*	[0 - 100 %]	This parameter returns the drive closed-loop PID controller output value in percent.

3.16.5 16-6* Inputs and Outputs

16-60 Digital Input		
Range:	Function:	
0*	[0 - 65535]	View the signal states from the active digital inputs. Example: Input 18 corresponds to bit number 5, 0=no signal, 1=connected signal. Bit 6 works in the opposite way, on=0, off=1 (safe torque off input).
	Bit 0	Digital input term. 33
	Bit 1	Digital input term. 32
	Bit 2	Digital input term. 29
	Bit 3	Digital input term. 27
	Bit 4	Digital input term. 19
	Bit 5	Digital input term. 18
	Bit 6	Digital input term. 37
	Bit 7	Digital input GP I/O term. X30/4
	Bit 8	Digital input GP I/O term. X30/3
	Bit 9	Digital input GP I/O term. X30/2
	Bit 10-63	Reserved for future terminals

Table 3.20 Active Digital Inputs

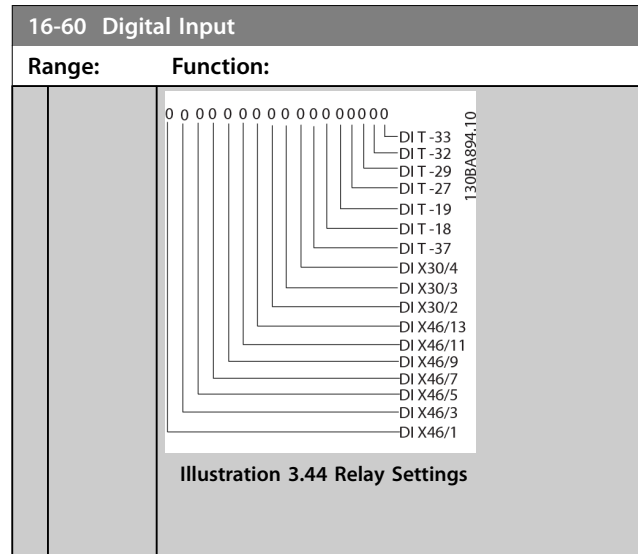

16-61 Terminal 53 Switch Setting		
Option:	Function:	
		View the setting of input terminal 53.
[0] *	Current	
[1]	Voltage	

16-62 Analog Input 53		
Range:	Function:	
0*	[-20 - 20]	View the actual value at input 53.

16-63 Terminal 54 Switch Setting		
Option:	Function:	
		View the setting of input terminal 54.
[0] *	Current	
[1]	Voltage	

16-64 Analog Input 54		
Range:	Function:	
0*	[-20 - 20]	View the actual value at input 54.

16-65 Analog Output 42 [mA]		
Range:	Function:	
0*	[0 - 30]	View the actual value at output 42 in mA. The value shown reflects the selection in <i>parameter 6-50 Terminal 42 Output</i> .

16-66 Digital Output [bin]		
Range:	Function:	
0*	[0 - 15]	View the binary value of all digital outputs.

16-67 Pulse Input #29 [Hz]		
Range:	Function:	
0*	[0 - 130000]	View the actual frequency rate on terminal 29.

16-68 Pulse Input #33 [Hz]		
Range:	Function:	
0* [0 - 130000]	View the actual value of the frequency applied at terminal 33 as an impulse input.	

16-69 Pulse Output #27 [Hz]		
Range:	Function:	
0* [0 - 40000]	View the actual value of impulses applied to terminal 27 in digital output mode.	

16-70 Pulse Output #29 [Hz]		
Range:	Function:	
0* [0 - 40000]	View the actual value of pulses to terminal 29 in digital output mode.	

16-71 Relay Output [bin]		
Range:	Function:	
0* [0 - 511]	View the settings of all relays.	
<div style="border: 1px solid black; padding: 5px; margin: 10px 0;"> <p>Readout choice (Par. 16-71): Relay output (bin):</p> <p style="text-align: right;">130BA195.10</p> <p>0 0 0 0 bin</p> <p style="text-align: center;">Illustration 3.46 Relay Settings</p> </div>		

16-72 Counter A		
Range:	Function:	
0* [-2147483648 - 2147483647]	View the present value of counter A. Counters are useful as comparator operands, see <i>parameter 13-10 Comparator Operand</i> . The value can be reset or changed either via digital inputs (parameter group 5-1* <i>Digital Inputs</i>) or by using an SLC action (<i>parameter 13-52 SL Controller Action</i>).	

16-73 Counter B		
Range:	Function:	
0* [-2147483648 - 2147483647]	View the present value of counter B. Counters are useful as comparator operands (<i>parameter 13-10 Comparator Operand</i>). The value can be reset or changed either via digital inputs (parameter group 5-1* <i>Digital Inputs</i>) or by using an SLC action (<i>parameter 13-52 SL Controller Action</i>).	

16-75 Analog In X30/11		
Range:	Function:	
0* [-20 - 20]	View the actual value at input X30/11 of MCB 101.	

16-76 Analog In X30/12		
Range:	Function:	
0* [-20 - 20]	View the actual value at input X30/12 of MCB 101.	

16-77 Analog Out X30/8 [mA]		
Range:	Function:	
0* [0 - 30]	View the actual value at input X30/8 in mA.	

3.16.6 16-8* Fieldbus & FC Port

Parameters for reporting the bus references and control words.

16-80 Fieldbus CTW 1		
Range:	Function:	
0* [0 - 65535]	View the 2-byte control word (CTW) received from the bus master. Interpretation of the control word depends on the fieldbus option installed and the control word profile selected in <i>parameter 8-10 Control Profile</i> . For more information, refer to the relevant fieldbus manual.	

16-82 Fieldbus REF 1		
Range:	Function:	
0* [-200 - 200]	View the 2-byte word sent with the control word from the bus master to set the reference value. For more information, refer to the relevant fieldbus manual.	

16-84 Comm. Option STW		
Range:	Function:	
0* [0 - 65535]	View the extended fieldbus communication option status word. For more information, refer to the relevant fieldbus manual.	

16-85 FC Port CTW 1		
Range:	Function:	
0* [0 - 65535]	View the 2-byte control word (CTW) received from the bus master. Interpretation of the control word depends on the fieldbus option installed and the control word profile selected in <i>parameter 8-10 Control Profile</i> .	

16-86 FC Port REF 1		
Range:	Function:	
0* [-200 - 200]	View the 2-byte status word (STW) sent to the bus master. Interpretation of the status word depends on the fieldbus option installed and the control word profile selected in <i>parameter 8-10 Control Profile</i> .	

3.16.7 16-9* Diagnosis Readouts

NOTICE

When using MCT 10 Set-up Software, the readout parameters can only be read online, that is as the actual status. This means that the status is not stored in the MCT 10 Set-up Software file.

16-90 Alarm Word		
Range:	Function:	
0* [0 - 4294967295]	View the alarm word sent via the serial communication port in hex code.	

16-91 Alarm Word 2		
Range:	Function:	
0* [0 - 4294967295]	View the alarm word 2 sent via the serial communication port in hex code.	

16-92 Warning Word		
Range:	Function:	
0* [0 - 4294967295]	View the warning word sent via the serial communication port in hex code.	

16-93 Warning Word 2		
Range:	Function:	
0* [0 - 4294967295]	View the warning word 2 sent via the serial communication port in hex code.	

16-94 Ext. Status Word		
Range:	Function:	
0* [0 - 4294967295]	Returns the extended status word sent via the serial communication port in hex code.	

16-95 Ext. Status Word 2		
Range:	Function:	
0* [0 - 4294967295]	Returns the extended warning word 2 sent via the serial communication port in hex code.	

16-96 Maintenance Word		
Range:	Function:	
0* [0 - 4294967295]	Readout of the preventive maintenance word. The bits reflect the status for the programmed preventive maintenance events in parameter group 23-1* <i>Maintenance</i> . 13 bits represent combinations of all the possible items: <ul style="list-style-type: none"> • Bit 0: Motor bearings . • Bit 1: Pump bearings. • Bit 2: Fan bearings. • Bit 3: Valve. • Bit 4: Pressure transmitter. • Bit 5: Flow transmitter. • Bit 6: Temperature transmitter. • Bit 7: Pump seals. • Bit 8: Fan belt. • Bit 9: Filter. • Bit 10: Drive cooling fan. • Bit 11: Drive system health check. • Bit 12: Warranty. • Bit 13: Maintenance Text 0. • Bit 14: Maintenance Text 1. • Bit 15: Maintenance Text 2. • Bit 16: Maintenance Text 3. • Bit 17: Maintenance Text 4. 	

3

16-96 Maintenance Word				
Range:	Function:			
4→	Valve	Fan bearings	Pump bearings	Motor bearings
3→	Pump seals	Temperature transmitter	Flow transmitter	Pressure transmitter
2→	Drive system health check	Drive cooling fan	Filter	Fan belt
1→				Warranty
0 _{hex}	-	-	-	-
1 _{hex}	-	-	-	+
2 _{hex}	-	-	+	-
3 _{hex}	-	-	+	+
4 _{hex}	-	+	-	-
5 _{hex}	-	+	-	+
6 _{hex}	-	+	+	-
7 _{hex}	-	+	+	+
8 _{hex}	+	-	-	-
9 _{hex}	+	-	-	+
A _{hex}	+	-	+	-
B _{hex}	+	-	+	+
C _{hex}	+	+	-	-
D _{hex}	+	+	-	+
E _{hex}	+	+	+	-
F _{hex}	+	+	+	+

Table 3.21 Maintenance Word

Example:
The preventive maintenance word shows 040A_{hex}.

Position	1	2	3	4
Hex value	0	4	0	A

Table 3.22 Example

The first digit 0 indicates that no items from the fourth row require maintenance
 The second digit 4 refers to the third row indicating that the frequency converter cooling fan requires maintenance
 The third digit 0 indicates that no items from the second row require maintenance
 The fourth digit A refers to the top row indicating that the valve and the pump bearings require maintenance

3.17 Parameters: 18-** Main Menu - Data Readouts 2

3.17.1 18-0* Maintenance Log

This group contains the last 10 preventive maintenance events. Maintenance log 0 is the latest and maintenance log 9 the oldest.

By selecting 1 of the logs and pressing [OK], the maintenance item, action and time of the occurrence, can be found in *parameter 18-00 Maintenance Log: Item* – *parameter 18-03 Maintenance Log: Date and Time*.

The alarm log key allows access to both alarm log and maintenance log.

18-00 Maintenance Log: Item		
Array [10]. Array parameter; Error code 0-9: The meaning of the error code can be found in the chapter <i>Troubleshooting</i> in the design guide.		
Range:	Function:	
0*	[0 - 255]	Locate the meaning of the maintenance item in the description of <i>parameter 23-10 Maintenance Item</i> .

18-01 Maintenance Log: Action		
Array [10]. Array parameter; Error code 0-9: The meaning of the error code can be found in the chapter <i>Troubleshooting</i> in the design guide.		
Range:	Function:	
0*	[0 - 255]	Locate the meaning of the maintenance item in the description of <i>parameter 23-11 Maintenance Action</i> .

18-02 Maintenance Log: Time		
Array [10]. Array parameter; Time 0-9: This parameter shows at which time the logged event occurred. Time is measured in seconds since start of the frequency converter.		
Range:	Function:	
0 s*	[0 - 2147483647 s]	Shows when the logged event occurred. Time is measured in seconds since last power-up.

18-03 Maintenance Log: Date and Time		
Array [10]		
Range:	Function:	
Size related*	[0 - 0]	Shows when the logged event occurred. NOTICE This requires that the date and time is programmed in <i>parameter 0-70 Date and Time</i> .

18-03 Maintenance Log: Date and Time		
Array [10]		
Range:	Function:	
		Date format depends on the setting in <i>parameter 0-71 Date Format</i> , while the time format depends on the setting in <i>parameter 0-72 Time Format</i> . NOTICE The frequency converter has no back-up of the clock function and the set date/time resets to default (2000-01-01 00:00) after a power-down unless a real time clock module with back-up is installed. In <i>parameter 0-79 Clock Fault</i> it is possible to programme a warning in case the clock has not been set properly, for example after a power-down. Incorrect setting of the clock affects the time stamps for the maintenance events.

NOTICE

When mounting an analog I/O MCB 109 option card, a battery back-up of date and time is included.

3.17.2 18-1* Fire Mode Log

The log covers the latest 10 faults which have been suppressed by the Fire mode function. See parameter group 24-0*, *Fire Mode*. The log can be viewed either via the below parameters or by pressing [Alarm Log] on the LCP and select *Fire mode log*. It is not possible to reset the fire mode log.

18-10 FireMode Log:Event		
Range:	Function:	
0*	[0 - 255]	This parameter contains an array with 10 elements. The number read represent an error code, which corresponds to a specific alarm. This can be found in the <i>Troubleshooting</i> section in the design guide.

18-11 Fire Mode Log: Time		
Range:	Function:	
0 s*	[0 - 2147483647 s]	This parameter contains an array with 10 elements. The parameter shows at which time the logged event occurred. Time is measured in seconds since the first start of the motor.

18-12 Fire Mode Log: Date and Time		
Range:		Function:
Size related*	[0 - 0]	This parameter contains an array with 10 elements. The parameter shows at which date and time the logged event occurred. The function relies on that the actual date and time has been set in <i>parameter 0-70 Date and Time</i> . Note: There is no built-in battery back-up of the clock. Use an external back-up, for example the one in the MCB 109 Analog I/O option card. See parameter group 0-7* Clock Settings .

3.17.3 18-3* Analog I/O

Parameters for reporting the digital and analog I/O ports.

18-30 Analog Input X42/1		
Range:		Function:
0*	[-20 - 20]	Readout of the value of the signal applied to terminal X42/1 on the analog I/O card. The units of the value shown in the LCP correspond to the mode selected in <i>parameter 26-00 Terminal X42/1 Mode</i> .

18-31 Analog Input X42/3		
Range:		Function:
0*	[-20 - 20]	Readout of the value of the signal applied to terminal X42/3 on the analog I/O card. The units of the value shown in the LCP correspond to the mode selected in <i>parameter 26-01 Terminal X42/3 Mode</i> .

18-32 Analog Input X42/5		
Range:		Function:
0*	[-20 - 20]	Readout of the value of the signal applied to terminal X42/5 on the analog I/O card. The units of the value shown in the LCP correspond to the mode selected in <i>parameter 26-02 Terminal X42/5 Mode</i> .

18-33 Analog Out X42/7 [V]		
Range:		Function:
0*	[0 - 30]	Readout of the value of the signal applied to terminal X42/7 on the analog I/O card. The value shown reflects the selection in <i>parameter 26-40 Terminal X42/7 Output</i> .

18-34 Analog Out X42/9 [V]		
Range:		Function:
0*	[0 - 30]	Readout of the value of the signal applied to terminal X42/9 on the analog I/O card. The value shown reflects the selection in <i>parameter 26-50 Terminal X42/9 Output</i> .

18-35 Analog Out X42/11 [V]		
Range:		Function:
0*	[0 - 30]	Readout of the value of the signal applied to terminal X42/11 on the analog I/O card. The value shown reflects the selection in <i>parameter 26-60 Terminal X42/11 Output</i> .

18-36 Analog Input X48/2 [mA]		
Range:		Function:
0*	[-20 - 20]	View the actual current measured at input X48/2.

18-37 Temp. Input X48/4		
Range:		Function:
0*	[-500 - 500]	View the actual temperature measured at input X48/4. The temperature unit is based on the selection in <i>35-00 Term. X48/4 Temperature Unit</i> .

18-38 Temp. Input X48/7		
Range:		Function:
0*	[-500 - 500]	View the actual temperature measured at input X48/7. The temperature unit is based on the selection in <i>35-02 Term. X48/7 Temperature Unit</i> .

18-39 Temp. Input X48/10		
Range:		Function:
0*	[-500 - 500]	View the actual temperature measured at input X48/10. The temperature unit is based on the selection in <i>35-04 Term. X48/10 Temperature Unit</i> .

3.17.4 18-5* Ref. & Feedb.

NOTICE

Sensorless readout requires set-up by MCT 10 Set-up Software with sensorless specific plug-in.

18-50 Sensorless Readout [unit]		
Range:		Function:
0 SensorlessUnit*	[-999999.999 - 999999.999 SensorlessUnit]	

3.18 Parameters: 20-** Main Menu - FC Closed Loop

This parameter group is used for configuring the closed-loop PID controller that controls the output frequency of the frequency converter.

3.18.1 20-0* Feedback

This parameter group is used to configure the feedback signal for the frequency converter's closed-loop PID controller. Whether the frequency converter is in closed-loop mode or open-loop mode, the feedback signals can also be shown on the frequency converter's display, be used to control a frequency converter analog output, and be transmitted over various serial communication protocols.

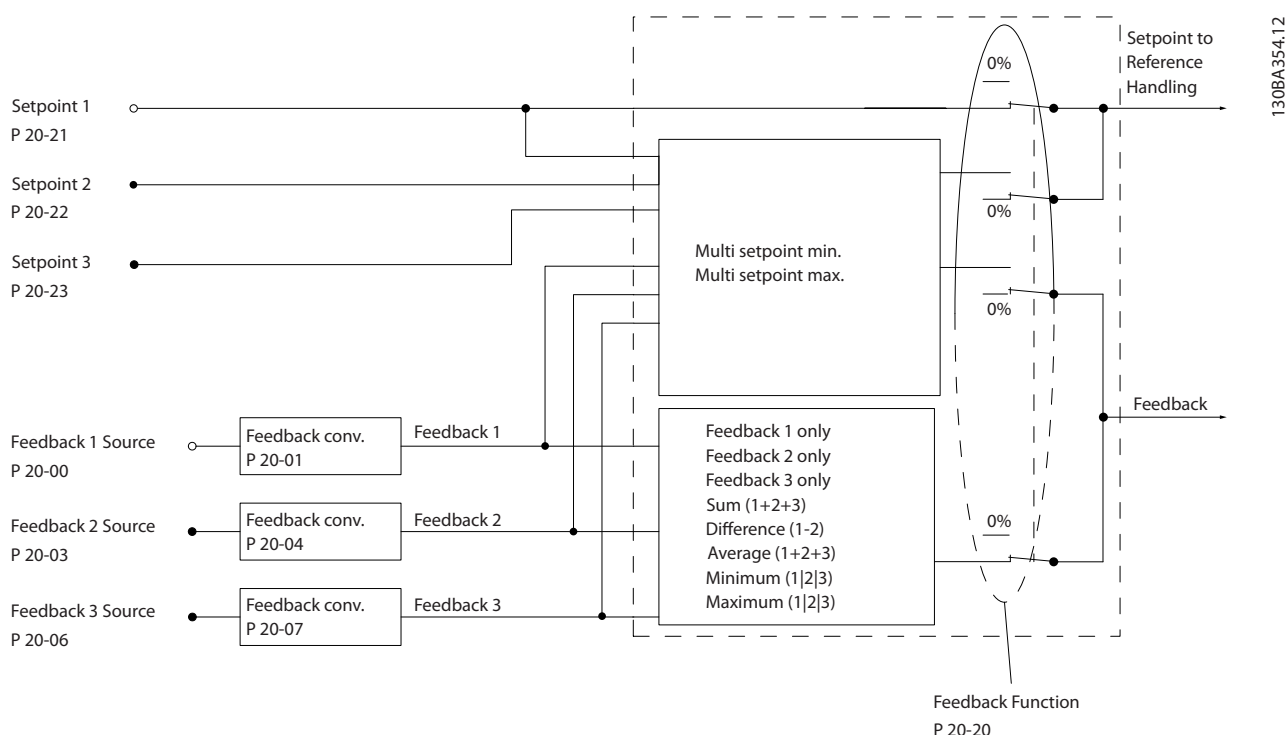

Illustration 3.47 Feedback

20-00 Feedback 1 Source	
Option:	Function:
	<p>NOTICE</p> <p>If a feedback is not used, set its source to [0] No Function. Parameter 20-20 Feedback Function determines how the PID controller uses the 3 possible feedbacks.</p> <p>Up to 3 different feedback signals can be used to provide the feedback signal for the frequency converter's PID controller. This parameter defines which input is used as the source of the first feedback signal.</p>

20-00 Feedback 1 Source	
Option:	Function:
	Analog input X30/11 and analog input X30/12 refer to inputs on the optional general purpose I/O board.
[0]	No function
[1]	Analog Input 53
[2] *	Analog Input 54
[3]	Pulse input 29
[4]	Pulse input 33
[7]	Analog Input X30/11
[8]	Analog Input X30/12
[9]	Analog Input X42/1

20-00 Feedback 1 Source		
Option:	Function:	
[10]	Analog Input X42/3	
[11]	Analog Input X42/5	
[15]	Analog Input X48/2	
[100]	Bus Feedback 1	
[101]	Bus Feedback 2	
[102]	Bus feedback 3	
[104]	Sensorless Flow	Requires set-up by MCT 10 Set-up Software with sensorless-specific plug-in.
[105]	Sensorless Pressure	Requires set-up by MCT 10 Set-up Software with sensorless-specific plug-in.

20-01 Feedback 1 Conversion		
Option:	Function:	
		This parameter allows a conversion function to be applied to feedback 1.
[0]	Linear	No effect on the feedback.
[1]	Square root	Commonly used when a pressure sensor is used to provide flow feedback ($(flow \propto \sqrt{pressure})$).
[2]	Pressure to temperature	Used in compressor applications to provide temperature feedback using a pressure sensor. The temperature of the refrigerant is calculated using the following formula: $Temperature = \frac{A2}{(\ln(Pe + 1) - A1)} - A3,$ where A1, A2 and A3 are refrigerant-specific constants. Select the refrigerant in <i>parameter 20-30 Refrigerant</i> . <i>Parameter 20-21 Setpoint 1</i> through <i>parameter 20-23 Setpoint 3</i> allow the values of A1, A2 and A3 to be entered for a refrigerant that is not listed in <i>parameter 20-30 Refrigerant</i> .
[3]	Pressure to flow	Used in applications for controlling the air flow in a duct. A dynamic pressure measurement (pitot tube) represents the feedback signal. $Flow = Duct\ Area \times \sqrt{Dynamic\ Pressure} \times Air\ Density\ Factor$ See also <i>parameter 20-34 Duct 1 Area [m2]</i> through <i>parameter 20-38 Air Density Factor [%]</i> for setting of duct area and air density.
[4]	Velocity to flow	Used in applications for controlling the air flow in a duct. An air velocity measurement represents the feedback signal. $Flow = Duct\ Area \times Air\ Velocity$ See also <i>parameter 20-34 Duct 1 Area [m2]</i> through <i>parameter 20-37 Duct 2 Area [in2]</i> for setting of duct area.

20-02 Feedback 1 Source Unit		
Option:	Function:	
		<p>NOTICE</p> <p>This parameter is only available when using pressure to temperature feedback conversion.</p> <p>If option [0] <i>Linear</i> is selected in <i>parameter 20-01 Feedback 1 Conversion</i>, the setting of any option in <i>parameter 20-02 Feedback 1 Source Unit</i> does not matter as a conversion is 1-to-1.</p> <p>This parameter determines the unit that is used for this feedback source, before applying the feedback conversion of <i>parameter 20-01 Feedback 1 Conversion</i>. This unit is not used by the PID controller.</p>
[0]	None	
[1]	%	
[5]	PPM	
[10]	1/min	
[11]	RPM	
[12]	Pulse/s	
[20]	l/s	
[21]	l/min	
[22]	l/h	
[23]	m ³ /s	
[24]	m ³ /min	
[25]	m ³ /h	
[30]	kg/s	
[31]	kg/min	
[32]	kg/h	
[33]	t/min	
[34]	t/h	
[40]	m/s	
[41]	m/min	
[45]	m	
[60]	°C	
[70]	mbar	
[71]	bar	
[72]	Pa	
[73]	kPa	
[74]	m WG	
[75]	mm Hg	
[80]	kW	
[120]	GPM	
[121]	gal/s	
[122]	gal/min	
[123]	gal/h	
[124]	CFM	
[125]	ft ³ /s	
[126]	ft ³ /min	
[127]	ft ³ /h	
[130]	lb/s	

20-02 Feedback 1 Source Unit		
Option:	Function:	
[131]	lb/min	
[132]	lb/h	
[140]	ft/s	
[141]	ft/min	
[145]	ft	
[160]	°F	
[170]	psi	
[171]	lb/in ²	
[172]	in WG	
[173]	ft WG	
[174]	in Hg	
[180]	HP	

20-03 Feedback 2 Source		
Option:	Function:	
		See parameter 20-00 Feedback 1 Source for details.
[0] *	No function	
[1]	Analog Input 53	
[2]	Analog Input 54	
[3]	Pulse input 29	
[4]	Pulse input 33	
[7]	Analog Input X30/11	
[8]	Analog Input X30/12	
[9]	Analog Input X42/1	
[10]	Analog Input X42/3	
[11]	Analog Input X42/5	
[15]	Analog Input X48/2	
[100]	Bus Feedback 1	
[101]	Bus Feedback 2	
[102]	Bus feedback 3	
[104]	Sensorless Flow	
[105]	Sensorless Pressure	

20-04 Feedback 2 Conversion		
Option:	Function:	
		See parameter 20-01 Feedback 1 Conversion for details.
[0] *	Linear	
[1]	Square root	
[2]	Pressure to temperature	
[3]	Pressure to flow	
[4]	Velocity to flow	

20-05 Feedback 2 Source Unit		
Option:	Function:	
		See parameter 20-02 Feedback 1 Source Unit for details.

20-06 Feedback 3 Source		
Option:	Function:	
		See parameter 20-00 Feedback 1 Source for details.
[0] *	No function	
[1]	Analog Input 53	
[2]	Analog Input 54	
[3]	Pulse input 29	
[4]	Pulse input 33	
[7]	Analog Input X30/11	
[8]	Analog Input X30/12	
[9]	Analog Input X42/1	
[10]	Analog Input X42/3	
[11]	Analog Input X42/5	
[15]	Analog Input X48/2	
[100]	Bus Feedback 1	
[101]	Bus Feedback 2	
[102]	Bus feedback 3	
[104]	Sensorless Flow	
[105]	Sensorless Pressure	

20-07 Feedback 3 Conversion		
Option:	Function:	
		See parameter 20-01 Feedback 1 Conversion for details.
[0] *	Linear	
[1]	Square root	
[2]	Pressure to temperature	
[3]	Pressure to flow	
[4]	Velocity to flow	

20-08 Feedback 3 Source Unit		
Option:	Function:	
		See parameter 20-02 Feedback 1 Source Unit for details.

20-12 Reference/Feedback Unit		
Option:	Function:	
		See parameter 20-02 Feedback 1 Source Unit for details.

20-13 Minimum Reference/Feedb.		
Range:		Function:
0 ProcessCtrlUnit*	[-999999.999 - par. 20-14 ProcessCtrlUnit]	Enter the desired minimum value for the remote reference when operating with <i>parameter 1-00 Configuration Mode</i> set for [3] <i>Closed Loop</i> operation. Units are set in <i>20-12 Reference/Feedback Unit</i> . Minimum feedback is -200% of either the value set in <i>parameter 20-13 Minimum Reference/Feedb.</i> or in <i>parameter 20-14 Maximum Reference/Feedb.</i> , which ever numeric value is the highest.

20-14 Maximum Reference/Feedb.		
Range:		Function:
100 ProcessCtrlUnit*	[par. 20-13 - 999999.999 ProcessCtrlUnit]	<p>NOTICE</p> <p>If operating with <i>parameter 1-00 Configuration Mode</i> set for [0] <i>Open Loop</i>, use <i>3-03 Maximum Reference</i>.</p> <p>NOTICE</p> <p>The dynamics of the PID controller depends on the value set in this parameter. See also <i>parameter 20-93 PID Proportional Gain</i>. <i>Parameter 20-13 Minimum Reference/Feedb.</i> and <i>parameter 20-14 Maximum Reference/Feedb.</i> also determine the feedback range when using feedback for display readout with <i>parameter 1-00 Configuration Mode</i> set for [0] <i>Open Loop</i>. Same condition as above.</p> <p>Enter the maximum reference/feedback for closed loop operation. The setting determines the highest value obtainable by summing all reference sources for closed loop operation. The setting determines 100% feedback in open and closed loop (total</p>

20-14 Maximum Reference/Feedb.		
Range:		Function:
		feedback range: -200% to +200%.

3.18.2 20-2* Feedback & Setpoint

This parameter group is used to determine how the frequency converter's PID controller uses the 3 possible feedback signals to control the output frequency of the frequency converter. This group is also used to store the 3 internal setpoint references.

20-20 Feedback Function		
Option:	Function:	
		This parameter determines how the 3 possible feedbacks are used to control the output frequency of the frequency converter.
[0]	Sum	<p>Sets up the PID controller to use the sum of feedback 1, feedback 2 and feedback 3 as the feedback.</p> <p>NOTICE</p> <p>Set any unused feedbacks to [0] <i>No Function</i> in</p> <ul style="list-style-type: none"> • <i>Parameter 20-00 Feedback 1 Source</i>. • <i>Parameter 20-03 Feedback 2 Source</i>. • <i>Parameter 20-06 Feedback 3 Source</i>. <p>The sum of setpoint 1 and any other references that are enabled (see parameter group 3-1* <i>References</i>) are used as the PID controller's setpoint reference.</p>
[1]	Difference	<p>Sets up the PID controller to use the difference between feedback 1 and feedback 2 as the feedback. Feedback 3 is not used with this selection. Only setpoint 1 is used. The sum of setpoint 1 and any other references that are enabled (see parameter group 3-1* <i>References</i>) are used as the PID controller's setpoint reference.</p>
[2]	Average	<p>Sets up the PID Controller to use the average of feedback 1, feedback 2 and feedback 3 as the feedback.</p>

20-20 Feedback Function	
Option:	Function:
	<p>NOTICE</p> <p>Set any unused feedbacks to [0] No Function in</p> <ul style="list-style-type: none"> Parameter 20-00 Feedback 1 Source. Parameter 20-03 Feedback 2 Source. Parameter 20-06 Feedback 3 Source. <p>The sum of setpoint 1 and any other references that are enabled (see parameter group 3-1* References) are used as the PID controller's setpoint reference.</p>
[3] *	<p>Minimum</p> <p>Sets up the PID controller to compare feedback 1, feedback 2, and feedback 3. The PID controller uses the lowest value as the feedback.</p> <p>NOTICE</p> <p>Set any unused feedbacks to [0] No Function in</p> <ul style="list-style-type: none"> Parameter 20-00 Feedback 1 Source Parameter 20-03 Feedback 2 Source Parameter 20-06 Feedback 3 Source <p>Only setpoint 1 is used. The sum of setpoint 1 and any other references that are enabled (see parameter group 3-1* References) are used as the PID controller's setpoint reference.</p>
[4]	<p>Maximum</p> <p>Sets up the PID controller to compare feedback 1, feedback 2 and feedback 3 and use the highest value as the feedback.</p> <p>NOTICE</p> <p>Set any unused feedbacks to [0] No Function in</p> <ul style="list-style-type: none"> Parameter 20-00 Feedback 1 Source. Parameter 20-03 Feedback 2 Source. Parameter 20-06 Feedback 3 Source. <p>Only setpoint 1 is used. The sum of setpoint 1 and any other references that are enabled (see</p>

20-20 Feedback Function	
Option:	Function:
	<p>parameter group 3-1* References) are used as the PID controller's setpoint reference.</p>
[5]	<p>Multi Setpoint Min</p> <p>Sets up the PID controller to calculate the difference between feedback 1 and setpoint 1, feedback 2 and setpoint 2, and feedback 3 and setpoint 3. It uses the feedback/setpoint pair in which the feedback is the farthest below its corresponding setpoint reference. If all feedback signals are above their corresponding setpoints, the PID controller uses the feedback/setpoint pair with the least difference between the 2.</p> <p>NOTICE</p> <p>If only 2 feedback signals are used, set the non-used feedback to [0] No Function in</p> <ul style="list-style-type: none"> Parameter 20-00 Feedback 1 Source. Parameter 20-03 Feedback 2 Source. Parameter 20-06 Feedback 3 Source. <p>Note that each setpoint reference is the sum of its respective parameter value (parameter 20-21 Setpoint 1, parameter 20-22 Setpoint 2 and parameter 20-23 Setpoint 3) and any other references that are enabled (see parameter group 3-1* References).</p>
[6]	<p>Multi Setpoint Max</p> <p>Sets up the PID controller to calculate the difference between feedback 1 and setpoint 1, feedback 2 and setpoint 2, and feedback 3 and setpoint 3. It uses the feedback/setpoint pair in which the feedback is farthest above its corresponding setpoint reference. If all feedback signals are below their corresponding setpoints, the PID controller uses the feedback/setpoint pair with the least difference between the 2.</p>

20-20 Feedback Function	
Option:	Function:
	<p>NOTICE</p> <p>If only 2 feedback signals are used, set the non-used feedback to [0] No Function in</p> <ul style="list-style-type: none"> • <i>Parameter 20-00 Feedback 1 Source.</i> • <i>Parameter 20-03 Feedback 2 Source.</i> • <i>Parameter 20-06 Feedback 3 Source.</i> <p>Note that each setpoint reference is the sum of its respective parameter value (<i>parameter 20-21 Setpoint 1, parameter 20-22 Setpoint 2 and parameter 20-23 Setpoint 3</i>) and any other references that are enabled (see parameter group 3-1* <i>References</i>).</p>

NOTICE

Set any unused feedback to [0] No function in

- *Parameter 20-00 Feedback 1 Source.*
- *Parameter 20-03 Feedback 2 Source.*
- *Parameter 20-06 Feedback 3 Source.*

The PID controller uses the feedback resulting from the function selected in *parameter 20-20 Feedback Function* to control the output frequency of the frequency converter. This feedback can also:

- Be shown on the frequency converter's display.
- Be used to control a frequency converter's analog output.
- Be transmitted over various serial communication protocols.

The frequency converter can be configured to handle multi-zone applications. 2 different multi-zone applications are supported:

- Multi-zone, single setpoint
- Multi-zone, multi-setpoint

Examples 1 and 2 illustrate the difference between the 2:

Example 1 – Multi-zone, single setpoint

In an office building, a VAV (variable air volume) VLT® HVAC Drive system must ensure a minimum pressure at selected VAV boxes. Due to the varying pressure losses in each duct, the pressure at each VAV box cannot be assumed to be the same. The minimum pressure required

is the same for all VAV boxes. This control method can be set up by setting *parameter 20-20 Feedback Function* to [3] *Minimum*, and entering the desired pressure in *parameter 20-21 Setpoint 1*. If any feedback is below the setpoint, the PID controller increases the fan speed. If all feedbacks are above the setpoint, the PID controller decreases the fan speed.

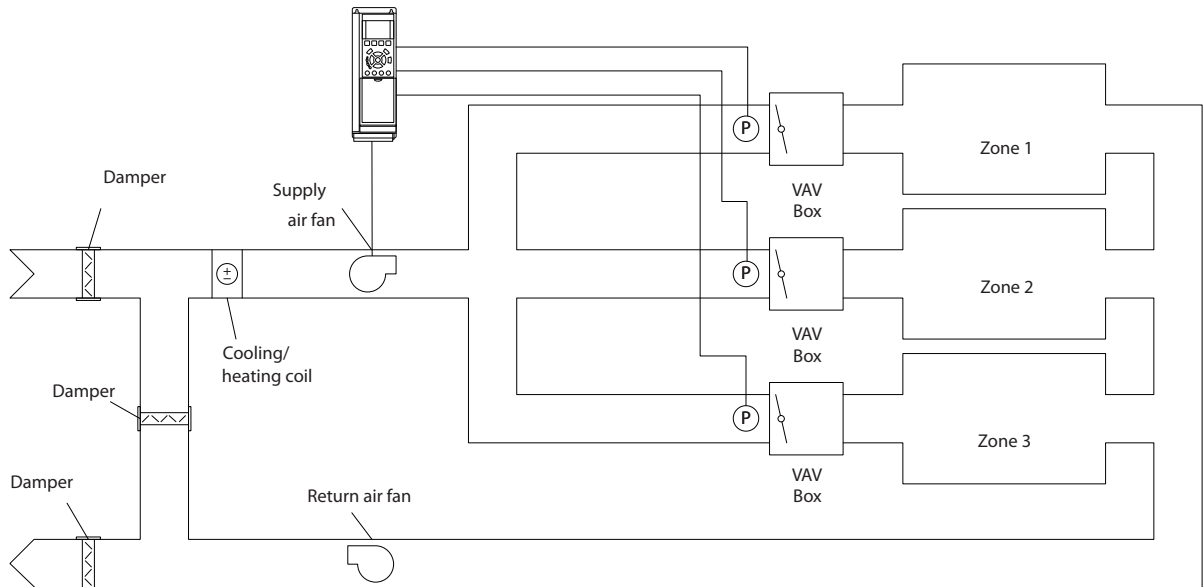

130BA353.10

Illustration 3.48 Example, Multi-zone, Single Setpoint

Example 2 – Multi-zone, multi-setpoint

The previous example illustrates the use of multi-zone, multi-setpoint control. If the zones require different pressures for each VAV box, each setpoint may be specified in

- *Parameter 20-21 Setpoint 1.*
- *Parameter 20-22 Setpoint 2.*
- *Parameter 20-23 Setpoint 3.*

By selecting [5] *Multi-setpoint minimum* in *parameter 20-20 Feedback Function*, the PID controller increases the fan speed if any one of the feedbacks is below its setpoint. If all feedbacks are above their individual setpoints, the PID controller decreases the fan speed.

20-21 Setpoint 1		
Range:	Function:	
0 ProcessCtrlUnit*	[-999999.999 - 999999.999 ProcessCtrlUnit]	Setpoint 1 is used in closed-loop mode to enter a setpoint reference that is used by the frequency converter's PID controller. See the description of <i>parameter 20-20 Feedback Function</i> .
<p>NOTICE</p> <p>The setpoint reference entered here is added to any other references that are enabled (see <i>parameter group 3-1* References</i>).</p>		

20-22 Setpoint 2		
Range:	Function:	
0 ProcessCtrlUnit*	[-999999.999 - 999999.999 ProcessCtrlUnit]	Setpoint 2 is used in closed-loop mode to enter a setpoint reference that may be used by the frequency converter's PID controller. See the description of <i>parameter 20-20 Feedback Function</i> . NOTICE The setpoint reference entered here is added to any other references that are enabled (see parameter group 3-1* References).

20-23 Setpoint 3		
Range:	Function:	
0 ProcessCtrlUnit*	[-999999.999 - 999999.999 ProcessCtrlUnit]	Setpoint 3 is used in Closed Loop Mode to enter a setpoint reference that may be used by the frequency converter's PID Controller. See the description of <i>parameter 20-20 Feedback Function</i> . NOTICE The setpoint reference entered here is added to any other references that are enabled (see parameter group 3-1*).

20-30 Refrigerant		
Option:	Function:	
		<i>parameter 20-31 User Defined Refrigerant A1</i> , <i>parameter 20-32 User Defined Refrigerant A2</i> and <i>parameter 20-33 User Defined Refrigerant A3</i> to provide A1, A2 and A3 for the equation below: $\text{Temperature} = \frac{A2}{(\ln(Pe + 1) - A1)} - A3$
[0] *	R22	
[1]	R134a	
[2]	R404A	
[3]	R407C	
[4]	R410A	
[5]	R502	
[6]	R744	
[7]	User defined	

20-31 User Defined Refrigerant A1		
Range:	Function:	
10*	[8 - 12]	Use this parameter to enter the value of coefficient A1 when <i>parameter 20-30 Refrigerant</i> is set to [7] <i>User defined</i> .

20-32 User Defined Refrigerant A2		
Range:	Function:	
-2250*	[-3000 - -1500]	Use this parameter to enter the value of coefficient A2 when <i>parameter 20-30 Refrigerant</i> is set to [7] <i>User defined</i> .

20-33 User Defined Refrigerant A3		
Range:	Function:	
250*	[200 - 300]	Use this parameter to enter the value of coefficient A3 when <i>parameter 20-30 Refrigerant</i> is set to [7] <i>User defined</i> .

3.18.3 20-3* Feedback Adv. Conversion

In air conditioning compressor applications it is often useful to control the system based on the temperature of the refrigerant. However, it is generally more convenient to directly measure its pressure. This parameter group allows the frequency converter's PID Controller to convert refrigerant pressure measurements into temperature values.

20-30 Refrigerant		
Option:	Function:	
		Select the refrigerant used in the compressor application. This parameter must be specified correctly for the pressure to temperature conversion to be accurate. If the refrigerant used is not listed in options [0] through [6], select [7] <i>User defined</i> . Then, use

20-34 Duct 1 Area [m2]		
Range:	Function:	
0.500 m2*	[0.001 - 10 m2]	Used for setting the area of the air ducts in connection with feedback conversion pressure/velocity to flow. The unit (m ²) is determined by the setting of <i>parameter 0-03 Regional Settings</i> . Fan 1 is used with feedback 1. In case of flow difference control, set <i>parameter 20-20 Feedback Function</i> to [1] <i>Difference</i> , if flow fan 1 – flow fan 2 is to be controlled.

20-35 Duct 1 Area [in2]		
Range:	Function:	
750 in2*	[1 - 15500 in2]	Used for setting the area of the air ducts in connection with feedback conversion pressure/velocity to flow. The unit (in ²) is determined by

20-35 Duct 1 Area [in ²]		
Range:		Function:
		the setting of <i>parameter 0-03 Regional Settings</i> . Fan 1 is used with feedback 1. In case of flow difference control, set <i>parameter 20-20 Feedback Function</i> to [1] Difference, if flow fan 1 – flow fan 2 is to be controlled.

20-36 Duct 2 Area [m ²]		
Range:		Function:
0.500 m ² *	[0.001 - 10 m ²]	Used for setting the area of the air ducts in connection with feedback conversion pressure/velocity to flow. The unit (m ²) is determined by the setting of <i>parameter 0-03 Regional Settings</i> . Fan 2 is used with feedback 2. In case of flow difference control, set <i>parameter 20-20 Feedback Function</i> to [1] Difference, if flow fan 1 – flow fan 2 is to be controlled.

20-37 Duct 2 Area [in ²]		
Range:		Function:
750 in ² *	[1 - 15500 in ²]	Used for setting the area of the air ducts in connection with feedback conversion pressure/velocity to flow. The unit (in ²) is determined by the setting of <i>parameter 0-03 Regional Settings</i> . Fan 2 is used with feedback 2. In case of flow difference control, set <i>parameter 20-20 Feedback Function</i> to [1] Difference, if flow fan 1 – flow fan 2 is to be controlled.

20-38 Air Density Factor [%]		
Range:		Function:
100 %*	[50 - 150 %]	Set the air density factor for conversion from pressure to flow in % relative to the air density at sea level at 20 °C (100% ~ 1,2 kg/m ³).

3.18.4 20-6* Sensorless

Parameters for Sensorless. See also

- *Parameter 20-00 Feedback 1 Source*
- *Parameter 18-50 Sensorless Readout [unit]*
- *Parameter 16-26 Power Filtered [kW]*
- *Parameter 16-27 Power Filtered [hp]*

NOTICE

Sensorless unit and sensorless information require set-up by MCT 10 Set-up Software with sensorless specific plug in.

20-60 Sensorless Unit		
Option:		Function:
		Select the unit to be used with <i>parameter 18-50 Sensorless Readout [unit]</i> .
[20]	l/s	
[21]	l/min	
[22]	l/h	
[23]	m ³ /s	
[24]	m ³ /min	
[25]	m ³ /h	
[70]	mbar	
[71]	bar	
[72]	Pa	
[73]	kPa	
[74]	m WG	
[75]	mm Hg	
[120]	GPM	
[121]	gal/s	
[122]	gal/min	
[123]	gal/h	
[124]	CFM	
[125]	ft ³ /s	
[126]	ft ³ /min	
[127]	ft ³ /h	
[170]	psi	
[171]	lb/in ²	
[172]	in WG	
[173]	ft WG	
[174]	in Hg	

20-69 Sensorless Information		
Range:		Function:
0*	[0 - 25]	View information about the sensorless data.

3.18.5 20-7* PID Auto Tuning

The frequency converter PID closed-loop controller (parameter group 20-**, *FC Drive Closed Loop*) can be auto-tuned, simplifying and saving time during commissioning, while ensuring accurate PID control adjustment. To use auto-tuning, configure for the frequency converter for closed loop in *parameter 1-00 Configuration Mode*.

Use a graphical local control panel (GLCP) to react to messages during the auto-tuning sequence.

Enabling *parameter 20-79 PID Autotuning* puts the frequency converter into auto-tuning mode. The LCP then on-screen instructions.

To start the fan/pump, press [Auto On] and apply a start signal. Adjust the speed manually by pressing [▲] or [▼] to a level where the feedback is around the system set-point.

NOTICE

It is not possible to run the motor at maximum or minimum speed, when manually adjusting the motor speed due to the need of giving the motor a step in the speed during auto-tuning.

PID auto-tuning functions by introducing step changes while operating at a steady state and then monitoring the feedback. From the feedback response, the required values for *parameter 20-93 PID Proportional Gain* and *parameter 20-94 PID Integral Time* are calculated. *Parameter 20-95 PID Differentiation Time* is set to value 0 (zero). *Parameter 20-81 PID Normal/ Inverse Control* is determined during the tuning process.

These calculated values are presented in the LCP and can be either accepted or rejected. Once accepted, the values are written to the relevant parameters and auto-tuning mode is disabled in *parameter 20-79 PID Autotuning*. Depending on the system the time required to carry out auto-tuning could be several minutes. Before carrying out the PID auto tuning, set the following parameters according to the load inertia:

- *Parameter 3-41 Ramp 1 Ramp Up Time.*
- *Parameter 3-42 Ramp 1 Ramp Down Time.*

or

- *Parameter 3-51 Ramp 2 Ramp Up Time.*
- *Parameter 3-52 Ramp 2 Ramp Down Time.*

according to the load inertia before carrying out PID autotuning. If PID autotuning is carried out with slow ramp times, the auto-tuned parameters typically results in very slow control. Before activating PID auto tuning remove excessive feedback sensor noise using the input filter (parameter groups 6-** *Analog In/Out*, 5-5* *Pulse Input*, and 26-** *Analog I/O Option MCB 109*, Terminal 53/54 Filter Time Constant/Pulse Filter Time Constant #29/33) before activating PID autotuning. To obtain the most accurate controller parameters, carry out PID autotuning when the application runs in typical operation, that is with a typical load.

20-70 Closed Loop Type		
Option:	Function:	
		Select the application response speed if it is known. The default setting is sufficient for most applications. A more precise value decreases the time needed for carrying out PID adaptation. The setting has no impact on values of parameters and only affects the auto-tuning speed.
[0] *	Auto	Takes 30–60 s to complete.
[1]	Fast Pressure	Takes 10–20 s to complete.
[2]	Slow Pressure	Takes 30–60 s to complete.

20-70 Closed Loop Type		
Option:	Function:	
[3]	Fast Temperature	Takes 10–20 min to complete.
[4]	Slow Temperature	Takes 30–60 min to complete.

20-71 PID Performance		
Option:	Function:	
[0] *	Normal	Normal setting of this parameter is suitable for pressure control in fan systems.
[1]	Fast	Fast setting is used in pumping systems, where a faster control response is wanted.

20-72 PID Output Change		
Range:	Function:	
0.10*	[0.01 - 0.50]	This parameter sets the magnitude of step change during autotuning. The value is a percentage of full speed. I.e. if maximum output frequency in <i>parameter 4-13 Motor Speed High Limit [RPM]</i> / <i>parameter 4-14 Motor Speed High Limit [Hz]</i> is set to 50 Hz, 0.10 is 10% of 50 Hz, which is 5 Hz. This parameter should be set to a value resulting in feedback changes of between 10% and 20% for best tuning accuracy.

20-73 Minimum Feedback Level		
Range:	Function:	
-999999 ProcessCtrlUnit*	[-999999.999 - par. 20-74 ProcessCtrlUnit]	Enter the minimum allowable feedback level in user units as defined in <i>20-12 Reference/ Feedback Unit</i> . If the level drops below <i>parameter 20-73 Minimum Feedback Level</i> , auto tuning is aborted and an error message appears in the LCP.

20-74 Maximum Feedback Level		
Range:	Function:	
999999 ProcessCtrlUnit*	[par. 20-73 - 999999.999 ProcessCtrlUnit]	Enter the maximum allowable feedback level in user units as defined in <i>20-12 Reference/ Feedback Unit</i> . If the level rises above <i>parameter 20-74 Maximum Feedback Level</i> , auto tuning is aborted and an error message appears in the LCP.

20-79 PID Autotuning		
Option:	Function:	
		This parameter starts the PID autotuning sequence. Once the autotuning has successfully completed and the settings have been accepted

20-79 PID Autotuning		
Option:	Function:	
		or rejected by the user, by pressing [OK] or [Cancel] at the end of tuning, this parameter is reset to [0] Disabled.
[0] *	Disabled	
[1]	Enabled	

3.18.6 20-8* PID Basic Settings

This parameter group is used to configure the basic operation of the frequency converter's PID controller, including how it responds to a feedback that is above or below the setpoint, the speed at which it first starts functioning, and when it indicates that the system has reached the setpoint.

20-81 PID Normal/ Inverse Control		
Option:	Function:	
[0] *	Normal	The frequency converter's output frequency decreases when the feedback is greater than the setpoint reference. This behaviour is common for pressure-controlled supply fan and pump applications.
[1]	Inverse	The frequency converter's output frequency increases when the feedback is greater than the setpoint reference. This behaviour is common for temperature-controlled cooling applications, such as cooling towers.

20-82 PID Start Speed [RPM]		
Range:	Function:	
Size related* [0 - par. 4-13 RPM]		When the frequency converter is first started, it initially ramps up to this output speed in open-loop mode, following the active ramp-up time. When the output speed programmed is reached, the frequency converter automatically switches to closed-loop mode and the PID controller begins to function. This is useful in applications that require quick acceleration to a minimum speed at start-up.
		NOTICE This parameter is only visible if parameter 0-02 Motor Speed Unit is set to [0] RPM.

20-83 PID Start Speed [Hz]		
Range:	Function:	
Size related* [0 - par. 4-14 Hz]		When the frequency converter is first started, it initially ramps up to this output frequency in open-loop mode, following

20-83 PID Start Speed [Hz]		
Range:	Function:	
		the active ramp-up time. When the output frequency programmed is reached, the frequency converter automatically switches to closed-loop mode and the PID controller begins to function. This is useful in applications that require quick acceleration to a minimum speed at start-up.
		NOTICE This parameter is only visible if parameter 0-02 Motor Speed Unit is set to [1] Hz.

20-84 On Reference Bandwidth		
Range:	Function:	
5 %* [0 - 200 %]		When the difference between the feedback and the setpoint reference is less than the value of this parameter, the frequency converter's display shows <i>Run on Reference</i> . This status can be communicated externally by programming the function of a digital output for [8] <i>Run on Reference/No Warning</i> . In addition, for serial communications, the <i>On Reference</i> status bit of the frequency converter's status word is high (1). The <i>On Reference Bandwidth</i> is calculated as a percentage of the setpoint reference.

3.18.7 20-9* PID Controller

This group provides the ability to manually adjust the PID controller. By adjusting the PID controller parameters, the control performance may be improved. See the *VLT® HVAC Drive FC 102 Design Guide*, for guidelines on adjusting the PID controller parameters.

20-91 PID Anti Windup		
Option:	Function:	
[0]	Off	The integrator continues to change value also after output has reached 1 of the extremes. This can afterwards cause a delay of change of the output of the controller.
[1] *	On	The integrator is locked if the output of the built-in PID controller has reached 1 of the extremes (minimum or maximum value) and therefore is not able to add further changes to the value of the process parameter controlled. This allows the controller to respond more quickly when it can control the system again.

20-93 PID Proportional Gain	
Range:	Function:
0.50* [0 - 10]	<p>NOTICE</p> <p>Always set the desired value for <i>parameter 20-14 Maximum Reference/Feedb.</i> before setting the values for the PID controller in parameter group 20-9* PID Controller.</p> <p>The proportional gain indicates the number of times the error between the setpoint and the feedback signal is to be applied.</p>

If (Error x Gain) jumps with a value equal to what is set in *parameter 20-14 Maximum Reference/Feedb.*, the PID controller tries to change the output speed equal to what is set in *parameter 4-13 Motor Speed High Limit [RPM]/parameter 4-14 Motor Speed High Limit [Hz]*. However, the output speed is limited by this setting. The proportional band (error causing output to change from 0–100%) can be calculated with the formula:

$$\left(\frac{1}{\text{Proportional Gain}} \right) \times (\text{Max Reference})$$

20-94 PID Integral Time	
Range:	Function:
20 s* [0.01 - 10000 s]	<p>The integrator accumulates a contribution to the output from the PID controller as long as there is a deviation between the reference/setpoint and feedback signals. The contribution is proportional to the size of the deviation. This ensures that the deviation (error) approaches zero.</p> <p>Quick response on any deviation is obtained when the integral time is set to a low value. Setting it too low, however, may cause the control to become unstable.</p> <p>The value set is the time needed for the integrator to add the same contribution as the proportional for a certain deviation.</p> <p>If the value is set to 10000, the controller acts as a pure proportional controller with a P-band based on the value set in <i>parameter 20-93 PID Proportional Gain</i>. When no deviation is present, the output from the proportional controller is 0.</p>

20-95 PID Differentiation Time	
Range:	Function:
0 s* [0 - 10 s]	<p>The differentiator monitors the rate of change of the feedback. If the feedback is changing quickly, it adjusts the output of the PID Controller to reduce the rate of change of the feedback. Quick PID Controller response is obtained when this value is large. However, if too large of a value is used, the frequency converter's output frequency may become unstable.</p>

20-95 PID Differentiation Time	
Range:	Function:
	<p>Differentiation time is useful in situations where extremely fast frequency converter response and precise speed control are required. It can be difficult to adjust this for proper system control. Differentiation time is not commonly used in HVAC applications. Therefore, it is best to leave this parameter at 0 or OFF.</p>

20-96 PID Diff. Gain Limit	
Range:	Function:
5* [1 - 50]	<p>The differential function of a PID controller responds to the rate of change of the feedback. As a result, an abrupt change in the feedback can cause the differential function to make a very large change in the PID controller's output. This parameter limits the maximum effect that the PID controller's differential function can produce. A smaller value reduces the maximum effect of the PID controller's differential function.</p> <p>This parameter is only active when <i>parameter 20-95 PID Differentiation Time</i> is not set to OFF (0 s).</p>

3.19 Parameters: 21-** Main Menu - Extended Closed Loop

The FC 102 offers 3 extended closed-loop PID controllers in addition to the PID controller. These can be configured independently to control either external actuators (valves, dampers and so on.) or be used with the internal PID controller to improve the dynamic responses to setpoint changes or load disturbances.

The extended closed-loop PID controllers may be interconnected or connected to the PID closed-loop controller to form a dual loop configuration.

To control a modulating device (for example a valve motor), this device must be a positioning servo motor with built-in electronics accepting either a 0-10 V (signal from analog I/O card MCB 109) or a 0/4–20 mA (signal from control card and/or general purpose I/O card MCB 101) control signal.

The output function can be programmed in the following parameters:

- Control card, terminal 42: *Parameter 6-50 Terminal 42 Output* (setting [113]...[115] or [149]...[151], Ext. Closed Loop 1/2/3
- General purpose I/O card MCB 101, terminal X30/8: *Parameter 6-60 Terminal X30/8 Output*, (setting [113]...[115] or [149]...[151], Ext. Closed Loop 1/2/3
- Analog I/O card MCB 109, terminal X42/7...11: *Parameter 26-40 Terminal X42/7 Output*, *parameter 26-50 Terminal X42/9 Output*, *parameter 26-60 Terminal X42/11 Output* (setting [113]...[115], Ext. Closed Loop 1/2/3

General purpose I/O card and analog I/O card are optional cards.

3.19.1 21-0* Extended CL Autotuning

The extended closed-loop PID controllers can each be autotuned, simplifying and saving time during commissioning, while ensuring accurate PID control adjustment.

To use PID auto tuning, configure for the relevant extended PID controller for the application.

Use a graphical LCP to react on messages during the auto-tuning sequence.

Enabling auto tuning, *parameter 21-09 PID Autotuning* puts the relevant PID controller into PID autotuning mode. The LCP then provides on-screen instructions.

PID auto tuning functions by introducing step changes and then monitoring the feedback. Based on the feedback response, the following required values are calculated:

- PID proportional gain.
 - *Parameter 21-21 Ext. 1 Proportional Gain* for EXT CL 1.
 - *Parameter 21-41 Ext. 2 Proportional Gain* for EXT CL 2.
 - *Parameter 21-61 Ext. 3 Proportional Gain* for EXT CL 3.
- Integral time.
 - *Parameter 21-22 Ext. 1 Integral Time* for EXT CL 1.
 - *Parameter 21-42 Ext. 2 Integral Time* for EXT CL 2.
 - *Parameter 21-62 Ext. 3 Integral Time* for EXT CL 3 are calculated.

The PID differentiation time is set to 0 in the following parameters:

- *Parameter 21-23 Ext. 1 Differentiation Time* for EXT CL 1.
- *Parameter 21-43 Ext. 2 Differentiation Time* for EXT CL 2 .
- *Parameter 21-63 Ext. 3 Differentiation Time* for EXT CL 3 are set to value 0 (zero).
- *Parameter 21-20 Ext. 1 Normal/Inverse Control* for EXT CL 1.
- *Parameter 21-40 Ext. 2 Normal/Inverse Control* for EXT CL 2.
- *Parameter 21-60 Ext. 3 Normal/Inverse Control* for EXT CL 3 are determined during the tuning process.

These calculated values are presented on the LCP and can either be accepted or rejected. Once accepted, the values are written to the relevant parameters and PID autotuning mode is disabled in *parameter 21-09 PID Autotuning*. Depending on the system being controlled, the time required to carry out PID auto tuning could be several minutes.

Before activating the PID auto tuning, remove excessive feedback sensor noise using the input filter (parameter groups 5-5* *Pulse Input*, 6-** *Analog In/Out*, and 26-** *Analog I/O Option MCB 109*, Terminal 53/54 Filter Time Constant/Pulse Filter Time Constant #29/33) before activating PID autotuning.

21-00 Closed Loop Type		
Option:	Function:	
		This parameter defines the application response. The default mode should be sufficient for most applications. If the relative application speed is known, it can be selected here. This decreases the time needed for carrying out PID autotuning. The setting has no impact on the value of the tuned parameters and is used only for the PID autotuning sequence.
[0] *	Auto	
[1]	Fast Pressure	
[2]	Slow Pressure	
[3]	Fast Temperature	
[4]	Slow Temperature	

21-01 PID Performance		
Option:	Function:	
[0] *	Normal	Normal setting of this parameter is suitable for pressure control in fan systems.
[1]	Fast	Fast setting would generally be used in pumping systems, where a faster control response is desirable.

21-02 PID Output Change		
Range:	Function:	
0.10*	[0.01 - 0.50]	This parameter sets the magnitude of step change during auto tuning. The value is a percentage of full operating range. That is if the maximum analog output voltage is set to 10 V, 0.10 is 10% of 10 V, which is 1 V. Set this parameter to a value resulting in feedback changes of between 10% and 20% for best tuning accuracy.

21-03 Minimum Feedback Level		
Range:	Function:	
-999999*	[-999999.999 - par. 21-04]	Enter the minimum allowable feedback level in user units as defined in <ul style="list-style-type: none"> Parameter 21-10 Ext. 1 Ref./ Feedback Unit for EXT CL 1. Parameter 21-30 Ext. 2 Ref./ Feedback Unit for EXT CL 2. Parameter 21-50 Ext. 3 Ref./ Feedback Unit for EXT CL 3. If the level drops below parameter 21-03 Minimum Feedback Level, PID auto tuning is aborted and an error message appears in the display.

21-04 Maximum Feedback Level		
Range:	Function:	
999999*	[par. 21-03 - 999999.999]	Enter the maximum allowable feedback level in user units as defined in <ul style="list-style-type: none"> Parameter 21-10 Ext. 1 Ref./ Feedback Unit for EXT CL 1. Parameter 21-30 Ext. 2 Ref./ Feedback Unit for EXT CL 2. Parameter 21-50 Ext. 3 Ref./ Feedback Unit for EXT CL 3. If the level rises above parameter 21-04 Maximum Feedback Level, PID auto tuning is aborted and an error message appears in the display.

21-09 PID Autotuning		
Option:	Function:	
		This parameter enables selection of the extended PID controller to be auto-tuned and starts the PID auto tuning for that controller. Once the auto tuning has successfully completed and the settings have been accepted or rejected by pressing [OK] or [Cancel] at the end of tuning, this parameter is reset to [0] Disabled.
[0] *	Disabled	
[1]	Enabled Ext CL1 PID	
[2]	Enabled Ext CL 2 PID	
[3]	Enabled Ext CL 3 PID	

3.19.2 21-1* Closed Loop 1 Ref/Feedback

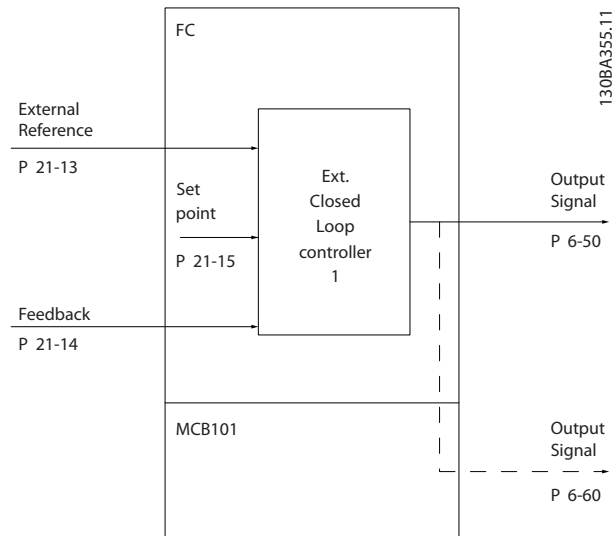

Illustration 3.49 Closed Loop 1 Ref/Feedback

21-10 Ext. 1 Ref./Feedback Unit	
Option:	Function:
	Select the unit for the reference and feedback.
[0]	None
[1] *	%
[5]	PPM
[10]	1/min
[11]	RPM
[12]	Pulse/s
[20]	l/s
[21]	l/min
[22]	l/h
[23]	m ³ /s
[24]	m ³ /min
[25]	m ³ /h
[30]	kg/s
[31]	kg/min
[32]	kg/h
[33]	t/min
[34]	t/h
[40]	m/s
[41]	m/min
[45]	m
[60]	°C
[70]	mbar
[71]	bar
[72]	Pa
[73]	kPa
[74]	m WG
[75]	mm Hg
[80]	kW
[120]	GPM
[121]	gal/s

21-10 Ext. 1 Ref./Feedback Unit	
Option:	Function:
[122]	gal/min
[123]	gal/h
[124]	CFM
[125]	ft ³ /s
[126]	ft ³ /min
[127]	ft ³ /h
[130]	lb/s
[131]	lb/min
[132]	lb/h
[140]	ft/s
[141]	ft/min
[145]	ft
[160]	°F
[170]	psi
[171]	lb/in ²
[172]	in WG
[173]	ft WG
[174]	in Hg
[180]	HP

21-11 Ext. 1 Minimum Reference		
Range:	Function:	
0 ExtPID1Unit*	[-999999.999 - par. 21-12 ExtPID1Unit]	Select the minimum reference for the closed loop 1 controller.

21-12 Ext. 1 Maximum Reference		
Range:	Function:	
100 ExtPID1Unit*	[par. 21-11 - 999999.999 ExtPID1Unit]	<p>NOTICE</p> <p>Always set the desired value for parameter 21-12 Ext. 1 Maximum Reference before setting the values for the PID controller in parameter group 20-9* PID Controller.</p> <p>Select the maximum reference for the closed loop 1 controller.</p> <p>The dynamics of the PID controller depend on the value set in this parameter. See also parameter 21-21 Ext. 1 Proportional Gain.</p>

21-13 Ext. 1 Reference Source		
Option:	Function:	
		This parameter defines which input on the frequency converter that should be treated as the source of the reference signal for the closed loop 1 controller. Analog input X30/11 and analog input X30/12 refer to inputs on the general purpose I/O.
[0] *	No function	
[1]	Analog Input 53	
[2]	Analog Input 54	
[7]	Pulse input 29	
[8]	Pulse input 33	
[20]	Digital pot.meter	
[21]	Analog input X30/11	
[22]	Analog input X30/12	
[23]	Analog Input X42/1	
[24]	Analog Input X42/3	
[25]	Analog Input X42/5	
[29]	Analog Input X48/2	
[30]	Ext. Closed Loop 1	
[31]	Ext. Closed Loop 2	
[32]	Ext. Closed Loop 3	

21-14 Ext. 1 Feedback Source		
Option:	Function:	
		This parameter defines which input on the frequency converter should be treated as the source of the feedback signal for the closed loop 1 controller. Analog input X30/11 and analog input X30/12 refer to inputs on the general purpose I/O.
[0] *	No function	
[1]	Analog Input 53	
[2]	Analog Input 54	
[3]	Pulse input 29	
[4]	Pulse input 33	
[7]	Analog Input X30/11	
[8]	Analog Input X30/12	
[9]	Analog Input X42/1	
[10]	Analog Input X42/3	
[11]	Analog Input X42/5	
[15]	Analog Input X48/2	
[100]	Bus Feedback 1	
[101]	Bus Feedback 2	
[102]	Bus feedback 3	
[104]	Sensorless Flow	
[105]	Sensorless Pressure	

21-15 Ext. 1 Setpoint		
Range:	Function:	
0 ExtPID1Unit*	[par. 21-11 - par. 21-12 ExtPID1Unit]	The setpoint reference is used in extended 1 closed loop. Ext.1 Setpoint is added to the value from the Ext.1 Reference source selected in <i>parameter 21-13 Ext. 1 Reference Source</i> .

21-17 Ext. 1 Reference [Unit]		
Range:	Function:	
0 ExtPID1Unit*	[-999999.999 - 999999.999 ExtPID1Unit]	Readout of the reference value for the closed loop 1 controller.

21-18 Ext. 1 Feedback [Unit]		
Range:	Function:	
0 ExtPID1Unit*	[-999999.999 - 999999.999 ExtPID1Unit]	Readout of the feedback value for the closed loop 1 controller.

21-19 Ext. 1 Output [%]		
Range:	Function:	
0 %*	[0 - 100 %]	Readout of the output value for the closed loop 1 controller.

3.19.3 21-2* Closed Loop 1 PID

21-20 Ext. 1 Normal/Inverse Control		
Option:	Function:	
[0] *	Normal	Reduces the output when feedback is higher than the reference.
[1]	Inverse	Increase the output when feedback is higher than the reference.

21-21 Ext. 1 Proportional Gain		
Range:	Function:	
0.01* [0 - 10]		<p>NOTICE</p> <p>Always set <i>parameter 20-14 Maximum Reference/Feedb.</i> before setting the values for the PID controller in parameter group 20-9* PID Controller.</p> <p>The proportional gain indicates the number of times the error between the setpoint and the feedback signal is to be applied.</p>

If (Error x Gain) jumps with a value equal to what is set in *parameter 20-14 Maximum Reference/Feedb.*, the PID controller tries to change the output speed equal to what is set in *parameter 4-13 Motor Speed High Limit [RPM]*/*parameter 4-14 Motor Speed High Limit [Hz]*. However, the output speed is limited by this setting.

The proportional band (error causing output to change from 0–100%) can be calculated with the formula

$$\left(\frac{1}{\text{Proportional Gain}}\right) \times (\text{Max Reference})$$

21-22 Ext. 1 Integral Time		
Range:	Function:	
10000 s*	[0.01 - 10000 s]	Over time, the integrator accumulates a contribution to the output from the PID controller as long as there is a deviation between the reference/setpoint and feedback signals. The contribution is proportional to the size of the deviation. This ensures that the deviation (error) approaches zero. Quick response on any deviation is obtained when the integral time is set to a low value. Setting it too low, however, may cause the control to become unstable. The value set is the time needed for the integrator to add the same contribution as the proportional for a certain deviation. If the value is set to 10000, the controller acts as a pure proportional controller with a P-band based on the value set in <i>parameter 20-93 PID Proportional Gain</i> . When no deviation is present, the output from the proportional controller is 0.

21-23 Ext. 1 Differentiation Time		
Range:	Function:	
0 s*	[0 - 10 s]	The differentiator does not react to a constant error. It only provides a gain when the feedback changes. The quicker the feedback changes, the stronger the gain from the differentiator.

21-24 Ext. 1 Dif. Gain Limit		
Range:	Function:	
5*	[1 - 50]	Set a limit for the differentiator gain (DG). The DG increases if there are fast changes. Limit the DG to obtain a pure differentiator gain at slow changes and a constant differentiator gain where quick changes occur.

3.19.4 21-3* Closed Loop 2 Ref/Fb

21-30 Ext. 2 Ref./Feedback Unit		
Option:	Function:	
		See <i>parameter 21-10 Ext. 1 Ref./Feedback Unit</i> for details.
[0]	None	
[1] *	%	
[5]	PPM	
[10]	1/min	
[11]	RPM	

21-30 Ext. 2 Ref./Feedback Unit		
Option:	Function:	
[12]	Pulse/s	
[20]	l/s	
[21]	l/min	
[22]	l/h	
[23]	m ³ /s	
[24]	m ³ /min	
[25]	m ³ /h	
[30]	kg/s	
[31]	kg/min	
[32]	kg/h	
[33]	t/min	
[34]	t/h	
[40]	m/s	
[41]	m/min	
[45]	m	
[60]	°C	
[70]	mbar	
[71]	bar	
[72]	Pa	
[73]	kPa	
[74]	m WG	
[75]	mm Hg	
[80]	kW	
[120]	GPM	
[121]	gal/s	
[122]	gal/min	
[123]	gal/h	
[124]	CFM	
[125]	ft ³ /s	
[126]	ft ³ /min	
[127]	ft ³ /h	
[130]	lb/s	
[131]	lb/min	
[132]	lb/h	
[140]	ft/s	
[141]	ft/min	
[145]	ft	
[160]	°F	
[170]	psi	
[171]	lb/in ²	
[172]	in WG	
[173]	ft WG	
[174]	in Hg	
[180]	HP	

21-31 Ext. 2 Minimum Reference		
Range:	Function:	
0 ExtPID2Unit*	[-999999.999 - par. 21-32 ExtPID2Unit]	See <i>parameter 21-11 Ext. 1 Minimum Reference</i> for details.

21-32 Ext. 2 Maximum Reference		
Range:	Function:	
100 ExtPID2Unit*	[par. 21-31 - 999999.999 ExtPID2Unit]	See <i>parameter 21-12 Ext. 1 Maximum Reference</i> for details.

21-33 Ext. 2 Reference Source		
Option:	Function:	
		See <i>parameter 21-13 Ext. 1 Reference Source</i> for details.
[0] *	No function	
[1]	Analog Input 53	
[2]	Analog Input 54	
[7]	Pulse input 29	
[8]	Pulse input 33	
[20]	Digital pot.meter	
[21]	Analog input X30/11	
[22]	Analog input X30/12	
[23]	Analog Input X42/1	
[24]	Analog Input X42/3	
[25]	Analog Input X42/5	
[29]	Analog Input X48/2	
[30]	Ext. Closed Loop 1	
[31]	Ext. Closed Loop 2	
[32]	Ext. Closed Loop 3	

21-34 Ext. 2 Feedback Source		
Option:	Function:	
		See <i>parameter 21-14 Ext. 1 Feedback Source</i> for details.
[0] *	No function	
[1]	Analog Input 53	
[2]	Analog Input 54	
[3]	Pulse input 29	
[4]	Pulse input 33	
[7]	Analog Input X30/11	
[8]	Analog Input X30/12	
[9]	Analog Input X42/1	
[10]	Analog Input X42/3	
[11]	Analog Input X42/5	
[15]	Analog Input X48/2	
[100]	Bus Feedback 1	
[101]	Bus Feedback 2	
[102]	Bus feedback 3	
[104]	Sensorless Flow	
[105]	Sensorless Pressure	

21-35 Ext. 2 Setpoint		
Range:	Function:	
0 ExtPID2Unit*	[par. 21-31 - par. 21-32 ExtPID2Unit]	See <i>parameter 21-15 Ext. 1 Setpoint</i> for details.

21-37 Ext. 2 Reference [Unit]		
Range:	Function:	
0 ExtPID2Unit*	[-999999.999 - 999999.999 ExtPID2Unit]	See <i>parameter 21-17 Ext. 1 Reference [Unit], Ext. 1 Reference [Unit]</i> , for details.

21-38 Ext. 2 Feedback [Unit]		
Range:	Function:	
0 ExtPID2Unit*	[-999999.999 - 999999.999 ExtPID2Unit]	See <i>parameter 21-18 Ext. 1 Feedback [Unit]</i> for details.

21-39 Ext. 2 Output [%]		
Range:	Function:	
0 %*	[0 - 100 %]	See <i>parameter 21-19 Ext. 1 Output [%]</i> for details.

3.19.5 21-4* Closed Loop 2 PID

21-40 Ext. 2 Normal/Inverse Control		
Option:	Function:	
		See <i>parameter 21-20 Ext. 1 Normal/Inverse Control for details.</i>
[0] *	Normal	
[1]	Inverse	

21-41 Ext. 2 Proportional Gain		
Range:	Function:	
0.01*	[0 - 10]	See <i>parameter 21-21 Ext. 1 Proportional Gain</i> for details.

21-42 Ext. 2 Integral Time		
Range:	Function:	
10000 s*	[0.01 - 10000 s]	See <i>parameter 21-22 Ext. 1 Integral Time</i> for details.

21-43 Ext. 2 Differentiation Time		
Range:	Function:	
0 s*	[0 - 10 s]	See <i>parameter 21-23 Ext. 1 Differentiation Time</i> for details.

21-44 Ext. 2 Dif. Gain Limit		
Range:	Function:	
5*	[1 - 50]	See <i>parameter 21-24 Ext. 1 Dif. Gain Limit</i> for details.

3.19.6 21-5* Closed Loop 3 Ref/Fb

21-50 Ext. 3 Ref./Feedback Unit		
Option:	Function:	
		See <i>parameter 21-10 Ext. 1 Ref./Feedback Unit</i> for details.

21-50 Ext. 3 Ref./Feedback Unit		
Option:	Function:	
[0]	None	
[1] *	%	
[5]	PPM	
[10]	1/min	
[11]	RPM	
[12]	Pulse/s	
[20]	l/s	
[21]	l/min	
[22]	l/h	
[23]	m ³ /s	
[24]	m ³ /min	
[25]	m ³ /h	
[30]	kg/s	
[31]	kg/min	
[32]	kg/h	
[33]	t/min	
[34]	t/h	
[40]	m/s	
[41]	m/min	
[45]	m	
[60]	°C	
[70]	mbar	
[71]	bar	
[72]	Pa	
[73]	kPa	
[74]	m WG	
[75]	mm Hg	
[80]	kW	
[120]	GPM	
[121]	gal/s	
[122]	gal/min	
[123]	gal/h	
[124]	CFM	
[125]	ft ³ /s	
[126]	ft ³ /min	
[127]	ft ³ /h	
[130]	lb/s	
[131]	lb/min	
[132]	lb/h	
[140]	ft/s	
[141]	ft/min	
[145]	ft	
[160]	°F	
[170]	psi	
[171]	lb/in ²	
[172]	in WG	
[173]	ft WG	
[174]	in Hg	
[180]	HP	

21-51 Ext. 3 Minimum Reference		
Range:	Function:	
0 ExtPID3Unit*	[-999999.999 - par. 21-52 ExtPID3Unit]	See parameter 21-11 Ext. 1 Minimum Reference for details.

21-52 Ext. 3 Maximum Reference		
Range:	Function:	
100 ExtPID3Unit*	[par. 21-51 - 999999.999 ExtPID3Unit]	See parameter 21-12 Ext. 1 Maximum Reference for details.

21-53 Ext. 3 Reference Source		
Option:	Function:	
		See parameter 21-13 Ext. 1 Reference Source for details.
[0] *	No function	
[1]	Analog Input 53	
[2]	Analog Input 54	
[7]	Pulse input 29	
[8]	Pulse input 33	
[20]	Digital pot.meter	
[21]	Analog input X30/11	
[22]	Analog input X30/12	
[23]	Analog Input X42/1	
[24]	Analog Input X42/3	
[25]	Analog Input X42/5	
[29]	Analog Input X48/2	
[30]	Ext. Closed Loop 1	
[31]	Ext. Closed Loop 2	
[32]	Ext. Closed Loop 3	

21-54 Ext. 3 Feedback Source		
Option:	Function:	
		See parameter 21-14 Ext. 1 Feedback Source for details.
[0] *	No function	
[1]	Analog Input 53	
[2]	Analog Input 54	
[3]	Pulse input 29	
[4]	Pulse input 33	
[7]	Analog Input X30/11	
[8]	Analog Input X30/12	
[9]	Analog Input X42/1	
[10]	Analog Input X42/3	
[11]	Analog Input X42/5	
[15]	Analog Input X48/2	
[100]	Bus Feedback 1	
[101]	Bus Feedback 2	
[102]	Bus feedback 3	
[104]	Sensorless Flow	
[105]	Sensorless Pressure	

21-55 Ext. 3 Setpoint		
Range:	Function:	
0 ExtPID3Unit*	[par. 21-51 - par. 21-52 ExtPID3Unit]	See <i>parameter 21-15 Ext. 1 Setpoint</i> for details.

21-57 Ext. 3 Reference [Unit]		
Range:	Function:	
0 ExtPID3Unit*	[-999999.999 - 999999.999 ExtPID3Unit]	See <i>parameter 21-17 Ext. 1 Reference [Unit]</i> for details.

21-58 Ext. 3 Feedback [Unit]		
Range:	Function:	
0 ExtPID3Unit*	[-999999.999 - 999999.999 ExtPID3Unit]	See <i>parameter 21-18 Ext. 1 Feedback [Unit]</i> for details.

21-59 Ext. 3 Output [%]		
Range:	Function:	
0 %*	[0 - 100 %]	See <i>parameter 21-19 Ext. 1 Output [%]</i> for details.

3.19.7 21-6* Closed Loop 3 PID

21-60 Ext. 3 Normal/Inverse Control		
Option:	Function:	
		See <i>parameter 21-20 Ext. 1 Normal/Inverse Control</i> for details.
[0] *	Normal	
[1]	Inverse	

21-61 Ext. 3 Proportional Gain		
Range:	Function:	
0.01*	[0 - 10]	See <i>parameter 21-21 Ext. 1 Proportional Gain</i> for details.

21-62 Ext. 3 Integral Time		
Range:	Function:	
10000 s*	[0.01 - 10000 s]	See <i>parameter 21-22 Ext. 1 Integral Time</i> for details.

21-63 Ext. 3 Differentiation Time		
Range:	Function:	
0 s*	[0 - 10 s]	See <i>parameter 21-23 Ext. 1 Differentiation Time</i> for details.

21-64 Ext. 3 Dif. Gain Limit		
Range:	Function:	
5*	[1 - 50]	See <i>parameter 21-24 Ext. 1 Dif. Gain Limit</i> for details.

3.20 Parameters: 22-** Application Functions

This group contains parameters used for monitoring HVAC applications.

22-00 External Interlock Delay		
Range:	Function:	
0 s* [0 - 600 s]	Only relevant if 1 of the digital inputs in parameter group 5-1* <i>Digital Inputs</i> has been programmed for [7] <i>External Interlock</i> . The external interlock timer introduces a delay after the signal has been removed from the digital	

22-00 External Interlock Delay		
Range:	Function:	
	input programmed for external interlock, before reaction takes place.	

22-01 Power Filter Time		
Range:	Function:	
0.50 s* [0.02 - 10 s]	Sets the time constant for the filtered power readout. A higher value gives a more steady readout but a slower system response to changes.	

3.20.1 22-2* No-Flow Detection

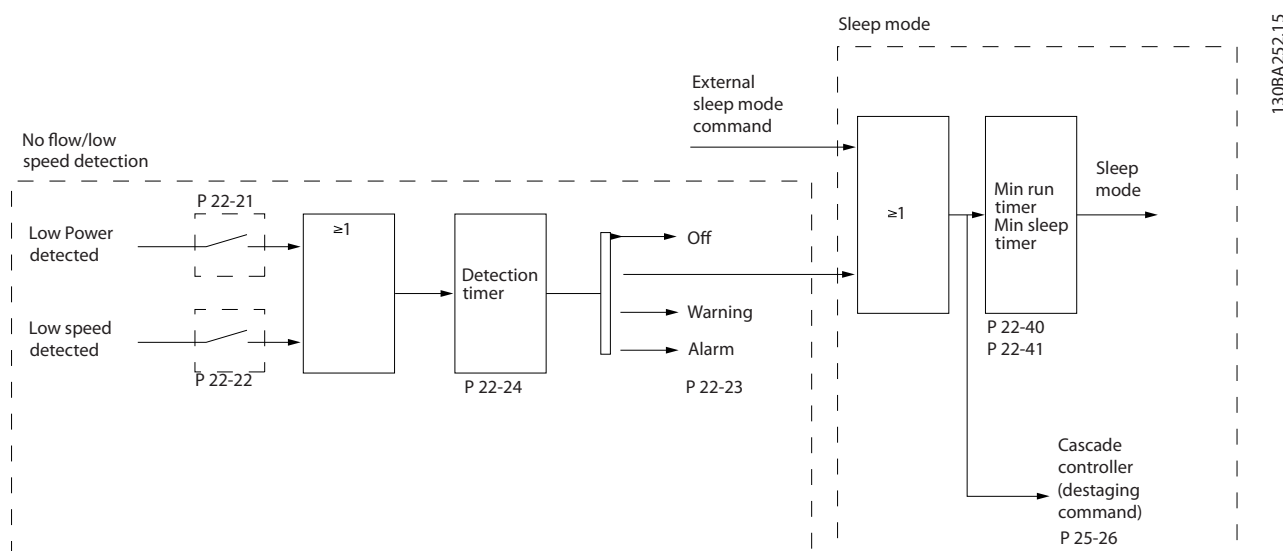

Illustration 3.50 No Flow Detection

The frequency converter includes functions for detecting if the load conditions in the system allow the motor to be stopped:

- Low power detection.
- Low speed detection.

One of these 2 signals must be active for a set time (*parameter 22-24 No-Flow Delay*) before selected action takes place.

Possible actions to select (*parameter 22-23 No-Flow Function*):

- No action
- Warning
- Alarm
- Sleep Mode

No Flow Detection

This function is used for detecting a no-flow situation in pump systems where all valves can be closed. Can be used both when controlled by the integrated PI controller in the frequency converter or an external PI controller. Programme the actual configuration in *parameter 1-00 Configuration Mode*.

Configuration mode for

- Integrated PI controller: Closed loop
- External PI controller: Open loop

NOTICE

Carry out no-flow tuning before setting the PI controller parameters.

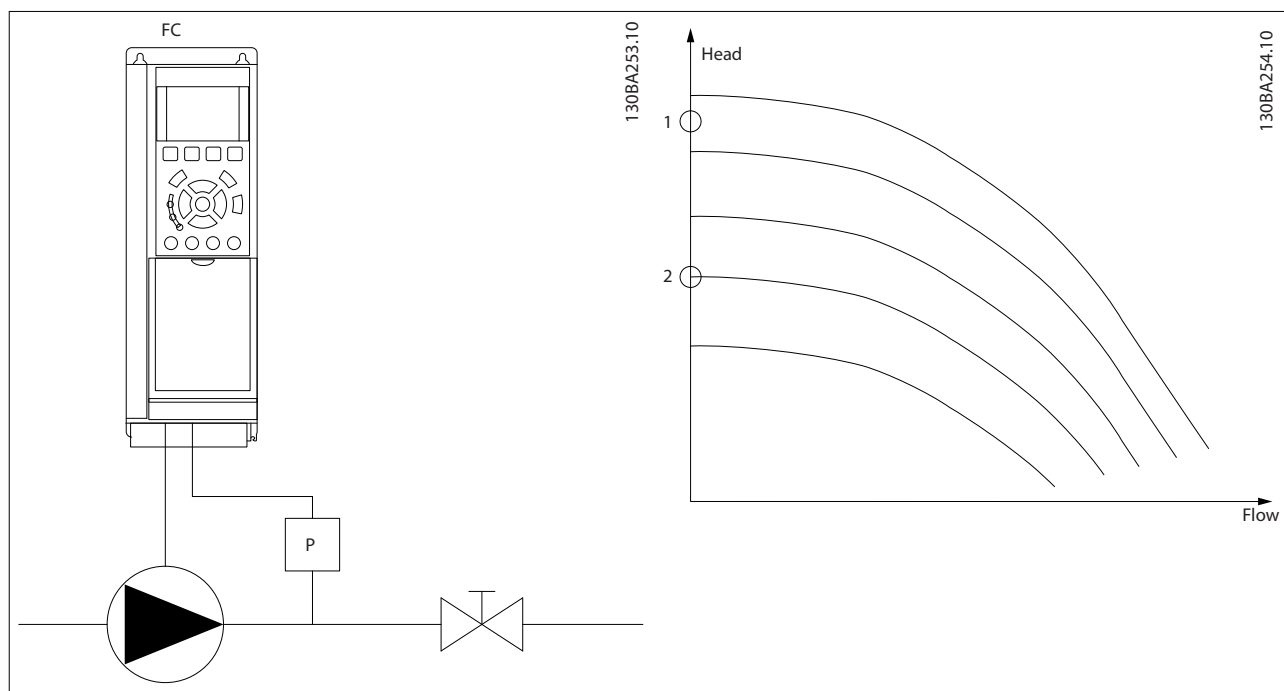

Table 3.23 No Flow Detection

No-flow Detection

No-flow detection is based on the measurement of speed and power. For a certain speed, the frequency converter calculates the power at no flow.

This coherence is based on the adjustment of 2 sets of speed and associated power at no-flow. By monitoring the power, it is possible to detect no-flow conditions in systems with fluctuating suction pressure, or if the pump has a flat characteristic towards low speed.

The 2 sets of data must be based on measurement of power at approximately 50% and 85% of maximum speed with the valve(s) closed. The data is programmed in parameter group 22-3* No-Flow Power Tuning. It is also possible to run a [0] Low Power Auto Set Up (parameter 22-20 Low Power Auto Set-up) automatically stepping through the commissioning process and also automatically storing the data measured. The frequency converter must be set for [0] Open Loop in parameter 1-00 Configuration Mode, when carrying out the Auto Set Up (See parameter group 22-3* No-Flow Power Tuning No-flow Power Tuning).

NOTICE

If to use the integrated PI controller, carry out no-flow tuning before setting the PI controller parameters.

Low speed detection

Low speed detection gives a signal if the motor operates with minimum speed as set in *parameter 4-11 Motor Speed Low Limit [RPM]* or *parameter 4-12 Motor Speed Low Limit [Hz]*. Actions are common with no-flow detection (individual selection not possible).

The use of low speed detection is not limited to systems with a no-flow situation, but can be used in any system where operation at minimum speed allows for a stop of the motor until the load calls for a speed higher than minimum speed, for example systems with fans and compressors.

NOTICE

In pump systems, ensure that the minimum speed in *parameter 4-11 Motor Speed Low Limit [RPM]* or *parameter 4-12 Motor Speed Low Limit [Hz]* has been set high enough for detection as the pump can run with a rather high speed even with valves closed.

Dry-pump detection

No-flow detection can also be used for detecting if the pump has run dry (low power consumption-high speed). Can be used with both the integrated PI controller and an external PI controller.

The condition for dry pump signal:

- Power consumption below no-flow level

and

- Pump running at maximum speed or maximum reference open loop, whichever is lowest.

The signal must be active for a set time (*parameter 22-27 Dry Pump Delay*) before the selected action takes place.

Possible actions to select (*parameter 22-26 Dry Pump Function*):

- Warning
- Alarm

No-flow detection must be enabled (*parameter 22-23 No-Flow Function*) and commissioned (parameter group 22-3* *No-Flow Power Tuning*).

22-20 Low Power Auto Set-up	
Start of auto set-up of power data for no-flow power tuning.	
Option:	Function:
[0] * Off	
[1] Enabled	<p>NOTICE</p> <p>Auto set-up must be done when the system has reached normal operating temperature!</p> <p>NOTICE</p> <p>It is important that <i>parameter 4-13 Motor Speed High Limit [RPM]</i> or <i>parameter 4-14 Motor Speed High Limit [Hz]</i> is set to the maximum operational speed of the motor.</p> <p>It is important to do the auto set-up before configuring the integrated PI controller as settings are reset when changing from closed to open loop in <i>parameter 1-00 Configuration Mode</i>.</p>

22-20 Low Power Auto Set-up	
Start of auto set-up of power data for no-flow power tuning.	
Option:	Function:
	<p>NOTICE</p> <p>Carry out the tuning with the same settings in <i>parameter 1-03 Torque Characteristics</i>, as for operation after the tuning.</p> <p>An auto set-up sequence is activated, automatically setting speed to approximately 50% and 85% of rated motor speed (<i>parameter 4-13 Motor Speed High Limit [RPM]</i>, <i>parameter 4-14 Motor Speed High Limit [Hz]</i>). At those 2 speeds, the power consumption is automatically measured and stored.</p> <p>Before enabling auto set-up:</p> <ol style="list-style-type: none"> 1. Close valve(s) to create a no-flow condition. 2. Set the frequency converter to open-loop (<i>parameter 1-00 Configuration Mode</i>). Note that it is important also to set <i>parameter 1-03 Torque Characteristics</i>.

22-21 Low Power Detection		
Option:	Function:	
[0] *	Disabled	
[1]	Enabled	To set the parameters in parameter group 22-3* <i>No-Flow Power Tuning</i> for proper operation, Carry out the low-power detection commissioning.

22-22 Low Speed Detection		
Option:	Function:	
[0] *	Disabled	
[1]	Enabled	Detects when the motor operates with a speed as set in <i>parameter 4-11 Motor Speed Low Limit [RPM]</i> or <i>parameter 4-12 Motor Speed Low Limit [Hz]</i> .

22-23 No-Flow Function		
Common actions for low-power detection and low-speed detection (individual selections not possible).		
Option:	Function:	
[0] *	Off	<p>NOTICE</p> <p>Do not set <i>parameter 14-20 Reset Mode</i>, to [13] <i>Infinite auto reset</i>, when <i>parameter 22-23 No-Flow Function</i> is set to [3] <i>Alarm</i>. Doing so causes the frequency converter to continuously cycle between running and stopping when a no-flow condition is detected.</p> <p>NOTICE</p> <p>Disable the automatic bypass function of the bypass if:</p> <ul style="list-style-type: none"> The frequency converter is equipped with a constant-speed bypass with an automatic bypass function starting the bypass if the frequency converter experiences a persistent alarm condition, and [3] <i>Alarm</i> is selected as the no-flow function.
[1]	Sleep Mode	The frequency converter enters sleep mode and stops when a no-flow condition is detected. See parameter group 22-4* <i>Sleep Mode</i> for programming options for sleep mode.
[2]	Warning	The frequency converter continues to run, but activates a no-flow warning (<i>Warning 92, NoFlow</i>). A digital output or a serial communication bus can communicate a warning to other equipment.

22-23 No-Flow Function		
Common actions for low-power detection and low-speed detection (individual selections not possible).		
Option:	Function:	
[3]	Alarm	The frequency converter stops running and activates a no-flow alarm (<i>Alarm 92, NoFlow</i>). A frequency converter digital output or a serial communication bus can communicate an alarm to other equipment.

22-24 No-Flow Delay		
Range:	Function:	
10 s*	[1 - 600 s]	Set the time that low power/low speed must stay detected to activate signal for actions. If detection disappears before the timer runs out, the timer is reset.

22-26 Dry Pump Function		
Select desired action for dry-pump operation.		
Option:	Function:	
[0] *	Off	
[1]	Warning	<p>NOTICE</p> <p>To use dry-pump detection:</p> <ol style="list-style-type: none"> 1. Enable <i>low-power detection</i> in <i>parameter 22-21 Low Power Detection</i>. 2. Commission <i>low-power detection</i> using either parameter group <i>22-3* No-flow Power Tuning No Flow Power Tuning</i>, or <i>parameter 22-20 Low Power Auto Set-up</i>. <p>NOTICE</p> <p>Do not set <i>parameter 14-20 Reset Mode</i> to [13] <i>Infinite auto reset</i>, when <i>parameter 22-26 Dry Pump Function</i> is set to [2] <i>Alarm</i>. Doing so causes the frequency converter to continuously cycle between running and stopping when a dry-pump condition is detected.</p> <p>NOTICE</p> <p>For frequency converters with constant-speed bypass If an automatic bypass function starts the bypass at persistent alarm conditions, disable the bypass's automatic bypass function, if [2] <i>Alarm</i> or [3] <i>Man. Reset Alarm</i> is selected as the dry-pump function.</p> <p>The frequency converter continues to run, but activates a dry-pump warning (<i>Warning 93, Dry pump</i>). A frequency converter digital output or a serial communication bus can communicate a warning to other equipment.</p>
[2]	Alarm	The frequency converter stops running and activates a dry-pump alarm (<i>Alarm 93, Dry pump</i>). A frequency converter digital output or a serial communication bus can communicate an alarm to other equipment.
[3]	Man. Reset Alarm	The frequency converter stops running and activates a dry-pump alarm (<i>Alarm 93, Dry pump</i>). A frequency converter digital output or a serial communication bus can communicate an alarm to other equipment.

22-26 Dry Pump Function		
Select desired action for dry-pump operation.		
Option:	Function:	
[4]	Stop and Trip	

22-27 Dry Pump Delay		
Range:	Function:	
10 s*	[0 - 600 s]	Defines for how long the dry-pump condition must be active before activating a warning or an alarm. The frequency converter waits for the no-flow delay time (<i>22-24 No-Flow Delay</i>) to expire before the timer for the dry-pump delay starts.

3.20.2 22-3* No-flow Power Tuning

If not selecting *Auto Set Up* in *parameter 22-20 Low Power Auto Set-up*, the tuning sequence is:

1. Close the main valve to stop flow.
2. Run with motor until the system has reached normal operating temperature.
3. Press [Hand On] and adjust speed for approximately 85% of rated speed. Note the exact speed.
4. Read power consumption either by looking for actual power in the data line in the LCP or call
 - 4a *Parameter 16-10 Power [kW]*
 - or
 - 4b *Parameter 16-11 Power [hp]* in Main Menu.

Note the power readout.
5. Change speed to approximately 50% of rated speed. Note the exact speed.
6. Read power consumption either by looking for actual power in the data line in the LCP or call
 - 6a *Parameter 16-10 Power [kW]*
 - or
 - 6b *Parameter 16-11 Power [hp]* in Main Menu.

Note the power readout.
7. Programme the speeds used in:
 - 7a *Parameter 22-32 Low Speed [RPM]*.
 - 7b *Parameter 22-33 Low Speed [Hz]*.
 - 7c *Parameter 22-36 High Speed [RPM]*.
 - 7d *Parameter 22-37 High Speed [Hz]*.
8. Programme the associated power values in:

- 8a Parameter 22-34 Low Speed Power [kW].
- 8b Parameter 22-35 Low Speed Power [HP].
- 8c Parameter 22-38 High Speed Power [kW].
- 8d Parameter 22-39 High Speed Power [HP].

9. Switch back with [Auto On] or [Off].

NOTICE

Set parameter 1-03 Torque Characteristics before tuning takes place.

22-30 No-Flow Power		
Range:		Function:
0 kW*	[0 - 0 kW]	Readout of calculated no-flow power at actual speed. If power drops to the display value, the frequency converter considers the condition as a no-flow situation.

22-31 Power Correction Factor		
Range:		Function:
100 %*	[1 - 400 %]	Make corrections to the calculated power in parameter 22-30 No-Flow Power. If no-flow is detected, when it should not be detected, decrease the setting. However, if no-flow is not detected, when it should be detected, increase the setting to above 100%.

22-32 Low Speed [RPM]		
Range:		Function:
Size related*	[0 - par. 22-36 RPM]	To be used if parameter 0-02 Motor Speed Unit has been set to [0] RPM (parameter not visible if [1] Hz is selected). Set used speed for the 50% level. This function is used for storing values needed to tune no-flow detection.

22-33 Low Speed [Hz]		
Range:		Function:
Size related*	[0 - par. 22-37 Hz]	To be used if parameter 0-02 Motor Speed Unit has been set for [1] Hz (parameter not visible if [0] RPM is selected). Set used speed for the 50% level. The function is used for storing values needed to tune no-flow detection.

22-34 Low Speed Power [kW]		
Range:		Function:
Size related*	[0 - 5.50 kW]	To be used if parameter 0-03 Regional Settings has been set for [0] International (parameter not visible if [1] North America is selected). Set power consumption at 50% speed level. This function is used for storing values needed to tune no-flow detection.

22-35 Low Speed Power [HP]		
Range:		Function:
Size related*	[0 - 7.50 hp]	To be used if parameter 0-03 Regional Settings has been set for [1] North America (parameter not visible if [0] International is selected). Set power consumption at 50% speed level. This function is used for storing values needed to tune no-flow detection.

22-36 High Speed [RPM]		
Range:		Function:
Size related*	[0 - par. 4-13 RPM]	To be used if parameter 0-02 Motor Speed Unit has been set for [0] RPM (parameter not visible if [1] Hz is selected). Set used speed for the 85% level. The function is used for storing values needed to tune no-flow detection.

22-37 High Speed [Hz]		
Range:		Function:
Size related*	[0 - par. 4-14 Hz]	To be used if parameter 0-02 Motor Speed Unit has been set for [1] Hz (parameter not visible if [0] RPM is selected). Set used speed for the 85% level. The function is used for storing values needed to tune no-flow detection.

22-38 High Speed Power [kW]		
Range:		Function:
Size related*	[0 - 5.50 kW]	To be used if parameter 0-03 Regional Settings has been set for International (parameter not visible if North America is selected). Set power consumption at 85% speed level. This function is used for storing values needed to tune no-flow detection.

22-39 High Speed Power [HP]		
Range:		Function:
Size related*	[0 - 7.50 hp]	To be used if parameter 0-03 Regional Settings has been set for North America (parameter not visible if International is selected). Set power consumption at 85% speed level. This function is used for storing values needed to tune no-flow detection.

3.20.3 22-4* Sleep Mode

If the load on the system allows for stop of the motor and the load is monitored, the motor can be stopped by activating the sleep mode function. This is not a normal stop command, but ramps the motor down to 0 RPM and

stops energising the motor. When in sleep mode, certain conditions are monitored to find out when load has been applied to the system again.

Sleep mode can be activated either from the no-flow detection/minimum speed detection (must be programmed via parameters for no-flow detection, see the signal flow-diagram in parameter group 22-2*, *No-Flow Detection*) or via an external signal applied to 1 of the digital inputs (must be programmed via the parameters for configuration of the digital inputs, parameter group 5-1* selecting [66] Sleep Mode). Sleep mode is activated only when no wake-up conditions are present.

To make it possible to use for example an electro-mechanical flow switch to detect a no-flow condition and activate Sleep mode, the action takes place at the raising edge of the external signal applied (otherwise the frequency converter would stay in sleep mode as the signal would be steadily connected).

NOTICE

If sleep mode is to be based on no-flow detection/minimum speed, select [1] Sleep Mode in parameter 22-23 No-Flow Function.

If parameter 25-26 *Destage At No-Flow* is set for [1] Enabled, activating sleep mode sends a command to the cascade controller (if enabled) to start de-staging of lag pumps (fixed speed) before stopping the lead pump (variable speed).

When entering sleep mode, the lower status line in the LCP shows *Sleep Mode*.

See also signal flow chart in chapter 3.20.1 22-2* *No-Flow Detection*.

There are 3 different ways of using the sleep mode function:

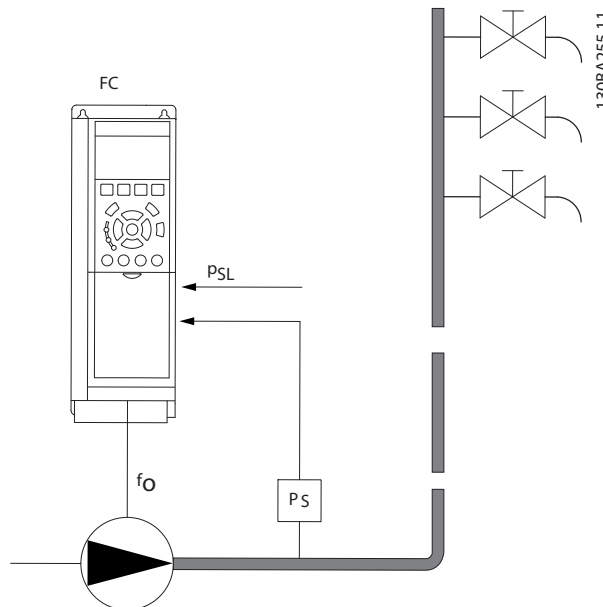

Illustration 3.51 Sleep mode function

1) Systems where the integrated PI controller is used for controlling pressure or temperature for example boost systems with a pressure feedback signal applied to the frequency converter from a pressure transducer. Set parameter 1-00 Configuration Mode for [3] Closed Loop and configure the PI controller configured for desired reference and feedback signals.

Example: Boost system.

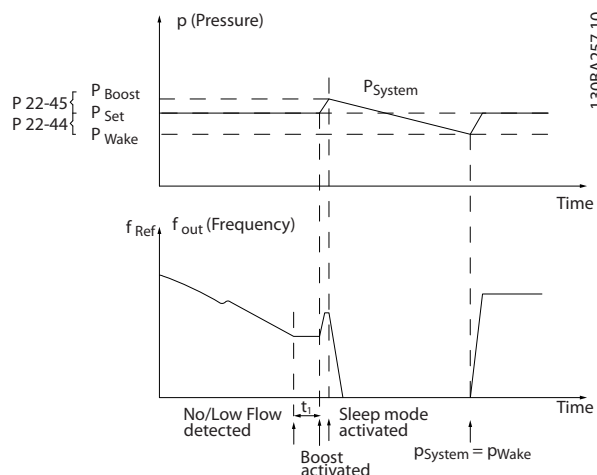

Illustration 3.52 Boost system

If no-flow is detected, the frequency converter increases the setpoint for pressure to ensure a slight overpressure in

the system (boost to be set in *parameter 22-45 Setpoint Boost*).
 The feedback from the pressure transducer is monitored, and when this pressure has dropped with a set percentage below the normal setpoint for pressure (P_{set}), the motor ramps up again and pressure controlled for reaching the set value (P_{set}).

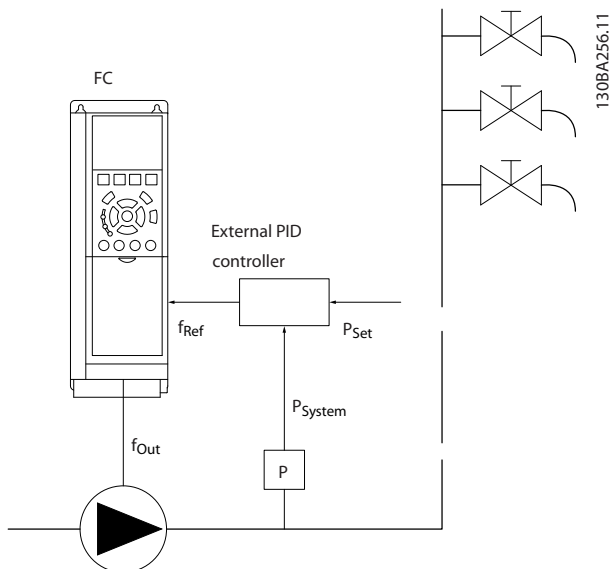

Illustration 3.53 Boost System

2) In systems where the pressure or temperature is controlled by an external PI controller, the wake-up conditions cannot be based on feedback from the pressure/temperature transducer as the setpoint is not known. In the example with a boost system, desired

pressure P_{set} is not known. *Parameter 1-00 Configuration Mode for [0] Open Loop*.
 Example: Boost system.

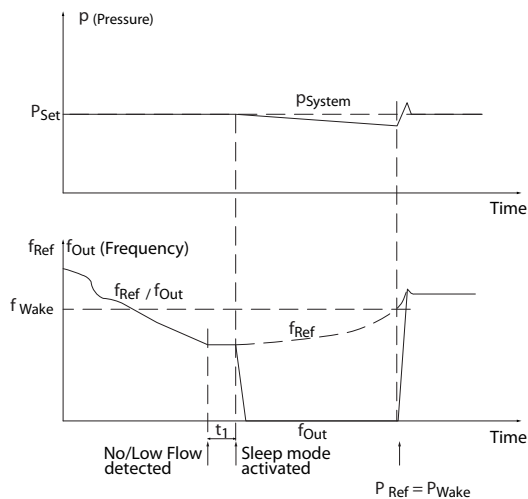

Illustration 3.54 Boost System

When low power or low speed is detected the motor is stopped, but the reference signal (f_{ref}) from the external controller is still monitored. Because of the low pressure created, the controller increases the reference signal to gain pressure. When the reference signal has reached a set value, f_{wake} , the motor restarts.

The speed is set manually by an external reference signal (Remote Reference). Use default settings (parameter group 22-3* No-Flow Power Tuning) for tuning of the no-flow function.

	Internal PI controller (parameter 1-00 Configuration Mode: Closed loop)		External PI controller or manual control (parameter 1-00 Configuration Mode: Open loop)	
	Sleep mode	Wake up	Sleep mode	Wake up
No-flow detection (pumps only)	Yes		Yes (except manual setting of speed)	
Low speed detection	Yes		Yes	
External signal	Yes		Yes	
Pressure/temperature (transmitter connected)		Yes		No
Output frequency		No		Yes

Table 3.24 Configuration Overview

NOTICE

Sleep mode does not active when local reference is active (press the navigation keys to set speed manually).
 See 3-13 Reference Site.
 Does not work in Hand mode. Carry out Auto set-up in open loop before setting input/output in closed loop.

22-40 Minimum Run Time		
Range:	Function:	
10 s*	[0 - 600 s]	Set the desired minimum running time for the motor after a start command (digital input or bus) before entering sleep mode.

22-41 Minimum Sleep Time		
Range:	Function:	
10 s*	[0 - 600 s]	Set the desired minimum time for staying in sleep mode. This setting overrides any wake-up conditions.

22-42 Wake-up Speed [RPM]		
Range:	Function:	
Size related*	[par. 4-11 - par. 4-13 RPM]	To be used if <i>parameter 0-02 Motor Speed Unit</i> has been set for [0] RPM (parameter not visible if [1] Hz is selected). Only to be used if <i>parameter 1-00 Configuration Mode</i> is set for open loop and an external controller applies speed reference. Set the reference speed at which the sleep mode should be cancelled.

22-43 Wake-up Speed [Hz]		
Range:	Function:	
Size related*	[par. 4-12 - par. 4-14 Hz]	To be used if <i>parameter 0-02 Motor Speed Unit</i> has been set for [1] Hz (parameter not visible if [0] RPM is selected). Only to be used if <i>parameter 1-00 Configuration Mode</i> is set for [0] Open Loop and speed reference is applied by an external controller controlling the pressure. Set the reference speed at which the sleep mode should be cancelled.

22-44 Wake-up Ref./FB Difference		
Range:	Function:	
10 %*	[0 - 100 %]	Only to be used if <i>parameter 1-00 Configuration Mode</i> is set for [3] Process Closed Loop and the integrated PI controller is used for controlling the pressure. Set the pressure drop allowed in percentage of setpoint for the pressure (P_{set}) before cancelling the sleep mode.

22-45 Setpoint Boost		
Range:	Function:	
0 %*	[-100 - 100 %]	Only to be used if <i>parameter 1-00 Configuration Mode</i> is set to [3] Closed Loop and the integrated PI controller is used. In systems with, for example, constant pressure control, it is advantageous to increase the system pressure before the motor is stopped. This extends the time in which the motor is stopped and helps to avoid frequent start/stop.

22-45 Setpoint Boost		
Range:	Function:	
		Set the desired overpressure/temperature in percentage of setpoint for the pressure (P_{set})/temperature before entering sleep mode. If set to 5%, the boost pressure is $P_{set} * 1.05$. The negative values can be used, for example, cooling tower control where a negative change is needed.

22-46 Maximum Boost Time		
Range:	Function:	
60 s*	[0 - 600 s]	Only to be used if <i>parameter 1-00 Configuration Mode</i> is set to [3] Process Closed Loop and the integrated PI controller is used for controlling the pressure. Set the maximum time for which boost mode is allowed. If the set time is exceeded, sleep mode is entered, not waiting for the set boost pressure to be reached.

3.20.4 22-5* End of Curve

The end-of-Curve conditions occur when a pump is yielding a too large volume to ensure the set pressure. This can occur if there is a leakage in the distribution pipe system after the pump causing the pump to operate at the end of the pump characteristic, valid for the max. speed set in *parameter 4-13 Motor Speed High Limit [RPM]* or *parameter 4-14 Motor Speed High Limit [Hz]*.

If the feedback is 2.5% of the programmed value in *parameter 20-14 Maximum Reference/Feedb.* (or numerical value of *parameter 20-13 Minimum Reference/Feedb.* whichever is highest) below the set point for the desired pressure for a set time (*parameter 22-51 End of Curve Delay*), and the pump is running with maximum speed set in *parameter 4-13 Motor Speed High Limit [RPM]* or *parameter 4-14 Motor Speed High Limit [Hz]*, the function selected in *parameter 22-50 End of Curve Function* takes place.

It is possible to get a signal on 1 of the digital outputs by selecting [192] End of Curve in parameter group 5-3* Digital Outputs and/or parameter group 5-4* Relays. The signal is present, when an end-of-Curve condition occurs and the selection in *parameter 22-50 End of Curve Function*, is different from [0] Off. The end-of-curve function can only be used when operating with the built-in PID controller ([3] Closed loop in *parameter 1-00 Configuration Mode*).

22-50 End of Curve Function		
Option:	Function:	
		<p>NOTICE</p> <p>Automatic restart resets the alarm and restarts the system.</p> <p>NOTICE</p> <p>Do not set <i>parameter 14-20 Reset Mode</i>, to [13] <i>Infinite auto reset</i>, when <i>parameter 22-50 End of Curve Function</i> is set to [2] <i>Alarm</i>. Doing so causes the frequency converter to continuously cycle between running and stopping when an end-of-curve condition is detected.</p> <p>NOTICE</p> <p>If the frequency converter is equipped with a constant speed bypass with an automatic bypass function that starts the bypass if the frequency converter experiences a persistent alarm condition, be sure to disable the bypass's automatic bypass function, if [2] <i>Alarm</i> or [3] <i>Man. Reset Alarm</i> is selected as the end-of-curve function.</p>
[0]	Off	End-of-curve monitoring is not active.
[1]	Warning	The frequency converter continues to run, but activates an end-of-curve warning (<i>Warning 94, End of curve</i>). A frequency converter digital output or a serial communication bus can communicate a warning to other equipment.
[2]	Alarm	The frequency converter stops running and activates an end-of-curve alarm (<i>Alarm 94, End of curve</i>). A frequency converter digital output or a serial communication bus can communicate an alarm to other equipment.
[3]	Man. Reset Alarm	The frequency converter stops running and activates an end-of-curve alarm (<i>Alarm 94, End of curve</i>). A frequency converter digital output or a serial communication bus can communicate an alarm to other equipment.
[4]	Stop and Trip	

22-51 End of Curve Delay		
Range:	Function:	
10 s*	[0 - 600 s]	When an end-of-curve condition is detected, a timer is activated. When the time set in this parameter expires, and the end-of-curve condition has been steady during the entire period, the function set in <i>parameter 22-50 End of Curve Function</i> is activated. If the condition

22-51 End of Curve Delay		
Range:	Function:	
		disappears before the timer expires, the timer is reset.

3.20.5 22-6* Broken Belt Detection

The broken belt detection can be used in both closed and open loop systems for pumps, fans, and compressors. If the estimated motor torque is below the broken belt torque value (*parameter 22-61 Broken Belt Torque*), and the frequency converter output frequency is above or equal to 15 Hz, the broken-belt function (*parameter 22-60 Broken Belt Function*) is performed.

22-60 Broken Belt Function		
Selects the action to be performed if the broken-belt condition is detected.		
Option:	Function:	
		<p>NOTICE</p> <p>Do not set <i>parameter 14-20 Reset Mode</i> to [13] <i>Infinite auto reset</i>, when <i>parameter 22-60 Broken Belt Function</i> is set to [2] <i>Trip</i>. Doing so causes the frequency converter to continuously cycle between running and stopping when a broken-belt condition is detected.</p> <p>NOTICE</p> <p>For frequency converters with constant-speed bypass If an automatic bypass function starts the bypass at persistent alarm conditions, disable the bypass's automatic bypass function, if [2] <i>Alarm</i> or [3] <i>Man. Reset Alarm</i> is selected as the broken-belt function.</p>
[0] *	Off	
[1]	Warning	The frequency converter continues to run, but activates a broken-belt warning (<i>Warning 95, Broken belt</i>). A frequency converter digital output or a serial communication bus can communicate a warning to other equipment.
[2]	Trip	The frequency converter stops running and activates a broken-belt alarm (<i>Alarm 95, Broken belt</i>). A frequency converter digital output or a serial communication bus can communicate an alarm to other equipment.

22-61 Broken Belt Torque		
Range:	Function:	
10 %*	[0 - 100 %]	Sets the broken-belt torque as a percentage of the rated motor torque.

22-62 Broken Belt Delay		
Range:	Function:	
10 s [0 - 600 s]	Sets the time for which the broken-belt conditions must be active before carrying out the action selected in <i>parameter 22-60 Broken Belt Function</i> .	

3.20.6 22-7* Short Cycle Protection

When controlling refrigeration compressors, often there is a need for limiting the numbers of starts. One way to do this is to ensure a minimum run time (time between a start and a stop) and a minimum interval between starts. This means that any normal stop command can be overridden by the *Minimum Run Time* function (*parameter 22-77 Minimum Run Time*) and any normal start command (start/jog/freeze) can be overridden by the *Interval Between Starts* function (*parameter 22-76 Interval between Starts*).

None of the 2 functions are active if *Hand On* or *Off* modes have been activated via the LCP. If selecting *Hand On* or *Off*, the 2 timers are reset to 0, and not start counting until *Auto* is pressed and an active start command applied.

NOTICE

A coast command or missing run permissive signal override both minimum run time and interval between starts functions.

22-75 Short Cycle Protection		
Option:	Function:	
[0] *	Disabled	Timer set in <i>parameter 22-76 Interval between Starts</i> is disabled.
[1]	Enabled	Timer set in <i>parameter 22-76 Interval between Starts</i> is enabled.

22-76 Interval between Starts		
Range:	Function:	
Size related* [par. 22-77 - 3600 s]	Sets the time desired as minimum time between 2 starts. Any normal start command (start/jog/freeze) is disregarded until the timer has expired.	

22-77 Minimum Run Time		
Range:	Function:	
0 s* [0 - par. 22-76 s]	<p>NOTICE</p> <p>Does not work in cascade mode.</p> <p>Sets the time desired as minimum run time after a normal start command (start/jog/freeze). Any normal stop command is disregarded until the set time has expired. The timer starts counting following a normal start command (start/jog/freeze).</p> <p>A coast (inverse) or an external interlock command overrides the timer.</p>	

3.20.7 22-8* Flow Compensation

It is sometimes the case that it is not possible for a pressure transducer to be placed at a remote point in the system and it can only be located close to the fan/pump outlet. Flow compensation operates by adjusting the setpoint according to the output frequency, which is almost proportional to flow, thus compensating for higher losses at higher flow rates.

H_{DESIGN} (required pressure) is the setpoint for closed loop (PI) operation of the frequency converter and is set as for closed-loop operation without flow compensation.

It is recommended to use slip compensation and RPM as unit.

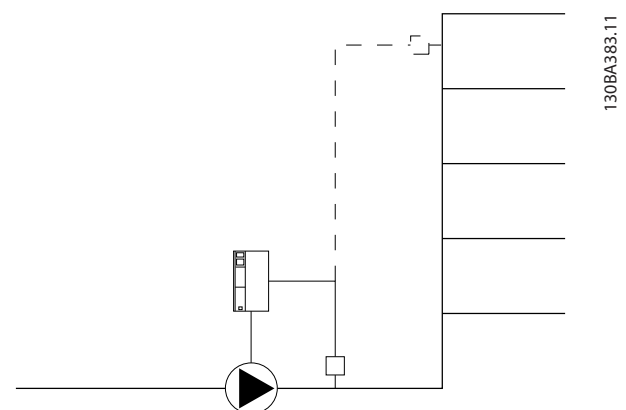

Illustration 3.55 Flow Compensation

NOTICE

When flow compensation is used with the cascade controller (parameter group 25-** Cascade Pack Controller), the actual setpoint does not depend on speed (flow), but on the number of pumps cut in. See *Illustration 3.56*:

There are 2 methods which can be employed, depending upon whether or not the speed at system design working point is known.

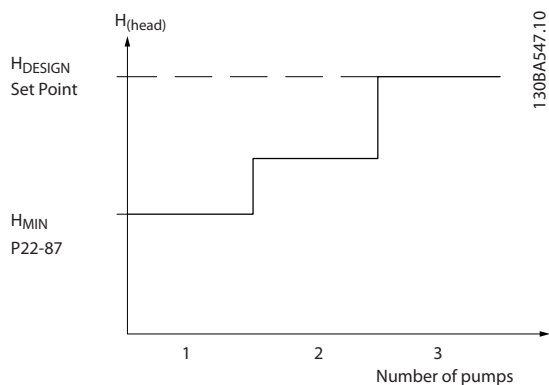

Illustration 3.56 Number of Pumps

Parameter used	Speed at design point KNOWN	Speed at design point UNKNOWN	Cascade controller
Parameter 22-80 Flow Compensation	+	+	+
Parameter 22-81 Square-linear Curve Approximation	+	+	-
Parameter 22-82 Work Point Calculation	+	+	-
Parameter 22-83 Speed at No-Flow [RPM]/ Parameter 22-84 Speed at No-Flow [Hz]	+	+	-
Parameter 22-85 Speed at Design Point [RPM]/ Parameter 22-86 Speed at Design Point [Hz]	+	-	-
parameter 22-87 Pressure at No-Flow Speed	+	+	+
Parameter 22-88 Pressure at Rated Speed	-	+	-
Parameter 22-89 Flow at Design Point	-	+	-
Parameter 22-90 Flow at Rated Speed	-	+	-

Table 3.25 Number of Pumps

22-80 Flow Compensation		
Option:	Function:	
[0] *	Disabled	Setpoint compensation not active.
[1]	Enabled	Setpoint compensation is active. Enabling this parameter allows the flow-compensated setpoint operation.

22-81 Square-linear Curve Approximation		
Range:	Function:	
100 %*	[0 - 100 %]	<p>Example 1:</p> <p>Adjustment of this parameter allows the shape of the control curve to be adjusted.</p> <p>0=Linear</p> <p>100%=Ideal shape (theoretical).</p>

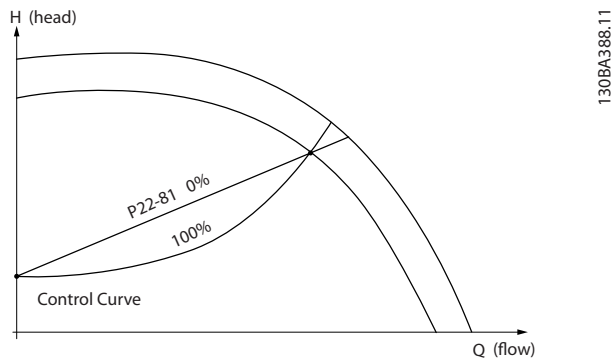

Illustration 3.57 Square-Linear Curve Approximation

22-82 Work Point Calculation	
Option:	Function:
	<p>Example 1</p> <p>Illustration 3.58 Speed at System Design Working Point is Known</p> <p>From the data sheet showing characteristics for the specific equipment at different speeds, simply reading across from the H_{DESIGN} point and the Q_{DESIGN} point allows finding point A, which is the system design working point. The pump characteristics at this point should be identified and the associated speed programmed. Closing the valves and adjusting the speed until H_{MIN} has been achieved allows the speed at the no-flow point to be identified.</p> <p>Adjustment of <i>parameter 22-81 Square-linear Curve Approximation</i> then allows the shape of the control curve to be adjusted infinitely.</p> <p>Example 2:</p> <p>Speed at system design working point is not known: Where the speed at system design working point is unknown, another reference point</p>

22-82 Work Point Calculation	
Option:	Function:
	<p>on the control curve needs to be determined based on the data sheet. By looking at the curve for the rated speed and plotting the design pressure (H_{DESIGN}, Point C), the flow at that pressure, Q_{RATED}, can be determined. Similarly, by plotting the design flow (Q_{DESIGN}, Point D), the pressure H_{DESIGN} at that flow can be determined. Knowing these 2 points on the pump curve, along with H_{MIN} as described above, allows the frequency converter to calculate the reference point B and thus to plot the control curve, which also includes the system design working point A.</p> <p>Illustration 3.59 Speed at System Design Working Point is not Known</p>
[0]	<p>Disabled</p> <p>Work point calculation not active. To be used if speed at design point is known.</p>
[1]	<p>Enabled</p> <p>Work point calculation is active. Enabling this parameter allows the calculation of the unknown system design working point at 50/60 Hz speed, from the input data set in</p> <ul style="list-style-type: none"> Parameter 22-83 Speed at No-Flow [RPM]. Parameter 22-84 Speed at No-Flow [Hz]. Parameter 22-87 Pressure at No-Flow Speed. Parameter 22-88 Pressure at Rated Speed. Parameter 22-89 Flow at Design Point. Parameter 22-90 Flow at Rated Speed.

22-83 Speed at No-Flow [RPM]		
Range:		Function:
Size related*	[0 - par. 22-85 RPM]	Resolution 1 RPM. Enter the speed of the motor in RPM at which flow is zero and minimum pressure H_{MIN} is achieved. Alternatively, enter the speed in Hz in <i>parameter 22-84 Speed at No-Flow [Hz]</i> . If it has been decided to use RPM in <i>parameter 0-02 Motor Speed Unit</i> , <i>parameter 22-85 Speed at Design Point [RPM]</i> should also be used. Closing the valves and reducing the speed until minimum pressure H_{MIN} is achieved determines this value.

22-84 Speed at No-Flow [Hz]		
Range:		Function:
Size related*	[0 - par. 22-86 Hz]	Resolution 0.033 Hz. Enter the motor speed in Hz at which flow has effectively stopped and minimum pressure H_{MIN} is achieved. Alternatively, enter the speed in RPM in <i>parameter 22-83 Speed at No-Flow [RPM]</i> . If it has been decided to use Hz in <i>parameter 0-02 Motor Speed Unit</i> , <i>parameter 22-86 Speed at Design Point [Hz]</i> should also be used. Closing the valves and reducing the speed until minimum pressure H_{MIN} is achieved determines this value.

22-85 Speed at Design Point [RPM]		
Range:		Function:
Size related*	[par. 22-83 - 60000 RPM]	Resolution 1 RPM. Only visible when <i>parameter 22-82 Work Point Calculation</i> is set to [0] Disabled. Enter the motor speed in RPM at which the system design working point is achieved. Alternatively, enter the speed in Hz in <i>parameter 22-86 Speed at Design Point [Hz]</i> . If it has been decided to use RPM in <i>parameter 0-02 Motor Speed Unit</i> , <i>parameter 22-83 Speed at No-Flow [RPM]</i> should also be used.

22-86 Speed at Design Point [Hz]		
Range:		Function:
Size related*	[par. 22-84 - par. 4-19 Hz]	Resolution 0.033 Hz. Only visible when <i>parameter 22-82 Work Point Calculation</i> is set to [0] Disabled. Enter the motor speed in Hz at which the system design working point is achieved. Alternatively, enter the speed in RPM in <i>parameter 22-85 Speed at Design Point [RPM]</i> . If it has been decided to use Hz in <i>parameter 0-02 Motor Speed Unit</i> ,

22-86 Speed at Design Point [Hz]		
Range:		Function:
		<i>parameter 22-83 Speed at No-Flow [RPM]</i> should also be used.

22-87 Pressure at No-Flow Speed		
Range:		Function:
0*	[0 - par. 22-88]	Enter the pressure H_{MIN} corresponding to speed at no-flow in reference/feedback units.

22-88 Pressure at Rated Speed		
Also see <i>parameter 22-82 Work Point Calculation</i> .		
Range:		Function:
999999.999*	[par. 22-87 - 999999.999]	Enter the value corresponding to the pressure at rated speed, in reference/feedback units. This value can be defined using the pump datasheet.

22-89 Flow at Design Point		
Also see <i>parameter 22-82 Work Point Calculation</i> .		
Range:		Function:
0*	[0 - 999999.999]	Enter the value corresponding to the flow at design point. No units necessary.

22-90 Flow at Rated Speed		
Also see <i>parameter 22-82 Work Point Calculation</i> .		
Range:		Function:
0*	[0 - 999999.999]	Enter the value corresponding to flow at rated speed. This value can be defined using the pump data sheet.

3.21 Parameters: 23-** Time-based Functions

3.21.1 23-0* timed actions

Use *timed actions* for actions that must be performed on a daily or weekly basis, for example different references for working hours/non-working hours. Up to 10 timed actions can be programmed in the frequency converter. The timed action number is selected from the list when entering parameter group 23-0* *Timed Actions* from the LCP. *Parameter 23-00 ON Time* and *parameter 23-04 Occurrence* then refer to the selected timed action number. Each timed action is divided into an ON time and an OFF time, in which 2 different actions may be performed.

Display lines 2 and 3 in the LCP show the status for timed actions mode (0-23 *Display Line 2 Large* and 0-24 *Display Line 3 Large*, setting [1643] *Timed Actions Status*).

NOTICE

A change in mode via the digital inputs can only take place if *parameter 23-08 Timed Actions Mode* is set for [0] *Times Actions Auto*.

If commands are applied simultaneously to the digital inputs for constant OFF and constant ON, the timed actions mode changes to timed actions auto and the 2 commands are disregarded.

If *parameter 0-70 Date and Time* is not set or the frequency converter is set to *Hand* or *OFF* mode (for Example via the LCP), the timed actions mode is changed to *Timed Actions Disabled*.

The timed actions have a higher priority than the same actions/commands activated by the digital inputs or the smart logic controller.

The actions programmed in timed actions are merged with corresponding actions from digital inputs, control word via bus, and smart logic controller, according to merge rules set up in parameter group 8-5* *Digital/Bus*.

NOTICE

Programme the clock (parameter group 0-7* *Clock Settings*) correctly for timed actions to function.

NOTICE

When mounting an analog I/O MCB 109 option card, a battery back-up of the date and time is included.

NOTICE

The PC-based configuration tool MCT 10 Set-up Software comprises a special guide for easy programming of timed actions.

23-00 ON Time		
Array [10]		
Range:		Function:
Size related*	[0 - 0]	Sets the ON time for the timed action.
<p>NOTICE</p> <p>The frequency converter has no back-up of the clock function and the set date/time resets to default (2000-01-01 00:00) after a power-down unless a real time clock-module with back-up is installed. In <i>parameter 0-79 Clock Fault</i>, it is possible to programme a warning if the clock has not been set properly, for example after a power-down.</p>		

23-01 ON Action		
Arra [10]		
Option:		Function:
		<p>NOTICE</p> <p>For options [32] <i>Set digital out A low</i>-[43] <i>Set digital out F high</i>, see also parameter group 5-3* <i>Digital Outputs</i> and 5-4* <i>Relays</i>.</p> <p>Select the action during ON time. See <i>parameter 13-52 SL Controller Action</i> for descriptions of the options.</p>
[0] *	Disabled	
[1]	No action	
[2]	Select set-up 1	
[3]	Select set-up 2	
[4]	Select set-up 3	
[5]	Select set-up 4	
[10]	Select preset ref 0	
[11]	Select preset ref 1	
[12]	Select preset ref 2	
[13]	Select preset ref 3	
[14]	Select preset ref 4	
[15]	Select preset ref 5	
[16]	Select preset ref 6	
[17]	Select preset ref 7	
[18]	Select ramp 1	
[19]	Select ramp 2	
[22]	Run	
[23]	Run reverse	
[24]	Stop	
[26]	DC Brake	
[27]	Coast	
[32]	Set digital out A low	

23-01 ON Action		
Array [10]		
Option:	Function:	
[33]	Set digital out B low	
[34]	Set digital out C low	
[35]	Set digital out D low	
[36]	Set digital out E low	
[37]	Set digital out F low	
[38]	Set digital out A high	
[39]	Set digital out B high	
[40]	Set digital out C high	
[41]	Set digital out D high	
[42]	Set digital out E high	
[43]	Set digital out F high	
[60]	Reset Counter A	
[61]	Reset Counter B	
[62]	Counter A (up)	
[63]	Counter A (down)	
[64]	Counter B (up)	
[65]	Counter B (down)	
[80]	Sleep Mode	
[90]	Set ECB Bypass Mode	
[91]	Set ECB Drive Mode	
[100]	Reset Alarms	

23-02 OFF Time		
Array [10]		
Range:	Function:	
Size related*	[0 - 0]	Sets the OFF time for the timed action. NOTICE The frequency converter has no back-up of the clock function and the set date/time is reset to default (2000-01-01 00:00) after a power-down unless a real time clock module, with back-up is installed. In <i>parameter 0-79 Clock Fault</i> , it is possible to programme a warning if the clock has not been set properly, for example after a power-down.

23-03 OFF Action		
Array [10]		
Option:	Function:	
		Select the action during OFF time. See <i>parameter 13-52 SL Controller Action</i> for descriptions of the options.
[1] *	No action	
[2]	Select set-up 1	
[3]	Select set-up 2	
[4]	Select set-up 3	

23-03 OFF Action		
Array [10]		
Option:	Function:	
[5]	Select set-up 4	
[10]	Select preset ref 0	
[11]	Select preset ref 1	
[12]	Select preset ref 2	
[13]	Select preset ref 3	
[14]	Select preset ref 4	
[15]	Select preset ref 5	
[16]	Select preset ref 6	
[17]	Select preset ref 7	
[18]	Select ramp 1	
[19]	Select ramp 2	
[22]	Run	
[23]	Run reverse	
[24]	Stop	
[26]	DC Brake	
[27]	Coast	
[32]	Set digital out A low	
[33]	Set digital out B low	
[34]	Set digital out C low	
[35]	Set digital out D low	
[36]	Set digital out E low	
[37]	Set digital out F low	
[38]	Set digital out A high	
[39]	Set digital out B high	
[40]	Set digital out C high	
[41]	Set digital out D high	
[42]	Set digital out E high	
[43]	Set digital out F high	
[60]	Reset Counter A	
[61]	Reset Counter B	
[62]	Counter A (up)	
[63]	Counter A (down)	
[64]	Counter B (up)	
[65]	Counter B (down)	
[80]	Sleep Mode	
[90]	Set ECB Bypass Mode	
[91]	Set ECB Drive Mode	
[100]	Reset Alarms	

23-04 Occurrence		
Array [10]		
Option:	Function:	
	Select which day(s) the timed action applies to. Specify working/non-working days in <ul style="list-style-type: none"> Parameter 0-81 Working Days. Parameter 0-82 Additional Working Days. Parameter 0-83 Additional Non-Working Days. 	
[0] *	All days	
[1]	Working days	
[2]	Non-working days	
[3]	Monday	
[4]	Tuesday	
[5]	Wednesday	
[6]	Thursday	
[7]	Friday	
[8]	Saturday	
[9]	Sunday	

23-08 Timed Actions Mode		
Used to enable and disable automatic timed actions.		
Option:	Function:	
[0] *	Timed Actions Auto	Enable timed actions.
[1]	Timed Actions Disabled	Disable timed actions, normal operation according to control commands.
[2]	Constant On Actions	Disable timed actions. Constant On Actions activated.
[3]	Constant Off Actions	Disable timed actions. Constant Off Actions activated.

23-09 Timed Actions Reactivation		
Option:	Function:	
[0]	Disabled	After an update of time/condition <ul style="list-style-type: none"> power cycling setting date time change of summertime change of Hand Auto mode change of Constant ON and OFF set-up change all activated ON actions are overridden to OFF actions until passing the next time for an ON action. Any OFF actions remain unchanged.

23-09 Timed Actions Reactivation		
Option:	Function:	
[1] *	Enabled	After an update of time/condition On and OFF actions are immediately set to the actual time programming of ON and OFF actions.

To see an example of a reactivation test, see *Illustration 3.60*.

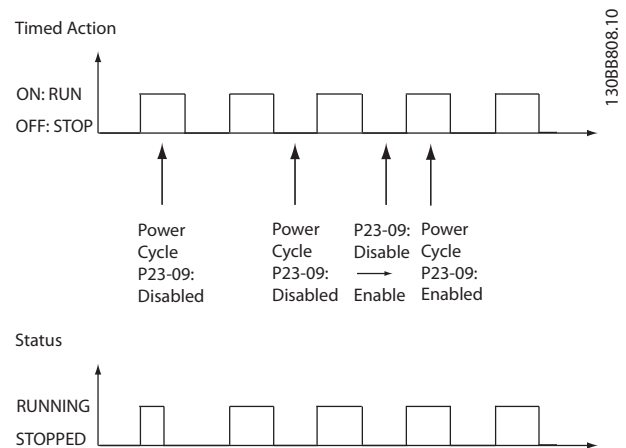

Illustration 3.60 Reactivation Test Diagram

3.21.2 23-1* Maintenance

Wear and tear calls for periodic inspection and service of elements in the application, for example motor bearings, feedback sensors and seals, or filters. With preventive maintenance the service intervals may be programmed into the frequency converter. The frequency converter gives a message when maintenance is required. 20 preventive maintenance events can be programmed into the frequency converter. Specify the following for each event:

- Maintenance item (for example Motor Bearings).
- Maintenance action (for example Replace).
- Maintenance time base (for example Running Hours or a specific date and time).
- Maintenance time interval or the date and time of next maintenance.

NOTICE

To disable a preventive maintenance event, set the associated *parameter 23-12 Maintenance Time Base* to [0] Disabled.

Preventive maintenance can be programmed from the LCP, but use of the PC-based VLT Motion Control Tool MCT 10 Set-up Software is recommended.

ID	Name	Setup 1	Setup 2	Setup 3	Setup 4
2310.0	Maintenance Item	Motor bearings	Motor bearings	Motor bearings	Motor bearings
2310.1	Maintenance Item	Motor bearings	Motor bearings	Motor bearings	Motor bearings
2310.2	Maintenance Item	Motor bearings	Motor bearings	Motor bearings	Motor bearings
2310.3	Maintenance Item	Motor bearings	Motor bearings	Motor bearings	Motor bearings
2310.4	Maintenance Item	Motor bearings	Motor bearings	Motor bearings	Motor bearings
2310.5	Maintenance Item	Motor bearings	Motor bearings	Motor bearings	Motor bearings
2310.6	Maintenance Item	Motor bearings	Motor bearings	Motor bearings	Motor bearings
2310.7	Maintenance Item	Motor bearings	Motor bearings	Motor bearings	Motor bearings
2310.8	Maintenance Item	Motor bearings	Motor bearings	Motor bearings	Motor bearings
2310.9	Maintenance Item	Motor bearings	Motor bearings	Motor bearings	Motor bearings
2310.10	Maintenance Item	Motor bearings	Motor bearings	Motor bearings	Motor bearings
2310.11	Maintenance Item	Motor bearings	Motor bearings	Motor bearings	Motor bearings
2310.12	Maintenance Item	Motor bearings	Motor bearings	Motor bearings	Motor bearings
2310.13	Maintenance Item	Motor bearings	Motor bearings	Motor bearings	Motor bearings
2310.14	Maintenance Item	Motor bearings	Motor bearings	Motor bearings	Motor bearings
2310.15	Maintenance Item	Motor bearings	Motor bearings	Motor bearings	Motor bearings
2310.16	Maintenance Item	Motor bearings	Motor bearings	Motor bearings	Motor bearings
2310.17	Maintenance Item	Motor bearings	Motor bearings	Motor bearings	Motor bearings
2310.18	Maintenance Item	Motor bearings	Motor bearings	Motor bearings	Motor bearings
2310.19	Maintenance Item	Motor bearings	Motor bearings	Motor bearings	Motor bearings
2311.0	Maintenance Action	Lubricate	Lubricate	Lubricates	Lubricate
2311.2	Maintenance Action	Lubricate	Lubricate	Lubricates	Lubricate
2311.3	Maintenance Action	Lubricate	Lubricate	Lubricates	Lubricate
2311.4	Maintenance Action	Lubricate	Lubricate	Lubricates	Lubricate
2311.5	Maintenance Action	Lubricate	Lubricate	Lubricates	Lubricate
2311.6	Maintenance Action	Lubricate	Lubricate	Lubricates	Lubricate

Illustration 3.61 MCT 10 Set-up Software

The LCP indicates (with a wrench icon and an “M”) when it is time for a preventive maintenance action, and can be programmed to be indicated on a digital output in parameter group 5-3* *Digital Outputs*. The preventive maintenance status may be read in *parameter 16-96 Maintenance Word*. A preventive maintenance indication can be reset from a digital input, the FC bus, or manually from the LCP through *parameter 23-15 Reset Maintenance Word*.

A maintenance log with the latest 10 loggings can be read from parameter group 18-0* *Maintenance Log* and via the alarm log key on the LCP after selecting maintenance log.

NOTICE

The preventive maintenance events are defined in a 20-element array. Hence each preventive maintenance event must use the same array element index in *parameter 23-10 Maintenance Item* to *parameter 23-14 Maintenance Date and Time*.

23-10 Maintenance Item		
Array [20]		
Option:	Function:	
	Array with 20 elements displayed below parameter number in the display. Press [OK] and step between elements with [◀], [▶], [▲] and [▼]. Select the item to be associated with the preventive maintenance event.	
[1] *	Motor bearings	
[2]	Fan bearings	
[3]	Pump bearings	
[4]	Valve	
[5]	Pressure transmitter	
[6]	Flow transmitter	
[7]	Temperature transm.	
[8]	Pump seals	
[9]	Fan belt	
[10]	Filter	
[11]	Drive cooling fan	
[12]	System health check	
[13]	Warranty	
[20]	Maintenance Text 0	
[21]	Maintenance Text 1	
[22]	Maintenance Text 2	
[23]	Maintenance Text 3	
[24]	Maintenance Text 4	
[25]	Maintenance Text 5	

23-11 Maintenance Action		
Array [20]		
Option:	Function:	
	Select the action to be associated with the preventive maintenance event.	
[1] *	Lubricate	
[2]	Clean	
[3]	Replace	
[4]	Inspect/Check	
[5]	Overhaul	
[6]	Renew	
[7]	Check	
[20]	Maintenance Text 0	
[21]	Maintenance Text 1	
[22]	Maintenance Text 2	
[23]	Maintenance Text 3	
[24]	Maintenance Text 4	

23-11 Maintenance Action		
Array [20]		
Option:	Function:	
[25]	Maintenance Text 5	

23-12 Maintenance Time Base		
Array [20]		
Option:	Function:	
		Select the time base to be associated with the preventive maintenance event.
[0] *	Disabled	Disables the preventive maintenance event.
[1]	Running Hours	The number of hours the motor has been running. Running hours are not reset at power-on. Specify the maintenance time interval in <i>parameter 23-13 Maintenance Time Interval</i> .
[2]	Operating Hours	The number of hours the frequency converter has been running. Operating hours are not reset at power-on. Specify the maintenance time interval in <i>parameter 23-13 Maintenance Time Interval</i> .
[3]	Date & Time	Uses the internal clock. Specify the date and time of the next maintenance occurrence in <i>parameter 23-14 Maintenance Date and Time</i> .

23-13 Maintenance Time Interval		
Array [20]		
Range:	Function:	
1 h*	[1 - 2147483647 h]	Set the interval associated with the current preventive maintenance event. This parameter is only used if [1] <i>Running Hours</i> or [2] <i>Operating Hours</i> is selected in <i>parameter 23-12 Maintenance Time Base</i> . The timer is reset from <i>parameter 23-15 Reset Maintenance Word</i> . Example A preventive maintenance event is set up Monday at 8:00. <i>Parameter 23-12 Maintenance Time Base</i> is [2] <i>Operating hours</i> and <i>parameter 23-13 Maintenance Time Interval</i> is 7 x 24 hours=168 hours. Next maintenance event is indicated the following Monday at 8:00. If this maintenance event is not reset until Tuesday at 9:00, the next occurrence is the following Tuesday at 9:00.

23-14 Maintenance Date and Time		
Array [20]		
Range:		Function:
Size related*	[0 - 0]	Set the date and time for next maintenance occurrence if the preventive maintenance event is based on date/time. Date format depends on the setting in <i>parameter 0-71 Date Format</i> while the time format depends on the setting in <i>parameter 0-72 Time Format</i> .
<p>NOTICE</p> <p>The frequency converter has no back-up of the clock function and the set date/time is reset to default (2000-01-01 00:00) after a power-down. In <i>parameter 0-79 Clock Fault</i> it is possible to programme a warning if the clock has not been set properly, for example after a power-down. The time set must be at least 1 hour later than actual time!</p> <p>NOTICE</p> <p>When mounting an analog I/O MCB 109 option card, a battery back-up of the date and time is included.</p>		

23-15 Reset Maintenance Word		
Option:		Function:
<p>NOTICE</p> <p>When messages are reset - maintenance item, action and maintenance date/time are not cancelled. <i>Parameter 23-12 Maintenance Time Base</i> is set to [0] Disabled.</p> <p>Set this parameter to [1] Do reset to reset the maintenance word in <i>parameter 16-96 Maintenance Word</i> and reset the message displayed in the LCP. This parameter changes back to [0] Do not reset when pressing [OK].</p>		
[0] *	Do not reset	
[1]	Do reset	

23-16 Maintenance Text		
Array [6]		
Range:		Function:
0*	[0 - 20]	6 individual texts (Maintenance Text 0...Maintenance Text 5) can be written for use in either <i>parameter 23-10 Maintenance Item</i> or <i>parameter 23-11 Maintenance Action</i> .

23-16 Maintenance Text		
Array [6]		
Range:		Function:
		The text is written according to the guidelines in <i>parameter 0-37 Display Text 1</i> .

3.21.3 23-5* Energy Log

The frequency converter is continuously accumulating the consumption of the motor controlled, based on the actual power yielded by the frequency converter.

These data can be used for an energy log function allowing the user to compare and structure the information about the energy consumption related to time.

There are basically 2 functions:

- Data related to a pre-programmed period, defined by a set date and time for start.
- Data related to a predefined period back in time, for example last 7 days within the pre-programmed period.

For each of the above 2 functions, the data are stored in a number of counters allowing for selecting time frame and a split on hours, days, or weeks.

The period/split (resolution) can be set in *parameter 23-50 Energy Log Resolution*.

The data is based on the value registered by the kWh counter in the frequency converter. This counter value can be read in *parameter 15-02 kWh Counter* containing the accumulated value since the first power-up or latest reset of the counter (*parameter 15-06 Reset kWh Counter*).

All data for the energy log is stored in counters, which can be read from *parameter 23-53 Energy Log*.

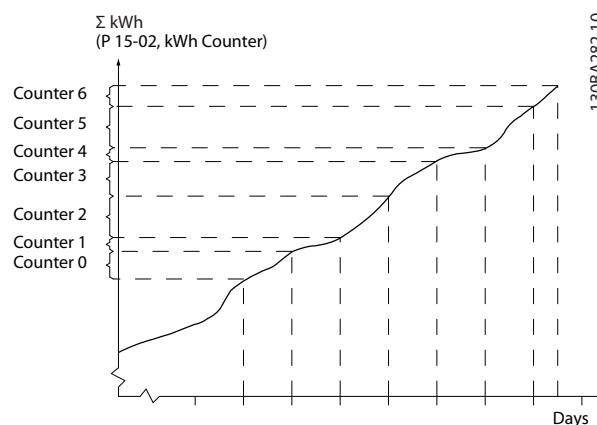

Illustration 3.62 Energy Log Graph

Counter 00 always contains the oldest data. A counter covers a period from XX:00 to XX:59 if hours or 00:00 to 23:59 if days.

If logging either the last hours or last days, the counters shift contents at XX:00 every hour or at 00:00 every day. The counter with highest index is always subject to update (containing data for the actual hour since XX:00 or the actual day since 00:00).

The contents of counters can be displayed as bars on the LCP. Select *Quick Menu, Loggings, Energy Log: Trending Continued Bin/Trending Timed Bin/Trending Comparison*.

23-50 Energy Log Resolution	
Option:	Function:
	<p>NOTICE</p> <p>The frequency converter has no back-up of the clock function and the set date/time resets to default (2000-01-01 00:00) after a power-down unless a real time clock-module with back-up is installed. Consequently, the logging is stopped until date/time is readjusted in <i>parameter 0-70 Date and Time</i>. In <i>parameter 0-79 Clock Fault</i> it is possible to programme a warning if the clock not has been set properly, for example after a power-down.</p> <p>Select the desired type of period for logging of consumption. [0] Hour of Day, [1] Day of Week, or [2] Day of Month. The counters contain the logging data from the programmed date/time for start (<i>parameter 23-51 Period Start</i>) and the numbers of hours/days as programmed for (<i>parameter 23-50 Energy Log Resolution</i>).</p> <p>The logging starts on the date programmed in <i>parameter 23-51 Period Start</i>, and continues until 1 day/week/month has passed. [5] Last 24 Hours, [6] Last 7 Days or [7] Last 5 Weeks.</p> <p>The counters contain data for 1 day, 1 week or 5 weeks back in time, and up to the actual time.</p> <p>The logging starts at the date programmed in <i>parameter 23-51 Period Start</i>. In all cases, the period split refers to operating hours (time where frequency converter is powered up).</p>
[0]	Hour of Day
[1]	Day of Week
[2]	Day of Month
[5] *	Last 24 Hours
[6]	Last 7 Days

23-50 Energy Log Resolution	
Option:	Function:
[7]	Last 5 Weeks

23-51 Period Start	
Range:	Function:
Size related* [0 - 0]	<p>NOTICE</p> <p>When mounting an analog I/O MCB 109 option card, a battery back-up of the date and time is included.</p> <p>Set the date and time at which the energy log starts updating the counters. First, data are stored in counter [00] and start at the time/date programmed in this parameter.</p> <p>Date format depends on setting in <i>parameter 0-71 Date Format</i> and time format on setting in <i>parameter 0-72 Time Format</i>.</p>

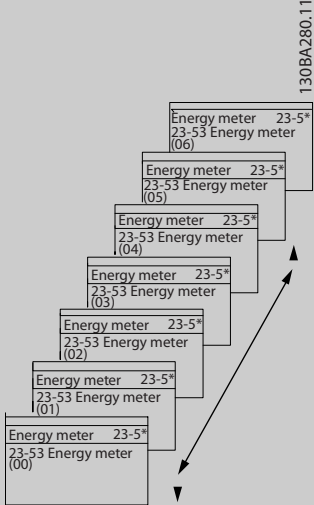
23-53 Energy Log	
Array [31]	
Range:	Function:
0* [0 - 4294967295]	<p>NOTICE</p> <p>All counters are automatically reset when changing the setting in <i>parameter 23-50 Energy Log Resolution</i>. At overflow, the update of the counters stops at maximum value.</p> <p>NOTICE</p> <p>When mounting an analog I/O MCB 109 option card, a battery back-up of the date and time is included.</p> <p>Array with a number of elements equal to the number of counters ([00]-[xx] below parameter number in display). Press [OK] and step between elements with [▲] and [▼].</p> <p>Array elements:</p>  <p>Illustration 3.63 Energy Log</p> <p>Data from latest period are stored in the counter with the highest index. At power-down, all counter values are stored and resumed at next power-up.</p>

23-54 Reset Energy Log	
Option:	Function:
[1]	Do reset
[0] *	Do not reset

23-54 Reset Energy Log	
Option:	Function:
[1]	Do reset

3.21.4 23-6* Trending

Trending is used to monitor a process variable over a period of time and record how often the data fall into each of 10 user-defined data ranges. This is a convenient tool to obtain a quick overview indicating where to focus on improvement of operation.

2 sets of data for trending can be created to make it possible to compare current values for a selected operating variable with data for a certain reference period, for the same variable. This reference period can be pre-programmed (*parameter 23-63 Timed Period Start* and *parameter 23-64 Timed Period Stop*). The 2 sets of data can be read from *parameter 23-61 Continuous Bin Data* (current) and *parameter 23-62 Timed Bin Data* (reference).

It is possible to create trending for following operation variables:

- Power
- Current
- Output frequency
- Motor speed

The trending function includes 10 counters (forming a bin) for each set of data containing the numbers of registrations reflecting how often the operating variable is within each of 10 pre-defined intervals. The sorting is based on a relative value of the variable.

The relative value for the operating variable is

$$\text{Actual/rated} * 100\%$$

for power and current, and

$$\text{actual/max} * 100\%$$

for output frequency and motor speed.

The size of each interval can be adjusted individually, but is 10% for each for default. Power and current can exceed rated value, but those registrations are included in 90%-100% (MAX) counter.

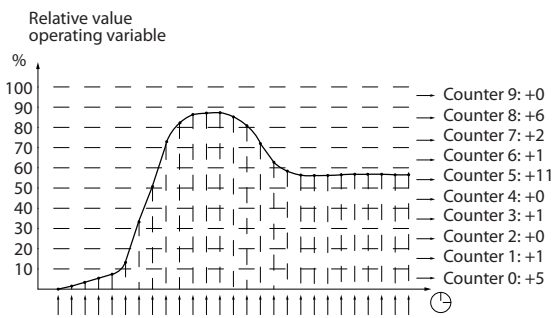

Illustration 3.64 Time and Relative Values

130BA281.10

Once a second, the value of the operating variable selected is registered. If a value has been registered to equal 13%, the counter 10- <20% is updated with the value 1. If the value stays at 13% for 10 s, 10 is added to the counter value.

The contents of counters can be displayed as bars on the LCP. Select *Quick Menu*⇒*Loggings: Trending Continued Bin/Trending Timed Bin/Trending Comparison*.

NOTICE

The counters start counting whenever the frequency converter is powered up. Power cycle shortly after a reset zeros the counters. EEPROM data are updated once per hour.

23-60 Trend Variable		
Option:	Function:	
		Select the desired operating variable to be monitored for trending.
[0]	Power [kW]	Power yielded to the motor. Reference for the relative value is the rated motor power programmed in <i>parameter 1-20 Motor Power [kW]</i> or <i>parameter 1-21 Motor Power [HP]</i> . Actual value can be read in <i>parameter 16-10 Power [kW]</i> or <i>parameter 16-11 Power [hp]</i> .
[1]	Current [A]	Output current to the motor. Reference for the relative value is the rated motor current programmed in <i>parameter 1-24 Motor Current</i> . Actual value can be read in <i>parameter 16-14 Motor current</i> .
[2]	Frequency [Hz]	Output frequency to the motor. Reference for the relative value is the maximum output frequency programmed in <i>parameter 4-14 Motor Speed High Limit [Hz]</i> . Actual value can be read in <i>parameter 16-13 Frequency</i> .
[3]	Motor Speed [RPM]	Speed of the motor. Reference for relative value is the maximum motor speed programmed in <i>parameter 4-13 Motor Speed High Limit [RPM]</i> .

23-61 Continuous Bin Data		
Range:	Function:	
0* [0 - 4294967295]	<p>Array with 10 elements ([0]-[9] below parameter number in display). Press [OK] and step between elements with [▲] and [▼].</p> <p>10 counters with the frequency of occurrence for the operating variable monitored, sorted according to the following intervals:</p> <ul style="list-style-type: none"> Counter [0]: 0-<10% Counter [1]: 10-<20% Counter [2]: 20-<30% Counter [3]: 30-<40% Counter [4]: 40-<50% Counter [5]: 50-<60% Counter [6]: 60-<70% Counter [7]: 70-<80% Counter [8]: 80-<90% Counter [9]: 90-<100% or max <p>The above minimum limits for the intervals are the default limits. These can be changed in <i>parameter 23-65 Minimum Bin Value</i>.</p> <p>Starts to count when the frequency converter is powered up for the first time. All counters can be reset to 0 in <i>parameter 23-66 Reset Continuous Bin Data</i>.</p>	

23-62 Timed Bin Data		
Range:	Function:	
0* [0 - 4294967295]	<p>Array with 10 elements ([0]-[9] below parameter number in display). Press [OK] and step between elements with [▲] and [▼].</p> <p>10 counters with the frequency of occurrence for the operating data monitored sorted according to the intervals as for <i>parameter 23-61 Continuous Bin Data</i>.</p> <p>Starts to count at the date/time programmed in <i>parameter 23-63 Timed Period Start</i>, and stops at the time/date programmed in <i>parameter 23-64 Timed Period Stop</i>. All counters can be reset to 0 in <i>parameter 23-67 Reset Timed Bin Data</i>.</p>	

23-63 Timed Period Start		
Range:	Function:	
Size related* [0 - 0]	<p>NOTICE</p> <p>The frequency converter has no back-up of the clock function and the set date/time is reset to default (2000-01-01 00:00) after a power-down unless a real time clock-module with back-up is installed. Consequently, the logging is stopped until date/time is readjusted in <i>parameter 0-70 Date and Time</i>. In <i>parameter 0-79 Clock Fault</i> it is possible to programme a warning if in case the clock has not been set properly, for example after a power-down.</p> <p>NOTICE</p> <p>When mounting an analog I/O MCB 109 option card, a battery back-up of the date and time is included.</p> <p>Set the date and time at which the trending starts the update of the timed bin counters.</p> <p>Date format depends on setting in <i>parameter 0-71 Date Format</i>, and time format on setting in <i>parameter 0-72 Time Format</i>.</p>	

23-64 Timed Period Stop		
Range:	Function:	
Size related* [0 - 0]	<p>NOTICE</p> <p>When mounting an analog I/O MCB 109 option card, a battery back-up of the date and time is included.</p> <p>Set the date and time at which the trend analyses must stop updating the timed bin counters.</p>	

23-64 Timed Period Stop		
Range:	Function:	
	Date format depends on setting in <i>parameter 0-71 Date Format</i> , and time format on setting in <i>parameter 0-72 Time Format</i> .	

23-65 Minimum Bin Value		
Range:	Function:	
Size related* [0 - 100 %]	<p>Array with 10 elements ([0]-[9] below parameter number in display). Press [OK] and step between elements with [▲] and [▼].</p> <p>Set the minimum limit for each interval in <i>parameter 23-61 Continuous Bin Data</i> and <i>parameter 23-62 Timed Bin Data</i>. Example: If selecting [1] counter and changing setting from 10% to 12%, [0] counter is based on the interval 0-<12% and [1] counter on interval 12%-<20%.</p>	

23-66 Reset Continuous Bin Data		
Option:	Function:	
[0] * Do not reset	Select [1] Do reset to reset all values in <i>parameter 23-61 Continuous Bin Data</i> . After pressing [OK], the setting of the parameter value automatically changes to [0] Do not reset.	
[1] Do reset		

23-67 Reset Timed Bin Data		
Option:	Function:	
	Select [1] Do reset to reset all counters in <i>parameter 23-62 Timed Bin Data</i> . After pressing [OK], the setting of the parameter value automatically changes to [0] Do not reset.	
[0] * Do not reset		
[1] Do reset		

3.21.5 23-8* Payback Counter

The frequency converter includes a feature which can give a rough calculation on payback in cases where the frequency converter has been installed in an existing plant to ensure energy savings. Reference for the savings is a set value to represent the average power yielded before the upgrade with variable speed control.

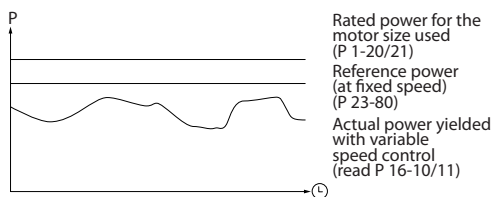

130BA259.11

Illustration 3.65 Variable Speed Control

The difference between the reference power at fixed speed and the actual power yielded with speed control represent the actual saving.

As value for the fixed speed case, the rated motor size (kW) is multiplied with a factor (set in %) representing the power produced at fixed speed. The difference between this reference power and the actual power is accumulated and stored. The difference in energy can be read in *parameter 23-83 Energy Savings*.

The accumulated value for the difference in power consumption is multiplied with the energy cost in local currency and the investment is subtracted. This calculation for cost savings can also be read in *parameter 23-84 Cost Savings*.

$$\text{Cost Savings} = \left\{ \sum_{t=0}^t \left[(\text{Rated Motor Power} * \text{Power Reference Factor}) - \text{Actual Power Consumption} \right] * \text{Energy Cost} \right\} - \text{Investment Cost}$$

Break even (payback) occurs when the value read in the parameter turns from negative to positive.

It is not possible to reset the energy savings counter, but the counter can be stopped any time by setting *parameter 23-80 Power Reference Factor* to 0.

Parameter for settings		Parameters for readout	
Rated motor power	<i>Parameter 1-20 Motor Power [kW]</i>	Energy savings	<i>Parameter 23-83 Energy Savings</i>
Power reference factor in %	<i>Parameter 23-80 Power Reference Factor</i>	Actual power	<i>Parameter 16-10 Power [kW], parameter 16-11 Power [hp]</i>
Energy cost per kWh	<i>Parameter 23-81 Energy Cost</i>	Cost savings	<i>Parameter 23-84 Cost Savings</i>
Investment	<i>Parameter 23-82 Investment</i>		

Table 3.26 Parameter Overview

23-80 Power Reference Factor		
Range:	Function:	
100 %* [0 - 100 %]	Set the percentage of the rated motor size (set in <i>parameter 1-20 Motor Power [kW]</i> or <i>parameter 1-21 Motor Power [HP]</i>), which should represent the average power yielded at the time running with fixed speed (before upgrade with variable speed control). Must be set to a value different from zero to start counting.	

23-83 Energy Savings		
Range:	Function:	
0 kWh* [0 - 0 kWh]	This parameter allows a readout of the accumulated difference between the reference power and the actual output power. If motor size is set in hp (<i>parameter 1-21 Motor Power [HP]</i>), the equivalent kW value is used for the energy savings.	

23-81 Energy Cost		
Range:	Function:	
1* [0 - 999999.99]	Set the actual cost for a kWh in local currency. If the energy cost is changed later on, it impacts the calculation for the entire period.	

23-84 Cost Savings		
Range:	Function:	
0* [0 - 2147483647]	This parameter allows a readout of the calculation based on the above equation (in local currency).	

23-82 Investment		
Range:	Function:	
0* [0 - 999999999]	Set the value of the investment spent on upgrading the plant with speed control, in same currency as used in <i>parameter 23-81 Energy Cost</i> .	

3.22 Parameters: 24-** Application Functions 2

3.22.1 24-0* Fire Mode

CAUTION

Note the frequency converter is only 1 component of the VLT® HVAC Drive system. Correct function of fire mode depends on the correct design and selection of system components. Ventilation systems working in life safety applications have to be approved by the local fire authorities. Non-interruption of the frequency converter due to fire mode-operation could cause overpressure and result in damage to VLT® HVAC Drive system and components, including dampers and air ducts. The frequency converter itself could be damaged and it may cause damage or fire. Danfoss accepts no responsibility for errors, malfunctions personal injury, or any damage to the frequency converter itself or components herein, VLT® HVAC Drive systems and components herein, or other property when the frequency converter has been programmed for fire mode. In no event shall Danfoss be liable to the end user or any other party for any direct or indirect, special or consequential damage or loss suffered by such party, which has occurred due to the frequency converter being programmed and operated in fire mode.

Background

Fire mode is for use in critical situations, where it is imperative for the motor to keep running, regardless of the frequency converter's normal protective functions. These could be ventilation fans in tunnels or stairwells for instance, where continued operation of the fan facilitates safe evacuation of personnel in the event of a fire. Some selections of the fire mode function cause alarms and trip conditions to be disregarded, enabling the motor to run without interruption.

Activation

Fire mode is activated only via digital Input terminals. See parameter group 5-1* *Digital Inputs*.

Messages in display

When fire mode is activated, the display shows a status message *Fire Mode* and a warning *Fire Mode*.

Once the fire mode is again deactivated, the status messages disappears and the warning is replaced by the warning *Fire M Was Active*. This message can only be reset by power-cycling the frequency converter supply. If a warranty-affecting alarm (see parameter 24-09 *Fire Mode Alarm Handling*) should occur while the frequency converter is active in fire mode, the display shows the warning *Fire M Limits Exceeded*.

Digital and relay outputs can be configured for the status messages *Fire Mode Active* and the warning *Fire M Was Active*. See parameter group 5-3* *Digital Outputs* and parameter group 5-4* *Relays*.

Fire M was Active messages can also be accessed in the warning word via serial communication. (See relevant documentation).

Access the status messages *Fire Mode* via the extended status word.

Message	Type	LCP	Messages in display	Warning word 2	Ext. status word 2
Fire Mode	Status	+	+		+(bit 25)
Fire Mode	Warning	+			
Fire M was Active	Warning	+	+	+(bit 3)	
Fire M Limits Exceeded	Warning	+	+		

Table 3.27 Messages in Display

Log

To see an overview of fire mode-related events, view the fire mode-log, 18-1*, Fire mode log, or press [Alarm Log] on the LCP or via the Alarm Log button on the LCP.

The log includes up to 10 of the latest events. Warranty-affecting alarms have a higher priority than the other 2 types of events.

The log cannot be reset

Following events are logged:

- Warranty-affecting alarms (see *parameter 24-09 Fire Mode Alarm Handling*)
- Fire mode activated
- Fire mode deactivated

All other alarms occurring while fire mode is activated are logged as usual.

NOTICE

During fire mode-operation, all stop commands to the frequency converter are ignored, including coast/coast inverse and external interlock. However, if Safe Torque Off is available in the frequency converter, this function is still active.

NOTICE

If using the live zero-function in fire mode, then it is also active for analog inputs other than that used for fire mode setpoint/feedback. Should the feedback to any of those other analog inputs be lost, for example a cable is burned, live zero-function operates. If this is not wanted, disable the live zero-function for those other inputs.

Set the wanted live zero-function in case of a missing signal when fire mode active in *parameter 6-02 Fire Mode Live Zero Timeout Function*.

Warning for live zero has a higher priority than the warning *Fire Mode*.

NOTICE

If setting the command [11] *Start Reversing* on a digital input terminal in *parameter 5-10 Terminal 18 Digital Input*, the frequency convertor understands this as a reversing command.

24-00 Fire Mode Function		
Option:	Function:	
		NOTICE In the above, alarms are produced or ignored in accordance with the selection in <i>parameter 24-09 Fire Mode Alarm Handling</i> .
[0] *	Disabled	Fire mode-function is not active.
[1]	Enabled-Run Forward	In this mode the motor continues to operate in a clockwise direction. Works only in open loop. Set <i>parameter 24-01 Fire Mode Configuration</i> to [0] <i>Open Loop</i> .
[2]	Enabled-Run Reverse	In this mode the motor continues to operate in a counterclockwise direction. Works only in open loop. Set <i>parameter 24-01 Fire Mode Configuration</i> to [0] <i>Open Loop</i> .
[3]	Enabled-Coast	In this mode, the output is disabled and the motor is allowed to coast to stop.
[4]	Enabled-Run Fwd/Rev	

24-01 Fire Mode Configuration		
Option:	Function:	
		<p>NOTICE</p> <p>Before adjusting the PID controller set parameter 24-09 Fire Mode Alarm Handling, [2] Trip, All Alarms/Test.</p> <p>NOTICE</p> <p>If [2] Enable-Run Reverse is selected in parameter 24-00 Fire Mode Function, [3] Closed Loop cannot be selected in parameter 24-01 Fire Mode Configuration.</p>
[0]	Open Loop *	When fire mode is active, the motor runs with a fixed speed based on a reference set. The unit is the same as selected in parameter 0-02 Motor Speed Unit.
[3]	Closed Loop	When fire mode is active, the built-in PID controller controls the speed based on the setpoint and a feedback signal selected in parameter 24-07 Fire Mode Feedback Source. Select the unit in parameter 24-02 Fire Mode Unit. For other PID controller settings use parameter group 20-** FC Closed Loop as for normal operation. If the motor also is controlled by the built-in PID controller when in normal operation, the same transmitter can be used for both cases by selecting the same source.

24-02 Fire Mode Unit		
Option:	Function:	
		Select the desired unit when fire mode is active and running in closed loop.
[0]	None	
[1]	%	
[2]	RPM	
[3]	Hz	
[4]	Nm	
[5]	PPM	
[10]	l/min	
[11]	RPM	
[12]	Pulse/s	
[20]	l/s	
[21]	l/min	
[22]	l/h	
[23]	m ³ /s	
[24]	m ³ /min	
[25]	m ³ /h	
[30]	kg/s	
[31]	kg/min	
[32]	kg/h	
[33]	t/min	
[34]	t/h	

24-02 Fire Mode Unit		
Option:	Function:	
[40]	m/s	
[41]	m/min	
[45]	m	
[60]	°C	
[70]	mbar	
[71]	bar	
[72]	Pa	
[73]	kPa	
[74]	m WG	
[75]	mm Hg	
[80]	kW	
[120]	GPM	
[121]	gal/s	
[122]	gal/min	
[123]	gal/h	
[124]	CFM	
[125]	ft ³ /s	
[126]	ft ³ /min	
[127]	ft ³ /h	
[130]	lb/s	
[131]	lb/min	
[132]	lb/h	
[140]	ft/s	
[141]	ft/min	
[145]	ft	
[160]	°F	
[170]	psi	
[171]	lb/in ²	
[172]	in WG	
[173]	ft WG	
[174]	in Hg	
[180]	HP	

24-03 Fire Mode Min Reference		
Range:	Function:	
Size related*	[-999999.999 - par. 24-04 FireModeUnit]	Minimum value for the reference/setpoint (limiting the sum of value in parameter 24-05 Fire Mode Preset Reference and value of signal on input selected in parameter 24-06 Fire Mode Reference Source). If running in open loop when fire mode is active, the unit is selected by the setting of parameter 0-02 Motor Speed Unit. For closed loop, select the unit in parameter 24-02 Fire Mode Unit.

24-04 Fire Mode Max Reference		
Range:	Function:	
Size related*	[par. 24-03 - 999999.999 FireModeUnit]	Maximum value for the reference/ setpoint (limiting the sum of value in <i>parameter 24-05 Fire Mode Preset Reference</i> and value of signal on input selected in <i>parameter 24-06 Fire Mode Reference Source</i>). If running in open loop when fire mode is active, the unit is selected by the setting <i>parameter 0-02 Motor Speed Unit</i> . For closed loop, select the unit in <i>parameter 24-02 Fire Mode Unit</i> .

24-05 Fire Mode Preset Reference		
Range:	Function:	
0 %*	[-100 - 100 %]	Enter the required preset reference/set point as a percentage of the Fire Mode Max Reference set in <i>parameter 24-04 Fire Mode Max Reference</i> . The set value is added to the value represented by the signal on the analog input selected in <i>parameter 24-06 Fire Mode Reference Source</i> .

24-06 Fire Mode Reference Source		
Option:	Function:	
		Select the external reference input to be used for the fire mode. This signal is added to the value set in <i>parameter 24-06 Fire Mode Reference Source</i> .
[0] *	No function	
[1]	Analog Input 53	
[2]	Analog Input 54	
[7]	Pulse input 29	
[8]	Pulse input 33	
[20]	Digital pot.meter	
[21]	Analog input X30/11	
[22]	Analog input X30/12	
[23]	Analog Input X42/1	
[24]	Analog Input X42/3	
[25]	Analog Input X42/5	

24-07 Fire Mode Feedback Source		
Option:	Function:	
		Select the feedback input to be used for the fire mode feedback signal when fire mode is active. If the motor also is controlled by the built-in PID controller when in normal operation, the same transmitter can be used for both cases by selecting the same source.
[0] *	No function	
[1]	Analog Input 53	
[2]	Analog Input 54	

24-07 Fire Mode Feedback Source		
Option:	Function:	
[3]	Pulse input 29	
[4]	Pulse input 33	
[7]	Analog Input X30/11	
[8]	Analog Input X30/12	
[9]	Analog Input X42/1	
[10]	Analog Input X42/3	
[11]	Analog Input X42/5	
[15]	Analog Input X48/2	
[100]	Bus Feedback 1	
[101]	Bus Feedback 2	
[102]	Bus feedback 3	
[104]	Sensorless Flow	
[105]	Sensorless Pressure	

24-09 Fire Mode Alarm Handling		
Option:	Function:	
[0]	Trip+Reset, Critical Alarms	If this mode is selected, the frequency converter continues to run, ignoring most alarms, even if doing so may result in damage of the frequency converter. Critical alarms are alarms, which cannot be suppressed but a restart attempt is possible (infinity automatic reset).
[1] *	Trip, Critical Alarms	In case of a critical alarm, the frequency converter trips and does not auto-restart (manual reset).
[2]	Trip, All Alarms/Test	It is possible to test the operation of fire mode, but all alarm states are activated normally (manual reset).

NOTICE

Warranty-affecting alarms. Certain alarms can affect the lifetime of the frequency converter. Should 1 of these ignored alarms occur while in fire mode, a log of the event is stored in the fire mode-log.

Here the 10 latest events of warranty-affecting alarms, fire mode activation, and fire mode deactivation are stored.

NOTICE

The setting in *parameter 14-20 Reset Mode* is disregarded if fire mode is active (see parameter group 24-0* *Fire Mode*).

Number	Description	Critical alarms	Warranty-affecting alarms
4	Mains ph. Loss		x
7	DC overvolt	x	
8	DC undervolt	x	
9	Inverter overloaded		x
13	Over current	x	
14	Earth fault	x	
16	Short circuit	x	
29	Power card temp		x
33	Inrush fault		x
38	Internal fault		x
65	Ctrl. card temp		x
68	Safe Stop	x	

Table 3.28 Fire Mode Alarm Handling

3.22.2 24-1* Drive Bypass

The frequency converter includes a feature, which can be used to automatically activate an external electro-mechanical bypass in case of a trip/trip lock of the frequency converter or the event of a fire mode coast (see *parameter 24-00 Fire Mode Function*).

The bypass switches the motor to operation direct on line. The external bypass is activated by 1 of the digital outputs or relays in the frequency converter, when programmed in parameter group 5-3* *Digital Outputs* or parameter group 5-4* *Relays*.

NOTICE

After enabling the drive bypass function, the frequency converter is no longer safety certified (for using the safe Torque Off in versions, where included).

To deactivate the drive bypass at normal operation (fire mode not activated), carry out 1 of following actions:

- Press [Off] on the LCP, (or program 2 of the digital inputs for Hand On-Off-Auto).
- Activate external interlock via digital input
- Carry out a power cycling.

NOTICE

The drive bypass cannot be deactivated if in fire mode. It can be deactivated only by either removing the fire mode command signal or the power supply to the frequency converter.

When the drive bypass function is activated, the display on the LCP shows the status message *Drive Bypass*. This message has a higher priority than the fire mode status

messages. When the automatic drive bypass function is enabled, it cuts in the external bypass according to the sequence in *Illustration 3.66*

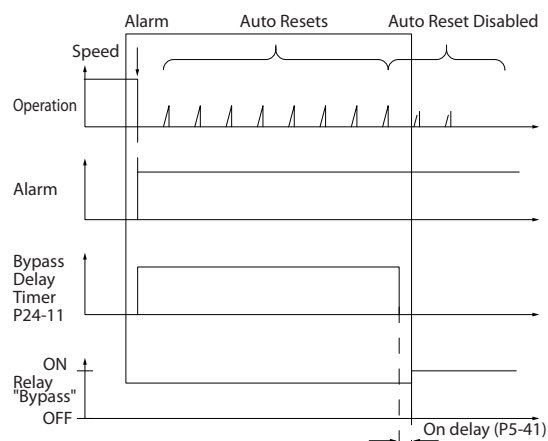

Illustration 3.66 Drive Bypass

Status can be read in the extended status word 2, bit number 24.

24-10 Drive Bypass Function		
Option:	Function:	
		<p>NOTICE</p> <p>After enabling the drive bypass function, the Safe Torque Off function (in versions, where included) is not complying with standard EN 954-1, Cat. 3 installations anymore.</p> <p>This parameter determines which circumstances activate the drive bypass function.</p>
[0] *	Disabled	
[1]	Enabled	<p>If in normal operation, the automatic drive bypass function is activated under the following conditions:</p> <ul style="list-style-type: none"> • In case of a trip lock or a trip. • After the programmed number of reset attempts, programmed in <i>parameter 14-20 Reset Mode</i> • if the Bypass Delay Timer (<i>parameter 24-11 Drive Bypass Delay Time</i>) expires before reset attempts have been completed.
[2]	Enabled (Fire M Only)	

24-11 Drive Bypass Delay Time		
Range:	Function:	
0 s* [0 - 600 s]	<p>Programmable in 1 s increments. Once the bypass function is activated in accordance with the setting in <i>parameter 24-10 Drive Bypass Function</i>, the bypass delay timer begins to operate. If the frequency converter has been set for a number of restart attempts, the timer continues to run while the frequency converter tries to restart. Should the motor have restarted within the time period of the bypass delay timer, the timer is reset.</p> <p>Should the motor fail to restart at the end of the bypass delay time, the drive bypass relay is activated, which has been programmed for bypass in <i>parameter 5-40 Function Relay</i>. If a relay delay has also been programmed in <i>parameter 5-41 On Delay, Relay, [Relay]</i> or <i>parameter 5-42 Off Delay, Relay, [Relay]</i>, this time must also elapse before the relay action is performed.</p> <p>Where no restart attempts are programmed, the timer runs for the delay period set in this parameter and activates the drive bypass relay, which has been programmed for bypass in <i>parameter 5-40 Function Relay</i>. If a relay delay has also been programmed in <i>parameter 5-41 On Delay, Relay or parameter 5-42 Off Delay, Relay, [Relay]</i>, this time must also elapse before the relay action is performed.</p>	

24-90 Missing Motor Function		
Option:	Function:	
	Select the action to be taken if the motor current is below the limit calculated as a function of the output frequency. The function is used for detecting for example a missing motor in multi-motor applications.	
[0] *	Off	
[1]	Warning	

24-91 Missing Motor Coefficient 1		
Range:	Function:	
0* [-10 - 10]	Enter the cubic coefficient of the missing motor detection-function multiplied by 1000.	

24-92 Missing Motor Coefficient 2		
Range:	Function:	
0* [-100 - 100]	Enter the quadratic coefficient of the missing motor detection-function multiplied by 1000.	

24-93 Missing Motor Coefficient 3		
Range:	Function:	
0* [-100 - 100]	Enter the linear coefficient of the missing motor detection-function.	

24-94 Missing Motor Coefficient 4		
Range:	Function:	
0* [-500 - 500]	Enter the constant of the missing motor detection-function.	

24-95 Locked Rotor Function		
Option:	Function:	
	Select the action to be taken if the motor current is above the limit calculated as a function of the output frequency. The function is used for detecting for example, a locked rotor in multi-motor applications.	
[0] *	Off	
[1]	Warning	

24-96 Locked Rotor Coefficient 1		
Range:	Function:	
0* [-10 - 10]	Enter the cubic coefficient of the Locked Rotor detection function multiplied by 1000.	

24-97 Locked Rotor Coefficient 2		
Range:	Function:	
0* [-100 - 100]	Enter the quadratic coefficient of the locked rotor detection function multiplied by 1000.	

24-98 Locked Rotor Coefficient 3		
Range:	Function:	
0* [-100 - 100]	Enter the linear coefficient of the locked rotor detection function.	

24-99 Locked Rotor Coefficient 4		
Range:	Function:	
0* [-500 - 500]	Enter the constant of the locked rotor detection function.	

3.23 Parameters: 25-** Cascade Controller

Parameters for configuring the basic cascade controller for sequence control of multiple pumps. For a more application-oriented description and wiring examples, see *Application Examples, Cascade Controller* in the design guide.

3

To configure the cascade controller to the actual system and the desired control strategy, follow the sequence, starting with parameter group 25-0* *System Settings* and next parameter group 25-5* *Alternation Settings*. These parameters can normally be set in advance.

Parameters in 25-2* *Bandwidth Settings* and 25-4* *Staging Settings* often depend on the dynamic of the system and final adjustment to be d1 at the commissioning of the plant.

NOTICE

The cascade controller is supposed to operate in closed loop controlled by the built-in PI controller ([3] closed loop selected in parameter 1-00 Configuration Mode). If [8] open loop is selected in parameter 1-00 Configuration Mode, all fixed speed pumps are destaged, but the variable speed pump is still controlled by the frequency converter, now as an open-loop configuration:

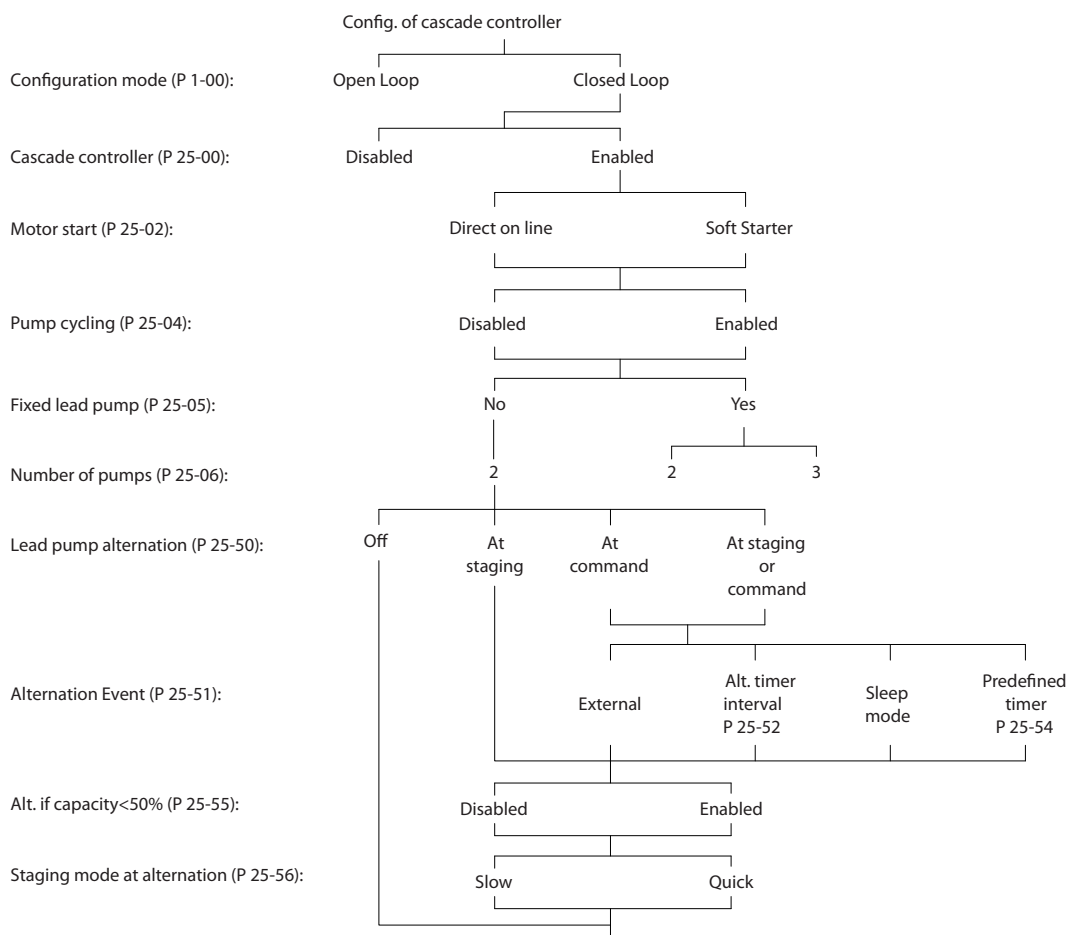

130BA279.12

Illustration 3.67 Cascade Controller Sample Set-up

3.23.1 25-0* System Settings

Parameters related to control principles and configuration of the system.

25-00 Cascade Controller		
Option:	Function:	
		For operation of multiple devices (pump/fan) systems where capacity is adapted to actual load with speed control combined with on/off control of the devices. For simplicity, only pump systems are described.
[0] *	Disabled	The cascade controller is not active. All built-in relays assigned to pump motors in the cascade function are de-energised. If a variable speed pump is connected to the frequency converter directly (not controlled by a built-in relay), this pump/fan is controlled as a single-pump system.
[1]	Enabled	The cascade controller is active and stages/destages pump according to load on the system.

25-02 Motor Start		
Option:	Function:	
		Motors are connected to the mains directly with a contactor or with a soft starter. When the value of <i>parameter 25-02 Motor Start</i> is set to an option other than [0] <i>Direct on Line</i> , then <i>parameter 25-50 Lead Pump Alternation</i> is automatically set to the default of [0] <i>Direct on Line</i> .
[0] *	Direct on Line	Each fixed speed pump is connected to mains directly via a contactor.
[1]	Soft Starter	Each fixed speed pump is connected to mains via a soft starter.
[2]	Star-Delta	Fixed pumps connected with star-delta starters are staged in the same way as pumps connected with soft starters. They are destaged in the same way as pumps connected directly to mains.

25-04 Pump Cycling		
Option:	Function:	
		To provide equal hours of operation with fixed speed pumps, the pump use can be cycled. The selection of pump cycling is either "first in – last out" or equal running hours for each pump.
[0] *	Disabled	The fixed speed pumps are connected in the order 1–2 and disconnected in the order 2–1 (first in–last out).
[1]	Enabled	The fixed speed pumps are connected/disconnected to have equal running hours for each pump.

25-05 Fixed Lead Pump		
Option:	Function:	
		Fixed lead pump means that the variable speed pump is connected directly to the frequency converter, and if a contactor is applied between frequency converter and pump, this contactor is not controlled by the frequency converter. If operating with <i>parameter 25-50 Lead Pump Alternation</i> set to other than [0] <i>Off</i> , set this parameter to [0] <i>No</i> .
[0]	No	The lead pump function can alternate between the pumps controlled by the 2 built-in relays. Connect 1 pump to the built-in <i>RELAY 1</i> , and the other pump to <i>RELAY 2</i> . The pump function (cascade pump1 and cascade pump2) is automatically assigned to the relays (maximum 2 pumps can in this case be controlled by the frequency converter).
[1] *	Yes	The lead pump is fixed (no alternation) and connected directly to the frequency converter. The <i>parameter 25-50 Lead Pump Alternation</i> is automatically set to [0] <i>Off</i> . Built-in relays <i>RELAY 1</i> and <i>RELAY 2</i> can be assigned to separate fixed speed pumps. In total, 3 pumps can be controlled by the frequency converter.

25-06 Number of Pumps		
Range:	Function:	
2* [2 - 3]		The number of pumps connected to the cascade controller including the variable speed pump. If the variable speed pump is connected directly to the frequency converter, and the other fixed speed pumps (lag pumps) are controlled by the 2 built-in relays, 3 pumps can be controlled. If both the variable speed and fixed speed pumps are to be controlled by built-in relays, only 2 pumps can be connected. If <i>parameter 25-05 Fixed Lead Pump</i> is set to [0] <i>No</i> : 1 variable speed pump and 1 fixed speed pump; both controlled by built-in relay. If <i>parameter 25-05 Fixed Lead Pump</i> is set to [1] <i>Yes</i> : 1 variable speed pump and 1 fixed speed pump controlled by built-in relays. 1 lead pump, see <i>parameter 25-05 Fixed Lead Pump</i> . 2 fixed speed pumps controlled by built-in relays.

3.23.2 25-2* Bandwidth Settings

Parameters for setting the bandwidth within which the pressure is allowed to operate before staging/destaging fixed speed pumps. Also includes various timers to stabilise the control.

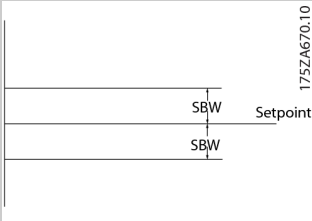
25-20 Staging Bandwidth		
Range:	Function:	
10 %* [1 - 25-21 %]	<p>Set the staging bandwidth (SBW) percentage to accommodate normal system pressure fluctuation. In cascade control systems, to avoid frequent switching of fixed speed pumps, the desired system pressure is typically kept within a bandwidth rather than at a constant level.</p> <p>The SBW is programmed as a percentage of <i>parameter 20-13 Minimum Reference/Feedb.</i> and <i>parameter 20-14 Maximum Reference/Feedb.</i> For example, if the setpoint is 5 bar and the SBW is set to 10%, a system pressure between 4.5 and 5.5 bar is tolerated. No staging or de-staging occur within this bandwidth.</p>	
		
	<p>Illustration 3.69 Staging Bandwidth</p>	

25-21 Override Bandwidth		
Range:	Function:	
100 %* [par. 25-20 - 100 %]	<p>When a large and quick change in the system demand occurs (such as a sudden water demand), the system pressure rapidly changes and an immediate staging or destaging of a fixed speed pump becomes necessary to match the requirement. The override bandwidth (OBW) is programmed to override the staging/destaging timer (<i>parameter 25-23 SBW Staging Delay</i> and <i>parameter 25-24 SBW Destaging Delay</i>) for immediate response.</p> <p>The OBW must always be programmed to a higher value than the value set in <i>parameter 25-20 Staging Bandwidth</i>. The OBW is a percentage of <i>parameter 3-02 Minimum Reference</i> and <i>3-03 Maximum Reference</i>.</p>	

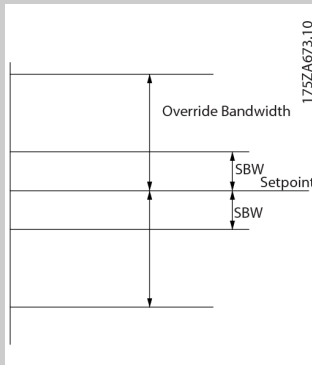
25-21 Override Bandwidth		
Range:	Function:	
		
	<p>Illustration 3.71</p>	
	<p>Setting the OBW too close to the SBW could defeat the purpose with frequent staging at momentary pressure changes. Setting the OBW too high might lead to unacceptably high or low pressure in the system while the SBW timers are running. The value can be optimised with increased familiarity with the system. See <i>parameter 25-25 OBW Time</i>.</p> <p>To avoid unintended staging during the commissioning phase and fine-tuning of the controller, initially leave the OBW at the factory setting of 100% (Off). When the fine-tuning is completed, the OBW should be set to the desired value. An initial value of 10% is suggested.</p>	

25-22 Fixed Speed Bandwidth		
Range:	Function:	
Size related* [par. 25-20 - 25-21 %]	<p>When the cascade control system is running normally and the frequency converter issues a trip alarm, it is important to maintain the system head. The cascade controller does this by continuing to stage/destage the fixed speed pump on and off. Due to the fact that keeping the head at the setpoint would require frequent staging and destaging when only a fixed speed pump is running, a wider fixed speed bandwidth (FSBW) is used instead of SBW. In alarm situations, or if the start signal on the digital input goes low, It is possible to stop the fixed speed pumps by pressing [Off] or [Hand On].</p> <p>If the issued alarm is a trip-lock alarm, the cascade controller stops the system immediately by cutting out all the fixed speed pumps. This is basically the same as emergency stop (coast/coast inverse command) for the cascade controller.</p>	

25-23 SBW Staging Delay		
Range:	Function:	
15 s* [0 - 3000 s]	<p>Immediate staging of a fixed speed pump is not desirable when a momentary pressure drop in the system exceeds the staging bandwidth (SBW). Staging is delayed by the length of time programmed. If the pressure increases within the SBW before the timer has elapsed, the timer is reset.</p>	
<p style="text-align: right; font-size: small;">175ZA672.11</p>		
<p>Illustration 3.72 SBW Staging Delay</p>		

25-25 OBW Time		
Range:	Function:	
	<p>prevent staging until the system pressure has stabilised and normal control established. Set the timer to a value that allows the system to stabilise after staging. The 10 s factory setting is appropriate in most applications. In highly dynamic systems, a shorter time may be wanted.</p>	

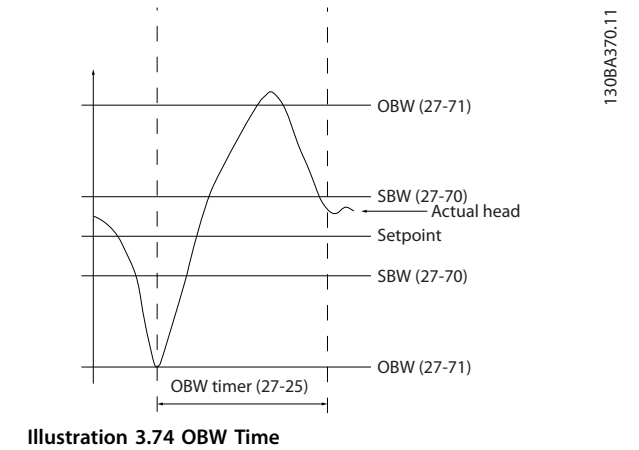

Illustration 3.74 OBW Time

25-24 SBW Destaging Delay		
Range:	Function:	
15 s* [0 - 3000 s]	<p>Immediate destaging of a fixed speed pump is not desirable when a momentary pressure increases in the system that exceeds the staging bandwidth (SBW). Destaging is delayed by the length of time programmed. If the pressure decreases within the SBW before the timer has elapsed, the timer is reset.</p>	
<p style="text-align: right; font-size: small;">175ZA671.11</p>		
<p>Illustration 3.73 SBW Destaging Delay</p>		

25-26 Destage At No-Flow		
Option:	Function:	
	<p>This parameter ensures that when a no-flow situation occurs, the fixed speed pumps are destaged 1-by-1 until the no-flow signal disappears. This requires that no-flow detection is active. See parameter group 22-2* <i>No-Flow Detection</i>. If [0] <i>Disabled</i> is selected, the cascade controller does not change the normal behaviour of the system.</p>	
[0] *	Disabled	
[1]	Enabled	

25-27 Stage Function		
Option:	Function:	
	<p>If the stage function is set to [0] <i>Disabled</i>, parameter 25-28 <i>Stage Function Time</i> is not activated.</p>	
[0]	Disabled	
[1] *	Enabled	

25-25 OBW Time		
Range:	Function:	
10 s* [0 - 300 s]	<p>Staging a fixed speed pump creates a momentary pressure peak in the system, which might exceed the override bandwidth (OBW). It is not desirable to destage a pump in response to a staging pressure peak. The OBW time can be programmed to</p>	

25-28 Stage Function Time		
Range:	Function:	
15 s*	[0 - 300 s]	The stage function time is programmed to avoid frequent staging of the fixed speed pumps. The stage function time starts if it is [1] Enabled by parameter 25-27 Stage Function, and when the variable speed pump is running at motor speed high limit, parameter 4-13 Motor Speed High Limit [RPM] or parameter 4-14 Motor Speed High Limit [Hz], with at least 1 fixed speed pump in the stop position. When the programmed value of the timer expires, a fixed speed pump is staged.

25-29 Destage Function		
Option:	Function:	
		The destage function ensures that the lowest numbers of pumps are running to save energy and to avoid dead head water circulation in the variable speed pump. If the destage function is set to [0] Disabled, parameter 25-30 Destage Function Time is not activated.
[0]	Disabled	
[1] *	Enabled	

25-30 Destage Function Time		
Range:	Function:	
15 s*	[0 - 300 s]	The destage function timer is programmable to avoid frequent staging/destaging of the fixed speed pumps. The destage function time starts when the adjustable speed pump is running at parameter 4-11 Motor Speed Low Limit [RPM] or parameter 4-12 Motor Speed Low Limit [Hz], with 1 or more fixed speed pumps in operation and system requirements satisfied. In this situation, the adjustable speed pump contributes a little to the system. When the programmed value of the timer expires, a stage is removed, avoiding dead head water circulation in the adjustable speed pump.

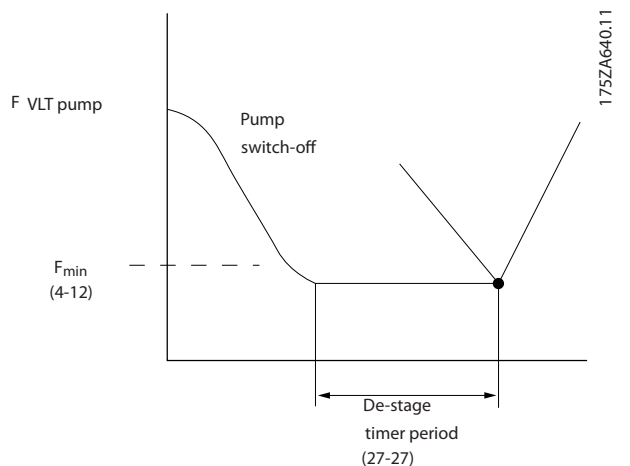

Illustration 3.75 Destage Function Time

3.23.3 25-4* Staging Settings

Parameters determining conditions for staging/destaging the pumps.

25-40 Ramp Down Delay		
Range:	Function:	
10 s*	[0 - 120 s]	When adding a fixed speed pump controlled by a soft starter or a star-delta starter, it is possible to delay the ramp down of the lead pump until a preset time after the start of the fixed speed pump to eliminate pressure surges or water hammer in the system. Use this option only if [1] Soft Starter or [2] Star Delta is selected in parameter 25-02 Motor Start.

25-41 Ramp Up Delay		
Range:	Function:	
2 s*	[0 - 12 s]	When removing a fixed speed pump controlled by a soft starter, it is possible to delay the ramp up of the lead pump until a preset time after the stopping of the fixed speed pump to eliminate pressure surges or water hammer in the system. Only to be used if [1] Soft Starter is selected in parameter 25-02 Motor Start.

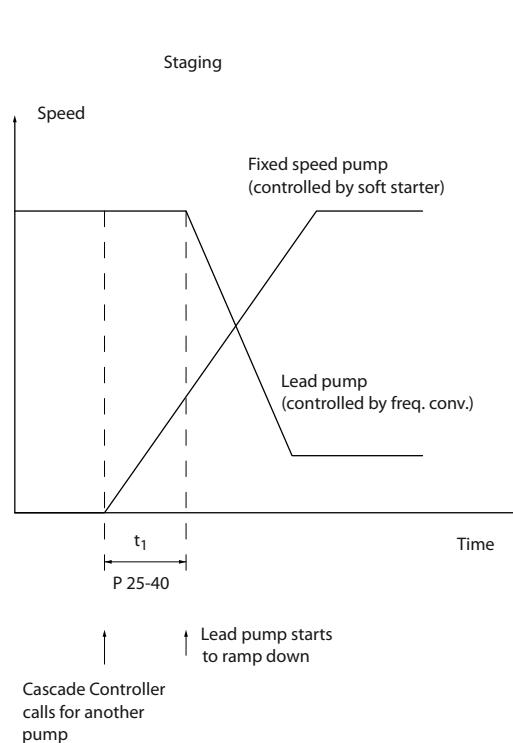
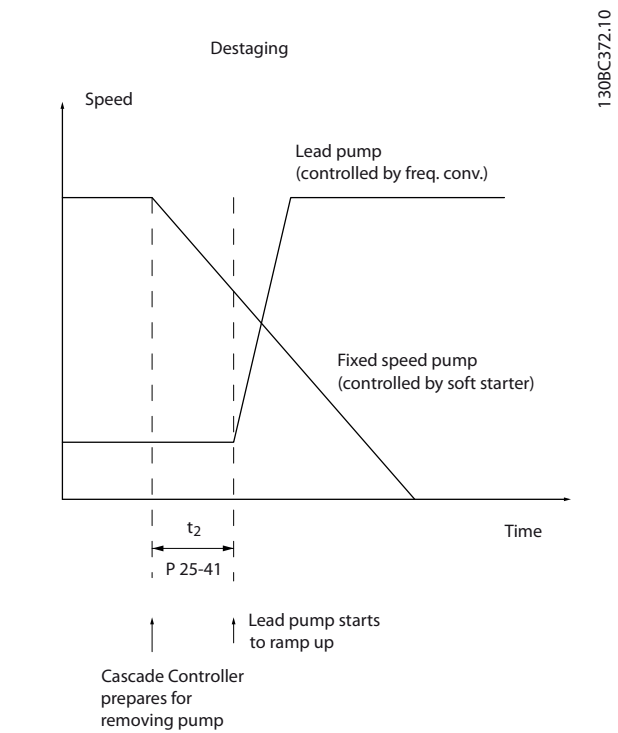

Illustration 3.76 Staging



130BC372.10

Illustration 3.77 Destaging

25-42 Staging Threshold		
Range:	Function:	
Size related* [0 - 100 %]	When adding a fixed speed pump, to prevent an overshoot of pressure, the variable speed pump ramps down to a lower speed. When the variable speed pump reaches the "Staging Speed" the fixed speed pump is staged on. The staging threshold is used to calculate the speed of the variable speed pump when the "cut-in point" of the fixed speed pump occurs. The calculation of the staging threshold is the ratio of <i>parameter 4-11 Motor Speed Low Limit [RPM]</i> or <i>parameter 4-12 Motor Speed Low Limit [Hz]</i> , to the <i>parameter 4-13 Motor Speed High Limit [RPM]</i> or <i>parameter 4-14 Motor Speed High Limit [Hz]</i> , expressed in percent.	
	Staging threshold must range from $STAGE \% = \frac{LOW}{HIGH} \times 100 \%$ to 100%, where n_{LOW} is motor speed low limit and n_{HIGH} is Motor Speed High Limit.	

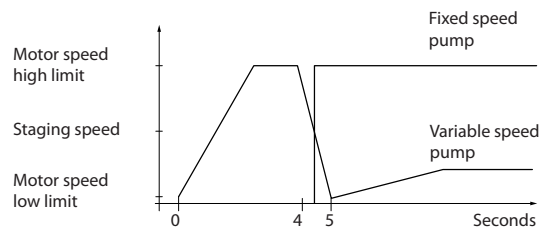

130BA366.10

Illustration 3.78 Staging Threshold

25-43 Destaging Threshold		
Range:	Function:	
Size related* [0 - 100 %]	When removing a fixed speed pump to prevent an undershoot of pressure, the variable speed pump ramps up to a higher speed. When the variable speed pump reaches the destaging speed, the fixed speed pump is destaged. The destaging threshold is used to calculate the speed of the variable speed pump when the destaging of the fixed speed pump occurs. The calculation of the destaging threshold is the ratio of <i>parameter 4-11 Motor Speed Low Limit [RPM]</i> or <i>parameter 4-12 Motor Speed Low Limit [Hz]</i> , to <i>parameter 4-13 Motor Speed High Limit [RPM]</i> or <i>parameter 4-14 Motor Speed High Limit [Hz]</i> , expressed in percent.	
	Destaging threshold must range from $STAGE \% = \frac{LOW}{HIGH} \times 100 \%$ to 100%, where n_{LOW} is motor speed low limit and n_{HIGH} is motor speed high limit.	

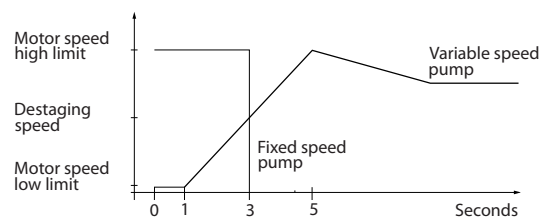

130BA367.10

Illustration 3.79 Destaging Threshold

25-44 Staging Speed [RPM]		
Range:	Function:	
0 RPM* [000 - 0 RPM]	<p>Readout of the below calculated value for staging speed. When adding a fixed speed pump to prevent an overshoot of pressure, the variable speed pump ramps down to a lower speed. When the variable speed pump reaches the staging speed, the fixed speed pump is staged on. Staging speed calculation is based on <i>parameter 25-42 Staging Threshold</i> and <i>parameter 4-13 Motor Speed High Limit [RPM]</i>.</p> <p>Staging speed is calculated with the following formula:</p> $STAGE = HIGH \frac{STAGE\%}{100}$ <p>where n_{HIGH} is motor speed high limit and $n_{STAGE100\%}$ is the value of staging threshold.</p>	

25-45 Staging Speed [Hz]		
Range:	Function:	
0 Hz* [0 - 0 Hz]	<p>Readout of the below calculated value for staging speed. When adding a fixed speed pump to prevent an overshoot of pressure, the variable speed pump ramps down to a lower speed. When the variable speed pump reaches the staging speed, the fixed speed pump is staged on. Staging speed calculation is based on <i>parameter 25-42 Staging Threshold</i> and <i>parameter 4-14 Motor Speed High Limit [Hz]</i>.</p> <p>Staging speed is calculated with the following formula:</p> $STAGE = HIGH \frac{STAGE\%}{100}$ <p>where n_{HIGH} is motor speed high limit and $n_{STAGE100\%}$ is the value of staging threshold.</p>	

25-46 Destaging Speed [RPM]		
Range:	Function:	
0 RPM* [000 - 0 RPM]	<p>Readout of the below calculated value for destaging speed. When removing a fixed speed pump to prevent an undershoot of pressure, the variable speed pump ramps up to a higher speed. When the variable speed pump reaches the destaging speed, the fixed speed pump is destaged. Destaging speed is calculated based on <i>parameter 25-43 Destaging Threshold</i> and <i>parameter 4-13 Motor Speed High Limit [RPM]</i>.</p> <p>Destaging speed is calculated with the following formula:</p> $DESTAGE = HIGH \frac{DESTAGE\%}{100}$ <p>where n_{HIGH} is motor speed high limit and $n_{DESTAGE100\%}$ is the value of destaging threshold.</p>	

25-47 Destaging Speed [Hz]		
Range:	Function:	
0 Hz* [0 - 0 Hz]	<p>Readout of the below calculated value for destaging speed. When removing a fixed speed pump to prevent an undershoot of pressure, the variable speed pump ramps up to a higher speed. When the variable speed pump reaches the destaging speed, the fixed speed pump is destaged. Destaging speed is calculated based on <i>parameter 25-43 Destaging Threshold</i> and <i>parameter 4-14 Motor Speed High Limit [Hz]</i>.</p> <p>Destaging speed is calculated with the following formula:</p> $DESTAGE = HIGH \frac{DESTAGE\%}{100}$ <p>where n_{HIGH} is motor speed high limit and $n_{DESTAGE100\%}$ is the value of destaging threshold.</p>	

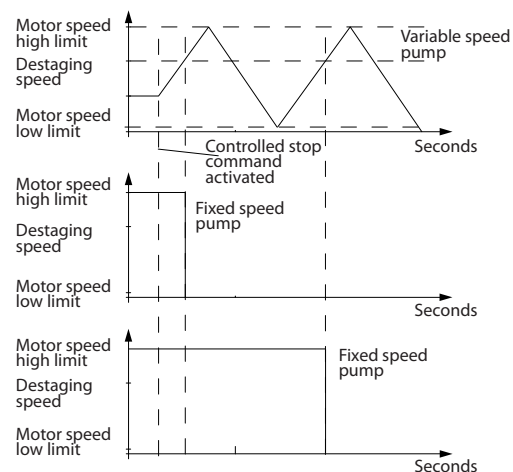

Illustration 3.80 Destaging Speed

3.23.4 25-5* Alternation Settings

Parameters for defining the conditions for alternation of the variable speed pump (lead), if selected as control strategy.

25-50 Lead Pump Alternation	
Option:	Function:
	<p>NOTICE</p> <p>It is not possible to select other than [0] Off if <i>parameter 25-05 Fixed Lead Pump</i> is set to [1] Yes.</p> <p>Lead pump alternation equalises the use of pumps by periodically changing the pump that is speed-controlled. This ensures that pumps are equally used over time. Alternation equalises the usage of pumps by always selecting the pump with the lowest number of used hours to stage on next.</p>

25-50 Lead Pump Alternation		
Option:	Function:	
[0] *	Off	No alternation of lead pump function takes place. It is not possible to set this parameter to options other than [0] Off if <i>parameter 25-02 Motor Start</i> is set other than [0] Direct on Line.
[1]	At staging	Alternation of the lead pump function takes place when staging another pump.
[2]	At command	Alternation of the lead pump function takes place at an external command signal or a pre-programmed event. See <i>parameter 25-51 Alternation Event</i> for available options.
[3]	At staging or command	Alternation of the variable speed (lead) pump takes place at staging or the At command signal (see above).

25-51 Alternation Event		
Option:	Function:	
		This parameter is only active if the options [2] At Command or [3] At Staging or Command have been selected in <i>parameter 25-50 Lead Pump Alternation</i> . If an alternation event is selected, the alternation of lead pump takes place every time the event occurs.
[0] *	External	Alternation takes place when a signal is applied to 1 of the digital inputs on the terminal strip and this input has been assigned to [121] Lead Pump Alternation in <i>parameter group 5-1*, Digital Inputs</i> .
[1]	Alternation Time Interval	Alternation takes place every time <i>parameter 25-52 Alternation Time Interval</i> expires.
[2]	Sleep Mode	Alternation takes place each time the lead pump goes into sleep mode. Set <i>parameter 20-23 Setpoint 3</i> to [1] Sleep Mode or apply an external signal must be applied for this function.
[3]	Predefined Time	Alternation takes place at a defined time of the day. If <i>parameter 25-54 Alternation Predefined Time</i> is set, the alternation is carried out every day at the specified time. Default time is midnight (00:00 or 12:00AM depending on the time format).

25-52 Alternation Time Interval		
Range:	Function:	
24 h*	[1 - 999 h]	If selecting [1] Alternation Time Interval in <i>parameter 25-51 Alternation Event</i> , the alternation of the variable speed pump takes place every time the alternation time interval expires (can be checked in <i>parameter 25-53 Alternation Timer Value</i>).

25-53 Alternation Timer Value		
Range:	Function:	
0*	[0 - 7]	Readout parameter for the alternation time interval value set in <i>parameter 25-52 Alternation Time Interval</i> .

25-54 Alternation Predefined Time		
Range:	Function:	
Size related*	[0 - 0]	If selecting [3] Predefined Time in <i>parameter 25-51 Alternation Event</i> the variable speed pump alternation is carried out every day at the specified time set in alternation predefined time. Default time is midnight (00:00 or 12:00AM depending on the time format).

25-55 Alternate if Load < 50%		
Option:	Function:	
		<p>NOTICE</p> <p>Only valid if <i>parameter 25-50 Lead Pump Alternation</i> is different from [0] Off.</p> <p>If selecting [1] Enabled, the pump alternation can only occur if the capacity is equal to or below 50%. The capacity calculation is the ratio of running pumps (including the variable speed pump) to the total number of available pumps (including variable speed pump, but not those that are interlocked).</p> $Capacity = \frac{N_{RUNNING}}{N_{TOTAL}} \times 100\%$ <p>For the basic cascade controller, all pumps are equal size.</p>
[0]	Disabled	The lead pump alternation takes place at any pump capacity.
[1] *	Enabled	The lead pump function is alternated only if the number of pumps running are providing less than 50% of total pump capacity.

25-56 Staging Mode at Alternation		
Option:	Function:	
		This parameter is only active if the option selected in <i>parameter 25-50 Lead Pump Alternation</i> is different from [0] Off. 2 types of staging and destaging of pumps are possible. Slow transfer makes staging and destaging smooth. Quick transfer makes staging and destaging as fast as possible; the variable speed pump is just cut out (coasted).
[0] *	Slow	At alternation, the variable speed pump is ramped up to maximum speed and then ramped down to a stand still.
[1]	Quick	At alternation, the variable speed pump is ramped up to maximum speed and then coasted to stand still.

Illustration 3.81 is an example of the slow transfer-staging. The variable speed pump (top graph) and 1 fixed speed pump (bottom graph) run before the staging command. When the [0] Slow transfer command is activated, an alternation is carried out by ramping the variable speed pump to *parameter 4-13 Motor Speed High Limit [RPM]* or *parameter 4-14 Motor Speed High Limit [Hz]*, and then decelerated to zero speed. After a delay before starting next pump (*parameter 25-58 Run Next Pump Delay*), the next lead pump (middle graph) is accelerated and another original lead pump (top graph) is added after the delay before running on mains (*parameter 25-59 Run on Mains Delay*) as a fixed speed pump. The next lead pump (middle graph) is decelerated to motor speed low limit and then allowed to vary speed to maintain system pressure.

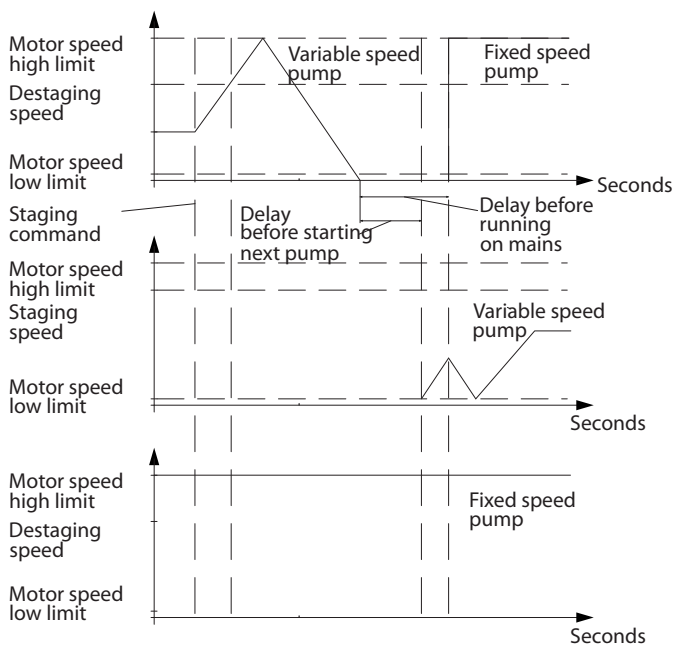

Illustration 3.81 Staging Mode at Alternation

25-58 Run Next Pump Delay		
Range:	Function:	
0.1 s* 5 s]	[0.1 -	This parameter is only active if the option selected in <i>parameter 25-50 Lead Pump Alternation</i> is different from [0] Off. This parameter sets the time between stopping the old variable speed pump and starting another pump as a new variable speed pump. Refer to <i>parameter 25-56 Staging Mode at Alternation, Illustration 3.81</i> for description of staging and alternation.

25-59 Run on Mains Delay		
Range:	Function:	
0.5 s* 5 s]	[par. 25-58 -	This parameter is only active if the option selected in <i>parameter 25-50 Lead Pump Alternation</i> , is different from [0] Off. This parameter sets the time between stopping the old variable speed pump and starting this pump as a new fixed speed pump. Refer to <i>Illustration 3.81</i> for description of staging and alternation.

3.23.5 25-8* Status

Readout parameters informing about the operating status of the cascade controller and the pumps controlled.

25-80 Cascade Status		
Range:	Function:	
0*	[0 - 25]	Readout of the status of the cascade controller.

25-81 Pump Status		
Range:	Function:	
0*	[0 - 25]	Pump status shows the status for the number of pumps selected in <i>parameter 25-06 Number of Pumps</i> . It is a readout of the status for each of the pumps showing a string, which consists of pump number and the current status of the pump. Example: Readout is with the abbreviation like "1:D 2:O" This means that pump 1 is running and speed controlled by the frequency converter and pump 2 is stopped.

25-82 Lead Pump		
Range:	Function:	
0*	[0 - par. 25-06]	Readout parameter for the actual variable speed pump in the system. The lead pump parameter is updated to reflect the current variable speed pump in the system when an alternation takes place. If no lead pump is selected (cascade controller disabled or all pumps interlocked), the display shows N1.

25-83 Relay Status		
Range:	Function:	
0* [0 - 4]	Readout of the status for each of the relays assigned to control the pumps. Every element in the array represents a relay. If a relay is activated, the corresponding element is set to On. If a relay is deactivated, the corresponding element is set to Off.	

25-84 Pump ON Time		
Range:	Function:	
0 h* [0 - 2147483647 h]	Readout of the value for pump ON time. The cascade controller has separate counters for the pumps and for the relays that control the pumps. Pump ON time monitors the operating hours of each pump. The value of each pump ON time counter can be reset to 0 by writing in the parameter, for example, if the pump is replaced in case of service.	

25-85 Relay ON Time		
Range:	Function:	
0 h* [0 - 2147483647 h]	Readout of the value for relay ON time. The cascade controller has separate counters for the pumps and for the relays that control the pumps. Pump cycling is always d1 based on the relay counters, otherwise it would always use the new pump if a pump is replaced and its value in <i>parameter 25-84 Pump ON Time</i> is reset. To use <i>parameter 25-04 Pump Cycling</i> , the cascade controller is monitoring the relay ON time.	

25-86 Reset Relay Counters		
Option:	Function:	
[0] *	Do not reset	
[1]	Do reset	

25-90 Pump Interlock		
Option:	Function:	
		The digital input interlocks are selected as [130] Pump 1 Interlock – [132] Pump 1 Interlock in parameter group 5-1* Digital In/Out.
[0] *	Off	The pump is active for staging/destaging.
[1]	On	The pump interlock command is given. If a pump is running it is immediately destaged. If the pump is not running, it is not allowed to stage on.

25-91 Manual Alternation		
Range:	Function:	
0* [0 - par. 25-06]	Readout parameter for the actual variable speed pump in the system. When an alternation takes place, the lead pump parameter is updated to reflect the current variable speed pump in the system. If no lead pump is selected (cascade controller disabled or all pumps interlocked), the display shows N1.	

3.23.6 25-9* Service

Parameters used in case of service on 1 or more of the pumps controlled.

25-90 Pump Interlock		
Option:	Function:	
		In this parameter, it is possible to disable 1 or more of the fixed lead pumps. For example, the pump is not selected for staging on even if it is the next pump in the operation sequence. It is not possible to disable the lead pump with the pump interlock command.

3.24 Parameters: 26-** Analog I/O Option MCB 109

The analog I/O option MCB 109 extends the functionality of VLT® HVAC Drive frequency converters, by adding a number of additional, programmable analog inputs and outputs. This could be especially useful in building management system installations where the frequency converter may be used as de-central I/O, obviating the need for an outstation and thus reducing cost.

3

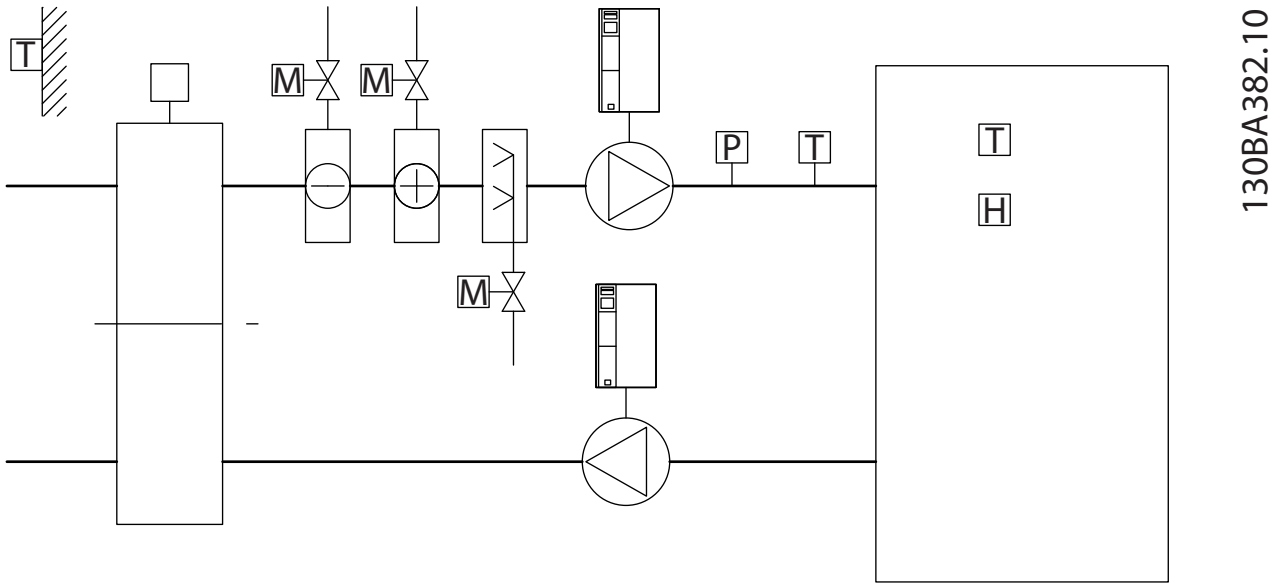

Illustration 3.82 Analog I/O Option MCB 109

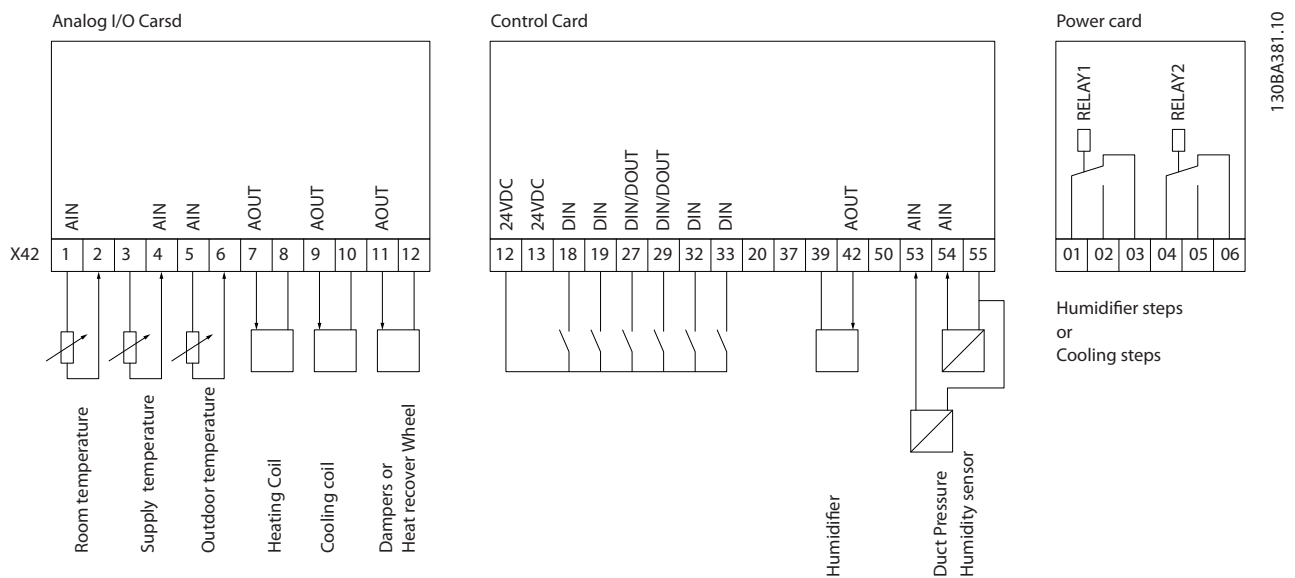

Illustration 3.83 Analog I/O Option MCB 109

Illustration 3.82 a typical air handling unit (AHU). As can be seen, the addition of the analog I/O option offers the possibility to control all of the functions from the frequency converter, such as inlet-, return- and exhaust dampers, or heating/cooling coils with temperature and pressure measurements being read by the frequency converter.

NOTICE

The maximum current for the analog outputs 0-10 V is 1 mA.

NOTICE

Where live zero monitoring is used, it is important that any analog inputs not being used for the frequency converter, that is, being used as part of the building management system decentral I/O, should have their live zero-function disabled.

3

Terminal	Parameters	Terminal	Parameters	Terminal	Parameters
Analog inputs		Analog inputs		Relays	
X42/1	Parameter 26-00 Terminal X42/1 Mode, 26-1*	53	6-1*	Relay 1 Term 1, 2, 3	5-4*
X42/3	Parameter 26-01 Terminal X42/3 Mode, 26-2*	54	6-2*	Relay 2 Term 4, 5, 6	5-4*
X42/5	Parameter 26-02 Terminal X42/5 Mode, 26-3*				
Analog outputs		Analog output			
X42/7	26-4*	42	6-5*		
X42/9	26-5*				
X42/11	26-6*				

Table 3.29 Relevant Parameters

It is also possible to read the analog inputs, write to the analog outputs, and control the relays, using communication via the serial bus. In this instance, these are the relevant parameters.

Terminal	Parameters	Terminal	Parameters	Terminal	Parameters
Analog inputs (read)		Analog inputs (read)		Relays	
X42/1	Parameter 18-30 Analog Input X42/1	53	Parameter 16-62 Analog Input 53	Relay 1 Term 1, 2, 3	Parameter 16-71 Relay Output [bin]
X42/3	Parameter 18-31 Analog Input X42/3	54	Parameter 16-64 Analog Input 54	Relay 2 Term 4, 5, 6	Parameter 16-71 Relay Output [bin]
X42/5	Parameter 18-32 Analog Input X42/5				
Analog outputs (write)		Analog output (write)			
X42/7	Parameter 18-33 Analog Out X42/7 [V]	42	Parameter 6-53 Terminal 42 Output Bus Control	NOTICE Enable the relay outputs via control word bit 11 (relay 1) and bit 12 (relay 2).	
X42/9	Parameter 18-34 Analog Out X42/9 [V]				
X42/11	Parameter 18-35 Analog Out X42/11 [V]				

Table 3.30 Relevant Parameters

Setting of on-board real time clock

The analog I/O option incorporates a real time clock with battery back-up. This can be used as back-up of the clock function included in the frequency converter as standard. See *chapter 3.2.8 0-7* Clock Settings*.

The analog I/O option can be used for the control of devices such as actuators or valves, using the extended closed loop facility, thus removing control from the building management system. See *chapter 3.19 Parameters: 21-** Main Menu - Extended Closed Loop*. There are 3 independent closed-loop PID controllers.

3.24.1 26-0* Analog I/O Mode

Parameter group for setting up the analog I/O configuration. The option is equipped with 3 analog inputs. These analog inputs can be freely allocated to either voltage (0-10 V), Pt 1000, or Ni 1000 temperature sensor input.

26-00 Terminal X42/1 Mode	
Option:	Function:
	<p>Terminal X42/1 can be programmed as an analog input accepting a voltage or input from either Pt1000 (1000 Ω at 0 °C) or Ni 1000 (1000 Ω at 0 °C) temperature sensors. Select the desired mode.</p> <p>[2] Pt 1000 [°C] and [4] Ni 1000 [°C] if operating in Celsius, or [3] Pt 1000 [°F] and [5] Ni 1000 [°F] if operating in Fahrenheit.</p> <p>NOTICE</p> <p>If the input is not in use, it must be set for voltage.</p> <p>If set for temperature and used as feedback, set the unit for either Celsius or Fahrenheit.</p> <ul style="list-style-type: none"> • 20-12 Reference/Feedback Unit. • Parameter 21-10 Ext. 1 Ref./Feedback Unit. • Parameter 21-30 Ext. 2 Ref./Feedback Unit. • Parameter 21-50 Ext. 3 Ref./Feedback Unit.
[1] *	Voltage
[2]	Pt 1000 [°C]
[3]	Pt 1000 [°F]
[4]	Ni 1000 [°C]
[5]	Ni 1000 [°F]

26-01 Terminal X42/3 Mode	
Option:	Function:
	<p>Terminal X42/3 can be programmed as an analog input accepting a voltage, or input from either Pt 1000 or Ni 1000 temperature sensors. Select the desired mode.</p> <p>[2] Pt 1000 [°C] and [4] Ni 1000 [°C] if operating in Celsius, or [3] Pt 1000 [°F] and [5] Ni 1000 [°F] if operating in Fahrenheit.</p> <p>NOTICE</p> <p>If the input is not in use, it must be set for voltage.</p> <p>If set for temperature and used as feedback, set the unit for either Celsius or Fahrenheit</p>

26-01 Terminal X42/3 Mode	
Option:	Function:
	<ul style="list-style-type: none"> • 20-12 Reference/Feedback Unit. • Parameter 21-10 Ext. 1 Ref./Feedback Unit. • Parameter 21-30 Ext. 2 Ref./Feedback Unit. • Parameter 21-50 Ext. 3 Ref./Feedback Unit.
[1] *	Voltage
[2]	Pt 1000 [°C]
[3]	Pt 1000 [°F]
[4]	Ni 1000 [°C]
[5]	Ni 1000 [°F]

26-02 Terminal X42/5 Mode	
Option:	Function:
	<p>Terminal X42/5 can be programmed as an analog input accepting a voltage or input from either Pt 1000 (1000 Ω at 0 °C) or Ni 1000 (1000 Ω at 0 °C) temperature sensors. Select the desired mode.</p> <p>[2] Pt 1000 [°C] and [4] Ni 1000 [°C] if operating in Celsius, or [3] Pt 1000 [°F] and [5] Ni 1000 [°F] if operating in Fahrenheit.</p> <p>NOTICE</p> <p>If the input is not in use, it must be set for voltage.</p> <p>If set for temperature and used as feedback, set the unit for either Celsius or Fahrenheit</p> <ul style="list-style-type: none"> • 20-12 Reference/Feedback Unit. • Parameter 21-10 Ext. 1 Ref./Feedback Unit. • Parameter 21-30 Ext. 2 Ref./Feedback Unit. • Parameter 21-50 Ext. 3 Ref./Feedback Unit.
[1] *	Voltage
[2]	Pt 1000 [°C]
[3]	Pt 1000 [°F]
[4]	Ni 1000 [°C]
[5]	Ni 1000 [°F]

3.24.2 26-1* Analog Input X42/1

Parameters for configuring the scaling and limits for analog input, terminal X42/1.

26-10 Terminal X42/1 Low Voltage		
Range:	Function:	
0.07 V* [0 - par. 6-31 V]	Enter the low-voltage value. This analog input scaling value should correspond to the low reference/feedback value set in <i>parameter 26-14 Term. X42/1 Low Ref./Feedb. Value.</i>	

26-11 Terminal X42/1 High Voltage		
Range:	Function:	
10 V* [par. 6-30 - 10 V]	Enter the high-voltage value. This analog input scaling value should correspond to the high reference/feedback value set in <i>parameter 26-15 Term. X42/1 High Ref./Feedb. Value.</i>	

26-14 Term. X42/1 Low Ref./Feedb. Value		
Range:	Function:	
0* [-999999.999 - 999999.999]	Enter the analog input scaling value that corresponds to the low-voltage value set in <i>parameter 26-10 Terminal X42/1 Low Voltage.</i>	

26-15 Term. X42/1 High Ref./Feedb. Value		
Range:	Function:	
100* [-999999.999 - 999999.999]	Enter the analog input scaling value that corresponds to the high-voltage value set in <i>parameter 26-11 Terminal X42/1 High Voltage.</i>	

26-16 Term. X42/1 Filter Time Constant		
Range:	Function:	
0.001 s* [0.001 - 10 s]	<p>NOTICE</p> <p>This parameter cannot be adjusted while the motor is running.</p> <p>This is a first-order digital low-pass filter time constant for suppressing noise in terminal X42/1. A high time constant value improves dampening, but also increases the time delay through the filter.</p>	

26-17 Term. X42/1 Live Zero		
Option:	Function:	
[0]	Disabled	
[1] *	Enabled	

3.24.3 26-2* Analog Input X42/3

Parameters for configuring the scaling and limits for analog input, terminal X42/3.

26-20 Terminal X42/3 Low Voltage		
Range:	Function:	
0.07 V* [0 - par. 6-31 V]	Enter the low-voltage value. This analog input scaling value should correspond to the low reference/feedback value set in <i>parameter 26-24 Term. X42/3 Low Ref./Feedb. Value.</i>	

26-21 Terminal X42/3 High Voltage		
Range:	Function:	
10 V* [par. 6-30 - 10 V]	Enter the high-voltage value. This analog input scaling value should correspond to the high reference/feedback value set in <i>parameter 26-25 Term. X42/3 High Ref./Feedb. Value.</i>	

26-24 Term. X42/3 Low Ref./Feedb. Value		
Range:	Function:	
0* [-999999.999 - 999999.999]	Enter the analog input scaling value that corresponds to the low-voltage value set in <i>parameter 26-20 Terminal X42/3 Low Voltage.</i>	

26-25 Term. X42/3 High Ref./Feedb. Value		
Range:	Function:	
100* [-999999.999 - 999999.999]	Enter the analog input scaling value that corresponds to the high-voltage value set in <i>parameter 26-21 Terminal X42/3 High Voltage.</i>	

26-26 Term. X42/3 Filter Time Constant		
Range:	Function:	
0.001 s* [0.001 - 10 s]	<p>NOTICE</p> <p>This parameter cannot be adjusted while the motor is running.</p> <p>Enter the time constant. This is a first-order digital low-pass filter time constant for suppressing noise in terminal X42/3. A high time constant value improves dampening, but also increases the time delay through the filter.</p>	

26-27 Term. X42/3 Live Zero		
Option:	Function:	
[0]	Disabled	
[1] *	Enabled	

3.24.4 26-3* Analog Input X42/5

Parameters for configuring the scaling and limits for analog input, terminal X42/5.

26-30 Terminal X42/5 Low Voltage		
Range:	Function:	
0.07 V*	[0 - par. 6-31 V]	Enter the low-voltage value. This analog input scaling value should correspond to the low reference/feedback value set in <i>parameter 26-34 Term. X42/5 Low Ref./Feedb. Value</i> .

26-31 Terminal X42/5 High Voltage		
Range:	Function:	
10 V*	[par. 6-30 - 10 V]	Enter the high-voltage value. This analog input scaling value should correspond to the high reference/feedback value set in <i>parameter 26-35 Term. X42/5 High Ref./Feedb. Value</i> .

26-34 Term. X42/5 Low Ref./Feedb. Value		
Range:	Function:	
0*	[-999999.999 - 999999.999]	Enter the analog input scaling value that corresponds to the low-voltage value set in <i>parameter 26-30 Terminal X42/5 Low Voltage</i> .

26-35 Term. X42/5 High Ref./Feedb. Value		
Range:	Function:	
100*	[-999999.999 - 999999.999]	Enter the analog input scaling value that corresponds to the high-voltage value set in <i>parameter 26-21 Terminal X42/3 High Voltage</i> .

26-36 Term. X42/5 Filter Time Constant		
Range:	Function:	
0.001 s*	[0.001 - 10 s]	<p>NOTICE</p> <p>This parameter cannot be adjusted while the motor is running.</p> <p>This is a first-order digital low-pass filter time constant for suppressing noise in terminal X42/5. A high time constant value improves dampening, but also increases the time delay through the filter.</p>

26-37 Term. X42/5 Live Zero		
Option:	Function:	
		Enable or disable the live zero monitoring.
[0]	Disabled	
[1] *	Enabled	

3.24.5 26-4* Analog Out X42/7

Parameters for configuring the scaling and output function for analog output, terminal X42/7.

26-40 Terminal X42/7 Output		
Option:	Function:	
		Set the function of terminal X42/7 as an analog current output.
[0] *	No operation	
[100]	Output freq. 0-100	0–100 Hz, (0–10 V).
[101]	Reference Min-Max	Minimum reference–maximum reference, (0–10 V).
[102]	Feedback +-200%	-200% to +200% of 3-03 <i>Maximum Reference</i> , (0–10 V).
[103]	Motor cur. 0-Imax	0–inverter maximum current (<i>parameter 16-37 Inv. Max. Current</i>), (0–10 V).
[104]	Torque 0-Tlim	0–torque limit (<i>parameter 4-16 Torque Limit Motor Mode</i>), (0–10 V).
[105]	Torque 0-Tnom	0–motor rated torque, (0–10 V).
[106]	Power 0-Pnom	0–motor rated power, (0–10 V).
[107]	Speed 0-HighLim	0–speed high limit (<i>parameter 4-13 Motor Speed High Limit [RPM]</i> and <i>parameter 4-14 Motor Speed High Limit [Hz]</i>), (0–10 V).
[113]	Ext. Closed Loop 1	0–100%, (0–10 V).
[114]	Ext. Closed Loop 2	0–100%, (0–10 V).
[115]	Ext. Closed Loop 3	0–100%, (0–10 V).
[139]	Bus ctrl.	0–100%, (0–10 V).
[141]	Bus ctrl t.o.	0–100%, (0–10 V).

26-41 Terminal X42/7 Min. Scale		
Range:	Function:	
0 %* [0 - 200 %]	Scale the minimum output of the selected analog signal at terminal X42/7, as a percentage of the maximum signal level, example, if 0 V (or 0 Hz) is desired at 25% of the maximum output value, programme 25%. Scaling values up to 100% can never be higher than the corresponding setting in <i>parameter 26-42 Terminal X42/7 Max. Scale</i> . See principle graph for <i>parameter 6-51 Terminal 42 Output Min Scale</i> .	

26-42 Terminal X42/7 Max. Scale		
See <i>Illustration 3.30</i> .		
Range:	Function:	
100 %* [0 - 200 %]	Scale the maximum output of the selected analog signal at terminal X42/7. Set the value to the maximum value of the voltage signal output. Scale the output to give a voltage lower than 10 V at full scale; or 10 V at an output below 100% of the maximum signal value. If 10 V is the desired output current at a value between 0-100% of the full-scale output, programme the percentage value in the parameter, that is 50%=10 V. If a voltage between 0 and 10 V is desired at maximum output, calculate the percentage as follows: $\left(\frac{10V}{\text{desired maximum voltage}} \right) \times 100\%$ that is $5V: \frac{10V}{5V} \times 100\% = 200\%$	

26-43 Terminal X42/7 Bus Control		
Range:	Function:	
0 %* [0 - 100 %]	Holds the level of terminal X42/7 if controlled by bus.	

26-44 Terminal X42/7 Timeout Preset		
Range:	Function:	
0 %* [0 - 100 %]	Holds the preset level of terminal X42/7. if a bus time-out and a time-out function are selected in <i>parameter 26-50 Terminal X42/9 Output</i> , the output presets to this level.	

26-50 Terminal X42/9 Output		
Option:	Function:	
[100] Output freq. 0-100	0-100 Hz, (0-10 V).	
[101] Reference Min-Max	Minimum reference-maximum reference, (0-10 V).	
[102] Feedback +200%	-200% to +200% of 3-03 <i>Maximum Reference</i> , (0-10 V).	
[103] Motor cur. 0-lmax	0-inverter maximum current (<i>parameter 16-37 Inv. Max. Current</i>), (0-10 V).	
[104] Torque 0-Tlim	0-torque limit (<i>parameter 4-16 Torque Limit Motor Mode</i>), (0-10 V).	
[105] Torque 0-Tnom	0-motor rated torque, (0-10 V).	
[106] Power 0-Pnom	0-motor rated power, (0-10 V).	
[107] Speed 0-HighLim	0-speed high limit (<i>parameter 4-13 Motor Speed High Limit [RPM]</i> and <i>parameter 4-14 Motor Speed High Limit [Hz]</i>), (0-10 V).	
[113] Ext. Closed Loop 1	0-100%, (0-10 V).	
[114] Ext. Closed Loop 2	0-100%, (0-10 V).	
[115] Ext. Closed Loop 3	0-100%, (0-10 V).	
[139] Bus ctrl.	0-100%, (0-10 V).	
[141] Bus ctrl t.o.	0-100%, (0-10 V).	

26-51 Terminal X42/9 Min. Scale		
For more information, see <i>chapter 3.8.7 6-51 Terminal 42 Output Min Scale</i> .		
Range:	Function:	
0 %* [0 - 200 %]	Scale the minimum output of the selected analog signal at terminal X42/9, as a percentage of the maximum signal level, example, if 0 V is desired at 25% of the maximum output value, programme 25%. Scaling values up to 100% can never be higher than the corresponding setting in <i>parameter 26-52 Terminal X42/9 Max. Scale</i> .	

3.24.6 26-5* Analog Out X42/9

Parameters for configuring the scaling and output function for analog output, terminal X42/9.

26-50 Terminal X42/9 Output		
Option:	Function:	
[0] *	No operation	

26-52 Terminal X42/9 Max. Scale		
See <i>Illustration 3.30</i> .		
Range:	Function:	
100 %*	[0 - 200 %]	Scale the maximum output of the selected analog signal at terminal X42/9. Set the value to the maximum value of the voltage signal output. Scale the output to give a voltage lower than 10 V at full scale; or 10 V at an output below 100% of the maximum signal value. If 10 V is the desired output current at a value between 0-100% of the full-scale output, programme the percentage value in the parameter, that is, 50%=10 V. If a voltage between 0 and 10 V is desired at maximum output, calculate the percentage as follows: that is $5V: \frac{10V}{5V} \times 100\% = 200\%$

26-53 Terminal X42/9 Bus Control		
Range:	Function:	
0 %*	[0 - 100 %]	Holds the level of terminal X42/9 if controlled by bus.

26-54 Terminal X42/9 Timeout Preset		
Range:	Function:	
0 %*	[0 - 100 %]	Holds the preset level of terminal X42/9. If a bus time-out and a time-out function are selected in <i>parameter 26-60 Terminal X42/11 Output</i> , the output presets to this level.

3.24.7 26-6* Analog Out X42/11

Parameters for configuring the scaling and output function for analog output, terminal X42/11.

26-60 Terminal X42/11 Output		
Option:	Function:	
	Set the function of terminal X42/11.	
[0] *	No operation	
[100]	Output freq. 0-100	0–100 Hz, (0–10 V).
[101]	Reference Min-Max	Minimum reference - maximum reference, (0–10 V).
[102]	Feedback +200%	-200% to +200% of 3-03 <i>Maximum Reference</i> , (0–10 V).
[103]	Motor cur. 0-Imax	0–inverter maximum current (<i>parameter 16-37 Inv. Max. Current</i>), (0–10 V).
[104]	Torque 0-Tlim	0–torque limit (<i>parameter 4-16 Torque Limit Motor Mode</i>), (0–10 V).
[105]	Torque 0-Tnom	0–motor rated torque, (0–0 V).
[106]	Power 0-Pnom	0–motor rated power, (0–10 V).

26-60 Terminal X42/11 Output		
Option:	Function:	
[107]	Speed 0-HighLim	0–speed high limit (<i>parameter 4-13 Motor Speed High Limit [RPM]</i> and <i>parameter 4-14 Motor Speed High Limit [Hz]</i>), (0–10 V).
[113]	Ext. Closed Loop 1	0–100%, (0–10 V).
[114]	Ext. Closed Loop 2	0–100%, (0–10 V).
[115]	Ext. Closed Loop 3	0–100%, (0–10 V).
[139]	Bus ctrl.	0–100%, (0–10 V).
[141]	Bus ctrl t.o.	0–100%, (0–10 V).

26-61 Terminal X42/11 Min. Scale		
For more information, see <i>chapter 3.8.7 6-51 Terminal 42 Output Min Scale</i> .		
Range:	Function:	
0 %*	[0 - 200 %]	Scale the minimum output of the selected analog signal at terminal X42/11, as a percentage of the maximum signal level. For example, if 0 V is desired at 25% of the maximum output value, programme 25%. Scaling values up to 100% can never be higher than the corresponding setting in <i>parameter 26-62 Terminal X42/11 Max. Scale</i> .

26-62 Terminal X42/11 Max. Scale		
See <i>Illustration 3.30</i> .		
Range:	Function:	
100 %*	[0 - 200 %]	Scale the maximum output of the selected analog signal at terminal X42/9. Set the value to the maximum value of the voltage signal output. Scale the output to give a voltage lower than 10 V at full scale; or 10 V at an output below 100% of the maximum signal value. For example, If 10 V is the desired output current at a value between 0-100% of the full-scale output, programme the percentage value in the parameter, that is, 50%=10 V. If a voltage between 0 and 10 V is desired at maximum output, calculate the percentage as follows: $\left(\frac{10V}{\text{desired maximum voltage}}\right) \times 100\%$ that is $5V: \frac{10V}{5V} \times 100\% = 200\%$

26-63 Terminal X42/11 Bus Control		
Range:	Function:	
0 %*	[0 - 100 %]	Holds the level of terminal X42/11 if controlled by bus.

26-64 Terminal X42/11 Timeout Preset		
Range:		Function:
0 %*	[0 - 100 %]	Holds the preset level of terminal X42/11. If a bus time-out and a time-out function are selected, the output presets to this level.

3.25 Parameters: 30-** Special Features

3

30-22 Locked Rotor Protection		
Available for PM motors only, in VVC ⁺ open-loop mode.		
Option: Function:		
[0]	Off	
[1]	On	Protects the motor from the locked rotor condition. The control algorithm detects a possible locked rotor condition in motor and trips the frequency converter to protect the motor.

30-23 Locked Rotor Detection Time [s]		
Available for PM motors only, in flux sensorless-mode and VVC ⁺ open-loop mode.		
Range:		Function:
Size related*	[0.05 - 1 s]	Time period for detecting the locked rotor condition. A low parameter value leads to faster detection.

4 Troubleshooting

4.1 Troubleshooting

A warning or an alarm is signalled by the relevant LED on the front of the frequency converter and indicated by a code on the display.

A warning remains active until its cause is no longer present. Under certain circumstances, operation of the motor may still be continued.

In the event of an alarm, the frequency converter trips. To restart operation, reset the alarms once their causes have been rectified.

This may be done in 4 ways:

- By resetting the [RESET] on the LCP.
- Via a digital input with the Reset function.
- Via serial communication/optional fieldbus.
- By resetting automatically using the auto reset-function, which is a default setting, see *parameter 14-20 Reset Mode*.

NOTICE

After a manual reset pressing [RESET] on the LCP, press [Auto On] or [Hand On] to restart the motor.

If an alarm cannot be reset, the reason may be that its cause has not been rectified, or the alarm is trip-locked (see also *Table 4.1*).

CAUTION

Alarms that are trip-locked offer additional protection, as the mains supply must be switched off before the alarm can be reset. After being switched back on, the frequency converter is no longer blocked and may be reset as described above once the alarm cause has been rectified.

Alarms that are not trip-locked can also be reset using the automatic reset function in *parameter 14-20 Reset Mode* (Warning: Automatic wake-up is possible!)

If a warning and alarm is marked against a code in *Table 4.1*, this means that either a warning occurs before an alarm, or it can be specified whether it is a warning or an alarm that is to be displayed for a given fault. This is possible, for instance, in *parameter 1-90 Motor Thermal Protection*. After an alarm or trip, the motor carries on coasting, and the alarm and warning flash on the frequency converter. Once the problem has been rectified, only the alarm continues flashing.

NOTICE

No missing motorphase detection (number 30-32) and no stall detection are active when *parameter 1-10 Motor Construction* is set to [1] PM non-salient SPM.

No.	Description	Warning	Alarm/trip	Alarm/trip lock	Parameter reference
1	10 V low	X			
2	Live zero error	(X)	(X)		<i>Parameter 6-01 Live Zero Timeout Function</i>
3	No motor	(X)			<i>Parameter 1-80 Function at Stop</i>
4	Mains phase loss	(X)	(X)	(X)	<i>Parameter 14-12 Function at Mains Imbalance</i>
5	DC link voltage high	X			
6	DC link voltage low	X			
7	DC over voltage	X	X		
8	DC under voltage	X	X		
9	Inverter overloaded	X	X		
10	Motor ETR over temperature	(X)	(X)		<i>Parameter 1-90 Motor Thermal Protection</i>
11	Motor thermistor over temperature	(X)	(X)		<i>Parameter 1-90 Motor Thermal Protection</i>
12	Torque limit	X	X		
13	Over Current	X	X	X	
14	Ground fault	X	X	X	

No.	Description	Warning	Alarm/trip	Alarm/trip lock	Parameter reference
15	Hardware mismatch		X	X	
16	Short Circuit		X	X	
17	Control word timeout	(X)	(X)		<i>Parameter 8-04 Control Timeout Function</i>
18	Start failed		X		
23	Internal Fan Fault	X			
24	External Fan Fault	X			<i>Parameter 14-53 Fan Monitor</i>
25	Brake resistor short-circuited	X			
26	Brake resistor power limit	(X)	(X)		<i>Parameter 2-13 Brake Power Monitoring</i>
27	Brake chopper short-circuited	X	X		
28	Brake check	(X)	(X)		<i>Parameter 2-15 Brake Check</i>
29	Drive over temperature	X	X	X	
30	Motor phase U missing	(X)	(X)	(X)	<i>4-58 Missing Motor Phase Function</i>
31	Motor phase V missing	(X)	(X)	(X)	<i>4-58 Missing Motor Phase Function</i>
32	Motor phase W missing	(X)	(X)	(X)	<i>4-58 Missing Motor Phase Function</i>
33	Inrush fault		X	X	
34	Fieldbus communication fault	X	X		
35	Out of frequency range	X	X		
36	Mains failure	X	X		
37	Phase Imbalance	X	X		
38	Internal fault		X	X	
39	Heatsink sensor		X	X	
40	Overload of Digital Output Terminal 27	(X)			<i>Parameter 5-00 Digital I/O Mode, parameter 5-01 Terminal 27 Mode</i>
41	Overload of Digital Output Terminal 29	(X)			<i>Parameter 5-00 Digital I/O Mode, parameter 5-02 Terminal 29 Mode</i>
42	Overload of Digital Output On X30/6	(X)			<i>Parameter 5-32 Term X30/6 Digi Out (MCB 101)</i>
42	Overload of Digital Output On X30/7	(X)			<i>Parameter 5-33 Term X30/7 Digi Out (MCB 101)</i>
46	Pwr. card supply		X	X	
47	24 V supply low	X	X	X	
48	1.8 V supply low		X	X	
49	Speed limit	X	(X)		<i>Parameter 1-86 Trip Speed Low [RPM]</i>
50	AMA calibration failed		X		
51	AMA check U_{nom} and I_{nom}		X		
52	AMA low I_{nom}		X		
53	AMA motor too big		X		
54	AMA motor too small		X		
55	AMA Parameter out of range		X		
56	AMA interrupted by user		X		

No.	Description	Warning	Alarm/trip	Alarm/trip lock	Parameter reference
57	AMA timeout		X		
58	AMA internal fault	X	X		
59	Current limit	X			
60	External Interlock	X			
62	Output Frequency at Maximum Limit	X			
64	Voltage Limit	X			
65	Control Board Over-temperature	X	X	X	
66	Heat sink Temperature Low	X			
67	Option Configuration has Changed		X		
68	Safe Stop	(X)	X ¹⁾		5-19 Terminal 37 Safe Stop
69	Pwr. Card Temp		X	X	
70	Illegal FC configuration			X	
71	PTC 1 Safe Stop	X	X ¹⁾		
72	Dangerous Failure			X ¹⁾	
73	Safe Stop Auto Restart				
76	Power Unit Setup	X			
79	Illegal PS config		X	X	
80	Drive Initialized to Default Value		X		
91	Analog input 54 wrong settings			X	
92	NoFlow	X	X		22-2* No-Flow Detection
93	Dry Pump	X	X		22-2* No-Flow Detection
94	End of Curve	X	X		22-5* End of Curve
95	Broken Belt	X	X		22-6* Broken Belt Detection
96	Start Delayed	X			22-7* Short Cycle Protection
97	Stop Delayed	X			22-7* Short Cycle Protection
98	Clock Fault	X			0-7* Clock Settings
201	Fire M was Active				
202	Fire M Limits Exceeded				
203	Missing Motor				
204	Locked Rotor				
243	Brake IGBT	X	X		
244	Heatsink temp	X	X	X	
245	Heatsink sensor		X	X	
246	Pwr.card supply		X	X	
247	Pwr.card temp		X	X	
248	Illegal PS config		X	X	
250	New spare parts			X	
251	New Type Code		X	X	

Table 4.1 Alarm/Warning Code List

(X) Dependent on parameter.

1) Cannot be auto reset via parameter 14-20 Reset Mode.

A trip is the action when an alarm has appeared. The trip coasts the motor and can be reset by pressing [Reset] or make a reset by a digital input (parameter group 5-1* *Digital Inputs [1] Reset*). The original event that caused an alarm cannot damage the frequency converter or cause dangerous conditions. A trip lock is an action when an alarm occurs, which may cause damage to frequency converter or connected parts. A trip lock situation can only be reset by a power cycling.

Warning	yellow
Alarm	flashing red
Trip locked	yellow and red

Table 4.2 LED Indication
4

Alarm word and extended status word					
Bit	Hex	Dec	Alarm word	Warning word	Extended status word
0	00000001	1	Brake Check	Brake Check	Ramping
1	00000002	2	Pwr. Card Temp	Pwr. Card Temp	AMA Running
2	00000004	4	Earth Fault	Earth Fault	Start CW/CCW
3	00000008	8	Ctrl.Card Temp	Ctrl.Card Temp	Slow Down
4	00000010	16	Ctrl. Word TO	Ctrl. Word TO	Catch Up
5	00000020	32	Over Current	Over Current	Feedback High
6	00000040	64	Torque Limit	Torque Limit	Feedback Low
7	00000080	128	Motor Th Over	Motor Th Over	Output Current High
8	00000100	256	Motor ETR Over	Motor ETR Over	Output Current Low
9	00000200	512	Inverter Overld.	Inverter Overld.	Output Freq High
10	00000400	1024	DC under Volt	DC under Volt	Output Freq Low
11	00000800	2048	DC over Volt	DC over Volt	Brake Check OK
12	00001000	4096	Short Circuit	DC Voltage Low	Braking Max
13	00002000	8192	Inrush Fault	DC Voltage High	Braking
14	00004000	16384	Mains ph. Loss	Mains ph. Loss	Out of Speed Range
15	00008000	32768	AMA Not OK	No Motor	OVC Active
16	00010000	65536	Live Zero Error	Live Zero Error	
17	00020000	131072	Internal Fault	10V Low	
18	00040000	262144	Brake Overload	Brake Overload	
19	00080000	524288	U phase Loss	Brake Resistor	
20	00100000	1048576	V phase Loss	Brake IGBT	
21	00200000	2097152	W phase Loss	Speed Limit	
22	00400000	4194304	Fieldbus Fault	Fieldbus Fault	
23	00800000	8388608	24 V Supply Low	24V Supply Low	
24	01000000	16777216	Mains Failure	Mains Failure	
25	02000000	33554432	1.8V Supply Low	Current Limit	
26	04000000	67108864	Brake Resistor	Low Temp	
27	08000000	134217728	Brake IGBT	Voltage Limit	
28	10000000	268435456	Option Change	Unused	
29	20000000	536870912	Drive Initialized	Unused	
30	40000000	1073741824	Safe Stop	Unused	
31	80000000	2147483648	Mech. brake low (A63)	Extended Status Word	

Table 4.3 Description of Alarm Word, Warning, Word and Extended Status Word

The alarm words, warning words, and extended status words can be read out via serial bus or optional fieldbus for diagnosis. See also

- *Parameter 16-90 Alarm Word.*
- *Parameter 16-92 Warning Word.*
- *Parameter 16-94 Ext. Status Word.*

4.1.1 Alarm Words

Bit (hex)	Alarm word (parameter 16-90 Alarm Word)
00000001	
00000002	Power card over temperature
00000004	Earth fault
00000008	
00000010	Control word timeout
00000020	Over current
00000040	
00000080	Motor thermistor over temp.
0000100	Motor ETR over temperature
0000200	Inverter overloaded
0000400	DC link under voltage
0000800	DC link over voltage
0001000	Short circuit
0002000	
0004000	Mains phase loss
0008000	AMA not OK
0010000	Live zero error
0020000	Internal fault
0040000	
0080000	Motor phase U is missing
00100000	Motor phase V is missing
00200000	Motor phase W is missing
00800000	Control Voltage Fault
01000000	
02000000	VDD, supply low
04000000	Brake resistor short circuit
08000000	Brake chopper fault
10000000	Earth fault DESAT
20000000	Drive initialised
40000000	Safe Stop [A68]
80000000	

Table 4.4 Parameter 16-90 Alarm Word

Bit (hex)	Alarm word 2 (parameter 16-91 Alarm Word 2)
00000001	
00000002	Reserved
00000004	Service Trip, Typecode / Sparepart
00000008	Reserved
00000010	Reserved
00000020	
00000040	
00000080	
0000100	Broken Belt
0000200	Not used
0000400	Not used
0000800	Reserved
0001000	Reserved
0002000	Reserved
0004000	Reserved
0008000	Reserved
0010000	Reserved
0020000	Not used
0040000	Fans error
0080000	ECB error
00100000	Reserved
00200000	Reserved
00400000	Reserved
00800000	Reserved
01000000	Reserved
02000000	Reserved
04000000	Reserved
08000000	Reserved
10000000	Reserved
20000000	Reserved
40000000	PTC 1 Safe Stop [A71]
80000000	Dangerous Failure [A72]

Table 4.5 Parameter 16-91 Alarm Word 2

4.1.2 Warning Words

Bit (Hex)	Warning Word (parameter 16-92 Warning Word)
00000001	
00000002	Power card over temperature
00000004	Earth fault
00000008	
00000010	Control word timeout
00000020	Over current
00000040	
00000080	Motor thermistor over temp.
00000100	Motor ETR over temperature
00000200	Inverter overloaded
00000400	DC link under voltage
00000800	DC link over voltage
00001000	
00002000	
00004000	Mains phase loss
00008000	No motor
00010000	Live zero error
00020000	
00040000	
00080000	
00100000	
00200000	
00400000	
00800000	
01000000	
02000000	Current limit
04000000	
08000000	
10000000	
20000000	
40000000	Safe Stop [W68]
80000000	Not used

Table 4.6 parameter 16-92 Warning Word

Bit (Hex)	Warning Word 2 (parameter 16-93 Warning Word 2)
00000001	
00000002	
00000004	Clock Failure
00000008	Reserved
00000010	Reserved
00000020	
00000040	
00000080	End of Curve
00000100	Broken Belt
00000200	Not used
00000400	Reserved
00000800	Reserved
00001000	Reserved
00002000	Reserved
00004000	Reserved
00008000	Reserved
00010000	Reserved
00020000	Not used
00040000	Fans warning
00080000	
00100000	Reserved
00200000	Reserved
00400000	Reserved
00800000	Reserved
01000000	Reserved
02000000	Reserved
04000000	Reserved
08000000	Reserved
10000000	Reserved
20000000	Reserved
40000000	PTC 1 Safe Stop [W71]
80000000	Reserved

Table 4.7 parameter 16-93 Warning Word 2

4.1.3 Extended Status Words

Bit (hex)	Extended status word (parameter 16-94 Ext. Status Word)
00000001	Ramping
00000002	AMA tuning
00000004	Start CW/CCW
00000008	Not used
00000010	Not used
00000020	Feedback high
00000040	Feedback low
00000080	Output current high
00000100	Output current low
00000200	Output frequency high
00000400	Output frequency low
00000800	Brake check OK
00001000	Braking max
00002000	Braking
00004000	Out of speed range
00008000	OVC active
00010000	AC brake
00020000	Password Timelock
00040000	Password Protection
00080000	Reference high
00100000	Reference low
00200000	Local Ref./Remote Ref.
00400000	Reserved
00800000	Reserved
01000000	Reserved
02000000	Reserved
04000000	Reserved
08000000	Reserved
10000000	Reserved
20000000	Reserved
40000000	Reserved
80000000	Reserved

Table 4.8 Parameter 16-94 Ext. Status Word

Bit (hex)	Extended status word 2 (parameter 16-95 Ext. Status Word 2)
00000001	Off
00000002	Hand / Auto
00000004	Not used
00000008	Not used
00000010	Not used
00000020	Relay 123 active
00000040	Start Prevented
00000080	Control ready
00000100	Drive ready
00000200	Quick Stop
00000400	DC Brake
00000800	Stop
00001000	Standby
00002000	Freeze Output Request
00004000	Freeze Output
00008000	Jog Request
00010000	Jog
00020000	Start Request
00040000	Start
00080000	Start Applied
00100000	Start Delay
00200000	Sleep
00400000	Sleep Boost
00800000	Running
01000000	Bypass
02000000	Fire Mode
04000000	Reserved
08000000	Reserved
10000000	Reserved
20000000	Reserved
40000000	Reserved
80000000	Reserved

Table 4.9 Parameter 16-95 Ext. Status Word 2

The following warning/alarm information defines each warning/alarm condition, provides the probable cause for the condition, and details a remedy or troubleshooting procedure.

WARNING 1, 10 Volts low

The control card voltage is <10 V from terminal 50. Remove some of the load from terminal 50, as the 10 V supply is overloaded. Maximum 15 mA or minimum 590 Ω.

A short circuit in a connected potentiometer or incorrect wiring of the potentiometer can cause this condition.

Troubleshooting

- Remove the wiring from terminal 50. If the warning clears, the problem is with the wiring. If the warning does not clear, replace the control card.

WARNING/ALARM 2, Live zero error

This warning or alarm only appears if programmed in *parameter 6-01 Live Zero Timeout Function*. The signal on 1 of the analog inputs is less than 50% of the minimum value programmed for that input. Broken wiring or a faulty device sending the signal can cause this condition.

Troubleshooting

- Check the connections on all the analog mains terminals.
 - Control card terminals 53 and 54 for signals, terminal 55 common.
 - MCB 101 terminals 11 and 12 for signals, terminal 10 common.
 - MCB 109 terminals 1, 3, and 5 for signals, terminals 2, 4, and 6 common.
- Check that the frequency converter programming and switch settings match the analog signal type.
- Perform an input terminal signal test.

WARNING/ALARM 4, Mains phase loss

A phase is missing on the supply side, or the mains voltage imbalance is too high. This message also appears for a fault in the input rectifier on the frequency converter. Options are programmed in *parameter 14-12 Function at Mains Imbalance*.

Troubleshooting

- Check the supply voltage and supply currents to the frequency converter.

WARNING 5, DC link voltage high

The DC-link voltage (DC) is higher than the high-voltage warning limit. The limit depends on the frequency converter voltage rating. The unit is still active.

WARNING 6, DC link voltage low

The DC-link voltage (DC) is lower than the low-voltage warning limit. The limit depends on the frequency converter voltage rating. The unit is still active.

WARNING/ALARM 7, DC overvoltage

If the DC-link voltage exceeds the limit, the frequency converter trips after a time.

Troubleshooting

- Connect a brake resistor.
- Extend the ramp time.
- Change the ramp type.
- Activate the functions in *parameter 2-10 Brake Function*.
- Increase *parameter 14-26 Trip Delay at Inverter Fault*.
- If the alarm/warning occurs during a power sag, use kinetic back-up (*14-10 Mains Failure*).

WARNING/ALARM 8, DC under voltage

If the DC-link voltage drops below the undervoltage limit, the frequency converter checks if a 24 V DC back-up supply is connected. If no 24 V DC back-up supply is connected, the frequency converter trips after a fixed time delay. The time delay varies with unit size.

Troubleshooting

- Check that the supply voltage matches the frequency converter voltage.
- Perform an input voltage test.
- Perform a soft charge circuit test.

WARNING/ALARM 9, Inverter overload

The frequency converter has run with more than 100% overload for too long and is about to cut-out. The counter for electronic thermal inverter protection issues a warning at 98% and trips at 100%, while giving an alarm. The frequency converter cannot be reset until the counter is below 90%.

Troubleshooting

- Compare the output current shown on the LCP with the frequency converter rated current.
- Compare the output current shown on the LCP with the measured motor current.
- Display the thermal frequency converter load on the LCP and monitor the value. When running above the frequency converter continuous current rating, the counter increases. When running below the frequency converter continuous current rating, the counter decreases.

WARNING/ALARM 10, Motor overload temperature

According to the electronic thermal protection (ETR), the motor is too hot. Select whether the frequency converter issues a warning or an alarm when the counter reaches 100% in *parameter 1-90 Motor Thermal Protection*. The fault occurs when the motor runs with more than 100% overload for too long.

Troubleshooting

- Check for motor overheating.
- Check if the motor is mechanically overloaded.
- Check that the motor current set in *1-24 Motor Current* is correct.
- Ensure that the motor data in *parameters 1-20 to 1-25* are set correctly.
- If an external fan is in use, check that it is selected in *parameter 1-91 Motor External Fan*.
- Running AMA in *parameter 1-29 Automatic Motor Adaptation (AMA)* tunes the frequency converter to the motor more accurately and reduces thermal loading.

WARNING/ALARM 11, Motor thermistor overtemp

Check whether the thermistor is disconnected. Select whether the frequency converter issues a warning or an alarm in *parameter 1-90 Motor Thermal Protection*.

Troubleshooting

- Check for motor overheating.
- Check if the motor is mechanically overloaded.
- When using terminal 53 or 54, check that the thermistor is connected correctly between either terminal 53 or 54 (analog voltage input) and terminal 50 (+10 V supply). Also check that the terminal switch for 53 or 54 is set for voltage. Check that *1-93 Thermistor Source* selects terminal 53 or 54.
- When using terminal 18, 19, 31, 32, or 33 (digital inputs), check that the thermistor is connected correctly between the digital input terminal used (digital input PNP only) and terminal 50. Select the terminal to use in *1-93 Thermistor Source*.

WARNING/ALARM 12, Torque limit

The torque has exceeded the value in *parameter 4-16 Torque Limit Motor Mode* or the value in *parameter 4-17 Torque Limit Generator Mode*. *Parameter 14-25 Trip Delay at Torque Limit* can change this warning from a warning-only condition to a warning followed by an alarm.

Troubleshooting

- If the motor torque limit is exceeded during ramp-up, extend the ramp-up time.
- If the generator torque limit is exceeded during ramp-down, extend the ramp-down time.
- If torque limit occurs while running, increase the torque limit. Make sure that the system can operate safely at a higher torque.
- Check the application for excessive current draw on the motor.

WARNING/ALARM 13, Over current

The inverter peak current limit (approximately 200% of the rated current) is exceeded. The warning lasts approximately 1.5 s, then the frequency converter trips and issues an alarm. Shock loading or quick acceleration with high-inertia loads can cause this fault. If the acceleration during ramp-up is quick, the fault can also appear after kinetic back-up. If extended mechanical brake control is selected, a trip can be reset externally.

Troubleshooting

- Remove the power and check if the motor shaft can be turned.
- Check that the motor size matches the frequency converter.
- Check that the motor data is correct in *parameters 1-20 to 1-25*.

ALARM 14, Earth (ground) fault

There is current from the output phase to ground, either in the cable between the frequency converter and the motor or in the motor itself.

Troubleshooting

- Remove power to the frequency converter and repair the ground fault.
- Check for ground faults in the motor by measuring the resistance to ground of the motor cables and the motor with a megohmmeter.

ALARM 15, Hardware mismatch

A fitted option is not operational with the present control board hardware or software.

Record the value of the following parameters and contact Danfoss:

- *15-40 FC Type*
- *15-41 Power Section*
- *15-42 Voltage*
- *15-43 Software Version*
- *15-45 Actual Typecode String*
- *15-49 SW ID Control Card*
- *15-50 SW ID Power Card*
- *15-60 Option Mounted*
- *15-61 Option SW Version* (for each option slot)

ALARM 16, Short circuit

There is short-circuiting in the motor or motor wiring.

Troubleshooting

- Remove the power to the frequency converter and repair the short circuit.

WARNING/ALARM 17, Control word timeout

There is no communication to the frequency converter. The warning is only active when *8-04 Control Word Timeout Function* is NOT set to [0] Off.

If *8-04 Control Word Timeout Function* is set to *[5] Stop and Trip*, a warning appears and the frequency converter ramps down until it stops, and then it displays an alarm.

Troubleshooting

- Check the connections on the serial communication cable.
- Increase *8-03 Control Word Timeout Time*.
- Check the operation of the communication equipment.
- Verify a proper installation based on EMC requirements.

ALARM 18, Start failed

The speed has not been able to exceed *parameter 1-77 Compressor Start Max Speed [RPM]* during start within the allowed time. (set in *parameter 1-79 Compressor Start Max Time to Trip*). This may be caused by a blocked motor.

WARNING 23, Internal fan fault

The fan warning function is an extra protective function that checks if the fan is running/mounted. The fan warning can be disabled in *14-53 Fan Monitor ([0] Disabled)*.

For frequency converters with DC fans, there is a feedback sensor mounted in the fan. If the fan is commanded to run and there is no feedback from the sensor, this alarm appears. For frequency converters with AC fans, the voltage to the fan is monitored.

Troubleshooting

- Check for proper fan operation.
- Cycle power to the frequency converter and check that the fan operates briefly at start-up.
- Check the sensors on the heat sink and control card.

WARNING 24, External fan fault

The fan warning function is an extra protective function that checks if the fan is running/mounted. The fan warning can be disabled in *14-53 Fan Monitor ([0] Disabled)*.

For frequency converters with DC fans, there is a feedback sensor mounted in the fan. If the fan is commanded to run and there is no feedback from the sensor, this alarm appears. For frequency converters with AC fans, the voltage to the fan is monitored.

Troubleshooting

- Check for proper fan operation.
- Cycle power to the frequency converter and check that the fan operates briefly at start-up.
- Check the sensors on the heat sink and control card.

WARNING 25, Brake resistor short circuit

The brake resistor is monitored during operation. If a short circuit occurs, the brake function is disabled and the warning appears. The frequency converter is still operational, but without the brake function.

Troubleshooting

- Remove the power to the frequency converter and replace the brake resistor (see *2-15 Brake Check*).

WARNING/ALARM 26, Brake resistor power limit

The power transmitted to the brake resistor is calculated as a mean value over the last 120 s of run time. The calculation is based on the DC-link voltage and the brake resistor value set in *2-16 AC brake Max. Current*. The warning is active when the dissipated braking power is higher than 90% of the brake resistor power. If option *[2] Trip* is selected in *2-13 Brake Power Monitoring*, the frequency converter trips when the dissipated braking power reaches 100%.

WARNING/ALARM 27, Brake chopper fault

The brake transistor is monitored during operation, and if a short circuit occurs, the brake function is disabled and a warning is issued. The frequency converter is still operational but, since the brake transistor has short-circuited, substantial power is transmitted to the brake resistor, even if it is inactive.

Troubleshooting

- Remove power to the frequency converter and remove the brake resistor.

WARNING/ALARM 28, Brake check failed

The brake resistor is not connected or not working. Check *2-15 Brake Check*.

ALARM 29, Heat Sink temp

The maximum temperature of the heat sink has been exceeded. The temperature fault does not reset until the temperature drops below a defined heat sink temperature. The trip and reset points are different based on the frequency converter power size.

Troubleshooting

Check for the following conditions.

- Ambient temperature too high.
- Motor cables too long.
- Incorrect airflow clearance above and below the frequency converter.
- Blocked airflow around the frequency converter.
- Damaged heat sink fan.
- Dirty heat sink.

ALARM 30, Motor phase U missing

Motor phase U between the frequency converter and the motor is missing.

Troubleshooting

- Remove the power from the frequency converter and check motor phase U.

ALARM 31, Motor phase V missing

Motor phase V between the frequency converter and the motor is missing.

Troubleshooting

- Remove the power from the frequency converter and check motor phase V.

ALARM 32, Motor phase W missing

Motor phase W between the frequency converter and the motor is missing.

Troubleshooting

- Remove the power from the frequency converter and check motor phase W.

ALARM 33, Inrush fault

Too many power-ups have occurred within a short time period.

Troubleshooting

- Let the unit cool to operating temperature.

WARNING/ALARM 34, Fieldbus communication fault

The fieldbus on the communication option card is not working.

WARNING/ALARM 36, Mains failure

This warning/alarm is only active if the supply voltage to the frequency converter is lost and *parameter 14-10 Mains Failure* is not set to option [0] *No Function*. Check the fuses to the frequency converter and mains supply to the unit.

ALARM 38, Internal fault

When an internal fault occurs, a code number defined in *Table 4.10* is displayed.

Troubleshooting

- Cycle power.
- Check that the option is properly installed.
- Check for loose or missing wiring.

It may be necessary to contact the Danfoss supplier or service department. Note the code number for further troubleshooting directions.

Number	Text
0	Serial port cannot be initialised. Contact the Danfoss supplier or Danfoss Service Department.
256-258	Power EEPROM data is defective or too old. Replace power card.
512-519	Internal fault. Contact the Danfoss supplier or Danfoss Service Department.
783	Parameter value outside of minimum/maximum limits.
1024-1284	Internal fault. Contact the Danfoss supplier or the Danfoss Service Department.
1299	The option SW in slot A is too old.
1300	The option SW in slot B is too old.

Number	Text
1302	The option SW in slot C1 is too old.
1315	The option SW in slot A is not supported (not allowed).
1316	The option SW in slot B is not supported (not allowed).
1318	The option SW in slot C1 is not supported (not allowed).
1379-2819	Internal fault. Contact the Danfoss supplier or Danfoss Service Department.
1792	HW reset of DSP.
1793	Motor derived parameters not transferred correctly to DSP.
1794	Power data not transferred correctly at power-up to DSP.
1795	The DSP has received too many unknown SPI telegrams. The frequency converter also uses this fault code if the MCO does not power up correctly, for example due to poor EMC protection or improper grounding.
1796	RAM copy error.
2561	Replace control card.
2820	LCP stack overflow.
2821	Serial port overflow.
2822	USB port overflow.
3072-5122	Parameter value is outside its limits.
5123	Option in slot A: Hardware incompatible with control board hardware.
5124	Option in slot B: Hardware incompatible with control board hardware.
5125	Option in slot C0: Hardware incompatible with control board hardware.
5126	Option in slot C1: Hardware incompatible with control board hardware.
5376-6231	Internal fault. Contact the Danfoss supplier or Danfoss Service Department.

Table 4.10 Internal Fault Codes

ALARM 39, Heat sink sensor

No feedback from the heat sink temperature sensor.

The signal from the IGBT thermal sensor is not available on the power card. The problem could be on the power card, on the gatedrive card, or the ribbon cable between the power card and gatedrive card.

WARNING 40, Overload of digital output terminal 27

Check the load connected to terminal 27 or remove the short circuit connection. Check *parameter 5-00 Digital I/O Mode* and *5-01 Terminal 27 Mode*.

WARNING 41, Overload of digital output terminal 29

Check the load connected to terminal 29 or remove the short circuit connection. Check *parameter 5-00 Digital I/O Mode* and *parameter 5-02 Terminal 29 Mode*.

WARNING 42, Overload of digital output on X30/6 or overload of digital output on X30/7

For X30/6, check the load connected to X30/6 or remove the short circuit connection. Check 5-32 Term X30/6 Digi Out (MCB 101).

For X30/7, check the load connected to X30/7 or remove the short-circuit connection. Check 5-33 Term X30/7 Digi Out (MCB 101).

ALARM 45, Earth fault 2

Ground fault.

Troubleshooting

- Check for proper grounding and loose connections.
- Check for proper wire size.
- Check the motor cables for short circuits or leakage currents.

ALARM 46, Power card supply

The supply on the power card is out of range.

There are 3 supplies generated by the switch mode supply (SMPS) on the power card:

- 24 V.
- 5 V.
- ± 18 V.

When powered with 24 V DC with the MCB 107 option, only the 24 V and 5 V supplies are monitored. When powered with 3-phase mains voltage, all 3 supplies are monitored.

Troubleshooting

- Check for a defective power card.
- Check for a defective control card.
- Check for a defective option card.
- If a 24 V DC supply is used, verify proper supply power.

WARNING 47, 24 V supply low

The supply on the power card is out of range.

There are 3 supplies generated by the switch mode supply (SMPS) on the power card:

- 24 V.
- 5 V.
- ± 18 V.

Troubleshooting

- Check for a defective power card.

WARNING 48, 1.8 V supply low

The 1.8 V DC supply used on the control card is outside of the allowable limits. The supply is measured on the control card. Check for a defective control card. If an option card is present, check for overvoltage.

WARNING 49, Speed limit

When the speed is outside of the specified range in *parameter 4-11 Motor Speed Low Limit [RPM]* and *parameter 4-13 Motor Speed High Limit [RPM]*, the frequency converter shows a warning. When the speed is below the specified limit in *parameter 1-86 Trip Speed Low [RPM]* (except when starting or stopping), the frequency converter trips.

ALARM 50, AMA calibration failed

Contact the Danfoss supplier or Danfoss Service.

ALARM 51, AMA check U_{nom} and I_{nom}

The settings for motor voltage, motor current, and motor power are wrong. Check the settings in *parameters 1-20 to 1-25*.

ALARM 52, AMA low I_{nom}

The motor current is too low. Check the settings in *parameter 4-18 Current Limit*.

ALARM 53, AMA motor too big

The motor is too big for the AMA to operate.

ALARM 54, AMA motor too small

The motor is too small for the AMA to operate.

ALARM 55, AMA parameter out of range

The parameter values of the motor are outside of the acceptable range. AMA cannot run.

ALARM 56, AMA interrupted by user

The user has interrupted AMA.

ALARM 57, AMA internal fault

Try to restart AMA. Repeated restarts can overheat the motor.

ALARM 58, AMA Internal fault

Contact the Danfoss supplier.

WARNING 59, Current limit

The current is higher than the value in *parameter 4-18 Current Limit*. Ensure that motor data in *parameters 1-20 to 1-25* are set correctly. Increase the current limit if necessary. Ensure that the system can operate safely at a higher limit.

WARNING 60, External interlock

A digital input signal is indicating a fault condition external to the frequency converter. An external interlock has commanded the frequency converter to trip. Clear the external fault condition. To resume normal operation, apply 24 V DC to the terminal programmed for external interlock. Reset the frequency converter.

WARNING 62, Output frequency at maximum limit

The output frequency has reached the value set in *parameter 4-19 Max Output Frequency*. Check the application for possible causes. Possibly increase the output frequency limit. Be sure that the system can operate safely at a higher output frequency. The warning clears when the output drops below the maximum limit.

WARNING/ALARM 65, Control card over temperature

The cut-out temperature of the control card is 80 °C.

Troubleshooting

- Check that the ambient operating temperature is within the limits.
- Check for clogged filters.
- Check the fan operation.
- Check the control card.

WARNING 66, Heat sink temperature low

The frequency converter is too cold to operate. This warning is based on the temperature sensor in the IGBT module.

Increase the ambient temperature of the unit. Also, a trickle amount of current can be supplied to the frequency converter whenever the motor is stopped by setting *parameter 2-00 DC Hold/Preheat Current* at 5% and *parameter 1-80 Function at Stop*.

ALARM 67, Option module configuration has changed

1 or more options have either been added or removed since the last power-down. Check that the configuration change is intentional and reset the unit.

ALARM 68, Safe Stop activated

STO has been activated. To resume normal operation, apply 24 V DC to terminal 37, then send a reset signal (via bus, digital I/O, or by pressing [Reset]).

ALARM 69, Power card temperature

The temperature sensor on the power card is either too hot or too cold.

Troubleshooting

- Check that the ambient operating temperature is within limits.
- Check for clogged filters.
- Check fan operation.
- Check the power card.

ALARM 70, Illegal FC configuration

The control card and power card are incompatible. To check compatibility, contact the Danfoss supplier with the type code of the unit from the nameplate and the part numbers of the cards.

ALARM 71, PTC 1 safe stop

STO has been activated from the VLT[®] PTC Thermistor Card MCB 112 (motor too warm). Normal operation can be resumed when the MCB 112 applies 24 V DC to terminal 37 again (when the motor temperature reaches an acceptable level) and when the digital input from the MCB 112 is deactivated. When that happens, send a reset signal (via bus or digital I/O, or press [Reset]).

ALARM 72, Dangerous failure

STO with trip lock. An unexpected combination of STO commands has occurred:

- VLT[®] PTC Thermistor Card MCB 112 enables X44/10, but STO is not enabled.
- MCB 112 is the only device using STO (specified through selection [4] *PTC 1 Alarm* or [5] *PTC 1 Warning* in *parameter 5-19 Terminal 37 Safe Stop*), STO is activated, and X44/10 is not activated.

ALARM 80, Drive initialised to default value

Parameter settings are initialised to default settings after a manual reset. To clear the alarm, reset the unit.

ALARM 92, No flow

A no-flow condition has been detected in the system. *Parameter 22-23 No-Flow Function* is set for alarm.

Troubleshooting

- Troubleshoot the system and reset the frequency converter after the fault has been cleared.

ALARM 93, Dry pump

A no-flow condition in the system with the frequency converter operating at high speed may indicate a dry pump. *Parameter 22-26 Dry Pump Function* is set for alarm.

Troubleshooting

- Troubleshoot the system and reset the frequency converter after the fault has been cleared.

ALARM 94, End of curve

The feedback is lower than the setpoint. This may indicate leakage in the system. *Parameter 22-50 End of Curve Function* is set for alarm.

Troubleshooting

- Troubleshoot the system and reset the frequency converter after the fault has been cleared.

ALARM 95, Broken belt

Torque is below the torque level set for no load, indicating a broken belt. *Parameter 22-60 Broken Belt Function* is set for alarm.

Troubleshooting

- Troubleshoot the system and reset the frequency converter after the fault has been cleared.

ALARM 96, Start delayed

Motor start has been delayed due to short-cycle protection. *Parameter 22-76 Interval between Starts* is enabled. Troubleshoot the system and reset the frequency converter after the fault has been cleared.

WARNING 97, Stop delayed

Stopping the motor has been delayed due to short cycle protection. *Parameter 22-76 Interval between Starts* is enabled.

Troubleshooting

- Troubleshoot the system and reset the frequency converter after the fault has been cleared.

WARNING 98, Clock fault

Time is not set or the RTC clock has failed. Reset the clock in *parameter 0-70 Date and Time*.

WARNING 200, Fire mode

This warning indicates that the frequency converter is operating in fire mode. The warning clears when fire mode is removed. See the fire mode data in the alarm log.

WARNING 201, Fire mode was active

This indicates that the frequency converter has entered fire mode. Cycle power to the unit to remove the warning. See the fire mode data in the alarm log.

WARNING 202, Fire mode limits exceeded

While operating in fire mode, 1 or more alarm conditions have been ignored which would normally trip the unit. Operating in this condition voids unit warranty. Cycle power to the unit to remove the warning. See the fire mode data in the alarm log.

WARNING 203, Missing motor

With a frequency converter operating multi-motors, an underload condition was detected. This could indicate a missing motor. Inspect the system for proper operation.

WARNING 204, Locked rotor

With a frequency converter operating multi-motors, an overload condition was detected. This could indicate a locked rotor. Inspect the motor for proper operation.

WARNING 250, New spare part

A component in the frequency converter has been replaced.

Troubleshooting

- Reset the frequency converter for normal operation.

WARNING 251, New typecode

The power card or other components have been replaced and the type code has been changed.

Troubleshooting

- Reset to remove the warning and resume normal operation.

5 Parameter Lists

5.1 Parameter Options

5.1.1 Default Settings

Changes during operation

TRUE means that the parameter can be changed while the frequency converter is in operation FALSE means that the frequency converter must be stopped before a change can be made.

4-Set-up

All set-up: The parameter can be set individually in each of the 4 set-ups, that is 1 single parameter can have 4 different data values.

1 set-up: Data value is the same in all set-ups.

SR

Size related.

N/A

No default value available.

Conversion index

This number refers to a conversion figure used when writing or reading by means of a frequency converter.

Conv. index	100	75	74	70	67	6	5	4	3	2	1	0	-1	-2	-3	-4	-5	-6
Conv. factor	1	3600000	3600	60	1/60	1000000	100000	10000	1000	100	10	1	0.1	0.01	0.001	0.0001	0.00001	0.000001

Table 5.1 Conversion Index

Data type	Description	Type
2	Integer 8	Int8
3	Integer 16	Int16
4	Integer 32	Int32
5	Unsigned 8	UInt8
6	Unsigned 16	UInt16
7	Unsigned 32	UInt32
9	Visible String	VisStr
33	Normalised value 2 bytes	N2
35	Bit sequence of 16 boolean variables	V2
54	Time difference w/o date	TimD

Table 5.2 Conversion Index Description

5.1.2 0-** Operation and Display

Parameter #	Parameter description	Default value	4 set-up	Change during operation	Conversion index	Type
0-0* Basic Settings						
0-01	Language	[0] English	1 set-up	TRUE	-	Uint8
0-02	Motor Speed Unit	[1] Hz	2 set-ups	FALSE	-	Uint8
0-03	Regional Settings	ExpressionLimit	2 set-ups	FALSE	-	Uint8
0-04	Operating State at Power-up	[0] Resume	All set-ups	TRUE	-	Uint8
0-1* Set-up Operations						
0-10	Active Set-up	[1] Set-up 1	1 set-up	TRUE	-	Uint8
0-11	Programming Set-up	[9] Active Set-up	All set-ups	TRUE	-	Uint8
0-12	This Set-up Linked to	[0] Not linked	All set-ups	FALSE	-	Uint8
0-13	Readout: Linked Set-ups	0 N/A	All set-ups	FALSE	0	Uint16
0-14	Readout: Prog. Set-ups / Channel	0 N/A	All set-ups	TRUE	0	Int32
0-2* LCP Display						
0-20	Display Line 1.1 Small	1602	All set-ups	TRUE	-	Uint16
0-21	Display Line 1.2 Small	1614	All set-ups	TRUE	-	Uint16
0-22	Display Line 1.3 Small	1610	All set-ups	TRUE	-	Uint16
0-23	Display Line 2 Large	1613	All set-ups	TRUE	-	Uint16
0-24	Display Line 3 Large	1502	All set-ups	TRUE	-	Uint16
0-25	My Personal Menu	ExpressionLimit	1 set-up	TRUE	0	Uint16
0-3* LCP Custom Readout						
0-30	Custom Readout Unit	[1] %	All set-ups	TRUE	-	Uint8
0-31	Custom Readout Min Value	ExpressionLimit	All set-ups	TRUE	-2	Int32
0-32	Custom Readout Max Value	100 CustomReadoutUnit	All set-ups	TRUE	-2	Int32
0-37	Display Text 1	0 N/A	1 set-up	TRUE	0	VisStr[25]
0-38	Display Text 2	0 N/A	1 set-up	TRUE	0	VisStr[25]
0-39	Display Text 3	0 N/A	1 set-up	TRUE	0	VisStr[25]
0-4* LCP Keypad						
0-40	[Hand on] Key on LCP	[1] Enabled	All set-ups	TRUE	-	Uint8
0-41	[Off] Key on LCP	[1] Enabled	All set-ups	TRUE	-	Uint8
0-42	[Auto on] Key on LCP	[1] Enabled	All set-ups	TRUE	-	Uint8
0-43	[Reset] Key on LCP	[1] Enabled	All set-ups	TRUE	-	Uint8
0-5* Copy/Save						
0-50	LCP Copy	[0] No copy	All set-ups	FALSE	-	Uint8
0-51	Set-up Copy	[0] No copy	All set-ups	FALSE	-	Uint8
0-6* Password						
0-60	Main Menu Password	100 N/A	1 set-up	TRUE	0	Int16
0-61	Access to Main Menu w/o Password	[0] Full access	1 set-up	TRUE	-	Uint8
0-65	Personal Menu Password	200 N/A	1 set-up	TRUE	0	Int16
0-66	Access to Personal Menu w/o Password	[0] Full access	1 set-up	TRUE	-	Uint8
0-67	Bus Access Password	0 N/A	All set-ups	TRUE	0	Uint16
0-7* Clock Settings						
0-70	Date and Time	ExpressionLimit	All set-ups	TRUE	0	TimeOfDay
0-71	Date Format	ExpressionLimit	1 set-up	TRUE	-	Uint8
0-72	Time Format	ExpressionLimit	1 set-up	TRUE	-	Uint8
0-74	DST/Summertime	[0] Off	1 set-up	TRUE	-	Uint8
0-76	DST/Summertime Start	ExpressionLimit	1 set-up	TRUE	0	TimeOfDay
0-77	DST/Summertime End	ExpressionLimit	1 set-up	TRUE	0	TimeOfDay
0-79	Clock Fault	ExpressionLimit	1 set-up	TRUE	-	Uint8
0-81	Working Days	ExpressionLimit	1 set-up	TRUE	-	Uint8

0-82	Additional Working Days	ExpressionLimit	1 set-up	TRUE	0	TimeOfDay
0-83	Additional Non-Working Days	ExpressionLimit	1 set-up	TRUE	0	TimeOfDay
0-89	Date and Time Readout	0 N/A	All set-ups	TRUE	0	VisStr[25]

5.1.3 1-** Load / Motor

Parameter #	Parameter description	Default value	4 set-up	Change during operation	Conversion index	Type
1-0* General Settings						
1-00	Configuration Mode	ExpressionLimit	All set-ups	TRUE	-	Uint8
1-03	Torque Characteristics	[3] Auto Energy Optim. VT	All set-ups	TRUE	-	Uint8
1-06	Clockwise Direction	[0] Normal	All set-ups	FALSE	-	Uint8
1-1* Motor Selection						
1-10	Motor Construction	[0] Asynchron	All set-ups	FALSE	-	Uint8
1-1* VVC+ PM						
1-14	Damping Gain	120 %	All set-ups	TRUE	0	Int16
1-15	Low Speed Filter Time Const.	ExpressionLimit	All set-ups	TRUE	-2	Uint16
1-16	High Speed Filter Time Const.	ExpressionLimit	All set-ups	TRUE	-2	Uint16
1-17	Voltage filter time const.	ExpressionLimit	All set-ups	TRUE	-3	Uint16
1-2* Motor Data						
1-20	Motor Power [kW]	ExpressionLimit	All set-ups	FALSE	1	Uint32
1-21	Motor Power [HP]	ExpressionLimit	All set-ups	FALSE	-2	Uint32
1-22	Motor Voltage	ExpressionLimit	All set-ups	FALSE	0	Uint16
1-23	Motor Frequency	ExpressionLimit	All set-ups	FALSE	0	Uint16
1-24	Motor Current	ExpressionLimit	All set-ups	FALSE	-2	Uint32
1-25	Motor Nominal Speed	ExpressionLimit	All set-ups	FALSE	67	Uint16
1-26	Motor Cont. Rated Torque	ExpressionLimit	All set-ups	FALSE	-1	Uint32
1-28	Motor Rotation Check	[0] Off	All set-ups	FALSE	-	Uint8
1-29	Automatic Motor Adaptation (AMA)	[0] Off	All set-ups	FALSE	-	Uint8
1-3* Adv. Motor Data						
1-30	Stator Resistance (Rs)	ExpressionLimit	All set-ups	FALSE	-4	Uint32
1-31	Rotor Resistance (Rr)	ExpressionLimit	All set-ups	FALSE	-4	Uint32
1-35	Main Reactance (Xh)	ExpressionLimit	All set-ups	FALSE	-4	Uint32
1-36	Iron Loss Resistance (Rfe)	ExpressionLimit	All set-ups	FALSE	-3	Uint32
1-37	d-axis Inductance (Ld)	ExpressionLimit	All set-ups	FALSE	-6	Int32
1-39	Motor Poles	ExpressionLimit	All set-ups	FALSE	0	Uint8
1-40	Back EMF at 1000 RPM	ExpressionLimit	All set-ups	FALSE	0	Uint16
1-46	Position Detection Gain	100 %	All set-ups	TRUE	0	Uint16
1-5* Load Indep. Setting						
1-50	Motor Magnetisation at Zero Speed	100 %	All set-ups	TRUE	0	Uint16
1-51	Min Speed Normal Magnetising [RPM]	ExpressionLimit	All set-ups	TRUE	67	Uint16
1-52	Min Speed Normal Magnetising [Hz]	ExpressionLimit	All set-ups	TRUE	-1	Uint16
1-58	Flystart Test Pulses Current	ExpressionLimit	All set-ups	FALSE	0	Uint16
1-59	Flystart Test Pulses Frequency	ExpressionLimit	All set-ups	FALSE	0	Uint16
1-6* Load Depen. Setting						
1-60	Low Speed Load Compensation	100 %	All set-ups	TRUE	0	Int16
1-61	High Speed Load Compensation	100 %	All set-ups	TRUE	0	Int16
1-62	Slip Compensation	0 %	All set-ups	TRUE	0	Int16
1-63	Slip Compensation Time Constant	ExpressionLimit	All set-ups	TRUE	-2	Uint16
1-64	Resonance Dampening	100 %	All set-ups	TRUE	0	Uint16
1-65	Resonance Dampening Time Constant	5 ms	All set-ups	TRUE	-3	Uint8
1-66	Min. Current at Low Speed	ExpressionLimit	All set-ups	TRUE	0	Uint8
1-7* Start Adjustments						

1-70	PM Start Mode	[1] Parking	All set-ups	TRUE	-	Uint8
1-71	Start Delay	00 s	All set-ups	TRUE	-1	Uint16
1-72	Start Function	ExpressionLimit	All set-ups	TRUE	-	Uint8
1-73	Flying Start	ExpressionLimit	All set-ups	TRUE	-	Uint8
1-77	Compressor Start Max Speed [RPM]	ExpressionLimit	All set-ups	TRUE	67	Uint16
1-78	Compressor Start Max Speed [Hz]	ExpressionLimit	All set-ups	TRUE	-1	Uint16
1-79	Compressor Start Max Time to Trip	5 s	All set-ups	TRUE	-1	Uint8
1-8* Stop Adjustments						
1-80	Function at Stop	[0] Coast	All set-ups	TRUE	-	Uint8
1-81	Min Speed for Function at Stop [RPM]	ExpressionLimit	All set-ups	TRUE	67	Uint16
1-82	Min Speed for Function at Stop [Hz]	ExpressionLimit	All set-ups	TRUE	-1	Uint16
1-86	Trip Speed Low [RPM]	ExpressionLimit	All set-ups	TRUE	67	Uint16
1-87	Trip Speed Low [Hz]	ExpressionLimit	All set-ups	TRUE	-1	Uint16
1-9* Motor Temperature						
1-90	Motor Thermal Protection	ExpressionLimit	All set-ups	TRUE	-	Uint8
1-91	Motor External Fan	[0] No	All set-ups	TRUE	-	Uint16
1-93	Thermistor Source	[0] None	All set-ups	TRUE	-	Uint8

5

5.1.4 2-** Brakes

Parameter #	Parameter description	Default value	4 set-up	Change during operation	Conversion index	Type
2-0* DC-Brake						
2-00	DC Hold/Preheat Current	50 %	All set-ups	TRUE	0	Uint8
2-01	DC Brake Current	50 %	All set-ups	TRUE	0	Uint16
2-02	DC Braking Time	10 s	All set-ups	TRUE	-1	Uint16
2-03	DC Brake Cut In Speed [RPM]	ExpressionLimit	All set-ups	TRUE	67	Uint16
2-04	DC Brake Cut In Speed [Hz]	ExpressionLimit	All set-ups	TRUE	-1	Uint16
2-06	Parking Current	50 %	All set-ups	TRUE	0	Uint16
2-07	Parking Time	3 s	All set-ups	TRUE	-1	Uint16
2-1* Brake Energy Funct.						
2-10	Brake Function	ExpressionLimit	All set-ups	TRUE	-	Uint8
2-11	Brake Resistor (ohm)	ExpressionLimit	All set-ups	TRUE	-2	Uint32
2-12	Brake Power Limit (kW)	ExpressionLimit	All set-ups	TRUE	0	Uint32
2-13	Brake Power Monitoring	[0] Off	All set-ups	TRUE	-	Uint8
2-15	Brake Check	[0] Off	All set-ups	TRUE	-	Uint8
2-16	AC brake Max. Current	ExpressionLimit	All set-ups	TRUE	-1	Uint32
2-17	Over-voltage Control	[2] Enabled	All set-ups	TRUE	-	Uint8

5.1.5 3-** Reference / Ramps

Parameter #	Parameter description	Default value	4 set-up	Change during operation	Conversion index	Type
3-0* Reference Limits						
3-02	Minimum Reference	ExpressionLimit	All set-ups	TRUE	-3	Int32
3-03	Maximum Reference	ExpressionLimit	All set-ups	TRUE	-3	Int32
3-04	Reference Function	ExpressionLimit	All set-ups	TRUE	-	UInt8
3-1* References						
3-10	Preset Reference	0 %	All set-ups	TRUE	-2	Int16
3-11	Jog Speed [Hz]	ExpressionLimit	All set-ups	TRUE	-1	UInt16
3-13	Reference Site	[0] Linked to Hand / Auto	All set-ups	TRUE	-	UInt8
3-14	Preset Relative Reference	0 %	All set-ups	TRUE	-2	Int32
3-15	Reference 1 Source	[1] Analog Input 53	All set-ups	TRUE	-	UInt8
3-16	Reference 2 Source	[20] Digital pot.meter	All set-ups	TRUE	-	UInt8
3-17	Reference 3 Source	[0] No function	All set-ups	TRUE	-	UInt8
3-19	Jog Speed [RPM]	ExpressionLimit	All set-ups	TRUE	67	UInt16
3-4* Ramp 1						
3-41	Ramp 1 Ramp Up Time	ExpressionLimit	All set-ups	TRUE	-2	UInt32
3-42	Ramp 1 Ramp Down Time	ExpressionLimit	All set-ups	TRUE	-2	UInt32
3-5* Ramp 2						
3-51	Ramp 2 Ramp Up Time	ExpressionLimit	All set-ups	TRUE	-2	UInt32
3-52	Ramp 2 Ramp Down Time	ExpressionLimit	All set-ups	TRUE	-2	UInt32
3-8* Other Ramps						
3-80	Jog Ramp Time	ExpressionLimit	All set-ups	TRUE	-2	UInt32
3-82	Starting Ramp Up Time	ExpressionLimit	2 set-ups	TRUE	-2	UInt32
3-9* Digital Pot.Meter						
3-90	Step Size	0.10 %	All set-ups	TRUE	-2	UInt16
3-91	Ramp Time	1 s	All set-ups	TRUE	-2	UInt32
3-92	Power Restore	[0] Off	All set-ups	TRUE	-	UInt8
3-93	Maximum Limit	100 %	All set-ups	TRUE	0	Int16
3-94	Minimum Limit	0 %	All set-ups	TRUE	0	Int16
3-95	Ramp Delay	ExpressionLimit	All set-ups	TRUE	-3	TimD

5.1.6 4-** Limits / Warnings

Parameter #	Parameter description	Default value	4 set-up	Change during operation	Conversion index	Type
4-1* Motor Limits						
4-10	Motor Speed Direction	[2] Both directions	All set-ups	FALSE	-	UInt8
4-11	Motor Speed Low Limit [RPM]	ExpressionLimit	All set-ups	TRUE	67	UInt16
4-12	Motor Speed Low Limit [Hz]	ExpressionLimit	All set-ups	TRUE	-1	UInt16
4-13	Motor Speed High Limit [RPM]	ExpressionLimit	All set-ups	TRUE	67	UInt16
4-14	Motor Speed High Limit [Hz]	ExpressionLimit	All set-ups	TRUE	-1	UInt16
4-16	Torque Limit Motor Mode	ExpressionLimit	All set-ups	TRUE	-1	UInt16
4-17	Torque Limit Generator Mode	100 %	All set-ups	TRUE	-1	UInt16
4-18	Current Limit	ExpressionLimit	All set-ups	TRUE	-1	UInt32
4-19	Max Output Frequency	ExpressionLimit	All set-ups	FALSE	-1	UInt16
4-5* Adj. Warnings						
4-50	Warning Current Low	0 A	All set-ups	TRUE	-2	UInt32
4-51	Warning Current High	ImaxVLT (P1637)	All set-ups	TRUE	-2	UInt32
4-52	Warning Speed Low	0 RPM	All set-ups	TRUE	67	UInt16

4-53	Warning Speed High	outputSpeed-HighLimit (P413)	All set-ups	TRUE	67	Uint16
4-54	Warning Reference Low	-999999.999 N/A	All set-ups	TRUE	-3	Int32
4-55	Warning Reference High	999999.999 N/A	All set-ups	TRUE	-3	Int32
4-56	Warning Feedback Low	-999999.999 ProcessCtrlUnit	All set-ups	TRUE	-3	Int32
4-57	Warning Feedback High	999999.999 ProcessCtrlUnit	All set-ups	TRUE	-3	Int32
4-58	Missing Motor Phase Function	[2] Trip 1000 ms	All set-ups	TRUE	-	Uint8
4-6* Speed Bypass						
4-60	Bypass Speed From [RPM]	ExpressionLimit	All set-ups	TRUE	67	Uint16
4-61	Bypass Speed From [Hz]	ExpressionLimit	All set-ups	TRUE	-1	Uint16
4-62	Bypass Speed To [RPM]	ExpressionLimit	All set-ups	TRUE	67	Uint16
4-63	Bypass Speed To [Hz]	ExpressionLimit	All set-ups	TRUE	-1	Uint16
4-64	Semi-Auto Bypass Set-up	[0] Off	All set-ups	FALSE	-	Uint8

5.1.7 5-** Digital In / Out

Parameter #	Parameter description	Default value	4 set-up	Change during operation	Conversion index	Type
5-0* Digital I/O mode						
5-00	Digital I/O Mode	[0] PNP - Active at 24V	All set-ups	FALSE	-	Uint8
5-01	Terminal 27 Mode	[0] Input	All set-ups	TRUE	-	Uint8
5-02	Terminal 29 Mode	[0] Input	All set-ups	TRUE	-	Uint8
5-1* Digital Inputs						
5-10	Terminal 18 Digital Input	ExpressionLimit	All set-ups	TRUE	-	Uint8
5-11	Terminal 19 Digital Input	ExpressionLimit	All set-ups	TRUE	-	Uint8
5-12	Terminal 27 Digital Input	ExpressionLimit	All set-ups	TRUE	-	Uint8
5-13	Terminal 29 Digital Input	ExpressionLimit	All set-ups	TRUE	-	Uint8
5-14	Terminal 32 Digital Input	ExpressionLimit	All set-ups	TRUE	-	Uint8
5-15	Terminal 33 Digital Input	ExpressionLimit	All set-ups	TRUE	-	Uint8
5-16	Terminal X30/2 Digital Input	ExpressionLimit	All set-ups	TRUE	-	Uint8
5-17	Terminal X30/3 Digital Input	ExpressionLimit	All set-ups	TRUE	-	Uint8
5-18	Terminal X30/4 Digital Input	ExpressionLimit	All set-ups	TRUE	-	Uint8
5-19	Terminal 37 Safe Stop	ExpressionLimit	1 set-up	TRUE	-	Uint8
5-3* Digital Outputs						
5-30	Terminal 27 Digital Output	[0] No operation	All set-ups	TRUE	-	Uint8
5-31	Terminal 29 Digital Output	[0] No operation	All set-ups	TRUE	-	Uint8
5-32	Term X30/6 Digi Out (MCB 101)	[0] No operation	All set-ups	TRUE	-	Uint8
5-33	Term X30/7 Digi Out (MCB 101)	[0] No operation	All set-ups	TRUE	-	Uint8
5-4* Relays						
5-40	Function Relay	ExpressionLimit	All set-ups	TRUE	-	Uint8
5-41	On Delay, Relay	0.01 s	All set-ups	TRUE	-2	Uint16
5-42	Off Delay, Relay	0.01 s	All set-ups	TRUE	-2	Uint16
5-5* Pulse Input						
5-50	Term. 29 Low Frequency	100 Hz	All set-ups	TRUE	0	Uint32
5-51	Term. 29 High Frequency	100 Hz	All set-ups	TRUE	0	Uint32
5-52	Term. 29 Low Ref./Feedb. Value	0 N/A	All set-ups	TRUE	-3	Int32
5-53	Term. 29 High Ref./Feedb. Value	100 N/A	All set-ups	TRUE	-3	Int32
5-54	Pulse Filter Time Constant #29	100 ms	All set-ups	FALSE	-3	Uint16
5-55	Term. 33 Low Frequency	100 Hz	All set-ups	TRUE	0	Uint32
5-56	Term. 33 High Frequency	100 Hz	All set-ups	TRUE	0	Uint32
5-57	Term. 33 Low Ref./Feedb. Value	0 N/A	All set-ups	TRUE	-3	Int32

5-58	Term. 33 High Ref./Feedb. Value	100 N/A	All set-ups	TRUE	-3	Int32
5-59	Pulse Filter Time Constant #33	100 ms	All set-ups	FALSE	-3	UInt16
5-6* Pulse Output						
5-60	Terminal 27 Pulse Output Variable	[0] No operation	All set-ups	TRUE	-	UInt8
5-62	Pulse Output Max Freq #27	5000 Hz	All set-ups	TRUE	0	UInt32
5-63	Terminal 29 Pulse Output Variable	[0] No operation	All set-ups	TRUE	-	UInt8
5-65	Pulse Output Max Freq #29	5000 Hz	All set-ups	TRUE	0	UInt32
5-66	Terminal X30/6 Pulse Output Variable	[0] No operation	All set-ups	TRUE	-	UInt8
5-68	Pulse Output Max Freq #X30/6	5000 Hz	All set-ups	TRUE	0	UInt32
5-8* I/O Options						
5-80	AHF Cap Reconnect Delay	25 s	2 set-ups	TRUE	0	UInt16
5-9* Bus Controlled						
5-90	Digital & Relay Bus Control	0 N/A	All set-ups	TRUE	0	UInt32
5-93	Pulse Out #27 Bus Control	0 %	All set-ups	TRUE	-2	N2
5-94	Pulse Out #27 Timeout Preset	0 %	1 set-up	TRUE	-2	UInt16
5-95	Pulse Out #29 Bus Control	0 %	All set-ups	TRUE	-2	N2
5-96	Pulse Out #29 Timeout Preset	0 %	1 set-up	TRUE	-2	UInt16
5-97	Pulse Out #X30/6 Bus Control	0 %	All set-ups	TRUE	-2	N2
5-98	Pulse Out #X30/6 Timeout Preset	0 %	1 set-up	TRUE	-2	UInt16

5.1.8 6-** Analog In / Out

Parameter #	Parameter description	Default value	4 set-up	Change during operation	Conversion index	Type
6-0* Analog I/O Mode						
6-00	Live Zero Timeout Time	10 s	All set-ups	TRUE	0	UInt8
6-01	Live Zero Timeout Function	[0] Off	All set-ups	TRUE	-	UInt8
6-02	Fire Mode Live Zero Timeout Function	[0] Off	All set-ups	TRUE	-	UInt8
6-1* Analog Input 53						
6-10	Terminal 53 Low Voltage	0.07 V	All set-ups	TRUE	-2	Int16
6-11	Terminal 53 High Voltage	10 V	All set-ups	TRUE	-2	Int16
6-12	Terminal 53 Low Current	4 mA	All set-ups	TRUE	-5	Int16
6-13	Terminal 53 High Current	20 mA	All set-ups	TRUE	-5	Int16
6-14	Terminal 53 Low Ref./Feedb. Value	0 N/A	All set-ups	TRUE	-3	Int32
6-15	Terminal 53 High Ref./Feedb. Value	ExpressionLimit	All set-ups	TRUE	-3	Int32
6-16	Terminal 53 Filter Time Constant	0.001 s	All set-ups	TRUE	-3	UInt16
6-17	Terminal 53 Live Zero	[1] Enabled	All set-ups	TRUE	-	UInt8
6-2* Analog Input 54						
6-20	Terminal 54 Low Voltage	0.07 V	All set-ups	TRUE	-2	Int16
6-21	Terminal 54 High Voltage	10 V	All set-ups	TRUE	-2	Int16
6-22	Terminal 54 Low Current	4 mA	All set-ups	TRUE	-5	Int16
6-23	Terminal 54 High Current	20 mA	All set-ups	TRUE	-5	Int16
6-24	Terminal 54 Low Ref./Feedb. Value	0 N/A	All set-ups	TRUE	-3	Int32
6-25	Terminal 54 High Ref./Feedb. Value	100 N/A	All set-ups	TRUE	-3	Int32
6-26	Terminal 54 Filter Time Constant	0.001 s	All set-ups	TRUE	-3	UInt16
6-27	Terminal 54 Live Zero	[1] Enabled	All set-ups	TRUE	-	UInt8
6-3* Analog Input X30/11						
6-30	Terminal X30/11 Low Voltage	0.07 V	All set-ups	TRUE	-2	Int16
6-31	Terminal X30/11 High Voltage	10 V	All set-ups	TRUE	-2	Int16
6-34	Term. X30/11 Low Ref./Feedb. Value	0 N/A	All set-ups	TRUE	-3	Int32
6-35	Term. X30/11 High Ref./Feedb. Value	100 N/A	All set-ups	TRUE	-3	Int32
6-36	Term. X30/11 Filter Time Constant	0.001 s	All set-ups	TRUE	-3	UInt16
6-37	Term. X30/11 Live Zero	[1] Enabled	All set-ups	TRUE	-	UInt8
6-4* Analog Input X30/12						

6-40	Terminal X30/12 Low Voltage	0.07 V	All set-ups	TRUE	-2	Int16
6-41	Terminal X30/12 High Voltage	10 V	All set-ups	TRUE	-2	Int16
6-44	Term. X30/12 Low Ref./Feedb. Value	0 N/A	All set-ups	TRUE	-3	Int32
6-45	Term. X30/12 High Ref./Feedb. Value	100 N/A	All set-ups	TRUE	-3	Int32
6-46	Term. X30/12 Filter Time Constant	0.001 s	All set-ups	TRUE	-3	Uint16
6-47	Term. X30/12 Live Zero	[1] Enabled	All set-ups	TRUE	-	Uint8
6-5* Analog Output 42						
6-50	Terminal 42 Output	ExpressionLimit	All set-ups	TRUE	-	Uint8
6-51	Terminal 42 Output Min Scale	0 %	All set-ups	TRUE	-2	Int16
6-52	Terminal 42 Output Max Scale	100 %	All set-ups	TRUE	-2	Int16
6-53	Terminal 42 Output Bus Control	0 %	All set-ups	TRUE	-2	N2
6-54	Terminal 42 Output Timeout Preset	0 %	1 set-up	TRUE	-2	Uint16
6-55	Analog Output Filter	[0] Off	1 set-up	TRUE	-	Uint8
6-6* Analog Output X30/8						
6-60	Terminal X30/8 Output	[0] No operation	All set-ups	TRUE	-	Uint8
6-61	Terminal X30/8 Min. Scale	0 %	All set-ups	TRUE	-2	Int16
6-62	Terminal X30/8 Max. Scale	100 %	All set-ups	TRUE	-2	Int16
6-63	Terminal X30/8 Output Bus Control	0 %	All set-ups	TRUE	-2	N2
6-64	Terminal X30/8 Output Timeout Preset	0 %	1 set-up	TRUE	-2	Uint16

5

5.1.9 8-** Communication and Options

Parameter #	Parameter description	Default value	4 set-up	Change during operation	Conversion index	Type
8-0* General Settings						
8-01	Control Site	ExpressionLimit	All set-ups	TRUE	-	Uint8
8-02	Control Source	ExpressionLimit	All set-ups	TRUE	-	Uint8
8-03	Control Timeout Time	ExpressionLimit	1 set-up	TRUE	-1	Uint32
8-04	Control Timeout Function	[0] Off	1 set-up	TRUE	-	Uint8
8-05	End-of-Timeout Function	[1] Resume set-up	1 set-up	TRUE	-	Uint8
8-06	Reset Control Timeout	[0] Do not reset	All set-ups	TRUE	-	Uint8
8-07	Diagnosis Trigger	[0] Disable	2 set-ups	TRUE	-	Uint8
8-08	Readout Filtering	ExpressionLimit	All set-ups	TRUE	-	Uint8
8-1* Control Settings						
8-10	Control Profile	[0] FC profile	All set-ups	TRUE	-	Uint8
8-13	Configurable Status Word STW	[1] Profile Default	All set-ups	TRUE	-	Uint8
8-3* FC Port Settings						
8-30	Protocol	ExpressionLimit	1 set-up	TRUE	-	Uint8
8-31	Address	ExpressionLimit	1 set-up	TRUE	0	Uint8
8-32	Baud Rate	ExpressionLimit	1 set-up	TRUE	-	Uint8
8-33	Parity / Stop Bits	ExpressionLimit	1 set-up	TRUE	-	Uint8
8-34	Estimated cycle time	0 ms	2 set-ups	TRUE	-3	Uint32
8-35	Minimum Response Delay	ExpressionLimit	1 set-up	TRUE	-3	Uint16
8-36	Maximum Response Delay	ExpressionLimit	1 set-up	TRUE	-3	Uint16
8-37	Maximum Inter-Char Delay	ExpressionLimit	1 set-up	TRUE	-5	Uint16
8-4* FC MC protocol set						
8-40	Telegram Selection	[1] Standard telegram 1	2 set-ups	TRUE	-	Uint8
8-42	PCD Write Configuration	ExpressionLimit	2 set-ups	TRUE	-	Uint16
8-43	PCD Read Configuration	ExpressionLimit	2 set-ups	TRUE	-	Uint16
8-5* Digital/Bus						
8-50	Coasting Select	[3] Logic OR	All set-ups	TRUE	-	Uint8
8-52	DC Brake Select	ExpressionLimit	All set-ups	TRUE	-	Uint8
8-53	Start Select	[3] Logic OR	All set-ups	TRUE	-	Uint8

8-54	Reversing Select	ExpressionLimit	All set-ups	TRUE	-	Uint8
8-55	Set-up Select	[3] Logic OR	All set-ups	TRUE	-	Uint8
8-56	Preset Reference Select	[3] Logic OR	All set-ups	TRUE	-	Uint8
8-7* BACnet						
8-70	BACnet Device Instance	1 N/A	1 set-up	TRUE	0	Uint32
8-72	MS/TP Max Masters	127 N/A	1 set-up	TRUE	0	Uint8
8-73	MS/TP Max Info Frames	1 N/A	1 set-up	TRUE	0	Uint16
8-74	"I-Am" Service	[0] Send at power-up	1 set-up	TRUE	-	Uint8
8-75	Initialisation Password	ExpressionLimit	1 set-up	TRUE	0	VisStr[20]
8-8* FC Port Diagnostics						
8-80	Bus Message Count	0 N/A	All set-ups	TRUE	0	Uint32
8-81	Bus Error Count	0 N/A	All set-ups	TRUE	0	Uint32
8-82	Slave Messages Rcvd	0 N/A	All set-ups	TRUE	0	Uint32
8-83	Slave Error Count	0 N/A	All set-ups	TRUE	0	Uint32
8-84	Slave Messages Sent	0 N/A	All set-ups	TRUE	0	Uint32
8-85	Slave Timeout Errors	0 N/A	All set-ups	TRUE	0	Uint32
8-9* Bus Jog / Feedback						
8-90	Bus Jog 1 Speed	100 RPM	All set-ups	TRUE	67	Uint16
8-91	Bus Jog 2 Speed	200 RPM	All set-ups	TRUE	67	Uint16
8-94	Bus Feedback 1	0 N/A	1 set-up	TRUE	0	N2
8-95	Bus Feedback 2	0 N/A	1 set-up	TRUE	0	N2
8-96	Bus Feedback 3	0 N/A	1 set-up	TRUE	0	N2

5.1.10 9-** Profibus

Parameter #	Parameter description	Default value	4 set-up	Change during operation	Conversion index	Type
9-15	PCD Write Configuration	ExpressionLimit	2 set-ups	TRUE	-	Uint16
9-16	PCD Read Configuration	ExpressionLimit	2 set-ups	TRUE	-	Uint16
9-18	Node Address	126 N/A	1 set-up	TRUE	0	Uint8
9-22	Telegram Selection	[108] PPO 8	1 set-up	TRUE	-	Uint8
9-23	Parameters for Signals	0	All set-ups	TRUE	-	Uint16
9-27	Parameter Edit	[1] Enabled	2 set-ups	FALSE	-	Uint16
9-28	Process Control	[1] Enable cyclic master	2 set-ups	FALSE	-	Uint8
9-53	Profibus Warning Word	0 N/A	All set-ups	TRUE	0	V2
9-63	Actual Baud Rate	[255] No baudrate found	All set-ups	TRUE	-	Uint8
9-65	Profile Number	0 N/A	All set-ups	TRUE	0	OctStr[2]
9-70	Programming Set-up	[9] Active Set-up	All set-ups	TRUE	-	Uint8
9-71	Profibus Save Data Values	[0] Off	All set-ups	TRUE	-	Uint8
9-72	ProfibusDriveReset	[0] No action	1 set-up	FALSE	-	Uint8
9-80	Defined Parameters (1)	0 N/A	All set-ups	FALSE	0	Uint16
9-81	Defined Parameters (2)	0 N/A	All set-ups	FALSE	0	Uint16
9-82	Defined Parameters (3)	0 N/A	All set-ups	FALSE	0	Uint16
9-83	Defined Parameters (4)	0 N/A	All set-ups	FALSE	0	Uint16
9-90	Changed Parameters (1)	0 N/A	All set-ups	FALSE	0	Uint16
9-91	Changed Parameters (2)	0 N/A	All set-ups	FALSE	0	Uint16
9-92	Changed Parameters (3)	0 N/A	All set-ups	FALSE	0	Uint16
9-94	Changed Parameters (5)	0 N/A	All set-ups	FALSE	0	Uint16

5.1.11 10-** CAN Fieldbus

Parameter #	Parameter description	Default value	4 set-up	Change during operation	Conversion index	Type
10-0* Common Settings						
10-00	CAN Protocol	ExpressionLimit	2 set-ups	FALSE	-	Uint8
10-01	Baud Rate Select	ExpressionLimit	2 set-ups	TRUE	-	Uint8
10-02	MAC ID	ExpressionLimit	2 set-ups	TRUE	0	Uint8
10-05	Readout Transmit Error Counter	0 N/A	All set-ups	TRUE	0	Uint8
10-06	Readout Receive Error Counter	0 N/A	All set-ups	TRUE	0	Uint8
10-07	Readout Bus Off Counter	0 N/A	All set-ups	TRUE	0	Uint8
10-1* DeviceNet						
10-10	Process Data Type Selection	ExpressionLimit	All set-ups	TRUE	-	Uint8
10-11	Process Data Config Write	ExpressionLimit	2 set-ups	TRUE	-	Uint16
10-12	Process Data Config Read	ExpressionLimit	2 set-ups	TRUE	-	Uint16
10-13	Warning Parameter	0 N/A	All set-ups	TRUE	0	Uint16
10-14	Net Reference	[0] Off	2 set-ups	TRUE	-	Uint8
10-15	Net Control	[0] Off	2 set-ups	TRUE	-	Uint8
10-2* COS Filters						
10-20	COS Filter 1	0 N/A	All set-ups	FALSE	0	Uint16
10-21	COS Filter 2	0 N/A	All set-ups	FALSE	0	Uint16
10-22	COS Filter 3	0 N/A	All set-ups	FALSE	0	Uint16
10-23	COS Filter 4	0 N/A	All set-ups	FALSE	0	Uint16
10-3* Parameter Access						
10-30	Array Index	0 N/A	2 set-ups	TRUE	0	Uint8
10-31	Store Data Values	[0] Off	All set-ups	TRUE	-	Uint8
10-32	Devicenet Revision	0 N/A	All set-ups	TRUE	0	Uint16
10-33	Store Always	[0] Off	1 set-up	TRUE	-	Uint8

5.1.12 11-** LonWorks

Parameter #	Parameter description	Default value	4 set-up	Change during operation	Conversion index	Type
11-0* LonWorks ID						
11-00	Neuron ID	0 N/A	All set-ups	TRUE	0	OctStr[6]
11-1* LON Functions						
11-10	Drive Profile	[0] VSD profile	All set-ups	TRUE	-	UInt8
11-15	LON Warning Word	0 N/A	All set-ups	TRUE	0	UInt16
11-17	XIF Revision	0 N/A	All set-ups	TRUE	0	VisStr[5]
11-18	LonWorks Revision	0 N/A	All set-ups	TRUE	0	VisStr[5]
11-2* LON Param. Access						
11-21	Store Data Values	[0] Off	All set-ups	TRUE	-	UInt8

5

5.1.13 13-** Smart Logic Controller

Parameter #	Parameter description	Default value	4 set-up	Change during operation	Conversion index	Type
13-0* SLC Settings						
13-00	SL Controller Mode	ExpressionLimit	2 set-ups	TRUE	-	UInt8
13-01	Start Event	ExpressionLimit	2 set-ups	TRUE	-	UInt8
13-02	Stop Event	ExpressionLimit	2 set-ups	TRUE	-	UInt8
13-03	Reset SLC	[0] Do not reset SLC	All set-ups	TRUE	-	UInt8
13-1* Comparators						
13-10	Comparator Operand	ExpressionLimit	2 set-ups	TRUE	-	UInt8
13-11	Comparator Operator	ExpressionLimit	2 set-ups	TRUE	-	UInt8
13-12	Comparator Value	ExpressionLimit	2 set-ups	TRUE	-3	Int32
13-2* Timers						
13-20	SL Controller Timer	ExpressionLimit	1 set-up	TRUE	-3	TimD
13-4* Logic Rules						
13-40	Logic Rule Boolean 1	ExpressionLimit	2 set-ups	TRUE	-	UInt8
13-41	Logic Rule Operator 1	ExpressionLimit	2 set-ups	TRUE	-	UInt8
13-42	Logic Rule Boolean 2	ExpressionLimit	2 set-ups	TRUE	-	UInt8
13-43	Logic Rule Operator 2	ExpressionLimit	2 set-ups	TRUE	-	UInt8
13-44	Logic Rule Boolean 3	ExpressionLimit	2 set-ups	TRUE	-	UInt8
13-5* States						
13-51	SL Controller Event	ExpressionLimit	2 set-ups	TRUE	-	UInt8
13-52	SL Controller Action	ExpressionLimit	2 set-ups	TRUE	-	UInt8

5.1.14 14-** Special Functions

Parameter #	Parameter description	Default value	4 set-up	Change during operation	Conversion index	Type
14-0* Inverter Switching						
14-00	Switching Pattern	ExpressionLimit	All set-ups	TRUE	-	UInt8
14-01	Switching Frequency	ExpressionLimit	All set-ups	TRUE	-	UInt8
14-03	Overmodulation	[0] Off	All set-ups	FALSE	-	UInt8
14-04	PWM Random	[0] Off	All set-ups	TRUE	-	UInt8
14-1* Mains On/Off						
14-10	Mains Failure	[0] No function	All set-ups	FALSE	-	UInt8
14-11	Mains Voltage at Mains Fault	ExpressionLimit	All set-ups	TRUE	0	UInt16
14-12	Function at Mains Imbalance	[0] Trip	All set-ups	TRUE	-	UInt8
14-2* Reset Functions						

14-20	Reset Mode	ExpressionLimit	All set-ups	TRUE	-	Uint8
14-21	Automatic Restart Time	10 s	All set-ups	TRUE	0	Uint16
14-22	Operation Mode	[0] Normal operation	All set-ups	TRUE	-	Uint8
14-25	Trip Delay at Torque Limit	60 s	All set-ups	TRUE	0	Uint8
14-26	Trip Delay at Inverter Fault	ExpressionLimit	All set-ups	TRUE	0	Uint8
14-29	Service Code	0 N/A	All set-ups	TRUE	0	Int32
14-3* Current Limit Ctrl.						
14-30	Current Lim Ctrl, Proportional Gain	100 %	All set-ups	FALSE	0	Uint16
14-31	Current Lim Ctrl, Integration Time	ExpressionLimit	All set-ups	FALSE	-3	Uint16
14-32	Current Lim Ctrl, Filter Time	ExpressionLimit	All set-ups	TRUE	-4	Uint16
14-4* Energy Optimising						
14-40	VT Level	66 %	All set-ups	FALSE	0	Uint8
14-41	AEO Minimum Magnetisation	ExpressionLimit	All set-ups	TRUE	0	Uint8
14-42	Minimum AEO Frequency	10 Hz	All set-ups	TRUE	0	Uint8
14-43	Motor Cosphi	ExpressionLimit	All set-ups	TRUE	-2	Uint16
14-5* Environment						
14-50	RFI Filter	[1] On	1 set-up	FALSE	-	Uint8
14-51	DC Link Compensation	[1] On	1 set-up	TRUE	-	Uint8
14-52	Fan Control	[0] Auto	All set-ups	TRUE	-	Uint8
14-53	Fan Monitor	[1] Warning	All set-ups	TRUE	-	Uint8
14-55	Output Filter	[0] No Filter	1 set-up	FALSE	-	Uint8
14-59	Actual Number of Inverter Units	ExpressionLimit	1 set-up	FALSE	0	Uint8
14-6* Auto Derate						
14-60	Function at Over Temperature	[0] Trip	All set-ups	TRUE	-	Uint8
14-61	Function at Inverter Overload	[0] Trip	All set-ups	TRUE	-	Uint8
14-62	Inv. Overload Derate Current	95 %	All set-ups	TRUE	0	Uint16
14-9* Fault Settings						
14-90	Fault Level	ExpressionLimit	1 set-up	TRUE	-	Uint8

5.1.15 15-** Drive Information

Parameter #	Parameter description	Default value	4 set-up	Change during operation	Conversion index	Type
15-0* Operating Data						
15-00	Operating hours	0 h	All set-ups	FALSE	74	Uint32
15-01	Running Hours	0 h	All set-ups	FALSE	74	Uint32
15-02	kWh Counter	0 kWh	All set-ups	FALSE	75	Uint32
15-03	Power Up's	0 N/A	All set-ups	FALSE	0	Uint32
15-04	Over Temp's	0 N/A	All set-ups	FALSE	0	Uint16
15-05	Over Volt's	0 N/A	All set-ups	FALSE	0	Uint16
15-06	Reset kWh Counter	[0] Do not reset	All set-ups	TRUE	-	Uint8
15-07	Reset Running Hours Counter	[0] Do not reset	All set-ups	TRUE	-	Uint8
15-08	Number of Starts	0 N/A	All set-ups	FALSE	0	Uint32
15-1* Data Log Settings						
15-10	Logging Source	0	2 set-ups	TRUE	-	Uint16
15-11	Logging Interval	ExpressionLimit	2 set-ups	TRUE	-3	TimD
15-12	Trigger Event	[0] False	1 set-up	TRUE	-	Uint8
15-13	Logging Mode	[0] Log always	2 set-ups	TRUE	-	Uint8
15-14	Samples Before Trigger	50 N/A	2 set-ups	TRUE	0	Uint8
15-2* Historic Log						
15-20	Historic Log: Event	0 N/A	All set-ups	FALSE	0	Uint8
15-21	Historic Log: Value	0 N/A	All set-ups	FALSE	0	Uint32
15-22	Historic Log: Time	0 ms	All set-ups	FALSE	-3	Uint32

15-23	Historic log: Date and Time	ExpressionLimit	All set-ups	FALSE	0	TimeOfDay
15-3* Alarm Log						
15-30	Alarm Log: Error Code	0 N/A	All set-ups	FALSE	0	Uint8
15-31	Alarm Log: Value	0 N/A	All set-ups	FALSE	0	Int16
15-32	Alarm Log: Time	0 s	All set-ups	FALSE	0	Uint32
15-33	Alarm Log: Date and Time	ExpressionLimit	All set-ups	FALSE	0	TimeOfDay
15-4* Drive Identification						
15-40	FC Type	0 N/A	All set-ups	FALSE	0	VisStr[6]
15-41	Power Section	0 N/A	All set-ups	FALSE	0	VisStr[20]
15-42	Voltage	0 N/A	All set-ups	FALSE	0	VisStr[20]
15-43	Software Version	0 N/A	All set-ups	FALSE	0	VisStr[5]
15-44	Ordered Typecode String	0 N/A	All set-ups	FALSE	0	VisStr[40]
15-45	Actual Typecode String	0 N/A	All set-ups	FALSE	0	VisStr[40]
15-46	Frequency Converter Ordering No	0 N/A	All set-ups	FALSE	0	VisStr[8]
15-47	Power Card Ordering No	0 N/A	All set-ups	FALSE	0	VisStr[8]
15-48	LCP Id No	0 N/A	All set-ups	FALSE	0	VisStr[20]
15-49	SW ID Control Card	0 N/A	All set-ups	FALSE	0	VisStr[20]
15-50	SW ID Power Card	0 N/A	All set-ups	FALSE	0	VisStr[20]
15-51	Frequency Converter Serial Number	0 N/A	All set-ups	FALSE	0	VisStr[10]
15-53	Power Card Serial Number	0 N/A	All set-ups	FALSE	0	VisStr[19]
15-59	CSIV Filename	ExpressionLimit	1 set-up	FALSE	0	VisStr[16]
15-6* Option Ident						
15-60	Option Mounted	0 N/A	All set-ups	FALSE	0	VisStr[30]
15-61	Option SW Version	0 N/A	All set-ups	FALSE	0	VisStr[20]
15-62	Option Ordering No	0 N/A	All set-ups	FALSE	0	VisStr[8]
15-63	Option Serial No	0 N/A	All set-ups	FALSE	0	VisStr[18]
15-70	Option in Slot A	0 N/A	All set-ups	FALSE	0	VisStr[30]
15-71	Slot A Option SW Version	0 N/A	All set-ups	FALSE	0	VisStr[20]
15-72	Option in Slot B	0 N/A	All set-ups	FALSE	0	VisStr[30]
15-73	Slot B Option SW Version	0 N/A	All set-ups	FALSE	0	VisStr[20]
15-74	Option in Slot C0/E0	0 N/A	All set-ups	FALSE	0	VisStr[30]
15-75	Slot C0/E0 Option SW Version	0 N/A	All set-ups	FALSE	0	VisStr[20]
15-76	Option in Slot C1/E1	0 N/A	All set-ups	FALSE	0	VisStr[30]
15-77	Slot C1/E1 Option SW Version	0 N/A	All set-ups	FALSE	0	VisStr[20]
15-8* Operating Data II						
15-80	Fan Running Hours	0 h	All set-ups	TRUE	74	Uint32
15-81	Preset Fan Running Hours	0 h	All set-ups	TRUE	74	Uint32
15-9* Parameter Info						
15-92	Defined Parameters	0 N/A	All set-ups	FALSE	0	Uint16
15-93	Modified Parameters	0 N/A	All set-ups	FALSE	0	Uint16
15-98	Drive Identification	0 N/A	All set-ups	FALSE	0	VisStr[40]
15-99	Parameter Metadata	0 N/A	All set-ups	FALSE	0	Uint16

5.1.16 16-** Data Readouts

Parameter #	Parameter description	Default value	4 set-up	Change during operation	Conversion index	Type
16-0* General Status						
16-00	Control Word	0 N/A	All set-ups	FALSE	0	V2
16-01	Reference [Unit]	0 ReferenceFeed-backUnit	All set-ups	FALSE	-3	Int32
16-02	Reference [%]	0 %	All set-ups	FALSE	-1	Int16
16-03	Status Word	0 N/A	All set-ups	FALSE	0	V2
16-05	Main Actual Value [%]	0 %	All set-ups	FALSE	-2	N2

16-09	Custom Readout	0 CustomReadoutUnit	All set-ups	FALSE	-2	Int32
16-1* Motor Status						
16-10	Power [kW]	0 kW	All set-ups	FALSE	1	Int32
16-11	Power [hp]	0 hp	All set-ups	FALSE	-2	Int32
16-12	Motor Voltage	0 V	All set-ups	FALSE	-1	UInt16
16-13	Frequency	0 Hz	All set-ups	FALSE	-1	UInt16
16-14	Motor current	0 A	All set-ups	FALSE	-2	Int32
16-15	Frequency [%]	0 %	All set-ups	FALSE	-2	N2
16-16	Torque [Nm]	0 Nm	All set-ups	FALSE	-1	Int32
16-17	Speed [RPM]	0 RPM	All set-ups	FALSE	67	Int32
16-18	Motor Thermal	0 %	All set-ups	FALSE	0	UInt8
16-22	Torque [%]	0 %	All set-ups	FALSE	0	Int16
16-26	Power Filtered [kW]	0 kW	All set-ups	FALSE	0	Int32
16-27	Power Filtered [hp]	0 hp	All set-ups	FALSE	-3	Int32
16-3* Drive Status						
16-30	DC Link Voltage	0 V	All set-ups	FALSE	0	UInt16
16-32	Brake Energy /s	0 kW	All set-ups	FALSE	0	UInt32
16-33	Brake Energy /2 min	0 kW	All set-ups	FALSE	0	UInt32
16-34	Heatsink Temp.	0 °C	All set-ups	FALSE	100	UInt8
16-35	Inverter Thermal	0 %	All set-ups	FALSE	0	UInt8
16-36	Inv. Nom. Current	ExpressionLimit	All set-ups	FALSE	-2	UInt32
16-37	Inv. Max. Current	ExpressionLimit	All set-ups	FALSE	-2	UInt32
16-38	SL Controller State	0 N/A	All set-ups	FALSE	0	UInt8
16-39	Control Card Temp.	0 °C	All set-ups	FALSE	100	UInt8
16-40	Logging Buffer Full	[0] No	All set-ups	TRUE	-	UInt8
16-43	Timed Actions Status	[0] Timed Actions Auto	All set-ups	TRUE	-	UInt8
16-49	Current Fault Source	0 N/A	All set-ups	TRUE	0	UInt8
16-5* Ref. & Feedb.						
16-50	External Reference	0 N/A	All set-ups	FALSE	-1	Int16
16-52	Feedback[Unit]	0 ProcessCtrlUnit	All set-ups	FALSE	-3	Int32
16-53	Digi Pot Reference	0 N/A	All set-ups	FALSE	-2	Int16
16-54	Feedback 1 [Unit]	0 ProcessCtrlUnit	All set-ups	FALSE	-3	Int32
16-55	Feedback 2 [Unit]	0 ProcessCtrlUnit	All set-ups	FALSE	-3	Int32
16-56	Feedback 3 [Unit]	0 ProcessCtrlUnit	All set-ups	FALSE	-3	Int32
16-58	PID Output [%]	0 %	All set-ups	TRUE	-1	Int16
16-6* Inputs & Outputs						
16-60	Digital Input	0 N/A	All set-ups	FALSE	0	UInt16
16-61	Terminal 53 Switch Setting	[0] Current	All set-ups	FALSE	-	UInt8
16-62	Analog Input 53	0 N/A	All set-ups	FALSE	-3	Int32
16-63	Terminal 54 Switch Setting	[0] Current	All set-ups	FALSE	-	UInt8
16-64	Analog Input 54	0 N/A	All set-ups	FALSE	-3	Int32
16-65	Analog Output 42 [mA]	0 N/A	All set-ups	FALSE	-3	Int16
16-66	Digital Output [bin]	0 N/A	All set-ups	FALSE	0	Int16
16-67	Pulse Input #29 [Hz]	0 N/A	All set-ups	FALSE	0	Int32
16-68	Pulse Input #33 [Hz]	0 N/A	All set-ups	FALSE	0	Int32
16-69	Pulse Output #27 [Hz]	0 N/A	All set-ups	FALSE	0	Int32
16-70	Pulse Output #29 [Hz]	0 N/A	All set-ups	FALSE	0	Int32
16-71	Relay Output [bin]	0 N/A	All set-ups	FALSE	0	Int16
16-72	Counter A	0 N/A	All set-ups	TRUE	0	Int32
16-73	Counter B	0 N/A	All set-ups	TRUE	0	Int32
16-75	Analog In X30/11	0 N/A	All set-ups	FALSE	-3	Int32
16-76	Analog In X30/12	0 N/A	All set-ups	FALSE	-3	Int32

16-77	Analog Out X30/8 [mA]	0 N/A	All set-ups	FALSE	-3	Int16
16-8* Fieldbus & FC Port						
16-80	Fieldbus CTW 1	0 N/A	All set-ups	FALSE	0	V2
16-82	Fieldbus REF 1	0 N/A	All set-ups	FALSE	0	N2
16-84	Comm. Option STW	0 N/A	All set-ups	FALSE	0	V2
16-85	FC Port CTW 1	0 N/A	All set-ups	FALSE	0	V2
16-86	FC Port REF 1	0 N/A	All set-ups	FALSE	0	N2
16-9* Diagnosis Readouts						
16-90	Alarm Word	0 N/A	All set-ups	FALSE	0	UInt32
16-91	Alarm Word 2	0 N/A	All set-ups	FALSE	0	UInt32
16-92	Warning Word	0 N/A	All set-ups	FALSE	0	UInt32
16-93	Warning Word 2	0 N/A	All set-ups	FALSE	0	UInt32
16-94	Ext. Status Word	0 N/A	All set-ups	FALSE	0	UInt32
16-95	Ext. Status Word 2	0 N/A	All set-ups	FALSE	0	UInt32
16-96	Maintenance Word	0 N/A	All set-ups	FALSE	0	UInt32

5.1.17 18-** Info & Readouts

Parameter #	Parameter description	Default value	4 set-up	Change during operation	Conversion index	Type
18-0* Maintenance Log						
18-00	Maintenance Log: Item	0 N/A	All set-ups	FALSE	0	UInt8
18-01	Maintenance Log: Action	0 N/A	All set-ups	FALSE	0	UInt8
18-02	Maintenance Log: Time	0 s	All set-ups	FALSE	0	UInt32
18-03	Maintenance Log: Date and Time	ExpressionLimit	All set-ups	FALSE	0	TimeOfDay
18-1* Fire Mode Log						
18-10	FireMode Log:Event	0 N/A	All set-ups	FALSE	0	UInt8
18-11	Fire Mode Log: Time	0 s	All set-ups	FALSE	0	UInt32
18-12	Fire Mode Log: Date and Time	ExpressionLimit	All set-ups	FALSE	0	TimeOfDay
18-3* Inputs & Outputs						
18-30	Analog Input X42/1	0 N/A	All set-ups	FALSE	-3	Int32
18-31	Analog Input X42/3	0 N/A	All set-ups	FALSE	-3	Int32
18-32	Analog Input X42/5	0 N/A	All set-ups	FALSE	-3	Int32
18-33	Analog Out X42/7 [V]	0 N/A	All set-ups	FALSE	-3	Int16
18-34	Analog Out X42/9 [V]	0 N/A	All set-ups	FALSE	-3	Int16
18-35	Analog Out X42/11 [V]	0 N/A	All set-ups	FALSE	-3	Int16
18-36	Analog Input X48/2 [mA]	0 N/A	All set-ups	TRUE	-3	Int32
18-37	Temp. Input X48/4	0 N/A	All set-ups	TRUE	0	Int16
18-38	Temp. Input X48/7	0 N/A	All set-ups	TRUE	0	Int16
18-39	Temp. Input X48/10	0 N/A	All set-ups	TRUE	0	Int16
18-5* Ref. & Feedb.						
18-50	Sensorless Readout [unit]	0 SensorlessUnit	All set-ups	FALSE	-3	Int32

5.1.18 20-** FC Closed Loop

Parameter #	Parameter description	Default value	4 set-up	Change during operation	Conversion index	Type
20-0* Feedback						
20-00	Feedback 1 Source	[2] Analog Input 54	All set-ups	TRUE	-	UInt8
20-01	Feedback 1 Conversion	[0] Linear	All set-ups	FALSE	-	UInt8
20-02	Feedback 1 Source Unit	ExpressionLimit	All set-ups	TRUE	-	UInt8
20-03	Feedback 2 Source	[0] No function	All set-ups	TRUE	-	UInt8
20-04	Feedback 2 Conversion	[0] Linear	All set-ups	FALSE	-	UInt8

20-05	Feedback 2 Source Unit	ExpressionLimit	All set-ups	TRUE	-	Uint8
20-06	Feedback 3 Source	[0] No function	All set-ups	TRUE	-	Uint8
20-07	Feedback 3 Conversion	[0] Linear	All set-ups	FALSE	-	Uint8
20-08	Feedback 3 Source Unit	ExpressionLimit	All set-ups	TRUE	-	Uint8
20-12	Reference/Feedback Unit	ExpressionLimit	All set-ups	TRUE	-	Uint8
20-13	Minimum Reference/Feedb.	0 ProcessCtrlUnit	All set-ups	TRUE	-3	Int32
20-14	Maximum Reference/Feedb.	100 ProcessCtrlUnit	All set-ups	TRUE	-3	Int32
20-2* Feedback/Setpoint						
20-20	Feedback Function	[3] Minimum	All set-ups	TRUE	-	Uint8
20-21	Setpoint 1	0 ProcessCtrlUnit	All set-ups	TRUE	-3	Int32
20-22	Setpoint 2	0 ProcessCtrlUnit	All set-ups	TRUE	-3	Int32
20-23	Setpoint 3	0 ProcessCtrlUnit	All set-ups	TRUE	-3	Int32
20-3* Feedb. Adv. Conv.						
20-30	Refrigerant	[0] R22	All set-ups	TRUE	-	Uint8
20-31	User Defined Refrigerant A1	10 N/A	All set-ups	TRUE	-4	Uint32
20-32	User Defined Refrigerant A2	-2250 N/A	All set-ups	TRUE	-2	Int32
20-33	User Defined Refrigerant A3	250 N/A	All set-ups	TRUE	-3	Uint32
20-34	Duct 1 Area [m2]	0.500 m2	All set-ups	TRUE	-3	Uint32
20-35	Duct 1 Area [in2]	750 in2	All set-ups	TRUE	0	Uint32
20-36	Duct 2 Area [m2]	0.500 m2	All set-ups	TRUE	-3	Uint32
20-37	Duct 2 Area [in2]	750 in2	All set-ups	TRUE	0	Uint32
20-38	Air Density Factor [%]	100 %	All set-ups	TRUE	0	Uint32
20-6* Sensorless						
20-60	Sensorless Unit	ExpressionLimit	All set-ups	TRUE	-	Uint8
20-69	Sensorless Information	0 N/A	All set-ups	TRUE	0	VisStr[25]
20-7* PID Autotuning						
20-70	Closed Loop Type	[0] Auto	2 set-ups	TRUE	-	Uint8
20-71	PID Performance	[0] Normal	2 set-ups	TRUE	-	Uint8
20-72	PID Output Change	0.10 N/A	2 set-ups	TRUE	-2	Uint16
20-73	Minimum Feedback Level	-999999 ProcessCtrlUnit	2 set-ups	TRUE	-3	Int32
20-74	Maximum Feedback Level	999999 ProcessCtrlUnit	2 set-ups	TRUE	-3	Int32
20-79	PID Autotuning	[0] Disabled	All set-ups	TRUE	-	Uint8
20-8* PID Basic Settings						
20-81	PID Normal/ Inverse Control	[0] Normal	All set-ups	TRUE	-	Uint8
20-82	PID Start Speed [RPM]	ExpressionLimit	All set-ups	TRUE	67	Uint16
20-83	PID Start Speed [Hz]	ExpressionLimit	All set-ups	TRUE	-1	Uint16
20-84	On Reference Bandwidth	5 %	All set-ups	TRUE	0	Uint8
20-9* PID Controller						
20-91	PID Anti Windup	[1] On	All set-ups	TRUE	-	Uint8
20-93	PID Proportional Gain	0.50 N/A	All set-ups	TRUE	-2	Uint16
20-94	PID Integral Time	20 s	All set-ups	TRUE	-2	Uint32
20-95	PID Differentiation Time	0 s	All set-ups	TRUE	-2	Uint16
20-96	PID Diff. Gain Limit	5 N/A	All set-ups	TRUE	-1	Uint16

5.1.19 21-** Ext. Closed Loop

Parameter #	Parameter description	Default value	4 set-up	Change during operation	Conversion index	Type
21-0* Ext. CL Autotuning						
21-00	Closed Loop Type	[0] Auto	2 set-ups	TRUE	-	Uint8
21-01	PID Performance	[0] Normal	2 set-ups	TRUE	-	Uint8
21-02	PID Output Change	0.10 N/A	2 set-ups	TRUE	-2	Uint16

21-03	Minimum Feedback Level	-999999 N/A	2 set-ups	TRUE	-3	Int32
21-04	Maximum Feedback Level	999999 N/A	2 set-ups	TRUE	-3	Int32
21-09	PID Autotuning	[0] Disabled	All set-ups	TRUE	-	UInt8
21-1* Ext. CL 1 Ref./Fb.						
21-10	Ext. 1 Ref./Feedback Unit	[1] %	All set-ups	TRUE	-	UInt8
21-11	Ext. 1 Minimum Reference	0 ExtPID1Unit	All set-ups	TRUE	-3	Int32
21-12	Ext. 1 Maximum Reference	100 ExtPID1Unit	All set-ups	TRUE	-3	Int32
21-13	Ext. 1 Reference Source	[0] No function	All set-ups	TRUE	-	UInt8
21-14	Ext. 1 Feedback Source	[0] No function	All set-ups	TRUE	-	UInt8
21-15	Ext. 1 Setpoint	0 ExtPID1Unit	All set-ups	TRUE	-3	Int32
21-17	Ext. 1 Reference [Unit]	0 ExtPID1Unit	All set-ups	TRUE	-3	Int32
21-18	Ext. 1 Feedback [Unit]	0 ExtPID1Unit	All set-ups	TRUE	-3	Int32
21-19	Ext. 1 Output [%]	0 %	All set-ups	TRUE	0	Int32
21-2* Ext. CL 1 PID						
21-20	Ext. 1 Normal/Inverse Control	[0] Normal	All set-ups	TRUE	-	UInt8
21-21	Ext. 1 Proportional Gain	0.01 N/A	All set-ups	TRUE	-2	UInt16
21-22	Ext. 1 Integral Time	10000 s	All set-ups	TRUE	-2	UInt32
21-23	Ext. 1 Differentiation Time	0 s	All set-ups	TRUE	-2	UInt16
21-24	Ext. 1 Dif. Gain Limit	5 N/A	All set-ups	TRUE	-1	UInt16
21-3* Ext. CL 2 Ref./Fb.						
21-30	Ext. 2 Ref./Feedback Unit	[1] %	All set-ups	TRUE	-	UInt8
21-31	Ext. 2 Minimum Reference	0 ExtPID2Unit	All set-ups	TRUE	-3	Int32
21-32	Ext. 2 Maximum Reference	100 ExtPID2Unit	All set-ups	TRUE	-3	Int32
21-33	Ext. 2 Reference Source	[0] No function	All set-ups	TRUE	-	UInt8
21-34	Ext. 2 Feedback Source	[0] No function	All set-ups	TRUE	-	UInt8
21-35	Ext. 2 Setpoint	0 ExtPID2Unit	All set-ups	TRUE	-3	Int32
21-37	Ext. 2 Reference [Unit]	0 ExtPID2Unit	All set-ups	TRUE	-3	Int32
21-38	Ext. 2 Feedback [Unit]	0 ExtPID2Unit	All set-ups	TRUE	-3	Int32
21-39	Ext. 2 Output [%]	0 %	All set-ups	TRUE	0	Int32
21-4* Ext. CL 2 PID						
21-40	Ext. 2 Normal/Inverse Control	[0] Normal	All set-ups	TRUE	-	UInt8
21-41	Ext. 2 Proportional Gain	0.01 N/A	All set-ups	TRUE	-2	UInt16
21-42	Ext. 2 Integral Time	10000 s	All set-ups	TRUE	-2	UInt32
21-43	Ext. 2 Differentiation Time	0 s	All set-ups	TRUE	-2	UInt16
21-44	Ext. 2 Dif. Gain Limit	5 N/A	All set-ups	TRUE	-1	UInt16
21-5* Ext. CL 3 Ref./Fb.						
21-50	Ext. 3 Ref./Feedback Unit	[1] %	All set-ups	TRUE	-	UInt8
21-51	Ext. 3 Minimum Reference	0 ExtPID3Unit	All set-ups	TRUE	-3	Int32
21-52	Ext. 3 Maximum Reference	100 ExtPID3Unit	All set-ups	TRUE	-3	Int32
21-53	Ext. 3 Reference Source	[0] No function	All set-ups	TRUE	-	UInt8
21-54	Ext. 3 Feedback Source	[0] No function	All set-ups	TRUE	-	UInt8
21-55	Ext. 3 Setpoint	0 ExtPID3Unit	All set-ups	TRUE	-3	Int32
21-57	Ext. 3 Reference [Unit]	0 ExtPID3Unit	All set-ups	TRUE	-3	Int32
21-58	Ext. 3 Feedback [Unit]	0 ExtPID3Unit	All set-ups	TRUE	-3	Int32
21-59	Ext. 3 Output [%]	0 %	All set-ups	TRUE	0	Int32
21-6* Ext. CL 3 PID						
21-60	Ext. 3 Normal/Inverse Control	[0] Normal	All set-ups	TRUE	-	UInt8
21-61	Ext. 3 Proportional Gain	0.01 N/A	All set-ups	TRUE	-2	UInt16
21-62	Ext. 3 Integral Time	10000 s	All set-ups	TRUE	-2	UInt32
21-63	Ext. 3 Differentiation Time	0 s	All set-ups	TRUE	-2	UInt16
21-64	Ext. 3 Dif. Gain Limit	5 N/A	All set-ups	TRUE	-1	UInt16

5.1.20 22-** Application Functions

Parameter #	Parameter description	Default value	4 set-up	Change during operation	Conversion index	Type
22-0* Miscellaneous						
22-00	External Interlock Delay	0 s	All set-ups	TRUE	0	Uint16
22-01	Power Filter Time	0.50 s	2 set-ups	TRUE	-2	Uint16
22-2* No-Flow Detection						
22-20	Low Power Auto Set-up	[0] Off	All set-ups	FALSE	-	Uint8
22-21	Low Power Detection	[0] Disabled	All set-ups	TRUE	-	Uint8
22-22	Low Speed Detection	[0] Disabled	All set-ups	TRUE	-	Uint8
22-23	No-Flow Function	[0] Off	All set-ups	TRUE	-	Uint8
22-24	No-Flow Delay	10 s	All set-ups	TRUE	0	Uint16
22-26	Dry Pump Function	[0] Off	All set-ups	TRUE	-	Uint8
22-27	Dry Pump Delay	10 s	All set-ups	TRUE	0	Uint16
22-3* No-Flow Power Tuning						
22-30	No-Flow Power	0 kW	All set-ups	TRUE	1	Uint32
22-31	Power Correction Factor	100 %	All set-ups	TRUE	0	Uint16
22-32	Low Speed [RPM]	ExpressionLimit	All set-ups	TRUE	67	Uint16
22-33	Low Speed [Hz]	ExpressionLimit	All set-ups	TRUE	-1	Uint16
22-34	Low Speed Power [kW]	ExpressionLimit	All set-ups	TRUE	1	Uint32
22-35	Low Speed Power [HP]	ExpressionLimit	All set-ups	TRUE	-2	Uint32
22-36	High Speed [RPM]	ExpressionLimit	All set-ups	TRUE	67	Uint16
22-37	High Speed [Hz]	ExpressionLimit	All set-ups	TRUE	-1	Uint16
22-38	High Speed Power [kW]	ExpressionLimit	All set-ups	TRUE	1	Uint32
22-39	High Speed Power [HP]	ExpressionLimit	All set-ups	TRUE	-2	Uint32
22-4* Sleep Mode						
22-40	Minimum Run Time	10 s	All set-ups	TRUE	0	Uint16
22-41	Minimum Sleep Time	10 s	All set-ups	TRUE	0	Uint16
22-42	Wake-up Speed [RPM]	ExpressionLimit	All set-ups	TRUE	67	Uint16
22-43	Wake-up Speed [Hz]	ExpressionLimit	All set-ups	TRUE	-1	Uint16
22-44	Wake-up Ref./FB Difference	10 %	All set-ups	TRUE	0	Int8
22-45	Setpoint Boost	0 %	All set-ups	TRUE	0	Int8
22-46	Maximum Boost Time	60 s	All set-ups	TRUE	0	Uint16
22-5* End of Curve						
22-50	End of Curve Function	[0] Off	All set-ups	TRUE	-	Uint8
22-51	End of Curve Delay	10 s	All set-ups	TRUE	0	Uint16
22-6* Broken Belt Detection						
22-60	Broken Belt Function	[0] Off	All set-ups	TRUE	-	Uint8
22-61	Broken Belt Torque	10 %	All set-ups	TRUE	0	Uint8
22-62	Broken Belt Delay	10 s	All set-ups	TRUE	0	Uint16
22-7* Short Cycle Protection						
22-75	Short Cycle Protection	[0] Disabled	All set-ups	TRUE	-	Uint8
22-76	Interval between Starts	start_to_start_min_on_time (P2277)	All set-ups	TRUE	0	Uint16
22-77	Minimum Run Time	0 s	All set-ups	TRUE	0	Uint16
22-8* Flow Compensation						
22-80	Flow Compensation	[0] Disabled	All set-ups	TRUE	-	Uint8
22-81	Square-linear Curve Approximation	100 %	All set-ups	TRUE	0	Uint8
22-82	Work Point Calculation	[0] Disabled	All set-ups	TRUE	-	Uint8
22-83	Speed at No-Flow [RPM]	ExpressionLimit	All set-ups	TRUE	67	Uint16
22-84	Speed at No-Flow [Hz]	ExpressionLimit	All set-ups	TRUE	-1	Uint16
22-85	Speed at Design Point [RPM]	ExpressionLimit	All set-ups	TRUE	67	Uint16
22-86	Speed at Design Point [Hz]	ExpressionLimit	All set-ups	TRUE	-1	Uint16

22-87	Pressure at No-Flow Speed	0 N/A	All set-ups	TRUE	-3	Int32
22-88	Pressure at Rated Speed	999999.999 N/A	All set-ups	TRUE	-3	Int32
22-89	Flow at Design Point	0 N/A	All set-ups	TRUE	-3	Int32
22-90	Flow at Rated Speed	0 N/A	All set-ups	TRUE	-3	Int32

5.1.21 23-** Time Based Functions

Parameter #	Parameter description	Default value	4 set-up	Change during operation	Conversion index	Type
23-0* Timed Actions						
23-00	ON Time	ExpressionLimit	2 set-ups	TRUE	0	TimeOfDay-WoDate
23-01	ON Action	[0] Disabled	2 set-ups	TRUE	-	UInt8
23-02	OFF Time	ExpressionLimit	2 set-ups	TRUE	0	TimeOfDay-WoDate
23-03	OFF Action	[1] No action	2 set-ups	TRUE	-	UInt8
23-04	Occurrence	[0] All days	2 set-ups	TRUE	-	UInt8
23-0* Timed Actions Settings						
23-08	Timed Actions Mode	[0] Timed Actions Auto	2 set-ups	TRUE	-	UInt8
23-09	Timed Actions Reactivation	[1] Enabled	2 set-ups	TRUE	-	UInt8
23-1* Maintenance						
23-10	Maintenance Item	[1] Motor bearings	1 set-up	TRUE	-	UInt8
23-11	Maintenance Action	[1] Lubricate	1 set-up	TRUE	-	UInt8
23-12	Maintenance Time Base	[0] Disabled	1 set-up	TRUE	-	UInt8
23-13	Maintenance Time Interval	1 h	1 set-up	TRUE	74	UInt32
23-14	Maintenance Date and Time	ExpressionLimit	1 set-up	TRUE	0	TimeOfDay
23-1* Maintenance Reset						
23-15	Reset Maintenance Word	[0] Do not reset	All set-ups	TRUE	-	UInt8
23-16	Maintenance Text	0 N/A	1 set-up	TRUE	0	VisStr[20]
23-5* Energy Log						
23-50	Energy Log Resolution	[5] Last 24 Hours	2 set-ups	TRUE	-	UInt8
23-51	Period Start	ExpressionLimit	2 set-ups	TRUE	0	TimeOfDay
23-53	Energy Log	0 N/A	All set-ups	TRUE	0	UInt32
23-54	Reset Energy Log	[0] Do not reset	All set-ups	TRUE	-	UInt8
23-6* Trending						
23-60	Trend Variable	[0] Power [kW]	2 set-ups	TRUE	-	UInt8
23-61	Continuous Bin Data	0 N/A	All set-ups	TRUE	0	UInt32
23-62	Timed Bin Data	0 N/A	All set-ups	TRUE	0	UInt32
23-63	Timed Period Start	ExpressionLimit	2 set-ups	TRUE	0	TimeOfDay
23-64	Timed Period Stop	ExpressionLimit	2 set-ups	TRUE	0	TimeOfDay
23-65	Minimum Bin Value	ExpressionLimit	2 set-ups	TRUE	0	UInt8
23-66	Reset Continuous Bin Data	[0] Do not reset	All set-ups	TRUE	-	UInt8
23-67	Reset Timed Bin Data	[0] Do not reset	All set-ups	TRUE	-	UInt8
23-8* Payback Counter						
23-80	Power Reference Factor	100 %	2 set-ups	TRUE	0	UInt8
23-81	Energy Cost	1 N/A	2 set-ups	TRUE	-2	UInt32
23-82	Investment	0 N/A	2 set-ups	TRUE	0	UInt32
23-83	Energy Savings	0 kWh	All set-ups	TRUE	75	Int32
23-84	Cost Savings	0 N/A	All set-ups	TRUE	0	Int32

5.1.22 24-** Application Functions 2

Parameter #	Parameter description	Default value	4 set-up	Change during operation	Conversion index	Type
24-0* Fire Mode						
24-00	Fire Mode Function	[0] Disabled	2 set-ups	TRUE	-	Uint8
24-01	Fire Mode Configuration	[0] Open Loop	All set-ups	TRUE	-	Uint8
24-02	Fire Mode Unit	ExpressionLimit	All set-ups	TRUE	-	Uint8
24-03	Fire Mode Min Reference	ExpressionLimit	All set-ups	TRUE	-3	Int32
24-04	Fire Mode Max Reference	ExpressionLimit	All set-ups	TRUE	-3	Int32
24-05	Fire Mode Preset Reference	0 %	All set-ups	TRUE	-2	Int16
24-06	Fire Mode Reference Source	[0] No function	All set-ups	TRUE	-	Uint8
24-07	Fire Mode Feedback Source	[0] No function	All set-ups	TRUE	-	Uint8
24-09	Fire Mode Alarm Handling	[1] Trip, Critical Alarms	2 set-ups	FALSE	-	Uint8
24-1* Drive Bypass						
24-10	Drive Bypass Function	[0] Disabled	2 set-ups	TRUE	-	Uint8
24-11	Drive Bypass Delay Time	0 s	2 set-ups	TRUE	0	Uint16
24-9* Multi-Motor Funct.						
24-90	Missing Motor Function	[0] Off	All set-ups	TRUE	-	Uint8
24-91	Missing Motor Coefficient 1	0 N/A	All set-ups	TRUE	-4	Int32
24-92	Missing Motor Coefficient 2	0 N/A	All set-ups	TRUE	-4	Int32
24-93	Missing Motor Coefficient 3	0 N/A	All set-ups	TRUE	-4	Int32
24-94	Missing Motor Coefficient 4	0 N/A	All set-ups	TRUE	-3	Int32
24-95	Locked Rotor Function	[0] Off	All set-ups	TRUE	-	Uint8
24-96	Locked Rotor Coefficient 1	0 N/A	All set-ups	TRUE	-4	Int32
24-97	Locked Rotor Coefficient 2	0 N/A	All set-ups	TRUE	-4	Int32
24-98	Locked Rotor Coefficient 3	0 N/A	All set-ups	TRUE	-4	Int32
24-99	Locked Rotor Coefficient 4	0 N/A	All set-ups	TRUE	-3	Int32

5.1.23 25-** Cascade Pack Controller

Parameter #	Parameter description	Default value	4 set-up	Change during operation	Conversion index	Type
25-0* System Settings						
25-00	Cascade Controller	[0] Disabled	2 set-ups	FALSE	-	Uint8
25-02	Motor Start	[0] Direct on Line	2 set-ups	FALSE	-	Uint8
25-04	Pump Cycling	[0] Disabled	All set-ups	TRUE	-	Uint8
25-05	Fixed Lead Pump	[1] Yes	2 set-ups	FALSE	-	Uint8
25-06	Number of Pumps	2 N/A	2 set-ups	FALSE	0	Uint8
25-2* Bandwidth Settings						
25-20	Staging Bandwidth	10 %	All set-ups	TRUE	0	Uint8
25-21	Override Bandwidth	100 %	All set-ups	TRUE	0	Uint8
25-22	Fixed Speed Bandwidth	casco_staging_bandwidth (P2520)	All set-ups	TRUE	0	Uint8
25-23	SBW Staging Delay	15 s	All set-ups	TRUE	0	Uint16
25-24	SBW Destaging Delay	15 s	All set-ups	TRUE	0	Uint16
25-25	OBW Time	10 s	All set-ups	TRUE	0	Uint16
25-26	Destage At No-Flow	[0] Disabled	All set-ups	TRUE	-	Uint8
25-27	Stage Function	[1] Enabled	All set-ups	TRUE	-	Uint8
25-28	Stage Function Time	15 s	All set-ups	TRUE	0	Uint16
25-29	Destage Function	[1] Enabled	All set-ups	TRUE	-	Uint8
25-30	Destage Function Time	15 s	All set-ups	TRUE	0	Uint16
25-4* Staging Settings						

25-40	Ramp Down Delay	10 s	All set-ups	TRUE	-1	Uint16
25-41	Ramp Up Delay	2 s	All set-ups	TRUE	-1	Uint16
25-42	Staging Threshold	ExpressionLimit	All set-ups	TRUE	0	Uint8
25-43	Destaging Threshold	ExpressionLimit	All set-ups	TRUE	0	Uint8
25-44	Staging Speed [RPM]	0 RPM	All set-ups	TRUE	67	Uint16
25-45	Staging Speed [Hz]	0 Hz	All set-ups	TRUE	-1	Uint16
25-46	Destaging Speed [RPM]	0 RPM	All set-ups	TRUE	67	Uint16
25-47	Destaging Speed [Hz]	0 Hz	All set-ups	TRUE	-1	Uint16
25-5* Alternation Settings						
25-50	Lead Pump Alternation	[0] Off	All set-ups	TRUE	-	Uint8
25-51	Alternation Event	[0] External	All set-ups	TRUE	-	Uint8
25-52	Alternation Time Interval	24 h	All set-ups	TRUE	74	Uint16
25-53	Alternation Timer Value	0 N/A	All set-ups	TRUE	0	VisStr[7]
25-54	Alternation Predefined Time	ExpressionLimit	All set-ups	TRUE	0	TimeOfDay-WoDate
25-55	Alternate if Load < 50%	[1] Enabled	All set-ups	TRUE	-	Uint8
25-56	Staging Mode at Alternation	[0] Slow	All set-ups	TRUE	-	Uint8
25-58	Run Next Pump Delay	0.1 s	All set-ups	TRUE	-1	Uint16
25-59	Run on Mains Delay	0.5 s	All set-ups	TRUE	-1	Uint16
25-8* Status						
25-80	Cascade Status	0 N/A	All set-ups	TRUE	0	VisStr[25]
25-81	Pump Status	0 N/A	All set-ups	TRUE	0	VisStr[25]
25-82	Lead Pump	0 N/A	All set-ups	TRUE	0	Uint8
25-83	Relay Status	0 N/A	All set-ups	TRUE	0	VisStr[4]
25-84	Pump ON Time	0 h	All set-ups	TRUE	74	Uint32
25-85	Relay ON Time	0 h	All set-ups	TRUE	74	Uint32
25-86	Reset Relay Counters	[0] Do not reset	All set-ups	TRUE	-	Uint8
25-9* Service						
25-90	Pump Interlock	[0] Off	All set-ups	TRUE	-	Uint8
25-91	Manual Alternation	0 N/A	All set-ups	TRUE	0	Uint8

5.1.24 26-** Analog I / O Option MCB 109

Parameter #	Parameter description	Default value	4 set-up	Change during operation	Conversion index	Type
26-0* Analog I/O Mode						
26-00	Terminal X42/1 Mode	[1] Voltage	All set-ups	TRUE	-	Uint8
26-01	Terminal X42/3 Mode	[1] Voltage	All set-ups	TRUE	-	Uint8
26-02	Terminal X42/5 Mode	[1] Voltage	All set-ups	TRUE	-	Uint8
26-1* Analog Input X42/1						
26-10	Terminal X42/1 Low Voltage	0.07 V	All set-ups	TRUE	-2	Int16
26-11	Terminal X42/1 High Voltage	10 V	All set-ups	TRUE	-2	Int16
26-14	Term. X42/1 Low Ref./Feedb. Value	0 N/A	All set-ups	TRUE	-3	Int32
26-15	Term. X42/1 High Ref./Feedb. Value	100 N/A	All set-ups	TRUE	-3	Int32
26-16	Term. X42/1 Filter Time Constant	0.001 s	All set-ups	TRUE	-3	Uint16
26-17	Term. X42/1 Live Zero	[1] Enabled	All set-ups	TRUE	-	Uint8
26-2* Analog Input X42/3						
26-20	Terminal X42/3 Low Voltage	0.07 V	All set-ups	TRUE	-2	Int16
26-21	Terminal X42/3 High Voltage	10 V	All set-ups	TRUE	-2	Int16
26-24	Term. X42/3 Low Ref./Feedb. Value	0 N/A	All set-ups	TRUE	-3	Int32
26-25	Term. X42/3 High Ref./Feedb. Value	100 N/A	All set-ups	TRUE	-3	Int32
26-26	Term. X42/3 Filter Time Constant	0.001 s	All set-ups	TRUE	-3	Uint16
26-27	Term. X42/3 Live Zero	[1] Enabled	All set-ups	TRUE	-	Uint8
26-3* Analog Input X42/5						

26-30	Terminal X42/5 Low Voltage	0.07 V	All set-ups	TRUE	-2	Int16
26-31	Terminal X42/5 High Voltage	10 V	All set-ups	TRUE	-2	Int16
26-34	Term. X42/5 Low Ref./Feedb. Value	0 N/A	All set-ups	TRUE	-3	Int32
26-35	Term. X42/5 High Ref./Feedb. Value	100 N/A	All set-ups	TRUE	-3	Int32
26-36	Term. X42/5 Filter Time Constant	0.001 s	All set-ups	TRUE	-3	UInt16
26-37	Term. X42/5 Live Zero	[1] Enabled	All set-ups	TRUE	-	UInt8
26-4* Analog Out X42/7						
26-40	Terminal X42/7 Output	[0] No operation	All set-ups	TRUE	-	UInt8
26-41	Terminal X42/7 Min. Scale	0 %	All set-ups	TRUE	-2	Int16
26-42	Terminal X42/7 Max. Scale	100 %	All set-ups	TRUE	-2	Int16
26-43	Terminal X42/7 Bus Control	0 %	All set-ups	TRUE	-2	N2
26-44	Terminal X42/7 Timeout Preset	0 %	1 set-up	TRUE	-2	UInt16
26-5* Analog Out X42/9						
26-50	Terminal X42/9 Output	[0] No operation	All set-ups	TRUE	-	UInt8
26-51	Terminal X42/9 Min. Scale	0 %	All set-ups	TRUE	-2	Int16
26-52	Terminal X42/9 Max. Scale	100 %	All set-ups	TRUE	-2	Int16
26-53	Terminal X42/9 Bus Control	0 %	All set-ups	TRUE	-2	N2
26-54	Terminal X42/9 Timeout Preset	0 %	1 set-up	TRUE	-2	UInt16
26-6* Analog Out X42/11						
26-60	Terminal X42/11 Output	[0] No operation	All set-ups	TRUE	-	UInt8
26-61	Terminal X42/11 Min. Scale	0 %	All set-ups	TRUE	-2	Int16
26-62	Terminal X42/11 Max. Scale	100 %	All set-ups	TRUE	-2	Int16
26-63	Terminal X42/11 Bus Control	0 %	All set-ups	TRUE	-2	N2
26-64	Terminal X42/11 Timeout Preset	0 %	1 set-up	TRUE	-2	UInt16

5.1.25 30-** Special Features

Parameter #	Parameter description	Default value	4 set-up	Change during operation	Conversion index	Type
30-2* Adv. Start Adjust						
30-22	Locked Rotor Detection	ExpressionLimit	All set-ups	TRUE	-	UInt8
30-23	Locked Rotor Detection Time [s]	ExpressionLimit	All set-ups	TRUE	-2	UInt8

Index

A

Abbreviations..... 4

AEO..... 4
 see also *Automatic energy optimisation*

Alarm..... 209

Alarm log..... 126

Alarm/warning code list..... 211

AMA..... 4, 217, 220
 see also *Automatic motor adaptation*

Analog I/O mode..... 82

Analog input..... 7

Analog input 2..... 83

Analog input 3 MCB 101..... 84

Analog input 4 MCB 101..... 85

Analog input scaling value..... 203

Analog output 2 MCB 101..... 88

Analog signal..... 216

Auto derate..... 122

Auto energy optimisation compressor..... 37

Auto energy optimisation VT..... 37

Automatic energy optimisation..... 4
 see also *AEO*

Automatic motor adaptation..... 4
 see also *AMA*

B

BACnet..... 94

Brake
 control..... 217
 resistor..... 216

Brake energy functions..... 55

Brake power..... 7

Brake resistor
 Brake resistor..... 5

Braking..... 218

Break-away torque..... 6

Broken belt detection..... 168

Bus controlled..... 80

Bus jog..... 95

C

Cascade controller..... 190

Changing parameter data..... 16

Clock settings..... 35

Coast inverse..... 17

Coasting..... 6, 13

Communication option..... 219

Comparator..... 109

Configuration..... 90

Control
 card..... 216
 word time-out..... 218

Conventions..... 5

Cooling..... 51, 52

Copyright, limitation of liability and revision rights..... 4

Current
 limit..... 5
 rating..... 216
 Output current..... 216
 Rated output current..... 5

Current limit control..... 121

D

Data log settings..... 124

Data readout..... 130

DC link..... 216

DC-brake..... 54

Default setting..... 223

Default settings..... 23

DeviceNet..... 102

Diagnosis readouts..... 135

Digital I/O mode..... 69

Drive bypass..... 188

Drive identification..... 127

Drive information..... 124

Drive status..... 131

Dry pump function..... 163

E

Efficiency
 Efficiency..... 5

End of curve..... 167

Energy log..... 178

Energy savings..... 121

ETR..... 4, 131
 see also *Electronic thermal relay*

Extended CL autotuning..... 151

F

FC closed loop..... 139

FC port diagnostics..... 95

Feedback..... 139, 219, 221

Feedback and setpoint..... 142

Fire mode..... 184, 222

Flow compensation..... 169
 Freeze output..... 6
 Function setup..... 18
 Fuse..... 219

G

General settings..... 37, 89
 General status..... 130
 Graphical display..... 10

H

Heat sink..... 219
 Historic log..... 126

I

I/O options..... 80
 Indexed parameters..... 23
 Initialisation..... 23
 Inputs
 Analog input..... 216
 Digital input..... 217
 Input terminal..... 216
 Intermediate circuit..... 216
 Inverter overload, no trip..... 123
 Inverter switching..... 118

J

Jog..... 6

L

Language package..... 25
 LCP..... 5, 6, 7, 16
 see also *Local control panel*
 LCP copy/save..... 34
 LCP custom readout..... 32
 LCP display..... 28
 LED..... 10, 11
 Literature..... 6
 Load dependent settings..... 46
 Local control panel..... 5
 see also *LCP*
 Local reference..... 26, 62
 Logging..... 17
 Logic rule..... 111
 LonWorks..... 105
 Low speed detection..... 162
 Low-power detection..... 162

M

Main menu mode..... 12, 16, 21
 Main menu structure..... 24
 Main reactance..... 42
 Mains On/Off..... 118
 Mains supply..... 8
 Maintenance log..... 137
 Manual initialisation..... 23
 MCB 109..... 200
 Modulation..... 4, 5
 Motor
 current..... 220
 data..... 217, 220
 power..... 220
 Motor data..... 40
 Motor limit..... 65
 Motor overload protection..... 51
 Motor status..... 130
 Motor temperature..... 51

N

NLCP..... 14
 No operation..... 17
 No-flow detection..... 159

O

Operating data..... 124
 Operating mode..... 26
 Other ramps..... 63
 Overheating..... 217
 Overtemperature..... 217

P

Parameter access..... 104
 Parameter data..... 16
 Parameter information..... 128
 Parameter options..... 223
 Parameter selection..... 22
 Parameter set-up..... 16
 Password..... 34
 PELV..... 5
 Phase loss..... 216
 PID autotuning..... 147
 PID basic settings..... 149
 PID controller..... 149
 Programming..... 216

Protection mode..... 9

Q

Quick menu mode..... 12, 16

R

Ramp 2..... 62

Rated motor speed..... 6

RCD..... 5, 8

Reference and feedback..... 132

Relay output..... 73

Reset..... 216, 217, 221

S

Safety precautions..... 8

Serial communication..... 7

Short circuit..... 217

Short cycle protection..... 169

Sleep mode..... 164

Software version..... 4

Speed bypass..... 67

Start adjustments..... 47

Start delay..... 47

Start function..... 47

Stator leakage reactance..... 42

Status..... 12

Status message..... 10

Stop adjustments..... 50

Supply voltage..... 219

Symbols..... 4

Synchronous motor speed..... 6

T

Terminals

Input terminal..... 216

Thermal load..... 45, 131

Thermistor..... 8, 51

Timed actions..... 173

Timer..... 111

Torque

Constant torque..... 4

limit..... 5

Variable torque..... 5

Torque..... 217

Trip at motor speed low limit..... 50

Trip reset..... 119

Troubleshooting..... 209

V

Voltage imbalance..... 216

VVC+..... 5, 8



.....
Danfoss can accept no responsibility for possible errors in catalogues, brochures and other printed material. Danfoss reserves the right to alter its products without notice. This also applies to products already on order provided that such alterations can be made without subsequential changes being necessary in specifications already agreed. All trademarks in this material are property of the respective companies. Danfoss and the Danfoss logotype are trademarks of Danfoss A/S. All rights reserved.
.....

Danfoss A/S
Ulsnaes 1
DK-6300 Graasten
vlt-drives.danfoss.com

