

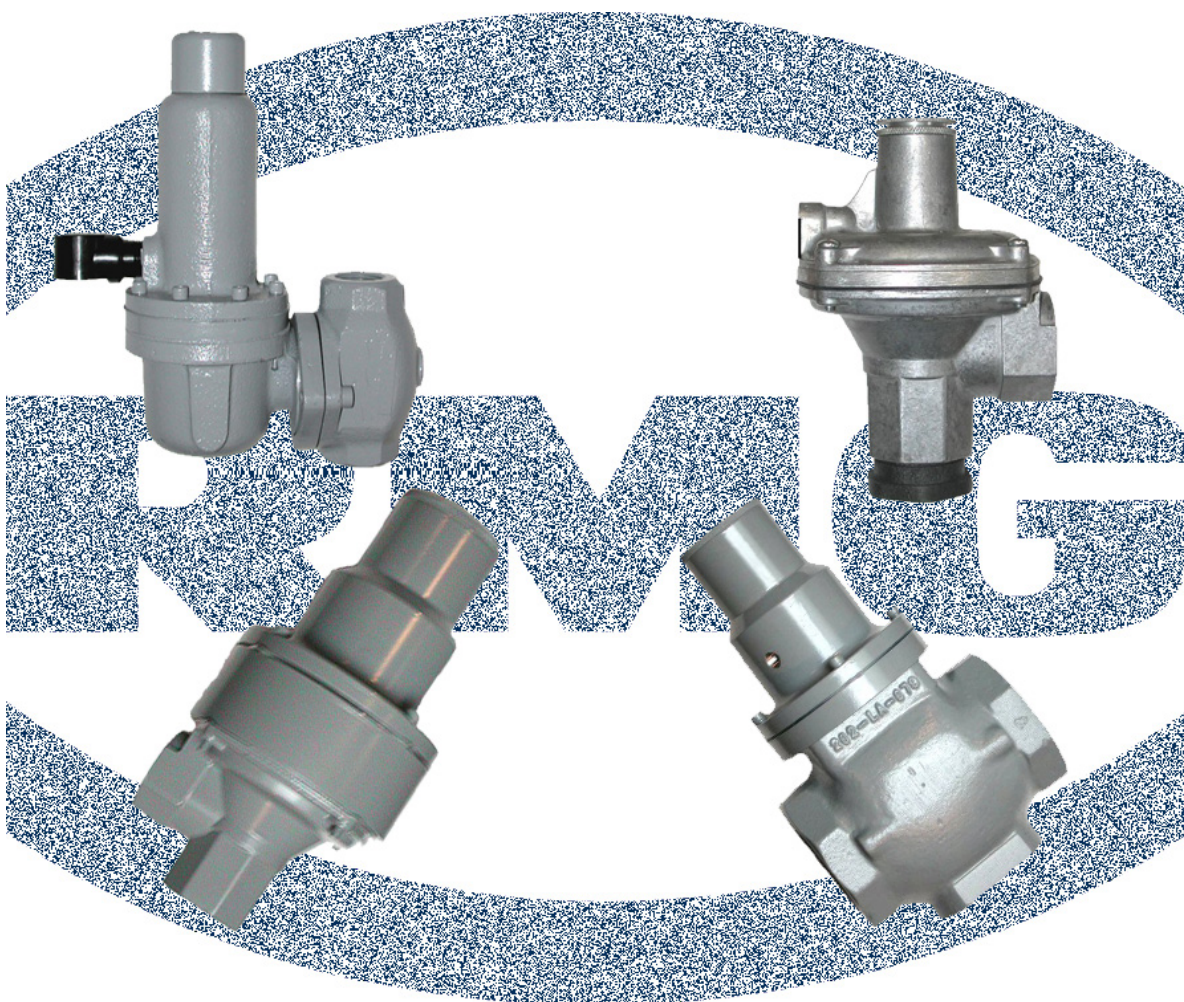

MODEL 201 – 225LP – 225LP2 – 225LP4 Safety Relief Valves

General Description

Edition
GDRV.06



BRYAN DONKIN RMG CANADA LIMITED
Serving the Gas Industry—WORLDWIDE



MODEL 201 – 225LP – 225LP2 – 225LP4 Safety Relief Valves

General Description

Applications

- Specifically designed to protect the downstream system or equipment from over pressure conditions by discharging excess gas pressure through the valve to a safe location
- For natural gas and all non-corrosive gaseous media

Characteristics

- Specifically designed to measure downstream pressure then vent gas if a predetermined pressure limit is reached
- Model 201 Safety Relief Valve is a high pressure version
- Models 225LP, 225LP2 and 225LP4 Safety Relief Valves are low pressure versions
- Maximum operating pressure of the 201 is 375 psig (25.5 bar)
- Maximum operating pressure of the 225LP is 30 psig (2 bar)
- Maximum operating pressure of the 225LP2 is 30 psig (2 bar)
- Maximum operating pressure of the 225LP4 is 150 psig (10 bar)
- Angle body (90°) design with Models 225LP and 225LP2
- Inline body (180°) design with Model 201 and 225LP4
- ¾" & 1" screwed connections NPT, BSPT or BSPP available with 201, 225LP and 225LP2
- 1¼", 1½" & 2" screwed connections NPT, BSPT or BSPP available with Model 225LP4
- 2" flanged version available in ANSI150 or PN16 with flat or raised face profiles
- Ease of maintenance due to interchangeable diaphragm casing cartridge accessible via a union nut to the body
- Custom designed and pre-fabricated regulator assemblies and pressure reducing stations available



MODEL 201 – 225LP – 225LP2 – 225LP4 Safety Relief Valves

General Description

Available Relief Pressure Ranges

201: High pressure safety relief valve

- Relief pressure range 3 – 150 psig (0.21 – 10 bar)

225LP: Low pressure relief valve

- Relief pressure range 12" w.c. – 5 psig (30 – 350 mbar)

225LP2: Low pressure relief valve

- Relief pressure range 5 – 15 psig (0.35 – 1.0 bar)

225LP4: Low pressure relief valve

- Relief pressure range 5 – 75 psig (0.35 – 5.1 bar)

Materials of Construction

Screwed Body (¾" & 1")	Die-Cast Aluminum
Screwed Body (1¼", 1½" & 2")	Cast Iron
Flanged Body	Cast Iron
Diaphragm Casings	Die Cast Aluminum
Diaphragm	Molded Nitrile Rubber with Nylon Reinforcing
Valve Head (Seat) for 225LP2, 225LP4 and 201	Polyurethane
Diaphragm Plates	Steel
Fasteners	Steel
Top Cap (standard)	Aluminum

Weights

- Model 201 (¾" & 1") – 14 lb. (6.4 kg)
- Model 225LP (¾" & 1") – 2 lb. (0.9 kg)
- Model 225LP2 (¾" & 1") – 5 lb. (2.3 kg)
- Model 225LP4 (1¼", 1½" & 2") – 18 lb. (8.2 kg)
- Model 225LP4 (2" flanged) - 25 lb. (11.4 kg)

Temperature Rating

- -40° to 60° Celsius
- -40° to 140° Fahrenheit



MODEL 201 – 225LP – 225LP2 – 225LP4 Safety Relief Valves

General Description

Spring Selection and Cut-Off Ranges

Model 201 Safety Relief Valve

Range (imperial)	Range (metric)	Spring Number/Colour
3 – 10 psig	0.21 – 0.7 bar	1030 (brown)
8 – 20 psig	0.5 – 1.4 bar	1031 (green)
15 – 25 psig	1.0 – 1.7 bar	1032 (blue)
20 – 40 psig	1.4 – 2.7 bar	1033 (silver)
30 – 75 psig	2.0 – 5.1 bar	1036 (red)
50 – 100 psig	3.4 – 6.8 bar	1037 (white)
80 – 150 psig	5.4 – 10 bar	1034 (yellow)

Model 225LP Safety Relief Valve

12” – 40” w.c.	30 – 100 mbar	861 (brown)
27” – 67” w.c.	67 – 167 mbar	868 (green)
2 – 3 psig	140 – 210 mbar	1254 (red)
3 – 4 psig	210 – 280 mbar	1047 (purple)
4 – 5 psig	280 – 350 mbar	1255 (green)

Model 225LP2 Safety Relief Valve

5 – 15 psig	0.35 – 1.0 bar	1030 (brown)
-------------	----------------	--------------

Model 225LP4 Safety Slam-Shut Valve

5 – 30 psig	0.35 – 2.0 bar	1030 (brown)
30 – 45 psig	2.0 – 3.0 bar	1031 (green)
45 – 75 psig	3.0 – 5.1 bar	1032 (dark blue)

MODEL 201 – 225LP – 225LP2 – 225LP4 Safety Relief Valves

General Description

Relief Performance

Model 201 Safety Relief Valve

TYPICAL PERFORMANCE DATA

SPRING		SET POINT	OVER-PRESSURE LEVEL			
NUMBER	COLOUR		10%	20%	50%	100%
1030	BROWN	6 psig	100	1,150	3,500	4,500
		9 psig	150	1,500	4,000	5,000
1031	GREEN	16 psig	1,200	2,300	5,500	8,400
1032	BLUE	20 psig	1,300	2,500	8,900	12,400
1033	SILVER	30 psig	1,500	2,700	9,000	13,800
		40 psig	1,600	4,700	12,200	18,750
1036	RED	50 psig	1,800	4,000	16,500	27,000
		60 psig	2,100	5,800	18,000	30,000
1037	WHITE	75 psig	3,000	6,000	18,000	31,000
1034	YELLOW	100 psig	5,300	15,500	29,750	38,000
		130 psig	4,500	12,000	36,000	45,000

Natural Gas, 0.6 sg at 1.013 barA and 15 C.

1" x 1" body connections.

Free discharge to atmosphere through 5 feet of 1" straight pipe.

Model 225LP Safety Relief Valve

BD-RMG Model 225 - Relief Valve
WORKS PERFORMANCE TEST

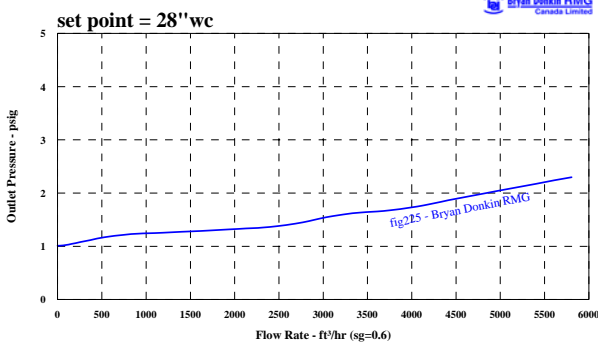

BD-RMG Model 225 - Relief Valve
WORKS PERFORMANCE TEST

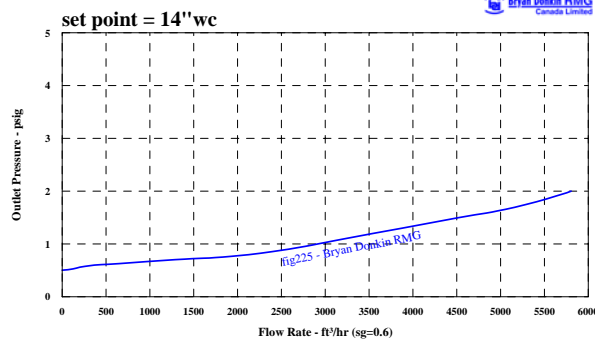

Model 225LP2 Safety Relief Valve

- Relief capacity 6000 ft³/hr (170 m³/hr)

Model 225LP4 Safety Relief Valve

- Relief capacity 24000 ft³/hr (680 m³/hr)

MODEL 201 – 225LP – 225LP2 – 225LP4 Safety Relief Valves

General Description

Sectional Drawings

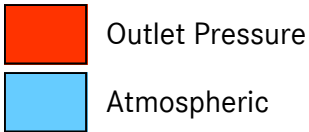

201 (3/4" & 1" body)

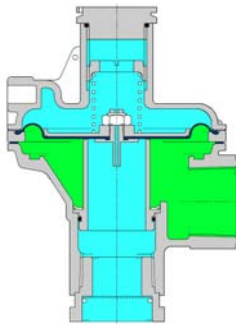
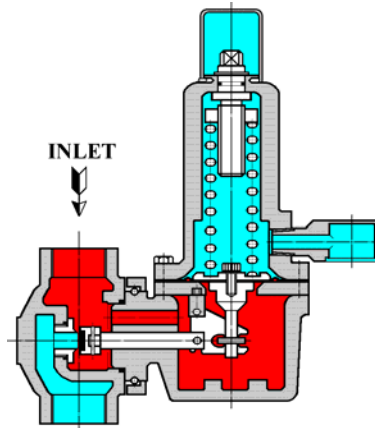

225LP (3/4" & 1" body)

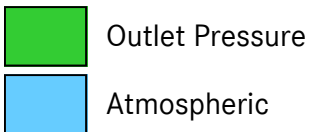

225LP2 (3/4" & 1" body)

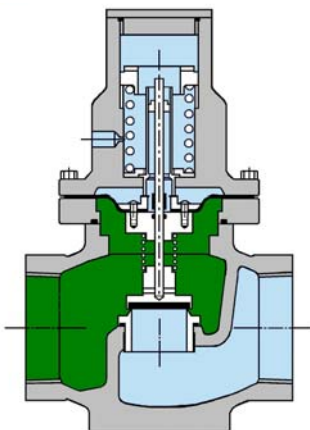
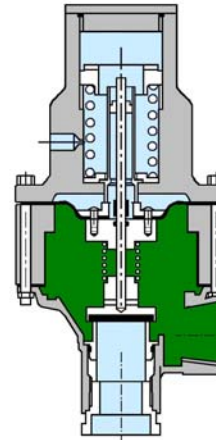

225LP4 (1/4", 1/2" & 2" screwed body)

MODEL 201 – 225LP – 225LP2 – 225LP4 Safety Relief Valves

General Description

Dimensional Drawings

201 ($\frac{3}{4}$ " & 1" body)

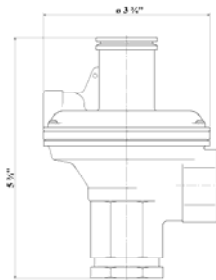
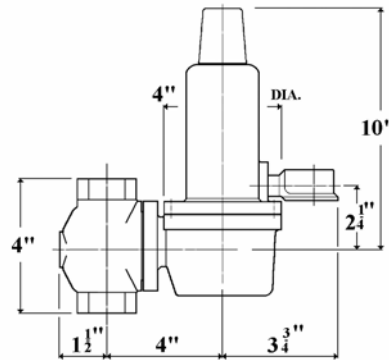

225LP ($\frac{3}{4}$ " & 1" body)

225LP2 ($\frac{3}{4}$ " & 1" body)

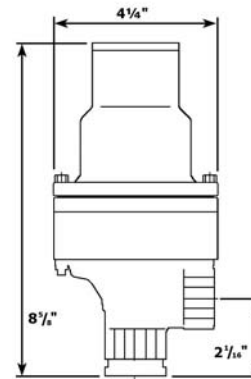

225LP4 ($\frac{1}{4}$ ", $\frac{1}{2}$ " & 2" screwed body)

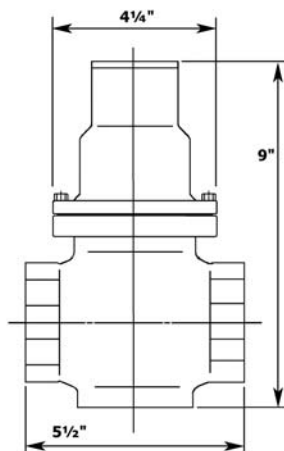



MODEL 201 – 225LP – 225LP2 – 225LP4 Safety Relief Valves

General Description

Commissioning and Installation Instructions

Please contact one of our representatives for the installation and commissioning instructions. Additionally, the commissioning and installation instructions are found in each box that the equipment is shipped in and can be downloaded from the website.

Ordering Information

1. Inlet pressure (minimum and maximum)
2. Relief pressure requirements
3. Flow requirement (minimum and maximum)
4. Type of gas
5. Temperature
6. Pipe connections (inlet and outlet)
7. Pressure regulator options or requirements (SRV and/or SSV)
8. Other critical information (system design or description)
9. Shipping and billing information

Product Portfolio

- Pressure regulators for every application from domestic, commercial, industrial to transmission line, city gate stations and other gas utility applications.
- Safety relief valves
- Safety slam shut valves
- Metering equipment (rotary displacement, turbine, vortex shedding, ultrasonic)
- Volume correctors (temperature and pressure)
- Filters
- Underground pressure regulator and metering modules
- Ball valves
- Station design and assembly (prefabricated stations, skid-mounted assemblies, small regulator/meter-set assemblies)
- Flame arrestors
- Data logging and software
- Check and non-return valves
- Training and after-sales service



MODEL 201 – 225LP – 225LP2 – 225LP4 Safety Relief Valves

General Description

Contact Information



Bryan Donkin RMG Canada Limited
50 Clarke Street South, Woodstock, Ontario, Canada N4S 7Y5
Phone: +1-519-539-8531
Fax: +1-519-537-3339
Email: neil@bdrmgcanada.com
Website: www.rmg.com



RMG Regel + Messtechnik GmbH
Osterholzstrasse 45, D-34123, Kassel, Germany
Phone: +49-561-5007-0
Fax: +49-561-5007-107
Website: www.rmg.com



Bryan Donkin RMG Gas Controls Limited
Enterprise Drive, Holmewood, Chesterfield S42 5UZ England
Phone: +44-1246-501501
Fax: +44-1246-501-500
Website: www.rmg.com

Distributor Information