

TS Series

TS... Protocol Converter

for use with LMV3..., LMV5..., RWF... and TS Series Controls

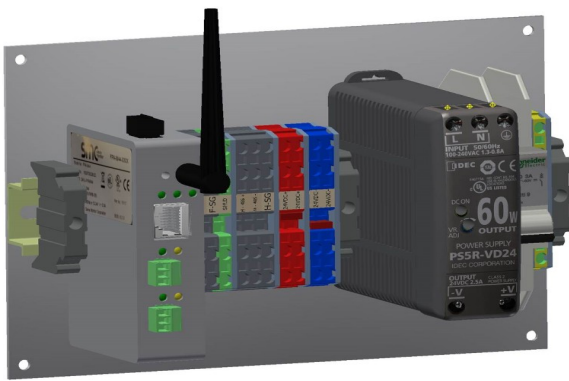

Standard



With Ethernet Switch

Description

TS... series protocol converters provide flexible communication interface options to the building management system (BMS) to provide streamlined data collection and monitoring.

Table of Contents

Certifications.....	5
Compatible Controls and Protocols.....	6
Controls.....	6
Available Ports.....	7
TS-PX4.....	7
TS-PL4.....	7
TS-PX2.....	7
TS-PL2.....	7
TS-PW.....	7
Protocol Selection.....	9
Physical Connections.....	10
TS-PL... and TS-PX.....	11
TS-PW.....	11
DIP Switches.....	12
Diagnostic LEDs.....	13
TS-PL... and TS-PX.....	13
TS-PW.....	14
Web-Based Configuration Utility.....	15
Establishing a Connection.....	15
Changing IP Address (Windows).....	16
Interface.....	19
Changing the Protocol.....	20
Adding a Device.....	20
Adding a TS Series Lead/Lag Master via HOST, FIELD, R1 or R2 Port.....	24
Adding a TS Series Lead/Lag Master via ETHERNET or ETH Port.....	26
Adding Boiler Objects to TS Series Lead/Lag Master.....	27
Adding a TS Series Deaerator/Surge Tank Panel via TS Series Lead/Lag Master.....	28
Adding a TS Series Deaerator/Surge Tank Panel.....	29
Adding a TS Series Touchscreen Kit.....	30
Protocol Configuration Parameters – BACnet/IP.....	31
Protocol Configuration Parameters – BACnet MS/TP.....	32
Protocol Configuration Parameters – Metasys N2.....	33
Protocol Configuration Parameters – Ethernet/IP.....	34
Protocol Configuration Parameters – Modbus/RTU to Modbus TCP/IP.....	35
Protocol Configuration Parameters – Modbus TCP/IP to Modbus/RTU.....	36
Protocol Configuration Parameters – LONWORKS.....	37
Clearing All Profiles From Memory.....	38
Changing Network Settings.....	39
Diagnostics and Debugging.....	40
About.....	40
Setup – Loading Updates.....	41

Setup – WiFi Client.....	42
Setup – WiFi Access Point.....	43
View.....	44
BACnet Additional Information.....	46
BACnet/IP.....	46
BACnet/IP BBMD (BACnet/IP Broadcast Management Device).....	46
BACnet MS/TP.....	46
Metasys N2 Additional Information.....	47
Ethernet/IP Additional Information.....	48
Tested Applications.....	48
Setup Files.....	48
User-Defined Data Types.....	49
Add-On Instructions.....	49
Controller Tags.....	50
Logic.....	52
Setting Up Messaging Instructions.....	53
Testing Operation.....	54
Modbus Additional Information.....	55
LONWORKS Additional Information.....	56
Service Pin.....	56
Uploading XIF File.....	56
BACnet/Metasys N2 – Mapping.....	57
LMV5.....	57
LMV3.....	61
LME7.....	63
RWF10.....	66
RWF55.....	67
TS Series Hardwired Draft Control.....	69
TS Series Deaerator/Surge Tank.....	70
TS Series Touchscreen Kit.....	73
TS Series Lead/Lag Master (Global System Data).....	83
TS Series Lead/Lag Master (Boiler Data).....	86
Ethernet/IP – Mapping.....	90
LMV5.....	90
LMV3.....	94
LME7.....	96
RWF10.....	99
RWF55.....	100
TS Series Hardwired Draft Control.....	102
TS Series Deaerator/Surge Tank.....	103
TS Series Touchscreen Kit.....	106
TS Series Lead/Lag Master (Global System Data).....	116
TS Series Lead/Lag Master (Boiler Data).....	119

LONWORKS – Mapping.....	123
LMV5.....	123
LMV3.....	126
LME7.....	128
RWF10.....	131
RWF55.....	132
TS Series Hardwired Draft Control.....	134
TS Series Deaerator/Surge Tank.....	135
TS Series Touchscreen Kit.....	138
TS Series Lead/Lag Master (Global System Data).....	147
TS Series Lead/Lag Master (Boiler Data).....	150
Modbus – Mapping.....	154
LMV5.....	154
LMV3.....	163
LME7.....	169
RWF10.....	172
RWF55.....	173
TS Series.....	175
Mapping Notes.....	176
TS Series Lead/Lag Master Remote Control Strategies.....	176
Notations.....	176
LMV Phases.....	180
LMV5 Lockout/Error Codes.....	181
LMV3 Error Codes.....	184
LME7 Phases.....	187
LME7 Error Codes.....	188
TS Series Configuration for Modbus.....	189
TS Series Hardwired Draft Control.....	189
TS Series Deaerator/Surge Tank.....	189
TS Series Touchscreen Kit.....	189
Default IP Addresses by Designation.....	189
TS Series Lead/Lag Master.....	189
LMV5 Configuration for Modbus.....	190
LMV3 Configuration for Modbus.....	191
LME7 Configuration for Modbus.....	192
RWF10 Configuration for Modbus.....	193
RWF55 Configuration for Modbus.....	194
Change Log.....	195
Revision 18D1.....	195
Revision 18J1.....	195
Revision 19C1.....	195
Revision 19F1.....	195

Certifications

- **BTL Mark – BACnet Testing Laboratory**



The BTL® Mark is a symbol that indicates that a product has passed a series of rigorous tests conducted by an independent laboratory which verifies that the product correctly implements the BACnet® features claimed in the listing. The mark is a symbol of a high-quality BACnet product. BACnet is a registered trademark of ASHRAE. BTL is a registered trademark of BACnet International.

- **LONMARK Certification**



LONMARK® International is the recognized authority for certification, education, and promotion of interoperability standards for the benefit of manufacturers, integrators and end users using the LONWORKS® platform. LONMARK International has developed extensive product certification standards and tests to provide the integrator and user with confidence that products from multiple manufacturers utilizing LONMARK devices work together. LONMARK and LONWORKS are registered trademarks of Echelon Corporation.

- **ODVA – Ethernet/IP**



ODVA® is an international association of automation companies. ODVA and its members support network technologies based on the Common Industrial Protocol (CIP™) including EtherNet/IP™. ODVA manages the development of these open technologies. ODVA and Ethernet/IP are registered trademarks of ODVA, Inc.

Compatible Controls and Protocols

The TS Series Protocol Converter can connect any combination or quantity of supported controls and convert the data into one of the supported protocols. A web-based configuration utility is used to make configuration changes.

Controls

- LMV5... (via AZL...)
- LMV3... (via OCI412.10 or OCI413.20)
- LME7... (via OCI417.10)
- RWF10 (with Modbus option)
- RWF55
- TS Series Hardwired Draft Control
- TS Series Deaerator/Surge Tank Panel
- TS Series Touchscreen Kit
- TS Series Lead/Lag Master

Protocols

- BACnet/IP
- BACnet MS/TP
- Modbus TCP/IP
- Metasys N2
- Ethernet/IP
- LONWORKS

Available Ports

TS-PX4

This model has the following ports:

- **HOST** port (RS-485)
- **FIELD** port (RS-485)
- **ETHERNET** port

TS-PL4

This model has the following ports:

- **HOST** port (RS-485)
- **FIELD** port (LONWORKS FTT-10A)
- **ETHERNET** port

TS-PX2

This model has the following ports:

- **HOST** port (RS-232)
- **FIELD** port (RS-485)
- **ETHERNET** port

TS-PL2

This model has the following ports:

- **HOST** port (RS-232)
- **FIELD** port (LONWORKS FTT-10A)
- **ETHERNET** port

TS-PW

This model has the following ports:

- **R1** port (RS-485 or RS-232, selected by DIP switch)
- **R2** port (RS-485)
- **ETH** port



TS-PL... and TS-PX... Models



TS-PW Model

Available Ports (continued)

Serial devices (LMV... and RWF...) normally connect to the HOST or R1 port. They can also connect to the FIELD or R2 port when the selected protocol uses the ETHERNET or ETH port. Ethernet devices (TS Series) can connect to the ETHERNET or ETH port regardless of which protocol is selected.

Each model comes wired as a kit with a circuit breaker, DC power supply and optional Ethernet switch. Models TS-PX2 and TS-PL2 also come with a wired cable from the HOST RS-232 port to connect directly to the AZL.... Model TS-PW will come with a wired cable from the R1 port (configured for RS-232 by DIP switch) to connect directly to the AZL... if specified as an option. If the TS-P... is ordered as part of a TS Series Lead/Lag Master, TS Series Deaerator/Surge Tank Master or TS Series Touchscreen Kit, it will come installed as part of that assembly.

Protocol Selection

Models TS-PX4, TS-PX2 and TS-PW can be configured for any of the following protocols:

- BACnet/IP
- BACnet MS/TP
- Modbus/RTU to Modbus TCP/IP
- Modbus TCP/IP to Modbus/RTU
- Metasys N2
- Ethernet/IP

Models TS-PL4 and TS-PL2 are configured for LONWORKS and cannot be changed.

Physical Connections

The protocol converter communicates with the connected equipment via Modbus. Multiple different devices can connect to the protocol converter. Connect any RS-485 devices in a daisy-chain with termination at the end of the chain (typically a 120-Ohm resistor).

Device Communication Protocols and Physical Mediums

Device	Protocol	Physical Medium
LMV5... (via AZL...)	Modbus/RTU	RS-232
LMV3... (via OCI412.10 or OCI413.20)	Modbus/RTU	RS-485
LME7... (via OCI417.10)	Modbus/RTU	RS-485
RWF10 (with Modbus)	Modbus/RTU	RS-485
RWF55	Modbus/RTU	RS-485
TS Series Hardwired Draft Control	Modbus/RTU	RS-485
TS Series Deaerator/Surge Tank Master	Modbus TCP/IP	Ethernet
TS Series Touchscreen Kit	Modbus TCP/IP	Ethernet
TS Series Lead/Lag Master	Modbus/RTU	RS-485

Each connected device must have a unique Modbus address assigned between 1 and 255. All serial devices connected must have matching baud rates, data bits, stop bits and parity settings.

Physical Connections (continued)

TS-PL... and TS-PX...

The protocol converter has three ports, labeled HOST, FIELD and ETHERNET. The physical medium of the HOST and FIELD port depends upon the model of the device.

HOST port



ETHERNET port



FIELD Port (TS-PX4, TS-PX2)

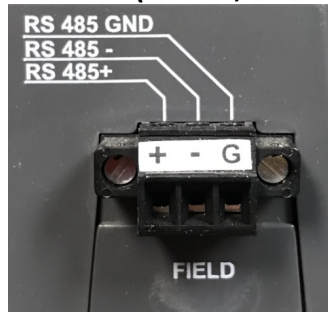

FIELD Port (TS-PL4, TS-PL2)



TS-PW...

The protocol converter has three ports, labeled R1, R2 and ETH. The physical medium of port R1 depends the position of the DIP switch. The physical medium of port R2 is always RS-485.

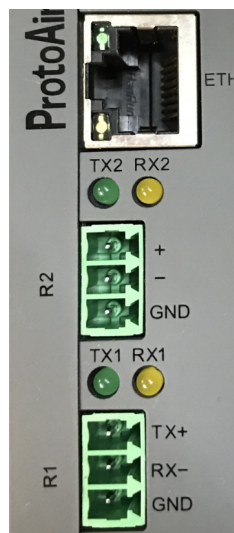

DIP Switches

Model TS-PW has DIP switches for each serial port to add termination, biasing as well as changing the physical connection for port R1 from RS-485 to RS-232.

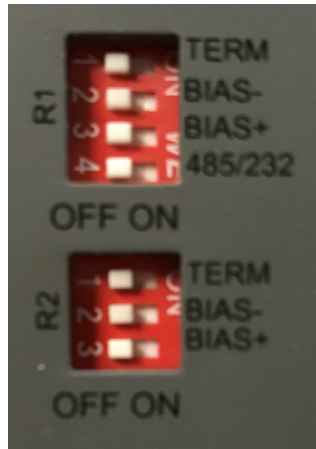

- **TERM:** Applies 120-ohm termination between the RS-485+ and RS-485- connections. This is typically used when the protocol converter is the device at the end of the serial connection (daisy-chain).
- **BIAS+/BIAS-:** Pulls the RS-485+ and RS-485- lines high and low with 510-ohm resistors. Biasing is typically not needed but if used should only be enabled on one device on the network.
- **485/232:** Switches port R1 from RS-485 to RS-232 for connection to serial devices.

Diagnostic LEDs

TS-PL... and TS-PX...

The protocol converter has six LEDs that indicate the current status.

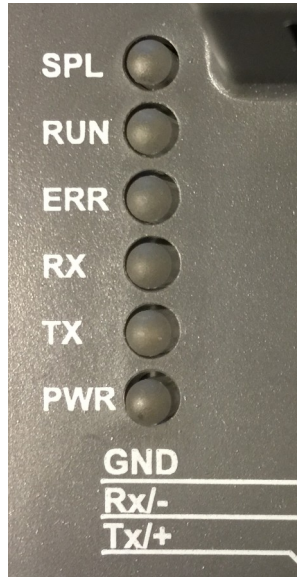

- **SPL:** Indicates that the protocol converter is offline (not programmed).
- **RUN:** Begins flashing 20 seconds after power to indicate normal operation.
- **ERR:** Indicates that there is a system error present. Use the web-based configuration utility to determine the source of the error.
- **RX:** Indicates that a message has been received on the HOST port.
- **TX:** Indicates that a message has been sent on the HOST port.
- **PWR:** Indicates that the device is powered on.

During normal communication with a serial device, the **TX** and **RX** LEDs will flash in alternation to indicate that communication is active.

Removing the cover of the protocol converter exposes the **TX** and **RX** LEDs for the FIELD port. This could be helpful in troubleshooting a bad connection.

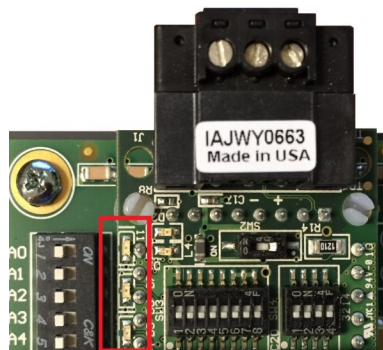

Diagnostic LEDs (continued)

TS-PW

The protocol converter has three LEDs that indicate the current status.



- **SS:** Begins flashing 20 seconds after power to indicate normal operation.
- **ERR:** Indicates that there is a system error present. Use the web-based configuration utility to determine the source of the error.
- **PWR:** Indicates that the device is powered on.

During normal communication with a serial device, the **TX1** and **RX1** (port R1) or the **TX2** and **RX2** (port R2) LEDs will flash in alternation to indicate that communication is active.

Web-Based Configuration Utility

The protocol converter is configured using a web-based configuration utility. This requires that a device with a web browser is connected to the same network as the protocol converter and can communicate with it. The protocol converter is shipped without a configuration since each configuration requires site-specific information.

Establishing a Connection

Connect the web-enabled device to the protocol converter using a standard Ethernet cable. The web-enabled device has to have an IP address compatible with the protocol converter. This may require that a static IP address is entered into the web-enabled device. Choose a static IP address with a different last byte (such as 10.100.0.99) than the protocol converter. Make the subnet mask and the default gateway the same as the protocol converter.

The default network settings for the protocol converter are:

- **IP Address:** 10.100.0.4
- **Subnet Mask:** 255.255.255.0
- **Default Gateway:** 10.100.0.1

Model TS-PW also allows a wireless connection. Enable DHCP to set a compatible IP address automatically. The default network settings for the wireless connection are:

- **SSID (Network Name):** SCC Inc. Protocol Converter
- **Password:** start9876
- **IP Address:** 192.168.50.1
- **Subnet Mask:** 255.255.255.0

If the IP address has been changed from the default, it will be necessary to keep the new address noted since it will be needed to establish communication in the future.

Web-Based Configuration Utility (continued)

Changing IP Address (Windows)

1. (Windows 7) Click the Windows logo to open the start menu, then type 'cmd.exe' in the *Search files and folders* text box and then press **Enter**.

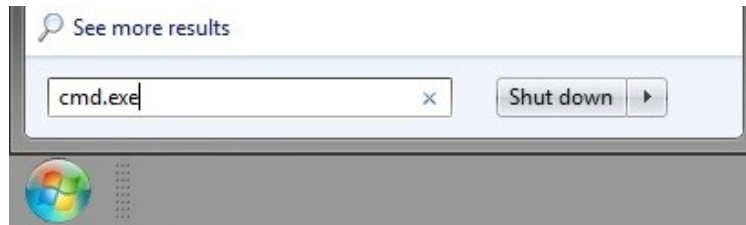

2. (Windows 10) Right-click the Windows logo to open the start menu and click 'Run'. Type 'cmd.exe' in the text box and then press **Enter**.

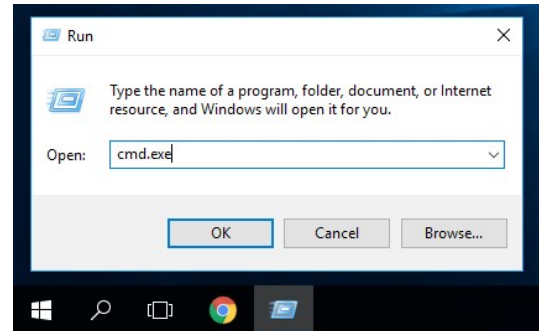
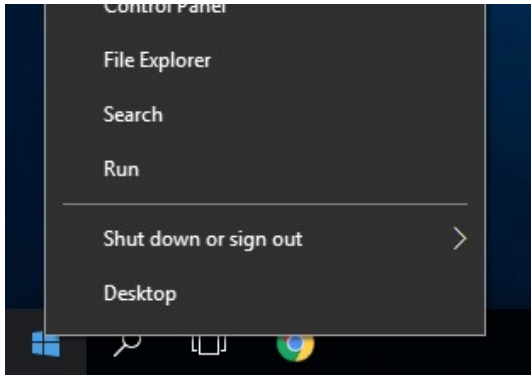

3. Type 'control ncpa.cpl' after the `C:\...>` prompt and then press **Enter**.

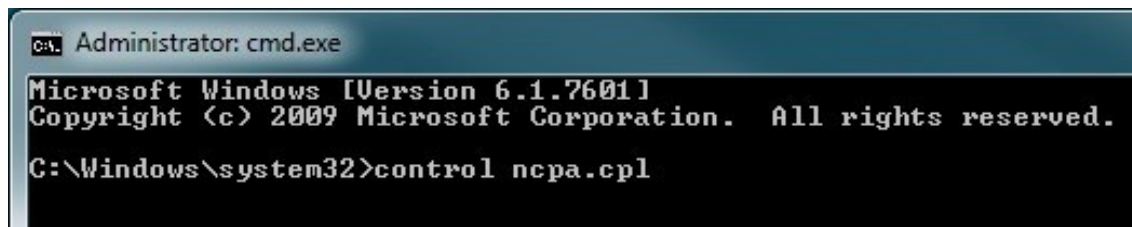

Web-Based Configuration Utility (continued)

4. Right-click on the network adapter that is connected to the protocol converter and then click **Properties**.

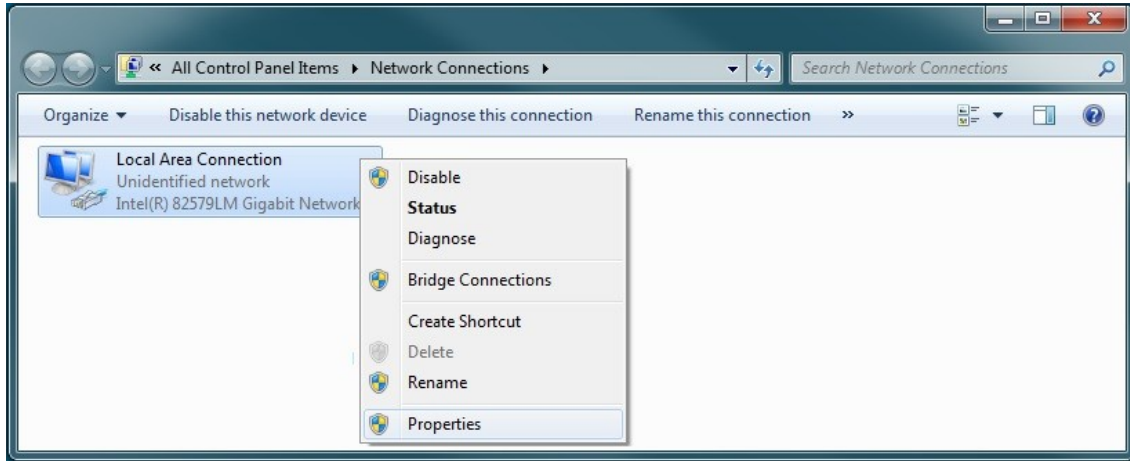

5. Click 'Internet Protocol Version 4 (TCP/IPv4)' and then click **Properties**.

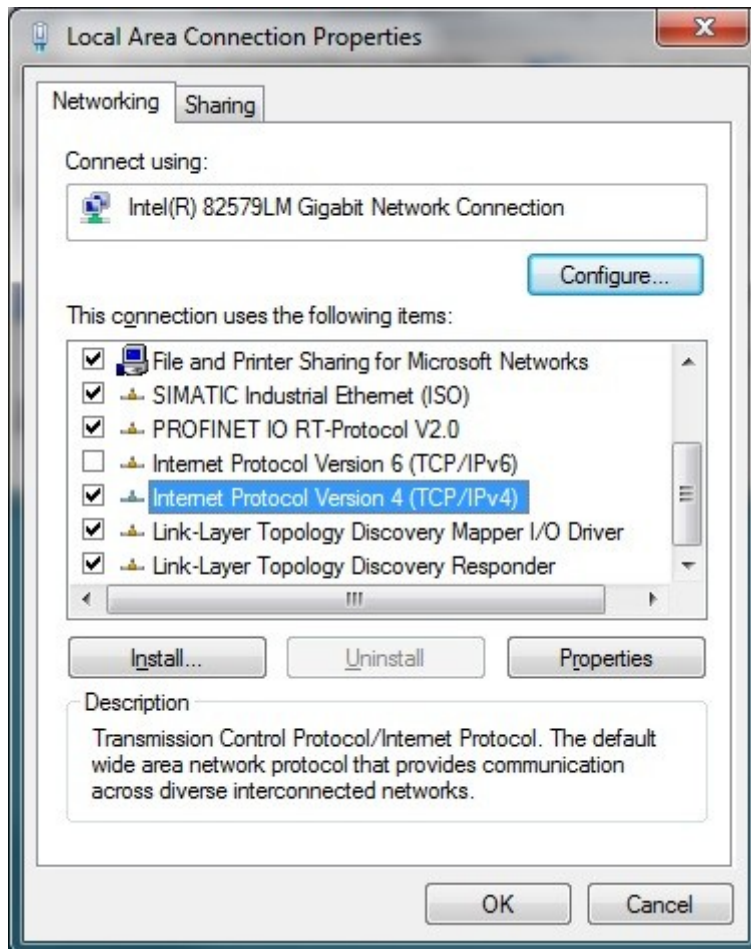

Web-Based Configuration Utility (continued)

6. Click 'Use the following IP address:'. Enter the IP address and subnet mask desired. *Using the values shown below is recommended if the protocol converter has the default IP address.* Click **OK** on each window until the main network control panel is shown.

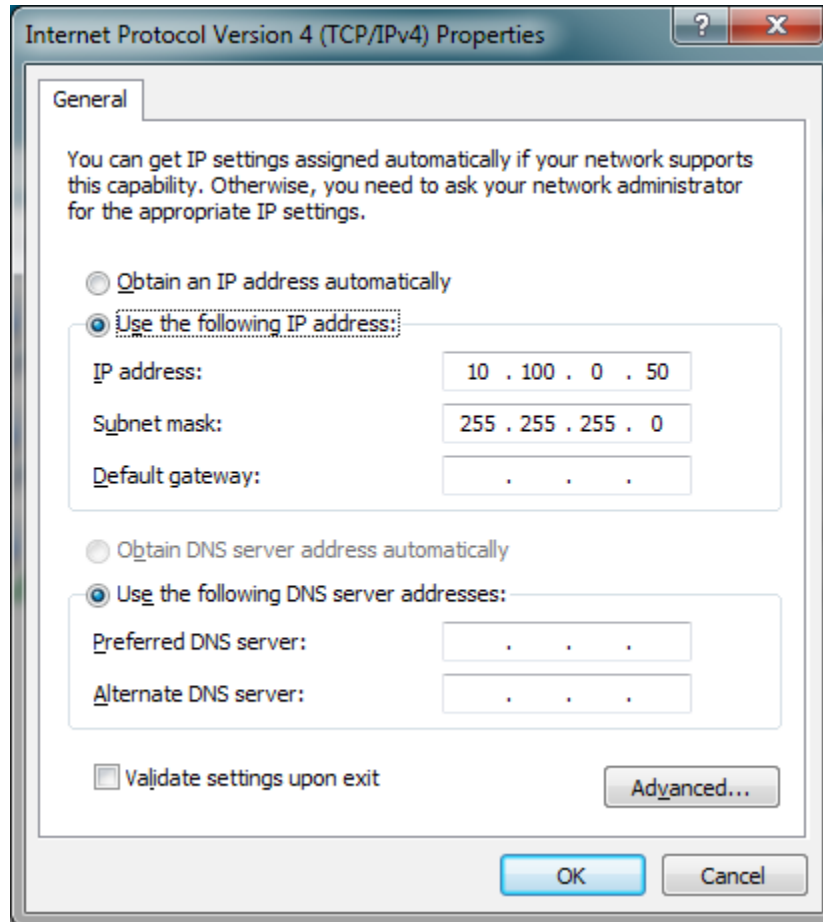

7. To restore DHCP when finished, repeat the steps shown and then click 'Obtain an IP address automatically' as well as 'Obtain DNS server address automatically' in the 'Internet Protocol Version 4 (TCP/IPv4) Properties' window.

Web-Based Configuration Utility (continued)

Interface

Open a web browser. Navigate to <http://10.100.0.4> or <http://192.168.50.1> if using model TS-PW with a wireless connection. Note that these addresses can be changed and may be different.

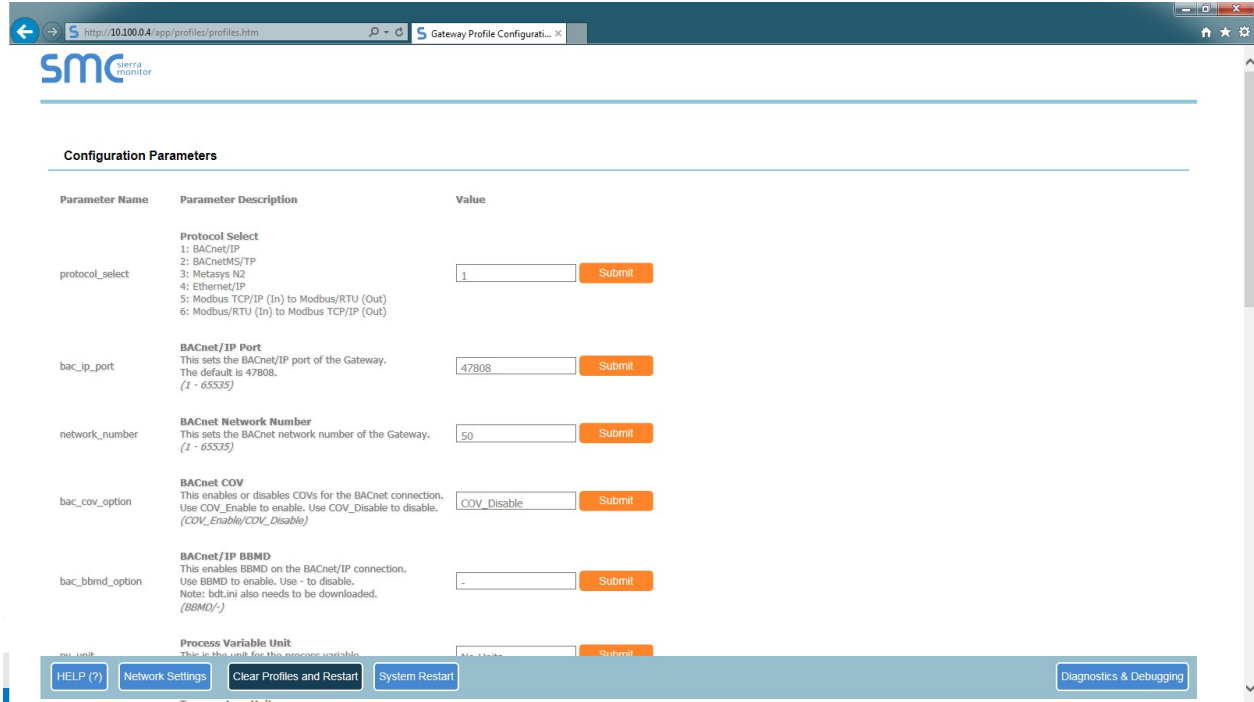

Web-Based Configuration Utility (continued)

Changing the Protocol

To change the protocol, enter the desired number in the **protocol_select** parameter and then click **Submit**. To apply the new protocol, click **System Restart** at the bottom of the screen.

Protocol Select

1: BACnet/IP
2: BACnetMS/TP
3: Metasys N2
4: Ethernet/IP
5: Modbus TCP/IP (In) to Modbus/RTU (Out)
6: Modbus/RTU (In) to Modbus TCP/IP (Out)

protocol_select

Adding a Device

To add a device, scroll down to the bottom of the screen and click **Add**.



Click on the 'Current Profile' drop-down to expand the list. Choose the device to configure.

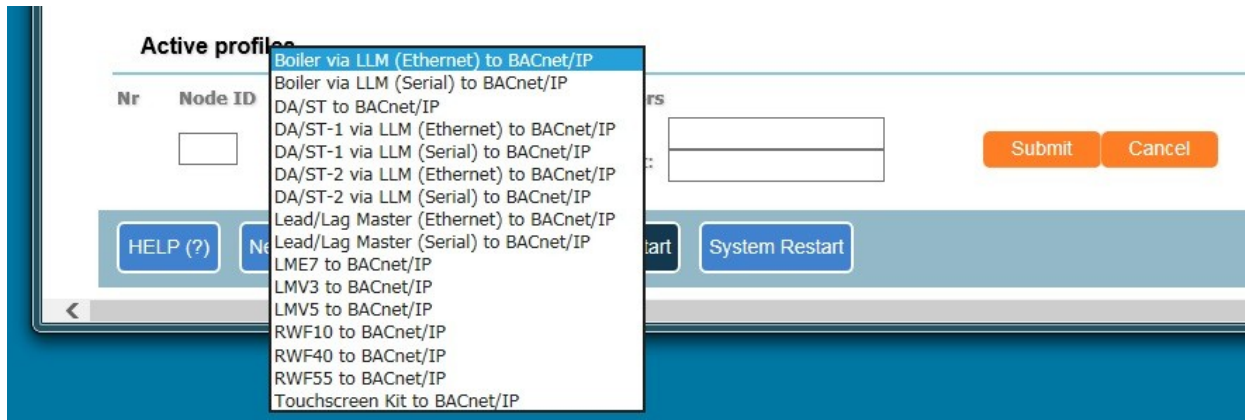

Web-Based Configuration Utility (continued)

Devices available:

- **Boiler via LLM (Ethernet) to <protocol>**: Connect to TS Series Lead/Lag Master boiler object via ETHERNET or ETH port
- **Boiler via LLM (Serial) to <protocol>**: Connect to TS Series Lead/Lag Master boiler object via either the HOST, FIELD, R1 or R2 serial port
- **DA/ST to <protocol>**: Connect to TS Series Deaerator/Surge Tank Master via ETHERNET or ETH port
- **DA/ST-1 via LLM (Ethernet) to <protocol>**: Connect to TS Series Lead/Lag Master DA/ST object (addressed as DA 1) via ETHERNET or ETH port
- **DA/ST-1 via LLM (Serial) to <protocol>**: Connect to TS Series Lead/Lag Master DA/ST object (addressed as DA 1) via either the HOST, FIELD, R1 or R2 serial port
- **DA/ST-2 via LLM (Ethernet) to <protocol>**: Connect to TS Series Lead/Lag Master DA/ST object (addressed as DA 2) via ETHERNET or ETH port
- **DA/ST-2 via LLM (Serial) to <protocol>**: Connect to TS Series Lead/Lag Master DA/ST object (addressed as DA 2) via either the HOST, FIELD, R1 or R2 serial port
- **Lead/Lag Master (Ethernet) to <protocol>**: Connect to TS Series Lead/Lag Master via ETHERNET or ETH port
- **Lead/Lag Master (Serial) to <protocol>**: Connect to TS Series Lead/Lag Master via either the HOST, FIELD, R1 or R2 serial port
- **LME7 to <protocol>**: Connect to LME7... via either the HOST, FIELD, R1 or R2 serial port
- **LMV3 to <protocol>**: Connect to LMV3... via either the HOST, FIELD, R1 or R2 serial port
- **LMV5 to <protocol>**: Connect to LMV5... via either the HOST, FIELD, R1 or R2 serial port
- **RWF10 to <protocol>**: Connect to RWF10 via either the HOST, FIELD, R1 or R2 serial port
- **RWF55 to <protocol>**: Connect to RWF55 via either the HOST, FIELD, R1 or R2 serial port
- **Touchscreen Kit to <protocol>**: Connect to TS Series Touchscreen Kit via ETHERNET or ETH port

Web-Based Configuration Utility (continued)

Once the device is selected, enter the Modbus address in the **Node ID** field. This must be a unique address. For devices connected to the ETHERNET or ETH port, enter any number that has not been used. A good practice in this case is to use numbers 200 or greater since these are unlikely to be assigned as Modbus addresses.

Active profiles

Nr	Node ID	Current profile	Parameters	
<input type="text" value="1"/>	<input type="text" value=""/>	<input type="text" value="LMV5 to BACnet/IP"/>	device_inst: <input type="text" value="1000"/> use_port: <input type="text" value="R2"/>	<input type="button" value="Submit"/> <input type="button" value="Cancel"/>

Depending upon the profile and protocol, different parameters will need to be entered.

- **ip_address:** Required if the device is connected using the ETHERNET port. This is the IP address of the connected device.
- **device_inst:** Required for BACnet protocols. Each connected device must have a unique device instance.
- **use_port:** Required for Ethernet-based protocols. Enter the appropriate ports for the HOST and FIELD port as specified in the protocol parameters (R1 or R2).
- **boiler_id:** Required for Lead/Lag Master boiler objects.

When all of the required information is entered, click **Submit**. The new device(s) should now appear under the 'Active profiles' heading.

Active profiles

Nr	Node ID	Current profile	Parameters	
1	1	LMV5 to BACnet/IP	device_inst : 1000 use_port : R2	<input type="button" value="Remove"/>

Repeat for each device to connect. When finished, click **System Restart** to activate the new profiles.

Web-Based Configuration Utility (continued)

The communication settings for the ports specified in the protocol parameters as the HOST port and FIELD port may need to be changed to match the connected equipment. All equipment connected to a port must have matching settings. Both ports may be used simultaneously if settings that do not match are required. Edit each of these parameters individually and click **Submit**. A restart will be required after all settings are configured.

baud_rate_host	<p>Modbus/RTU Baud Rate HOST Port This sets the Modbus/RTU baud rate for the HOST port. <i>(9600/19200/38400)</i></p>	<input type="text" value="19200"/>	<input type="submit" value="Submit"/>
parity_host	<p>Modbus/RTU Parity HOST Port This sets the Modbus/RTU parity for the HOST port. <i>(None/Even/Odd)</i></p>	<input type="text" value="None"/>	<input type="submit" value="Submit"/>
data_bits_host	<p>Modbus/RTU Data Bits HOST Port This sets the Modbus/RTU data bits for the HOST port. <i>(7 or 8)</i></p>	<input type="text" value="8"/>	<input type="submit" value="Submit"/>
stop_bits_host	<p>Modbus/RTU Stop Bits HOST Port This sets the Modbus/RTU stop bits for the HOST port. <i>(1 or 2)</i></p>	<input type="text" value="1"/>	<input type="submit" value="Submit"/>
baud_rate_field	<p>Modbus/RTU Baud Rate FIELD Port This sets the Modbus/RTU baud rate for the FIELD port. <i>(9600/19200/38400)</i></p>	<input type="text" value="19200"/>	<input type="submit" value="Submit"/>
parity_field	<p>Modbus/RTU Parity FIELD Port This sets the Modbus/RTU parity for the FIELD port. <i>(None/Even/Odd)</i></p>	<input type="text" value="None"/>	<input type="submit" value="Submit"/>
data_bits_field	<p>Modbus/RTU Data Bits FIELD Port This sets the Modbus/RTU data bits for the FIELD port. <i>(7 or 8)</i></p>	<input type="text" value="8"/>	<input type="submit" value="Submit"/>
stop_bits_field	<p>Modbus/RTU Stop Bits FIELD Port This sets the Modbus/RTU stop bits for the FIELD port. <i>(1 or 2)</i></p>	<input type="text" value="1"/>	<input type="submit" value="Submit"/>

Web-Based Configuration Utility (continued)

Adding a TS Series Lead/Lag Master via HOST, FIELD, R1 or R2 Port

Scroll down to the bottom of the screen and click **Add**. In the drop-down menu, select the device name **Lead/Lag Master (Serial) to <protocol>**. When configuring a TS Series Lead/Lag Master, multiple objects are created which appear to the BMS as different devices. There is an object for the global system data, each individual boiler and any connected TS Series Deaerator/Surge Tank Panels. These objects are created individually.

Active profiles

Nr	Node ID	Current profile	Parameters	
<input type="text" value="1"/>		Lead/Lag Master (Serial) to BACnet/IP	device_inst: <input type="text" value="1000"/> use_port: <input type="text" value="R2"/>	<input type="button" value="Submit"/> <input type="button" value="Cancel"/>

Enter **1** for the node ID. This is the default Modbus address of the TS Series Lead/Lag Master. Enter the device instance (if applicable), and the appropriate port for the HOST and FIELD port as specified in the protocol parameters (R1 or R2). Click **Submit**.

Web-Based Configuration Utility (continued)

The other communication settings for the ports specified in the protocol parameters as the HOST port and FIELD port need to be changed to match the TS Series Lead/Lag Master. The required settings are 38400 baud, no parity, 8 data bits and 1 stop bit. Edit each of these parameters individually and click **Submit**. A restart will be required after all settings are configured.

baud_rate_host	Modbus/RTU Baud Rate HOST Port This sets the Modbus/RTU baud rate for the HOST port. <i>(9600/19200/38400)</i>	<input type="text" value="38400"/>	<input type="submit" value="Submit"/>
parity_host	Modbus/RTU Parity HOST Port This sets the Modbus/RTU parity for the HOST port. <i>(None/Even/Odd)</i>	<input type="text" value="None"/>	<input type="submit" value="Submit"/>
data_bits_host	Modbus/RTU Data Bits HOST Port This sets the Modbus/RTU data bits for the HOST port. <i>(7 or 8)</i>	<input type="text" value="8"/>	<input type="submit" value="Submit"/>
stop_bits_host	Modbus/RTU Stop Bits HOST Port This sets the Modbus/RTU stop bits for the HOST port. <i>(1 or 2)</i>	<input type="text" value="1"/>	<input type="submit" value="Submit"/>

Web-Based Configuration Utility (continued)

Adding a TS Series Lead/Lag Master via ETHERNET or ETH Port

Scroll down to the bottom of the screen and click **Add**. In the drop-down menu, select the device name **Lead/Lag Master (Ethernet) to <protocol>**. When configuring a TS Series Lead/Lag Master, multiple objects are created which appear to the BMS as different devices. There is an object for the global system data, each individual boiler and any connected TS Series Deaerator/Surge Tank Panels. These objects are created individually.

Active profiles

Nr	Node ID	Current profile	Parameters
	<input type="text" value="200"/>	Lead/Lag Master (Ethernet) to BACnet/IP ▾	device_inst: <input type="text" value="1000"/>

Enter a unique number for the node ID (such as 200). Enter the device instance (if applicable). Click **Submit**.

The IP address for TS Series Lead/Lag Master must be checked to confirm it matches the IP address of the port it is connected to. The default is 192.168.1.10 for connection to ETHERNET2 on the TS Series Lead/Lag Master touchscreen. Edit this parameter if needed and click **Submit**. A restart will be required if this setting is changed.

ip_master

IP Address Lead-Lag Master
This is the IP address for the lead-lag master.
(xxx.xxx.xxx.xxx)

Web-Based Configuration Utility (continued)

Adding Boiler Objects to TS Series Lead/Lag Master

Boiler objects must be added to the configuration manually.

Scroll down to the bottom of the screen and click **Add**. In the drop-down menu, select the device name **Boiler via LLM (Ethernet) to <protocol>** or **Boiler via LLM (Serial) to <protocol>** that matches the method used to connect the TS Series Lead/Lag Master. *Make sure that the node ID and port selected (for serial) match that of the TS Series Lead/Lag Master and that the device instance selected is not duplicated.* Repeat for each boiler object needed. **boiler_id** indicates the boiler designation (Boiler 1, Boiler 2, Boiler 3, ..., Boiler 8).

Active profiles

Nr	Node ID	Current profile	Parameters	
1	200	Lead/Lag Master (Ethernet) to BACnet/IP	device_inst : 1000	<input type="button" value="Remove"/>
	<input type="text" value="200"/>	<input type="text" value="Boiler via LLM (Ethernet) to BACnet/IP"/> ▼	boiler_id: <input type="text" value="1"/>	<input type="button" value="Submit"/>
			device_inst: <input type="text" value="1001"/>	<input type="button" value="Cancel"/>

Web-Based Configuration Utility (continued)

Adding a TS Series Deaerator/Surge Tank Panel via TS Series Lead/Lag Master

The TS Series Lead/Lag Master can connect to two TS Series Deaerator/Surge Tank Panels. They are addresses as **DA1** and **DA2**. It is important to note these designations.

Scroll down to the bottom of the screen and click **Add**. In the drop-down menu, select the device name **DA/ST-x via LLM (Ethernet) to <protocol>** or **DA/ST-x via LLM (Serial) to <protocol>** that matches the method used to connect the TS Series Lead/Lag Master. Note that the **x** will be 1 or 2 depending upon if DA1 or DA2 is being connected. Make sure that the node ID matches that of the TS Series Lead/Lag Master and that the device instance selected is not duplicated.

Active profiles

Nr	Node ID	Current profile	Parameters	
1	200	Boiler via LLM (Ethernet) to BACnet/IP	device_inst : 1001 boiler_id : 1	<input type="button" value="Remove"/>
2	200	Boiler via LLM (Ethernet) to BACnet/IP	device_inst : 1002 boiler_id : 2	<input type="button" value="Remove"/>
3	200	Boiler via LLM (Ethernet) to BACnet/IP	device_inst : 1003 boiler_id : 3	<input type="button" value="Remove"/>
4	200	Lead/Lag Master (Ethernet) to BACnet/IP	device_inst : 1000	<input type="button" value="Remove"/>
	<input type="text" value="200"/>	<input type="text" value="DA/ST-1 via LLM (Ethernet) to BACnet/IP"/>	device_inst: <input type="text" value="1004"/>	<input type="button" value="Submit"/> <input type="button" value="Cancel"/>

Web-Based Configuration Utility (continued)

Adding a TS Series Deaerator/Surge Tank Panel

Direct connection to a TS Series Deaerator/Surge Tank Panel is possible. Scroll down to the bottom of the screen and click **Add**. In the drop-down menu, select the device name **DA/ST to <protocol>**.

Active profiles

Nr	Node ID	Current profile	Parameters	
	<input type="text" value="200"/>	<input type="text" value="DA/ST to BACnet/IP"/>	ip_address: <input type="text" value="10.100.0.31"/> device_inst: <input type="text" value="1234"/>	<input type="button" value="Submit"/> <input type="button" value="Cancel"/>

Enter a unique number for the node ID (such as 200). Enter the device instance (if applicable) and the IP address. The default IP address for a TS Series Deaerator/Surge Tank Panel is 10.100.0.31.

Active profiles

Nr	Node ID	Current profile	Parameters	
1	200	DA/ST to BACnet/IP	ip_address : 10.100.0.31 device_inst : 1234	<input type="button" value="Remove"/>

Web-Based Configuration Utility (continued)

Adding a TS Series Touchscreen Kit

Direct connection to a TS Series Touchscreen Kit is possible. Scroll down to the bottom of the screen and click **Add**. In the drop-down menu, select the device name **Touchscreen Kit to <protocol>**.

Active profiles

Nr	Node ID	Current profile	Parameters	
	<input type="text" value="200"/>	<input type="text" value="Touchscreen Kit to BACnet/IP"/>	ip_address: <input type="text" value="10.100.0.11"/> device_inst: <input type="text" value="2000"/>	<input type="button" value="Submit"/> <input type="button" value="Cancel"/>

Enter a unique number for the node ID (such as 200). Enter the device instance (if applicable) and the IP address. The default IP address for a TS Series Touchscreen Kit depends upon the boiler designation:

- **Boiler 1:** 10.100.0.11
- **Boiler 2:** 10.100.0.12
- **Boiler 3:** 10.100.0.13
- **Boiler 4:** 10.100.0.14
- **Boiler 5:** 10.100.0.15
- **Boiler 6:** 10.100.0.16
- **Boiler 7:** 10.100.0.17
- **Boiler 8:** 10.100.0.18

Active profiles

Nr	Node ID	Current profile	Parameters	
1	200	Touchscreen Kit to BACnet/IP	ip_address : 10.100.0.11 device_inst : 2000	<input type="button" value="Remove"/>

Web-Based Configuration Utility (continued)

Protocol Configuration Parameters – BACnet/IP

Parameters that apply to all profiles or are general to the protocol are set here. The setting in **bold** is the default. After changing a value, click Submit to apply the change. A restart is required after all desired settings have been changed.

- **bac_ip_port**: This sets the BACnet/IP port, default is **47808** (1-65535).
- **network_number**: This sets the BACnet network number, default is **50** (1-65535).
- **bac_cov_option**: This enables/disables the BACnet COV option, default is disabled (COV_Enable or **COV_Disable**).
- **bac_bbmd_option**: This enables/disables the BACnet/IP BBMD option, default is disabled (BBMD or -).
- **pv_unit**: Chooses the unit for the process variable (**No-Units**, PSI, Deg-F or Deg-C).
- **temp_unit**: Chooses the unit for temperature values (**Deg-F** or Deg-C).
- **host_port**: This sets the port typically connected to the serial devices (**R1/R2**).
- **baud_rate_host**: This sets the Modbus/RTU baud rate for the port specified as the HOST port (9600/**19200/38400**).
- **parity_host**: This sets the Modbus/RTU parity for the port specified as the HOST port (**None/Odd/Even**).
- **data_bits_host**: This sets the Modbus/RTU data bits for the port specified as the HOST port (7 or **8**).
- **stop_bits_host**: This sets the Modbus/RTU stop bits for the port specified as the HOST port (**1** or 2).
- **field_port**: This sets the port typically connected to the BMS (**R1/R2**).
- **baud_rate_field**: This sets the Modbus/RTU baud rate for the port specified as the FIELD port (9600/**19200/38400**).
- **parity_field**: This sets the Modbus/RTU parity for the port specified as the FIELD port (**None/Odd/Even**).
- **data_bits_field**: This sets the Modbus/RTU data bits for the port specified as the FIELD port (7 or **8**).
- **stop_bits_field**: This sets the Modbus/RTU stop bits for the port specified as the FIELD port (**1** or 2).
- **ip_master**: Sets the IP address of the TS Series Lead/Lag Master. The default address is **192.168.1.10** (the default address of the ETHERNET2 port on the HMI).
- **watchdog_time**: Remote command required refresh time, default is **60** seconds (0-999).
- **other_option**: Enables additional options in the Lead/Lag Master, default is **0** (0-999).

Web-Based Configuration Utility (continued)

Protocol Configuration Parameters – BACnet MS/TP

Parameters that apply to all profiles or are general to the protocol are set here. The setting in **bold** is the default. After changing a value, click Submit to apply the change. A restart is required after all desired settings have been changed.

- **mac_address**: This sets the BACnet MS/TP MAC address, default is **11** (1-254).
- **bac_max_master**: This sets the BACnet MS/TP max master, default is **127** (1-127).
- **field_port**: This sets the port typically connected to the BMS (**R1/R2**).
- **baud_rate_mstp**: This sets the BACnet MS/TP baud rate for the port specified as the FIELD port (9600/19200/**38400**).
- **parity_mstp**: This sets the BACnet MS/TP parity for the port specified as the FIELD port (**None/Odd/Even**).
- **data_bits_mstp**: This sets the BACnet MS/TP data bits for the port specified as the FIELD port (7 or **8**).
- **stop_bits_mstp**: This sets the BACnet MS/TP stop bits for the port specified as the FIELD port (**1** or 2).
- **bac_cov_option**: This enables/disables the BACnet COV option, default is disabled (COV_Enable or **COV_Disable**).
- **network_number**: This sets the BACnet network number, default is **50** (1-65535).
- **bac_device_ins**: This sets the BACnet MS/TP device instance, default is **1000** (1-4194303).
- **pv_unit**: Chooses the unit for the process variable (**No-Units**, PSI, Deg-F or Deg-C).
- **temp_unit**: Chooses the unit for temperature values (**Deg-F** or Deg-C).
- **host_port**: This sets the port typically connected to the serial devices (**R1/R2**).
- **baud_rate_host**: This sets the Modbus/RTU baud rate for the port specified as the HOST port (9600/**19200**/38400).
- **parity_host**: This sets the Modbus/RTU parity for the port specified as the HOST port (**None/Odd/Even**).
- **data_bits_host**: This sets the Modbus/RTU data bits for the port specified as the HOST port (7 or **8**).
- **stop_bits_host**: This sets the Modbus/RTU stop bits for the port specified as the HOST port (**1** or 2).
- **ip_master**: Sets the IP address of the TS Series Lead/Lag Master. The default address is **192.168.1.10** (the default address of the ETHERNET2 port on the HMI).
- **watchdog_time**: Remote command required refresh time, default is **60** seconds (0-999).
- **other_option**: Enables additional options in the Lead/Lag Master, default is **0** (0-999).

Web-Based Configuration Utility (continued)

Protocol Configuration Parameters – Metasys N2

Parameters that apply to all profiles or are general to the protocol are set here. The setting in **bold** is the default. After changing a value, click Submit to apply the change. A restart is required after all desired settings have been changed.

- **field_port**: This sets the port typically connected to the BMS (**R1/R2**).
- **host_port**: This sets the port typically connected to the serial devices (**R1/R2**).
- **baud_rate_host**: This sets the Modbus/RTU baud rate for the port specified as the HOST port (9600/**19200**/38400).
- **parity_host**: This sets the Modbus/RTU parity for the port specified as the HOST port (**None**/Odd/Even).
- **data_bits_host**: This sets the Modbus/RTU data bits for the port specified as the HOST port (7 or **8**).
- **stop_bits_host**: This sets the Modbus/RTU stop bits for the port specified as the HOST port (**1** or 2).
- **ip_master**: Sets the IP address of the TS Series Lead/Lag Master. The default address is **192.168.1.10** (the default address of the ETHERNET2 port on the HMI).
- **watchdog_time**: Remote command required refresh time, default is **60** seconds (0-999).
- **other_option**: Enables additional options in the Lead/Lag Master, default is **0** (0-999).

Web-Based Configuration Utility (continued)

Protocol Configuration Parameters – Ethernet/IP

Parameters that apply to all profiles or are general to the protocol are set here. The setting in **bold** is the default. After changing a value, click Submit to apply the change. A restart is required after all desired settings have been changed.

- **host_port**: This sets the port typically connected to the serial devices (**R1/R2**).
- **baud_rate_host**: This sets the Modbus/RTU baud rate for the port specified as the HOST port (9600/**19200**/38400).
- **parity_host**: This sets the Modbus/RTU parity for the port specified as the HOST port (**None**/Odd/Even).
- **data_bits_host**: This sets the Modbus/RTU data bits for the port specified as the HOST port (7 or **8**).
- **stop_bits_host**: This sets the Modbus/RTU stop bits for the port specified as the HOST port (**1** or 2).
- **field_port**: This sets the port typically connected to the BMS (**R1/R2**).
- **baud_rate_field**: This sets the Modbus/RTU baud rate for the port specified as the FIELD port (9600/**19200**/38400).
- **parity_field**: This sets the Modbus/RTU parity for the port specified as the FIELD port (**None**/Odd/Even).
- **data_bits_field**: This sets the Modbus/RTU data bits for the port specified as the FIELD port (7 or **8**).
- **stop_bits_field**: This sets the Modbus/RTU stop bits for the port specified as the FIELD port (**1** or 2).
- **ip_master**: Sets the IP address of the TS Series Lead/Lag Master. The default address is **192.168.1.10** (the default address of the ETHERNET2 port on the HMI).
- **watchdog_time**: Remote command required refresh time, default is **60** seconds (0-999).
- **other_option**: Enables additional options in the Lead/Lag Master, default is **0** (0-999).

Web-Based Configuration Utility (continued)

Protocol Configuration Parameters – Modbus TCP/IP (In) to Modbus/RTU (Out)

Parameters that apply to all profiles or are general to the protocol are set here. The setting in **bold** is the default. After changing a value, click Submit to apply the change. A restart is required after all desired settings have been changed.

This protocol works differently than the others. Profiles are not set up, but rather data is simply passed from the ports specified in the protocol parameters as the HOST port and FIELD ports directly to the ETHERNET or ETH port using the node ID (Modbus address). Odd- or even-numbered nodes can be connected to different ports, allowing a mix of serial networks. The Ethernet port will appear to the connected device as a Modbus TCP/IP server (slave) but will internally be a master in the conversion to Modbus/RTU.

- **odd_nodes**: This sets the port that odd Modbus/RTU nodes are connected to (R1/**R2**).
- **even_nodes**: This sets the port that even Modbus/RTU nodes are connected to (**R1**/R2).
- **host_port**: This sets the port typically connected to the serial devices (R1/**R2**).
- **baud_rate_host**: This sets the Modbus/RTU baud rate for the port specified as the HOST port (9600/**19200**/38400).
- **parity_host**: This sets the Modbus/RTU parity for the port specified as the HOST port (**None**/Odd/Even).
- **data_bits_host**: This sets the Modbus/RTU data bits for the port specified as the HOST port (7 or **8**).
- **stop_bits_host**: This sets the Modbus/RTU stop bits for the port specified as the HOST port (**1** or 2).
- **field_port**: This sets the port typically connected to the BMS (**R1**/R2).
- **baud_rate_field**: This sets the Modbus/RTU baud rate for the port specified as the FIELD port (9600/**19200**/38400).
- **parity_field**: This sets the Modbus/RTU parity for the port specified as the FIELD port (**None**/Odd/Even).
- **data_bits_field**: This sets the Modbus/RTU data bits for the port specified as the FIELD port (7 or **8**).
- **stop_bits_field**: This sets the Modbus/RTU stop bits for the port specified as the FIELD port (**1** or 2).

Web-Based Configuration Utility (continued)

Protocol Configuration Parameters – Modbus/RTU (In) to Modbus TCP/IP (Out)

Parameters that apply to all profiles or are general to the protocol are set here. The setting in **bold** is the default. After changing a value, click Submit to apply the change. A restart is required after all desired settings have been changed.

The Modbus/RTU connection coming in can be made to either one or both ports, and the ports can have different configurations. The serial port will appear to the connected device as a Modbus/RTU server (slave) but will internally be a master in the conversion to Modbus TCP/IP.

- **host_port**: This sets the port typically connected to the serial devices (**R1/R2**).
- **baud_rate_host**: This sets the Modbus/RTU baud rate for the port specified as the HOST port (9600/**19200**/38400).
- **parity_host**: This sets the Modbus/RTU parity for the port specified as the HOST port (**None**/Odd/Even).
- **data_bits_host**: This sets the Modbus/RTU data bits for the port specified as the HOST port (7 or **8**).
- **stop_bits_host**: This sets the Modbus/RTU stop bits for the port specified as the HOST port (**1** or 2).
- **field_port**: This sets the port typically connected to the BMS (**R1/R2**).
- **baud_rate_field**: This sets the Modbus/RTU baud rate for the port specified as the FIELD port (9600/**19200**/38400).
- **parity_field**: This sets the Modbus/RTU parity for the port specified as the FIELD port (**None**/Odd/Even).
- **data_bits_field**: This sets the Modbus/RTU data bits for the port specified as the FIELD port (7 or **8**).
- **stop_bits_field**: This sets the Modbus/RTU stop bits for the port specified as the FIELD port (**1** or 2).

There is only one profile available (Generic_TCPIP). Enter the desired Modbus address of the Modbus/RTU server in the **Node ID** field. This must be a unique address. Enter the IP address of the Modbus TCP/IP client in the **ip_address** field and the Modbus TCP/IP node ID (may be different from the Modbus/RTU node ID) in the **tcp_node_id** field.

Web-Based Configuration Utility (continued)

Protocol Configuration Parameters – LONWORKS

Parameters that apply to all profiles or are general to the protocol are set here. The setting in bold is the default. After changing a value, click Submit to apply the change. A restart is required after all desired settings have been changed.

- **baud_rate_host**: This sets the Modbus/RTU baud rate for the HOST port (9600/19200/**38400**).
- **parity_host**: This sets the Modbus/RTU parity for the HOST port (**None**/Odd/Even).
- **data_bits_host**: This sets the Modbus/RTU data bits for the HOST port (7 or **8**).
- **stop_bits_host**: This sets the Modbus/RTU stop bits for the HOST port (**1** or 2).
- **ip_master**: Sets the IP address of the TS Series Lead/Lag Master. The default address is **192.168.1.10** (the default address of the ETHERNET2 port on the HMI).
- **watchdog_time**: Remote command required refresh time, default is **60** seconds (0-999).
- **other_option**: Enables additional options in the Lead/Lag Master, default is **0** (0-999).

Web-Based Configuration Utility (continued)

Clearing All Profiles From Memory

All configured profiles can be cleared from the protocol converter by clicking Clear Profiles and Restart from the configuration screen. Alternatively, each profile can also be individually removed by clicking Remove under **Active profiles**.

Active profiles

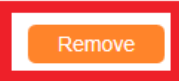
Nr	Node ID	Current profile	Parameters	
1	200	Touchscreen Kit to BACnet/IP	ip_address : 10.100.0.11 device_inst : 2000	

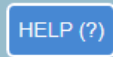
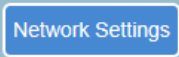
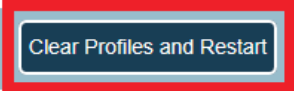
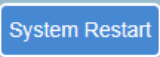

Web-Based Configuration Utility (continued)

Changing Network Settings

From the configuration screen, click Network Settings to view or edit the network settings. Before changing the IP address of the protocol converter or any connected devices, make sure that the communication between the devices will not be affected. This does not apply when the only devices connected to the protocol converter have serial connections (via the HOST, FIELD, R1 or R2 port).

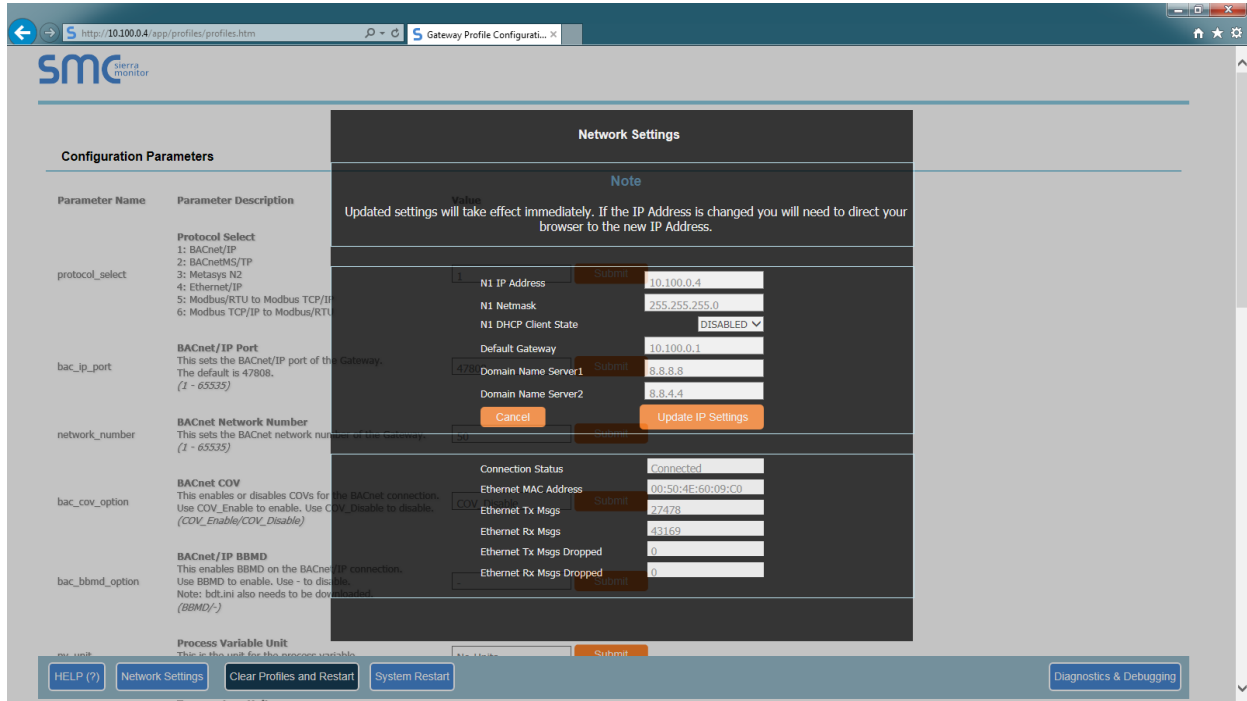

After making changes, click **Update IP Settings** to apply.

Web-Based Configuration Utility (continued)

Diagnostics and Debugging

Navigation

- ✓ SCC Inc. Protocol Converter 19C1
 - About
 - Setup
 - View
 - User Messages
 - Diagnostics

From the configuration screen, click **Diagnostics & Debugging** to display the diagnostic home screen. Use the navigation pane on the left to view the four diagnostic and debugging sections.

About

Contains device data. There are four further tabs including technical support contact information.

The screenshot shows the 'About' page of the web-based configuration utility. On the left is a navigation pane with the following structure:

- ✓ SCC Inc. Protocol Converter 19C1
 - About
 - Setup
 - View
 - User Messages
 - Diagnostics

The main content area has four tabs: Firmware, GUI, Skin, and Contact. The 'Firmware' tab is selected, showing a table with the following data:

Name	Value
Driver_Configuration	DCC000
DCC_Version	V6.05p (A)
Kernel_Version	V6.49b (C)
Release_Status	Normal
FieldServer_Model	Brain2
Serial_Number	-
BIOS_Version	4.0.2
Carrier_Type	485 Carrier
API: STATS_API	V1.00m (I)
API: REGISTRY_API	V1.02a (Q)
API: PLAT_CONF	V1.01b (Y)
API: QS_API	V1.00c (S)
API: Hot_Stby	V1.01a (W)
API: SIO_Linux	V1.00h (A)
API: CFG_CSV	V1.03a (J)
Driver: MODBUS_RTU	V4.15b (A)
Driver: SMT	V1.01m (R)
Driver: XML-HTTP	V1.20a (B)
Driver: JSON_TCP	V1.09a (A)
Build Revision	4.39.1
Build Date	2018-11-29 17:11:26 +0200

At the bottom of the page, there are three buttons: Home, HELP (F1), and Contact Us.

Web-Based Configuration Utility (continued)

Setup – Loading Updates

Allows uploading and downloading of system files.

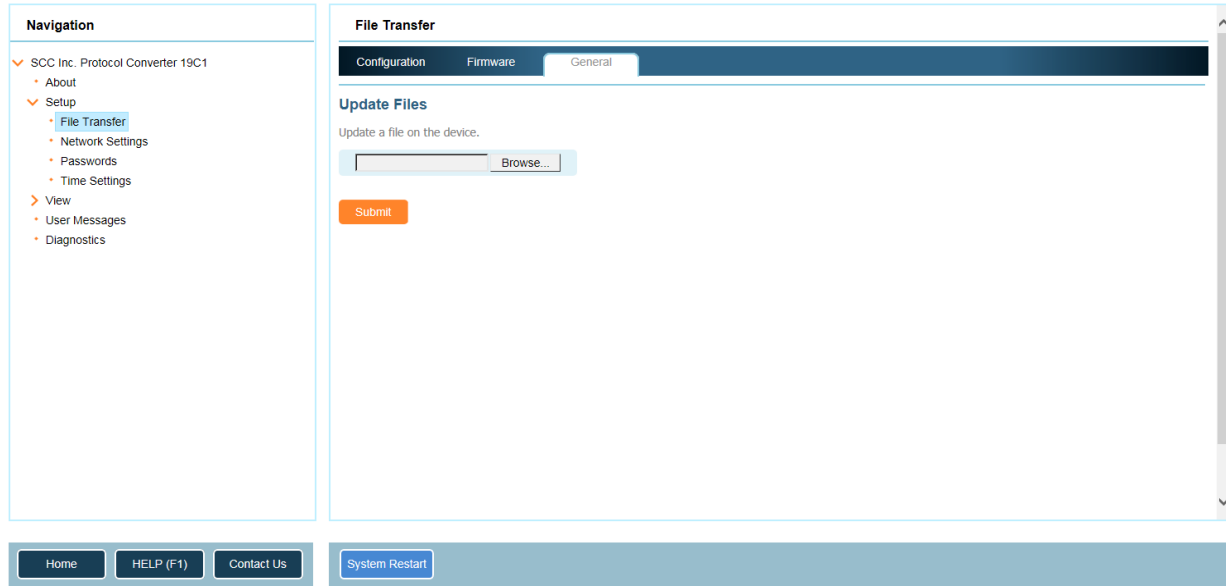

To load supplied updates or other configuration files (such as BACnet BBMD mapping file **bdt.ini**) choose the **General** tab, then click **Choose Files**. Navigate to the file to load then click **Submit**. A restart is required after loading a new file. An update file will have a name in the format **<revision number>-armv7.img**. An example of a revision is 19F1 (this revision). *If an update is loaded it is advised to clear all of the existing profiles and recommission the protocol converter.*

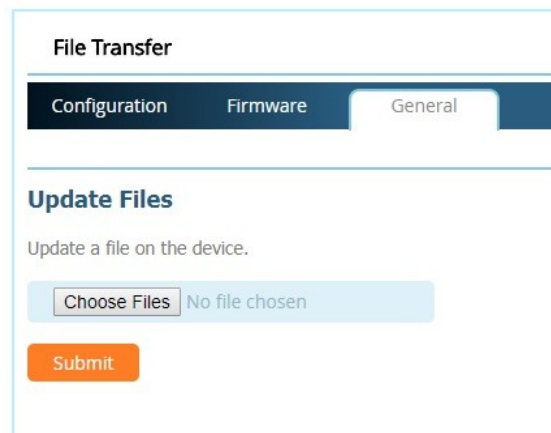

Web-Based Configuration Utility (continued)

Setup – WiFi Client

Allows a connection via WiFi to an existing wireless network (model TS-PW only). Depending upon the location of the protocol converter, it may require that an external antenna is mounted to receive a sufficient signal. Another device such as a laptop computer or smart phone must be used to detect the available wireless networks.

The screenshot displays the 'Network Settings' interface for the 'WiFi Client' tab. On the left, a navigation menu lists various system settings, with 'Network Settings' highlighted. The main content area features a 'Note' stating that updated settings take effect immediately and that changing the IP address requires a browser redirect. Below this, several configuration fields are listed: 'WiFi Status' (set to 'DISABLED'), 'WiFi SSID' (set to 'other network'), 'WiFi Password', 'WiFi DHCP Client State' (set to 'DISABLED'), 'WiFi IP Address', 'WiFi Netmask', 'WiFi Default Gateway', 'WiFi Domain Name Server1', and 'WiFi Domain Name Server2'. Each field has a corresponding input box or dropdown menu. At the bottom of the settings area are 'Cancel' and 'Update WiFi Settings' buttons. A 'Connection Status' section at the very bottom shows 'Disabled' and a 'WiFi MAC Address' field.

- **WiFi Status:** Enables or disables the WiFi client.
- **WiFi SSID:** Enter the name of the wireless network to connect to.
- **WiFi Password:** Enter the password for the wireless network.
- **WiFi DHCP Client State:** Enables or disables connection to the DHCP server (automatically provides an IP address).
- **WiFi IP Address:** Enter the desired IP address (if DHCP Client State is disabled).
- **WiFi Netmask:** Enter the desired subnet (if DHCP Client State is disabled).
- **WiFi Default Gateway:** Enter the desired default gateway (if DHCP Client State is disabled).
- **WiFi Domain Name Servers:** Enter the desired domain name servers (if DHCP Client State is disabled).

The connection status and statistics will display on the bottom of the screen to indicate if the connection is successful.

Web-Based Configuration Utility (continued)

Setup – WiFi Access Point

Allows a wireless access point to be established via WiFi (model TS-PW only). Depending upon the location of the protocol converter, it may require that an external antenna is mounted to receive a sufficient signal. This allows a wireless connection to be made by a laptop computer or smart phone for accessing the web-based configuration utility (see *Establishing a Connection* for additional detail). By default, the access point is enabled with the name "SCC Inc. Protocol Converter" and the password "start9876" and has IP address **192.168.50.1**.

The screenshot displays the 'WiFi AP' configuration page. On the left is a navigation tree with 'Network Settings' selected. The main area has a 'Note' and a form with the following fields and values:

Access Point Status	ENABLED
Access Point SSID	SCC Inc. Protocol Convert
Access Point Password	start9876
SSID Broadcast	ENABLED
Channel	11
Access Point Hotspot	DISABLED
Access Point IP Address	192.168.50.1
Access Point Netmask	255.255.255.0
Access Point IP Pool Address Start	192.168.50.120
Access Point IP Pool Address End	192.168.50.130

Buttons: Cancel, Update WiFi Settings. Connection Status: Enabled.

- **Access Point Status:** Enables or disables the access point.
- **Access Point SSID:** Enter the name of the wireless network.
- **Access Point Password:** Enter the password for the wireless network (must be between 8 and 64 characters).
- **SSID Broadcast:** Enables or disables broadcasting of the SSID. If broadcasting is disabled, a connection can still be made if the SSID is known and entered manually.
- **Channel:** Specifies the wireless channel between 1 and 11. Only change if necessary.
- **Access Point Hotspot:** Enables or disables the access point hotspot feature, which re-transmits Internet connectivity if present on the ETH port.
- **Access Point IP Address:** Enter the desired IP address. This must be on a different network than the ETH port.
- **Access Point Netmask:** Enter the desired subnet.
- **Access Point IP Pool Address Start:** Enter the first IP address to assign via DHCP.
- **Access Point IP Pool Address End:** Enter the last IP address to assign via DHCP.

The connection status and statistics will display on the bottom of the screen.

Web-Based Configuration Utility (continued)

View

The status of connections (protocol statistics), data arrays (internal data), nodes (individual device statistics) and map descriptors (data statistics) can be viewed to determine if configuration is successful.

Connections shows the Tx (transmit) and Rx (receive) traffic for each protocol. This shows that data is passing through the protocol converter. If Tx and Rx do not increment in unison that may indicate a communication problem.

Index	Name	Tx Msg	Rx Msg	Tx Char	Rx Char	Errors
0	S1 - MODBUS_RTU	129	129	1,032	9,143	0
1	R1 - MODBUS_RTU	0	0	0	0	0
2	N1 - Modbus/TCP	0	0	0	0	0
3	N1 - BACnet_IP	175	178	21,625	2,279	1

Data Arrays shows the internal data buffers. Browse the internal data buffers to see if there is non-zero data which is a good indication that communication is successful.

Name	Value
Data Array Name	DA_S16_1
Data Format	SInt16
Length in Items	300
Bytes per Item	2
Data Age	0.108s

Offset	0	1	2	3	4	5	6	7	8	9
0	0	0	1176	608	0	608	0	0	0	0
10	0	608	0	608	0	16960	15	255	255	0
20	0	-1	-1	-1	-1	0	0	0	0	0
30	0	0	0	0	0	0	0	0	0	0
40	0	0	0	0	0	0	0	0	0	0
50	0	0	0	0	0	0	0	0	0	0
60	0	0	0	0	0	0	0	0	0	0
70	0	0	0	0	0	0	0	0	0	0
80	0	0	0	0	0	0	0	0	0	0
90	0	0	0	0	0	0	0	0	0	0
100	167	608	0	12	255	0	0	0	0	0

Web-Based Configuration Utility (continued)

Nodes shows the Tx (transmit) and Rx (receive) traffic for each device. This shows that data is passing through the protocol converter. If Tx and Rx do not increment in unison that may indicate a communication problem.

Navigation

- ▼ SCC Inc. Protocol Converter 19C1
 - About
 - Setup
 - ▼ View
 - Connections
 - Data Arrays
 - ▼ Nodes
 - Dev_1
 - LME7_1
 - Map Descriptors
 - User Messages

Nodes

Overview

Index	Name	Tx Msg	Rx Msg	Tx Char	Rx Char	Errors
0	Dev_1	1,788	1,788	14,304	126,948	0
1	LME7_1	109	109	1,853	2,398	0

Map Descriptors shows the statistics for each data point. This indicates which data is being accessed to help troubleshoot communication issues.

Navigation

- ▼ Map Descriptors
 - CMD_Dev_1_01
 - CMD_Dev_1_02
 - CMD_Dev_1_03
 - CMD_Dev_1_04
 - PHASE
 - FLAME INTENSITY
 - MAINS VOLTAGE
 - STARTUPS RESETTABLE
 - STARTUPS TOTAL
 - RELAY K12 CYCLES
 - RELAY K11 CYCLES
 - RELAY K2 CYCLES
 - RELAY K1 CYCLES
 - MAX RELAY CYCLES
 - CURRENT OUTPUT PERCENT
 - ACTUATOR ACTUAL PERCENT
 - ACTUATOR TARGET PERCENT
 - EXT LOAD CONTROLLER PERCENT
 - FAN SPEED RPM
 - FAN SPEED PERCENT
 - TARGET FAN SPEED PERCENT
 - PWM SIGNAL PERCENT
 - CURRENT ERROR CODE

Map Descriptors

Overview

Index	Name	Tx Msg	Rx Msg	Tx Char	Rx Char	Errors
0	CMD_Dev_1_01	534	534	4,272	29,370	0
1	CMD_Dev_1_02	533	533	4,264	114,595	0
2	CMD_Dev_1_03	533	533	4,264	3,731	0
3	CMD_Dev_1_04	533	533	4,264	3,731	0
4	PHASE	109	109	1,853	2,398	0
5	FLAME INTENSITY	0	0	0	0	0
6	MAINS VOLTAGE	0	0	0	0	0
7	STARTUPS RESETTABLE	0	0	0	0	0
8	STARTUPS TOTAL	0	0	0	0	0
9	RELAY K12 CYCLES	0	0	0	0	0
10	RELAY K11 CYCLES	0	0	0	0	0
11	RELAY K2 CYCLES	0	0	0	0	0
12	RELAY K1 CYCLES	0	0	0	0	0
13	MAX RELAY CYCLES	0	0	0	0	0
14	CURRENT OUTPUT PERCENT	0	0	0	0	0
15	ACTUATOR ACTUAL PERCENT	0	0	0	0	0
16	ACTUATOR TARGET PERCENT	0	0	0	0	0
	EXT LOAD					

BACnet Additional Information

Models TS-PX... and TS-PW support both BACnet/IP and BACnet MS/TP.

BACnet/IP

BACnet/IP uses Ethernet as the physical medium and communicates using the UDP transport layer on port 47808 (BAC0 in hexadecimal) by default. The protocol converter can be configured as a BACnet/IP Broadcast Management Device.

BACnet/IP BBMD (BACnet/IP Broadcast Management Device)

Using BACnet/IP Broadcast Management Device (BBMD), any received broadcast messages will be sent as directed messages to any other connected BBMD devices. For this to work, each BBMD must be configured with the IP addresses of any other connected BBMDs using a Broadcast Distribution Table (BDT).

To create a BDT, use Notepad or any text editor to create a file in the format shown below. Use a new line for each entry and separate data fields with a comma. Save the file with the filename **bdt.ini** and load into the protocol converter using the web-based configuration utility (follow the procedure used to load updates).

```
// bdt.ini
// The format of this table must be:
//
// BBMD IP address , BBMD port , BBMD subnet mask
//
24.90.48.179 , 47808 , 255.255.255.255
64.80.115.156 , 47808 , 255.255.255.255
```

BACnet MS/TP

BACnet MS/TP uses RS-485 as the physical medium and communicates using a method known as 'master-slave token passing'. With this method, a device that wishes to initiate a poll requests the token. Only one device at any time can possess the token. When the device is finished or has reached the message limit, the token is passed to the next device that has requested it.

There is one MAC address and device instance for the protocol converter.

Up to 128 devices can be installed on a single network. Supported baud rates are 9600, 19200, 38400 and 76800.

Metasys N2 Additional Information

Models TS-PX... and TS-PW support Metasys N2.

Metasys N2 uses RS-485 as the physical medium. The maximum number of devices that can be installed on a single network varies depending upon the model of controller. The only supported baud rate is 9600.

Ethernet/IP Additional Information

Models TS-PX... and TS-PW support Ethernet/IP. The protocol converter is configured to be a server to the system. Message instructions are used to query data as needed.

Tested Applications

The following Rockwell Automation software platforms have been tested:

- Studio 5000
- RSLogix 5000

Setup Files

A compressed folder containing add-on instructions and user-defined data types is hosted on the protocol converter. These files will help to expedite the connection of the protocol converter. To download this folder, navigate a web browser to <http://10.100.0.4/ethip.zip> (or the new IP address if it has been changed).

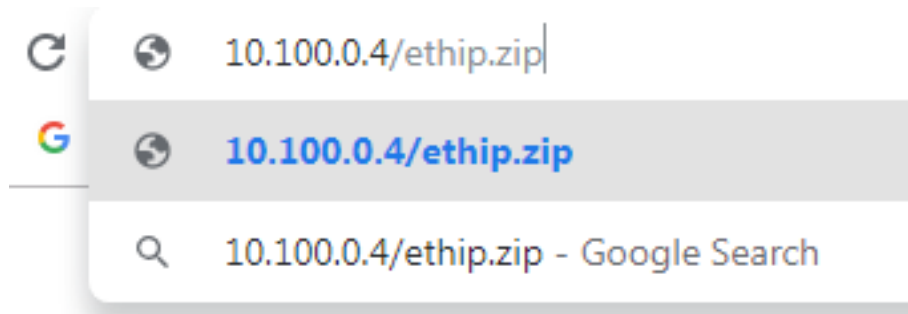

Once, the file is downloaded, copy the contents of the compressed folder into another location where they can be readily found.



Ethernet/IP Additional Information (continued)

User-Defined Data Types

Open Studio 5000 or RSLogix 5000. Create a new project using the appropriate controller. In the **Controller Organizer** window, right-click **User-Defined** under **Data Types** and choose **Import Data Type....**

Navigate to the 'User-Defined Data Type' folder saved and choose the file that matches the device connected to the protocol converter. Repeat for each different device that is connected.

These data types each contain arrays for the read, status, write and trigger data required to make a connection. Manually creating the needed arrays is an alternative to using these data types.

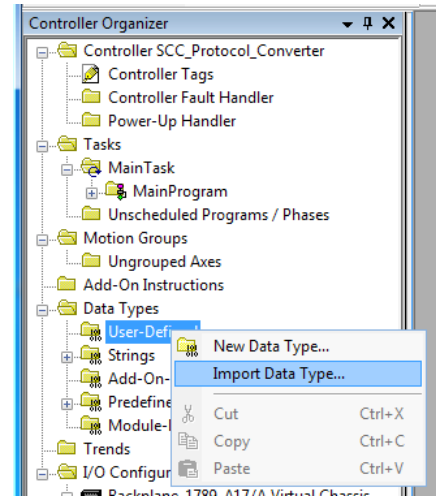

Add-On Instructions

In the **Controller Organizer** window, right-click **Add-On Instructions** and choose **Import Add-On Instruction....**

Navigate to the 'Add-On Instruction' folder saved and choose the file 'SCC_Sync_Variable.L5K'. Select the default options and the file will appear on the tree. If the protocol converter is being used for read-only access then this file is not necessary.

Navigate to the 'Add-On Instruction' folder again and choose the file 'SCC_Message_Sequence.L5K'. Select the default options and the file will appear on the tree. This instruction will provide a way to sequence message instructions in logic. If this logic is not needed then this file is not necessary.

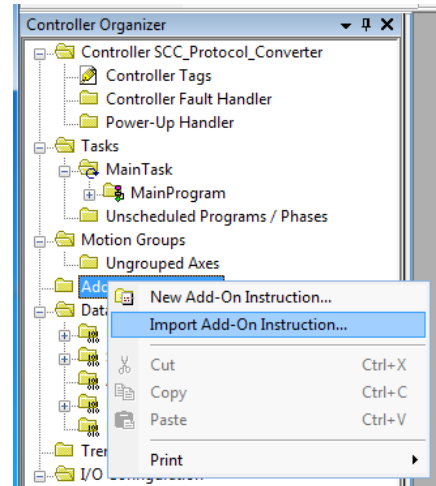

Once all files are imported, they will be available to use as variable objects. Confirm their existence in the **Controller Organizer** window.

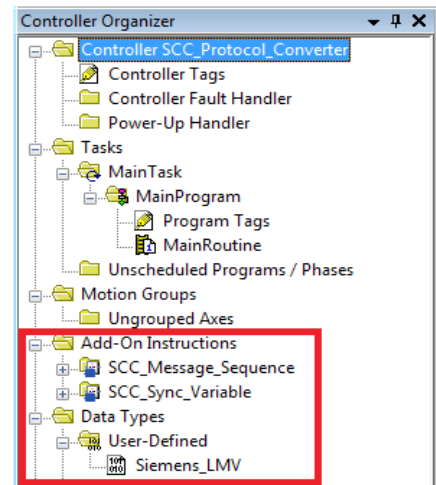

Ethernet/IP Additional Information (continued)

Controller Tags

In the **Controller Organizer** window, double-click **Controller Tags** and click the **Edit** tab. Choose a name for the device data to be connected (such as **Boiler_1**) and then click the **...** button to choose the data type. Select the user-defined data type that matches the device.

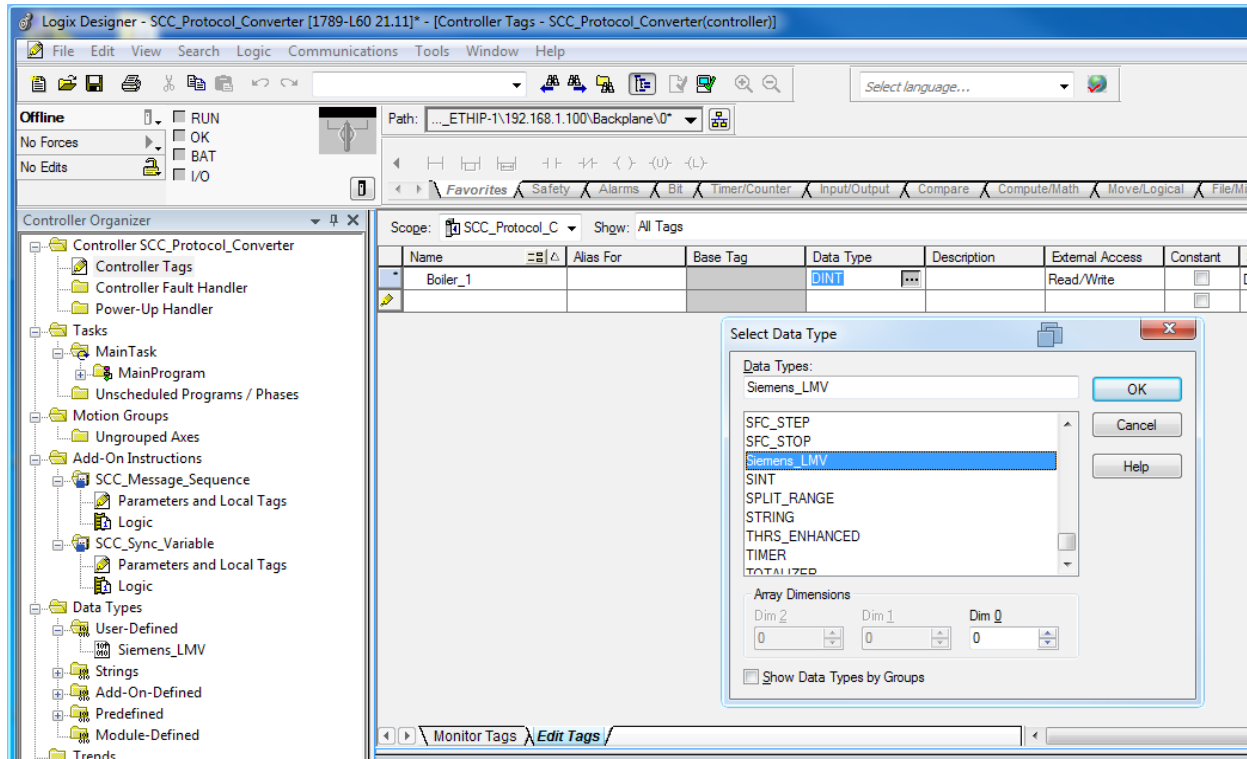

Create four message tags for each device, one each for read, status, write and trigger data. Also create a tag for the **SCC_Message_Sequence** add-on instruction. Finally, create a tag of type **SCC_Sync_Variable** for each data point that requires read/write access (one synchronized variable is shown in the example).

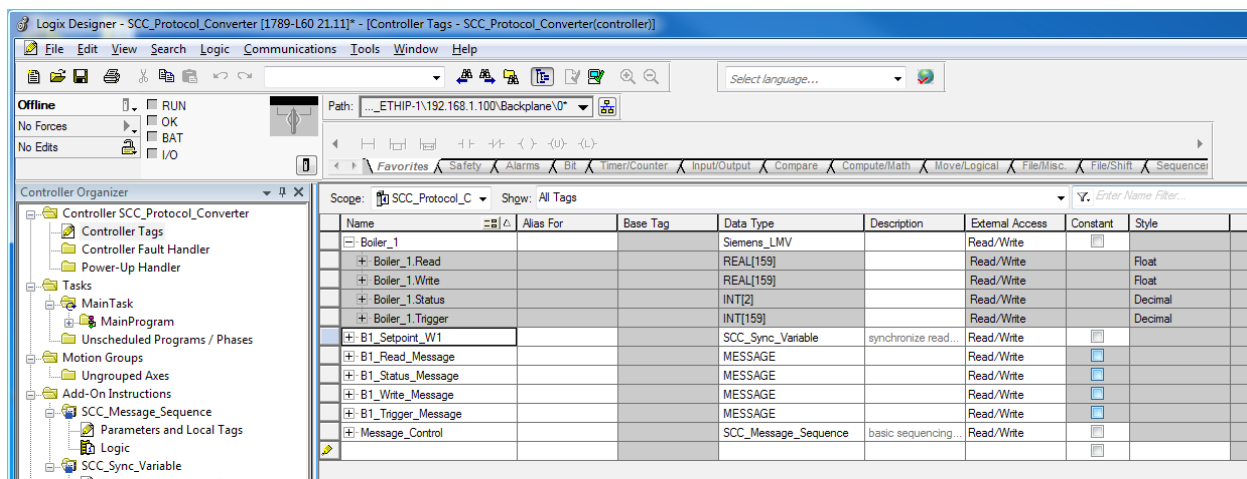

Ethernet/IP Additional Information (continued)

When tags are synchronized, the write array is used for read/write access. The data will synchronize between the read and write arrays automatically. If read-only access is sufficient, the read array is used for that data point.

If the **SCC_Sync_Variable** add-on instruction is not used, data from an index in the write array will be written whenever the corresponding index in the trigger array is set to **1**. It is then necessary to validate that the data was written by reading it back from the corresponding index in the read array.

The status array contains read-only bit data.

If the user-defined data types for each device are not used, create tags as outlined in the table below:

Device	Read	Status	Write	Trigger
LMV...	REAL[159]	INT[2]	REAL[159]	INT[159]
LME7...	REAL[64]	INT[3]	n/a	n/a
RWF10	REAL[11]	INT[1]	REAL[11]	INT[11]
RWF55	REAL[62]	INT[2]	REAL[62]	INT[62]
TS Series Hardwired Draft	REAL[22]	INT[2]	REAL[22]	INT[22]
TS Series DA/ST (standalone)	REAL[90]	INT[2]	n/a	n/a
TS Series Touchscreen Kit	REAL[274]	INT[21]	REAL[274]	INT[274]
TS Series Lead/Lag Master	REAL[57]	INT[5]	REAL[57]	INT[57]
TS Series LL Master (boiler)	REAL[96]	INT[7]	n/a	n/a
TS Series LL Master (DA/ST)	REAL[90]	INT[2]	n/a	n/a

Ethernet/IP Additional Information (continued)

Logic

Open the logic routine (such as **MainRoutine**) where the message instructions should be placed. Place **SCC_Message_Sequence** (found under **Add-On** tab) at the end of a rung. Edit the input tag **Qty_Messages** to match the total number of message instructions that will be used (maximum of 32 using this add-on instruction). **Time_Poll** and **Time_Sync** are in milliseconds and can be adjusted. Ensure **Time_Sync** is always slower than **Time_Poll** if these are adjusted.



Add the message instructions (**MSG** found under **Input/Output** tab) and trigger each from **SCC_Message_Sequence** by using the tags shown. The output tag **Call_Message** from the **SCC_Sync_Variable** tag has bits from 0 through 31 as needed to trigger up to 32 messages.

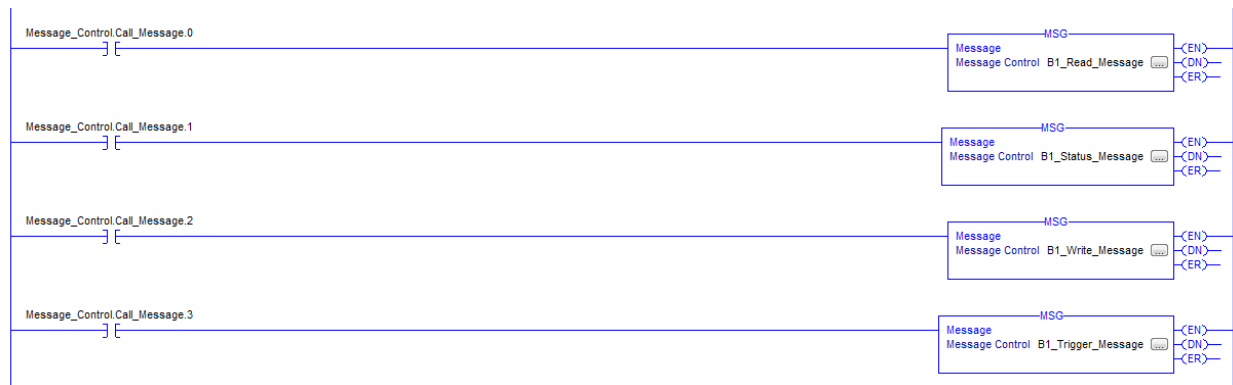

Set up any synchronized tags as shown using the output tag **Sync_Enable** from the **SCC_Sync_Variable** tag. Use the same array index for each of the **Read**, **Trigger** and **Write** inputs. This automates the coordination between the tags.

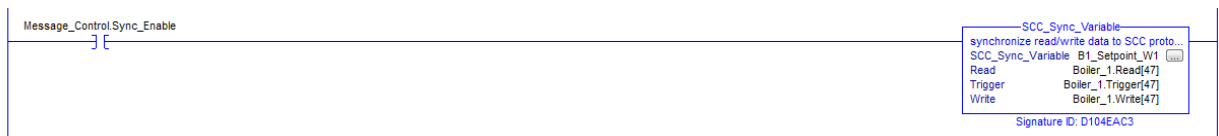

Ethernet/IP Additional Information (continued)

Setting Up Messaging Instructions

The protocol converter has specific data tags and array lengths that are required to be known for configuring the messaging instructions. **x** represents the **Node ID** parameter entered into the protocol converter when setting up the device.

Device	Read (R)	Status (S)	Write (W)	Trigger (T)	R/W/T Length	S Length
LMV...	LMV_Read_x	LMV_Status_x	LMV_Write_x	LMV_Trigger_x	159	2
LME7...	LME7_Read_x	LME7_Status_x	n/a	n/a	64	3
RWF10	RWF10_Read_x	RWF10_Status_x	RWF10_Write_x	RWF10_Trigger_x	11	1
RWF55	RWF55_Read_x	RWF55_Status_x	RWF55_Write_x	RWF55_Trigger_x	62	2
TS Series Hardwired Draft	DraftHW_Read_x	DraftHW_Status_x	DraftHW_Write_x	DraftHW_Trigger_x	22	2
TS Series DA/ST (standalone)	DSC_Read_x	DSC_Status_x	n/a	n/a	90	2
TS Series Touchscreen Kit	TSK_Read_x	TSK_Status_x	TSK_Write_x	TSK_Trigger_x	274	21
TS Series Lead/Lag Master	LLM_Mst_Read_x	LLM_Mst_Status_x	LLM_Mst_Write_x	LLM_Mst_Trigger_x	57	5
TS Series LL Master (boiler, y = 1-8)	LLM_By_Read_x	LLM_By_Status_x	LLM_By_Write_x	LLM_By_Trigger_x	96	7
TS Series LL Master (DA/ST, y = 1 or 2)	DSCy_Read_x	DSCy_Status_x	n/a	n/a	90	2

Click  on each message instruction to set up the specific message. For the **Read** and **Status** message instructions, choose the message type **CIP Data Table Read**. Select the source element name and number of elements from the table above – this must be an exact match with the tag name in the protocol converter. Select the destination element from the device tag and select the sub-element to match the type of data (**Read** or **Status**).

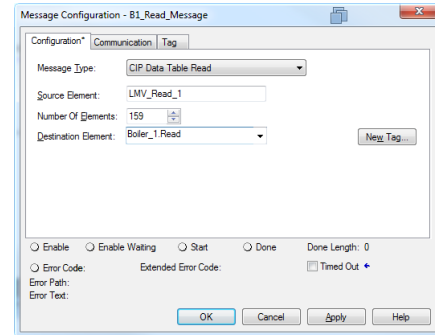

Click the **Communication** tab. This is where the path to the protocol converter is entered. Click **Browse** to choose the Ethernet/IP device to communicate from.

Once the device is chosen, the name for that device will be filled in. Type the remainder of the path following this format: **<communication device>, 2, <protocol converter IP address>**. Following the example and using the default IP address of the protocol converter, the path would be: **EthIP, 2, 10.100.0.4**. The **2** indicates Ethernet/IP communication.

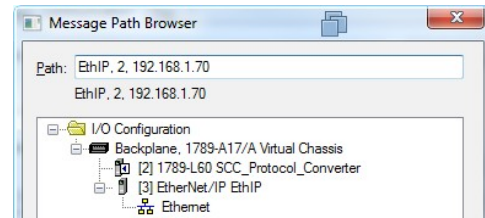
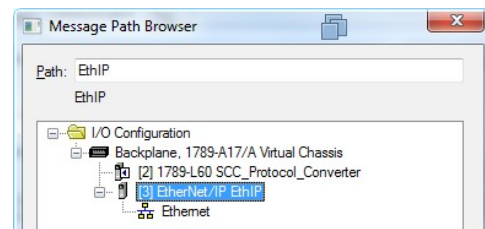
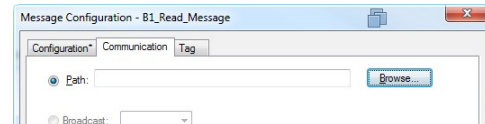

Ethernet/IP Additional Information (continued)

For the **Write** and **Trigger** message instructions, choose the message type **CIP Data Table Write**. Select the source element from the device tag and select the sub-element to match the type of data (**Write** or **Trigger**). Select the number of elements and destination element name from the table above – this must be an exact match with the tag name in the protocol converter. Set up the communication path as previously described.

For both **CIP Data Table Read** and **CIP Data Table Write** messages, check the **Connected** and **Cached Connections** check boxes at the bottom of the **Communication** tab.

Testing Operation

Once all of the message instructions have been configured, download the application into the PLC and set it to RUN mode. If communication is working, the **DN** bits to the right of each message instruction should be highlighted. If they are not, check that the protocol converter is connected to the same network as the PLC. If it is and there still is no communication, check that the protocol converter is configured for the correct devices and has communication with them. Finally, check that the message instructions have the correct information. Any errors in tag names will result in errors.

Double-click **Controller Tags** in the **Controller Organizer** window and select the **Monitor** tab. Data from the connected device should be visible in the corresponding **Read** array. The mapping tables indicate data applies to each array index. If a tag is synchronized using the **SCC_Sync_Variable** add-on instruction the data from the **Read** array will be available in the **Write** array for that particular index. When a tag is synchronized the **Write** array is what is referenced in the PLC or HMI program to monitor or change the data.

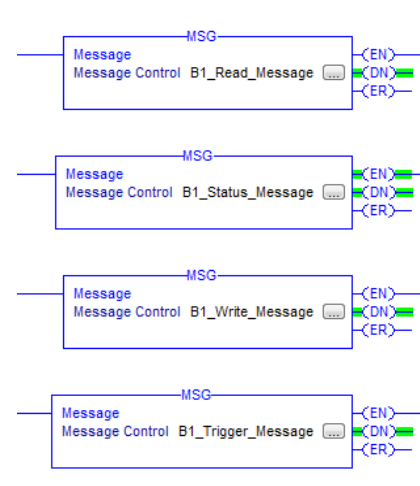
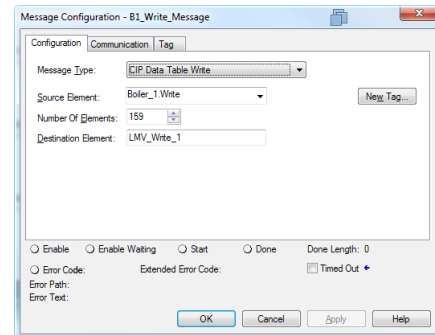

Scope: SCC_Protocol_C Shgw: All Tags

Name	Value
Boiler_1.Read	{...}
-Boiler_1.Read[0]	60.0
-Boiler_1.Read[1]	51.8
-Boiler_1.Read[2]	51.8
-Boiler_1.Read[3]	1.0
-Boiler_1.Read[4]	37.0
-Boiler_1.Read[5]	-10.2
-Boiler_1.Read[6]	-10.2
-Boiler_1.Read[7]	10.3
-Boiler_1.Read[8]	72.9
-Boiler_1.Read[9]	0.0
-Boiler_1.Read[10]	61.7
-Boiler_1.Read[11]	99.0
-Boiler_1.Read[12]	89.0
-Boiler_1.Read[13]	100.0
-Boiler_1.Read[14]	13191.0

Modbus Additional Information

Supported baud rates for Modbus/RTU are 9600, 19200, 38400, 57600, 76800 and 115000.

Conversion from Modbus/RTU to Modbus TCP/IP requires that the node ID parameter is used. This is often not used or set to '255' by default, following the assumption that there would only be one node per IP address. The protocol converter can have multiple nodes on a single IP address which makes this parameter necessary. While troubleshooting the connection, ensure that this parameter is being used correctly.

Conversion from Modbus TCP/IP to Modbus/RTU makes the data available on both ports simultaneously. Each port can have different communication settings.

LONWORKS Additional Information

Models TS-PL... support the LonWorks protocol via the FIELD port. LONWORKS uses the FTT-10A transceiver. The LONWORKS network is polarity insensitive and supports free topology wiring (star, bus or daisy-chain wiring are all acceptable). When using LONWORKS, the device must be commissioned on the LONWORKS network using a commissioning tool.

Service Pin

To aid with commissioning, a service pin is provided to broadcast the network information of the protocol converter. This is located under the case and can be depressed using a small screwdriver.



Uploading XIF File

If it is necessary to supply an XIF file during commissioning, this can be uploaded from the device. To do so, open a web browser and navigate to <http://10.100.0.7/fserver.xif> (or the new IP address if it has been changed). Save the file when prompted.

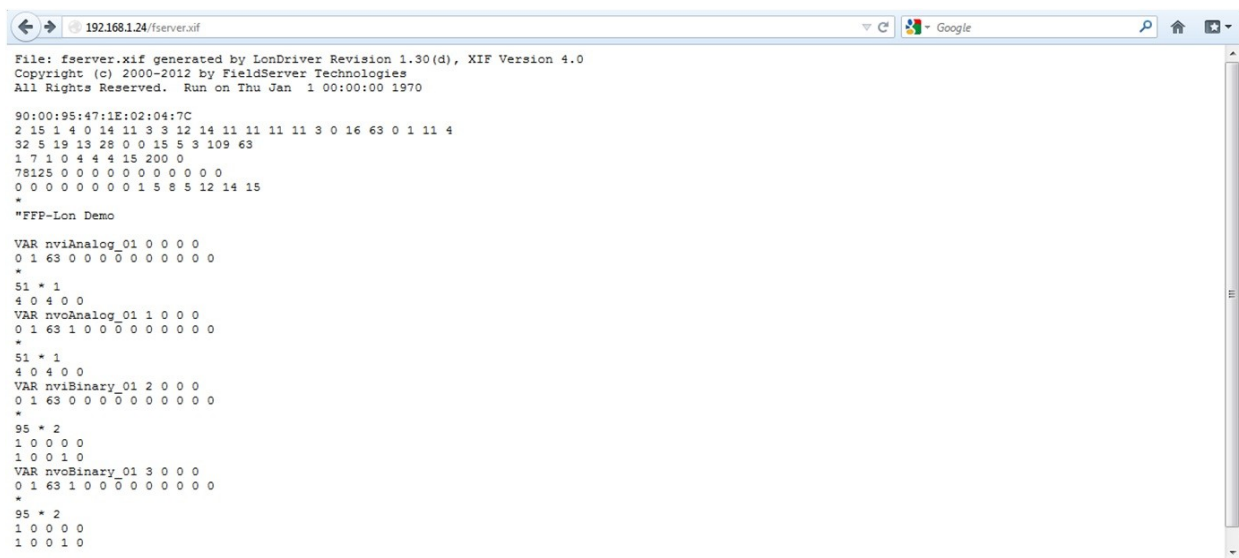

BACnet/Metasys N2 – Mapping

Mapping is identical for BACnet/IP and Metasys N2 and similar for BACnet MS/TP.

For all BACnet types, data types AI and BI are read-only, data types AV and BV are read/write. Units are used for AI/AV and text is used to enumerate active and inactive text for BI/BV.

For BACnet MS/TP only, the AI/AV/BI/BV addresses are preceded by the node ID for all devices other than the TS Series Lead/Lag Master. For example, address AI 1 would be AI 1001 for node 1 and AI 200001 for node 200. Addresses 100 and above work in the same manner. Address AI 101 would be AI 10101 for node 1 and AI 2000101 for node 200. For the TS Series Lead/Lag Master, the global variables will be AI/AV/BI/BV 1-99, boiler 1 variables will be AI/AV/BI/BV 101-199, continuing through boiler 8 variables which will be AI/AV/BI/BV 801-899. Connected TS Series Deaerator/Surge Tank devices will be AI/AV/BI/BV 901-999 and AI/AV/BI/BV 1001-1099. This is designated as **n** in the mapping for the node ID (Example: AI **n**10), **x** for the boiler ID (Example: AI **x**13).

For Metasys N2, data types AI (analog input) and BI (binary input) are read-only, data types AO and BO are read/write. Units and text are not used.

<pv unit> and <temp unit> refer to the dynamic parameters **pv_unit** and **temp_unit** assigned when configuring the devices.

Addresses marked with an asterisk (*) are EEPROM backed and should not be continuously written.

LMV5...

BACnet/Metasys N2 LMV5... Mapping
MS/TP addressing only: n = node ID

ADDRESS	DESCRIPTION	UNITS/TEXT	NOTES
AI n001	LMV PHASE	no units	see LMV Phases
AI n002	LMV FUEL ACTUATOR	angular degrees	
AI n003	LMV GAS ACTUATOR	angular degrees	
AI n004	LMV OIL ACTUATOR	angular degrees	
AI n005	LMV AIR ACTUATOR	angular degrees	
AI n006	LMV AUX1 ACTUATOR	angular degrees	
AI n007	LMV AUX2 ACTUATOR	angular degrees	
AI n008	LMV AUX3 ACTUATOR	angular degrees	
AI n009	LMV VSD OUTPUT	percent	
AI n010	LMV CURRENT FUEL	no units	0=gas/fuel0,1=oil/fuel1
AI n011	LMV CURRENT OUTPUT	percent	see Mapping Notes – Note 1
AI n012	LMV CURRENT SETPOINT	<pv unit>	
AI n013	LMV ACTUAL VALUE	<pv unit>	
AI n014	LMV FLAME SIGNAL	percent	
AI n015	LMV FUEL THROUGHPUT	no units	
AI n016	LMV CURRENT O2	percent	
AI n017	LMV GAS UNIT	no units	0=metric,1=standard
AI n018	LMV OIL UNIT	no units	0=metric,1=standard
AI n019	LMV TEMPERATURE UNIT	no units	0=metric,1=standard

BACnet/Metasys N2 LMV5... Mapping
MS/TP addressing only: n = node ID

ADDRESS	DESCRIPTION	UNITS/TEXT	NOTES
AI n020	LMV PRESSURE UNIT	no units	0=metric,1=standard
AI n021	LMV SENSOR SELECTION	no units	see Mapping Notes – Note 2
AI n022	LMV STARTUP COUNTER	no units	
AI n023	LMV HOUR COUNTER	no units	
AI n024	LMV CURRENT ERROR CODE	no units	see LMV5 Lockout/Error Codes
AI n025	LMV CURRENT DIAGNOSTIC CODE	no units	see LMV5 Lockout/Error Codes
AI n026	LMV CURRENT ERROR CLASS	no units	not used
AI n027	LMV CURRENT ERROR PHASE	no units	see LMV Phases
AI n028	LMV TEMP LIMIT OFF THRESHOLD	no units	
AI n029	LMV SUPPLY AIR TEMPERATURE	<temp unit>	
AI n030	LMV FLUE GAS TEMPERATURE	<temp unit>	
AI n031	LMV COMBUSTION EFFICIENCY	percent	
AI n032	LMV INPUT WORD	no units	word of bits
AI n033	LMV OUTPUT WORD	no units	word of bits
AV/AO n034*	LMV PROGRAM STOP	no units	see Mapping Notes – Note 3
AV/AO n035*	LMV LOAD CONTROL MODE	no units	see Mapping Notes – Note 4
AI n036	LMV MANUAL/AUTOMATIC	no units	0=auto,1=on,2=off
AV/AO n037	LMV MODBUS LOCAL/REMOTE	no units	0=local,1=remote
AV/AO n038*	LMV MODBUS WATCHDOG	seconds	
AV/AO n039	LMV MODBUS OPERATING MODE	no units	0=auto,1=on,2=off
AV/AO n040	LMV MODBUS SETPOINT W3	<pv unit>	
AV/AO n041	LMV MODBUS OUTPUT	no units	see Mapping Notes – Note 1
AV/AO n042*	LMV MODBUS FUEL SELECTION	no units	0=gas/fuel0,1=oil/fuel1
AV/AO n043*	LMV SETPOINT W1	<pv unit>	
AV/AO n044*	LMV SETPOINT W2	<pv unit>	
AI n045	LMV WEEKDAY	no units	0=Sun,1=Mon,...,6=Sat
AI n046	LMV YEAR 2-DIGIT	no units	
AI n047	LMV MONTH	no units	
AI n048	LMV DAY	no units	
AI n049	LMV HOUR	no units	
AI n050	LMV MINUTE	no units	
AI n051	LMV SECOND	no units	
AV/AO n052*	LMV HOURS RUN GAS RESET	hours	
AV/AO n053*	LMV HOURS RUN OIL S1 RESET	hours	
AV/AO n054*	LMV HOURS RUN OIL S2 RESET	hours	
AV/AO n055*	LMV HOURS RUN OIL S3 RESET	hours	
AV/AO n056*	LMV HOURS RUN TOTAL RESET	hours	
AI n057	LMV HOURS RUN TOTAL FIXED	hours	
AI n058	LMV HOURS CONNECTED TO POWER	hours	
AV/AO n059*	LMV STARTUPS GAS RESET	no units	
AV/AO n060*	LMV STARTUPS OIL RESET	no units	
AV/AO n061*	LMV STARTUPS TOTAL RESET	no units	
AI n062	LMV STARTUPS TOTAL FIXED	no units	
AV/AO n063*	LMV TOTAL VOLUME GAS	no units	
AV/AO n064*	LMV TOTAL VOLUME OIL	no units	
AI n065	LMV NUMBER OF LOCKOUTS	no units	
AI n066	LMV EXTRA TEMPERATURE SENSOR	<temp unit>	
AI n067	LMV AZL5 PARAMETER SET CODE	no units	

BACnet/Metasys N2 LMV5... Mapping
MS/TP addressing only: n = node ID

ADDRESS	DESCRIPTION	UNITS/TEXT	NOTES
AI n068	LMV AZL5 PARAMETER SET VER	no units	
AI n069	LMV AZL5 ID DATE YEAR 2-DIGIT	no units	
AI n070	LMV AZL5 ID DATE MONTH	no units	
AI n071	LMV AZL5 ID DATE DAY	no units	
AI n072	LMV AZL5 ID NUMBER	no units	
AI n073	LMV BC PARAMETER SET CODE	no units	
AI n074	LMV BC PARAMETER SET VER	no units	
AI n075	LMV BC ID DATE YEAR 2-DIGIT	no units	
AI n076	LMV BC ID DATE MONTH	no units	
AI n077	LMV BURNER CONTROL ID DATE DAY	no units	
AI n078	LMV BURNER CONTROL ID NUMBER	no units	
AI n079	LMV SOFTWARE VERSION AZL	no units	read in hexadecimal
AI n080	LMV SW VER BURNER CONTROL	no units	read in hexadecimal
AI n081	LMV SW VER LOAD CONTROL	no units	read in hexadecimal
AI n082	LMV MINIMUM OUTPUT GAS	percent	see Mapping Notes – Note 1
AI n083	LMV MAXIMUM OUTPUT GAS	percent	see Mapping Notes – Note 1
AI n084	LMV MINIMUM OUTPUT OIL	percent	see Mapping Notes – Note 1
AI n085	LMV MAXIMUM OUTPUT OIL	percent	see Mapping Notes – Note 1
AV/AO n086*	LMV LOAD LIMIT MODULATING	percent	see Mapping Notes – Note 1
AV/AO n087*	LMV LOAD LIMIT STAGING	no units	0=S1,1=S2,2=S3
AI n088	LMV TEMP LIMIT ON THRESHOLD	percent	-50% to 0%
AI n089	LMV RANGE TEMPERATURE SENSOR	no units	0=302F,1=752F,2=1562F
AI n090	LMV ADAPTION ACTIVE	no units	0=inactive,1=active
AI n091	LMV ADAPTION STATE	no units	
AV/AO n092	LMV START ADAPTION	no units	0=reset,1=start,2=abort
AV/AO n093*	LMV ADAPTION OUTPUT	percent	
AV/AO n094*	LMV P-VALUE	percent	
AV/AO n095*	LMV I-VALUE	seconds	
AV/AO n096*	LMV D-VALUE	seconds	
AI n097	LMV LOCKOUT ERROR CODE CURRENT	no units	see LMV5 Lockout/Error Codes
AI n098	LMV LOCKOUT DIAG CODE CURRENT	no units	see LMV5 Lockout/Error Codes
AI n099	LMV LOCKOUT ERR CLASS CURRENT	no units	not used
AI n0100	LMV LOCKOUT ERR PHASE CURRENT	no units	see LMV Phases
AI n0101	LMV LOCKOUT FUEL CURRENT	no units	0=gas/fuel0,1=oil/fuel1
AI n0102	LMV LOCKOUT OUTPUT CURRENT	percent	see Mapping Notes – Note 1
AI n0103	LMV LOCKOUT YEAR 2-DIG CURRENT	no units	
AI n0104	LMV LOCKOUT MONTH CURRENT	no units	
AI n0105	LMV LOCKOUT DAY CURRENT	no units	
AI n0106	LMV LOCKOUT HOUR CURRENT	no units	
AI n0107	LMV LOCKOUT MINUTE CURRENT	no units	
AI n0108	LMV LOCKOUT SECOND CURRENT	no units	
AI n0109	LMV LOCKOUT STARTUPS CURRENT	no units	
AI n0110	LMV LOCKOUT HOURS CURRENT	hours	
AI n0111	LMV ERROR ERROR CODE CURRENT	no units	see LMV5 Lockout/Error Codes
AI n0112	LMV ERROR DIAG CODE CURRENT	no units	see LMV5 Lockout/Error Codes
AI n0113	LMV ERROR ERROR CLASS CURRENT	no units	not used
AI n0114	LMV ERROR ERROR PHASE CURRENT	no units	see LMV Phases
AI n0115	LMV ERROR FUEL CURRENT	no units	0=gas/fuel0,1=oil/fuel1

BACnet/Metasys N2 LMV5... Mapping
MS/TP addressing only: n = node ID

ADDRESS	DESCRIPTION	UNITS/TEXT	NOTES
AI n0116	LMV ERROR OUTPUT CURRENT	percent	see Mapping Notes – Note 1
AI n0117	LMV ERROR STARTUPS CURRENT	no units	
BI n001	LMV CONTROLLER SWITCH	active/inactive	
BI n002	LMV FAN CONTACTOR	active/inactive	
BI n003	LMV OIL SELECTED	active/inactive	
BI n004	LMV GAS SELECTED	active/inactive	
BI n005	LMV OIL PRESS SW MAX	active/inactive	
BI n006	LMV OIL PRESS SW MIN	active/inactive	
BI n007	LMV VALVE PROVING SW	active/inactive	
BI n008	LMV SAFETY LOOP	active/inactive	
BI n009	LMV GAS PRESS SW MIN	active/inactive	
BI n010	LMV GAS PRESS SW MAX	active/inactive	
BI n011	LMV AIR PRESSURE SW	active/inactive	
BI n012	LMV START RELEASE OIL	active/inactive	
BI n013	LMV HEAVY OIL START	active/inactive	
BI n014	LMV ALARM	active/inactive	
BI n015	LMV IGNITION	active/inactive	
BI n016	LMV START SIGNAL	active/inactive	
BI n017	LMV FAN OUTPUT	active/inactive	
BI n018	LMV OIL PUMP	active/inactive	
BI n019	LMV FUEL VALVE SV OIL	active/inactive	
BI n020	LMV FUEL VALVE V1 OIL	active/inactive	
BI n021	LMV FUEL VALVE V2 OIL	active/inactive	
BI n022	LMV FUEL VALVE V3 OIL	active/inactive	
BI n023	LMV FUEL VALVE SV GAS	active/inactive	
BI n024	LMV FUEL VALVE V1 GAS	active/inactive	
BI n025	LMV FUEL VALVE V2 GAS	active/inactive	
BI n026	LMV FUEL VALVE PV GAS	active/inactive	

BACnet/Metasys N2 – Mapping (continued)**LMV3...****BACnet/Metasys N2 LMV3... Mapping**
MS/TP addressing only: n = node ID

ADDRESS	DESCRIPTION	UNITS/TEXT	NOTES
AI n001	LMV PHASE	no units	see LMV Phases
AI n002	LMV FUEL ACTUATOR	angular degrees	
AI n003	LMV AIR ACTUATOR	angular degrees	
AI n004	LMV VSD OUTPUT	percent	
AI n005	LMV CURRENT FUEL	no units	0=gas/fuel0,1=oil/fuel1
AI n006	LMV CURRENT OUTPUT	percent	see Mapping Notes – Note 1
AI n007	LMV FLAME SIGNAL	percent	
AI n008	LMV FUEL THROUGHPUT	no units	
AI n009	LMV STARTUP COUNTER	no units	
AI n010	LMV CURRENT ERROR CODE	no units	see LMV3 Error Codes
AI n011	LMV CURRENT DIAGNOSTIC CODE	no units	see LMV3 Error Codes
AI n012	LMV CURRENT ERROR CLASS	no units	not used
AI n013	LMV CURRENT ERROR PHASE	no units	see LMV Phases
AI n014	LMV INPUT WORD	no units	word of bits
AI n015	LMV OUTPUT WORD	no units	word of bits
AV/AO n016*	LMV PROGRAM STOP	no units	see Mapping Notes – Note 3
AV/AO n017	LMV MODBUS LOCAL/REMOTE	no units	0=local,1=remote
AV/AO n018*	LMV MODBUS WATCHDOG	seconds	
AV/AO n019	LMV MODBUS OPERATING MODE	no units	0=auto,1=on,2=off
AV/AO n020	LMV MODBUS OUTPUT	no units	see Mapping Notes – Note 1
AV/AO n021*	LMV HOURS RUN FUEL 0 RESET	hours	
AV/AO n022*	LMV HOURS RUN FUEL 1 RESET	hours	
AI n023	LMV HOURS CONNECTED TO POWER	hours	
AV/AO n024*	LMV STARTUPS FUEL 0 RESET	no units	
AV/AO n025*	LMV STARTUPS FUEL 1 RESET	no units	
AI n026	LMV STARTUPS TOTAL FIXED	no units	
AV/AO n027*	LMV TOTAL VOLUME FUELO	no units	
AV/AO n028*	LMV TOTAL VOLUME FUEL1	no units	
AI n029	LMV NUMBER OF LOCKOUTS	no units	
AV/AO n030*	LMV PRESELECTED OUTPUT FUEL 0	no units	see Mapping Notes – Note 1
AV/AO n031*	LMV PRESELECTED OUTPUT FUEL 1	no units	see Mapping Notes – Note 1
AI n32	LMV BC PARAMETER SET CODE	no units	
AI n033	LMV BC PARAMETER SET VER	no units	
AI n034	LMV BC ID DATE YEAR 2-DIGIT	no units	
AI n035	LMV BC ID DATE MONTH	no units	
AI n036	LMV BURNER CONTROL ID DATE DAY	no units	
AI n037	LMV BURNER CONTROL ID NUMBER	no units	
AI n038	LMV SW VER BURNER CONTROL	no units	read in hexadecimal
AI n039	LMV MINIMUM OUTPUT FUEL 0	percent	see Mapping Notes – Note 1
AI n040	LMV MAXIMUM OUTPUT FUEL 0	percent	see Mapping Notes – Note 1
AI n041	LMV MINIMUM OUTPUT FUEL 1	percent	see Mapping Notes – Note 1
AI n042	LMV MAXIMUM OUTPUT FUEL 1	percent	see Mapping Notes – Note 1
AI n043	LMV OPERATION FUEL 0	no units	see Mapping Notes – Note 7
AI n044	LMV OPERATION FUEL 1	no units	see Mapping Notes – Note 7

BACnet/Metasys N2 LMV3... Mapping
MS/TP addressing only: n = node ID

ADDRESS	DESCRIPTION	UNITS/TEXT	NOTES
AI n045	LMV REVERT TO PILOT CYCLES	no units	
AI n046	LMV OPERATION FUEL 0 NEW	no units	see Mapping Notes – Note 7
AI n047	LMV OPERATION FUEL 1 NEW	no units	see Mapping Notes – Note 7
AI n048	LMV REVERT TO PILOT CYCLES NEW	no units	
AI n049	LMV LOW TRIM FUEL 0	percent	
AI n050	LMV HIGH TRIM FUEL 0	percent	
AI n051	LMV LOW TRIM FUEL 1	percent	
AI n052	LMV HIGH TRIM FUEL 1	percent	
AI n053	LMV ANALOG INPUT TRIM	percent	
AI n054	LMV CURRENT TRIM	percent	
AI n055	LMV ABSOLUTE SPEED	RPM	
AI n056	LMV MAINS VOLTAGE	volts	
AI n057	LMV ERROR ERROR CODE CURRENT	no units	see LMV3 Error Codes
AI n058	LMV ERROR DIAG CODE CURRENT	no units	see LMV3 Error Codes
AI n059	LMV ERROR ERROR CLASS CURRENT	no units	not used
AI n060	LMV ERROR ERROR PHASE CURRENT	no units	
AI n061	LMV ERROR FUEL CURRENT	no units	0=gas/fuel0,1=oil/fuel1
AI n062	LMV ERROR OUTPUT CURRENT	no units	see Mapping Notes – Note 1
AI n063	LMV ERROR STARTUPS CURRENT	no units	
BI n001	LMV CONTROLLER SWITCH	active/inactive	
BI n002	LMV VALVE PROVING SW	active/inactive	
BI n003	LMV SAFETY LOOP	active/inactive	
BI n004	LMV GAS PRESS SW MIN	active/inactive	
BI n005	LMV GAS PRESS SW MAX	active/inactive	
BI n006	LMV AIR PRESSURE SW	active/inactive	
BI n007	LMV ALARM	active/inactive	
BI n008	LMV IGNITION	active/inactive	
BI n009	LMV FAN OUTPUT	active/inactive	
BI n010	LMV FUEL VALVE V1	active/inactive	
BI n011	LMV FUEL VALVE V2	active/inactive	
BI n012	LMV FUEL VALVE V3/PV	active/inactive	

BACnet/Metasy N2 – Mapping (continued)

LME7...

BACnet/Metasy N2 LME7... Mapping
MS/TP addressing only: n = node ID

ADDRESS	DESCRIPTION	UNITS/TEXT	NOTES
AI n001	PHASE	no units	see LME7 Phases
AI n002	FLAME PERCENT LME71/LME73	percent	
AI n003	MAINS VOLTAGE	volts	
AI n004	STARTUPS RESETTABLE	no units	
AI n005	STARTUPS TOTAL	no units	
AI n006	RELAY K12 CYCLES	no units	
AI n007	RELAY K11 CYCLES	no units	
AI n008	RELAY K2 CYCLES	no units	
AI n009	RELAY K1 CYCLES	no units	
AI n010	MAX RELAY CYCLES	no units	
AI n011	CURRENT OUTPUT PERCENT	percent	> 100 is stages (101=S1, 102=S2)
AI n012	ACTUATOR ACTUAL PERCENT	percent	65535 (-1) = not optioned
AI n013	ACTUATOR TARGET PERCENT	percent	65535 (-1) = not optioned
AI n014	EXT LOAD CONTROLLER PERCENT	percent	65535 (-1) = not optioned
AI n015	FAN SPEED RPM	RPM	65535 (-1) = not optioned
AI n016	FAN SPEED PERCENT	percent	65535 (-1) = not optioned
AI n017	TARGET FAN SPEED PERCENT	percent	65535 (-1) = not optioned
AI n018	PWM SIGNAL PERCENT	percent	65535 (-1) = not optioned
AI n019	FLAME 1 PERCENT LME75	percent	
AI n020	FLAME 2 PERCENT LME75	percent	
AI n021	CURRENT ERROR CODE	no units	see LME7 Error Codes
AI n022	CURRENT ERROR STARTUPS	no units	
AI n023	CURRENT ERROR PHASE	no units	see LME7 Phases
AI n024	CURRENT ERROR LOAD	percent	
AI n025	HISTORY 1 ERROR CODE	no units	see LME7 Error Codes
AI n026	HISTORY 1 ERROR STARTUPS	no units	
AI n027	HISTORY 1 ERROR PHASE	no units	see LME7 Phases
AI n028	HISTORY 1 ERROR LOAD	percent	
AI n029	HISTORY 2 ERROR CODE	no units	see LME7 Error Codes
AI n030	HISTORY 2 ERROR STARTUPS	no units	
AI n031	HISTORY 2 ERROR PHASE	no units	see LME7 Phases
AI n032	HISTORY 2 ERROR LOAD	percent	
AI n033	HISTORY 3 ERROR CODE	no units	see LME7 Error Codes
AI n034	HISTORY 3 ERROR STARTUPS	no units	
AI n035	HISTORY 3 ERROR PHASE	no units	see LME7 Phases
AI n036	HISTORY 3 ERROR LOAD	percent	
AI n037	HISTORY 4 ERROR CODE	no units	see LME7 Error Codes
AI n038	HISTORY 4 ERROR STARTUPS	no units	
AI n039	HISTORY 4 ERROR PHASE	no units	see LME7 Phases
AI n040	HISTORY 4 ERROR LOAD	percent	
AI n041	HISTORY 5 ERROR CODE	no units	see LME7 Error Codes
AI n042	HISTORY 5 ERROR STARTUPS	no units	
AI n043	HISTORY 5 ERROR PHASE	no units	see LME7 Phases
AI n044	HISTORY 5 ERROR LOAD	percent	

BACnet/Metasys N2 LME7... Mapping
MS/TP addressing only: n = node ID

ADDRESS	DESCRIPTION	UNITS/TEXT	NOTES
AI n045	HISTORY 6 ERROR CODE	no units	see LME7 Error Codes
AI n046	HISTORY 6 ERROR STARTUPS	no units	
AI n047	HISTORY 6 ERROR PHASE	no units	see LME7 Phases
AI n048	HISTORY 6 ERROR LOAD	percent	
AI n049	HISTORY 7 ERROR CODE	no units	see LME7 Error Codes
AI n050	HISTORY 7 ERROR STARTUPS	no units	
AI n051	HISTORY 7 ERROR PHASE	no units	see LME7 Phases
AI n052	HISTORY 7 ERROR LOAD	percent	
AI n053	HISTORY 8 ERROR CODE	no units	see LME7 Error Codes
AI n054	HISTORY 8 ERROR STARTUPS	no units	
AI n055	HISTORY 8 ERROR PHASE	no units	see LME7 Phases
AI n056	HISTORY 8 ERROR LOAD	percent	
AI n057	HISTORY 9 ERROR CODE	no units	see LME7 Error Codes
AI n058	HISTORY 9 ERROR STARTUPS	no units	
AI n059	HISTORY 9 ERROR PHASE	no units	see LME7 Phases
AI n060	HISTORY 9 ERROR LOAD	percent	
AI n061	HISTORY 10 ERROR CODE	no units	see LME7 Error Codes
AI n062	HISTORY 10 ERROR STARTUPS	no units	
AI n063	HISTORY 10 ERROR PHASE	no units	see LME7 Phases
AI n064	HISTORY 10 ERROR LOAD	percent	
BI n001	SAFETY LIMIT (SK)	active/inactive	TERMINAL X3.04.1
BI n002	PROOF OF CLOSURE (POC)	active/inactive	TERMINAL X2.02.4
BI n003	PRESS SW VALVE PROVING (P LT)	active/inactive	TERMINAL X9.04.2
BI n004	LOW GAS PRESSURE SWITCH (Pmin)	active/inactive	TERMINAL X5.01.2
BI n005	CONTROL SWITCH (ON/OFF)	active/inactive	TERMINAL X5.03.1
BI n006	COMBUSTION AIR SWITCH (LP)	active/inactive	TERMINAL X3.02.1
BI n007	RESET TERMINAL (EK2)	active/inactive	TERMINAL X2.03.1
BI n008	INCREASE MODULATION (LR-OPEN)	active/inactive	TERMINAL X5.03.3
BI n009	DECREASE MODULATION (LR-CLOSED)	active/inactive	TERMINAL X5.03.2
BI n010	ACTUATOR FEEDBACK (SA-R)	active/inactive	TERMINAL X2.09.4
BI n011	RESET BUTTON LME	active/inactive	
BI n012	FLAME PRESENT LME71/LME73 FLAME 1 PRESENT LME75	active/inactive	
BI n013	ALARM (AL)	active/inactive	TERMINAL X2.03.3
BI n014	NO COMM TO LME	active/inactive	STATUS FROM OCI417
BI n015	FLAME 2 PRESENT LME75	active/inactive	
BI n016	SAFETY VALVE (SV)	active/inactive	TERMINAL X6.03.3
BI n017	ACTUATOR LOW-FIRE (SA-KL)	active/inactive	TERMINAL X2.09.2
BI n018	ACTUATOR HIGH-FIRE (SA-NL)	active/inactive	TERMINAL X2.09.3
BI n019	PILOT VALVE (PV)	active/inactive	TERMINAL X7.01.3
BI n020	IGNITION (Z)	active/inactive	TERMINAL X4.02.3
BI n021	FAN (M)	active/inactive	TERMINAL X2.01.3
BI n022	VALVE 1 (V2)	active/inactive	TERMINAL X7.02.3
BI n023	VALVE 2 (V1)	active/inactive	TERMINAL X7.04.4
BI n024	PRESS SW VALVE PROVING (P LT)	active/inactive	TERMINAL X9.04.2
BI n025	VALVE PROVING ENABLE (LT) HIGH GAS PRESSURE SWITCH (Pmax) PROOF OF CLOSURE (POC)	active/inactive	TERMINAL X2.02.4

BACnet/Metasys N2 LME7... Mapping
MS/TP addressing only: n = node ID

ADDRESS	DESCRIPTION	UNITS/TEXT	NOTES
BI n026	INCREASE MODULATION (LR-OPEN)	active/inactive	TERMINAL X5.03.3
BI n027	DECREASE MODULATION (LR-CLOSED)	active/inactive	TERMINAL X5.03.2
BI n028	COMBUSTION AIR SWITCH (LP)	active/inactive	TERMINAL X3.02.1
BI n029	LOW GAS PRESSURE SWITCH (Pmin)	active/inactive	TERMINAL X5.01.2
BI n030	RESET BUTTON LME	active/inactive	
BI n031	RESET TERMINAL (EK2)	active/inactive	TERMINAL X2.03.1
BI n032	ACTUATOR FEEDBACK (SA-R)	active/inactive	TERMINAL X2.09.4
BI n033	SAFETY LIMIT (SK)	active/inactive	TERMINAL X3.04.1
BI n034	CONTROL SWITCH (ON/OFF)	active/inactive	TERMINAL X5.03.1
BI n035	INPUT CAMS (SA-ZL)	active/inactive	TERMINAL X2.09.8

BACnet/Metasys N2 – Mapping (continued)

RWF10

BACnet/Metasys N2 RWF10 Mapping
MS/TP addressing only: n = node ID

ADDRESS	DESCRIPTION	UNITS/TEXT	NOTES
AI n001	PROCESS VARIABLE	<pv unit>	
AI n002	STATUS WORD	no units	
AI n003	ANALOG OUTPUT	percent	
AV/AO n004	CURRENT SETPOINT	<pv unit>	
AV/AO n005	SETPOINT ALARM 1	no units	
AV/AO n006	SETPOINT ALARM 2	no units	
AV/AO n007	PROPORTIONAL BAND	no units	
AV/AO n008	INTEGRAL TIME	no units	
AV/AO n009	DERIVATIVE TIME	no units	
AV/AO n010	HYSTERESIS ALARM 1	no units	
AV/AO n011	HYSTERESIS ALARM 2	no units	
BI n001	OUTPUT ALARM 1 BURNER	active/inactive	
BI n002	OUTPUT ALARM 2 LF HOLD	active/inactive	

BACnet/Metasys N2 – Mapping (continued)RWF55

BACnet/Metasys N2 RWF55 Mapping
MS/TP addressing only: n = node ID

ADDRESS	DESCRIPTION	UNITS/TEXT	NOTES
AI n001	INPUT 1 X1	<pv unit>	
AI n002	INPUT 2 X2	no units	
AI n003	INPUT 3 X3	<temp unit>	
AI n004	CURRENT SETPOINT WR	<pv unit>	
AV/AO n005	FIRST SETPOINT SP1	<pv unit>	
AV/AO n006	SECOND SETPOINT SP2	<pv unit>	
AV/AO n007	REMOTE OPERATING MODE REM	no units	
AV/AO n008	REMOTE MODE OFF ROFF	no units	
AV/AO n009	REMOTE ON HYSTERESIS RHYS1	<pv unit>	
AV/AO n010	REMOTE OFF HYST BOTTOM RHYS2	<pv unit>	
AV/AO n011	REMOTE OFF HYST TOP RHYS3	<pv unit>	
AV/AO n012	REMOTE SETPOINT SPR	<pv unit>	
AV/AO n013	REMOTE BURNER OUTPUT RK1	no units	
AV/AO n014	REMOTE K2 OUTPUT RK2	no units	
AV/AO n015	REMOTE K3 OUTPUT RK3	no units	
AV/AO n016	REMOTE K6 OUTPUT RK6	no units	
AV/AO n017	REMOTE STAGE MODE RSTEP	no units	
AV/AO n018	REMOTE OUTPUT RY	percent	
AV/AO n019	REM ON HYST COOLING RHYS4	<pv unit>	
AV/AO n020	REM OFF HYST BTM COOLING RHYS5	<pv unit>	
AV/AO n021	REM OFF HYST TOP COOLING RHYS6	<pv unit>	
AI n022	INPUT 3 UNFILTERED TEMP	<temp unit>	
AI n023	ACTUAL OUTPUT Y	percent	
AI n024	BURNER ALARM	no units	
AV/AO n025	RAMP FUNCTION FnCt	no units	
AV/AO n026	RAMP SLOPE rASL	no units	
AV/AO n027	TOLERANCE BAND RAMP toLP	no units	
AV/AO n028	LIMIT VALUE rAL	<pv unit>	
AV/AO n029	ALARM RELAY FUNCTION FnAL	no units	
AV/AO n030	ALARM LIMIT COMPARATOR AL	<pv unit>	
AV/AO n031	HYSTERESIS LIMIT COMP HYST	<pv unit>	
AV/AO n032	MODBUS WATCHDOG dtt	seconds	
AV/AO n033	FILTER INPUT 1 dF1	seconds	
AV/AO n034	FILTER INPUT 2 dF2	seconds	
AV/AO n035	FILTER INPUT 3 dF3	seconds	
AI n036	ACTUAL VALUE LIMIT LOW oLLo	<pv unit>	
AI n037	ACTUAL VALUE LIMIT HIGH oLHi	<pv unit>	
AV/AO n038	PROPORTIONAL BAND Pb1	<pv unit>	
AV/AO n039	DERIVATIVE ACTION TIME dt	seconds	
AV/AO n040	INTEGRAL ACTION TIME rt	seconds	
AV/AO n041	DEAD BAND db	<pv unit>	
AV/AO n042	ACTUATOR RUNNING TIME tt	seconds	
AV/AO n043	ON HYSTERESIS HYS1	<pv unit>	
AV/AO n044	OFF HYSTERESIS BOTTOM HYS2	<pv unit>	

BACnet/Metasys N2 RWF55 Mapping
MS/TP addressing only: n = node ID

ADDRESS	DESCRIPTION	UNITS/TEXT	NOTES
AV/AO n045	OFF HYSTERESIS TOP HYS3	<pv unit>	
AV/AO n046	ON HYST COOLING HYS4	<pv unit>	
AV/AO n047	OFF HYST BTM COOLING HYS5	<pv unit>	
AV/AO n048	OFF HYST TOP COOLING HYS6	<pv unit>	
AV/AO n049	REACTION THRESHOLD q	<pv unit>	
AV/AO n050	OUTSIDE TEMPERATURE 1 At1	<temp unit>	
AV/AO n051	BOILER TEMPERATURE 1 Ht1	<temp unit>	
AV/AO n052	OUTSIDE TEMPERATURE 2 At2	<temp unit>	
AV/AO n053	BOILER TEMPERATURE 2 Ht2	<temp unit>	
AV/AO n054	INPUT 1 SCALE LOW SCL1	<pv unit>	
AV/AO n055	INPUT 1 SCALE HIGH SCH1	<pv unit>	
AV/AO n056	OFFSET INPUT 1 OFF1	<pv unit>	
AV/AO n057	INPUT 2 SCALE LOW SCL2	no units	
AV/AO n058	INPUT 2 SCALE HIGH SCH2	no units	
AV/AO n059	OFFSET INPUT 2 OFF2	no units	
AV/AO n060	OFFSET INPUT 3 OFF3	<temp unit>	
AV/AO n061	SETPOINT LIMIT SCALE LOW SPL	<pv unit>	
AV/AO n062	SETPOINT LIMIT SCALE HIGH SPH	<pv unit>	
BI n001	INPUT 1 FAULT	active/inactive	
BI n002	INPUT 2 FAULT	active/inactive	
BI n003	INPUT 3 FAULT	active/inactive	
BI n004	STAGE MODE	active/inactive	
BI n005	MANUAL OPERATION	active/inactive	
BI n006	BINARY INPUT 1	active/inactive	
BI n007	BINARY INPUT 2	active/inactive	
BI n008	STAT ACTIVE	active/inactive	
BI n009	UP ACTIVE	active/inactive	
BI n010	DOWN ACTIVE	active/inactive	
BI n011	K6 ACTIVE	active/inactive	

BACnet/Metasys N2 – Mapping (continued)

TS Series Hardwired Draft Control

BACnet/Metasys N2 TS Series Hardwired Draft Control Mapping
MS/TP addressing only: n = node ID

ADDRESS	DESCRIPTION	UNITS/TEXT	NOTES
AV/AO n001	SETPPOINT	inches water	
AV/AO n002	HYSTERESIS	inches water	
AI n003	DAMPER POSITION	angular degrees	
AI n004	CONTROL PHASE	no units	see Mapping Notes – Note 8
AV/AO n005	SENSOR MIN	inches water	
AV/AO n006	SENSOR MAX	inches water	
AV/AO n007	SENSOR TYPE	no units	see Mapping Notes – Note 9
AV/AO n008	SENSOR FILTER TIME	seconds	
AV/AO n009	DRIVE MIN	angular degrees	
AV/AO n010	DRIVE MAX	angular degrees	
AV/AO n011	PULSE ON	seconds	
AV/AO n012	PULSE OFF	seconds	
AV/AO n013	CLOSE TIMER SP	seconds	
AV/AO n014	PERMISSIVE TIMER SP	seconds	
AV/AO n015	IGNITION TIMER SP	seconds	
AV/AO n016	REL MOD TIMER SP	seconds	
AV/AO n017	POSTPURGE TIMER SP	seconds	
AI n018	CLOSE TIMER	seconds	
AI n019	PERMISSIVE TIMER	seconds	
AI n020	IGNITION TIMER	seconds	
AI n021	REL MOD TIMER	seconds	
AI n022	POSTPURGE TIMER	seconds	
BI n001	DAMPER CLOSED	active/inactive	
BI n002	DAMPER OPEN	active/inactive	
BI n003	DAMPER IGNITION	active/inactive	
BI n004	CALL FOR HEAT	active/inactive	
BI n005	FUEL VALVE OPEN	active/inactive	
BI n006	BLOWER RUNNING	active/inactive	
BI n007	FSG ALARM	active/inactive	
BI n008	LOW DRAFT	active/inactive	
BI n009	HIGH FIRE PURGE	active/inactive	
BI n010	PERMISSIVE	active/inactive	
BI n011	DRIVE IGNITION	active/inactive	
BI n012	DRIVE OPEN	active/inactive	
BI n013	DRIVE CLOSED	active/inactive	

BACnet/Metasys N2 – Mapping (continued)

TS Series Deaerator/Surge Tank

This mapping applies to either standalone applications or as part of a TS Series Lead/Lag Master.

BACnet/Metasys N2 TS Series Deaerator/Surge Tank Mapping

MS/TP addressing only: n = node ID for standalone, 9 when DA/ST-1 via LLM, 10 when DA/ST-2 via LLM

ADDRESS	DESCRIPTION	UNITS/TEXT	NOTES
AI n001	P1 HOA	no units	
AI n002	P2 HOA	no units	
AI n003	P3 HOA	no units	
AI n004	P4 HOA	no units	
AI n005	P5 HOA	no units	
AI n006	P6 HOA	no units	
AI n007	DA RWF WTR LEVEL E1	inches water	
AI n008	DA RWF WTR LEVEL E2	no units	
AI n009	DA RWF WTR LEVEL SP WR	inches water	
AI n010	DA RWF WTR LEVEL PCT Y	percent	
AI n011	SRG RWF WTR LEVEL E1	inches water	
AI n012	SRG RWF WTR LEVEL E2	no units	
AI n013	SRG RWF WTR LEVEL SP WR	inches water	
AI n014	SRG RWF WTR LEVEL PCT Y	percent	
AI n015	STEAM RWF PRS E1	PSI	
AI n016	STEAM RWF PRS E2	no units	
AI n017	STEAM RWF PRS SP WR	PSI	
AI n018	STEAM RWF PRS PCT Y	percent	
AI n019	BU DA WTR LEVEL E1	inches water	
AI n020	BU DA WTR LEVEL E2	no units	
AI n021	BU DA WTR LEVEL SP WR	inches water	
AI n022	BU DA WTR LEVEL PCT Y	percent	
AI n023	BU SRG WTR LEVEL E1	inches water	
AI n024	BU SRG WTR LEVEL E2	no units	
AI n025	BU SRG WTR LEVEL SP WR	inches water	
AI n026	BU SRG WTR LEVEL PCT Y	percent	
AI n027	P1 RUN HOURS	hours	
AI n028	P2 RUN HOURS	hours	
AI n029	P3 RUN HOURS	hours	
AI n030	P4 RUN HOURS	hours	
AI n031	P5 RUN HOURS	hours	
AI n032	P6 RUN HOURS	hours	
AI n033	RTD 1	<temp unit>	
AI n034	RTD 2	<temp unit>	
AI n035	RTD 3	<temp unit>	
AI n036	RTD 4	<temp unit>	
AI n037	ANALOG INPUT 1	no units	
AI n038	ANALOG INPUT 2	no units	
AI n039	ANALOG INPUT 3	no units	
AI n040	ANALOG INPUT 4	no units	
AI n041	ANALOG INPUT 5	no units	
AI n042	ANALOG INPUT 6	no units	
AI n043	ANALOG INPUT 7	no units	

BACnet/Metasys N2 TS Series Deaerator/Surge Tank Mapping

MS/TP addressing only: n = node ID for standalone, 9 when DA/ST-1 via LLM, 10 when DA/ST-2 via LLM

ADDRESS	DESCRIPTION	UNITS/TEXT	NOTES
AI n044	ANALOG INPUT 8	no units	
AI n045	ANALOG OUTPUT 1	no units	
AI n046	ANALOG OUTPUT 2	no units	
AI n047	ANALOG OUTPUT 3	no units	
AI n048	ANALOG OUTPUT 4	no units	
AI n049	ANALOG OUTPUT 5	no units	
AI n050	ANALOG OUTPUT 6	no units	
AI n051	ANALOG OUTPUT 7	no units	
AI n052	ANALOG OUTPUT 8	no units	
AI n053	DA SETPOINT MSC	PSI	
AI n054	DA FW PRESSURE MSC	PSI	
AI n055	DA DROP PUMP MSC	PSI	
AI n056	DA ADD PUMP MSC	PSI	
AI n057	DA SETPOINT VFD	PSI	
AI n058	DA FW PRESSURE CH4 VFD	PSI	
AI n059	DA FW PRESSURE OFFSET VFD	PSI	
AI n060	DA DROP PUMP VFD	percent	
AI n061	DA ADD PUMP VFD	percent	
AI n062	DA START DELAY	seconds	
AI n063	DA STOP DELAY	seconds	
AI n064	DA MIN RUN TIME	seconds	
AI n065	DA OVERLAP TIME	seconds	
AI n066	DA ALTERNATION TIME	hours	
AI n067	SRG SETPOINT MSC	PSI	
AI n068	SRG FW PRESSURE MSC	PSI	
AI n069	SRG DROP PUMP MSC	PSI	
AI n070	SRG ADD PUMP MSC	PSI	
AI n071	SRG SETPOINT VFD	PSI	
AI n072	SRG FW PRESSURE CH4 VFD	PSI	
AI n073	SRG FW PRESSURE OFFSET VFD	PSI	
AI n074	SRG DROP PUMP VFD	percent	
AI n075	SRG ADD PUMP VFD	percent	
AI n076	SRG START DELAY	seconds	
AI n077	SRG STOP DELAY	seconds	
AI n078	SRG MIN RUN TIME	seconds	
AI n079	SRG OVERLAP TIME	seconds	
AI n080	SRG ALTERNATION TIME	hours	
AI n081	P1 MANUAL VFD	percent	
AI n082	P2 MANUAL VFD	percent	
AI n083	P3 MANUAL VFD	percent	
AI n084	P4 MANUAL VFD	percent	
AI n085	P5 MANUAL VFD	percent	
AI n086	P6 MANUAL VFD	percent	
AI n087	CT LEAD START DELAY	seconds	
AI n088	CT LAG START DELAY	seconds	
AI n089	CT TIMED LEAD START	seconds	
AI n090	CT TIMED LAG START	seconds	
BI n001	LEAD LAG STATUS	disabled/enabled	

BACnet/Metasys N2 TS Series Deaerator/Surge Tank Mapping

MS/TP addressing only: n = node ID for standalone, 9 when DA/ST-1 via LLM, 10 when DA/ST-2 via LLM

ADDRESS	DESCRIPTION	UNITS/TEXT	NOTES
BI n002	DA HIGH WATER	normal/warning	
BI n003	DA LOW WATER	running/warning	
BI n004	DA LOW LOW WATER	running/alarm	
BI n005	SRG HIGH WATER	running/warning	
BI n006	SRG LOW WATER	running/warning	
BI n007	SRG LOW LOW WATER	running/alarm	
BI n008	CT LAG START	on/off	
BI n009	CT LEAD START	on/off	
BI n010	CT LEAD LAG STATUS	normal/stopped	
BI n011	P1 PROVEN	on/off	
BI n012	P2 PROVEN	on/off	
BI n013	P3 PROVEN	on/off	
BI n014	P4 PROVEN	on/off	
BI n015	P5 PROVEN	on/off	
BI n016	P6 PROVEN	on/off	
BI n017	P1 FAIL	alarm/normal	
BI n018	P2 FAIL	alarm/normal	
BI n019	P3 FAIL	alarm/normal	
BI n020	P4 FAIL	alarm/normal	
BI n021	P5 FAIL	alarm/normal	
BI n022	P6 FAIL	alarm/normal	
BI n023	CT LEAD PUMP START	on/off	
BI n024	CT LAG PUMP START	on/off	
BI n025	CT TIMED LEAD START	disabled/enabled	
BI n026	CT TIMED LAG START	disabled/enabled	

BACnet/Metasys N2 – Mapping (continued)

TS Series Touchscreen Kit

BACnet/Metasys N2 TS Series Touchscreen Kit Mapping
MS/TP addressing only: n = node ID

ADDRESS	DESCRIPTION	UNITS/TEXT	NOTES
AI n001	LMV PHASE	no units	see LMV Phases
AI n002	LMV FUEL ACTUATOR	angular degrees	
AI n003	LMV GAS ACTUATOR	angular degrees	
AI n004	LMV OIL ACTUATOR	angular degrees	
AI n005	LMV AIR ACTUATOR	angular degrees	
AI n006	LMV AUX1 ACTUATOR	angular degrees	
AI n007	LMV AUX2 ACTUATOR	angular degrees	
AI n008	LMV AUX3 ACTUATOR	angular degrees	
AI n009	LMV VSD OUTPUT	percent	
AI n010	LMV CURRENT FUEL	no units	0=gas/fuel0,1=oil/fuel1
AI n011	LMV CURRENT OUTPUT	percent	see Mapping Notes – Note 1
AI n012	LMV CURRENT SETPOINT	<pv unit>	
AI n013	LMV ACTUAL VALUE	<pv unit>	
AI n014	LMV FLAME SIGNAL	percent	
AI n015	LMV FUEL THROUGHPUT	no units	
AI n016	LMV CURRENT O2	percent	
AI n017	LMV GAS UNIT	no units	0=metric,1=standard
AI n018	LMV OIL UNIT	no units	0=metric,1=standard
AI n019	LMV TEMPERATURE UNIT	no units	0=metric,1=standard
AI n020	LMV PRESSURE UNIT	no units	0=metric,1=standard
AI n021	LMV SENSOR SELECTION	no units	see Mapping Notes – Note 2
AI n022	LMV STARTUP COUNTER	no units	
AI n023	LMV HOUR COUNTER	no units	
AI n024	LMV CURRENT ERROR CODE	no units	see LMV... Lockout/Error Codes
AI n025	LMV CURRENT DIAGNOSTIC CODE	no units	see LMV... Lockout/Error Codes
AI n026	LMV CURRENT ERROR CLASS	no units	not used
AI n027	LMV CURRENT ERROR PHASE	no units	see LMV Phases
AI n028	LMV TEMP LIMIT OFF THRESHOLD	no units	
AI n029	LMV SUPPLY AIR TEMPERATURE	<temp unit>	
AI n030	LMV FLUE GAS TEMPERATURE	<temp unit>	
AI n031	LMV COMBUSTION EFFICIENCY	percent	
AI n032	LMV CURRENT CO2	percent	
AI n033	LMV CURRENT EXCESS AIR	percent	
AI n034	LMV INPUT WORD	no units	word of bits
AI n035	LMV OUTPUT WORD	no units	word of bits
AV/AO n036*	LMV PROGRAM STOP	no units	see Mapping Notes – Note 3
AV/AO n037*	LMV LOAD CONTROL MODE	no units	see Mapping Notes – Note 4
AI n038	LMV MANUAL/AUTOMATIC	no units	0=auto,1=on,2=off
AV/AO n039	LMV MODBUS LOCAL/REMOTE	no units	0=local,1=remote
AV/AO n040*	LMV MODBUS WATCHDOG	seconds	
AV/AO n041	LMV MODBUS OPERATING MODE	no units	0=auto,1=on,2=off
AV/AO n042	LMV MODBUS SETPOINT W3	<pv unit>	
AV/AO n043	LMV MODBUS OUTPUT	no units	see Mapping Notes – Note 1
AV/AO n044*	LMV MODBUS FUEL SELECTION	no units	0=gas/fuel0,1=oil/fuel1

BACnet/Modbus N2 TS Series Touchscreen Kit Mapping
MS/TP addressing only: n = node ID

ADDRESS	DESCRIPTION	UNITS/TEXT	NOTES
AV/AO n045*	LMV SETPOINT W1	<pv unit>	
AV/AO n046*	LMV SETPOINT W2	<pv unit>	
AI n047	LMV WEEKDAY	no units	0=Sun,1=Mon,...,6=Sat
AI n048	LMV YEAR 2-DIGIT	no units	
AI n049	LMV MONTH	no units	
AI n050	LMV DAY	no units	
AI n051	LMV HOUR	no units	
AI n052	LMV MINUTE	no units	
AI n053	LMV SECOND	no units	
AV/AO n054*	LMV HOURS RUN GAS RESET	hours	
AV/AO n055*	LMV HOURS RUN OIL S1 RESET	hours	
AV/AO n056*	LMV HOURS RUN OIL S2 RESET	hours	
AV/AO n057*	LMV HOURS RUN OIL S3 RESET	hours	
AV/AO n058*	LMV HOURS RUN TOTAL RESET	hours	
AI n059	LMV HOURS RUN TOTAL FIXED	hours	
AI n060	LMV HOURS CONNECTED TO POWER	hours	
AV/AO n061*	LMV STARTUPS GAS RESET	no units	
AV/AO n062*	LMV STARTUPS OIL RESET	no units	
AV/AO n063*	LMV STARTUPS TOTAL RESET	no units	
AI n064	LMV STARTUPS TOTAL FIXED	no units	
AV/AO n065*	LMV TOTAL VOLUME GAS/FUELO	no units	
AV/AO n066*	LMV TOTAL VOLUME OIL/FUEL1	no units	
AI n067	LMV NUMBER OF LOCKOUTS	no units	
AI n068	LMV EXTRA TEMPERATURE SENSOR	no units	
AI n069	LMV AZL5 PARAMETER SET CODE	no units	
AI n070	LMV AZL5 PARAMETER SET VER	no units	
AI n071	LMV AZL5 ID DATE YEAR 2-DIGIT	no units	
AI n072	LMV AZL5 ID DATE MONTH	no units	
AI n073	LMV AZL5 ID DATE DAY	no units	
AI n074	LMV AZL5 ID NUMBER	no units	
AI n075	LMV BC PARAMETER SET CODE	no units	
AI n076	LMV BC PARAMETER SET VER	no units	
AI n077	LMV BC ID DATE YEAR 2-DIGIT	no units	
AI n078	LMV BC ID DATE MONTH	no units	
AI n079	LMV BURNER CONTROL ID DATE DAY	no units	
AI n080	LMV BURNER CONTROL ID NUMBER	no units	
AI n081	LMV SOFTWARE VERSION AZL	no units	read in hexadecimal
AI n082	LMV SW VER BURNER CONTROL	no units	read in hexadecimal
AI n083	LMV SW VER LOAD CONTROL	no units	read in hexadecimal
AI n084	LMV MINIMUM OUTPUT GAS	percent	see Mapping Notes – Note 1
AI n085	LMV MAXIMUM OUTPUT GAS	percent	see Mapping Notes – Note 1
AI n086	LMV MINIMUM OUTPUT OIL	percent	see Mapping Notes – Note 1
AI n087	LMV MAXIMUM OUTPUT OIL	percent	see Mapping Notes – Note 1
AV/AO n088*	LMV LOAD LIMIT MODULATING	percent	see Mapping Notes – Note 1
AV/AO n089*	LMV LOAD LIMIT STAGING	no units	0=S1,1=S2,2=S3
AI n090	LMV TEMP LIMIT ON THRESHOLD	percent	-50% to 0%
AI n091	LMV RANGE TEMPERATURE SENSOR	no units	0=302F,1=752F,2=1562F
AI n092	LMV ADAPTION ACTIVE	no units	0=inactive,1=active

BACnet/Metasys N2 TS Series Touchscreen Kit Mapping
MS/TP addressing only: n = node ID

ADDRESS	DESCRIPTION	UNITS/TEXT	NOTES
AI n093	LMV ADAPTION STATE	no units	
AV/AO n094	LMV START ADAPTION	no units	0=reset,1=start,2=abort
AV/AO n095*	LMV ADAPTION OUTPUT	percent	
AV/AO n096*	LMV P-VALUE	percent	
AV/AO n097*	LMV I-VALUE	seconds	
AV/AO n098*	LMV D-VALUE	seconds	
AI n099	OPERATION MODE FUEL 0	no units	see Mapping Notes – Note 7
AI n0100	OPERATION MODE FUEL 1	no units	see Mapping Notes – Note 7
AI n0101	CYCLES REVERT TO PILOT	no units	
AI n0102	LOW RANGE TRIM FUEL 0	percent	
AI n0103	HIGH RANGE TRIM FUEL 0	percent	
AI n0104	LOW RANGE TRIM FUEL 1	percent	
AI n0105	HIGH RANGE TRIM FUEL 1	percent	
AI n0106	ANALOG INPUT TRIM	percent	
AI n0107	CURRENT TRIM CORRECTION	percent	
AI n0108	ABSOLUTE SPEED RPM	RPM	
AI n0109	MAINS VOLTAGE	volts	
AV/AO n0110	REM CON HAND-OFF-AUTO	no units	0=hand,1=off,2=auto
AV/AO n0111	REM CON MAN MODE	no units	0=auto,1=manual
AV/AO n0112	REM CON MAN OUTPUT	percent	see Mapping Notes – Note 1
AI n0113	LMV LOCKOUT ERROR CODE CURRENT	no units	see LMV... Lockout/Error Codes
AI n0114	LMV LOCKOUT DIAG CODE CURRENT	no units	see LMV... Lockout/Error Codes
AI n0115	LMV LOCKOUT ERR CLASS CURRENT	no units	not used
AI n0116	LMV LOCKOUT ERR PHASE CURRENT	no units	see LMV Phases
AI n0117	LMV LOCKOUT FUEL CURRENT	no units	0=gas/fuel0,1=oil/fuel1
AI n0118	LMV LOCKOUT OUTPUT CURRENT	no units	see Mapping Notes – Note 1
AI n0119	LMV LOCKOUT YEAR 2-DIG CURRENT	no units	
AI n0120	LMV LOCKOUT MONTH CURRENT	no units	
AI n0121	LMV LOCKOUT DAY CURRENT	no units	
AI n0122	LMV LOCKOUT HOUR CURRENT	no units	
AI n0123	LMV LOCKOUT MINUTE CURRENT	no units	
AI n0124	LMV LOCKOUT SECOND CURRENT	no units	
AI n0125	LMV LOCKOUT STARTUPS CURRENT	no units	see LMV... Lockout/Error Codes
AI n0126	LMV LOCKOUT HOURS CURRENT	hours	see LMV... Lockout/Error Codes
AI n0127	LMV ERROR ERROR CODE CURRENT	no units	not used
AI n0128	LMV ERROR DIAG CODE CURRENT	no units	see LMV Phases
AI n0129	LMV ERROR ERROR CLASS CURRENT	no units	0=gas/fuel0,1=oil/fuel1
AI n0130	LMV ERROR ERROR PHASE CURRENT	no units	see Mapping Notes – Note 1
AI n0131	LMV ERROR FUEL CURRENT	no units	
AI n0132	LMV ERROR OUTPUT CURRENT	no units	
AI n0133	LMV ERROR STARTUPS CURRENT	no units	
AI n0134	EQUIPMENT FAULTS	no units	
AI n0135	RWF LC INPUT WORD	no units	
AI n0136	RWF LC OUTPUT WORD	no units	
AI n0137	RWF LC E1	<pv unit>	
AI n0138	RWF LC E2	no units	
AI n0139	RWF LC E3	<temp unit>	
AI n0140	RWF LC WR CURRENT SP	<pv unit>	

BACnet/Metasys N2 TS Series Touchscreen Kit Mapping
MS/TP addressing only: n = node ID

ADDRESS	DESCRIPTION	UNITS/TEXT	NOTES
AV/AO n0141	RWF LC SP1	<pv unit>	
AV/AO n0142	RWF LC SP2	<pv unit>	
AV/AO n0143	RWF LC AL ALARM SP	<pv unit>	
AV/AO n0144	RWF LC PB1 PROPORTIONAL	<pv unit>	
AV/AO n0145	RWF LC DT DERIVATIVE	seconds	
AV/AO n0146	RWF LC RT INTEGRAL	seconds	
AV/AO n0147	RWF LC HYS1	<pv unit>	
AV/AO n0148	RWF LC HYS3	<pv unit>	
AV/AO n0149	RWF LC DTT WATCHDOG	seconds	
AI n0150	RWF LC E3 UNFILTERED	<temp unit>	
AV/AO n0151	RWF LC REM REMOTE OPERATION	no units	
AV/AO n0152	RWF LC ROFF REMOTE OFF	no units	
AV/AO n0153	RWF LC RK1 REMOTE BURNER CONTROL	no units	
AV/AO n0154	RWF LC RK6 REMOTE K6 CONTROL	no units	
AV/AO n0155	RWF LC SPR REMOTE SETPOINT	<pv unit>	
AV/AO n0156	RWF LC RY REMOTE OUTPUT	percent	
AI n0157	RWF LC Y OUTPUT	percent	
AI n0158	CIRC PUMP CONTROL SIGNAL	percent	
AI n0159	CIRC PUMP OUTPUT SIGNAL	percent	
AI n0160	RWF FW INPUT WORD	no units	
AI n0161	RWF FW OUTPUT WORD	no units	
AI n0162	RWF FW LEVEL PERCENT	percent	
AI n0163	RWF FW SETPOINT PERCENT	percent	
AI n0164	RWF FW E1	inches water	
AI n0165	RWF FW E2	no units	
AI n0166	RWF FW E3	<temp unit>	
AI n0167	RWF FW WR CURRENT SP	inches water	
AI n0168	RWF FW SP1	inches water	
AI n0169	RWF FW SP2	inches water	
AI n0170	RWF FW Y	percent	
AI n0171	RWF EX1 INPUT WORD	no units	
AI n0172	RWF EX1 OUTPUT WORD	no units	
AI n0173	RWF EX1 E1	<pv unit>	
AI n0174	RWF EX1 E2	no units	
AI n0175	RWF EX1 E3	<temp unit>	
AI n0176	RWF EX1 WR CURRENT SP	<pv unit>	
AI n0177	RWF EX1 SP1	<pv unit>	
AI n0178	RWF EX1 SP2	<pv unit>	
AI n0179	RWF EX1 AL ALARM SP	no units	
AI n0180	RWF EX1 HYS1	<pv unit>	
AI n0181	RWF EX1 HYS3	<pv unit>	
AI n0182	RWF EX1 Y OUTPUT	percent	
AI n0183	RWF EX2 INPUT WORD	no units	
AI n0184	RWF EX2 OUTPUT WORD	no units	
AI n0185	RWF EX2 E1	<pv unit>	
AI n0186	RWF EX2 E2	no units	
AI n0187	RWF EX2 E3	<temp unit>	
AI n0188	RWF EX2 WR CURRENT SP	<pv unit>	

BACnet/Metasys N2 TS Series Touchscreen Kit Mapping
MS/TP addressing only: n = node ID

ADDRESS	DESCRIPTION	UNITS/TEXT	NOTES
AI n0189	RWF EX2 SP1	<pv unit>	
AI n0190	RWF EX2 SP2	<pv unit>	
AI n0191	RWF EX2 AL ALARM SP	no units	
AI n0192	RWF EX2 HYS1	<pv unit>	
AI n0193	RWF EX2 HYS3	<pv unit>	
AI n0194	RWF EX2 Y OUTPUT	percent	
AI n0195	EA GENERIC INPUTS 1 WORD	no units	
AI n0196	EA GENERIC INPUTS 2 WORD	no units	
AI n0197	EA GENERIC INPUTS 3 WORD	no units	
AI n0198	EA DIGITAL INPUT WORD	no units	
AI n0199	EA STATUS WORD	no units	
AI n0200	EA ALARM WORD	no units	
AI n0201	EA ANALOG INPUT 1	no units	
AI n0202	EA ANALOG INPUT 2	no units	
AI n0203	EA ANALOG INPUT 3	no units	
AI n0204	EA ANALOG INPUT 4	no units	
AI n0205	EA GENERIC INPUT 5	no units	
AI n0206	EA GENERIC INPUT 6	no units	
AI n0207	EA GENERIC INPUT 7	no units	
AI n0208	EA GENERIC INPUT 8	no units	
AI n0209	EA GENERIC INPUT 9	no units	
AI n0210	EA GENERIC INPUT 10	no units	
AI n0211	EA GENERIC INPUT 11	no units	
AI n0212	EA GENERIC INPUT 12	no units	
AI n0213	EA GENERIC INPUT 13	no units	
AI n0214	EA GENERIC INPUT 14	no units	
AI n0215	EA GENERIC INPUT 15	no units	
AI n0216	EA GENERIC INPUT 16	no units	
AI n0217	EA DRAFT FEEDBACK	angular degrees	
AI n0218	EA DRAFT ALARM	no units	
AI n0219	EA DRAFT ALARM CODE	no units	
AI n0220	EA DRAFT ALARM PHASE	no units	
AI n0221	EA DRAFT DRIVE WORD	no units	
AI n0222	EA DRAFT SWITCH	no units	
AI n0223	EA DRAFT SENSOR	inches water	
AI n0224	EA LC INPUT WORD	no units	
AI n0225	EA LC OUTPUT WORD	no units	
AI n0226	EA LC E1	<pv unit>	
AI n0227	EA LC E3	<temp unit>	
AI n0228	EA LC WR CURRENT SP	<pv unit>	
AV/AO n0229	EA LC SP1	<pv unit>	
AV/AO n0230	EA LC AL ALARM SP	<pv unit>	
AV/AO n0231	EA LC PB1 PROPORTIONAL	<pv unit>	
AV/AO n0232	EA LC DT DERIVATIVE	seconds	
AV/AO n0233	EA LC RT INTEGRAL	seconds	
AV/AO n0234	EA LC HYS1	<pv unit>	
AV/AO n0235	EA LC HYS3	<pv unit>	
AV/AO n0236	EA LC REM REMOTE OPERATION	no units	

BACnet/Modbus N2 TS Series Touchscreen Kit Mapping
MS/TP addressing only: n = node ID

ADDRESS	DESCRIPTION	UNITS/TEXT	NOTES
AV/AO n0237	EA LC ROFF REMOTE OFF	no units	
AV/AO n0238	EA LC RK1 REMOTE BURNER CONTROL	no units	
AV/AO n0239	EA LC SPR REMOTE SETPOINT	<pv unit>	
AV/AO n0240	EA LC RY REMOTE OUTPUT	percent	
AI n0241	EA LC Y OUTPUT	percent	
AI n0242	EA MONITORED OUT 1	no units	
AI n0243	EA MONITORED OUT 2	no units	
AI n0244	VSD FREQUENCY REF PERCENT	percent	
AI n0245	VSD OUTPUT FREQUENCY PERCENT	percent	
AI n0246	VSD OUTPUT VOLTAGE	volts	
AI n0247	VSD DC BUS VOLTAGE	volts	
AI n0248	VSD STATUS WORD	no units	
AI n0249	VSD OUTPUT RPM	RPM	
AI n0250	VSD OUTPUT CURRENT	amperes	
AI n0251	VSD FREQUENCY REFERENCE HERTZ	hertz	
AI n0252	VSD OUTPUT FREQUENCY HERTZ	hertz	
AI n0253	VSD ALARM CODE	no units	
AI n0254	VSD FAULT CODE	no units	
AI n0255	VSD DC BUS PEAK	volts	
AI n0256	VSD OUTPUT CURRENT PEAK	amperes	
AI n0257	VSD OUTPUT POWER	kilowatts	
AI n0258	VSD TOTALIZED POWER	kilowatts	
AI n0259	USER VALUE 1	no units	
AI n0260	USER VALUE 2	no units	
AI n0261	USER VALUE 3	no units	
AI n0262	USER VALUE 4	no units	
AI n0263	USER VALUE 5	no units	
AI n0264	USER VALUE 6	no units	
AI n0265	USER VALUE 7	no units	
AI n0266	USER VALUE 8	no units	
AI n0267	USER VALUE 9	no units	
AI n0268	USER VALUE 10	no units	
AI n0269	USER VALUE 11	no units	
AI n0270	USER VALUE 12	no units	
AI n0271	USER VALUE 13	no units	
AI n0272	USER VALUE 14	no units	
AI n0273	USER VALUE 15	no units	
AI n0274	USER VALUE 16	no units	
BI n001	LMV CONTROLLER SWITCH	active/inactive	
BI n002	LMV FAN CONTACTOR	active/inactive	
BI n003	LMV OIL SELECTED	active/inactive	
BI n004	LMV GAS SELECTED	active/inactive	
BI n005	LMV OIL PRESS SW MAX	active/inactive	
BI n006	LMV OIL PRESS SW MIN	active/inactive	
BI n007	LMV VALVE PROVING SW	active/inactive	
BI n008	LMV SAFETY LOOP	active/inactive	
BI n009	LMV GAS PRESS SW MIN	active/inactive	
BI n010	LMV GAS PRESS SW MAX	active/inactive	

BACnet/Modbus N2 TS Series Touchscreen Kit Mapping
MS/TP addressing only: n = node ID

ADDRESS	DESCRIPTION	UNITS/TEXT	NOTES
BI n011	LMV AIR PRESSURE SW	active/inactive	
BI n012	LMV START RELEASE OIL	active/inactive	
BI n013	LMV HEAVY OIL START	active/inactive	
BI n014	LMV ALARM	active/inactive	
BI n015	LMV IGNITION	active/inactive	
BI n016	LMV START SIGNAL	active/inactive	
BI n017	LMV FAN OUTPUT	active/inactive	
BI n018	LMV OIL PUMP	active/inactive	
BI n019	LMV FUEL VALVE SV OIL	active/inactive	
BI n020	LMV FUEL VALVE V1 OIL	active/inactive	
BI n021	LMV FUEL VALVE V2 OIL	active/inactive	
BI n022	LMV FUEL VALVE V3 OIL	active/inactive	
BI n023	LMV FUEL VALVE SV GAS	active/inactive	
BI n024	LMV FUEL VALVE V1 GAS	active/inactive	
BI n025	LMV FUEL VALVE V2 GAS	active/inactive	
BI n026	LMV FUEL VALVE PV GAS	active/inactive	
BI n027	EQUIPMENT FAULT LMV5	active/inactive	
BI n028	EQUIPMENT FAULT LMV3	active/inactive	
BI n029	EQUIPMENT FAULT RWF10 LC	active/inactive	
BI n030	EQUIPMENT FAULT UNUSED	active/inactive	
BI n031	EQUIPMENT FAULT RWF55 LC	active/inactive	
BI n032	EQUIPMENT FAULT UNUSED	active/inactive	
BI n033	EQUIPMENT FAULT RWF55 FW	active/inactive	
BI n034	EQUIPMENT FAULT EA	active/inactive	
BI n035	EQUIPMENT FAULT VSD	active/inactive	
BI n036	RWF LC INPUT 1 FAULT	active/inactive	
BI n037	RWF LC INPUT 2 FAULT	active/inactive	
BI n038	RWF LC INPUT 3 FAULT	active/inactive	
BI n039	RWF LC STAGE MODE	active/inactive	
BI n040	RWF LC MANUAL OPERATION	active/inactive	
BI n041	RWF LC BINARY INPUT 1	active/inactive	
BI n042	RWF LC BINARY INPUT 2	active/inactive	
BI n043	RWF LC STAT ACTIVE	active/inactive	
BI n044	RWF LC UP ACTIVE	active/inactive	
BI n045	RWF LC DOWN ACTIVE	active/inactive	
BI n046	RWF LC K6 ACTIVE	active/inactive	
BI n047	RWF FW INPUT 1 FAULT	active/inactive	
BI n048	RWF FW INPUT 2 FAULT	active/inactive	
BI n049	RWF FW INPUT 3 FAULT	active/inactive	
BI n050	RWF FW STAGE MODE	active/inactive	
BI n051	RWF FW MANUAL OPERATION	active/inactive	
BI n052	RWF FW BINARY INPUT 1	active/inactive	
BI n053	RWF FW BINARY INPUT 2	active/inactive	
BI n054	RWF FW STAT ACTIVE	active/inactive	
BI n055	RWF FW UP ACTIVE	active/inactive	
BI n056	RWF FW DOWN ACTIVE	active/inactive	
BI n057	RWF FW K6 ACTIVE	active/inactive	
BI n058	RWF EX1 INPUT 1 FAULT	active/inactive	

BACnet/Modbus N2 TS Series Touchscreen Kit Mapping
MS/TP addressing only: n = node ID

ADDRESS	DESCRIPTION	UNITS/TEXT	NOTES
BI n059	RWF EX1 INPUT 2 FAULT	active/inactive	
BI n060	RWF EX1 INPUT 3 FAULT	active/inactive	
BI n061	RWF EX1 STAGE MODE	active/inactive	
BI n062	RWF EX1 MANUAL OPERATION	active/inactive	
BI n063	RWF EX1 BINARY INPUT 1	active/inactive	
BI n064	RWF EX1 BINARY INPUT 2	active/inactive	
BI n065	RWF EX1 STAT ACTIVE	active/inactive	
BI n066	RWF EX1 UP ACTIVE	active/inactive	
BI n067	RWF EX1 DOWN ACTIVE	active/inactive	
BI n068	RWF EX1 K6 ACTIVE	active/inactive	
BI n069	RWF EX2 INPUT 1 FAULT	active/inactive	
BI n070	RWF EX2 INPUT 2 FAULT	active/inactive	
BI n071	RWF EX2 INPUT 3 FAULT	active/inactive	
BI n072	RWF EX2 STAGE MODE	active/inactive	
BI n073	RWF EX2 MANUAL OPERATION	active/inactive	
BI n074	RWF EX2 BINARY INPUT 1	active/inactive	
BI n075	RWF EX2 BINARY INPUT 2	active/inactive	
BI n076	RWF EX2 STAT ACTIVE	active/inactive	
BI n077	RWF EX2 UP ACTIVE	active/inactive	
BI n078	RWF EX2 DOWN ACTIVE	active/inactive	
BI n079	RWF EX2 K6 ACTIVE	active/inactive	
BI n080	EA GI5 HIGH ALARM	active/inactive	
BI n081	EA GI5 LOW ALARM	active/inactive	
BI n082	EA GI6 HIGH ALARM	active/inactive	
BI n083	EA GI6 LOW ALARM	active/inactive	
BI n084	EA GI7 HIGH ALARM	active/inactive	
BI n085	EA GI7 LOW ALARM	active/inactive	
BI n086	EA GI8 HIGH ALARM	active/inactive	
BI n087	EA GI8 LOW ALARM	active/inactive	
BI n088	EA GI9 HIGH ALARM	active/inactive	
BI n089	EA GI9 LOW ALARM	active/inactive	
BI n090	EA GI10 HIGH ALARM	active/inactive	
BI n091	EA GI10 LOW ALARM	active/inactive	
BI n092	EA GI11 HIGH ALARM	active/inactive	
BI n093	EA GI11 LOW ALARM	active/inactive	
BI n094	EA GI12 HIGH ALARM	active/inactive	
BI n095	EA GI12 LOW ALARM	active/inactive	
BI n096	EA GI13 HIGH ALARM	active/inactive	
BI n097	EA GI13 LOW ALARM	active/inactive	
BI n098	EA GI14 HIGH ALARM	active/inactive	
BI n099	EA GI14 LOW ALARM	active/inactive	
BI n0100	EA GI15 HIGH ALARM	active/inactive	
BI n0101	EA GI15 LOW ALARM	active/inactive	
BI n0102	EA GI16 HIGH ALARM	active/inactive	
BI n0103	EA GI16 LOW ALARM	active/inactive	
BI n0104	EA INPUT 1	active/inactive	
BI n0105	EA INPUT 2	active/inactive	
BI n0106	EA INPUT 3	active/inactive	

BACnet/Metasys N2 TS Series Touchscreen Kit Mapping
MS/TP addressing only: n = node ID

ADDRESS	DESCRIPTION	UNITS/TEXT	NOTES
BI n0107	EA INPUT 4	active/inactive	
BI n0108	EA INPUT 5	active/inactive	
BI n0109	EA INPUT 6	active/inactive	
BI n0110	EA INPUT 7	active/inactive	
BI n0111	EA INPUT 8	active/inactive	
BI n0112	EA INPUT 9	active/inactive	
BI n0113	EA INPUT 10	active/inactive	
BI n0114	EA INPUT 11	active/inactive	
BI n0115	EA INPUT 12	active/inactive	
BI n0116	EA INPUT 13	active/inactive	
BI n0117	EA PUMP PROVEN	active/inactive	
BI n0118	EA PUMP ALARM	active/inactive	
BI n0119	EA AI1 HIGH ALARM	active/inactive	
BI n0120	EA AI1 LOW ALARM	active/inactive	
BI n0121	EA AI2 HIGH ALARM	active/inactive	
BI n0122	EA AI2 LOW ALARM	active/inactive	
BI n0123	EA AI3 HIGH ALARM	active/inactive	
BI n0124	EA AI3 LOW ALARM	active/inactive	
BI n0125	EA AI4 HIGH ALARM	active/inactive	
BI n0126	EA AI4 LOW ALARM	active/inactive	
BI n0127	EA AO1 HIGH ALARM	active/inactive	
BI n0128	EA AO1 LOW ALARM	active/inactive	
BI n0129	EA AO2 HIGH ALARM	active/inactive	
BI n0130	EA AO2 LOW ALARM	active/inactive	
BI n0131	EA ALARM INPUT 1	active/inactive	
BI n0132	EA ALARM INPUT 2	active/inactive	
BI n0133	EA ALARM INPUT 3	active/inactive	
BI n0134	EA ALARM INPUT 4	active/inactive	
BI n0135	EA ALARM INPUT 5	active/inactive	
BI n0136	EA ALARM INPUT 6	active/inactive	
BI n0137	EA ALARM INPUT 7	active/inactive	
BI n0138	EA ALARM INPUT 8	active/inactive	
BI n0139	EA ALARM INPUT 9	active/inactive	
BI n0140	EA ALARM INPUT 10	active/inactive	
BI n0141	EA ALARM INPUT 11	active/inactive	
BI n0142	EA ALARM INPUT 12	active/inactive	
BI n0143	EA ALARM INPUT 13	active/inactive	
BI n0144	EA DRAFT OPEN POSITION	active/inactive	
BI n0145	EA DRAFT CLOSE POSITION	active/inactive	
BI n0146	EA DRAFT START POSITION	active/inactive	
BI n0147	EA DRAFT MODULATE	active/inactive	
BI n0148	EA LC STAT ACTIVE	active/inactive	
BI n0149	EA LC K6 ACTIVE	active/inactive	
BI n0150	EA MON OUT 3 ALARM	active/inactive	
BI n0151	EA MON OUT 4 ALARM	active/inactive	
BI n0152	VSD RUNNING	active/inactive	
BI n0153	VSD ZERO SPEED	active/inactive	
BI n0154	VSD SPEED AGREE	active/inactive	

BACnet/Metasys N2 TS Series Touchscreen Kit Mapping
MS/TP addressing only: n = node ID

ADDRESS	DESCRIPTION	UNITS/TEXT	NOTES
BI n0155	VSD READY STATE	active/inactive	
BI n0156	VSD ALARM STATE	active/inactive	
BI n0157	VSD FAULT STATE	active/inactive	

BACnet/Metasys N2 – Mapping (continued)

TS Series Lead/Lag Master (Global System Data)

BACnet/Metasys N2 TS Series Lead/Lag Master Mapping (Global System Data)

ADDRESS	DESCRIPTION	UNITS/TEXT	NOTES
AV/AO 1	LLM REMOTE SETPOINT	<pv unit>	
AV/AO 2	LLM LEAD BOILER	no units	
AI 3	LLM ALTERNATION SETPOINT	hours	
AI 4	LLM ALT HOURS REMAINING	hours	
AI 5	LLM CURRENT SETPOINT	no units	
AI 6	LLM TOTAL AVAILABLE	no units	
AI 7	LLM ACTUAL VALUE	<pv unit>	
AI 8	LLM RTD 1	<temp unit>	
AI 9	LLM RTD 2	<temp unit>	
AI 10	LLM RTD 3	<temp unit>	
AI 11	LLM RTD 4	<temp unit>	
AI 12	LLM ANALOG INPUT 1	no units	
AI 13	LLM ANALOG INPUT 2	no units	
AI 14	LLM ANALOG INPUT 3	no units	
AI 15	LLM ANALOG INPUT 4	no units	
AV/AO 16	LLM EXTRA INPUT	no units	
AV/AO 17	LLM LOAD DEMAND	percent	
AI 18	LLM ANALOG INPUT 1 TOTALIZED	no units	
AI 19	LLM ANALOG INPUT 2 TOTALIZED	no units	
AI 20	LLM ANALOG INPUT 3 TOTALIZED	no units	
AI 21	LLM ANALOG INPUT 4 TOTALIZED	no units	
AV/AO 22	LLM FREE REGISTER 1	no units	
AV/AO 23	LLM FREE REGISTER 2	no units	
AV/AO 24	LLM FREE REGISTER 3	no units	
AV/AO 25	LLM FREE REGISTER 4	no units	
AI 26	LLM USER VALUE 1	no units	
AI 27	LLM USER VALUE 2	no units	
AI 28	LLM USER VALUE 3	no units	
AI 29	LLM USER VALUE 4	no units	
AI 30	LLM USER VALUE 5	no units	
AI 31	LLM USER VALUE 6	no units	
AI 32	LLM USER VALUE 7	no units	
AI 33	LLM USER VALUE 8	no units	
AI 34	LLM USER VALUE 9	no units	
AI 35	LLM USER VALUE 10	no units	
AI 36	LLM USER VALUE 11	no units	
AI 37	LLM USER VALUE 12	no units	
AI 38	LLM USER VALUE 13	no units	
AI 39	LLM USER VALUE 14	no units	
AI 40	LLM USER VALUE 15	no units	
AI 41	LLM USER VALUE 16	no units	
AV/AO 42	LLM LOOP SETPOINT	no units	
AI 43	LLM LOOP OUTPUT	no units	
AV/AO 44	LLM LOOP P VALUE	no units	
AV/AO 45	LLM LOOP I VALUE	no units	

BACnet/Metasys N2 TS Series Lead/Lag Master Mapping (Global System Data)

ADDRESS	DESCRIPTION	UNITS/TEXT	NOTES
AV/AO 46	LLM LOOP D VALUE	no units	
AV/AO 47	LLM LOOP ALT SETPOINT	no units	
AI 48	LLM LOOP ALT ELAPSED	no units	
AI 49	LLM LOOP LEAD	no units	
AV/AO 50	LLM LOOP HYSTERESIS ON	no units	
AV/AO 51	LLM LOOP HYSTERESIS OFF	no units	
AI 52	LLM LOOP PUMP 1 CURRENT	amperes	
AI 53	LLM LOOP PUMP 2 CURRENT	amperes	
AI 54	LLM LOOP PUMP 1 FREQUENCY	hertz	
AI 55	LLM LOOP PUMP 2 FREQUENCY	hertz	
BV/BO 1	LLM REMOTE ENABLE	enable/disable	
BV/BO 2	LLM REMOTE VALID	enable/disable	
BI 3	LLM AI1 LOW ALARM	active/inactive	
BI 4	LLM AI1 HIGH ALARM	active/inactive	
BI 5	LLM AI2 LOW ALARM	active/inactive	
BI 6	LLM AI2 HIGH ALARM	active/inactive	
BI 7	LLM AI3 LOW ALARM	active/inactive	
BI 8	LLM AI3 HIGH ALARM	active/inactive	
BI 9	LLM AI4 LOW ALARM	active/inactive	
BI 10	LLM AI4 HIGH ALARM	active/inactive	
BI 11	LLM RTD1 LOW ALARM	active/inactive	
BI 12	LLM RTD1 HIGH ALARM	active/inactive	
BI 13	LLM RTD2 LOW ALARM	active/inactive	
BI 14	LLM RTD2 HIGH ALARM	active/inactive	
BI 15	LLM RTD3 LOW ALARM	active/inactive	
BI 16	LLM RTD3 HIGH ALARM	active/inactive	
BI 17	LLM RTD4 LOW ALARM	active/inactive	
BI 18	LLM RTD4 HIGH ALARM	active/inactive	
BI 19	LLM B1 COMM FAULT	active/inactive	
BI 20	LLM B2 COMM FAULT	active/inactive	
BI 21	LLM B3 COMM FAULT	active/inactive	
BI 22	LLM B4 COMM FAULT	active/inactive	
BI 23	LLM B5 COMM FAULT	active/inactive	
BI 24	LLM B6 COMM FAULT	active/inactive	
BI 25	LLM B7 COMM FAULT	active/inactive	
BI 26	LLM B8 COMM FAULT	active/inactive	
BI 27	LLM MO3 ALARM	active/inactive	
BI 28	LLM MO4 ALARM	active/inactive	
BI 29	LLM MO5 ALARM	active/inactive	
BI 30	LLM MO6 ALARM	active/inactive	
BI 31	LLM PLC COMM FAULT	active/inactive	
BI 32	LLM DIGITAL INPUT 1	active/inactive	
BI 33	LLM DIGITAL INPUT 2	active/inactive	
BI 34	LLM DIGITAL INPUT 3	active/inactive	
BI 35	LLM DIGITAL INPUT 4	active/inactive	
BI 36	LLM DIGITAL INPUT 5	active/inactive	
BI 37	LLM DIGITAL INPUT 6	active/inactive	
BI 38	LLM LOOP OUTPUT 1	active/inactive	
BI 39	LLM LOOP OUTPUT 2	active/inactive	

BACnet/Metasys N2 TS Series Lead/Lag Master Mapping (Global System Data)

ADDRESS	DESCRIPTION	UNITS/TEXT	NOTES
BI 40	LLM LOOP PUMP 1 RUN	active/inactive	
BI 41	LLM LOOP PUMP 2 RUN	active/inactive	
BI 42	LLM LOOP PUMP 1 ALARM	active/inactive	
BI 43	LLM LOOP PUMP 2 ALARM	active/inactive	

BACnet/Metasys N2 – Mapping (continued)

TS Series Lead/Lag Master (Boiler Data)

BACnet/Metasys N2 TS Series Lead/Lag Master Mapping (Boiler Data, x = boiler designation)
MS/TP addressing only: x = boiler designation

ADDRESS	DESCRIPTION	UNITS/TEXT	NOTES
AI x01	Bx LMV PHASE	no units	see LMV Phases
AI x02	Bx LMV FUEL ACTUATOR	angular degrees	
AI x03	Bx LMV GAS ACTUATOR	angular degrees	
AI x04	Bx LMV OIL ACTUATOR	angular degrees	
AI x05	Bx LMV AIR ACTUATOR	angular degrees	
AI x06	Bx LMV AUX1 ACTUATOR	angular degrees	
AI x07	Bx LMV AUX2 ACTUATOR	angular degrees	
AI x08	Bx LMV AUX3 ACTUATOR	angular degrees	
AI x09	Bx LMV VSD OUTPUT	percent	
AI x10	Bx LMV CURRENT OUTPUT	percent	see Mapping Notes – Note 1
AI x11	Bx LMV CURRENT SETPOINT	<pv unit>	
AI x12	Bx LMV ACTUAL VALUE	<pv unit>	
AI x13	Bx LMV FLAME SIGNAL	percent	
AI x14	Bx LMV FUEL THROUGHPUT	no units	
AI x15	Bx LMV CURRENT O2	percent	
AI x16	Bx LMV STARTUP COUNTER	no units	
AI x17	Bx LMV HOUR COUNTER	hours	
AI x18	Bx LMV CURR ERROR CODE	no units	see LMV... Lockout/Error Codes
AI x19	Bx LMV CURR DIAG CODE	no units	see LMV... Lockout/Error Codes
AI x20	Bx LMV CURR ERROR CLASS	no units	not used
AI x21	Bx LMV CURR ERROR PHASE	no units	see LMV Phases
AI x22	Bx LMV SUPPLY AIR TEMP	<temp unit>	
AI x23	Bx LMV FLUE GAS TEMP	<temp unit>	
AI x24	Bx LMV COMB EFFICIENCY	percent	
AI x25	Bx LMV CURRENT CO2	percent	
AI x26	Bx LMV CURR EXCESS AIR	percent	
AI x27	Bx LMV LD CONTROL MODE	no units	see Mapping Notes – Note 4
AI x28	Bx LMV MODBUS MODE	no units	0=auto,1=on,2=off
AI x29	Bx LMV MODBUS SP W3	<pv unit>	
AI x30	Bx LMV MODBUS OUTPUT	percent	see Mapping Notes – Note 1
AI x31	Bx LMV SETPOINT W1	<pv unit>	
AI x32	Bx LMV SETPOINT W2	<pv unit>	
AI x33	Bx LMV VOLUME GAS/FUELO	no units	
AI x34	Bx LMV VOLUME OIL/FUEL1	no units	
AI x35	Bx LMV TEMP SENSOR	<temp unit>	
AI x36	Bx RWF E1	<pv unit>	
AI x37	Bx RWF E2	no units	
AI x38	Bx RWF E3	<temp unit>	
AI x39	Bx RWF WR CURRENT SP	<pv unit>	
AI x40	Bx RWF SP1	<pv unit>	
AI x41	Bx FW E1	inches water	
AI x42	Bx FW E2	no units	
AI x43	Bx FW WR CURRENT SP	inches water	
AI x44	Bx FW SP1	inches water	

**BACnet/Modbus N2 TS Series Lead/Lag Master Mapping (Boiler Data, x = boiler designation)
MS/TP addressing only: x = boiler designation**

ADDRESS	DESCRIPTION	UNITS/TEXT	NOTES
AI x45	Bx DRAFT SENSOR	inches water	
AI x46	Bx DRAFT FEEDBACK	angular degrees	
AI x47	Bx USER VALUE 1	no units	
AI x48	Bx USER VALUE 2	no units	
AI x49	Bx USER VALUE 3	no units	
AI x50	Bx USER VALUE 4	no units	
AI x51	Bx USER VALUE 5	no units	
AI x52	Bx USER VALUE 6	no units	
AI x53	Bx USER VALUE 7	no units	
AI x54	Bx USER VALUE 8	no units	
AI x55	Bx USER VALUE 9	no units	
AI x56	Bx USER VALUE 10	no units	
AI x57	Bx USER VALUE 11	no units	
AI x58	Bx USER VALUE 12	no units	
AI x59	Bx USER VALUE 13	no units	
AI x60	Bx USER VALUE 14	no units	
AI x61	Bx USER VALUE 15	no units	
AI x62	Bx USER VALUE 16	no units	
AI x63	Bx EA ANALOG 1	no units	
AI x64	Bx EA ANALOG 2	no units	
AI x65	Bx EA ANALOG 3	no units	
AI x66	Bx EA ANALOG 4	no units	
AI x67	Bx EA GENERIC INPUT 5	no units	
AI x68	Bx EA GENERIC INPUT 6	no units	
AI x69	Bx EA GENERIC INPUT 7	no units	
AI x70	Bx EA GENERIC INPUT 8	no units	
AI x71	Bx EA GENERIC INPUT 9	no units	
AI x72	Bx EA GENERIC INPUT 10	no units	
AI x73	Bx EA GENERIC INPUT 11	no units	
AI x74	Bx EA GENERIC INPUT 12	no units	
AI x75	Bx UV FLOAT 1	no units	
AI x76	Bx UV FLOAT 2	no units	
AI x77	Bx UV FLOAT 3	no units	
AI x78	Bx UV FLOAT 4	no units	
AI x79	Bx UV FLOAT 5	no units	
AI x80	Bx UV FLOAT 6	no units	
AI x81	Bx UV FLOAT 7	no units	
AI x82	Bx UV FLOAT 8	no units	
AI x83	Bx UV DINT 1	no units	
AI x84	Bx UV DINT 2	no units	
AI x85	Bx UV DINT 3	no units	
AI x86	Bx UV DINT 4	no units	
AI x87	Bx UV DINT 5	no units	
AI x88	Bx UV DINT 6	no units	
AI x89	Bx UV DINT 7	no units	
AI x90	Bx UV DINT 8	no units	
BI x01	Bx BOILER AUTO	active/inactive	
BI x02	Bx BOILER AVAILABLE	active/inactive	

BACnet/Modbus N2 TS Series Lead/Lag Master Mapping (Boiler Data, x = boiler designation)

MS/TP addressing only: x = boiler designation

ADDRESS	DESCRIPTION	UNITS/TEXT	NOTES
BI x03	Bx BOILER PUMP RUNNING	active/inactive	
BI x04	Bx BOILER PUMP ALARM	active/inactive	
BI x05	Bx LMV CURRENT FUEL	oil/gas	
BI x06	Bx LMV CONTROLLER SW	active/inactive	
BI x07	Bx LMV FAN CONTACTOR	active/inactive	
BI x08	Bx LMV OIL SELECTED	active/inactive	
BI x09	Bx LMV GAS SELECTED	active/inactive	
BI x10	Bx LMV OIL PRESS SW MAX	active/inactive	
BI x11	Bx LMV OIL PRESS SW MIN	active/inactive	
BI x12	Bx LMV VALVE PROVING SW	active/inactive	
BI x13	Bx LMV SAFETY LOOP	active/inactive	
BI x14	Bx LMV GAS PRESS SW MIN	active/inactive	
BI x15	Bx LMV GAS PRESS SW MAX	active/inactive	
BI x16	Bx LMV AIR PRESSURE SW	active/inactive	
BI x17	Bx LMV START REL OIL	active/inactive	
BI x18	Bx LMV HEAVY OIL START	active/inactive	
BI x19	Bx LMV ALARM	active/inactive	
BI x20	Bx LMV IGNITION	active/inactive	
BI x21	Bx LMV START SIGNAL	active/inactive	
BI x22	Bx LMV FAN OUTPUT	active/inactive	
BI x23	Bx LMV OIL PUMP	active/inactive	
BI x24	Bx LMV VALVE SV OIL	active/inactive	
BI x25	Bx LMV VALVE V1 OIL	active/inactive	
BI x26	Bx LMV VALVE V2 OIL	active/inactive	
BI x27	Bx LMV VALVE V3 OIL	active/inactive	
BI x28	Bx LMV VALVE SV GAS	active/inactive	
BI x29	Bx LMV VALVE V1 GAS	active/inactive	
BI x30	Bx LMV VALVE V2 GAS	active/inactive	
BI x31	Bx LMV VALVE PV GAS	active/inactive	
BI x32	Bx LMV MODBUS LOC/REM	remote/local	
BI x33	Bx RWF INPUT 1 FAULT	active/inactive	
BI x34	Bx RWF INPUT 2 FAULT	active/inactive	
BI x35	Bx RWF INPUT 3 FAULT	active/inactive	
BI x36	Bx RWF STAGE MODE	active/inactive	
BI x37	Bx RWF MANUAL OPERATION	active/inactive	
BI x38	Bx RWF BINARY INPUT 1	active/inactive	
BI x39	Bx RWF BINARY INPUT 2	active/inactive	
BI x40	Bx RWF STAT ACTIVE	active/inactive	
BI x41	Bx RWF UP ACTIVE	active/inactive	
BI x42	Bx RWF DOWN ACTIVE	active/inactive	
BI x43	Bx RWF K6 ACTIVE	active/inactive	
BI x44	Bx EA INPUT 1	active/inactive	
BI x45	Bx EA INPUT 2	active/inactive	
BI x46	Bx EA INPUT 3	active/inactive	
BI x47	Bx EA INPUT 4	active/inactive	
BI x48	Bx EA INPUT 5	active/inactive	
BI x49	Bx EA INPUT 6	active/inactive	
BI x50	Bx EA INPUT 7	active/inactive	

BACnet/Metasys N2 TS Series Lead/Lag Master Mapping (Boiler Data, x = boiler designation)**MS/TP addressing only: x = boiler designation**

ADDRESS	DESCRIPTION	UNITS/TEXT	NOTES
BI x51	Bx EA INPUT 8	active/inactive	
BI x52	Bx EA INPUT 9	active/inactive	
BI x53	Bx EA INPUT 10	active/inactive	
BI x54	Bx EA INPUT 11	active/inactive	
BI x55	Bx EA INPUT 12	active/inactive	
BI x56	Bx EA INPUT 13	active/inactive	
BI x57	Bx EA ALARM 1	active/inactive	
BI x58	Bx EA ALARM 2	active/inactive	
BI x59	Bx EA ALARM 3	active/inactive	
BI x60	Bx EA ALARM 4	active/inactive	
BI x61	Bx EA ALARM 5	active/inactive	
BI x62	Bx EA ALARM 6	active/inactive	
BI x63	Bx EA ALARM 7	active/inactive	
BI x64	Bx EA ALARM 8	active/inactive	
BI x65	Bx EA ALARM 9	active/inactive	
BI x66	Bx EA ALARM 10	active/inactive	
BI x67	Bx EA ALARM 11	active/inactive	
BI x68	Bx EA ALARM 12	active/inactive	
BI x69	Bx EA ALARM 13	active/inactive	

Ethernet/IP – Mapping

There are four arrays provided for each device (Read, Status, Write and Trigger). To write a writable point, write the desired value to the index of the Write array and then set the corresponding index of the Trigger array to 1.

Status points are bits of INT so the bit position is indicated after the index (such as index 0, bit 5 being shown as **0.5**). Status is binary data.

The variable name is in the format **<Device Name>_<ARRAY_NAME>_<Node ID>** where the parameter **Node ID** is the same as entered when configuring the profile using the web-based configuration utility.

Indexes marked with an asterisk (*) are EEPROM backed and should not be continuously written.

LMV5...

Ethernet/IP LMV5... Mapping

Variable = LMV_<ARRAY NAME>_<Node ID>

INDEX	DESCRIPTION	ARRAY NAME(S)	NOTES
0	LMV PHASE	Read	see LMV Phases
1	LMV FUEL ACTUATOR	Read	
2	LMV GAS ACTUATOR	Read	
3	LMV OIL ACTUATOR	Read	
4	LMV AIR ACTUATOR	Read	
5	LMV AUX1 ACTUATOR	Read	
6	LMV AUX2 ACTUATOR	Read	
7	LMV AUX3 ACTUATOR	Read	
8	LMV VSD OUTPUT	Read	
9	LMV CURRENT FUEL	Read	0=gas/fuel0,1=oil/fuel1
10	LMV CURRENT OUTPUT	Read	see Mapping Notes – Note 1
11	LMV CURRENT SETPOINT	Read	
12	LMV ACTUAL VALUE	Read	
13	LMV FLAME SIGNAL	Read	
14	LMV FUEL THROUGHPUT	Read	
15	LMV CURRENT O2	Read	
16	LMV GAS UNIT	Read	0=metric,1=standard
17	LMV OIL UNIT	Read	0=metric,1=standard
18	LMV TEMPERATURE UNIT	Read	0=metric,1=standard
19	LMV PRESSURE UNIT	Read	0=metric,1=standard
20	LMV SENSOR SELECTION	Read	see Mapping Notes – Note 2
21	LMV STARTUP COUNTER	Read	
23	LMV HOUR COUNTER	Read	
25	LMV CURRENT ERROR CODE	Read	see LMV5 Lockout/Error Codes
26	LMV CURRENT DIAGNOSTIC CODE	Read	see LMV5 Lockout/Error Codes
27	LMV CURRENT ERROR CLASS	Read	not used
28	LMV CURRENT ERROR PHASE	Read	see LMV Phases
29	LMV TEMP LIMIT OFF THRESHOLD	Read	
30	LMV SUPPLY AIR TEMPERATURE	Read	

Ethernet/IP LMV5... Mapping

Variable = LMV_<ARRAY NAME>_<Node ID>

INDEX	DESCRIPTION	ARRAY NAME(S)	NOTES
31	LMV FLUE GAS TEMPERATURE	Read	
32	LMV COMBUSTION EFFICIENCY	Read	
35	LMV INPUT WORD	Read	word of bits
37	LMV OUTPUT WORD	Read	word of bits
38*	LMV PROGRAM STOP	Read, Write	see Mapping Notes – Note 3
39*	LMV LOAD CONTROL MODE	Read, Write	see Mapping Notes – Note 4
40	LMV MANUAL/AUTOMATIC	Read	0=auto,1=on,2=off
41	LMV MODBUS LOCAL/REMOTE	Read, Write	0=local,1=remote
42*	LMV MODBUS WATCHDOG	Read, Write	
43	LMV MODBUS OPERATING MODE	Read, Write	0=auto,1=on,2=off
44	LMV MODBUS SETPOINT W3	Read, Write	
45	LMV MODBUS OUTPUT	Read, Write	see Mapping Notes – Note 1
46*	LMV MODBUS FUEL SELECTION	Read, Write	0=gas/fuel0,1=oil/fuel1
47*	LMV SETPOINT W1	Read, Write	
48*	LMV SETPOINT W2	Read, Write	
49	LMV WEEKDAY	Read	0=Sun,1=Mon,...,6=Sat
50	LMV YEAR 2-DIGIT	Read	
51	LMV MONTH	Read	
52	LMV DAY	Read	
53	LMV HOUR	Read	
54	LMV MINUTE	Read	
55	LMV SECOND	Read	
56*	LMV HOURS RUN GAS RESET	Read, Write	
58*	LMV HOURS RUN OIL S1 RESET	Read, Write	
60*	LMV HOURS RUN OIL S2 RESET	Read, Write	
62*	LMV HOURS RUN OIL S3 RESET	Read, Write	
64*	LMV HOURS RUN TOTAL RESET	Read, Write	
66	LMV HOURS RUN TOTAL FIXED	Read	
68	LMV HOURS CONNECTED TO POWER	Read	
70*	LMV STARTUPS GAS RESET	Read, Write	
72*	LMV STARTUPS OIL RESET	Read, Write	
74*	LMV STARTUPS TOTAL RESET	Read, Write	
76	LMV STARTUPS TOTAL FIXED	Read	
78*	LMV TOTAL VOLUME GAS	Read, Write	
80*	LMV TOTAL VOLUME OIL	Read, Write	
82	LMV NUMBER OF LOCKOUTS	Read	
83	LMV EXTRA TEMPERATURE SENSOR	Read	
92	LMV AZL5 PARAMETER SET CODE	Read	
93	LMV AZL5 PARAMETER SET VER	Read	
94	LMV AZL5 ID DATE YEAR 2-DIGIT	Read	
95	LMV AZL5 ID DATE MONTH	Read	
96	LMV AZL5 ID DATE DAY	Read	
97	LMV AZL5 ID NUMBER	Read	
106	LMV BC PARAMETER SET CODE	Read	
107	LMV BC PARAMETER SET VER	Read	
108	LMV BC ID DATE YEAR 2-DIGIT	Read	
109	LMV BC ID DATE MONTH	Read	
110	LMV BURNER CONTROL ID DATE DAY	Read	

Ethernet/IP LMV5... Mapping

Variable = LMV_<ARRAY NAME>_<Node ID>

INDEX	DESCRIPTION	ARRAY NAME(S)	NOTES
111	LMV BURNER CONTROL ID NUMBER	Read	
112	LMV SOFTWARE VERSION AZL	Read	read in hexadecimal
113	LMV SW VER BURNER CONTROL	Read	read in hexadecimal
114	LMV SW VER LOAD CONTROL	Read	read in hexadecimal
123	LMV MINIMUM OUTPUT GAS	Read	see Mapping Notes – Note 1
124	LMV MAXIMUM OUTPUT GAS	Read	see Mapping Notes – Note 1
125	LMV MINIMUM OUTPUT OIL	Read	see Mapping Notes – Note 1
126	LMV MAXIMUM OUTPUT OIL	Read	see Mapping Notes – Note 1
127*	LMV LOAD LIMIT MODULATING	Read, Write	see Mapping Notes – Note 1
128*	LMV LOAD LIMIT STAGING	Read, Write	0=S1,1=S2,2=S3
129	LMV TEMP LIMIT ON THRESHOLD	Read	-50% to 0%
130	LMV RANGE TEMPERATURE SENSOR	Read	0=302F,1=752F,2=1562F
131	LMV ADAPTION ACTIVE	Read	0=inactive,1=active
132	LMV ADAPTION STATE	Read	
133	LMV START ADAPTION	Read, Write	0=reset,1=start,2=abort
134*	LMV ADAPTION OUTPUT	Read, Write	
135*	LMV P-VALUE	Read, Write	
136*	LMV I-VALUE	Read, Write	
137*	LMV D-VALUE	Read, Write	
138	LMV LOCKOUT ERROR CODE CURRENT	Read	see LMV5 Lockout/Error Codes
139	LMV LOCKOUT DIAG CODE CURRENT	Read	see LMV5 Lockout/Error Codes
140	LMV LOCKOUT ERR CLASS CURRENT	Read	not used
141	LMV LOCKOUT ERR PHASE CURRENT	Read	see LMV Phases
142	LMV LOCKOUT FUEL CURRENT	Read	0=gas/fuel0,1=oil/fuel1
143	LMV LOCKOUT OUTPUT CURRENT	Read	see Mapping Notes – Note 1
144	LMV LOCKOUT YEAR 2-DIG CURRENT	Read	
145	LMV LOCKOUT MONTH CURRENT	Read	
146	LMV LOCKOUT DAY CURRENT	Read	
147	LMV LOCKOUT HOUR CURRENT	Read	
148	LMV LOCKOUT MINUTE CURRENT	Read	
149	LMV LOCKOUT SECOND CURRENT	Read	
150	LMV LOCKOUT STARTUPS CURRENT	Read	
151	LMV LOCKOUT HOURS CURRENT	Read	
152	LMV ERROR ERROR CODE CURRENT	Read	see LMV5 Lockout/Error Codes
153	LMV ERROR DIAG CODE CURRENT	Read	see LMV5 Lockout/Error Codes
154	LMV ERROR ERROR CLASS CURRENT	Read	not used
155	LMV ERROR ERROR PHASE CURRENT	Read	see LMV Phases
156	LMV ERROR FUEL CURRENT	Read	0=gas/fuel0,1=oil/fuel1
157	LMV ERROR OUTPUT CURRENT	Read	see Mapping Notes – Note 1
158	LMV ERROR STARTUPS CURRENT	Read	
0.0	LMV CONTROLLER SWITCH	Status	
0.1	LMV FAN CONTACTOR	Status	
0.2	LMV OIL SELECTED	Status	
0.3	LMV GAS SELECTED	Status	
0.5	LMV OIL PRESS SW MAX	Status	
0.6	LMV OIL PRESS SW MIN	Status	
0.7	LMV VALVE PROVING SW	Status	
0.8	LMV SAFETY LOOP	Status	

Ethernet/IP LMV5... Mapping

Variable = LMV_<ARRAY NAME>_<Node ID>

INDEX	DESCRIPTION	ARRAY NAME(S)	NOTES
0.10	LMV GAS PRESS SW MIN	Status	
0.11	LMV GAS PRESS SW MAX	Status	
0.13	LMV AIR PRESSURE SW	Status	
0.14	LMV START RELEASE OIL	Status	
0.15	LMV HEAVY OIL START	Status	
1.0	LMV ALARM	Status	
1.4	LMV IGNITION	Status	
1.5	LMV START SIGNAL	Status	
1.6	LMV FAN OUTPUT	Status	
1.7	LMV OIL PUMP	Status	
1.8	LMV FUEL VALVE SV OIL	Status	
1.9	LMV FUEL VALVE V1 OIL	Status	
1.10	LMV FUEL VALVE V2 OIL	Status	
1.11	LMV FUEL VALVE V3 OIL	Status	
1.12	LMV FUEL VALVE SV GAS	Status	
1.13	LMV FUEL VALVE V1 GAS	Status	
1.14	LMV FUEL VALVE V2 GAS	Status	
1.15	LMV FUEL VALVE PV GAS	Status	

Ethernet/IP – Mapping (continued)

LMV3...

Ethernet/IP LMV3... Mapping

Variable = LMV_<ARRAY NAME>_<Node ID>

INDEX	DESCRIPTION	ARRAY NAME(S)	NOTES
0	LMV PHASE	Read	see LMV Phases
1	LMV FUEL ACTUATOR	Read	
4	LMV AIR ACTUATOR	Read	
8	LMV VSD OUTPUT	Read	
9	LMV CURRENT FUEL	Read	0=gas/fuel0,1=oil/fuel1
10	LMV CURRENT OUTPUT	Read	see Mapping Notes – Note 1
13	LMV FLAME SIGNAL	Read	
14	LMV FUEL THROUGHPUT	Read	
21	LMV STARTUP COUNTER	Read	
25	LMV CURRENT ERROR CODE	Read	see LMV3 Error Codes
26	LMV CURRENT DIAGNOSTIC CODE	Read	see LMV3 Error Codes
27	LMV CURRENT ERROR CLASS	Read	not used
28	LMV CURRENT ERROR PHASE	Read	see LMV Phases
35	LMV INPUT WORD	Read	word of bits
37	LMV OUTPUT WORD	Read	word of bits
38*	LMV PROGRAM STOP	Read, Write	see Mapping Notes – Note 3
41	LMV MODBUS LOCAL/REMOTE	Read, Write	0=local,1=remote
42*	LMV MODBUS WATCHDOG	Read, Write	
43	LMV MODBUS OPERATING MODE	Read, Write	0=auto,1=on,2=off
45	LMV MODBUS OUTPUT	Read, Write	see Mapping Notes – Note 1
56*	LMV HOURS RUN FUEL 0 RESET	Read, Write	
58*	LMV HOURS RUN FUEL 1 RESET	Read, Write	
68	LMV HOURS CONNECTED TO POWER	Read	
70*	LMV STARTUPS FUEL 0 RESET	Read, Write	
72*	LMV STARTUPS FUEL 1 RESET	Read, Write	
76	LMV STARTUPS TOTAL FIXED	Read	
78*	LMV TOTAL VOLUME FUELO	Read, Write	
80*	LMV TOTAL VOLUME FUEL1	Read, Write	
82	LMV NUMBER OF LOCKOUTS	Read	
84*	LMV PRESELECTED OUTPUT FUEL 0	Read, Write	see Mapping Notes – Note 1
85*	LMV PRESELECTED OUTPUT FUEL 1	Read, Write	see Mapping Notes – Note 1
106	LMV BC PARAMETER SET CODE	Read	
107	LMV BC PARAMETER SET VER	Read	
108	LMV BC ID DATE YEAR 2-DIGIT	Read	
109	LMV BC ID DATE MONTH	Read	
110	LMV BURNER CONTROL ID DATE DAY	Read	
111	LMV BURNER CONTROL ID NUMBER	Read	
113	LMV SW VER BURNER CONTROL	Read	read in hexadecimal
123	LMV MINIMUM OUTPUT FUEL 0	Read	see Mapping Notes – Note 1
124	LMV MAXIMUM OUTPUT FUEL 0	Read	see Mapping Notes – Note 1
125	LMV MINIMUM OUTPUT FUEL 1	Read	see Mapping Notes – Note 1
126	LMV MAXIMUM OUTPUT FUEL 1	Read	see Mapping Notes – Note 1
127	LMV OPERATION FUEL 0	Read	see Mapping Notes – Note 7
128	LMV OPERATION FUEL 1	Read	see Mapping Notes – Note 7

Ethernet/IP LMV3... Mapping

Variable = LMV_<ARRAY NAME>_<Node ID>

INDEX	DESCRIPTION	ARRAY NAME(S)	NOTES
129	LMV REVERT TO PILOT CYCLES	Read	
140	LMV OPERATION FUEL 0 NEW	Read	see Mapping Notes – Note 7
141	LMV OPERATION FUEL 1 NEW	Read	see Mapping Notes – Note 7
142	LMV REVERT TO PILOT CYCLES NEW	Read	
144	LMV LOW TRIM FUEL 0	Read	
145	LMV HIGH TRIM FUEL 0	Read	
146	LMV LOW TRIM FUEL 1	Read	
147	LMV HIGH TRIM FUEL 1	Read	
148	LMV ANALOG INPUT TRIM	Read	
149	LMV CURRENT TRIM	Read	
150	LMV ABSOLUTE SPEED	Read	
151	LMV MAINS VOLTAGE	Read	
152	LMV ERROR ERROR CODE CURRENT	Read	see LMV3 Error Codes
153	LMV ERROR DIAG CODE CURRENT	Read	see LMV3 Error Codes
154	LMV ERROR ERROR CLASS CURRENT	Read	not used
155	LMV ERROR ERROR PHASE CURRENT	Read	
156	LMV ERROR FUEL CURRENT	Read	0=gas/fuel0,1=oil/fuel1
157	LMV ERROR OUTPUT CURRENT	Read	see Mapping Notes – Note 1
158	LMV ERROR STARTUPS CURRENT	Read	
0.0	LMV CONTROLLER SWITCH	Status	
0.7	LMV VALVE PROVING SW	Status	
0.8	LMV SAFETY LOOP	Status	
0.10	LMV GAS PRESS SW MIN	Status	
0.11	LMV GAS PRESS SW MAX	Status	
0.13	LMV AIR PRESSURE SW	Status	
1.0	LMV ALARM	Status	
1.4	LMV IGNITION	Status	
1.6	LMV FAN OUTPUT	Status	
1.13	LMV FUEL VALVE V1	Status	
1.14	LMV FUEL VALVE V2	Status	
1.15	LMV FUEL VALVE V3/PV	Status	

Ethernet/IP – Mapping (continued)

LME7...

Ethernet/IP LME7... Mapping

Variable = LME7_<ARRAY NAME>_<Node ID>

INDEX	DESCRIPTION	ARRAY NAME(S)	NOTES
0	PHASE	Read	see LME7 Phases
1	FLAME PERCENT LME71/LME73	Read	
2	MAINS VOLTAGE	Read	
3	STARTUPS RESETTABLE	Read	
4	STARTUPS TOTAL	Read	
5	RELAY K12 CYCLES	Read	
6	RELAY K11 CYCLES	Read	
7	RELAY K2 CYCLES	Read	
8	RELAY K1 CYCLES	Read	
9	MAX RELAY CYCLES	Read	
10	CURRENT OUTPUT PERCENT	Read	> 100 is stages (101=S1, 102=S2)
11	ACTUATOR ACTUAL PERCENT	Read	65535 (-1) = not optioned
12	ACTUATOR TARGET PERCENT	Read	65535 (-1) = not optioned
13	EXT LOAD CONTROLLER PERCENT	Read	65535 (-1) = not optioned
14	FAN SPEED RPM	Read	65535 (-1) = not optioned
15	FAN SPEED PERCENT	Read	65535 (-1) = not optioned
16	TARGET FAN SPEED PERCENT	Read	65535 (-1) = not optioned
17	PWM SIGNAL PERCENT	Read	65535 (-1) = not optioned
18	FLAME 1 PERCENT LME75	Read	
19	FLAME 2 PERCENT LME75	Read	
20	CURRENT ERROR CODE	Read	see LME7 Error Codes
21	CURRENT ERROR STARTUPS	Read	
22	CURRENT ERROR PHASE	Read	see LME7 Phases
23	CURRENT ERROR LOAD	Read	
24	HISTORY 1 ERROR CODE	Read	see LME7 Error Codes
25	HISTORY 1 ERROR STARTUPS	Read	
26	HISTORY 1 ERROR PHASE	Read	see LME7 Phases
27	HISTORY 1 ERROR LOAD	Read	
28	HISTORY 2 ERROR CODE	Read	see LME7 Error Codes
29	HISTORY 2 ERROR STARTUPS	Read	
30	HISTORY 2 ERROR PHASE	Read	see LME7 Phases
31	HISTORY 2 ERROR LOAD	Read	
32	HISTORY 3 ERROR CODE	Read	see LME7 Error Codes
33	HISTORY 3 ERROR STARTUPS	Read	
34	HISTORY 3 ERROR PHASE	Read	see LME7 Phases
35	HISTORY 3 ERROR LOAD	Read	
36	HISTORY 4 ERROR CODE	Read	see LME7 Error Codes
37	HISTORY 4 ERROR STARTUPS	Read	
38	HISTORY 4 ERROR PHASE	Read	see LME7 Phases
39	HISTORY 4 ERROR LOAD	Read	
40	HISTORY 5 ERROR CODE	Read	see LME7 Error Codes
41	HISTORY 5 ERROR STARTUPS	Read	
42	HISTORY 5 ERROR PHASE	Read	see LME7 Phases
43	HISTORY 5 ERROR LOAD	Read	

Ethernet/IP LME7... Mapping

Variable = LME7_<ARRAY NAME>_<Node ID>

INDEX	DESCRIPTION	ARRAY NAME(S)	NOTES
44	HISTORY 6 ERROR CODE	Read	see LME7 Error Codes
45	HISTORY 6 ERROR STARTUPS	Read	
46	HISTORY 6 ERROR PHASE	Read	see LME7 Phases
47	HISTORY 6 ERROR LOAD	Read	
48	HISTORY 7 ERROR CODE	Read	see LME7 Error Codes
49	HISTORY 7 ERROR STARTUPS	Read	
50	HISTORY 7 ERROR PHASE	Read	see LME7 Phases
51	HISTORY 7 ERROR LOAD	Read	
52	HISTORY 8 ERROR CODE	Read	see LME7 Error Codes
53	HISTORY 8 ERROR STARTUPS	Read	
54	HISTORY 8 ERROR PHASE	Read	see LME7 Phases
55	HISTORY 8 ERROR LOAD	Read	
56	HISTORY 9 ERROR CODE	Read	see LME7 Error Codes
57	HISTORY 9 ERROR STARTUPS	Read	
58	HISTORY 9 ERROR PHASE	Read	see LME7 Phases
59	HISTORY 9 ERROR LOAD	Read	
60	HISTORY 10 ERROR CODE	Read	see LME7 Error Codes
61	HISTORY 10 ERROR STARTUPS	Read	
62	HISTORY 10 ERROR PHASE	Read	see LME7 Phases
63	HISTORY 10 ERROR LOAD	Read	
0.0	SAFETY LIMIT (SK)	Status	TERMINAL X3.04.1
0.1	PROOF OF CLOSURE (POC)	Status	TERMINAL X2.02.4
0.4	PRESS SW VALVE PROVING (P LT)	Status	TERMINAL X9.04.2
0.5	LOW GAS PRESSURE SWITCH (Pmin)	Status	TERMINAL X5.01.2
0.6	CONTROL SWITCH (ON/OFF)	Status	TERMINAL X5.03.1
0.7	COMBUSTION AIR SWITCH (LP)	Status	TERMINAL X3.02.1
0.8	RESET TERMINAL (EK2)	Status	TERMINAL X2.03.1
0.10	INCREASE MODULATION (LR-OPEN)	Status	TERMINAL X5.03.3
0.11	DECREASE MODULATION (LR-CLOSED)	Status	TERMINAL X5.03.2
0.12	ACTUATOR FEEDBACK (SA-R)	Status	TERMINAL X2.09.4
0.14	RESET BUTTON LME	Status	
1.0	FLAME PRESENT LME71/LME73 FLAME 1 PRESENT LME75	Status	
1.1	ALARM (AL)	Status	TERMINAL X2.03.3
1.2	NO COMM TO LME		STATUS FROM OCI417
1.3	FLAME 2 PRESENT LME75	Status	
1.7	SAFETY VALVE (SV)	Status	TERMINAL X6.03.3
1.8	ACTUATOR LOW-FIRE (SA-KL)	Status	TERMINAL X2.09.2
1.9	ACTUATOR HIGH-FIRE (SA-NL)	Status	TERMINAL X2.09.3
1.10	PILOT VALVE (PV)	Status	TERMINAL X7.01.3
1.12	IGNITION (Z)	Status	TERMINAL X4.02.3
1.13	FAN (M)	Status	TERMINAL X2.01.3
1.14	VALVE 1 (V2)	Status	TERMINAL X7.02.3
1.15	VALVE 2 (V1)	Status	TERMINAL X7.04.4
2.0	PRESS SW VALVE PROVING (P LT)		TERMINAL X9.04.2
2.1	VALVE PROVING ENABLE (LT) HIGH GAS PRESSURE SWITCH (Pmax) PROOF OF CLOSURE (POC)		TERMINAL X2.02.4

Ethernet/IP LME7... Mapping

Variable = LME7_<ARRAY NAME>_<Node ID>

INDEX	DESCRIPTION	ARRAY NAME(S)	NOTES
2.2	INCREASE MODULATION (LR-OPEN)		TERMINAL X5.03.3
2.3	DECREASE MODULATION (LR-CLOSED)		TERMINAL X5.03.2
2.4	COMBUSTION AIR SWITCH (LP)		TERMINAL X3.02.1
2.5	LOW GAS PRESSURE SWITCH (Pmin)		TERMINAL X5.01.2
2.6	RESET BUTTON LME		
2.7	RESET TERMINAL (EK2)		TERMINAL X2.03.1
2.8	ACTUATOR FEEDBACK (SA-R)		TERMINAL X2.09.4
2.9	SAFETY LIMIT (SK)		TERMINAL X3.04.1
2.10	CONTROL SWITCH (ON/OFF)		TERMINAL X5.03.1
2.11	INPUT CAMS (SA-ZL)		TERMINAL X2.09.8

Ethernet/IP – Mapping (continued)

RWF10

Ethernet/IP RWF10 Mapping

Variable = RWF10_<ARRAY NAME> <Node ID>

INDEX	DESCRIPTION	ARRAY NAME(S)	NOTES
0	PROCESS VARIABLE	Read	
1	STATUS WORD	Read	
2	ANALOG OUTPUT	Read	
3	CURRENT SETPOINT	Read, Write	
4	SETPOINT ALARM 1	Read, Write	
5	SETPOINT ALARM 2	Read, Write	
6	PROPORTIONAL BAND	Read, Write	
7	INTEGRAL TIME	Read, Write	
8	DERIVATIVE TIME	Read, Write	
9	HYSTERESIS ALARM 1	Read, Write	
10	HYSTERESIS ALARM 2	Read, Write	
0.12	OUTPUT ALARM 1 BURNER	Status	
0.13	OUTPUT ALARM 2 LF HOLD	Status	

Ethernet/IP – Mapping (continued)

RWF55

Ethernet/IP RWF55 Mapping

Variable = RWF55_<ARRAY NAME>_<Node ID>

INDEX	DESCRIPTION	ARRAY NAME(S)	NOTES
0	INPUT 1 X1	Read	
1	INPUT 2 X2	Read	
2	INPUT 3 X3	Read	
3	CURRENT SETPOINT WR	Read	
4	FIRST SETPOINT SP1	Read, Write	
5	SECOND SETPOINT SP2	Read, Write	
6	REMOTE OPERATING MODE REM	Read, Write	
7	REMOTE MODE OFF ROFF	Read, Write	
8	REMOTE ON HYSTERESIS RHYS1	Read, Write	
9	REMOTE OFF HYST BOTTOM RHYS2	Read, Write	
10	REMOTE OFF HYST TOP RHYS3	Read, Write	
11	REMOTE SETPOINT SPR	Read, Write	
12	REMOTE BURNER OUTPUT RK1	Read, Write	
13	REMOTE K2 OUTPUT RK2	Read, Write	
14	REMOTE K3 OUTPUT RK3	Read, Write	
15	REMOTE K6 OUTPUT RK6	Read, Write	
16	REMOTE STAGE MODE RSTEP	Read, Write	
17	REMOTE OUTPUT RY	Read, Write	
18	REM ON HYST COOLING RHYS4	Read, Write	
19	REM OFF HYST BTM COOLING RHYS5	Read, Write	
20	REM OFF HYST TOP COOLING RHYS6	Read, Write	
21	INPUT 3 UNFILTERED TEMP	Read	
22	ACTUAL OUTPUT Y	Read	
23	BURNER ALARM	Read	
24	RAMP FUNCTION FnCt	Read, Write	
25	RAMP SLOPE rASL	Read, Write	
26	TOLERANCE BAND RAMP toLP	Read, Write	
27	LIMIT VALUE rAL	Read, Write	
28	ALARM RELAY FUNCTION FnAL	Read, Write	
29	ALARM LIMIT COMPARATOR AL	Read, Write	
30	HYSTERESIS LIMIT COMP HYST	Read, Write	
31	MODBUS WATCHDOG dtt	Read, Write	
32	FILTER INPUT 1 dF1	Read, Write	
33	FILTER INPUT 2 dF2	Read, Write	
34	FILTER INPUT 3 dF3	Read, Write	
35	ACTUAL VALUE LIMIT LOW oLLo	Read	
36	ACTUAL VALUE LIMIT HIGH oLHi	Read	
37	PROPORTIONAL BAND Pb1	Read, Write	
38	DERIVATIVE ACTION TIME dt	Read, Write	
39	INTEGRAL ACTION TIME rt	Read, Write	
40	DEAD BAND db	Read, Write	
41	ACTUATOR RUNNING TIME tt	Read, Write	
42	ON HYSTERESIS HYS1	Read, Write	
43	OFF HYSTERESIS BOTTOM HYS2	Read, Write	

Ethernet/IP RWF55 Mapping

Variable = RWF55_<ARRAY NAME>_<Node ID>

INDEX	DESCRIPTION	ARRAY NAME(S)	NOTES
44	OFF HYSTERESIS TOP HYS3	Read, Write	
45	ON HYST COOLING HYS4	Read, Write	
46	OFF HYST BTM COOLING HYS5	Read, Write	
47	OFF HYST TOP COOLING HYS6	Read, Write	
48	REACTION THRESHOLD q	Read, Write	
49	OUTSIDE TEMPERATURE 1 At1	Read, Write	
50	BOILER TEMPERATURE 1 Ht1	Read, Write	
51	OUTSIDE TEMPERATURE 2 At2	Read, Write	
52	BOILER TEMPERATURE 2 Ht2	Read, Write	
53	INPUT 1 SCALE LOW SCL1	Read, Write	
54	INPUT 1 SCALE HIGH SCH1	Read, Write	
55	OFFSET INPUT 1 OFF1	Read, Write	
56	INPUT 2 SCALE LOW SCL2	Read, Write	
57	INPUT 2 SCALE HIGH SCH2	Read, Write	
58	OFFSET INPUT 2 OFF2	Read, Write	
59	OFFSET INPUT 3 OFF3	Read, Write	
60	SETPOINT LIMIT SCALE LOW SPL	Read, Write	
61	SETPOINT LIMIT SCALE HIGH SPH	Read, Write	
0.12	INPUT 1 FAULT	Status	
0.13	INPUT 2 FAULT	Status	
0.14	INPUT 3 FAULT	Status	
1.0	STAGE MODE	Status	
1.1	MANUAL OPERATION	Status	
1.2	BINARY INPUT 1	Status	
1.3	BINARY INPUT 2	Status	
1.4	STAT ACTIVE	Status	
1.5	UP ACTIVE	Status	
1.6	DOWN ACTIVE	Status	
1.7	K6 ACTIVE	Status	

Ethernet/IP – Mapping (continued)

TS Series Hardwired Draft Control

Ethernet/IP TS Series Hardwired Draft Control Mapping

Variable = RWF10_ <ARRAY NAME>_ <Node ID>

INDEX	DESCRIPTION	ARRAY NAME(S)	NOTES
0	SETPPOINT	Read, Write	
1	HYSTERESIS	Read, Write	
2	DAMPER POSITION	Read	
3	CONTROL PHASE	Read	see Mapping Notes – Note 8
4	SENSOR MIN	Read, Write	
5	SENSOR MAX	Read, Write	
6	SENSOR TYPE	Read, Write	see Mapping Notes – Note 9
7	SENSOR FILTER TIME	Read, Write	
8	DRIVE MIN	Read, Write	
9	DRIVE MAX	Read, Write	
10	PULSE ON	Read, Write	
11	PULSE OFF	Read, Write	
12	CLOSE TIMER SP	Read, Write	
13	PERMISSIVE TIMER SP	Read, Write	
14	IGNITION TIMER SP	Read, Write	
15	REL MOD TIMER SP	Read, Write	
16	POSTPURGE TIMER SP	Read, Write	
17	CLOSE TIMER	Read	
18	PERMISSIVE TIMER	Read	
19	IGNITION TIMER	Read	
20	REL MOD TIMER	Read	
21	POSTPURGE TIMER	Read	
0.0	DAMPER CLOSED	Status	
0.1	DAMPER OPEN	Status	
0.2	DAMPER IGNITION	Status	
0.3	CALL FOR HEAT	Status	
0.4	FUEL VALVE OPEN	Status	
0.5	BLOWER RUNNING	Status	
0.6	FSG ALARM	Status	
0.7	LOW DRAFT	Status	
0.8	HIGH FIRE PURGE	Status	
1.0	PERMISSIVE	Status	
1.1	DRIVE IGNITION	Status	
1.2	DRIVE OPEN	Status	
1.3	DRIVE CLOSED	Status	

Ethernet/IP – Mapping (continued)

TS Series Deaerator/Surge Tank

This mapping applies to either standalone applications or as part of a TS Series Lead/Lag Master.

Ethernet/IP TS Series Deaerator/Surge Tank Mapping

Variable (standalone) = DSC_<ARRAY NAME>_<Node ID>

Variable (TS Series Lead/Lag Master as DA1) = DSC1_<ARRAY NAME>_<Node ID>

Variable (TS Series Lead/Lag Master as DA1) = DSC2_<ARRAY NAME>_<Node ID>

INDEX	DESCRIPTION	ARRAY NAME(S)	NOTES
0	P1 HOA	Read	
1	P2 HOA	Read	
2	P3 HOA	Read	
3	P4 HOA	Read	
4	P5 HOA	Read	
5	P6 HOA	Read	
6	DA RWF WTR LEVEL E1	Read	
7	DA RWF WTR LEVEL E2	Read	
8	DA RWF WTR LEVEL SP WR	Read	
9	DA RWF WTR LEVEL PCT Y	Read	
10	SRG RWF WTR LEVEL E1	Read	
11	SRG RWF WTR LEVEL E2	Read	
12	SRG RWF WTR LEVEL SP WR	Read	
13	SRG RWF WTR LEVEL PCT Y	Read	
14	STEAM RWF PRS E1	Read	
15	STEAM RWF PRS E2	Read	
16	STEAM RWF PRS SP WR	Read	
17	STEAM RWF PRS PCT Y	Read	
18	BU DA WTR LEVEL E1	Read	
19	BU DA WTR LEVEL E2	Read	
20	BU DA WTR LEVEL SP WR	Read	
21	BU DA WTR LEVEL PCT Y	Read	
22	BU SRG WTR LEVEL E1	Read	
23	BU SRG WTR LEVEL E2	Read	
24	BU SRG WTR LEVEL SP WR	Read	
25	BU SRG WTR LEVEL PCT Y	Read	
26	P1 RUN HOURS	Read	
27	P2 RUN HOURS	Read	
28	P3 RUN HOURS	Read	
29	P4 RUN HOURS	Read	
30	P5 RUN HOURS	Read	
31	P6 RUN HOURS	Read	
32	RTD 1	Read	
33	RTD 2	Read	
34	RTD 3	Read	
35	RTD 4	Read	
36	ANALOG INPUT 1	Read	
37	ANALOG INPUT 2	Read	
38	ANALOG INPUT 3	Read	
39	ANALOG INPUT 4	Read	
40	ANALOG INPUT 5	Read	

Ethernet/IP TS Series Deaerator/Surge Tank Mapping

Variable (standalone) = DSC_<ARRAY NAME>_<Node ID>

Variable (TS Series Lead/Lag Master as DA1) = DSC1_<ARRAY NAME>_<Node ID>

Variable (TS Series Lead/Lag Master as DA1) = DSC2_<ARRAY NAME>_<Node ID>

INDEX	DESCRIPTION	ARRAY NAME(S)	NOTES
41	ANALOG INPUT 6	Read	
42	ANALOG INPUT 7	Read	
43	ANALOG INPUT 8	Read	
44	ANALOG OUTPUT 1	Read	
45	ANALOG OUTPUT 2	Read	
46	ANALOG OUTPUT 3	Read	
47	ANALOG OUTPUT 4	Read	
48	ANALOG OUTPUT 5	Read	
49	ANALOG OUTPUT 6	Read	
50	ANALOG OUTPUT 7	Read	
51	ANALOG OUTPUT 8	Read	
52	DA SETPOINT MSC	Read	
53	DA FW PRESSURE MSC	Read	
54	DA DROP PUMP MSC	Read	
55	DA ADD PUMP MSC	Read	
56	DA SETPOINT VFD	Read	
57	DA FW PRESSURE CH4 VFD	Read	
58	DA FW PRESSURE OFFSET VFD	Read	
59	DA DROP PUMP VFD	Read	
60	DA ADD PUMP VFD	Read	
61	DA START DELAY	Read	
62	DA STOP DELAY	Read	
63	DA MIN RUN TIME	Read	
64	DA OVERLAP TIME	Read	
65	DA ALTERNATION TIME	Read	
66	SRG SETPOINT MSC	Read	
67	SRG FW PRESSURE MSC	Read	
68	SRG DROP PUMP MSC	Read	
69	SRG ADD PUMP MSC	Read	
70	SRG SETPOINT VFD	Read	
71	SRG FW PRESSURE CH4 VFD	Read	
72	SRG FW PRESSURE OFFSET VFD	Read	
73	SRG DROP PUMP VFD	Read	
74	SRG ADD PUMP VFD	Read	
75	SRG START DELAY	Read	
76	SRG STOP DELAY	Read	
77	SRG MIN RUN TIME	Read	
78	SRG OVERLAP TIME	Read	
79	SRG ALTERNATION TIME	Read	
80	P1 MANUAL VFD	Read	
81	P2 MANUAL VFD	Read	
82	P3 MANUAL VFD	Read	
83	P4 MANUAL VFD	Read	
84	P5 MANUAL VFD	Read	
85	P6 MANUAL VFD	Read	
86	CT LEAD START DELAY	Read	

Ethernet/IP TS Series Deaerator/Surge Tank Mapping

Variable (standalone) = DSC_<ARRAY NAME>_<Node ID>

Variable (TS Series Lead/Lag Master as DA1) = DSC1_<ARRAY NAME>_<Node ID>

Variable (TS Series Lead/Lag Master as DA1) = DSC2_<ARRAY NAME>_<Node ID>

INDEX	DESCRIPTION	ARRAY NAME(S)	NOTES
87	CT LAG START DELAY	Read	
88	CT TIMED LEAD START	Read	
89	CT TIMED LAG START	Read	
0.0	LEAD LAG STATUS	Status	
0.1	DA HIGH WATER	Status	
0.2	DA LOW WATER	Status	
0.3	DA LOW LOW WATER	Status	
0.4	SRG HIGH WATER	Status	
0.5	SRG LOW WATER	Status	
0.6	SRG LOW LOW WATER	Status	
0.7	CT LAG START	Status	
0.8	CT LEAD START	Status	
0.9	CT LEAD LAG STATUS	Status	
0.10	P1 PROVEN	Status	
0.11	P2 PROVEN	Status	
0.12	P3 PROVEN	Status	
0.13	P4 PROVEN	Status	
0.14	P5 PROVEN	Status	
0.15	P6 PROVEN	Status	
1.0	P1 FAIL	Status	
1.1	P2 FAIL	Status	
1.2	P3 FAIL	Status	
1.3	P4 FAIL	Status	
1.4	P5 FAIL	Status	
1.5	P6 FAIL	Status	
1.6	CT LEAD PUMP START	Status	
1.7	CT LAG PUMP START	Status	
1.8	CT TIMED LEAD START	Status	
1.9	CT TIMED LAG START	Status	

Ethernet/IP – Mapping (continued)

TS Series Touchscreen Kit

Ethernet/IP TS Series Touchscreen Kit Mapping

Variable = TSK_<ARRAY NAME>_<Node ID>

INDEX	DESCRIPTION	ARRAY NAME(S)	NOTES
0	LMV PHASE	Read	see LMV Phases
1	LMV FUEL ACTUATOR	Read	
2	LMV GAS ACTUATOR	Read	
3	LMV OIL ACTUATOR	Read	
4	LMV AIR ACTUATOR	Read	
5	LMV AUX1 ACTUATOR	Read	
6	LMV AUX2 ACTUATOR	Read	
7	LMV AUX3 ACTUATOR	Read	
8	LMV VSD OUTPUT	Read	
9	LMV CURRENT FUEL	Read	0=gas/fuel0,1=oil/fuel1
10	LMV CURRENT OUTPUT	Read	see Mapping Notes – Note 1
11	LMV CURRENT SETPOINT	Read	
12	LMV ACTUAL VALUE	Read	
13	LMV FLAME SIGNAL	Read	
14	LMV FUEL THROUGHPUT	Read	
15	LMV CURRENT O2	Read	
16	LMV GAS UNIT	Read	0=metric,1=standard
17	LMV OIL UNIT	Read	0=metric,1=standard
18	LMV TEMPERATURE UNIT	Read	0=metric,1=standard
19	LMV PRESSURE UNIT	Read	0=metric,1=standard
20	LMV SENSOR SELECTION	Read	see Mapping Notes – Note 2
21	LMV STARTUP COUNTER	Read	
22	LMV HOUR COUNTER	Read	
23	LMV CURRENT ERROR CODE	Read	see LMV... Lockout/Error Codes
24	LMV CURRENT DIAGNOSTIC CODE	Read	see LMV... Lockout/Error Codes
25	LMV CURRENT ERROR CLASS	Read	not used
26	LMV CURRENT ERROR PHASE	Read	see LMV Phases
27	LMV TEMP LIMIT OFF THRESHOLD	Read	
28	LMV SUPPLY AIR TEMPERATURE	Read	
29	LMV FLUE GAS TEMPERATURE	Read	
30	LMV COMBUSTION EFFICIENCY	Read	
31	LMV CURRENT CO2	Read	
32	LMV CURRENT EXCESS AIR	Read	
33	LMV INPUT WORD	Read	word of bits
34	LMV OUTPUT WORD	Read	word of bits
35*	LMV PROGRAM STOP	Read, Write	see Mapping Notes – Note 3
36*	LMV LOAD CONTROL MODE	Read, Write	see Mapping Notes – Note 4
37	LMV MANUAL/AUTOMATIC	Read	0=auto,1=on,2=off
38	LMV MODBUS LOCAL/REMOTE	Read, Write	0=local,1=remote
39*	LMV MODBUS WATCHDOG	Read, Write	
40	LMV MODBUS OPERATING MODE	Read, Write	0=auto,1=on,2=off
41	LMV MODBUS SETPOINT W3	Read, Write	
42	LMV MODBUS OUTPUT	Read, Write	see Mapping Notes – Note 1
43*	LMV MODBUS FUEL SELECTION	Read, Write	0=gas/fuel0,1=oil/fuel1

Ethernet/IP TS Series Touchscreen Kit Mapping

Variable = TSK_<ARRAY NAME>_<Node ID>

INDEX	DESCRIPTION	ARRAY NAME(S)	NOTES
44*	LMV SETPOINT W1	Read, Write	
45*	LMV SETPOINT W2	Read, Write	
46	LMV WEEKDAY	Read	0=Sun,1=Mon,...,6=Sat
47	LMV YEAR 2-DIGIT	Read	
48	LMV MONTH	Read	
49	LMV DAY	Read	
50	LMV HOUR	Read	
51	LMV MINUTE	Read	
52	LMV SECOND	Read	
53*	LMV HOURS RUN GAS RESET	Read, Write	
54*	LMV HOURS RUN OIL S1 RESET	Read, Write	
55*	LMV HOURS RUN OIL S2 RESET	Read, Write	
56*	LMV HOURS RUN OIL S3 RESET	Read, Write	
57*	LMV HOURS RUN TOTAL RESET	Read, Write	
58	LMV HOURS RUN TOTAL FIXED	Read	
59	LMV HOURS CONNECTED TO POWER	Read	
60*	LMV STARTUPS GAS RESET	Read, Write	
61*	LMV STARTUPS OIL RESET	Read, Write	
62*	LMV STARTUPS TOTAL RESET	Read, Write	
63	LMV STARTUPS TOTAL FIXED	Read	
64*	LMV TOTAL VOLUME GAS/FUELO	Read, Write	
65*	LMV TOTAL VOLUME OIL/FUEL1	Read, Write	
66	LMV NUMBER OF LOCKOUTS	Read	
67	LMV EXTRA TEMPERATURE SENSOR	Read	
68	LMV AZL5 PARAMETER SET CODE	Read	
69	LMV AZL5 PARAMETER SET VER	Read	
70	LMV AZL5 ID DATE YEAR 2-DIGIT	Read	
71	LMV AZL5 ID DATE MONTH	Read	
72	LMV AZL5 ID DATE DAY	Read	
73	LMV AZL5 ID NUMBER	Read	
74	LMV BC PARAMETER SET CODE	Read	
75	LMV BC PARAMETER SET VER	Read	
76	LMV BC ID DATE YEAR 2-DIGIT	Read	
77	LMV BC ID DATE MONTH	Read	
78	LMV BURNER CONTROL ID DATE DAY	Read	
79	LMV BURNER CONTROL ID NUMBER	Read	
80	LMV SOFTWARE VERSION AZL	Read	read in hexadecimal
81	LMV SW VER BURNER CONTROL	Read	read in hexadecimal
82	LMV SW VER LOAD CONTROL	Read	read in hexadecimal
83	LMV MINIMUM OUTPUT GAS	Read	see Mapping Notes – Note 1
84	LMV MAXIMUM OUTPUT GAS	Read	see Mapping Notes – Note 1
85	LMV MINIMUM OUTPUT OIL	Read	see Mapping Notes – Note 1
86	LMV MAXIMUM OUTPUT OIL	Read	see Mapping Notes – Note 1
87*	LMV LOAD LIMIT MODULATING	Read, Write	see Mapping Notes – Note 1
88*	LMV LOAD LIMIT STAGING	Read, Write	0=S1,1=S2,2=S3
89	LMV TEMP LIMIT ON THRESHOLD	Read	-50% to 0%
90	LMV RANGE TEMPERATURE SENSOR	Read	0=302F,1=752F,2=1562F
91	LMV ADAPTION ACTIVE	Read	0=inactive,1=active

Ethernet/IP TS Series Touchscreen Kit Mapping

Variable = TSK_<ARRAY NAME>_<Node ID>

INDEX	DESCRIPTION	ARRAY NAME(S)	NOTES
92	LMV ADAPTION STATE	Read	
93	LMV START ADAPTION	Read, Write	0=reset,1=start,2=abort
94*	LMV ADAPTION OUTPUT	Read, Write	
95*	LMV P-VALUE	Read, Write	
96*	LMV I-VALUE	Read, Write	
97*	LMV D-VALUE	Read, Write	
98	OPERATION MODE FUEL 0	Read	see Mapping Notes – Note 7
99	OPERATION MODE FUEL 1	Read	see Mapping Notes – Note 7
100	CYCLES REVERT TO PILOT	Read	
101	LOW RANGE TRIM FUEL 0	Read	
102	HIGH RANGE TRIM FUEL 0	Read	
103	LOW RANGE TRIM FUEL 1	Read	
104	HIGH RANGE TRIM FUEL 1	Read	
105	ANALOG INPUT TRIM	Read	
106	CURRENT TRIM CORRECTION	Read	
107	ABSOLUTE SPEED RPM	Read	
108	MAINS VOLTAGE	Read	
109	REM CON HAND-OFF-AUTO	Read, Write	0=hand,1=off,2=auto
110	REM CON MAN MODE	Read, Write	0=auto,1=manual
111	REM CON MAN OUTPUT	Read, Write	see Mapping Notes – Note 1
112	LMV LOCKOUT ERROR CODE CURRENT	Read	see LMV... Lockout/Error Codes
113	LMV LOCKOUT DIAG CODE CURRENT	Read	see LMV... Lockout/Error Codes
114	LMV LOCKOUT ERR CLASS CURRENT	Read	not used
115	LMV LOCKOUT ERR PHASE CURRENT	Read	see LMV Phases
116	LMV LOCKOUT FUEL CURRENT	Read	0=gas/fuel0,1=oil/fuel1
117	LMV LOCKOUT OUTPUT CURRENT	Read	see Mapping Notes – Note 1
118	LMV LOCKOUT YEAR 2-DIG CURRENT	Read	
119	LMV LOCKOUT MONTH CURRENT	Read	
120	LMV LOCKOUT DAY CURRENT	Read	
121	LMV LOCKOUT HOUR CURRENT	Read	
122	LMV LOCKOUT MINUTE CURRENT	Read	
123	LMV LOCKOUT SECOND CURRENT	Read	
124	LMV LOCKOUT STARTUPS CURRENT	Read	see LMV... Lockout/Error Codes
125	LMV LOCKOUT HOURS CURRENT	Read	see LMV... Lockout/Error Codes
126	LMV ERROR ERROR CODE CURRENT	Read	not used
127	LMV ERROR DIAG CODE CURRENT	Read	see LMV Phases
128	LMV ERROR ERROR CLASS CURRENT	Read	0=gas/fuel0,1=oil/fuel1
129	LMV ERROR ERROR PHASE CURRENT	Read	see Mapping Notes – Note 1
130	LMV ERROR FUEL CURRENT	Read	
131	LMV ERROR OUTPUT CURRENT	Read	
132	LMV ERROR STARTUPS CURRENT	Read	
133	EQUIPMENT FAULTS	Read	
134	RWF LC INPUT WORD	Read	
135	RWF LC OUTPUT WORD	Read	
136	RWF LC E1	Read	
137	RWF LC E2	Read	
138	RWF LC E3	Read	
139	RWF LC WR CURRENT SP	Read	

Ethernet/IP TS Series Touchscreen Kit Mapping

Variable = TSK_<ARRAY NAME>_<Node ID>

INDEX	DESCRIPTION	ARRAY NAME(S)	NOTES
140	RWF LC SP1	Read, Write	
141	RWF LC SP2	Read, Write	
142	RWF LC AL ALARM SP	Read, Write	
143	RWF LC PB1 PROPORTIONAL	Read, Write	
144	RWF LC DT DERIVATIVE	Read, Write	
145	RWF LC RT INTEGRAL	Read, Write	
146	RWF LC HYS1	Read, Write	
147	RWF LC HYS3	Read, Write	
148	RWF LC DTT WATCHDOG	Read, Write	
149	RWF LC E3 UNFILTERED	Read	
150	RWF LC REM REMOTE OPERATION	Read, Write	
151	RWF LC ROFF REMOTE OFF	Read, Write	
152	RWF LC RK1 REMOTE BURNER CONTROL	Read, Write	
153	RWF LC RK6 REMOTE K6 CONTROL	Read, Write	
154	RWF LC SPR REMOTE SETPOINT	Read, Write	
155	RWF LC RY REMOTE OUTPUT	Read, Write	
156	RWF LC Y OUTPUT	Read	
157	CIRC PUMP CONTROL SIGNAL	Read	
158	CIRC PUMP OUTPUT SIGNAL	Read	
159	RWF FW INPUT WORD	Read	
160	RWF FW OUTPUT WORD	Read	
161	RWF FW LEVEL PERCENT	Read	
162	RWF FW SETPOINT PERCENT	Read	
163	RWF FW E1	Read	
164	RWF FW E2	Read	
165	RWF FW E3	Read	
166	RWF FW WR CURRENT SP	Read	
167	RWF FW SP1	Read	
168	RWF FW SP2	Read	
169	RWF FW Y	Read	
170	RWF EX1 INPUT WORD	Read	
171	RWF EX1 OUTPUT WORD	Read	
172	RWF EX1 E1	Read	
173	RWF EX1 E2	Read	
174	RWF EX1 E3	Read	
175	RWF EX1 WR CURRENT SP	Read	
176	RWF EX1 SP1	Read	
177	RWF EX1 SP2	Read	
178	RWF EX1 AL ALARM SP	Read	
179	RWF EX1 HYS1	Read	
180	RWF EX1 HYS3	Read	
181	RWF EX1 Y OUTPUT	Read	
182	RWF EX2 INPUT WORD	Read	
183	RWF EX2 OUTPUT WORD	Read	
184	RWF EX2 E1	Read	
185	RWF EX2 E2	Read	
186	RWF EX2 E3	Read	
187	RWF EX2 WR CURRENT SP	Read	

Ethernet/IP TS Series Touchscreen Kit Mapping

Variable = TSK_<ARRAY NAME>_<Node ID>

INDEX	DESCRIPTION	ARRAY NAME(S)	NOTES
188	RWF EX2 SP1	Read	
189	RWF EX2 SP2	Read	
190	RWF EX2 AL ALARM SP	Read	
191	RWF EX2 HYS1	Read	
192	RWF EX2 HYS3	Read	
193	RWF EX2 Y OUTPUT	Read	
194	EA GENERIC INPUTS 1 WORD	Read	
195	EA GENERIC INPUTS 2 WORD	Read	
196	EA GENERIC INPUTS 3 WORD	Read	
197	EA DIGITAL INPUT WORD	Read	
198	EA STATUS WORD	Read	
199	EA ALARM WORD	Read	
200	EA ANALOG INPUT 1	Read	
201	EA ANALOG INPUT 2	Read	
202	EA ANALOG INPUT 3	Read	
203	EA ANALOG INPUT 4	Read	
204	EA GENERIC INPUT 5	Read	
205	EA GENERIC INPUT 6	Read	
206	EA GENERIC INPUT 7	Read	
207	EA GENERIC INPUT 8	Read	
208	EA GENERIC INPUT 9	Read	
209	EA GENERIC INPUT 10	Read	
210	EA GENERIC INPUT 11	Read	
211	EA GENERIC INPUT 12	Read	
212	EA GENERIC INPUT 13	Read	
213	EA GENERIC INPUT 14	Read	
214	EA GENERIC INPUT 15	Read	
215	EA GENERIC INPUT 16	Read	
216	EA DRAFT FEEDBACK	Read	
217	EA DRAFT ALARM	Read	
218	EA DRAFT ALARM CODE	Read	
219	EA DRAFT ALARM PHASE	Read	
220	EA DRAFT DRIVE WORD	Read	
221	EA DRAFT SWITCH	Read	
222	EA DRAFT SENSOR	Read	
223	EA LC INPUT WORD	Read	
224	EA LC OUTPUT WORD	Read	
225	EA LC E1	Read	
226	EA LC E3	Read	
227	EA LC WR CURRENT SP	Read	
228	EA LC SP1	Read, Write	
229	EA LC AL ALARM SP	Read, Write	
230	EA LC PB1 PROPORTIONAL	Read, Write	
231	EA LC DT DERIVATIVE	Read, Write	
232	EA LC RT INTEGRAL	Read, Write	
233	EA LC HYS1	Read, Write	
234	EA LC HYS3	Read, Write	
235	EA LC REM REMOTE OPERATION	Read, Write	

Ethernet/IP TS Series Touchscreen Kit Mapping

Variable = TSK_<ARRAY NAME>_<Node ID>

INDEX	DESCRIPTION	ARRAY NAME(S)	NOTES
236	EA LC ROFF REMOTE OFF	Read, Write	
237	EA LC RK1 REMOTE BURNER CONTROL	Read, Write	
238	EA LC SPR REMOTE SETPOINT	Read, Write	
239	EA LC RY REMOTE OUTPUT	Read, Write	
240	EA LC Y OUTPUT	Read	
241	EA MONITORED OUT 1	Read	
242	EA MONITORED OUT 2	Read	
243	VSD FREQUENCY REF PERCENT	Read	
244	VSD OUTPUT FREQUENCY PERCENT	Read	
245	VSD OUTPUT VOLTAGE	Read	
246	VSD DC BUS VOLTAGE	Read	
247	VSD STATUS WORD	Read	
248	VSD OUTPUT RPM	Read	
249	VSD OUTPUT CURRENT	Read	
250	VSD FREQUENCY REFERENCE HERTZ	Read	
251	VSD OUTPUT FREQUENCY HERTZ	Read	
252	VSD ALARM CODE	Read	
253	VSD FAULT CODE	Read	
254	VSD DC BUS PEAK	Read	
255	VSD OUTPUT CURRENT PEAK	Read	
256	VSD OUTPUT POWER	Read	
257	VSD TOTALIZED POWER	Read	
258	USER VALUE 1	Read	
259	USER VALUE 2	Read	
260	USER VALUE 3	Read	
261	USER VALUE 4	Read	
262	USER VALUE 5	Read	
263	USER VALUE 6	Read	
264	USER VALUE 7	Read	
265	USER VALUE 8	Read	
266	USER VALUE 9	Read	
267	USER VALUE 10	Read	
268	USER VALUE 11	Read	
269	USER VALUE 12	Read	
270	USER VALUE 13	Read	
271	USER VALUE 14	Read	
272	USER VALUE 15	Read	
273	USER VALUE 16	Read	
0.0	LMV CONTROLLER SWITCH	Status	
0.1	LMV FAN CONTACTOR	Status	
0.2	LMV OIL SELECTED	Status	
0.3	LMV GAS SELECTED	Status	
0.5	LMV OIL PRESS SW MAX	Status	
0.6	LMV OIL PRESS SW MIN	Status	
0.7	LMV VALVE PROVING SW	Status	
0.8	LMV SAFETY LOOP	Status	
0.10	LMV GAS PRESS SW MIN	Status	
0.11	LMV GAS PRESS SW MAX	Status	

Ethernet/IP TS Series Touchscreen Kit Mapping

Variable = TSK_<ARRAY NAME>_<Node ID>

INDEX	DESCRIPTION	ARRAY NAME(S)	NOTES
0.13	LMV AIR PRESSURE SW	Status	
0.14	LMV START RELEASE OIL	Status	
0.15	LMV HEAVY OIL START	Status	
1.0	LMV ALARM	Status	
1.4	LMV IGNITION	Status	
1.5	LMV START SIGNAL	Status	
1.6	LMV FAN OUTPUT	Status	
1.7	LMV OIL PUMP	Status	
1.8	LMV FUEL VALVE SV OIL	Status	
1.9	LMV FUEL VALVE V1 OIL	Status	
1.10	LMV FUEL VALVE V2 OIL	Status	
1.11	LMV FUEL VALVE V3 OIL	Status	
1.12	LMV FUEL VALVE SV GAS	Status	
1.13	LMV FUEL VALVE V1 GAS	Status	
1.14	LMV FUEL VALVE V2 GAS	Status	
1.15	LMV FUEL VALVE PV GAS	Status	
2.0	EQUIPMENT FAULT LMV5	Status	
2.1	EQUIPMENT FAULT LMV3	Status	
2.2	EQUIPMENT FAULT RWF10 LC	Status	
2.3	EQUIPMENT FAULT UNUSED	Status	
2.4	EQUIPMENT FAULT RWF55 LC	Status	
2.5	EQUIPMENT FAULT UNUSED	Status	
2.6	EQUIPMENT FAULT RWF55 FW	Status	
2.7	EQUIPMENT FAULT EA	Status	
2.8	EQUIPMENT FAULT VSD	Status	
3.12	RWF LC INPUT 1 FAULT	Status	
3.13	RWF LC INPUT 2 FAULT	Status	
3.14	RWF LC INPUT 3 FAULT	Status	
4.0	RWF LC STAGE MODE	Status	
4.1	RWF LC MANUAL OPERATION	Status	
4.2	RWF LC BINARY INPUT 1	Status	
4.3	RWF LC BINARY INPUT 2	Status	
4.4	RWF LC STAT ACTIVE	Status	
4.5	RWF LC UP ACTIVE	Status	
4.6	RWF LC DOWN ACTIVE	Status	
4.7	RWF LC K6 ACTIVE	Status	
5.12	RWF FW INPUT 1 FAULT	Status	
5.13	RWF FW INPUT 2 FAULT	Status	
5.14	RWF FW INPUT 3 FAULT	Status	
6.0	RWF FW STAGE MODE	Status	
6.1	RWF FW MANUAL OPERATION	Status	
6.2	RWF FW BINARY INPUT 1	Status	
6.3	RWF FW BINARY INPUT 2	Status	
6.4	RWF FW STAT ACTIVE	Status	
6.5	RWF FW UP ACTIVE	Status	
6.6	RWF FW DOWN ACTIVE	Status	
6.7	RWF FW K6 ACTIVE	Status	
7.12	RWF EX1 INPUT 1 FAULT	Status	

Ethernet/IP TS Series Touchscreen Kit Mapping

Variable = TSK_<ARRAY NAME>_<Node ID>

INDEX	DESCRIPTION	ARRAY NAME(S)	NOTES
7.13	RWF EX1 INPUT 2 FAULT	Status	
7.14	RWF EX1 INPUT 3 FAULT	Status	
8.0	RWF EX1 STAGE MODE	Status	
8.1	RWF EX1 MANUAL OPERATION	Status	
8.2	RWF EX1 BINARY INPUT 1	Status	
8.3	RWF EX1 BINARY INPUT 2	Status	
8.4	RWF EX1 STAT ACTIVE	Status	
8.5	RWF EX1 UP ACTIVE	Status	
8.6	RWF EX1 DOWN ACTIVE	Status	
8.7	RWF EX1 K6 ACTIVE	Status	
9.12	RWF EX2 INPUT 1 FAULT	Status	
9.13	RWF EX2 INPUT 2 FAULT	Status	
9.14	RWF EX2 INPUT 3 FAULT	Status	
10.0	RWF EX2 STAGE MODE	Status	
10.1	RWF EX2 MANUAL OPERATION	Status	
10.2	RWF EX2 BINARY INPUT 1	Status	
10.3	RWF EX2 BINARY INPUT 2	Status	
10.4	RWF EX2 STAT ACTIVE	Status	
10.5	RWF EX2 UP ACTIVE	Status	
10.6	RWF EX2 DOWN ACTIVE	Status	
10.7	RWF EX2 K6 ACTIVE	Status	
11.0	EA GI5 HIGH ALARM	Status	
11.1	EA GI5 LOW ALARM	Status	
11.2	EA GI6 HIGH ALARM	Status	
11.3	EA GI6 LOW ALARM	Status	
11.4	EA GI7 HIGH ALARM	Status	
11.5	EA GI7 LOW ALARM	Status	
11.6	EA GI8 HIGH ALARM	Status	
11.7	EA GI8 LOW ALARM	Status	
12.0	EA GI9 HIGH ALARM	Status	
12.1	EA GI9 LOW ALARM	Status	
12.2	EA GI10 HIGH ALARM	Status	
12.3	EA GI10 LOW ALARM	Status	
12.4	EA GI11 HIGH ALARM	Status	
12.5	EA GI11 LOW ALARM	Status	
12.6	EA GI12 HIGH ALARM	Status	
12.7	EA GI12 LOW ALARM	Status	
13.0	EA GI13 HIGH ALARM	Status	
13.1	EA GI13 LOW ALARM	Status	
13.2	EA GI14 HIGH ALARM	Status	
13.3	EA GI14 LOW ALARM	Status	
13.4	EA GI15 HIGH ALARM	Status	
13.5	EA GI15 LOW ALARM	Status	
13.6	EA GI16 HIGH ALARM	Status	
13.7	EA GI16 LOW ALARM	Status	
14.0	EA INPUT 1	Status	
14.1	EA INPUT 2	Status	
14.2	EA INPUT 3	Status	

Ethernet/IP TS Series Touchscreen Kit Mapping

Variable = TSK_<ARRAY NAME>_<Node ID>

INDEX	DESCRIPTION	ARRAY NAME(S)	NOTES
14.3	EA INPUT 4	Status	
14.4	EA INPUT 5	Status	
14.5	EA INPUT 6	Status	
14.6	EA INPUT 7	Status	
14.7	EA INPUT 8	Status	
14.8	EA INPUT 9	Status	
14.9	EA INPUT 10	Status	
14.10	EA INPUT 11	Status	
14.11	EA INPUT 12	Status	
14.12	EA INPUT 13	Status	
15.0	EA PUMP PROVEN	Status	
15.1	EA PUMP ALARM	Status	
15.2	EA AI1 HIGH ALARM	Status	
15.3	EA AI1 LOW ALARM	Status	
15.4	EA AI2 HIGH ALARM	Status	
15.5	EA AI2 LOW ALARM	Status	
15.6	EA AI3 HIGH ALARM	Status	
15.7	EA AI3 LOW ALARM	Status	
15.8	EA AI4 HIGH ALARM	Status	
15.9	EA AI4 LOW ALARM	Status	
15.10	EA AO1 HIGH ALARM	Status	
15.11	EA AO1 LOW ALARM	Status	
15.12	EA AO2 HIGH ALARM	Status	
15.13	EA AO2 LOW ALARM	Status	
16.0	EA ALARM INPUT 1	Status	
16.1	EA ALARM INPUT 2	Status	
16.2	EA ALARM INPUT 3	Status	
16.3	EA ALARM INPUT 4	Status	
16.4	EA ALARM INPUT 5	Status	
16.5	EA ALARM INPUT 6	Status	
16.6	EA ALARM INPUT 7	Status	
16.7	EA ALARM INPUT 8	Status	
16.8	EA ALARM INPUT 9	Status	
16.9	EA ALARM INPUT 10	Status	
16.10	EA ALARM INPUT 11	Status	
16.11	EA ALARM INPUT 12	Status	
16.12	EA ALARM INPUT 13	Status	
17.0	EA DRAFT OPEN POSITION	Status	
17.1	EA DRAFT CLOSE POSITION	Status	
17.2	EA DRAFT START POSITION	Status	
17.3	EA DRAFT MODULATE	Status	
18.4	EA LC STAT ACTIVE	Status	
18.7	EA LC K6 ACTIVE	Status	
19.0	EA MON OUT 3 ALARM	Status	
19.1	EA MON OUT 4 ALARM	Status	
20.0	VSD RUNNING	Status	
20.1	VSD ZERO SPEED	Status	
20.4	VSD SPEED AGREE	Status	

Ethernet/IP TS Series Touchscreen Kit Mapping

Variable = TSK_<ARRAY NAME>_<Node ID>

INDEX	DESCRIPTION	ARRAY NAME(S)	NOTES
20.5	VSD READY STATE	Status	
20.6	VSD ALARM STATE	Status	
20.7	VSD FAULT STATE	Status	

Ethernet/IP – Mapping (continued)

TS Series Lead/Lag Master (Global System Data)

Ethernet/IP TS Series Lead/Lag Master Mapping (Global System Data)

Variable = LLM_Mst_<ARRAY NAME>_<Node ID>

INDEX	DESCRIPTION	ARRAY NAME(S)	NOTES
0	LLM REMOTE ENABLE	Read, Write	
1	LLM REMOTE VALID	Read, Write	
2	LLM REMOTE SETPOINT	Read, Write	
3	LLM LEAD BOILER	Read, Write	
4	LLM ALTERNATION SETPOINT	Read	
5	LLM ALT HOURS REMAINING	Read	
6	LLM CURRENT SETPOINT	Read	
7	LLM TOTAL AVAILABLE	Read	
8	LLM ACTUAL VALUE	Read	
9	LLM RTD 1	Read	
10	LLM RTD 2	Read	
11	LLM RTD 3	Read	
12	LLM RTD 4	Read	
13	LLM ANALOG INPUT 1	Read	
14	LLM ANALOG INPUT 2	Read	
15	LLM ANALOG INPUT 3	Read	
16	LLM ANALOG INPUT 4	Read	
17	LLM EXTRA INPUT	Read, Write	
18	LLM LOAD DEMAND	Read, Write	
19	LLM ANALOG INPUT 1 TOTALIZED	Read	
20	LLM ANALOG INPUT 2 TOTALIZED	Read	
21	LLM ANALOG INPUT 3 TOTALIZED	Read	
22	LLM ANALOG INPUT 4 TOTALIZED	Read	
23	LLM FREE REGISTER 1	Read, Write	
24	LLM FREE REGISTER 2	Read, Write	
25	LLM FREE REGISTER 3	Read, Write	
26	LLM FREE REGISTER 4	Read, Write	
27	LLM USER VALUE 1	Read	
28	LLM USER VALUE 2	Read	
29	LLM USER VALUE 3	Read	
30	LLM USER VALUE 4	Read	
31	LLM USER VALUE 5	Read	
32	LLM USER VALUE 6	Read	
33	LLM USER VALUE 7	Read	
34	LLM USER VALUE 8	Read	
35	LLM USER VALUE 9	Read	
36	LLM USER VALUE 10	Read	
37	LLM USER VALUE 11	Read	
38	LLM USER VALUE 12	Read	
39	LLM USER VALUE 13	Read	
40	LLM USER VALUE 14	Read	
41	LLM USER VALUE 15	Read	
42	LLM USER VALUE 16	Read	
43	LLM LOOP SETPOINT	Read, Write	

Ethernet/IP TS Series Lead/Lag Master Mapping (Global System Data)

Variable = LLM_Mst_<ARRAY NAME>_<Node ID>

INDEX	DESCRIPTION	ARRAY NAME(S)	NOTES
44	LLM LOOP OUTPUT	Read	
45	LLM LOOP P VALUE	Read, Write	
46	LLM LOOP I VALUE	Read, Write	
47	LLM LOOP D VALUE	Read, Write	
48	LLM LOOP ALT SETPOINT	Read, Write	
49	LLM LOOP ALT ELAPSED	Read	
50	LLM LOOP LEAD	Read	
51	LLM LOOP HYSTERESIS ON	Read, Write	
52	LLM LOOP HYSTERESIS OFF	Read, Write	
53	LLM LOOP PUMP 1 CURRENT	Read	
54	LLM LOOP PUMP 2 CURRENT	Read	
55	LLM LOOP PUMP 1 ALARM	Read	
56	LLM LOOP PUMP 2 ALARM	Read	
0.0	LLM AI1 LOW ALARM	Status	
0.1	LLM AI1 HIGH ALARM	Status	
0.2	LLM AI2 LOW ALARM	Status	
0.3	LLM AI2 HIGH ALARM	Status	
0.4	LLM AI3 LOW ALARM	Status	
0.5	LLM AI3 HIGH ALARM	Status	
0.6	LLM AI4 LOW ALARM	Status	
0.7	LLM AI4 HIGH ALARM	Status	
1.0	LLM RTD1 LOW ALARM	Status	
1.1	LLM RTD1 HIGH ALARM	Status	
1.2	LLM RTD2 LOW ALARM	Status	
1.3	LLM RTD2 HIGH ALARM	Status	
1.4	LLM RTD3 LOW ALARM	Status	
1.5	LLM RTD3 HIGH ALARM	Status	
1.6	LLM RTD4 LOW ALARM	Status	
1.7	LLM RTD4 HIGH ALARM	Status	
2.0	LLM B1 COMM FAULT	Status	
2.1	LLM B2 COMM FAULT	Status	
2.2	LLM B3 COMM FAULT	Status	
2.3	LLM B4 COMM FAULT	Status	
2.4	LLM B5 COMM FAULT	Status	
2.5	LLM B6 COMM FAULT	Status	
2.6	LLM B7 COMM FAULT	Status	
2.7	LLM B8 COMM FAULT	Status	
2.8	LLM MO3 ALARM	Status	
2.9	LLM MO4 ALARM	Status	
2.10	LLM MO5 ALARM	Status	
2.11	LLM MO6 ALARM	Status	
2.12	LLM PLC COMM FAULT	Status	
3.0	LLM DIGITAL INPUT 1	Status	
3.1	LLM DIGITAL INPUT 2	Status	
3.2	LLM DIGITAL INPUT 3	Status	
3.3	LLM DIGITAL INPUT 4	Status	
3.4	LLM DIGITAL INPUT 5	Status	
3.5	LLM DIGITAL INPUT 6	Status	

Ethernet/IP TS Series Lead/Lag Master Mapping (Global System Data)

Variable = LLM_Mst_ <ARRAY NAME>_ <Node ID>

INDEX	DESCRIPTION	ARRAY NAME(S)	NOTES
4.0	LLM LOOP OUTPUT 1	Status	
4.1	LLM LOOP OUTPUT 2	Status	
4.2	LLM LOOP PUMP 1 RUN	Status	
4.3	LLM LOOP PUMP 2 RUN	Status	
4.4	LLM LOOP PUMP 1 ALARM	Status	
4.5	LLM LOOP PUMP 2 ALARM	Status	

Ethernet/IP – Mapping (continued)TS Series Lead/Lag Master (Boiler Data)**Ethernet/IP TS Series Lead/Lag Master Mapping (Boiler Data, x = boiler designation)**

Variable = LLM_Bx_<ARRAY NAME>_<Node ID>

INDEX	DESCRIPTION	ARRAY NAME(S)	NOTES
0	Bx LMV PHASE	Read	see LMV Phases
1	Bx LMV FUEL ACTUATOR	Read	
2	Bx LMV GAS ACTUATOR	Read	
3	Bx LMV OIL ACTUATOR	Read	
4	Bx LMV AIR ACTUATOR	Read	
5	Bx LMV AUX1 ACTUATOR	Read	
6	Bx LMV AUX2 ACTUATOR	Read	
7	Bx LMV AUX3 ACTUATOR	Read	
8	Bx LMV CURRENT FUEL	Read	
9	Bx LMV VSD OUTPUT	Read	
10	Bx LMV CURRENT OUTPUT	Read	see Mapping Notes – Note 1
11	Bx LMV CURRENT SETPOINT	Read	
12	Bx LMV ACTUAL VALUE	Read	
13	Bx LMV FLAME SIGNAL	Read	
14	Bx LMV FUEL THROUGHPUT	Read	
15	Bx LMV CURRENT O2	Read	
16	Bx LMV STARTUP COUNTER	Read	
17	Bx LMV HOUR COUNTER	Read	
18	Bx LMV CURR ERROR CODE	Read	see LMV... Lockout/Error Codes
19	Bx LMV CURR DIAG CODE	Read	see LMV... Lockout/Error Codes
20	Bx LMV CURR ERROR CLASS	Read	not used
21	Bx LMV CURR ERROR PHASE	Read	see LMV Phases
22	Bx LMV SUPPLY AIR TEMP	Read	
23	Bx LMV FLUE GAS TEMP	Read	
24	Bx LMV COMB EFFICIENCY	Read	
25	Bx LMV CURRENT CO2	Read	
26	Bx LMV CURR EXCESS AIR	Read	
27	Bx LMV LD CONTROL MODE	Read	see Mapping Notes – Note 4
28	Bx LMV MODBUS LOC/REM	Read	
29	Bx LMV MODBUS MODE	Read	0=auto,1=on,2=off
30	Bx LMV MODBUS SP W3	Read	
31	Bx LMV MODBUS OUTPUT	Read	see Mapping Notes – Note 1
32	Bx LMV SETPOINT W1	Read	
33	Bx LMV SETPOINT W2	Read	
34	Bx LMV VOLUME GAS/FUELO	Read	
35	Bx LMV VOLUME OIL/FUEL1	Read	
36	Bx LMV TEMP SENSOR	Read	
37	Bx RWF E1	Read	
38	Bx RWF E2	Read	
39	Bx RWF E3	Read	
40	Bx RWF WR CURRENT SP	Read	
41	Bx RWF SP1	Read	
42	Bx FW E1	Read	
43	Bx FW E2	Read	

Ethernet/IP TS Series Lead/Lag Master Mapping (Boiler Data, x = boiler designation)

Variable = LLM_Bx_<ARRAY NAME>_<Node ID>

INDEX	DESCRIPTION	ARRAY NAME(S)	NOTES
44	Bx FW WR CURRENT SP	Read	
45	Bx FW SP1	Read	
46	Bx DRAFT SENSOR	Read	
47	Bx DRAFT FEEDBACK	Read	
48	Bx USER VALUE 1	Read	
49	Bx USER VALUE 2	Read	
50	Bx USER VALUE 3	Read	
51	Bx USER VALUE 4	Read	
52	Bx USER VALUE 5	Read	
53	Bx USER VALUE 6	Read	
54	Bx USER VALUE 7	Read	
55	Bx USER VALUE 8	Read	
56	Bx USER VALUE 9	Read	
57	Bx USER VALUE 10	Read	
58	Bx USER VALUE 11	Read	
59	Bx USER VALUE 12	Read	
60	Bx USER VALUE 13	Read	
61	Bx USER VALUE 14	Read	
62	Bx USER VALUE 15	Read	
63	Bx USER VALUE 16	Read	
64	Bx EA ANALOG 1	Read	
65	Bx EA ANALOG 2	Read	
66	Bx EA ANALOG 3	Read	
67	Bx EA ANALOG 4	Read	
68	Bx EA GENERIC INPUT 5	Read	
69	Bx EA GENERIC INPUT 6	Read	
70	Bx EA GENERIC INPUT 7	Read	
71	Bx EA GENERIC INPUT 8	Read	
72	Bx EA GENERIC INPUT 9	Read	
73	Bx EA GENERIC INPUT 10	Read	
74	Bx EA GENERIC INPUT 11	Read	
75	Bx EA GENERIC INPUT 12	Read	
76	Bx UV FLOAT 1	Read	
77	Bx UV FLOAT 2	Read	
78	Bx UV FLOAT 3	Read	
79	Bx UV FLOAT 4	Read	
80	Bx UV FLOAT 5	Read	
81	Bx UV FLOAT 6	Read	
82	Bx UV FLOAT 7	Read	
83	Bx UV FLOAT 8	Read	
84	Bx UV DINT 1	Read	
85	Bx UV DINT 2	Read	
86	Bx UV DINT 3	Read	
87	Bx UV DINT 4	Read	
88	Bx UV DINT 5	Read	
89	Bx UV DINT 6	Read	
90	Bx UV DINT 7	Read	
91	Bx UV DINT 8	Read	

Ethernet/IP TS Series Lead/Lag Master Mapping (Boiler Data, x = boiler designation)

Variable = LLM_Bx_<ARRAY NAME>_<Node ID>

INDEX	DESCRIPTION	ARRAY NAME(S)	NOTES
0.0	Bx BOILER AUTO	Status	
0.1	Bx BOILER AVAILABLE	Status	
0.2	Bx BOILER PUMP RUNNING	Status	
0.3	Bx BOILER PUMP ALARM	Status	
1.0	Bx LMV CONTROLLER SW	Status	
1.1	Bx LMV FAN CONTACTOR	Status	
1.2	Bx LMV OIL SELECTED	Status	
1.3	Bx LMV GAS SELECTED	Status	
1.5	Bx LMV OIL PRESS SW MAX	Status	
1.6	Bx LMV OIL PRESS SW MIN	Status	
1.7	Bx LMV VALVE PROVING SW	Status	
1.8	Bx LMV SAFETY LOOP	Status	
1.10	Bx LMV GAS PRESS SW MIN	Status	
1.11	Bx LMV GAS PRESS SW MAX	Status	
1.13	Bx LMV AIR PRESSURE SW	Status	
1.14	Bx LMV START REL OIL	Status	
1.15	Bx LMV HEAVY OIL START	Status	
2.0	Bx LMV ALARM	Status	
2.4	Bx LMV IGNITION	Status	
2.5	Bx LMV START SIGNAL	active/inactive	
2.6	Bx LMV FAN OUTPUT	active/inactive	
2.7	Bx LMV OIL PUMP	active/inactive	
2.8	Bx LMV VALVE SV OIL	active/inactive	
2.9	Bx LMV VALVE V1 OIL	active/inactive	
2.10	Bx LMV VALVE V2 OIL	active/inactive	
2.11	Bx LMV VALVE V3 OIL	active/inactive	
2.12	Bx LMV VALVE SV GAS	active/inactive	
2.13	Bx LMV VALVE V1 GAS	active/inactive	
2.14	Bx LMV VALVE V2 GAS	active/inactive	
2.15	Bx LMV VALVE PV GAS	active/inactive	
3.12	Bx RWF INPUT 1 FAULT	active/inactive	
3.13	Bx RWF INPUT 2 FAULT	active/inactive	
3.14	Bx RWF INPUT 3 FAULT	active/inactive	
4.0	Bx RWF STAGE MODE	active/inactive	
4.1	Bx RWF MANUAL OPERATION	active/inactive	
4.2	Bx RWF BINARY INPUT 1	active/inactive	
4.3	Bx RWF BINARY INPUT 2	active/inactive	
4.4	Bx RWF STAT ACTIVE	active/inactive	
4.5	Bx RWF UP ACTIVE	active/inactive	
4.6	Bx RWF DOWN ACTIVE	active/inactive	
4.7	Bx RWF K6 ACTIVE	active/inactive	
5.0	Bx EA INPUT 1	active/inactive	
5.1	Bx EA INPUT 2	active/inactive	
5.2	Bx EA INPUT 3	active/inactive	
5.3	Bx EA INPUT 4	active/inactive	
5.4	Bx EA INPUT 5	active/inactive	
5.5	Bx EA INPUT 6	active/inactive	
5.6	Bx EA INPUT 7	active/inactive	

Ethernet/IP TS Series Lead/Lag Master Mapping (Boiler Data, x = boiler designation)

Variable = LLM_Bx_<ARRAY NAME>_<Node ID>

INDEX	DESCRIPTION	ARRAY NAME(S)	NOTES
5.7	Bx EA INPUT 8	active/inactive	
5.8	Bx EA INPUT 9	active/inactive	
5.9	Bx EA INPUT 10	active/inactive	
5.10	Bx EA INPUT 11	active/inactive	
5.11	Bx EA INPUT 12	active/inactive	
5.12	Bx EA INPUT 13	active/inactive	
6.0	Bx EA ALARM 1	active/inactive	
6.1	Bx EA ALARM 2	active/inactive	
6.2	Bx EA ALARM 3	active/inactive	
6.3	Bx EA ALARM 4	active/inactive	
6.4	Bx EA ALARM 5	active/inactive	
6.5	Bx EA ALARM 6	active/inactive	
6.6	Bx EA ALARM 7	active/inactive	
6.7	Bx EA ALARM 8	active/inactive	
6.8	Bx EA ALARM 9	active/inactive	
6.9	Bx EA ALARM 10	active/inactive	
6.10	Bx EA ALARM 11	active/inactive	
6.11	Bx EA ALARM 12	active/inactive	
6.12	Bx EA ALARM 13	active/inactive	

LONWORKS – Mapping

SNVT names beginning with **nvo** are read-only. SNVT names beginning with **nvi** are used to write data. When writing, monitor the corresponding **nvo** SNVT to verify the write. **x** in the SNVT name represents the **Node ID** as entered when configuring the profile using the web-based configuration utility.

SNVT names marked with an asterisk (*) are EEPROM backed and should not be continuously written.

LMV5...

LONWORKS LMV5... Mapping

SNVT NAME	DESCRIPTION	SNVT TYPE	NOTES
(nvo)xLmvPhase	LMV PHASE	SNVT_count_inc_f	see LMV Phases
(nvo)xLmvFuelAct	LMV FUEL ACTUATOR	SNVT_angle_deg	
(nvo)xLmvGasAct	LMV GAS ACTUATOR	SNVT_angle_deg	
(nvo)xLmvOilAct	LMV OIL ACTUATOR	SNVT_angle_deg	
(nvo)xLmvAirAct	LMV AIR ACTUATOR	SNVT_angle_deg	
(nvo)xLmvAux1Act	LMV AUX1 ACTUATOR	SNVT_angle_deg	
(nvo)xLmvAux2Act	LMV AUX2 ACTUATOR	SNVT_angle_deg	
(nvo)xLmvAux3Act	LMV AUX3 ACTUATOR	SNVT_angle_deg	
(nvo)xLmvVsdOut	LMV VSD OUTPUT	SNVT_lev_percent	
(nvo)xLmvCurFuel	LMV CURRENT FUEL	SNVT_switch (State)	0=gas/fuel0,1=oil/fuel1
(nvo)xLmvCurOut	LMV CURRENT OUTPUT	SNVT_lev_percent	see Mapping Notes – Note 1
(nvo)xLmvCurSp	LMV CURRENT SETPOINT	SNVT_count_inc_f	
(nvo)xLmvActVal	LMV ACTUAL VALUE	SNVT_count_inc_f	
(nvo)xLmvFlame	LMV FLAME SIGNAL	SNVT_lev_percent	
(nvo)xLmvFuelMtr	LMV FUEL THROUGHPUT	SNVT_count_inc_f	
(nvo)xLmvCurO2	LMV CURRENT O2	SNVT_lev_percent	
(nvo)xLmvGasUnit	LMV GAS UNIT	SNVT_switch (State)	0=metric,1=standard
(nvo)xLmvOilUnit	LMV OIL UNIT	SNVT_switch (State)	0=metric,1=standard
(nvo)xLmvTempUn	LMV TEMPERATURE UNIT	SNVT_switch (State)	0=metric,1=standard
(nvo)xLmvPrsUn	LMV PRESSURE UNIT	SNVT_switch (State)	0=metric,1=standard
(nvo)xLmvSenSel	LMV SENSOR SELECTION	SNVT_count_inc_f	see Mapping Notes – Note 2
(nvo)xLmvSuCnt	LMV STARTUP COUNTER	SNVT_count_inc_f	
(nvo)xLmvHrCnt	LMV HOUR COUNTER	SNVT_count_inc_f	
(nvo)xLmvCurEc	LMV CURRENT ERROR CODE	SNVT_count_inc_f	see LMV5 Lockout/Error Codes
(nvo)xLmvCurDc	LMV CURRENT DIAGNOSTIC CODE	SNVT_count_inc_f	see LMV5 Lockout/Error Codes
(nvo)xLmvCurErCl	LMV CURRENT ERROR CLASS	SNVT_count_inc_f	not used
(nvo)xLmvCurErPh	LMV CURRENT ERROR PHASE	SNVT_count_inc_f	see LMV Phases
(nvo)xLmvLimOff	LMV TEMP LIMIT OFF THRESHOLD	SNVT_count_inc_f	
(nvo)xLmvSuppAir	LMV SUPPLY AIR TEMPERATURE	SNVT_count_inc_f	
(nvo)xLmvFlueGas	LMV FLUE GAS TEMPERATURE	SNVT_count_inc_f	
(nvo)xLmvCombEff	LMV COMBUSTION EFFICIENCY	SNVT_lev_percent	
(nvo)xLmvInput	LMV INPUT WORD	SNVT_count_inc_f	word of bits
(nvo)xLmvOutput	LMV OUTPUT WORD	SNVT_count_inc_f	word of bits
(nvo/nvi)xLmvPrgStop*	LMV PROGRAM STOP	SNVT_count_inc_f	see Mapping Notes – Note 3
(nvo/nvi)xLmvLcMode*	LMV LOAD CONTROL MODE	SNVT_count_inc_f	see Mapping Notes – Note 4
(nvo)xLmvManAuto	LMV MANUAL/AUTOMATIC	SNVT_count_inc_f	0=auto,1=on,2=off
(nvo/nvi)xLmvMLocRem	LMV MODBUS LOCAL/REMOTE	SNVT_switch (State)	0=local,1=remote

LonWorks LMV5... Mapping

SNVT NAME	DESCRIPTION	SNVT TYPE	NOTES
(nvo/nvi)xLmvMWdog*	LMV MODBUS WATCHDOG	SNVT_time_sec	
(nvo/nvi)xLmvMOPMode	LMV MODBUS OPERATING MODE	SNVT_count_inc_f	0=auto,1=on,2=off
(nvo/nvi)xLmvMSPW3	LMV MODBUS SETPOINT W3	SNVT_count_inc_f	
(nvo/nvi)xLmvMOutput	LMV MODBUS OUTPUT	SNVT_lev_percent	see Mapping Notes – Note 1
(nvo/nvi)xLmvMFuSel*	LMV MODBUS FUEL SELECTION	SNVT_switch (State)	0=gas/fuel0,1=oil/fuel1
(nvo/nvi)xLmvSpW1*	LMV SETPOINT W1	SNVT_count_inc_f	
(nvo/nvi)xLmvSpW2*	LMV SETPOINT W2	SNVT_count_inc_f	
(nvo)xLmvWeekday	LMV WEEKDAY	SNVT_date_day	
(nvo)xLmvDt	LMV DATE	SNVT_time_stamp	
(nvo/nvi)xLmvHrGsRst*	LMV HOURS RUN GAS RESET	SNVT_count_inc_f	
(nvo/nvi)xLmvHOS1Rst*	LMV HOURS RUN OIL S1 RESET	SNVT_count_inc_f	
(nvo/nvi)xLmvHOS2Rst*	LMV HOURS RUN OIL S2 RESET	SNVT_count_inc_f	
(nvo/nvi)xLmvHOS3Rst*	LMV HOURS RUN OIL S3 RESET	SNVT_count_inc_f	
(nvo/nvi)xLmvHTotRst*	LMV HOURS RUN TOTAL RESET	SNVT_count_inc_f	
(nvo)xLmvHTotFix	LMV HOURS RUN TOTAL FIXED	SNVT_count_inc_f	
(nvo)xLmvHrPower	LMV HOURS CONNECTED TO POWER	SNVT_count_inc_f	
(nvo/nvi)xLmvSGasRst*	LMV STARTUPS GAS RESET	SNVT_count_inc_f	
(nvo/nvi)xLmvSOilRst*	LMV STARTUPS OIL RESET	SNVT_count_inc_f	
(nvo/nvi)xLmvSTotRst*	LMV STARTUPS TOTAL RESET	SNVT_count_inc_f	
(nvo)xLmvSTotFix	LMV STARTUPS TOTAL FIXED	SNVT_count_inc_f	
(nvo/nvi)xLmvVolGas*	LMV TOTAL VOLUME GAS	SNVT_count_inc_f	
(nvo/nvi)xLmvVolOil*	LMV TOTAL VOLUME OIL	SNVT_count_inc_f	
(nvo)xLmvNumLo	LMV NUMBER OF LOCKOUTS	SNVT_count_inc_f	
(nvo)xLmvExTemp	LMV EXTRA TEMPERATURE SENSOR	SNVT_count_inc_f	
(nvo)xLmvAzl5PSC	LMV AZL5 PARAMETER SET CODE	SNVT_count_inc_f	
(nvo)xLmvAzl5PSV	LMV AZL5 PARAMETER SET VER	SNVT_count_inc_f	
(nvo)xLmvAzl5Dt	LMV AZL5 ID DATE	SNVT_time_stamp	
(nvo)xLmvAzl5Id	LMV AZL5 ID NUMBER	SNVT_count_inc_f	
(nvo)xLmvBcPSC	LMV BC PARAMETER SET CODE	SNVT_count_inc_f	
(nvo)xLmvBcPSV	LMV BC PARAMETER SET VER	SNVT_count_inc_f	
(nvo)xLmvBcIdDt	LMV BC ID DATE	SNVT_time_stamp	
(nvo)xLmvBcId	LMV BURNER CONTROL ID NUMBER	SNVT_count_inc_f	
(nvo)xLmvSwVAzl	LMV SOFTWARE VERSION AZL	SNVT_count_inc_f	read in hexadecimal
(nvo)xLmvSwVBc	LMV SW VER BURNER CONTROL	SNVT_count_inc_f	read in hexadecimal
(nvo)xLmvSwVLc	LMV SW VER LOAD CONTROL	SNVT_count_inc_f	read in hexadecimal
(nvo)xLmvMinGas	LMV MINIMUM OUTPUT GAS	SNVT_lev_percent	see Mapping Notes – Note 1
(nvo)xLmvMaxGas	LMV MAXIMUM OUTPUT GAS	SNVT_lev_percent	see Mapping Notes – Note 1
(nvo)xLmvMinOil	LMV MINIMUM OUTPUT OIL	SNVT_lev_percent	see Mapping Notes – Note 1
(nvo)xLmvMaxOil	LMV MAXIMUM OUTPUT OIL	SNVT_lev_percent	see Mapping Notes – Note 1
(nvo/nvi)xLmvLLimMod*	LMV LOAD LIMIT MODULATING	SNVT_lev_percent	see Mapping Notes – Note 1
(nvo/nvi)xLmvLLimStg*	LMV LOAD LIMIT STAGING	SNVT_count_inc_f	0=S1,1=S2,2=S3
(nvo)xLmvLimOn	LMV TEMP LIMIT ON THRESHOLD	SNVT_lev_percent	-50% to 0%
(nvo)xLmvRngTSen	LMV RANGE TEMPERATURE SENSOR	SNVT_count_inc_f	0=302F,1=752F,2=1562F
(nvo)xLmvAdptAct	LMV ADAPTION ACTIVE	SNVT_switch (State)	0=inactive,1=active
(nvo)xLmvAdptState	LMV ADAPTION STATE	SNVT_count_inc_f	
(nvo/nvi)xLmvStartAd	LMV START ADAPTION	SNVT_count_inc_f	0=reset,1=start,2=abort
(nvo/nvi)xLmvAdptOut*	LMV ADAPTION OUTPUT	SNVT_lev_percent	
(nvo/nvi)xLmvP-Value*	LMV P-VALUE	SNVT_lev_percent	
(nvo/nvi)xLmvI-Value*	LMV I-VALUE	SNVT_time_sec	

LonWorks LMV5... Mapping

SNVT NAME	DESCRIPTION	SNVT TYPE	NOTES
(nvo/nvi)xLmvD-Value*	LMV D-VALUE	SNVT_time_sec	
(nvo)xLmvLoEcCur	LMV LOCKOUT ERROR CODE CURRENT	SNVT_count_inc_f	see LMV5 Lockout/Error Codes
(nvo)xLmvLoDcCur	LMV LOCKOUT DIAG CODE CURRENT	SNVT_count_inc_f	see LMV5 Lockout/Error Codes
(nvo)xLmvLoClCur	LMV LOCKOUT ERR CLASS CURRENT	SNVT_count_inc_f	not used
(nvo)xLmvLoPhCur	LMV LOCKOUT ERR PHASE CURRENT	SNVT_count_inc_f	see LMV Phases
(nvo)xLmvLoFuCur	LMV LOCKOUT FUEL CURRENT	SNVT_switch (State)	0=gas/fuel0,1=oil/fuel1
(nvo)xLmvLoOpCur	LMV LOCKOUT OUTPUT CURRENT	SNVT_lev_percent	see Mapping Notes – Note 1
(nvo)xLmvLoDtCur	LMV LOCKOUT DATE	SNVT_time_stamp	
(nvo)xLmvLoSuCur	LMV LOCKOUT STARTUPS CURRENT	SNVT_count_inc_f	
(nvo)xLmvLoHrCur	LMV LOCKOUT HOURS CURRENT	SNVT_count_inc_f	
(nvo)xLmvErEcCur	LMV ERROR ERROR CODE CURRENT	SNVT_count_inc_f	see LMV5 Lockout/Error Codes
(nvo)xLmvErDcCur	LMV ERROR DIAG CODE CURRENT	SNVT_count_inc_f	see LMV5 Lockout/Error Codes
(nvo)xLmvErClCur	LMV ERROR ERROR CLASS CURRENT	SNVT_count_inc_f	not used
(nvo)xLmvErPhCur	LMV ERROR ERROR PHASE CURRENT	SNVT_count_inc_f	see LMV Phases
(nvo)xLmvErFuCur	LMV ERROR FUEL CURRENT	SNVT_switch (State)	0=gas/fuel0,1=oil/fuel1
(nvo)xLmvErOpCur	LMV ERROR OUTPUT CURRENT	SNVT_lev_percent	see Mapping Notes – Note 1
(nvo)xLmvErSuCur	LMV ERROR STARTUPS CURRENT	SNVT_count_inc_f	
(nvo)xLmvCntlSw	LMV CONTROLLER SWITCH	SNVT_switch (State)	
(nvo)xLmvFan	LMV FAN CONTACTOR	SNVT_switch (State)	
(nvo)xLmvOilSel	LMV OIL SELECTED	SNVT_switch (State)	
(nvo)xLmvGasSel	LMV GAS SELECTED	SNVT_switch (State)	
(nvo)xLmvOilMax	LMV OIL PRESS SW MAX	SNVT_switch (State)	
(nvo)xLmvOilMin	LMV OIL PRESS SW MIN	SNVT_switch (State)	
(nvo)xLmvVlvPrv	LMV VALVE PROVING SW	SNVT_switch (State)	
(nvo)xLmvSftyLp	LMV SAFETY LOOP	SNVT_switch (State)	
(nvo)xLmvGasMin	LMV GAS PRESS SW MIN	SNVT_switch (State)	
(nvo)xLmvGasMax	LMV GAS PRESS SW MAX	SNVT_switch (State)	
(nvo)xLmvAirPrs	LMV AIR PRESSURE SW	SNVT_switch (State)	
(nvo)xLmvStRIOil	LMV START RELEASE OIL	SNVT_switch (State)	
(nvo)xLmvHvyOlst	LMV HEAVY OIL START	SNVT_switch (State)	
(nvo)xLmvAlarm	LMV ALARM	SNVT_switch (State)	
(nvo)xLmvIgn	LMV IGNITION	SNVT_switch (State)	
(nvo)xLmvStSig	LMV START SIGNAL	SNVT_switch (State)	
(nvo)xLmvFanOut	LMV FAN OUTPUT	SNVT_switch (State)	
(nvo)xLmvOilPump	LMV OIL PUMP	SNVT_switch (State)	
(nvo)xLmvFvSvOil	LMV FUEL VALVE SV OIL	SNVT_switch (State)	
(nvo)xLmvFvV1Oil	LMV FUEL VALVE V1 OIL	SNVT_switch (State)	
(nvo)xLmvFvV2Oil	LMV FUEL VALVE V2 OIL	SNVT_switch (State)	
(nvo)xLmvFvV3Oil	LMV FUEL VALVE V3 OIL	SNVT_switch (State)	
(nvo)xLmvFvSvGas	LMV FUEL VALVE SV GAS	SNVT_switch (State)	
(nvo)xLmvFvV1Gas	LMV FUEL VALVE V1 GAS	SNVT_switch (State)	
(nvo)xLmvFvV2Gas	LMV FUEL VALVE V2 GAS	SNVT_switch (State)	
(nvo)xLmvFvV3Gas	LMV FUEL VALVE PV GAS	SNVT_switch (State)	

LONWORKS – Mapping (continued)

LMV3...

LONWORKS LMV3... Mapping

SNVT NAME	DESCRIPTION	SNVT TYPE	NOTES
(nvo)xLmvPhase	LMV PHASE	SNVT_count_inc_f	see LMV Phases
(nvo)xLmvFuelAct	LMV FUEL ACTUATOR	SNVT_angle_deg	
(nvo)xLmvAirAct	LMV AIR ACTUATOR	SNVT_angle_deg	
(nvo)xLmvVsdOut	LMV VSD OUTPUT	SNVT_lev_percent	
(nvo)xLmvCurFuel	LMV CURRENT FUEL	SNVT_switch (State)	0=gas/fuel0,1=oil/fuel1
(nvo)xLmvCurOut	LMV CURRENT OUTPUT	SNVT_lev_percent	see Mapping Notes – Note 1
(nvo)xLmvFlame	LMV FLAME SIGNAL	SNVT_lev_percent	
(nvo)xLmvFuelMtr	LMV FUEL THROUGHPUT	SNVT_count_inc_f	
(nvo)xLmvStarts	LMV STARTUP COUNTER	SNVT_count_inc_f	
(nvo)xLmvCurEc	LMV CURRENT ERROR CODE	SNVT_count_inc_f	see LMV3 Error Codes
(nvo)xLmvCurDc	LMV CURRENT DIAGNOSTIC CODE	SNVT_count_inc_f	see LMV3 Error Codes
(nvo)xLmvCurErCl	LMV CURRENT ERROR CLASS	SNVT_count_inc_f	not used
(nvo)xLmvCurErPh	LMV CURRENT ERROR PHASE	SNVT_count_inc_f	see LMV Phases
(nvo)xLmvInput	LMV INPUT WORD	SNVT_count_inc_f	word of bits
(nvo)xLmvOutput	LMV OUTPUT WORD	SNVT_count_inc_f	word of bits
(nvo/nvi)xLmvPrgStop*	LMV PROGRAM STOP	SNVT_count_inc_f	see Mapping Notes – Note 3
(nvo/nvi)xLmvMLocRem	LMV MODBUS LOCAL/REMOTE	SNVT_switch (State)	0=local,1=remote
(nvo/nvi)xLmvMWdog*	LMV MODBUS WATCHDOG	SNVT_count_inc_f	
(nvo/nvi)xLmvMOpMode	LMV MODBUS OPERATING MODE	SNVT_count_inc_f	0=auto,1=on,2=off
(nvo/nvi)xLmvMOutput	LMV MODBUS OUTPUT	SNVT_lev_percent	see Mapping Notes – Note 1
(nvo/nvi)xLmvHrF0Rst*	LMV HOURS RUN FUEL 0 RESET	SNVT_count_inc_f	
(nvo/nvi)xLmvHrF1Rst*	LMV HOURS RUN FUEL 1 RESET	SNVT_count_inc_f	
(nvo)xLmvHrPower	LMV HOURS CONNECTED TO POWER	SNVT_count_inc_f	
(nvo/nvi)xLmvSuF0Rst*	LMV STARTUPS FUEL 0 RESET	SNVT_count_inc_f	
(nvo/nvi)xLmvSuF1Rst*	LMV STARTUPS FUEL 1 RESET	SNVT_count_inc_f	
(nvo)xLmvSusTot	LMV STARTUPS TOTAL FIXED	SNVT_count_inc_f	
(nvo/nvi)xLmvVolF0*	LMV TOTAL VOLUME FUEL0	SNVT_count_inc_f	
(nvo/nvi)xLmvVolF1*	LMV TOTAL VOLUME FUEL1	SNVT_count_inc_f	
(nvo)xLmvNumLO	LMV NUMBER OF LOCKOUTS	SNVT_count_inc_f	
(nvo/nvi)xLmvPrOutF0*	LMV PRESELECTED OUTPUT FUEL 0	SNVT_lev_percent	see Mapping Notes – Note 1
(nvo/nvi)xLmvPrOutF1*	LMV PRESELECTED OUTPUT FUEL 1	SNVT_lev_percent	see Mapping Notes – Note 1
(nvo)xLmvBcPmCd	LMV BC PARAMETER SET CODE	SNVT_count_inc_f	
(nvo)xLmvBcPmVer	LMV BC PARAMETER SET VER	SNVT_count_inc_f	
(nvo)xLmvBcIdDtY	LMV BC ID DATE YEAR 2-DIGIT	SNVT_count_inc_f	
(nvo)xLmvBcIdDtM	LMV BC ID DATE MONTH	SNVT_count_inc_f	
(nvo)xLmvBcIdDtD	LMV BURNER CONTROL ID DATE DAY	SNVT_count_inc_f	
(nvo)xLmvBcIdNum	LMV BURNER CONTROL ID NUMBER	SNVT_count_inc_f	
(nvo)xLmvSwVerBC	LMV SW VER BURNER CONTROL	SNVT_count_inc_f	read in hexadecimal
(nvo)xLmvMinF0	LMV MINIMUM OUTPUT FUEL 0	SNVT_lev_percent	see Mapping Notes – Note 1
(nvo)xLmvMaxF0	LMV MAXIMUM OUTPUT FUEL 0	SNVT_lev_percent	see Mapping Notes – Note 1
(nvo)xLmvMinF1	LMV MINIMUM OUTPUT FUEL 1	SNVT_lev_percent	see Mapping Notes – Note 1
(nvo)xLmvMaxF1	LMV MAXIMUM OUTPUT FUEL 1	SNVT_lev_percent	see Mapping Notes – Note 1
(nvo)xLmvOpF0	LMV OPERATION FUEL 0	SNVT_count_inc_f	see Mapping Notes – Note 7
(nvo)xLmvOpF1	LMV OPERATION FUEL 1	SNVT_count_inc_f	see Mapping Notes – Note 7
(nvo)xLmvRevPil	LMV REVERT TO PILOT CYCLES	SNVT_count_inc_f	

LonWORKS LMV3... Mapping

SNVT NAME	DESCRIPTION	SNVT TYPE	NOTES
(nvo)xLmvOpF0N	LMV OPERATION FUEL 0 NEW	SNVT_count_inc_f	see Mapping Notes – Note 7
(nvo)xLmvOpF1N	LMV OPERATION FUEL 1 NEW	SNVT_count_inc_f	see Mapping Notes – Note 7
(nvo)xLmvRevPilN	LMV REVERT TO PILOT CYCLES NEW	SNVT_count_inc_f	
(nvo)xLmvLowTF0	LMV LOW TRIM FUEL 0	SNVT_lev_percent	
(nvo)xLmvHiTF0	LMV HIGH TRIM FUEL 0	SNVT_lev_percent	
(nvo)xLmvLowTF1	LMV LOW TRIM FUEL 1	SNVT_lev_percent	
(nvo)xLmvHiTF1	LMV HIGH TRIM FUEL 1	SNVT_lev_percent	
(nvo)xLmvAnaTr	LMV ANALOG INPUT TRIM	SNVT_lev_percent	
(nvo)xLmvCurrTr	LMV CURRENT TRIM	SNVT_lev_percent	
(nvo)xLmvAbsSpd	LMV ABSOLUTE SPEED	SNVT_rpm	
(nvo)xLmvMainV	LMV MAINS VOLTAGE	SNVT_volt_f	
(nvo)xLmvEcCur	LMV ERROR ERROR CODE CURRENT	SNVT_count_inc_f	see LMV3 Error Codes
(nvo)xLmvDcCur	LMV ERROR DIAG CODE CURRENT	SNVT_count_inc_f	see LMV3 Error Codes
(nvo)xLmvErClCur	LMV ERROR ERROR CLASS CURRENT	SNVT_count_inc_f	not used
(nvo)xLmvErPhCur	LMV ERROR ERROR PHASE CURRENT	SNVT_count_inc_f	
(nvo)xLmvErFuCur	LMV ERROR FUEL CURRENT	SNVT_count_inc_f	0=gas/fuel0,1=oil/fuel1
(nvo)xLmvErOpCur	LMV ERROR OUTPUT CURRENT	SNVT_count_inc_f	see Mapping Notes – Note 1
(nvo)xLmvErSuCur	LMV ERROR STARTUPS CURRENT	SNVT_count_inc_f	
(nvo)xLmvCntlSw	LMV CONTROLLER SWITCH	SNVT_switch (State)	
(nvo)xLmvVlvPrv	LMV VALVE PROVING SW	SNVT_switch (State)	
(nvo)xLmvSftyLp	LMV SAFETY LOOP	SNVT_switch (State)	
(nvo)xLmvGasMin	LMV GAS PRESS SW MIN	SNVT_switch (State)	
(nvo)xLmvGasMax	LMV GAS PRESS SW MAX	SNVT_switch (State)	
(nvo)xLmvAirPrs	LMV AIR PRESSURE SW	SNVT_switch (State)	
(nvo)xLmvAlarm	LMV ALARM	SNVT_switch (State)	
(nvo)xLmvIgn	LMV IGNITION	SNVT_switch (State)	
(nvo)xLmvFanOut	LMV FAN OUTPUT	SNVT_switch (State)	
(nvo)xLmvFvV1	LMV FUEL VALVE V1	SNVT_switch (State)	
(nvo)xLmvFvV2	LMV FUEL VALVE V2	SNVT_switch (State)	
(nvo)xLmvFvV3Pv	LMV FUEL VALVE V3/PV	SNVT_switch (State)	

LONWORKS – Mapping (continued)

LME7...

LONWORKS LME7... Mapping

SNVT NAME	DESCRIPTION	SNVT TYPE	NOTES
(nvo)xPhase	PHASE	SNVT_count_inc_f	see LME7 Phases
(nvo)xFlPer	FLAME PERCENT LME71/LME73	SNVT_lev_percent	
(nvo)xMainsVol	MAINS VOLTAGE	SNVT_volt_ac	
(nvo)xSURst	STARTUPS RESETTABLE	SNVT_count_inc_f	
(nvo)xSUTot	STARTUPS TOTAL	SNVT_count_inc_f	
(nvo)xRlyK12Cyc	RELAY K12 CYCLES	SNVT_count_inc_f	
(nvo)xRlyK11Cyc	RELAY K11 CYCLES	SNVT_count_inc_f	
(nvo)xRlyK2Cyc	RELAY K2 CYCLES	SNVT_count_inc_f	
(nvo)xRlyK1Cyc	RELAY K1 CYCLES	SNVT_count_inc_f	
(nvo)xMaxRlyCyc	MAX RELAY CYCLES	SNVT_count_inc_f	
(nvo)xCurrOutPer	CURRENT OUTPUT PERCENT	SNVT_lev_percent	> 100 is stages (101=S1, 102=S2)
(nvo)xActPer	ACTUATOR ACTUAL PERCENT	SNVT_lev_percent	65535 (-1) = not optioned
(nvo)xActTgtPer	ACTUATOR TARGET PERCENT	SNVT_lev_percent	65535 (-1) = not optioned
(nvo)xExtLdCtrlrPer	EXT LOAD CONTROLLER PERCENT	SNVT_lev_percent	65535 (-1) = not optioned
(nvo)xFanSpdRpm	FAN SPEED RPM	SNVT_rpm	65535 (-1) = not optioned
(nvo)xFanSpdPer	FAN SPEED PERCENT	SNVT_lev_percent	65535 (-1) = not optioned
(nvo)xTgtFanSpdPer	TARGET FAN SPEED PERCENT	SNVT_lev_percent	65535 (-1) = not optioned
(nvo)xPwmSigPer	PWM SIGNAL PERCENT	SNVT_lev_percent	65535 (-1) = not optioned
(nvo)xFl1Per75	FLAME 1 PERCENT LME75	SNVT_lev_percent	
(nvo)xFl2Per75	FLAME 2 PERCENT LME75	SNVT_lev_percent	
(nvo)xCurrErrCd	CURRENT ERROR CODE	SNVT_count_inc_f	see LME7 Error Codes
(nvo)xCurrErrSU	CURRENT ERROR STARTUPS	SNVT_count_inc_f	
(nvo)xCurrErrPh	CURRENT ERROR PHASE	SNVT_count_inc_f	see LME7 Phases
(nvo)xCurrErrLd	CURRENT ERROR LOAD	SNVT_lev_percent	
(nvo)xH1ErrCd	HISTORY 1 ERROR CODE	SNVT_count_inc_f	see LME7 Error Codes
(nvo)xH1ErrSU	HISTORY 1 ERROR STARTUPS	SNVT_count_inc_f	
(nvo)xH1ErrPh	HISTORY 1 ERROR PHASE	SNVT_count_inc_f	see LME7 Phases
(nvo)xH1ErrLd	HISTORY 1 ERROR LOAD	SNVT_lev_percent	
(nvo)xH2ErrCd	HISTORY 2 ERROR CODE	SNVT_count_inc_f	see LME7 Error Codes
(nvo)xH2ErrSU	HISTORY 2 ERROR STARTUPS	SNVT_count_inc_f	
(nvo)xH2ErrPh	HISTORY 2 ERROR PHASE	SNVT_count_inc_f	see LME7 Phases
(nvo)xH2ErrLd	HISTORY 2 ERROR LOAD	SNVT_lev_percent	
(nvo)xH3ErrCd	HISTORY 3 ERROR CODE	SNVT_count_inc_f	see LME7 Error Codes
(nvo)xH3ErrSU	HISTORY 3 ERROR STARTUPS	SNVT_count_inc_f	
(nvo)xH3ErrPh	HISTORY 3 ERROR PHASE	SNVT_count_inc_f	see LME7 Phases
(nvo)xH3ErrLd	HISTORY 3 ERROR LOAD	SNVT_lev_percent	
(nvo)xH4ErrCd	HISTORY 4 ERROR CODE	SNVT_count_inc_f	see LME7 Error Codes
(nvo)xH4ErrSU	HISTORY 4 ERROR STARTUPS	SNVT_count_inc_f	
(nvo)xH4ErrPh	HISTORY 4 ERROR PHASE	SNVT_count_inc_f	see LME7 Phases
(nvo)xH4ErrLd	HISTORY 4 ERROR LOAD	SNVT_lev_percent	
(nvo)xH5ErrCd	HISTORY 5 ERROR CODE	SNVT_count_inc_f	see LME7 Error Codes
(nvo)xH5ErrSU	HISTORY 5 ERROR STARTUPS	SNVT_count_inc_f	
(nvo)xH5ErrPh	HISTORY 5 ERROR PHASE	SNVT_count_inc_f	see LME7 Phases
(nvo)xH5ErrLd	HISTORY 5 ERROR LOAD	SNVT_lev_percent	
(nvo)xH6ErrCd	HISTORY 6 ERROR CODE	SNVT_count_inc_f	see LME7 Error Codes

LonWorks LME7... Mapping

SNVT NAME	DESCRIPTION	SNVT TYPE	NOTES
(nvo)xH6ErrSU	HISTORY 6 ERROR STARTUPS	SNVT_count_inc_f	
(nvo)xH6ErrPh	HISTORY 6 ERROR PHASE	SNVT_count_inc_f	see LME7 Phases
(nvo)xH6ErrLd	HISTORY 6 ERROR LOAD	SNVT_lev_percent	
(nvo)xH7ErrCd	HISTORY 7 ERROR CODE	SNVT_count_inc_f	see LME7 Error Codes
(nvo)xH7ErrSU	HISTORY 7 ERROR STARTUPS	SNVT_count_inc_f	
(nvo)xH7ErrPh	HISTORY 7 ERROR PHASE	SNVT_count_inc_f	see LME7 Phases
(nvo)xH7ErrLd	HISTORY 7 ERROR LOAD	SNVT_lev_percent	
(nvo)xH8ErrCd	HISTORY 8 ERROR CODE	SNVT_count_inc_f	see LME7 Error Codes
(nvo)xH8ErrSU	HISTORY 8 ERROR STARTUPS	SNVT_count_inc_f	
(nvo)xH8ErrPh	HISTORY 8 ERROR PHASE	SNVT_count_inc_f	see LME7 Phases
(nvo)xH8ErrLd	HISTORY 8 ERROR LOAD	SNVT_lev_percent	
(nvo)xH9ErrCd	HISTORY 9 ERROR CODE	SNVT_count_inc_f	see LME7 Error Codes
(nvo)xH9ErrSU	HISTORY 9 ERROR STARTUPS	SNVT_count_inc_f	
(nvo)xH9ErrPh	HISTORY 9 ERROR PHASE	SNVT_count_inc_f	see LME7 Phases
(nvo)xH9ErrLd	HISTORY 9 ERROR LOAD	SNVT_lev_percent	
(nvo)xH10ErrCd	HISTORY 10 ERROR CODE	SNVT_count_inc_f	see LME7 Error Codes
(nvo)xH10ErrSU	HISTORY 10 ERROR STARTUPS	SNVT_count_inc_f	
(nvo)xH10ErrPh	HISTORY 10 ERROR PHASE	SNVT_count_inc_f	see LME7 Phases
(nvo)xH10ErrLd	HISTORY 10 ERROR LOAD	SNVT_lev_percent	
(nvo)xSftyLim	SAFETY LIMIT (SK)	SNVT_switch (State)	TERMINAL X3.04.1
(nvo)xPrfOfCls	PROOF OF CLOSURE (POC)	SNVT_switch (State)	TERMINAL X2.02.4
(nvo)xPrsSwVlvPrv	PRESS SW VALVE PROVING (P LT)	SNVT_switch (State)	TERMINAL X9.04.2
(nvo)xLoGasPrsSw	LOW GAS PRESSURE SWITCH (Pmin)	SNVT_switch (State)	TERMINAL X5.01.2
(nvo)xCntlSw	CONTROL SWITCH (ON/OFF)	SNVT_switch (State)	TERMINAL X5.03.1
(nvo)xCombAirSw	COMBUSTION AIR SWITCH (LP)	SNVT_switch (State)	TERMINAL X3.02.1
(nvo)xRstRmTerm	RESET TERMINAL (EK2)	SNVT_switch (State)	TERMINAL X2.03.1
(nvo)xIncMod	INCREASE MODULATION (LR-OPEN)	SNVT_switch (State)	TERMINAL X5.03.3
(nvo)xDecMod	DECREASE MODULATION (LR-CLOSED)	SNVT_switch (State)	TERMINAL X5.03.2
(nvo)xAct	ACTUATOR FEEDBACK (SA-R)	SNVT_switch (State)	TERMINAL X2.09.4
(nvo)xRstButLME	RESET BUTTON LME	SNVT_switch (State)	
(nvo)xFlame	FLAME PRESENT LME71/LME73 FLAME 1 PRESENT LME75	SNVT_switch (State)	
(nvo)xAlarm	ALARM (AL)	SNVT_switch (State)	TERMINAL X2.03.3
(nvo)xNoComm	NO COMM TO LME		STATUS FROM OCI417
(nvo)xFlame2	FLAME 2 PRESENT LME75	SNVT_switch (State)	
(nvo)xSftyVlv	SAFETY VALVE (SV)	SNVT_switch (State)	TERMINAL X6.03.3
(nvo)xActLoFire	ACTUATOR LOW-FIRE (SA-KL)	SNVT_switch (State)	TERMINAL X2.09.2
(nvo)xActHiFire	ACTUATOR HIGH-FIRE (SA-NL)	SNVT_switch (State)	TERMINAL X2.09.3
(nvo)xPltVlv	PILOT VALVE (PV)	SNVT_switch (State)	TERMINAL X7.01.3
(nvo)xIgnition	IGNITION (Z)	SNVT_switch (State)	TERMINAL X4.02.3
(nvo)xFan	FAN (M)	SNVT_switch (State)	TERMINAL X2.01.3
(nvo)xVlvV1	VALVE 1 (V2)	SNVT_switch (State)	TERMINAL X7.02.3
(nvo)xVlvV2	VALVE 2 (V1)	SNVT_switch (State)	TERMINAL X7.04.4
(nvo)xPrsSwVP75	PRESS SW VALVE PROVING (P LT)	SNVT_switch (State)	TERMINAL X9.04.2
(nvo)xMulti75	VALVE PROVING ENABLE (LT) HIGH GAS PRESSURE SWITCH (Pmax) PROOF OF CLOSURE (POC)	SNVT_switch (State)	TERMINAL X2.02.4
(nvo)xIncMod75	INCREASE MODULATION (LR-OPEN)	SNVT_switch (State)	TERMINAL X5.03.3
(nvo)xDecMod75	DECREASE MODULATION (LR-CLOSED)	SNVT_switch (State)	TERMINAL X5.03.2

LonWorks LME7... Mapping

SNVT NAME	DESCRIPTION	SNVT TYPE	NOTES
(nvo)xCombAir75	COMBUSTION AIR SWITCH (LP)	SNVT_switch (State)	TERMINAL X3.02.1
(nvo)xLowGas75	LOW GAS PRESSURE SWITCH (Pmin)	SNVT_switch (State)	TERMINAL X5.01.2
(nvo)xResetB75	RESET BUTTON LME	SNVT_switch (State)	
(nvo)xResetT75	RESET TERMINAL (EK2)	SNVT_switch (State)	TERMINAL X2.03.1
(nvo)xActFB75	ACTUATOR FEEDBACK (SA-R)	SNVT_switch (State)	TERMINAL X2.09.4
(nvo)xSyLim75	SAFETY LIMIT (SK)	SNVT_switch (State)	TERMINAL X3.04.1
(nvo)xCtSw75	CONTROL SWITCH (ON/OFF)	SNVT_switch (State)	TERMINAL X5.03.1
(nvo)xInCams75	INPUT CAMS (SA-ZL)	SNVT_switch (State)	TERMINAL X2.09.8

LONWORKS – Mapping (continued)

RWF10

LONWORKS RWF10 Mapping

SNVT NAME	DESCRIPTION	SNVT TYPE	NOTES
(nvo)xProcessVar	PROCESS VARIABLE	SNVT_count_inc_f	
(nvo)xStatusWord	STATUS WORD	SNVT_count_inc_f	
(nvo)xAnaOutput	ANALOG OUTPUT	SNVT_lev_percent	
(nvo,nvi)xCurrentSp	CURRENT SETPOINT	SNVT_count_inc_f	
(nvo,nvi)xSpAlarm1	SETPOINT ALARM 1	SNVT_count_inc_f	
(nvo,nvi)xSpAlarm2	SETPOINT ALARM 2	SNVT_count_inc_f	
(nvo,nvi)xPropBand	PROPORTIONAL BAND	SNVT_count_inc_f	
(nvo,nvi)xIntTime	INTEGRAL TIME	SNVT_count_inc_f	
(nvo,nvi)xDerTime	DERIVATIVE TIME	SNVT_count_inc_f	
(nvo,nvi)xHystAlarm1	HYSTERESIS ALARM 1	SNVT_count_inc_f	
(nvo,nvi)xHystAlarm2	HYSTERESIS ALARM 2	SNVT_count_inc_f	
(nvo)xOpAlarm1	OUTPUT ALARM 1 BURNER	SNVT_switch (State)	
(nvo)xOpAlarm2	OUTPUT ALARM 2 LF HOLD	SNVT_switch (State)	

LONWORKS – Mapping (continued)**RWF55****LONWORKS RWF55 Mapping**

SNVT NAME	DESCRIPTION	SNVT TYPE	NOTES
(nvo)xIn1X1	INPUT 1 X1	SNVT_count_inc_f	
(nvo)xIn2X2	INPUT 2 X2	SNVT_count_inc_f	
(nvo)xIn3X3	INPUT 3 X3	SNVT_count_inc_f	
(nvo)xCurSpWr	CURRENT SETPOINT WR	SNVT_count_inc_f	
(nvo/nvi)xFirstSpSp1	FIRST SETPOINT SP1	SNVT_count_inc_f	
(nvo/nvi)xSecSpSp2	SECOND SETPOINT SP2	SNVT_count_inc_f	
(nvo/nvi)xOpgMdRem	REMOTE OPERATING MODE REM	SNVT_count_inc_f	
(nvo/nvi)xMdOffRoff	REMOTE MODE OFF ROFF	SNVT_switch (State)	
(nvo/nvi)xOnHysRhys1	REMOTE ON HYSTERESIS RHYS1	SNVT_count_inc_f	
(nvo/nvi)xHysBtRhys2	REMOTE OFF HYST BOTTOM RHYS2	SNVT_count_inc_f	
(nvo/nvi)xHysTpRhys3	REMOTE OFF HYST TOP RHYS3	SNVT_count_inc_f	
(nvo/nvi)xRemSpSpr	REMOTE SETPOINT SPR	SNVT_count_inc_f	
(nvo/nvi)xBrnOpRk1	REMOTE BURNER OUTPUT RK1	SNVT_switch (State)	
(nvo/nvi)xRemK2OpRk2	REMOTE K2 OUTPUT RK2	SNVT_switch (State)	
(nvo/nvi)xRemK3OpRk3	REMOTE K3 OUTPUT RK3	SNVT_switch (State)	
(nvo/nvi)xRemK6OpRk6	REMOTE K6 OUTPUT RK6	SNVT_switch (State)	
(nvo/nvi)xStgMdRstep	REMOTE STAGE MODE RSTEP	SNVT_count_inc_f	
(nvo/nvi)xRemOpRy	REMOTE OUTPUT RY	SNVT_count_inc_f	
(nvo/nvi)xOnHysRhys4	REM ON HYST COOLING RHYS4	SNVT_count_inc_f	
(nvo/nvi)xHysBtRhys5	REM OFF HYST BTM COOLING RHYS5	SNVT_count_inc_f	
(nvo/nvi)xHysTpRhys6	REM OFF HYST TOP COOLING RHYS6	SNVT_count_inc_f	
(nvo)xIn3Unf	INPUT 3 UNFILTERED TEMP	SNVT_count_inc_f	
(nvo)xActOpY	ACTUAL OUTPUT Y	SNVT_count_inc_f	
(nvo)xBrnAlarm	BURNER ALARM	SNVT_count_inc_f	
(nvo/nvi)xRmpFunFnct	RAMP FUNCTION FnCt	SNVT_count_inc_f	
(nvo/nvi)xRmpSlpRasl	RAMP SLOPE rASL	SNVT_count_inc_f	
(nvo/nvi)xBndRmpToLp	TOLERANCE BAND RAMP toLP	SNVT_count_inc_f	
(nvo/nvi)xLimValRal	LIMIT VALUE rAL	SNVT_count_inc_f	
(nvo/nvi)xAlmRelFnal	ALARM RELAY FUNCTION FnAL	SNVT_count_inc_f	
(nvo/nvi)xAlmLimAl	ALARM LIMIT COMPARATOR AL	SNVT_count_inc_f	
(nvo/nvi)xHysLimHyst	HYSTERESIS LIMIT COMP HYST	SNVT_count_inc_f	
(nvo/nvi)xMWdogDtt	MODBUS WATCHDOG dtt	SNVT_count_inc_f	
(nvo/nvi)xFilln1Df1	FILTER INPUT 1 df1	SNVT_count_inc_f	
(nvo/nvi)xFilln2Df2	FILTER INPUT 2 df2	SNVT_count_inc_f	
(nvo/nvi)xFilln3Df3	FILTER INPUT 3 df3	SNVT_count_inc_f	
(nvo)xAvLimOllo	ACTUAL VALUE LIMIT LOW oLlo	SNVT_count_inc_f	
(nvo)xAvLimOlhi	ACTUAL VALUE LIMIT HIGH oLHi	SNVT_count_inc_f	
(nvo/nvi)xPrBandPb1	PROPORTIONAL BAND Pb1	SNVT_count_inc_f	
(nvo/nvi)xDerTimeDt	DERIVATIVE ACTION TIME dt	SNVT_count_inc_f	
(nvo/nvi)xIntTimeRt	INTEGRAL ACTION TIME rt	SNVT_count_inc_f	
(nvo/nvi)xDeadBandDb	DEAD BAND db	SNVT_count_inc_f	
(nvo/nvi)xActTimeTt	ACTUATOR RUNNING TIME tt	SNVT_count_inc_f	
(nvo/nvi)xOnHystHys1	ON HYSTERESIS HYS1	SNVT_count_inc_f	
(nvo/nvi)xHysBtHys2	OFF HYSTERESIS BOTTOM HYS2	SNVT_count_inc_f	
(nvo/nvi)xHysTpHys3	OFF HYSTERESIS TOP HYS3	SNVT_count_inc_f	

LONWORKS RWF55 Mapping

SNVT NAME	DESCRIPTION	SNVT TYPE	NOTES
(nvo/nvi)xHysClgHys4	ON HYST COOLING HYS4	SNVT_count_inc_f	
(nvo/nvi)xHystBtHys5	OFF HYST BTM COOLING HYS5	SNVT_count_inc_f	
(nvo/nvi)xHystTpHys6	OFF HYST TOP COOLING HYS6	SNVT_count_inc_f	
(nvo/nvi)xThresholdQ	REACTION THRESHOLD q	SNVT_count_inc_f	
(nvo/nvi)xOsa1At1	OUTSIDE TEMPERATURE 1 At1	SNVT_count_inc_f	
(nvo/nvi)xBlrTmp1Ht1	BOILER TEMPERATURE 1 Ht1	SNVT_count_inc_f	
(nvo/nvi)xOsa2At2	OUTSIDE TEMPERATURE 2 At2	SNVT_count_inc_f	
(nvo/nvi)xBlrTmp2Ht2	BOILER TEMPERATURE 2 Ht2	SNVT_count_inc_f	
(nvo/nvi)xIn1SclLow	INPUT 1 SCALE LOW SCL1	SNVT_count_inc_f	
(nvo/nvi)xIn1SclHi	INPUT 1 SCALE HIGH SCH1	SNVT_count_inc_f	
(nvo/nvi)xOffIn1Off1	OFFSET INPUT 1 OFF1	SNVT_count_inc_f	
(nvo/nvi)xIn2SclLow	INPUT 2 SCALE LOW SCL2	SNVT_count_inc_f	
(nvo/nvi)xIn2SclHi	INPUT 2 SCALE HIGH SCH2	SNVT_count_inc_f	
(nvo/nvi)xOffIn2Off2	OFFSET INPUT 2 OFF2	SNVT_count_inc_f	
(nvo/nvi)xOffIn3Off3	OFFSET INPUT 3 OFF3	SNVT_count_inc_f	
(nvo/nvi)xSpLowSpl	SETPOINT LIMIT SCALE LOW SPL	SNVT_count_inc_f	
(nvo/nvi)xSpHiSph	SETPOINT LIMIT SCALE HIGH SPH	SNVT_count_inc_f	
(nvo)xIn1Fault	INPUT 1 FAULT	SNVT_switch (State)	
(nvo)xIn2Fault	INPUT 2 FAULT	SNVT_switch (State)	
(nvo)xIn3Fault	INPUT 3 FAULT	SNVT_switch (State)	
(nvo)xStageMode	STAGE MODE	SNVT_switch (State)	
(nvo)xManOp	MANUAL OPERATION	SNVT_switch (State)	
(nvo)xBinInput1	BINARY INPUT 1	SNVT_switch (State)	
(nvo)xBinInput2	BINARY INPUT 2	SNVT_switch (State)	
(nvo)xStatActive	STAT ACTIVE	SNVT_switch (State)	
(nvo)xUpActive	UP ACTIVE	SNVT_switch (State)	
(nvo)xDownActive	DOWN ACTIVE	SNVT_switch (State)	
(nvo)xK6Active	K6 ACTIVE	SNVT_switch (State)	

LONWORKS – Mapping (continued)

TS Series Hardwired Draft Control

LONWORKS TS Series Hardwired Draft Control Mapping

SNVT NAME	DESCRIPTION	SNVT TYPE	NOTES
(nvo,nvi)xSetpoint	SETPOINT	SNVT_count_inc_f	
(nvo,nvi)xHysteresis	HYSTERESIS	SNVT_count_inc_f	
(nvo)xDampPos	DAMPER POSITION	SNVT_count_inc_f	
(nvo)xContPhase	CONTROL PHASE	SNVT_count_inc_f	see Mapping Notes – Note 8
(nvo,nvi)xSenMin	SENSOR MIN	SNVT_count_inc_f	
(nvo,nvi)xSenMax	SENSOR MAX	SNVT_count_inc_f	
(nvo,nvi)xSenType	SENSOR TYPE	SNVT_count_inc_f	see Mapping Notes – Note 9
(nvo,nvi)xSenTime	SENSOR FILTER TIME	SNVT_count_inc_f	
(nvo,nvi)xDrMin	DRIVE MIN	SNVT_count_inc_f	
(nvo,nvi)xDrMax	DRIVE MAX	SNVT_count_inc_f	
(nvo,nvi)xPulseOn	PULSE ON	SNVT_count_inc_f	
(nvo,nvi)xPulseOff	PULSE OFF	SNVT_count_inc_f	
(nvo,nvi)xClTmSP	CLOSE TIMER SP	SNVT_count_inc_f	
(nvo,nvi)xPrmTmSP	PERMISSIVE TIMER SP	SNVT_count_inc_f	
(nvo,nvi)xIgnTmSP	IGNITION TIMER SP	SNVT_count_inc_f	
(nvo,nvi)xRelTmSP	REL MOD TIMER SP	SNVT_count_inc_f	
(nvo,nvi)xPPTmSP	POSTPURGE TIMER SP	SNVT_count_inc_f	
(nvo)xClTm	CLOSE TIMER	SNVT_count_inc_f	
(nvo)xPrmTm	PERMISSIVE TIMER	SNVT_count_inc_f	
(nvo)xIgnTm	IGNITION TIMER	SNVT_count_inc_f	
(nvo)xRelTm	REL MOD TIMER	SNVT_count_inc_f	
(nvo)xPPTm	POSTPURGE TIMER	SNVT_count_inc_f	
(nvo)xDiClose	DAMPER CLOSED	SNVT_switch (State)	
(nvo)xDiOpen	DAMPER OPEN	SNVT_switch (State)	
(nvo)xDiIgn	DAMPER IGNITION	SNVT_switch (State)	
(nvo)xDiCfh	CALL FOR HEAT	SNVT_switch (State)	
(nvo)xDiFvo	FUEL VALVE OPEN	SNVT_switch (State)	
(nvo)xDiFan	BLOWER RUNNING	SNVT_switch (State)	
(nvo)xDiFSGAI	FSG ALARM	SNVT_switch (State)	
(nvo)xDiLowDr	LOW DRAFT	SNVT_switch (State)	
(nvo)xDiHfp	HIGH FIRE PURGE	SNVT_switch (State)	
(nvo)xDoPerm	PERMISSIVE	SNVT_switch (State)	
(nvo)xDoIgn	DRIVE IGNITION	SNVT_switch (State)	
(nvo)xDoOpen	DRIVE OPEN	SNVT_switch (State)	
(nvo)xDoClose	DRIVE CLOSED	SNVT_switch (State)	

LONWORKS – Mapping (continued)TS Series Deaerator/Surge Tank

This mapping applies to either standalone applications or as part of a TS Series Lead/Lag Master.

LONWORKS TS Series Deaerator/Surge Tank Mapping
x = 9 for DA/ST-1 or 10 for DA/ST-2 when connected via TS Series Lead/Lag Master

SNVT NAME	DESCRIPTION	SNVT TYPE	NOTES
(nvo)xP1Hoa	P1 HOA	SNVT_count_inc_f	
(nvo)xP2Hoa	P2 HOA	SNVT_count_inc_f	
(nvo)xP3Hoa	P3 HOA	SNVT_count_inc_f	
(nvo)xP4Hoa	P4 HOA	SNVT_count_inc_f	
(nvo)xP5Hoa	P5 HOA	SNVT_count_inc_f	
(nvo)xP6Hoa	P6 HOA	SNVT_count_inc_f	
(nvo)xDaRwfWLE1	DA RWF WTR LEVEL E1	SNVT_press_f	
(nvo)xDaRwfWLE2	DA RWF WTR LEVEL E2	SNVT_count_inc_f	
(nvo)xDaRwfWLWr	DA RWF WTR LEVEL SP WR	SNVT_press_f	
(nvo)xDaRwfWLY	DA RWF WTR LEVEL PCT Y	SNVT_lev_percent	
(nvo)xSrgRwfWLE1	SRG RWF WTR LEVEL E1	SNVT_press_f	
(nvo)xSrgRwfWLE2	SRG RWF WTR LEVEL E2	SNVT_count_inc_f	
(nvo)xSrgRwfWLSpWr	SRG RWF WTR LEVEL SP WR	SNVT_press_f	
(nvo)xSrgRwfWLPctY	SRG RWF WTR LEVEL PCT Y	SNVT_lev_percent	
(nvo)xSteamRwfE1	STEAM RWF PRS E1	SNVT_count_inc_f	
(nvo)xSteamRwfE2	STEAM RWF PRS E2	SNVT_count_inc_f	
(nvo)xSteamRwfWr	STEAM RWF PRS SP WR	SNVT_count_inc_f	
(nvo)xSteamRwfY	STEAM RWF PRS PCT Y	SNVT_lev_percent	
(nvo)xBuDaWLE1	BU DA WTR LEVEL E1	SNVT_press_f	
(nvo)xBuDaWLE2	BU DA WTR LEVEL E2	SNVT_count_inc_f	
(nvo)xBuDaWLWr	BU DA WTR LEVEL SP WR	SNVT_press_f	
(nvo)xBuDaWLY	BU DA WTR LEVEL PCT Y	SNVT_lev_percent	
(nvo)xBuSrgWLE1	BU SRG WTR LEVEL E1	SNVT_press_f	
(nvo)xBuSrgWLE2	BU SRG WTR LEVEL E2	SNVT_count_inc_f	
(nvo)xBuSrgWLWr	BU SRG WTR LEVEL SP WR	SNVT_press_f	
(nvo)xBuSrgWLY	BU SRG WTR LEVEL PCT Y	SNVT_lev_percent	
(nvo)xP1RunHrs	P1 RUN HOURS	SNVT_time_hour	
(nvo)xP2RunHrs	P2 RUN HOURS	SNVT_time_hour	
(nvo)xP3RunHrs	P3 RUN HOURS	SNVT_time_hour	
(nvo)xP4RunHrs	P4 RUN HOURS	SNVT_time_hour	
(nvo)xP5RunHrs	P5 RUN HOURS	SNVT_time_hour	
(nvo)xP6RunHrs	P6 RUN HOURS	SNVT_time_hour	
(nvo)xRtd1	RTD 1	SNVT_count_inc_f	
(nvo)xRtd2	RTD 2	SNVT_count_inc_f	
(nvo)xRtd3	RTD 3	SNVT_count_inc_f	
(nvo)xRtd4	RTD 4	SNVT_count_inc_f	
(nvo)xAnaInput1	ANALOG INPUT 1	SNVT_count_inc_f	
(nvo)xAnaInput2	ANALOG INPUT 2	SNVT_count_inc_f	
(nvo)xAnaInput3	ANALOG INPUT 3	SNVT_count_inc_f	
(nvo)xAnaInput4	ANALOG INPUT 4	SNVT_count_inc_f	
(nvo)xAnaInput5	ANALOG INPUT 5	SNVT_count_inc_f	
(nvo)xAnaInput6	ANALOG INPUT 6	SNVT_count_inc_f	
(nvo)xAnaInput7	ANALOG INPUT 7	SNVT_count_inc_f	

LonWORKS TS Series Deaerator/Surge Tank Mapping

x = 9 for DA/ST-1 or 10 for DA/ST-2 when connected via TS Series Lead/Lag Master

SNVT NAME	DESCRIPTION	SNVT TYPE	NOTES
(nvo)xAnaInput8	ANALOG INPUT 8	SNVT_count_inc_f	
(nvo)xAnaOutput1	ANALOG OUTPUT 1	SNVT_count_inc_f	
(nvo)xAnaOutput2	ANALOG OUTPUT 2	SNVT_count_inc_f	
(nvo)xAnaOutput3	ANALOG OUTPUT 3	SNVT_count_inc_f	
(nvo)xAnaOutput4	ANALOG OUTPUT 4	SNVT_count_inc_f	
(nvo)xAnaOutput5	ANALOG OUTPUT 5	SNVT_count_inc_f	
(nvo)xAnaOutput6	ANALOG OUTPUT 6	SNVT_count_inc_f	
(nvo)xAnaOutput7	ANALOG OUTPUT 7	SNVT_count_inc_f	
(nvo)xAnaOutput8	ANALOG OUTPUT 8	SNVT_count_inc_f	
(nvo)xDaSpMsc	DA SETPOINT MSC	SNVT_count_inc_f	
(nvo)xDaFwPrsMsc	DA FW PRESSURE MSC	SNVT_count_inc_f	
(nvo)xDaDropMsc	DA DROP PUMP MSC	SNVT_count_inc_f	
(nvo)xDaAddMsc	DA ADD PUMP MSC	SNVT_count_inc_f	
(nvo)xDaSpVfd	DA SETPOINT VFD	SNVT_count_inc_f	
(nvo)xDaFwC4Vfd	DA FW PRESSURE CH4 VFD	SNVT_count_inc_f	
(nvo)xDaFwOfVfd	DA FW PRESSURE OFFSET VFD	SNVT_count_inc_f	
(nvo)xDaDropVfd	DA DROP PUMP VFD	SNVT_lev_percent	
(nvo)xDaAddVfd	DA ADD PUMP VFD	SNVT_lev_percent	
(nvo)xDaStartDel	DA START DELAY	SNVT_time_f	
(nvo)xDaStopDel	DA STOP DELAY	SNVT_time_f	
(nvo)xDaMinRunTm	DA MIN RUN TIME	SNVT_time_f	
(nvo)xDaOvlapTm	DA OVERLAP TIME	SNVT_time_f	
(nvo)xDaAltTime	DA ALTERNATION TIME	SNVT_time_hour	
(nvo)xSrgSpMsc	SRG SETPOINT MSC	SNVT_count_inc_f	
(nvo)xSrgFwPrsMsc	SRG FW PRESSURE MSC	SNVT_count_inc_f	
(nvo)xSrgDropMsc	SRG DROP PUMP MSC	SNVT_count_inc_f	
(nvo)xSrgAddMsc	SRG ADD PUMP MSC	SNVT_count_inc_f	
(nvo)xSrgSpVfd	SRG SETPOINT VFD	SNVT_count_inc_f	
(nvo)xSrgFwC4Vfd	SRG FW PRESSURE CH4 VFD	SNVT_count_inc_f	
(nvo)xSrgFwOfVfd	SRG FW PRESSURE OFFSET VFD	SNVT_count_inc_f	
(nvo)xSrgDropVfd	SRG DROP PUMP VFD	SNVT_lev_percent	
(nvo)xSrgAddVfd	SRG ADD PUMP VFD	SNVT_lev_percent	
(nvo)xSrgStartDelay	SRG START DELAY	SNVT_time_f	
(nvo)xSrgStopDelay	SRG STOP DELAY	SNVT_time_f	
(nvo)xSrgMinRunTm	SRG MIN RUN TIME	SNVT_time_f	
(nvo)xSrgOvlapTm	SRG OVERLAP TIME	SNVT_time_f	
(nvo)xSrgAltTime	SRG ALTERNATION TIME	SNVT_time_hour	
(nvo)xP1ManVfd	P1 MANUAL VFD	SNVT_lev_percent	
(nvo)xP2ManVfd	P2 MANUAL VFD	SNVT_lev_percent	
(nvo)xP3ManVfd	P3 MANUAL VFD	SNVT_lev_percent	
(nvo)xP4ManVfd	P4 MANUAL VFD	SNVT_lev_percent	
(nvo)xP5ManVfd	P5 MANUAL VFD	SNVT_lev_percent	
(nvo)xP6ManVfd	P6 MANUAL VFD	SNVT_lev_percent	
(nvo)xCtLdStDel	CT LEAD START DELAY	SNVT_time_f	
(nvo)xCtLagStartDelay	CT LAG START DELAY	SNVT_time_f	
(nvo)xCtLdStTm	CT TIMED LEAD START	SNVT_time_f	
(nvo)xCtLgStTm	CT TIMED LAG START	SNVT_time_f	
(nvo)xLdLgStatus	LEAD LAG STATUS	SNVT_switch (State)	

LONWORKS TS Series Deaerator/Surge Tank Mapping

x = 9 for DA/ST-1 or 10 for DA/ST-2 when connected via TS Series Lead/Lag Master

SNVT NAME	DESCRIPTION	SNVT TYPE	NOTES
(nvo)xDaHighWtr	DA HIGH WATER	SNVT_switch (State)	
(nvo)xDaLowWtr	DA LOW WATER	SNVT_switch (State)	
(nvo)xDaLwLwWtr	DA LOW LOW WATER	SNVT_switch (State)	
(nvo)xSrgHighWtr	SRG HIGH WATER	SNVT_switch (State)	
(nvo)xSrgLowWtr	SRG LOW WATER	SNVT_switch (State)	
(nvo)xSrgLwLwWtr	SRG LOW LOW WATER	SNVT_switch (State)	
(nvo)xCtLagStart	CT LAG START	SNVT_switch (State)	
(nvo)xCtLeadStart	CT LEAD START	SNVT_switch (State)	
(nvo)xCtLeadLagStatus	CT LEAD LAG STATUS	SNVT_switch (State)	
(nvo)xP1Proven	P1 PROVEN	SNVT_switch (State)	
(nvo)xP2Proven	P2 PROVEN	SNVT_switch (State)	
(nvo)xP3Proven	P3 PROVEN	SNVT_switch (State)	
(nvo)xP4Proven	P4 PROVEN	SNVT_switch (State)	
(nvo)xP5Proven	P5 PROVEN	SNVT_switch (State)	
(nvo)xP6Proven	P6 PROVEN	SNVT_switch (State)	
(nvo)xP1Fail	P1 FAIL	SNVT_switch (State)	
(nvo)xP2Fail	P2 FAIL	SNVT_switch (State)	
(nvo)xP3Fail	P3 FAIL	SNVT_switch (State)	
(nvo)xP4Fail	P4 FAIL	SNVT_switch (State)	
(nvo)xP5Fail	P5 FAIL	SNVT_switch (State)	
(nvo)xP6Fail	P6 FAIL	SNVT_switch (State)	
(nvo)xCtLdPumpSt	CT LEAD PUMP START	SNVT_switch (State)	
(nvo)xCtLgPumpSt	CT LAG PUMP START	SNVT_switch (State)	
(nvo)xCtTmLdSt	CT TIMED LEAD START	SNVT_switch (State)	
(nvo)xCtTmLgSt	CT TIMED LAG START	SNVT_switch (State)	

LONWORKS – Mapping (continued)

TS Series Touchscreen Kit

LONWORKS TS Series Touchscreen Kit Mapping

SNVT NAME	DESCRIPTION	SNVT TYPE	NOTES
(nvo)xLmvPhase	LMV PHASE	SNVT_count_inc_f	see LMV Phases
(nvo)xLmvFuelAct	LMV FUEL ACTUATOR	SNVT_angle_deg	
(nvo)xLmvGasAct	LMV GAS ACTUATOR	SNVT_angle_deg	
(nvo)xLmvOilAct	LMV OIL ACTUATOR	SNVT_angle_deg	
(nvo)xLmvAirAct	LMV AIR ACTUATOR	SNVT_angle_deg	
(nvo)xLmvAux1Act	LMV AUX1 ACTUATOR	SNVT_angle_deg	
(nvo)xLmvAux2Act	LMV AUX2 ACTUATOR	SNVT_angle_deg	
(nvo)xLmvAux3Act	LMV AUX3 ACTUATOR	SNVT_angle_deg	
(nvo)xLmvVsdOut	LMV VSD OUTPUT	SNVT_lev_percent	
(nvo)xLmvCurFuel	LMV CURRENT FUEL	SNVT_switch (State)	0=gas/fuel0,1=oil/fuel1
(nvo)xLmvCurOut	LMV CURRENT OUTPUT	SNVT_lev_percent	see Mapping Notes – Note 1
(nvo)xLmvCurSp	LMV CURRENT SETPOINT	SNVT_count_inc_f	
(nvo)xLmvActVal	LMV ACTUAL VALUE	SNVT_count_inc_f	
(nvo)xLmvFlame	LMV FLAME SIGNAL	SNVT_lev_percent	
(nvo)xLmvFuelMtr	LMV FUEL THROUGHPUT	SNVT_count_inc_f	
(nvo)xLmvCurO2	LMV CURRENT O2	SNVT_lev_percent	
(nvo)xLmvGasUnit	LMV GAS UNIT	SNVT_switch (State)	0=metric,1=standard
(nvo)xLmvOilUnit	LMV OIL UNIT	SNVT_switch (State)	0=metric,1=standard
(nvo)xLmvTmpUnit	LMV TEMPERATURE UNIT	SNVT_switch (State)	0=metric,1=standard
(nvo)xLmvPrsUnit	LMV PRESSURE UNIT	SNVT_switch (State)	0=metric,1=standard
(nvo)xLmvSenSel	LMV SENSOR SELECTION	SNVT_count_inc_f	see Mapping Notes – Note 2
(nvo)xLmvSuCnt	LMV STARTUP COUNTER	SNVT_count_inc_f	
(nvo)xLmvHrCnt	LMV HOUR COUNTER	SNVT_count_inc_f	
(nvo)xLmvCurEc	LMV CURRENT ERROR CODE	SNVT_count_inc_f	see LMV... Lockout/Error Codes
(nvo)xLmvCurDc	LMV CURRENT DIAGNOSTIC CODE	SNVT_count_inc_f	see LMV... Lockout/Error Codes
(nvo)xLmvCurErCl	LMV CURRENT ERROR CLASS	SNVT_count_inc_f	not used
(nvo)xLmvCurErPh	LMV CURRENT ERROR PHASE	SNVT_count_inc_f	see LMV Phases
(nvo)xLmvLimOff	LMV TEMP LIMIT OFF THRESHOLD	SNVT_count_inc_f	
(nvo)xLmvSupAir	LMV SUPPLY AIR TEMPERATURE	SNVT_count_inc_f	
(nvo)xLmvFlueGas	LMV FLUE GAS TEMPERATURE	SNVT_count_inc_f	
(nvo)xLmvCombEff	LMV COMBUSTION EFFICIENCY	SNVT_lev_percent	
(nvo)xLmvCurCO2	LMV CURRENT CO2	SNVT_lev_percent	
(nvo)xLmvExAir	LMV CURRENT EXCESS AIR	SNVT_lev_percent	
(nvo)xLmvInput	LMV INPUT WORD	SNVT_count_inc_f	word of bits
(nvo)xLmvOutput	LMV OUTPUT WORD	SNVT_count_inc_f	word of bits
(nvo/nvi)xLmvPrgStop*	LMV PROGRAM STOP	SNVT_count_inc_f	see Mapping Notes – Note 3
(nvo/nvi)xLmvLCMode*	LMV LOAD CONTROL MODE	SNVT_count_inc_f	see Mapping Notes – Note 4
(nvo)xLmvManAuto	LMV MANUAL/AUTOMATIC	SNVT_count_inc_f	0=auto,1=on,2=off
(nvo/nvi)xLmvMLocRem	LMV MODBUS LOCAL/REMOTE	SNVT_switch (State)	0=local,1=remote
(nvo/nvi)xLmvMWdog*	LMV MODBUS WATCHDOG	SNVT_time_sec	
(nvo/nvi)xLmvMOpMode	LMV MODBUS OPERATING MODE	SNVT_count_inc_f	0=auto,1=on,2=off
(nvo/nvi)xLmvMSpW3	LMV MODBUS SETPOINT W3	SNVT_count_inc_f	
(nvo/nvi)xLmvMOutput	LMV MODBUS OUTPUT	SNVT_lev_percent	see Mapping Notes – Note 1
(nvo/nvi)xLmvMFuSel*	LMV MODBUS FUEL SELECTION	SNVT_switch (State)	0=gas/fuel0,1=oil/fuel1
(nvo/nvi)xLmvSpW1*	LMV SETPOINT W1	SNVT_count_inc_f	

LonWORKS TS Series Touchscreen Kit Mapping

SNVT NAME	DESCRIPTION	SNVT TYPE	NOTES
(nvo/nvi)xLmvSpW2*	LMV SETPOINT W2	SNVT_count_inc_f	
(nvo)xLmvWeekday	LMV WEEKDAY	SNVT_date_day	0=Sun,1=Mon,....,6=Sat
(nvo)xLmvDt	LMV DATE	SNVT_time_stamp	
(nvo/nvi)xLmvHrGsRst*	LMV HOURS RUN GAS RESET	SNVT_count_inc_f	
(nvo/nvi)xLmvHOS1Rst*	LMV HOURS RUN OIL S1 RESET	SNVT_count_inc_f	
(nvo/nvi)xLmvHOS2Rst*	LMV HOURS RUN OIL S2 RESET	SNVT_count_inc_f	
(nvo/nvi)xLmvHOS3Rst*	LMV HOURS RUN OIL S3 RESET	SNVT_count_inc_f	
(nvo/nvi)xLmvHTotRst*	LMV HOURS RUN TOTAL RESET	SNVT_count_inc_f	
(nvo)xLmvHrFixed	LMV HOURS RUN TOTAL FIXED	SNVT_count_inc_f	
(nvo)xLmvHrPower	LMV HOURS CONNECTED TO POWER	SNVT_count_inc_f	
(nvo/nvi)xLmvSuGsRst*	LMV STARTUPS GAS RESET	SNVT_count_inc_f	
(nvo/nvi)xLmvSuOIRst*	LMV STARTUPS OIL RESET	SNVT_count_inc_f	
(nvo/nvi)xLmvSTotRst*	LMV STARTUPS TOTAL RESET	SNVT_count_inc_f	
(nvo)xLmvSuFixed	LMV STARTUPS TOTAL FIXED	SNVT_count_inc_f	
(nvo/nvi)xLmvVolF0*	LMV TOTAL VOLUME GAS/FUELO	SNVT_count_inc_f	
(nvo/nvi)xLmvVolF1*	LMV TOTAL VOLUME OIL/FUEL1	SNVT_count_inc_f	
(nvo)xLmvNumLo	LMV NUMBER OF LOCKOUTS	SNVT_count_inc_f	
(nvo)xLmvExTemp	LMV EXTRA TEMPERATURE SENSOR	SNVT_count_inc_f	
(nvo)xLmvAzl5Psc	LMV AZL5 PARAMETER SET CODE	SNVT_count_inc_f	
(nvo)xLmvAzl5Psv	LMV AZL5 PARAMETER SET VER	SNVT_count_inc_f	
(nvo)xLmvAzl5Dt	LMV AZL5 ID DATE	SNVT_time_stamp	
(nvo)xLmvAzl5Id	LMV AZL5 ID NUMBER	SNVT_count_inc_f	
(nvo)xLmvBcPsc	LMV BC PARAMETER SET CODE	SNVT_count_inc_f	
(nvo)xLmvBcPsv	LMV BC PARAMETER SET VER	SNVT_count_inc_f	
(nvo)xLmvBcDt	LMV BC ID DATE	SNVT_time_stamp	
(nvo)xLmvBcId	LMV BURNER CONTROL ID NUMBER	SNVT_count_inc_f	
(nvo)xLmvSwVAzl	LMV SOFTWARE VERSION AZL	SNVT_count_inc_f	read in hexadecimal
(nvo)xLmvSwVerBc	LMV SW VER BURNER CONTROL	SNVT_count_inc_f	read in hexadecimal
(nvo)xLmvSwVerLc	LMV SW VER LOAD CONTROL	SNVT_count_inc_f	read in hexadecimal
(nvo)xLmvMinGas	LMV MINIMUM OUTPUT GAS	SNVT_lev_percent	see Mapping Notes – Note 1
(nvo)xLmvMaxGas	LMV MAXIMUM OUTPUT GAS	SNVT_lev_percent	see Mapping Notes – Note 1
(nvo)xLmvMinOil	LMV MINIMUM OUTPUT OIL	SNVT_lev_percent	see Mapping Notes – Note 1
(nvo)xLmvMaxOil	LMV MAXIMUM OUTPUT OIL	SNVT_lev_percent	see Mapping Notes – Note 1
(nvo/nvi)xLmvLLMod*	LMV LOAD LIMIT MODULATING	SNVT_lev_percent	see Mapping Notes – Note 1
(nvo/nvi)xLmvLLStg*	LMV LOAD LIMIT STAGING	SNVT_count_inc_f	0=S1,1=S2,2=S3
(nvo)xLmvLimOn	LMV TEMP LIMIT ON THRESHOLD	SNVT_lev_percent	-50% to 0%
(nvo)xLmvRngTSen	LMV RANGE TEMPERATURE SENSOR	SNVT_count_inc_f	0=302F,1=752F,2=1562F
(nvo)xLmvAdptAct	LMV ADAPTION ACTIVE	SNVT_switch (State)	0=inactive,1=active
(nvo)xLmvAdptSt	LMV ADAPTION STATE	SNVT_count_inc_f	
(nvo/nvi)xLmvStAdpt	LMV START ADAPTION	SNVT_count_inc_f	0=reset,1=start,2=abort
(nvo/nvi)xLmvAdptOut*	LMV ADAPTION OUTPUT	SNVT_lev_percent	
(nvo/nvi)xLmvPVal*	LMV P-VALUE	SNVT_lev_percent	
(nvo/nvi)xLmvIVal*	LMV I-VALUE	SNVT_time_sec	
(nvo/nvi)xLmvDVal*	LMV D-VALUE	SNVT_time_sec	
(nvo)xOpMdFuel0	OPERATION MODE FUEL 0	SNVT_count_inc_f	see Mapping Notes – Note 7
(nvo)xOpMdFuel1	OPERATION MODE FUEL 1	SNVT_count_inc_f	see Mapping Notes – Note 7
(nvo)xCycRvPilot	CYCLES REVERT TO PILOT	SNVT_count_inc_f	
(nvo)xLowTrFuel0	LOW RANGE TRIM FUEL 0	SNVT_lev_percent	
(nvo)xHiTrFuel0	HIGH RANGE TRIM FUEL 0	SNVT_lev_percent	

LONWORKS TS Series Touchscreen Kit Mapping

SNVT NAME	DESCRIPTION	SNVT TYPE	NOTES
(nvo)xLowTrFuel1	LOW RANGE TRIM FUEL 1	SNVT_lev_percent	
(nvo)xHighTrFuel1	HIGH RANGE TRIM FUEL 1	SNVT_lev_percent	
(nvo)xAnalnTr	ANALOG INPUT TRIM	SNVT_lev_percent	
(nvo)xCurrTrCorr	CURRENT TRIM CORRECTION	SNVT_lev_percent	
(nvo)xAbsSpdRpm	ABSOLUTE SPEED RPM	SNVT_rpm	
(nvo)xMainsVolt	MAINS VOLTAGE	SNVT_volt_f	
(nvo/nvi)xRemHOA	REM CON HAND-OFF-AUTO	SNVT_count_inc_f	0=hand,1=off,2=auto
(nvo/nvi)xRemManMode	REM CON MAN MODE	SNVT_switch (State)	0=auto,1=manual
(nvo/nvi)xRemManOut	REM CON MAN OUTPUT	SNVT_lev_percent	see Mapping Notes – Note 1
(nvo)xLmvLoECCur	LMV LOCKOUT ERROR CODE CURRENT	SNVT_count_inc_f	see LMV... Lockout/Error Codes
(nvo)xLmvLoDCCur	LMV LOCKOUT DIAG CODE CURRENT	SNVT_count_inc_f	see LMV... Lockout/Error Codes
(nvo)xLmvLoCICur	LMV LOCKOUT ERR CLASS CURRENT	SNVT_count_inc_f	not used
(nvo)xLmvLoPhCur	LMV LOCKOUT ERR PHASE CURRENT	SNVT_count_inc_f	see LMV Phases
(nvo)xLmvLoFuCur	LMV LOCKOUT FUEL CURRENT	SNVT_switch (State)	0=gas/fuel0,1=oil/fuel1
(nvo)xLmvLoOpCur	LMV LOCKOUT OUTPUT CURRENT	SNVT_lev_percent	see Mapping Notes – Note 1
(nvo)xLmvLoDT	LMV LOCKOUT DATE	SNVT_time_stamp	
(nvo)xLmvLoSuCur	LMV LOCKOUT STARTUPS CURRENT	SNVT_count_inc_f	see LMV... Lockout/Error Codes
(nvo)xLmvLoHrCur	LMV LOCKOUT HOURS CURRENT	SNVT_count_inc_f	see LMV... Lockout/Error Codes
(nvo)xLmvErEcCur	LMV ERROR ERROR CODE CURRENT	SNVT_count_inc_f	not used
(nvo)xLmvErDcCur	LMV ERROR DIAG CODE CURRENT	SNVT_count_inc_f	see LMV Phases
(nvo)xLmvErCICur	LMV ERROR ERROR CLASS CURRENT	SNVT_count_inc_f	0=gas/fuel0,1=oil/fuel1
(nvo)xLmvErPhCur	LMV ERROR ERROR PHASE CURRENT	SNVT_count_inc_f	see Mapping Notes – Note 1
(nvo)xLmvErFuCur	LMV ERROR FUEL CURRENT	SNVT_switch (State)	
(nvo)xLmvErOpCur	LMV ERROR OUTPUT CURRENT	SNVT_lev_percent	
(nvo)xLmvErSuCur	LMV ERROR STARTUPS CURRENT	SNVT_count_inc_f	
(nvo)xEqFlts	EQUIPMENT FAULTS	SNVT_count_inc_f	
(nvo)xRwfLcIn	RWF LC INPUT WORD	SNVT_count_inc_f	
(nvo)xRwfLcOut	RWF LC OUTPUT WORD	SNVT_count_inc_f	
(nvo)xRwfLcE1	RWF LC E1	SNVT_count_inc_f	
(nvo)xRwfLcE2	RWF LC E2	SNVT_count_inc_f	
(nvo)xRwfLcE3	RWF LC E3	SNVT_count_inc_f	
(nvo)xRwfLcWRSp	RWF LC WR CURRENT SP	SNVT_count_inc_f	
(nvo)xRwfLcSp1	RWF LC SP1	SNVT_count_inc_f	
(nvo)xRwfLcSp2	RWF LC SP2	SNVT_count_inc_f	
(nvo)xRwfLcAlSp	RWF LC AL ALARM SP	SNVT_count_inc_f	
(nvo)xRwfLcPb1	RWF LC PB1 PROPORTIONAL	SNVT_count_inc_f	
(nvo)xRwfLcDt	RWF LC DT DERIVATIVE	SNVT_count_inc_f	
(nvo)xRwfLcRt	RWF LC RT INTEGRAL	SNVT_count_inc_f	
(nvo)xRwfLcHys1	RWF LC HYS1	SNVT_count_inc_f	
(nvo)xRwfLcHys3	RWF LC HYS3	SNVT_count_inc_f	
(nvo)xRwfLcDtt	RWF LC DTT WATCHDOG	SNVT_count_inc_f	
(nvo)xRwfLcE3Unf	RWF LC E3 UNFILTERED	SNVT_count_inc_f	
(nvo)xRwfLcRem	RWF LC REM REMOTE OPERATION	SNVT_count_inc_f	
(nvo)xRwfLcRoff	RWF LC ROFF REMOTE OFF	SNVT_switch (State)	
(nvo)xRwfLcRk1	RWF LC RK1 REMOTE BURNER CONTROL	SNVT_switch (State)	
(nvo)xRwfLcRk6	RWF LC RK6 REMOTE K6 CONTROL	SNVT_switch (State)	
(nvo)xRwfLcSpr	RWF LC SPR REMOTE SETPOINT	SNVT_count_inc_f	
(nvo)xRwfLcRy	RWF LC RY REMOTE OUTPUT	SNVT_lev_percent	
(nvo)xRwfLcY	RWF LC Y OUTPUT	SNVT_lev_percent	

LonWORKS TS Series Touchscreen Kit Mapping

SNVT NAME	DESCRIPTION	SNVT TYPE	NOTES
(nvo)xCircPmpSig	CIRC PUMP CONTROL SIGNAL	SNVT_lev_percent	
(nvo)xCircPmpOut	CIRC PUMP OUTPUT SIGNAL	SNVT_lev_percent	
(nvo)xRwfFwIn	RWF FW INPUT WORD	SNVT_count_inc_f	
(nvo)xRwfFwOut	RWF FW OUTPUT WORD	SNVT_count_inc_f	
(nvo)xRwfFwLvPct	RWF FW LEVEL PERCENT	SNVT_count_inc_f	
(nvo)xRwfFwSpPct	RWF FW SETPOINT PERCENT	SNVT_count_inc_f	
(nvo)xRwfFwE1	RWF FW E1	SNVT_count_inc_f	
(nvo)xRwfFwE2	RWF FW E2	SNVT_count_inc_f	
(nvo)xRwfFwE3	RWF FW E3	SNVT_count_inc_f	
(nvo)xRwfFwWr	RWF FW WR CURRENT SP	SNVT_count_inc_f	
(nvo)xRwfFwSp1	RWF FW SP1	SNVT_count_inc_f	
(nvo)xRwfFwSp2	RWF FW SP2	SNVT_count_inc_f	
(nvo)xRwfFwY	RWF FW Y	SNVT_lev_percent	
(nvo)xRwfEx1In	RWF EX1 INPUT WORD	SNVT_count_inc_f	
(nvo)xRwfEx1Out	RWF EX1 OUTPUT WORD	SNVT_count_inc_f	
(nvo)xRwfEx1E1	RWF EX1 E1	SNVT_count_inc_f	
(nvo)xRwfEx1E2	RWF EX1 E2	SNVT_count_inc_f	
(nvo)xRwfEx1E3	RWF EX1 E3	SNVT_count_inc_f	
(nvo)xRwfEx1Wr	RWF EX1 WR CURRENT SP	SNVT_count_inc_f	
(nvo)xRwfEx1Sp1	RWF EX1 SP1	SNVT_count_inc_f	
(nvo)xRwfEx1Sp2	RWF EX1 SP2	SNVT_count_inc_f	
(nvo)xRwfEx1Al	RWF EX1 AL ALARM SP	SNVT_count_inc_f	
(nvo)xRwfEx1Hys1	RWF EX1 HYS1	SNVT_count_inc_f	
(nvo)xRwfEx1Hys3	RWF EX1 HYS3	SNVT_count_inc_f	
(nvo)xRwfEx1Y	RWF EX1 Y OUTPUT	SNVT_lev_percent	
(nvo)xRwfEx2In	RWF EX2 INPUT WORD	SNVT_count_inc_f	
(nvo)xRwfEx2Out	RWF EX2 OUTPUT WORD	SNVT_count_inc_f	
(nvo)xRwfEx2E1	RWF EX2 E1	SNVT_count_inc_f	
(nvo)xRwfEx2E2	RWF EX2 E2	SNVT_count_inc_f	
(nvo)xRwfEx2E3	RWF EX2 E3	SNVT_count_inc_f	
(nvo)xRwfEx2Wr	RWF EX2 WR CURRENT SP	SNVT_count_inc_f	
(nvo)xRwfEx2Sp1	RWF EX2 SP1	SNVT_count_inc_f	
(nvo)xRwfEx2Sp2	RWF EX2 SP2	SNVT_count_inc_f	
(nvo)xRwfEx2Al	RWF EX2 AL ALARM SP	SNVT_count_inc_f	
(nvo)xRwfEx2Hys1	RWF EX2 HYS1	SNVT_count_inc_f	
(nvo)xRwfEx2Hys3	RWF EX2 HYS3	SNVT_count_inc_f	
(nvo)xRwfEx2Y	RWF EX2 Y OUTPUT	SNVT_lev_percent	
(nvo)xEaGenWd1	EA GENERIC INPUTS 1 WORD	SNVT_count_inc_f	
(nvo)xEaGenWd2	EA GENERIC INPUTS 2 WORD	SNVT_count_inc_f	
(nvo)xEaGenWd3	EA GENERIC INPUTS 3 WORD	SNVT_count_inc_f	
(nvo)xEaDigIns	EA DIGITAL INPUT WORD	SNVT_count_inc_f	
(nvo)xEaStatWord	EA STATUS WORD	SNVT_count_inc_f	
(nvo)xEaAlmWord	EA ALARM WORD	SNVT_count_inc_f	
(nvo)xEaAnIn1	EA ANALOG INPUT 1	SNVT_count_inc_f	
(nvo)xEaAnIn2	EA ANALOG INPUT 2	SNVT_count_inc_f	
(nvo)xEaAnIn3	EA ANALOG INPUT 3	SNVT_count_inc_f	
(nvo)xEaAnIn4	EA ANALOG INPUT 4	SNVT_count_inc_f	
(nvo)xEaGenIn5	EA GENERIC INPUT 5	SNVT_count_inc_f	
(nvo)xEaGenIn6	EA GENERIC INPUT 6	SNVT_count_inc_f	

LonWORKS TS Series Touchscreen Kit Mapping

SNVT NAME	DESCRIPTION	SNVT TYPE	NOTES
(nvo)xEaGenIn7	EA GENERIC INPUT 7	SNVT_count_inc_f	
(nvo)xEaGenIn8	EA GENERIC INPUT 8	SNVT_count_inc_f	
(nvo)xEaGenIn9	EA GENERIC INPUT 9	SNVT_count_inc_f	
(nvo)xEaGenIn10	EA GENERIC INPUT 10	SNVT_count_inc_f	
(nvo)xEaGenIn11	EA GENERIC INPUT 11	SNVT_count_inc_f	
(nvo)xEaGenIn12	EA GENERIC INPUT 12	SNVT_count_inc_f	
(nvo)xEaGenIn13	EA GENERIC INPUT 13	SNVT_count_inc_f	
(nvo)xEaGenIn14	EA GENERIC INPUT 14	SNVT_count_inc_f	
(nvo)xEaGenIn15	EA GENERIC INPUT 15	SNVT_count_inc_f	
(nvo)xEaGenIn16	EA GENERIC INPUT 16	SNVT_count_inc_f	
(nvo)xEaDraftFB	EA DRAFT FEEDBACK	SNVT_lev_percent	
(nvo)xEaDraftAlm	EA DRAFT ALARM	SNVT_switch (State)	
(nvo)xEaDrftAlCd	EA DRAFT ALARM CODE	SNVT_count_inc_f	
(nvo)xEaDrftAlPh	EA DRAFT ALARM PHASE	SNVT_count_inc_f	
(nvo)xEaDrftDrW	EA DRAFT DRIVE WORD	SNVT_count_inc_f	
(nvo)xEaDraftSw	EA DRAFT SWITCH	SNVT_count_inc_f	
(nvo)xEaDraftSen	EA DRAFT SENSOR	SNVT_count_inc_f	
(nvo)xEaLcIns	EA LC INPUT WORD	SNVT_count_inc_f	
(nvo)xEaLcOuts	EA LC OUTPUT WORD	SNVT_count_inc_f	
(nvo)xEaLcE1	EA LC E1	SNVT_count_inc_f	
(nvo)xEaLcE3	EA LC E3	SNVT_count_inc_f	
(nvo)xEaLcWr	EA LC WR CURRENT SP	SNVT_count_inc_f	
(nvo)xEaLcSp1	EA LC SP1	SNVT_count_inc_f	
(nvo)xEaLcAl	EA LC AL ALARM SP	SNVT_count_inc_f	
(nvo)xEaLcPb1	EA LC PB1 PROPORTIONAL	SNVT_count_inc_f	
(nvo)xEaLcDt	EA LC DT DERIVATIVE	SNVT_count_inc_f	
(nvo)xEaLcRt	EA LC RT INTEGRAL	SNVT_count_inc_f	
(nvo)xEaLcHys1	EA LC HYS1	SNVT_count_inc_f	
(nvo)xEaLcHys3	EA LC HYS3	SNVT_count_inc_f	
(nvo)xEaLcRem	EA LC REM REMOTE OPERATION	SNVT_count_inc_f	
(nvo)xEaLcRoff	EA LC ROFF REMOTE OFF	SNVT_switch (State)	
(nvo)xEaLcRk1	EA LC RK1 REMOTE BURNER CONTROL	SNVT_switch (State)	
(nvo)xEaLcSpr	EA LC SPR REMOTE SETPOINT	SNVT_count_inc_f	
(nvo)xEaLcRy	EA LC RY REMOTE OUTPUT	SNVT_count_inc_f	
(nvo)xEaLcY	EA LC Y OUTPUT	SNVT_count_inc_f	
(nvo)EaMonOut1	EA MONITORED OUT 1	SNVT_count_inc_f	
(nvo)EaMonOut2	EA MONITORED OUT 2	SNVT_count_inc_f	
(nvo)xVsdRefPct	VSD FREQUENCY REF PERCENT	SNVT_lev_percent	
(nvo)xVsdOutPct	VSD OUTPUT FREQUENCY PERCENT	SNVT_lev_percent	
(nvo)xVsdOutVltg	VSD OUTPUT VOLTAGE	SNVT_volt_f	
(nvo)xVsdDcBusV	VSD DC BUS VOLTAGE	SNVT_volt_f	
(nvo)xVsdStatusW	VSD STATUS WORD	SNVT_count_inc_f	
(nvo)xVsdOutRpm	VSD OUTPUT RPM	SNVT_rpm	
(nvo)xVsdOutCur	VSD OUTPUT CURRENT	SNVT_amp_f	
(nvo)xVsdRefHz	VSD FREQUENCY REFERENCE HERTZ	SNVT_freq_f	
(nvo)xVsdOutHz	VSD OUTPUT FREQUENCY HERTZ	SNVT_freq_f	
(nvo)xVsdAlmCode	VSD ALARM CODE	SNVT_count_inc_f	
(nvo)xVsdFltCode	VSD FAULT CODE	SNVT_count_inc_f	
(nvo)xVsdDcBusPk	VSD DC BUS PEAK	SNVT_count_inc_f	

LonWORKS TS Series Touchscreen Kit Mapping

SNVT NAME	DESCRIPTION	SNVT TYPE	NOTES
(nvo)xVsdAmpPeak	VSD OUTPUT CURRENT PEAK	SNVT_count_inc_f	
(nvo)xVsdOPPwr	VSD OUTPUT POWER	SNVT_count_inc_f	
(nvo)xVsdTotPwr	VSD TOTALIZED POWER	SNVT_count_inc_f	
(nvo)xUserVal1	USER VALUE 1	SNVT_count_inc_f	
(nvo)xUserVal2	USER VALUE 2	SNVT_count_inc_f	
(nvo)xUserVal3	USER VALUE 3	SNVT_count_inc_f	
(nvo)xUserVal4	USER VALUE 4	SNVT_count_inc_f	
(nvo)xUserVal5	USER VALUE 5	SNVT_count_inc_f	
(nvo)xUserVal6	USER VALUE 6	SNVT_count_inc_f	
(nvo)xUserVal7	USER VALUE 7	SNVT_count_inc_f	
(nvo)xUserVal8	USER VALUE 8	SNVT_count_inc_f	
(nvo)xUserVal9	USER VALUE 9	SNVT_count_inc_f	
(nvo)xUserVal10	USER VALUE 10	SNVT_count_inc_f	
(nvo)xUserVal11	USER VALUE 11	SNVT_count_inc_f	
(nvo)xUserVal12	USER VALUE 12	SNVT_count_inc_f	
(nvo)xUserVal13	USER VALUE 13	SNVT_count_inc_f	
(nvo)xUserVal14	USER VALUE 14	SNVT_count_inc_f	
(nvo)xUserVal15	USER VALUE 15	SNVT_count_inc_f	
(nvo)xUserVal16	USER VALUE 16	SNVT_count_inc_f	
(nvo)xLmvCntlSw	LMV CONTROLLER SWITCH	SNVT_switch (State)	
(nvo)xLmvFanCont	LMV FAN CONTACTOR	SNVT_switch (State)	
(nvo)xLmvOilSel	LMV OIL SELECTED	SNVT_switch (State)	
(nvo)xLmvGasSel	LMV GAS SELECTED	SNVT_switch (State)	
(nvo)xLmvOilMax	LMV OIL PRESS SW MAX	SNVT_switch (State)	
(nvo)xLmvOilMin	LMV OIL PRESS SW MIN	SNVT_switch (State)	
(nvo)xLmvVlvPrv	LMV VALVE PROVING SW	SNVT_switch (State)	
(nvo)xLmvSftyLp	LMV SAFETY LOOP	SNVT_switch (State)	
(nvo)xLmvGasMin	LMV GAS PRESS SW MIN	SNVT_switch (State)	
(nvo)xLmvGasMax	LMV GAS PRESS SW MAX	SNVT_switch (State)	
(nvo)xLmvAirPrs	LMV AIR PRESSURE SW	SNVT_switch (State)	
(nvo)xLmvStRIOil	LMV START RELEASE OIL	SNVT_switch (State)	
(nvo)xLmvHvOilSt	LMV HEAVY OIL START	SNVT_switch (State)	
(nvo)xLmvAlarm	LMV ALARM	SNVT_switch (State)	
(nvo)xLmvIgn	LMV IGNITION	SNVT_switch (State)	
(nvo)xLmvStSig	LMV START SIGNAL	SNVT_switch (State)	
(nvo)xLmvFanOut	LMV FAN OUTPUT	SNVT_switch (State)	
(nvo)xLmvOilPump	LMV OIL PUMP	SNVT_switch (State)	
(nvo)xLmvFvSvOil	LMV FUEL VALVE SV OIL	SNVT_switch (State)	
(nvo)xLmvFvV1Oil	LMV FUEL VALVE V1 OIL	SNVT_switch (State)	
(nvo)xLmvFvV2Oil	LMV FUEL VALVE V2 OIL	SNVT_switch (State)	
(nvo)xLmvFvV3Oil	LMV FUEL VALVE V3 OIL	SNVT_switch (State)	
(nvo)xLmvFvSvGas	LMV FUEL VALVE SV GAS	SNVT_switch (State)	
(nvo)xLmvFvV1Gas	LMV FUEL VALVE V1 GAS	SNVT_switch (State)	
(nvo)xLmvFvV2Gas	LMV FUEL VALVE V2 GAS	SNVT_switch (State)	
(nvo)xLmvFvV3Gas	LMV FUEL VALVE PV GAS	SNVT_switch (State)	
(nvo)xEqFltLmv5	EQUIPMENT FAULT LMV5	SNVT_switch (State)	
(nvo)xEqFltLmv3	EQUIPMENT FAULT LMV3	SNVT_switch (State)	
(nvo)xEqFltR10Lc	EQUIPMENT FAULT RWF10 LC	SNVT_switch (State)	
(nvo)xEqFltR40Lc	EQUIPMENT FAULT UNUSED	SNVT_switch (State)	

LonWORKS TS Series Touchscreen Kit Mapping

SNVT NAME	DESCRIPTION	SNVT TYPE	NOTES
(nvo)xEqFltR55Lc	EQUIPMENT FAULT RWF55 LC	SNVT_switch (State)	
(nvo)xEqFltR40Fw	EQUIPMENT FAULT UNUSED	SNVT_switch (State)	
(nvo)xEqFltR55Fw	EQUIPMENT FAULT RWF55 FW	SNVT_switch (State)	
(nvo)xEqFaultEa	EQUIPMENT FAULT EA	SNVT_switch (State)	
(nvo)xEqFaultVsd	EQUIPMENT FAULT VSD	SNVT_switch (State)	
(nvo)xRLcIn1Flt	RWF LC INPUT 1 FAULT	SNVT_switch (State)	
(nvo)xRLcIn2Flt	RWF LC INPUT 2 FAULT	SNVT_switch (State)	
(nvo)xRLcIn3Flt	RWF LC INPUT 3 FAULT	SNVT_switch (State)	
(nvo)xRwfLcStgMd	RWF LC STAGE MODE	SNVT_switch (State)	
(nvo)xRwfLcManOp	RWF LC MANUAL OPERATION	SNVT_switch (State)	
(nvo)xRwfLcBin1	RWF LC BINARY INPUT 1	SNVT_switch (State)	
(nvo)xRwfLcBin2	RWF LC BINARY INPUT 2	SNVT_switch (State)	
(nvo)xRwfLcStat	RWF LC STAT ACTIVE	SNVT_switch (State)	
(nvo)xRwfLcUp	RWF LC UP ACTIVE	SNVT_switch (State)	
(nvo)xRwfLcDown	RWF LC DOWN ACTIVE	SNVT_switch (State)	
(nvo)xRwfLcK6	RWF LC K6 ACTIVE	SNVT_switch (State)	
(nvo)xRFwIn1Flt	RWF FW INPUT 1 FAULT	SNVT_switch (State)	
(nvo)xRFwIn2Flt	RWF FW INPUT 2 FAULT	SNVT_switch (State)	
(nvo)xRFwIn3Flt	RWF FW INPUT 3 FAULT	SNVT_switch (State)	
(nvo)xRwfFwStgMd	RWF FW STAGE MODE	SNVT_switch (State)	
(nvo)xRwfFwManOp	RWF FW MANUAL OPERATION	SNVT_switch (State)	
(nvo)xRwfFwBin1	RWF FW BINARY INPUT 1	SNVT_switch (State)	
(nvo)xRwfFwBin2	RWF FW BINARY INPUT 2	SNVT_switch (State)	
(nvo)xRwfFwStat	RWF FW STAT ACTIVE	SNVT_switch (State)	
(nvo)xRwfFwUp	RWF FW UP ACTIVE	SNVT_switch (State)	
(nvo)xRwfFwDown	RWF FW DOWN ACTIVE	SNVT_switch (State)	
(nvo)xRwfFwK6	RWF FW K6 ACTIVE	SNVT_switch (State)	
(nvo)xREx1In1Flt	RWF EX1 INPUT 1 FAULT	SNVT_switch (State)	
(nvo)xREx1In2Flt	RWF EX1 INPUT 2 FAULT	SNVT_switch (State)	
(nvo)xREx1In3Flt	RWF EX1 INPUT 3 FAULT	SNVT_switch (State)	
(nvo)xREx1StgMd	RWF EX1 STAGE MODE	SNVT_switch (State)	
(nvo)xREx1ManOp	RWF EX1 MANUAL OPERATION	SNVT_switch (State)	
(nvo)xRwfEx1Bin1	RWF EX1 BINARY INPUT 1	SNVT_switch (State)	
(nvo)xRwfEx1Bin2	RWF EX1 BINARY INPUT 2	SNVT_switch (State)	
(nvo)xRwfEx1Stat	RWF EX1 STAT ACTIVE	SNVT_switch (State)	
(nvo)xRwfEx1Up	RWF EX1 UP ACTIVE	SNVT_switch (State)	
(nvo)xRwfEx1Down	RWF EX1 DOWN ACTIVE	SNVT_switch (State)	
(nvo)xRwfEx1K6	RWF EX1 K6 ACTIVE	SNVT_switch (State)	
(nvo)xREx2In1Flt	RWF EX2 INPUT 1 FAULT	SNVT_switch (State)	
(nvo)xREx2In2Flt	RWF EX2 INPUT 2 FAULT	SNVT_switch (State)	
(nvo)xREx2In3Flt	RWF EX2 INPUT 3 FAULT	SNVT_switch (State)	
(nvo)xREx2StgMd	RWF EX2 STAGE MODE	SNVT_switch (State)	
(nvo)xREx2ManOp	RWF EX2 MANUAL OPERATION	SNVT_switch (State)	
(nvo)xRwfEx2Bin1	RWF EX2 BINARY INPUT 1	SNVT_switch (State)	
(nvo)xRwfEx2Bin2	RWF EX2 BINARY INPUT 2	SNVT_switch (State)	
(nvo)xRwfEx2Stat	RWF EX2 STAT ACTIVE	SNVT_switch (State)	
(nvo)xRwfEx2Up	RWF EX2 UP ACTIVE	SNVT_switch (State)	
(nvo)xRwfEx2Down	RWF EX2 DOWN ACTIVE	SNVT_switch (State)	
(nvo)xRwfEx2K6	RWF EX2 K6 ACTIVE	SNVT_switch (State)	

LonWORKS TS Series Touchscreen Kit Mapping

SNVT NAME	DESCRIPTION	SNVT TYPE	NOTES
(nvo)xEaGI5Hi	EA GI5 HIGH ALARM	SNVT_switch (State)	
(nvo)xEaGI5Lo	EA GI5 LOW ALARM	SNVT_switch (State)	
(nvo)xEaG6Hi	EA GI6 HIGH ALARM	SNVT_switch (State)	
(nvo)xEaGI6Lo	EA GI6 LOW ALARM	SNVT_switch (State)	
(nvo)xEaGI7Hi	EA GI7 HIGH ALARM	SNVT_switch (State)	
(nvo)xEaGI7Lo	EA GI7 LOW ALARM	SNVT_switch (State)	
(nvo)xEaGI8Hi	EA GI8 HIGH ALARM	SNVT_switch (State)	
(nvo)xEaGI8Lo	EA GI8 LOW ALARM	SNVT_switch (State)	
(nvo)xEaGI9Hi	EA GI9 HIGH ALARM	SNVT_switch (State)	
(nvo)xEaGI9Lo	EA GI9 LOW ALARM	SNVT_switch (State)	
(nvo)xEaGI10Hi	EA GI10 HIGH ALARM	SNVT_switch (State)	
(nvo)xEaGI10Lo	EA GI10 LOW ALARM	SNVT_switch (State)	
(nvo)xEaGI11Hi	EA GI11 HIGH ALARM	SNVT_switch (State)	
(nvo)xEaGI11Lo	EA GI11 LOW ALARM	SNVT_switch (State)	
(nvo)xEaGI12Hi	EA GI12 HIGH ALARM	SNVT_switch (State)	
(nvo)xEaGI12Lo	EA GI12 LOW ALARM	SNVT_switch (State)	
(nvo)xEaGI13Hi	EA GI13 HIGH ALARM	SNVT_switch (State)	
(nvo)xEaGI13Lo	EA GI13 LOW ALARM	SNVT_switch (State)	
(nvo)xEaGI14Hi	EA GI14 HIGH ALARM	SNVT_switch (State)	
(nvo)xEaGI14Lo	EA GI14 LOW ALARM	SNVT_switch (State)	
(nvo)xEaGI15Hi	EA GI15 HIGH ALARM	SNVT_switch (State)	
(nvo)xEaGI15Lo	EA GI15 LOW ALARM	SNVT_switch (State)	
(nvo)xEaGI16Hi	EA GI16 HIGH ALARM	SNVT_switch (State)	
(nvo)xEaGI16Lo	EA GI16 LOW ALARM	SNVT_switch (State)	
(nvo)xEaInput1	EA INPUT 1	SNVT_switch (State)	
(nvo)xEaInput2	EA INPUT 2	SNVT_switch (State)	
(nvo)xEaInput3	EA INPUT 3	SNVT_switch (State)	
(nvo)xEaInput4	EA INPUT 4	SNVT_switch (State)	
(nvo)xEaInput5	EA INPUT 5	SNVT_switch (State)	
(nvo)xEaInput6	EA INPUT 6	SNVT_switch (State)	
(nvo)xEaInput7	EA INPUT 7	SNVT_switch (State)	
(nvo)xEaInput8	EA INPUT 8	SNVT_switch (State)	
(nvo)xEaInput9	EA INPUT 9	SNVT_switch (State)	
(nvo)xEaInput10	EA INPUT 10	SNVT_switch (State)	
(nvo)xEaInput11	EA INPUT 11	SNVT_switch (State)	
(nvo)xEaInput12	EA INPUT 12	SNVT_switch (State)	
(nvo)xEaInput13	EA INPUT 13	SNVT_switch (State)	
(nvo)xEaPumpPrv	EA PUMP PROVEN	SNVT_switch (State)	
(nvo)xEaPumpAlm	EA PUMP ALARM	SNVT_switch (State)	
(nvo)xEaAi1HiAlm	EA AI1 HIGH ALARM	SNVT_switch (State)	
(nvo)xEaAi1LwAlm	EA AI1 LOW ALARM	SNVT_switch (State)	
(nvo)xEaAi2HiAlm	EA AI2 HIGH ALARM	SNVT_switch (State)	
(nvo)xEaAi2LwAlm	EA AI2 LOW ALARM	SNVT_switch (State)	
(nvo)xEaAi3HiAlm	EA AI3 HIGH ALARM	SNVT_switch (State)	
(nvo)xEaAi3LwAlm	EA AI3 LOW ALARM	SNVT_switch (State)	
(nvo)xEaAi4HiAlm	EA AI4 HIGH ALARM	SNVT_switch (State)	
(nvo)xEaAi4LwAlm	EA AI4 LOW ALARM	SNVT_switch (State)	
(nvo)xEaAo1HiAlm	EA AO1 HIGH ALARM	SNVT_switch (State)	
(nvo)xEaAo1LwAlm	EA AO1 LOW ALARM	SNVT_switch (State)	

LONWORKS TS Series Touchscreen Kit Mapping

SNVT NAME	DESCRIPTION	SNVT TYPE	NOTES
(nvo)xEaAo2HiAlm	EA AO2 HIGH ALARM	SNVT_switch (State)	
(nvo)xEaAo2LwAlm	EA AO2 LOW ALARM	SNVT_switch (State)	
(nvo)xEaAlmIn1	EA ALARM INPUT 1	SNVT_switch (State)	
(nvo)xEaAlmIn2	EA ALARM INPUT 2	SNVT_switch (State)	
(nvo)xEaAlmIn3	EA ALARM INPUT 3	SNVT_switch (State)	
(nvo)xEaAlmIn4	EA ALARM INPUT 4	SNVT_switch (State)	
(nvo)xEaAlmIn5	EA ALARM INPUT 5	SNVT_switch (State)	
(nvo)xEaAlmIn6	EA ALARM INPUT 6	SNVT_switch (State)	
(nvo)xEaAlmIn7	EA ALARM INPUT 7	SNVT_switch (State)	
(nvo)xEaAlmIn8	EA ALARM INPUT 8	SNVT_switch (State)	
(nvo)xEaAlmIn9	EA ALARM INPUT 9	SNVT_switch (State)	
(nvo)xEaAlmIn10	EA ALARM INPUT 10	SNVT_switch (State)	
(nvo)xEaAlmIn11	EA ALARM INPUT 11	SNVT_switch (State)	
(nvo)xEaAlmIn12	EA ALARM INPUT 12	SNVT_switch (State)	
(nvo)xEaAlmIn13	EA ALARM INPUT 13	SNVT_switch (State)	
(nvo)xEaDrftOpen	EA DRAFT OPEN POSITION	SNVT_switch (State)	
(nvo)xEaDrftCls	EA DRAFT CLOSE POSITION	SNVT_switch (State)	
(nvo)xEaDrftStPs	EA DRAFT START POSITION	SNVT_switch (State)	
(nvo)xEaDrftMod	EA DRAFT MODULATE	SNVT_switch (State)	
(nvo)xEaLcStat	EA LC STAT ACTIVE	SNVT_switch (State)	
(nvo)xEaLcK6	EA LC K6 ACTIVE	SNVT_switch (State)	
(nvo)MO3Alarm	EA MON OUT 3 ALARM	SNVT_switch (State)	
(nvo)MO4Alarm	EA MON OUT 4 ALARM	SNVT_switch (State)	
(nvo)xVsdRunning	VSD RUNNING	SNVT_switch (State)	
(nvo)xVsdZeroSpd	VSD ZERO SPEED	SNVT_switch (State)	
(nvo)xVsdSpdAgr	VSD SPEED AGREE	SNVT_switch (State)	
(nvo)xVsdReady	VSD READY STATE	SNVT_switch (State)	
(nvo)xVsdAlarm	VSD ALARM STATE	SNVT_switch (State)	
(nvo)xVsdFault	VSD FAULT STATE	SNVT_switch (State)	

LONWORKS – Mapping (continued)

TS Series Lead/Lag Master (Global System Data)

LONWORKS TS Series Lead/Lag Master Mapping (Global System Data)

SNVT NAME	DESCRIPTION	SNVT TYPE	NOTES
(nvo/nvi)MstRemoteSp	LLM REMOTE SETPOINT	SNVT_count_inc_f	
(nvo/nvi)MstLeadBoiler	LLM LEAD BOILER	SNVT_count_inc_f	
(nvo)MstAltSp	LLM ALTERNATION SETPOINT	SNVT_time_hour	
(nvo)MstAltHrsRem	LLM ALT HOURS REMAINING	SNVT_time_hour	
(nvo)MstCurrentSp	LLM CURRENT SETPOINT	SNVT_count_inc_f	
(nvo)MstTotalAvail	LLM TOTAL AVAILABLE	SNVT_count_inc_f	
(nvo)MstActValue	LLM ACTUAL VALUE	SNVT_count_inc_f	
(nvo)MstRtd1	LLM RTD 1	SNVT_count_inc_f	
(nvo)MstRtd2	LLM RTD 2	SNVT_count_inc_f	
(nvo)MstRtd3	LLM RTD 3	SNVT_count_inc_f	
(nvo)MstRtd4	LLM RTD 4	SNVT_count_inc_f	
(nvo)MstAnalInput1	LLM ANALOG INPUT 1	SNVT_count_inc_f	
(nvo)MstAnalInput2	LLM ANALOG INPUT 2	SNVT_count_inc_f	
(nvo)MstAnalInput3	LLM ANALOG INPUT 3	SNVT_count_inc_f	
(nvo)MstAnalInput4	LLM ANALOG INPUT 4	SNVT_count_inc_f	
(nvo/nvi)MstExtraInput	LLM EXTRA INPUT	SNVT_count_inc_f	
(nvo/nvi)MstLoadDemand	LLM LOAD DEMAND	SNVT_lev_percent	
(nvo)MstAnIn1Total	LLM ANALOG INPUT 1 TOTALIZED	SNVT_count_inc_f	
(nvo)MstAnIn2Total	LLM ANALOG INPUT 2 TOTALIZED	SNVT_count_inc_f	
(nvo)MstAnIn3Total	LLM ANALOG INPUT 3 TOTALIZED	SNVT_count_inc_f	
(nvo)MstAnIn4Total	LLM ANALOG INPUT 4 TOTALIZED	SNVT_count_inc_f	
(nvo/nvi)MstFreeReg1	LLM FREE REGISTER 1	SNVT_count_inc_f	
(nvo/nvi)MstFreeReg2	LLM FREE REGISTER 2	SNVT_count_inc_f	
(nvo/nvi)MstFreeReg3	LLM FREE REGISTER 3	SNVT_count_inc_f	
(nvo/nvi)MstFreeReg4	LLM FREE REGISTER 4	SNVT_count_inc_f	
(nvo)MstUserVal2	LLM USER VALUE 2	SNVT_count_inc_f	
(nvo)MstUserVal1	LLM USER VALUE 1	SNVT_count_inc_f	
(nvo)MstUserVal3	LLM USER VALUE 3	SNVT_count_inc_f	
(nvo)MstUserVal4	LLM USER VALUE 4	SNVT_count_inc_f	
(nvo)MstUserVal5	LLM USER VALUE 5	SNVT_count_inc_f	
(nvo)MstUserVal6	LLM USER VALUE 6	SNVT_count_inc_f	
(nvo)MstUserVal7	LLM USER VALUE 7	SNVT_count_inc_f	
(nvo)MstUserVal8	LLM USER VALUE 8	SNVT_count_inc_f	
(nvo)MstUserVal9	LLM USER VALUE 9	SNVT_count_inc_f	
(nvo)MstUserVal10	LLM USER VALUE 10	SNVT_count_inc_f	
(nvo)MstUserVal11	LLM USER VALUE 11	SNVT_count_inc_f	
(nvo)MstUserVal12	LLM USER VALUE 12	SNVT_count_inc_f	
(nvo)MstUserVal13	LLM USER VALUE 13	SNVT_count_inc_f	
(nvo)MstUserVal14	LLM USER VALUE 14	SNVT_count_inc_f	
(nvo)MstUserVal15	LLM USER VALUE 15	SNVT_count_inc_f	
(nvo)MstUserVal16	LLM USER VALUE 16	SNVT_count_inc_f	
(nvo/nvi)MstLoopSp	LLM LOOP SETPOINT	SNVT_count_inc_f	
(nvo)MstLoopOut	LLM LOOP OUTPUT	SNVT_count_inc_f	
(nvo/nvi)MstLoopP	LLM LOOP P VALUE	SNVT_count_inc_f	
(nvo/nvi)MstLoopI	LLM LOOP I VALUE	SNVT_count_inc_f	

LONWORKS TS Series Lead/Lag Master Mapping (Global System Data)

SNVT NAME	DESCRIPTION	SNVT TYPE	NOTES
(nvo/nvi)MstLoopD	LLM LOOP D VALUE	SNVT_count_inc_f	
(nvo/nvi)MstLoopAlt	LLM LOOP ALT SETPOINT	SNVT_count_inc_f	
(nvo)MstLoopElap	LLM LOOP ALT ELAPSED	SNVT_count_inc_f	
(nvo)MstLoopLead	LLM LOOP LEAD	SNVT_count_inc_f	
(nvo/nvi)MstLoopHysOn	LLM LOOP HYSTERESIS ON	SNVT_count_inc_f	
(nvo/nvi)MstLoopHysOff	LLM LOOP HYSTERESIS OFF	SNVT_count_inc_f	
(nvo)MstLoopP1Amps	LLM LOOP PUMP 1 CURRENT	SNVT_amp_f	
(nvo)MstLoopP2Amps	LLM LOOP PUMP 2 CURRENT	SNVT_amp_f	
(nvo)MstLoopP1Hz	LLM LOOP PUMP 1 FREQUENCY	SNVT_freq_f	
(nvo)MstLoopP2Hz	LLM LOOP PUMP 2 FREQUENCY	SNVT_freq_f	
(nvo/nvi)MstRemoteEn	LLM REMOTE ENABLE	SNVT_switch (State)	
(nvo/nvi)MstRemValid	LLM REMOTE VALID	SNVT_switch (State)	
(nvo)MstLowAI1	LLM AI1 LOW ALARM	SNVT_switch (State)	
(nvo)MstHiAI1	LLM AI1 HIGH ALARM	SNVT_switch (State)	
(nvo)MstLowAI2	LLM AI2 LOW ALARM	SNVT_switch (State)	
(nvo)MstHiAI2	LLM AI2 HIGH ALARM	SNVT_switch (State)	
(nvo)MstLowAI3	LLM AI3 LOW ALARM	SNVT_switch (State)	
(nvo)MstHiAI3	LLM AI3 HIGH ALARM	SNVT_switch (State)	
(nvo)MstLowAI4	LLM AI4 LOW ALARM	SNVT_switch (State)	
(nvo)MstHiAI4	LLM AI4 HIGH ALARM	SNVT_switch (State)	
(nvo)MstLowRTD1	LLM RTD1 LOW ALARM	SNVT_switch (State)	
(nvo)MstHiRTD1	LLM RTD1 HIGH ALARM	SNVT_switch (State)	
(nvo)MstLowRTD2	LLM RTD2 LOW ALARM	SNVT_switch (State)	
(nvo)MstHiRTD2	LLM RTD2 HIGH ALARM	SNVT_switch (State)	
(nvo)MstLowRTD3	LLM RTD3 LOW ALARM	SNVT_switch (State)	
(nvo)MstHiRTD3	LLM RTD3 HIGH ALARM	SNVT_switch (State)	
(nvo)MstLowRTD4	LLM RTD4 LOW ALARM	SNVT_switch (State)	
(nvo)MstHiRTD4	LLM RTD4 HIGH ALARM	SNVT_switch (State)	
(nvo)MstCommFB1	LLM B1 COMM FAULT	SNVT_switch (State)	
(nvo)MstCommFB2	LLM B2 COMM FAULT	SNVT_switch (State)	
(nvo)MstCommFB3	LLM B3 COMM FAULT	SNVT_switch (State)	
(nvo)MstCommFB4	LLM B4 COMM FAULT	SNVT_switch (State)	
(nvo)MstCommFB5	LLM B5 COMM FAULT	SNVT_switch (State)	
(nvo)MstCommFB6	LLM B6 COMM FAULT	SNVT_switch (State)	
(nvo)MstCommFB7	LLM B7 COMM FAULT	SNVT_switch (State)	
(nvo)MstCommFB8	LLM B8 COMM FAULT	SNVT_switch (State)	
(nvo)MstAlarmMO3	LLM MO3 ALARM	SNVT_switch (State)	
(nvo)MstAlarmMO4	LLM MO4 ALARM	SNVT_switch (State)	
(nvo)MstAlarmMO5	LLM MO5 ALARM	SNVT_switch (State)	
(nvo)MstAlarmMO6	LLM MO6 ALARM	SNVT_switch (State)	
(nvo)MstPLCFault	LLM PLC COMM FAULT	SNVT_switch (State)	
nvoMstDigIn1	LLM DIGITAL INPUT 1	SNVT_switch (State)	
nvoMstDigIn2	LLM DIGITAL INPUT 2	SNVT_switch (State)	
nvoMstDigIn3	LLM DIGITAL INPUT 3	SNVT_switch (State)	
nvoMstDigIn4	LLM DIGITAL INPUT 4	SNVT_switch (State)	
nvoMstDigIn5	LLM DIGITAL INPUT 5	SNVT_switch (State)	
nvoMstDigIn6	LLM DIGITAL INPUT 6	SNVT_switch (State)	
nvoMstLoopOut1	LLM LOOP OUTPUT 1	SNVT_switch (State)	
nvoMstLoopOut2	LLM LOOP OUTPUT 2	SNVT_switch (State)	

LONWORKS TS Series Lead/Lag Master Mapping (Global System Data)

SNVT NAME	DESCRIPTION	SNVT TYPE	NOTES
nvoMstLoopP1Run	LLM LOOP PUMP 1 RUN	SNVT_switch (State)	
nvoMstLoopP2Run	LLM LOOP PUMP 2 RUN	SNVT_switch (State)	
nvoMstLoopP1Alm	LLM LOOP PUMP 1 ALARM	SNVT_switch (State)	
nvoMstLoopP2Alm	LLM LOOP PUMP 2 ALARM	SNVT_switch (State)	

LONWORKS – Mapping (continued)

TS Series Lead/Lag Master (Boiler Data)

LONWORKS TS Series Lead/Lag Master Mapping (Boiler Data, x = boiler designation)

SNVT NAME	DESCRIPTION	SNVT TYPE	NOTES
(nvo)xLmvPhase	Bx LMV PHASE	SNVT_count_inc_f	see LMV Phases
(nvo)xLmvFuelAct	Bx LMV FUEL ACTUATOR	SNVT_angle_deg	
(nvo)xLmvGasAct	Bx LMV GAS ACTUATOR	SNVT_angle_deg	
(nvo)xLmvOilAct	Bx LMV OIL ACTUATOR	SNVT_angle_deg	
(nvo)xLmvAirAct	Bx LMV AIR ACTUATOR	SNVT_angle_deg	
(nvo)xLmvAux1Act	Bx LMV AUX1 ACTUATOR	SNVT_angle_deg	
(nvo)xLmvAux2Act	Bx LMV AUX2 ACTUATOR	SNVT_angle_deg	
(nvo)xLmvAux3Act	Bx LMV AUX3 ACTUATOR	SNVT_angle_deg	
(nvo)xLmvVsdOut	Bx LMV VSD OUTPUT	SNVT_lev_percent	
(nvo)xLmvCurOut	Bx LMV CURRENT OUTPUT	SNVT_lev_percent	see Mapping Notes – Note 1
(nvo)xLmvCurSp	Bx LMV CURRENT SETPOINT	SNVT_count_inc_f	
(nvo)xLmvActVal	Bx LMV ACTUAL VALUE	SNVT_count_inc_f	
(nvo)xLmvFlame	Bx LMV FLAME SIGNAL	SNVT_lev_percent	
(nvo)xLmvFuelMtr	Bx LMV FUEL THROUGHPUT	SNVT_count_inc_f	
(nvo)xLmvCurO2	Bx LMV CURRENT O2	SNVT_lev_percent	
(nvo)xLmvSuCnt	Bx LMV STARTUP COUNTER	SNVT_count_inc_f	
(nvo)xLmvHrCnt	Bx LMV HOUR COUNTER	SNVT_count_inc_f	
(nvo)xLmvCurEc	Bx LMV CURR ERROR CODE	SNVT_count_inc_f	see LMV... Lockout/Error Codes
(nvo)xLmvCurDc	Bx LMV CURR DIAG CODE	SNVT_count_inc_f	see LMV... Lockout/Error Codes
(nvo)xLmvCurErCl	Bx LMV CURR ERROR CLASS	SNVT_count_inc_f	not used
(nvo)xLmvCurErPh	Bx LMV CURR ERROR PHASE	SNVT_count_inc_f	see LMV Phases
(nvo)xLmvSupAir	Bx LMV SUPPLY AIR TEMP	SNVT_count_inc_f	
(nvo)xLmvFlueGas	Bx LMV FLUE GAS TEMP	SNVT_count_inc_f	
(nvo)xLmvCombEff	Bx LMV COMB EFFICIENCY	SNVT_lev_percent	
(nvo)xLmvLCMode	Bx LMV LD CONTROL MODE	SNVT_count_inc_f	see Mapping Notes – Note 4
(nvo)xLmvMMode	Bx LMV MODBUS MODE	SNVT_count_inc_f	0=auto,1=on,2=off
(nvo)xLmvMSpW3	Bx LMV MODBUS SP W3	SNVT_count_inc_f	
(nvo)xLmvMOutput	Bx LMV MODBUS OUTPUT	SNVT_lev_percent	see Mapping Notes – Note 1
(nvo)xLmvSpW1	Bx LMV SETPOINT W1	SNVT_count_inc_f	
(nvo)xLmvSpW2	Bx LMV SETPOINT W2	SNVT_count_inc_f	
(nvo)xLmvVolF0	Bx LMV VOLUME GAS/FUELO	SNVT_count_inc_f	
(nvo)xLmvVolF1	Bx LMV VOLUME OIL/FUEL1	SNVT_count_inc_f	
(nvo)xLmvExTemp	Bx LMV TEMP SENSOR	SNVT_count_inc_f	
(nvo)xRwfE1	Bx RWF E1	SNVT_count_inc_f	
(nvo)xRwfE2	Bx RWF E2	SNVT_count_inc_f	
(nvo)xRwfE3	Bx RWF E3	SNVT_count_inc_f	
(nvo)xRwfWrCurSp	Bx RWF WR CURRENT SP	SNVT_count_inc_f	
(nvo)xRwfSp1	Bx RWF SP1	SNVT_count_inc_f	
(nvo)xFwE1	Bx FW E1	SNVT_count_inc_f	
(nvo)xFwE2	Bx FW E2	SNVT_count_inc_f	
(nvo)xFwWrCurrSp	Bx FW WR CURRENT SP	SNVT_count_inc_f	
(nvo)xFwSp1	Bx FW SP1	SNVT_count_inc_f	
(nvo)xDrSen	Bx DRAFT SENSOR	SNVT_count_inc_f	
(nvo)xDrFb	Bx DRAFT FEEDBACK	SNVT_count_inc_f	
(nvo)xUserVal1	Bx USER VALUE 1	SNVT_count_inc_f	

LONWORKS TS Series Lead/Lag Master Mapping (Boiler Data, x = boiler designation)

SNVT NAME	DESCRIPTION	SNVT TYPE	NOTES
(nvo)xUserVal2	Bx USER VALUE 2	SNVT_count_inc_f	
(nvo)xUserVal3	Bx USER VALUE 3	SNVT_count_inc_f	
(nvo)xUserVal4	Bx USER VALUE 4	SNVT_count_inc_f	
(nvo)xUserVal5	Bx USER VALUE 5	SNVT_count_inc_f	
(nvo)xUserVal6	Bx USER VALUE 6	SNVT_count_inc_f	
(nvo)xUserVal7	Bx USER VALUE 7	SNVT_count_inc_f	
(nvo)xUserVal8	Bx USER VALUE 8	SNVT_count_inc_f	
(nvo)xUserVal9	Bx USER VALUE 9	SNVT_count_inc_f	
(nvo)xUserVal10	Bx USER VALUE 10	SNVT_count_inc_f	
(nvo)xUserVal11	Bx USER VALUE 11	SNVT_count_inc_f	
(nvo)xUserVal12	Bx USER VALUE 12	SNVT_count_inc_f	
(nvo)xUserVal13	Bx USER VALUE 13	SNVT_count_inc_f	
(nvo)xUserVal14	Bx USER VALUE 14	SNVT_count_inc_f	
(nvo)xUserVal15	Bx USER VALUE 15	SNVT_count_inc_f	
(nvo)xUserVal16	Bx USER VALUE 16	SNVT_count_inc_f	
(nvo)xEAAnalog1	Bx EA ANALOG 1	SNVT_count_inc_f	
(nvo)xEAAnalog2	Bx EA ANALOG 2	SNVT_count_inc_f	
(nvo)xEAAnalog3	Bx EA ANALOG 3	SNVT_count_inc_f	
(nvo)xEAAnalog4	Bx EA ANALOG 4	SNVT_count_inc_f	
(nvo)xEAGenIn5	Bx EA GENERIC INPUT 5	SNVT_count_inc_f	
(nvo)xEAGenIn6	Bx EA GENERIC INPUT 6	SNVT_count_inc_f	
(nvo)xEAGenIn7	Bx EA GENERIC INPUT 7	SNVT_count_inc_f	
(nvo)xEAGenIn8	Bx EA GENERIC INPUT 8	SNVT_count_inc_f	
(nvo)xEAGenIn9	Bx EA GENERIC INPUT 9	SNVT_count_inc_f	
(nvo)xEAGenIn10	Bx EA GENERIC INPUT 10	SNVT_count_inc_f	
(nvo)xEAGenIn11	Bx EA GENERIC INPUT 11	SNVT_count_inc_f	
(nvo)xEAGenIn12	Bx EA GENERIC INPUT 12	SNVT_count_inc_f	
(nvo)xUVFloat1	Bx UV FLOAT 1	SNVT_count_inc_f	
(nvo)xUVFloat2	Bx UV FLOAT 2	SNVT_count_inc_f	
(nvo)xUVFloat3	Bx UV FLOAT 3	SNVT_count_inc_f	
(nvo)xUVFloat4	Bx UV FLOAT 4	SNVT_count_inc_f	
(nvo)xUVFloat5	Bx UV FLOAT 5	SNVT_count_inc_f	
(nvo)xUVFloat6	Bx UV FLOAT 6	SNVT_count_inc_f	
(nvo)xUVFloat7	Bx UV FLOAT 7	SNVT_count_inc_f	
(nvo)xUVFloat8	Bx UV FLOAT 8	SNVT_count_inc_f	
(nvo)xUVDINT1	Bx UV DINT 1	SNVT_count_inc_f	
(nvo)xUVDINT2	Bx UV DINT 2	SNVT_count_inc_f	
(nvo)xUVDINT3	Bx UV DINT 3	SNVT_count_inc_f	
(nvo)xUVDINT4	Bx UV DINT 4	SNVT_count_inc_f	
(nvo)xUVDINT5	Bx UV DINT 5	SNVT_count_inc_f	
(nvo)xUVDINT6	Bx UV DINT 6	SNVT_count_inc_f	
(nvo)xUVDINT7	Bx UV DINT 7	SNVT_count_inc_f	
(nvo)xUVDINT8	Bx UV DINT 8	SNVT_count_inc_f	
(nvo)xBoilerAuto	Bx BOILER AUTO	SNVT_switch (State)	
(nvo)xBlrAvail	Bx BOILER AVAILABLE	SNVT_switch (State)	
(nvo)xBlrPumpRun	Bx BOILER PUMP RUNNING	SNVT_switch (State)	
(nvo)xBlrPumpAlm	Bx BOILER PUMP ALARM	SNVT_switch (State)	
(nvo)xLmvCurFuel	Bx LMV CURRENT FUEL	SNVT_switch (State)	
(nvo)xLmvContSw	Bx LMV CONTROLLER SW	SNVT_switch (State)	

LONWORKS TS Series Lead/Lag Master Mapping (Boiler Data, x = boiler designation)

SNVT NAME	DESCRIPTION	SNVT TYPE	NOTES
(nvo)xLmvFanCont	Bx LMV FAN CONTACTOR	SNVT_switch (State)	
(nvo)xLmvOilSel	Bx LMV OIL SELECTED	SNVT_switch (State)	
(nvo)xLmvGasSel	Bx LMV GAS SELECTED	SNVT_switch (State)	
(nvo)xLmvOilMax	Bx LMV OIL PRESS SW MAX	SNVT_switch (State)	
(nvo)xLmvOilMin	Bx LMV OIL PRESS SW MIN	SNVT_switch (State)	
(nvo)xLmvVlvPrv	Bx LMV VALVE PROVING SW	SNVT_switch (State)	
(nvo)xLmvSftyLp	Bx LMV SAFETY LOOP	SNVT_switch (State)	
(nvo)xLmvGasMin	Bx LMV GAS PRESS SW MIN	SNVT_switch (State)	
(nvo)xLmvGasMax	Bx LMV GAS PRESS SW MAX	SNVT_switch (State)	
(nvo)xLmvAirPrs	Bx LMV AIR PRESSURE SW	SNVT_switch (State)	
(nvo)xLmvStRIOil	Bx LMV START REL OIL	SNVT_switch (State)	
(nvo)xLmvHvOilSt	Bx LMV HEAVY OIL START	SNVT_switch (State)	
(nvo)xLmvAlarm	Bx LMV ALARM	SNVT_switch (State)	
(nvo)xLmvIgn	Bx LMV IGNITION	SNVT_switch (State)	
(nvo)xLmvStSig	Bx LMV START SIGNAL	SNVT_switch (State)	
(nvo)xLmvFanOut	Bx LMV FAN OUTPUT	SNVT_switch (State)	
(nvo)xLmvOilPump	Bx LMV OIL PUMP	SNVT_switch (State)	
(nvo)xLmvFvSvOil	Bx LMV VALVE SV OIL	SNVT_switch (State)	
(nvo)xLmvFvV1Oil	Bx LMV VALVE V1 OIL	SNVT_switch (State)	
(nvo)xLmvFvV2Oil	Bx LMV VALVE V2 OIL	SNVT_switch (State)	
(nvo)xLmvFvV3Oil	Bx LMV VALVE V3 OIL	SNVT_switch (State)	
(nvo)xLmvFvSvGas	Bx LMV VALVE SV GAS	SNVT_switch (State)	
(nvo)xLmvFvV1Gas	Bx LMV VALVE V1 GAS	SNVT_switch (State)	
(nvo)xLmvFvV2Gas	Bx LMV VALVE V2 GAS	SNVT_switch (State)	
(nvo)xLmvFvVpGas	Bx LMV VALVE PV GAS	SNVT_switch (State)	
(nvo)xLmvMLocRem	Bx LMV MODBUS LOC/REM	SNVT_switch (State)	
(nvo)xRwfIn1Flt	Bx RWF INPUT 1 FAULT	SNVT_switch (State)	
(nvo)xRwfIn2Flt	Bx RWF INPUT 2 FAULT	SNVT_switch (State)	
(nvo)xRwfIn3Flt	Bx RWF INPUT 3 FAULT	SNVT_switch (State)	
(nvo)xRwfStgMode	Bx RWF STAGE MODE	SNVT_switch (State)	
(nvo)xRwfManOp	Bx RWF MANUAL OPERATION	SNVT_switch (State)	
(nvo)xRwfBinIn1	Bx RWF BINARY INPUT 1	SNVT_switch (State)	
(nvo)xRwfBinIn2	Bx RWF BINARY INPUT 2	SNVT_switch (State)	
(nvo)xRwfStatAct	Bx RWF STAT ACTIVE	SNVT_switch (State)	
(nvo)xRwfUpAct	Bx RWF UP ACTIVE	SNVT_switch (State)	
(nvo)xRwfDownAct	Bx RWF DOWN ACTIVE	SNVT_switch (State)	
(nvo)xRwfK6Act	Bx RWF K6 ACTIVE	SNVT_switch (State)	
(nvo)xEAIn1	Bx EA INPUT 1	SNVT_switch (State)	
(nvo)xEAIn2	Bx EA INPUT 2	SNVT_switch (State)	
(nvo)xEAIn3	Bx EA INPUT 3	SNVT_switch (State)	
(nvo)xEAIn4	Bx EA INPUT 4	SNVT_switch (State)	
(nvo)xEAIn5	Bx EA INPUT 5	SNVT_switch (State)	
(nvo)xEAIn6	Bx EA INPUT 6	SNVT_switch (State)	
(nvo)xEAIn7	Bx EA INPUT 7	SNVT_switch (State)	
(nvo)xEAIn8	Bx EA INPUT 8	SNVT_switch (State)	
(nvo)xEAIn9	Bx EA INPUT 9	SNVT_switch (State)	
(nvo)xEAIn10	Bx EA INPUT 10	SNVT_switch (State)	
(nvo)xEAIn11	Bx EA INPUT 11	SNVT_switch (State)	
(nvo)xEAIn12	Bx EA INPUT 12	SNVT_switch (State)	

LONWORKS TS Series Lead/Lag Master Mapping (Boiler Data, x = boiler designation)

SNVT NAME	DESCRIPTION	SNVT TYPE	NOTES
(nvo)xEAIn13	Bx EA INPUT 13	SNVT_switch (State)	
(nvo)xEAAalarm1	Bx EA ALARM 1	SNVT_switch (State)	
(nvo)xEAAalarm2	Bx EA ALARM 2	SNVT_switch (State)	
(nvo)xEAAalarm3	Bx EA ALARM 3	SNVT_switch (State)	
(nvo)xEAAalarm4	Bx EA ALARM 4	SNVT_switch (State)	
(nvo)xEAAalarm5	Bx EA ALARM 5	SNVT_switch (State)	
(nvo)xEAAalarm6	Bx EA ALARM 6	SNVT_switch (State)	
(nvo)xEAAalarm7	Bx EA ALARM 7	SNVT_switch (State)	
(nvo)xEAAalarm8	Bx EA ALARM 8	SNVT_switch (State)	
(nvo)xEAAalarm9	Bx EA ALARM 9	SNVT_switch (State)	
(nvo)xEAAalarm10	Bx EA ALARM 10	SNVT_switch (State)	
(nvo)xEAAalarm11	Bx EA ALARM 11	SNVT_switch (State)	
(nvo)xEAAalarm12	Bx EA ALARM 12	SNVT_switch (State)	
(nvo)xEAAalarm13	Bx EA ALARM 13	SNVT_switch (State)	

Modbus – Mapping

When using either Modbus conversion, the Modbus points are the same as the native mapping. Using the node ID as part of the Modbus TCP/IP message is required to direct the message to the proper device. The protocol converter simply acts as a pass-through. All registers shown are in 0-based notation using function code 03 (read holding registers). To convert to 4x notation, add 1 (address 0 = 40001, address 7500 = 47501, etc.).

LMV5...

There is a read limit of 20 words per message. If a message is invalid, the LMV5... will not respond with an exception. Messages must begin and end on a valid register. Multi-register formats such as 32-bit or string data must be read entirely to be a valid message. All three registers for date or time must be set together to be a valid message. Access marked with an asterisk (*) are EEPROM backed and should not be continuously written.

Modbus LMV5... Mapping

ADDRESS	ACCESS	DESCRIPTION	FORMAT	NOTES
0	R	LMV PHASE	Unsigned Int 16	see LMV Phases
1	R	LMV FUEL ACTUATOR	Signed Int 16	x10
2	R	LMV GAS ACTUATOR	Signed Int 16	x10
3	R	LMV OIL ACTUATOR	Signed Int 16	x10
4	R	LMV AIR ACTUATOR	Signed Int 16	X10
5	R	LMV AUX1 ACTUATOR	Signed Int 16	x10
6	R	LMV AUX2 ACTUATOR	Signed Int 16	x10
7	R	LMV AUX3 ACTUATOR	Signed Int 16	x10
8	R	LMV VSD OUTPUT	Unsigned Int 16	x10
9	R	LMV CURRENT FUEL	Unsigned Int 16	0=gas/fuel0,1=oil/fuel1
10	R	LMV CURRENT OUTPUT	Unsigned Int 16	x10, see Mapping Notes – Note 1
11	R	LMV CURRENT SETPOINT	Unsigned Int 16	
12	R	LMV ACTUAL VALUE	Unsigned Int 16	
13	R	LMV FLAME SIGNAL	Unsigned Int 16	x10
14	R	LMV FUEL THROUGHPUT	Unsigned Int 16	
15	R	LMV CURRENT O ₂	Unsigned Int 16	x10
16	R	LMV GAS UNIT	Unsigned Int 16	0=metric,1=standard
17	R	LMV OIL UNIT	Unsigned Int 16	0=metric,1=standard
18	R	LMV TEMPERATURE UNIT	Unsigned Int 16	0=metric,1=standard
19	R	LMV PRESSURE UNIT	Unsigned Int 16	0=metric,1=standard
20	R	LMV SENSOR SELECTION	Unsigned Int 16	see Mapping Notes – Note 2
21	R	LMV STARTUP COUNTER	Unsigned Int 32	
23	R	LMV HOUR COUNTER	Unsigned Int 32	
25	R	LMV CURRENT ERROR CODE	Unsigned Int 16	see LMV5 Lockout/Error Codes
26	R	LMV CURRENT DIAGNOSTIC CODE	Unsigned Int 16	see LMV5 Lockout/Error Codes
27	R	LMV CURRENT ERROR CLASS	Unsigned Int 16	not used
28	R	LMV CURRENT ERROR PHASE	Unsigned Int 16	see LMV Phases
29	R	LMV TEMP LIMIT OFF THRESHOLD	Unsigned Int 16	
30	R	LMV SUPPLY AIR TEMPERATURE	Unsigned Int 16	
31	R	LMV FLUE GAS TEMPERATURE	Unsigned Int 16	
32	R	LMV COMBUSTION EFFICIENCY	Unsigned Int 16	x10
33	R	LMV CURRENT CO ₂	Unsigned Int 16	x10

Modbus LMV5... Mapping

ADDRESS	ACCESS	DESCRIPTION	FORMAT	NOTES
34	R	LMV CURRENT EXCESS AIR	Unsigned Int 16	x10
35	R	LMV INPUT WORD	Unsigned Int 16	word of bits
35 bit 0	R	LMV CONTROLLER SWITCH	Boolean	
35 bit 1	R	LMV FAN CONTACTOR	Boolean	
35 bit 2	R	LMV OIL SELECTED	Boolean	
35 bit 3	R	LMV GAS SELECTED	Boolean	
35 bit 5	R	LMV OIL PRESS SW MAX	Boolean	
35 bit 6	R	LMV OIL PRESS SW MIN	Boolean	
35 bit 7	R	LMV VALVE PROVING SW	Boolean	
35 bit 8	R	LMV SAFETY LOOP	Boolean	
35 bit 10	R	LMV GAS PRESS SW MIN	Boolean	
35 bit 11	R	LMV GAS PRESS SW MAX	Boolean	
35 bit 13	R	LMV AIR PRESSURE SW	Boolean	
35 bit 14	R	LMV START RELEASE OIL	Boolean	
35 bit 15	R	LMV HEAVY OIL START	Boolean	
37	R	LMV OUTPUT WORD	Unsigned Int 16	word of bits
37 bit 0	R	LMV ALARM	Boolean	
37 bit 4	R	LMV IGNITION	Boolean	
37 bit 5	R	LMV START SIGNAL	Boolean	
37 bit 6	R	LMV FAN OUTPUT	Boolean	
37 bit 7	R	LMV OIL PUMP	Boolean	
37 bit 8	R	LMV FUEL VALVE SV OIL	Boolean	
37 bit 9	R	LMV FUEL VALVE V1 OIL	Boolean	
37 bit 10	R	LMV FUEL VALVE V2 OIL	Boolean	
37 bit 11	R	LMV FUEL VALVE V3 OIL	Boolean	
37 bit 12	R	LMV FUEL VALVE SV GAS	Boolean	
37 bit 13	R	LMV FUEL VALVE V1 GAS	Boolean	
37 bit 14	R	LMV FUEL VALVE V2 GAS	Boolean	
37 bit 15	R	LMV FUEL VALVE PV GAS	Boolean	
38	RW*	LMV PROGRAM STOP	Unsigned Int 16	see Mapping Notes – Note 3
39	RW*	LMV LOAD CONTROL MODE	Unsigned Int 16	see Mapping Notes – Note 4
40	R	LMV MANUAL/AUTOMATIC	Unsigned Int 16	0=auto,1=on,2=off
41	RW	LMV MODBUS LOCAL/REMOTE	Unsigned Int 16	0=local,1=remote
42	RW*	LMV MODBUS WATCHDOG	Unsigned Int 16	
43	RW	LMV MODBUS OPERATING MODE	Unsigned Int 16	0=auto,1=on,2=off
44	RW	LMV MODBUS SETPOINT W3	Unsigned Int 16	
45	RW	LMV MODBUS OUTPUT	Unsigned Int 16	x10, see Mapping Notes – Note 1
46	RW*	LMV MODBUS FUEL SELECTION	Unsigned Int 16	0=gas/fuel0,1=oil/fuel1
47	RW*	LMV SETPOINT W1	Unsigned Int 16	
48	RW*	LMV SETPOINT W2	Unsigned Int 16	
49	RW	LMV WEEKDAY	Unsigned Int 16	0=Sun,1=Mon,...,6=Sat
50	RW	LMV YEAR 2-DIGIT	Unsigned Int 16	
51	RW	LMV MONTH	Unsigned Int 16	
52	RW	LMV DAY	Unsigned Int 16	
53	RW	LMV HOUR	Unsigned Int 16	
54	RW	LMV MINUTE	Unsigned Int 16	
55	RW	LMV SECOND	Unsigned Int 16	
56	RW*	LMV HOURS RUN GAS RESET	Unsigned Int 32	
58	RW*	LMV HOURS RUN OIL S1 RESET	Unsigned Int 32	

Modbus LMV5... Mapping

ADDRESS	ACCESS	DESCRIPTION	FORMAT	NOTES
60	RW*	LMV HOURS RUN OIL S2 RESET	Unsigned Int 32	
62	RW*	LMV HOURS RUN OIL S3 RESET	Unsigned Int 32	
64	RW*	LMV HOURS RUN TOTAL RESET	Unsigned Int 32	
66	R	LMV HOURS RUN TOTAL FIXED	Unsigned Int 32	
68	R	LMV HOURS CONNECTED TO POWER	Unsigned Int 32	
70	RW*	LMV STARTUPS GAS RESET	Unsigned Int 32	
72	RW*	LMV STARTUPS OIL RESET	Unsigned Int 32	
74	RW*	LMV STARTUPS TOTAL RESET	Unsigned Int 32	
76	R	LMV STARTUPS TOTAL FIXED	Unsigned Int 32	
78	RW*	LMV TOTAL VOLUME GAS/FUELO	Unsigned Int 32	
80	RW*	LMV TOTAL VOLUME OIL/FUEL1	Unsigned Int 32	
82	R	LMV NUMBER OF LOCKOUTS	Unsigned Int 16	
83	R	LMV EXTRA TEMPERATURE SENSOR	Unsigned Int 16	
84	R	LMV AZL5 ASN STRING	String (8 words)	
92	R	LMV AZL5 PARAMETER SET CODE	Unsigned Int 16	
93	R	LMV AZL5 PARAMETER SET VER	Unsigned Int 16	
94	R	LMV AZL5 ID DATE YEAR 2-DIGIT	Unsigned Int 16	
95	R	LMV AZL5 ID DATE MONTH	Unsigned Int 16	
96	R	LMV AZL5 ID DATE DAY	Unsigned Int 16	
97	R	LMV AZL5 ID NUMBER	Unsigned Int 16	
98	R	LMV BURNER CONTROL STRING	String (8 words)	
106	R	LMV BC PARAMETER SET CODE	Unsigned Int 16	
107	R	LMV BC PARAMETER SET VER	Unsigned Int 16	
108	R	LMV BC ID DATE YEAR 2-DIGIT	Unsigned Int 16	
109	R	LMV BC ID DATE MONTH	Unsigned Int 16	
110	R	LMV BURNER CONTROL ID DATE DAY	Unsigned Int 16	
111	R	LMV BURNER CONTROL ID NUMBER	Unsigned Int 16	
112	R	LMV SOFTWARE VERSION AZL	Unsigned Int 16	read in hexadecimal
113	R	LMV SW VER BURNER CONTROL	Unsigned Int 16	read in hexadecimal
114	R	LMV SW VER LOAD CONTROL	Unsigned Int 16	read in hexadecimal
115	R	LMV BURNER ID STRING	String (8 words)	
123	R	LMV MINIMUM OUTPUT GAS	Unsigned Int 16	x10, see Mapping Notes – Note 1
124	R	LMV MAXIMUM OUTPUT GAS	Unsigned Int 16	x10, see Mapping Notes – Note 1
125	R	LMV MINIMUM OUTPUT OIL	Unsigned Int 16	x10, see Mapping Notes – Note 1
126	R	LMV MAXIMUM OUTPUT OIL	Unsigned Int 16	x10, see Mapping Notes – Note 1
127	RW*	LMV LOAD LIMIT MODULATING	Unsigned Int 16	x10, see Mapping Notes – Note 1
128	RW*	LMV LOAD LIMIT STAGING	Unsigned Int 16	0=S1,1=S2,2=S3
129	R	LMV TEMP LIMIT ON THRESHOLD	Signed Int 16	x10, -50% to 0%
130	R	LMV RANGE TEMPERATURE SENSOR	Unsigned Int 16	0=302F,1=752F,2=1562F
131	R	LMV ADAPTION ACTIVE	Unsigned Int 16	0=inactive,1=active
132	R	LMV ADAPTION STATE	Unsigned Int 16	see Mapping Notes – Note 5
133	RW	LMV START ADAPTION	Unsigned Int 16	0=reset,1=start,2=abort
134	RW*	LMV ADAPTION OUTPUT	Unsigned Int 16	x10
135	RW*	LMV P-VALUE	Unsigned Int 16	x10
136	RW*	LMV I-VALUE	Unsigned Int 16	
137	RW*	LMV D-VALUE	Unsigned Int 16	
400	R	LMV LOCKOUT ERROR CODE CURRENT	Unsigned Int 16	see LMV5 Lockout/Error Codes
401	R	LMV LOCKOUT DIAG CODE CURRENT	Unsigned Int 16	see LMV5 Lockout/Error Codes
402	R	LMV LOCKOUT ERR CLASS CURRENT	Unsigned Int 16	not used

Modbus LMV5... Mapping

ADDRESS	ACCESS	DESCRIPTION	FORMAT	NOTES
403	R	LMV LOCKOUT ERR PHASE CURRENT	Unsigned Int 16	see LMV Phases
404	R	LMV LOCKOUT FUEL CURRENT	Unsigned Int 16	0=gas/fuel0,1=oil/fuel
405	R	LMV LOCKOUT OUTPUT CURRENT	Unsigned Int 16	x10, see Mapping Notes – Note 1
406	R	LMV LOCKOUT YEAR 2-DIG CURRENT	Unsigned Int 16	
407	R	LMV LOCKOUT MONTH CURRENT	Unsigned Int 16	
408	R	LMV LOCKOUT DAY CURRENT	Unsigned Int 16	
409	R	LMV LOCKOUT HOUR CURRENT	Unsigned Int 16	
410	R	LMV LOCKOUT MINUTE CURRENT	Unsigned Int 16	
411	R	LMV LOCKOUT SECOND CURRENT	Unsigned Int 16	
412	R	LMV LOCKOUT STARTUPS CURRENT	Unsigned Int 32	
414	R	LMV LOCKOUT HOURS CURRENT	Unsigned Int 32	
416	R	LMV LOCKOUT ERROR CODE -1	Unsigned Int 16	see LMV5 Lockout/Error Codes
417	R	LMV LOCKOUT DIAG CODE -1	Unsigned Int 16	see LMV5 Lockout/Error Codes
418	R	LMV LOCKOUT ERROR CLASS -1	Unsigned Int 16	not used
419	R	LMV LOCKOUT ERROR PHASE -1	Unsigned Int 16	see LMV Phases
420	R	LMV LOCKOUT FUEL -1	Unsigned Int 16	0=gas/fuel0,1=oil/fuel
421	R	LMV LOCKOUT OUTPUT -1	Unsigned Int 16	x10, see Mapping Notes – Note 1
422	R	LMV LOCKOUT YEAR 2-DIG -1	Unsigned Int 16	
423	R	LMV LOCKOUT MONTH -1	Unsigned Int 16	
424	R	LMV LOCKOUT DAY -1	Unsigned Int 16	
425	R	LMV LOCKOUT HOUR -1	Unsigned Int 16	
426	R	LMV LOCKOUT MINUTE -1	Unsigned Int 16	
427	R	LMV LOCKOUT SECOND -1	Unsigned Int 16	
428	R	LMV LOCKOUT STARTUPS -1	Unsigned Int 32	
430	R	LMV LOCKOUT HOURS -1	Unsigned Int 32	
432	R	LMV LOCKOUT ERROR CODE -2	Unsigned Int 16	see LMV5 Lockout/Error Codes
433	R	LMV LOCKOUT DIAG CODE -2	Unsigned Int 16	see LMV5 Lockout/Error Codes
434	R	LMV LOCKOUT ERROR CLASS -2	Unsigned Int 16	not used
435	R	LMV LOCKOUT ERROR PHASE -2	Unsigned Int 16	see LMV Phases
436	R	LMV LOCKOUT FUEL -2	Unsigned Int 16	0=gas/fuel0,1=oil/fuel
437	R	LMV LOCKOUT OUTPUT -2	Unsigned Int 16	x10, see Mapping Notes – Note 1
438	R	LMV LOCKOUT YEAR 2-DIG -2	Unsigned Int 16	
439	R	LMV LOCKOUT MONTH -2	Unsigned Int 16	
440	R	LMV LOCKOUT DAY -2	Unsigned Int 16	
441	R	LMV LOCKOUT HOUR -2	Unsigned Int 16	
442	R	LMV LOCKOUT MINUTE -2	Unsigned Int 16	
443	R	LMV LOCKOUT SECOND -2	Unsigned Int 16	
444	R	LMV LOCKOUT STARTUPS -2	Unsigned Int 32	
446	R	LMV LOCKOUT HOURS -2	Unsigned Int 32	
448	R	LMV LOCKOUT ERROR CODE -3	Unsigned Int 16	see LMV5 Lockout/Error Codes
449	R	LMV LOCKOUT DIAG CODE -3	Unsigned Int 16	see LMV5 Lockout/Error Codes
450	R	LMV LOCKOUT ERROR CLASS -3	Unsigned Int 16	not used
451	R	LMV LOCKOUT ERROR PHASE -3	Unsigned Int 16	see LMV Phases
452	R	LMV LOCKOUT FUEL -3	Unsigned Int 16	0=gas/fuel0,1=oil/fuel
453	R	LMV LOCKOUT OUTPUT -3	Unsigned Int 16	x10, see Mapping Notes – Note 1
454	R	LMV LOCKOUT YEAR 2-DIG -3	Unsigned Int 16	
455	R	LMV LOCKOUT MONTH -3	Unsigned Int 16	
456	R	LMV LOCKOUT DAY -3	Unsigned Int 16	
457	R	LMV LOCKOUT HOUR -3	Unsigned Int 16	

Modbus LMV5... Mapping

ADDRESS	ACCESS	DESCRIPTION	FORMAT	NOTES
458	R	LMV LOCKOUT MINUTE -3	Unsigned Int 16	
459	R	LMV LOCKOUT SECOND -3	Unsigned Int 16	
460	R	LMV LOCKOUT STARTUPS -3	Unsigned Int 32	
462	R	LMV LOCKOUT HOURS -3	Unsigned Int 32	
464	R	LMV LOCKOUT ERROR CODE -4	Unsigned Int 16	see LMV5 Lockout/Error Codes
465	R	LMV LOCKOUT DIAG CODE -4	Unsigned Int 16	see LMV5 Lockout/Error Codes
466	R	LMV LOCKOUT ERROR CLASS -4	Unsigned Int 16	not used
467	R	LMV LOCKOUT ERROR PHASE -4	Unsigned Int 16	see LMV Phases
468	R	LMV LOCKOUT FUEL -4	Unsigned Int 16	0=gas/fuel0,1=oil/fuel
469	R	LMV LOCKOUT OUTPUT -4	Unsigned Int 16	x10, see Mapping Notes – Note 1
470	R	LMV LOCKOUT YEAR 2-DIG -4	Unsigned Int 16	
471	R	LMV LOCKOUT MONTH -4	Unsigned Int 16	
472	R	LMV LOCKOUT DAY -4	Unsigned Int 16	
473	R	LMV LOCKOUT HOUR -4	Unsigned Int 16	
474	R	LMV LOCKOUT MINUTE -4	Unsigned Int 16	
475	R	LMV LOCKOUT SECOND -4	Unsigned Int 16	
476	R	LMV LOCKOUT STARTUPS -4	Unsigned Int 32	
478	R	LMV LOCKOUT HOURS -4	Unsigned Int 32	
480	R	LMV LOCKOUT ERROR CODE -5	Unsigned Int 16	see LMV5 Lockout/Error Codes
481	R	LMV LOCKOUT DIAG CODE -5	Unsigned Int 16	see LMV5 Lockout/Error Codes
482	R	LMV LOCKOUT ERROR CLASS -5	Unsigned Int 16	not used
483	R	LMV LOCKOUT ERROR PHASE -5	Unsigned Int 16	see LMV Phases
484	R	LMV LOCKOUT FUEL -5	Unsigned Int 16	0=gas/fuel0,1=oil/fuel
485	R	LMV LOCKOUT OUTPUT -5	Unsigned Int 16	x10, see Mapping Notes – Note 1
486	R	LMV LOCKOUT YEAR 2-DIG -5	Unsigned Int 16	
487	R	LMV LOCKOUT MONTH -5	Unsigned Int 16	
488	R	LMV LOCKOUT DAY -5	Unsigned Int 16	
489	R	LMV LOCKOUT HOUR -5	Unsigned Int 16	
490	R	LMV LOCKOUT MINUTE -5	Unsigned Int 16	
491	R	LMV LOCKOUT SECOND -5	Unsigned Int 16	
492	R	LMV LOCKOUT STARTUPS -5	Unsigned Int 32	
494	R	LMV LOCKOUT HOURS -5	Unsigned Int 32	
496	R	LMV LOCKOUT ERROR CODE -6	Unsigned Int 16	see LMV5 Lockout/Error Codes
497	R	LMV LOCKOUT DIAG CODE -6	Unsigned Int 16	see LMV5 Lockout/Error Codes
498	R	LMV LOCKOUT ERROR CLASS -6	Unsigned Int 16	not used
499	R	LMV LOCKOUT ERROR PHASE -6	Unsigned Int 16	see LMV Phases
500	R	LMV LOCKOUT FUEL -6	Unsigned Int 16	0=gas/fuel0,1=oil/fuel
501	R	LMV LOCKOUT OUTPUT -6	Unsigned Int 16	x10, see Mapping Notes – Note 1
502	R	LMV LOCKOUT YEAR 2-DIG -6	Unsigned Int 16	
503	R	LMV LOCKOUT MONTH -6	Unsigned Int 16	
504	R	LMV LOCKOUT DAY -6	Unsigned Int 16	
505	R	LMV LOCKOUT HOUR -6	Unsigned Int 16	
506	R	LMV LOCKOUT MINUTE -6	Unsigned Int 16	
507	R	LMV LOCKOUT SECOND -6	Unsigned Int 16	
508	R	LMV LOCKOUT STARTUPS -6	Unsigned Int 32	
510	R	LMV LOCKOUT HOURS -6	Unsigned Int 32	
512	R	LMV LOCKOUT ERROR CODE -7	Unsigned Int 16	see LMV5 Lockout/Error Codes
513	R	LMV LOCKOUT DIAG CODE -7	Unsigned Int 16	see LMV5 Lockout/Error Codes
514	R	LMV LOCKOUT ERROR CLASS -7	Unsigned Int 16	not used

Modbus LMV5... Mapping

ADDRESS	ACCESS	DESCRIPTION	FORMAT	NOTES
515	R	LMV LOCKOUT ERROR PHASE -7	Unsigned Int 16	see LMV Phases
516	R	LMV LOCKOUT FUEL -7	Unsigned Int 16	0=gas/fuel0,1=oil/fuel
517	R	LMV LOCKOUT OUTPUT -7	Unsigned Int 16	x10, see Mapping Notes – Note 1
518	R	LMV LOCKOUT YEAR 2-DIG -7	Unsigned Int 16	
519	R	LMV LOCKOUT MONTH -7	Unsigned Int 16	
520	R	LMV LOCKOUT DAY -7	Unsigned Int 16	
521	R	LMV LOCKOUT HOUR -7	Unsigned Int 16	
522	R	LMV LOCKOUT MINUTE -7	Unsigned Int 16	
523	R	LMV LOCKOUT SECOND -7	Unsigned Int 16	
524	R	LMV LOCKOUT STARTUPS -7	Unsigned Int 32	
526	R	LMV LOCKOUT HOURS -7	Unsigned Int 32	
528	R	LMV LOCKOUT ERROR CODE -8	Unsigned Int 16	see LMV5 Lockout/Error Codes
529	R	LMV LOCKOUT DIAG CODE -8	Unsigned Int 16	see LMV5 Lockout/Error Codes
530	R	LMV LOCKOUT ERROR CLASS -8	Unsigned Int 16	not used
531	R	LMV LOCKOUT ERROR PHASE -8	Unsigned Int 16	see LMV Phases
532	R	LMV LOCKOUT FUEL -8	Unsigned Int 16	0=gas/fuel0,1=oil/fuel
533	R	LMV LOCKOUT OUTPUT -8	Unsigned Int 16	x10, see Mapping Notes – Note 1
534	R	LMV LOCKOUT YEAR 2-DIG -8	Unsigned Int 16	
535	R	LMV LOCKOUT MONTH -8	Unsigned Int 16	
536	R	LMV LOCKOUT DAY -8	Unsigned Int 16	
537	R	LMV LOCKOUT HOUR -8	Unsigned Int 16	
538	R	LMV LOCKOUT MINUTE -8	Unsigned Int 16	
539	R	LMV LOCKOUT SECOND -8	Unsigned Int 16	
540	R	LMV LOCKOUT STARTUPS -8	Unsigned Int 32	
542	R	LMV LOCKOUT HOURS -8	Unsigned Int 32	
544	R	LMV ERROR ERROR CODE CURRENT	Unsigned Int 16	see LMV5 Lockout/Error Codes
545	R	LMV ERROR DIAG CODE CURRENT	Unsigned Int 16	see LMV5 Lockout/Error Codes
546	R	LMV ERROR ERROR CLASS CURRENT	Unsigned Int 16	not used
547	R	LMV ERROR ERROR PHASE CURRENT	Unsigned Int 16	see LMV Phases
548	R	LMV ERROR FUEL CURRENT	Unsigned Int 16	0=gas/fuel0,1=oil/fuel
549	R	LMV ERROR OUTPUT CURRENT	Unsigned Int 16	x10, see Mapping Notes – Note 1
550	R	LMV ERROR STARTUPS CURRENT	Unsigned Int 32	
552	R	LMV ERROR ERROR CODE -1	Unsigned Int 16	see LMV5 Lockout/Error Codes
553	R	LMV ERROR DIAG CODE -1	Unsigned Int 16	see LMV5 Lockout/Error Codes
554	R	LMV ERROR ERROR CLASS -1	Unsigned Int 16	not used
555	R	LMV ERROR ERROR PHASE -1	Unsigned Int 16	see LMV Phases
556	R	LMV ERROR FUEL -1	Unsigned Int 16	0=gas/fuel0,1=oil/fuel
557	R	LMV ERROR OUTPUT -1	Unsigned Int 16	x10, see Mapping Notes – Note 1
558	R	LMV ERROR STARTUPS -1	Unsigned Int 32	
560	R	LMV ERROR ERROR CODE -2	Unsigned Int 16	see LMV5 Lockout/Error Codes
561	R	LMV ERROR DIAG CODE -2	Unsigned Int 16	see LMV5 Lockout/Error Codes
562	R	LMV ERROR ERROR CLASS -2	Unsigned Int 16	not used
563	R	LMV ERROR ERROR PHASE -2	Unsigned Int 16	see LMV Phases
564	R	LMV ERROR FUEL -2	Unsigned Int 16	0=gas/fuel0,1=oil/fuel
565	R	LMV ERROR OUTPUT -2	Unsigned Int 16	x10, see Mapping Notes – Note 1
566	R	LMV ERROR STARTUPS -2	Unsigned Int 32	
568	R	LMV ERROR ERROR CODE -3	Unsigned Int 16	see LMV5 Lockout/Error Codes
569	R	LMV ERROR DIAG CODE -3	Unsigned Int 16	see LMV5 Lockout/Error Codes
570	R	LMV ERROR ERROR CLASS -3	Unsigned Int 16	not used

Modbus LMV5... Mapping

ADDRESS	ACCESS	DESCRIPTION	FORMAT	NOTES
571	R	LMV ERROR ERROR PHASE -3	Unsigned Int 16	see LMV Phases
572	R	LMV ERROR FUEL -3	Unsigned Int 16	0=gas/fuel0,1=oil/fuel
573	R	LMV ERROR OUTPUT -3	Unsigned Int 16	x10, see Mapping Notes – Note 1
574	R	LMV ERROR STARTUPS -3	Unsigned Int 32	
576	R	LMV ERROR ERROR CODE -4	Unsigned Int 16	see LMV5 Lockout/Error Codes
577	R	LMV ERROR DIAG CODE -4	Unsigned Int 16	see LMV5 Lockout/Error Codes
578	R	LMV ERROR ERROR CLASS -4	Unsigned Int 16	not used
579	R	LMV ERROR ERROR PHASE -4	Unsigned Int 16	see LMV Phases
580	R	LMV ERROR FUEL -4	Unsigned Int 16	0=gas/fuel0,1=oil/fuel
581	R	LMV ERROR OUTPUT -4	Unsigned Int 16	x10, see Mapping Notes – Note 1
582	R	LMV ERROR STARTUPS -4	Unsigned Int 32	
584	R	LMV ERROR ERROR CODE -5	Unsigned Int 16	see LMV5 Lockout/Error Codes
585	R	LMV ERROR DIAG CODE -5	Unsigned Int 16	see LMV5 Lockout/Error Codes
586	R	LMV ERROR ERROR CLASS -5	Unsigned Int 16	not used
587	R	LMV ERROR ERROR PHASE -5	Unsigned Int 16	see LMV Phases
588	R	LMV ERROR FUEL -5	Unsigned Int 16	0=gas/fuel0,1=oil/fuel
589	R	LMV ERROR OUTPUT -5	Unsigned Int 16	x10, see Mapping Notes – Note 1
590	R	LMV ERROR STARTUPS -5	Unsigned Int 32	
592	R	LMV ERROR ERROR CODE -6	Unsigned Int 16	see LMV5 Lockout/Error Codes
593	R	LMV ERROR DIAG CODE -6	Unsigned Int 16	see LMV5 Lockout/Error Codes
594	R	LMV ERROR ERROR CLASS -6	Unsigned Int 16	not used
595	R	LMV ERROR ERROR PHASE -6	Unsigned Int 16	see LMV Phases
596	R	LMV ERROR FUEL -6	Unsigned Int 16	0=gas/fuel0,1=oil/fuel
597	R	LMV ERROR OUTPUT -6	Unsigned Int 16	x10, see Mapping Notes – Note 1
598	R	LMV ERROR STARTUPS -6	Unsigned Int 32	
600	R	LMV ERROR ERROR CODE -7	Unsigned Int 16	see LMV5 Lockout/Error Codes
601	R	LMV ERROR DIAG CODE -7	Unsigned Int 16	see LMV5 Lockout/Error Codes
602	R	LMV ERROR ERROR CLASS -7	Unsigned Int 16	not used
603	R	LMV ERROR ERROR PHASE -7	Unsigned Int 16	see LMV Phases
604	R	LMV ERROR FUEL -7	Unsigned Int 16	0=gas/fuel0,1=oil/fuel
605	R	LMV ERROR OUTPUT -7	Unsigned Int 16	x10, see Mapping Notes – Note 1
606	R	LMV ERROR STARTUPS -7	Unsigned Int 32	
608	R	LMV ERROR ERROR CODE -8	Unsigned Int 16	see LMV5 Lockout/Error Codes
609	R	LMV ERROR DIAG CODE -8	Unsigned Int 16	see LMV5 Lockout/Error Codes
610	R	LMV ERROR ERROR CLASS -8	Unsigned Int 16	not used
611	R	LMV ERROR ERROR PHASE -8	Unsigned Int 16	see LMV Phases
612	R	LMV ERROR FUEL -8	Unsigned Int 16	0=gas/fuel0,1=oil/fuel
613	R	LMV ERROR OUTPUT -8	Unsigned Int 16	x10, see Mapping Notes – Note 1
614	R	LMV ERROR STARTUPS -8	Unsigned Int 32	
616	R	LMV ERROR ERROR CODE -9	Unsigned Int 16	see LMV5 Lockout/Error Codes
617	R	LMV ERROR DIAG CODE -9	Unsigned Int 16	see LMV5 Lockout/Error Codes
618	R	LMV ERROR ERROR CLASS -9	Unsigned Int 16	not used
619	R	LMV ERROR ERROR PHASE -9	Unsigned Int 16	see LMV Phases
620	R	LMV ERROR FUEL -9	Unsigned Int 16	0=gas/fuel0,1=oil/fuel
621	R	LMV ERROR OUTPUT -9	Unsigned Int 16	x10, see Mapping Notes – Note 1
622	R	LMV ERROR STARTUPS -9	Unsigned Int 32	
624	R	LMV ERROR ERROR CODE -10	Unsigned Int 16	see LMV5 Lockout/Error Codes
625	R	LMV ERROR DIAG CODE -10	Unsigned Int 16	see LMV5 Lockout/Error Codes
626	R	LMV ERROR ERROR CLASS -10	Unsigned Int 16	not used

Modbus LMV5... Mapping

ADDRESS	ACCESS	DESCRIPTION	FORMAT	NOTES
627	R	LMV ERROR ERROR PHASE -10	Unsigned Int 16	see LMV Phases
628	R	LMV ERROR FUEL -10	Unsigned Int 16	0=gas/fuel0,1=oil/fuel
629	R	LMV ERROR OUTPUT -10	Unsigned Int 16	x10, see Mapping Notes – Note 1
630	R	LMV ERROR STARTUPS -10	Unsigned Int 32	
632	R	LMV ERROR ERROR CODE -11	Unsigned Int 16	see LMV5 Lockout/Error Codes
633	R	LMV ERROR DIAG CODE -11	Unsigned Int 16	see LMV5 Lockout/Error Codes
634	R	LMV ERROR ERROR CLASS -11	Unsigned Int 16	not used
635	R	LMV ERROR ERROR PHASE -11	Unsigned Int 16	see LMV Phases
636	R	LMV ERROR FUEL -11	Unsigned Int 16	0=gas/fuel0,1=oil/fuel
637	R	LMV ERROR OUTPUT -11	Unsigned Int 16	x10, see Mapping Notes – Note 1
638	R	LMV ERROR STARTUPS -11	Unsigned Int 32	
640	R	LMV ERROR ERROR CODE -12	Unsigned Int 16	see LMV5 Lockout/Error Codes
641	R	LMV ERROR DIAG CODE -12	Unsigned Int 16	see LMV5 Lockout/Error Codes
642	R	LMV ERROR ERROR CLASS -12	Unsigned Int 16	not used
643	R	LMV ERROR ERROR PHASE -12	Unsigned Int 32	see LMV Phases
644	R	LMV ERROR FUEL -12	Unsigned Int 16	0=gas/fuel0,1=oil/fuel
645	R	LMV ERROR OUTPUT -12	Unsigned Int 16	x10, see Mapping Notes – Note 1
646	R	LMV ERROR STARTUPS -12	Unsigned Int 16	
648	R	LMV ERROR ERROR CODE -13	Unsigned Int 16	see LMV5 Lockout/Error Codes
649	R	LMV ERROR DIAG CODE -13	Unsigned Int 16	see LMV5 Lockout/Error Codes
650	R	LMV ERROR ERROR CLASS -13	Unsigned Int 16	not used
651	R	LMV ERROR ERROR PHASE -13	Unsigned Int 16	see LMV Phases
652	R	LMV ERROR FUEL -13	Unsigned Int 16	0=gas/fuel0,1=oil/fuel
653	R	LMV ERROR OUTPUT -13	Unsigned Int 16	x10, see Mapping Notes – Note 1
654	R	LMV ERROR STARTUPS -13	Unsigned Int 32	
656	R	LMV ERROR ERROR CODE -14	Unsigned Int 16	see LMV5 Lockout/Error Codes
657	R	LMV ERROR DIAG CODE -14	Unsigned Int 16	see LMV5 Lockout/Error Codes
658	R	LMV ERROR ERROR CLASS -14	Unsigned Int 16	not used
659	R	LMV ERROR ERROR PHASE -14	Unsigned Int 16	see LMV Phases
660	R	LMV ERROR FUEL -14	Unsigned Int 16	0=gas/fuel0,1=oil/fuel
661	R	LMV ERROR OUTPUT -14	Unsigned Int 16	x10, see Mapping Notes – Note 1
662	R	LMV ERROR STARTUPS -14	Unsigned Int 32	
664	R	LMV ERROR ERROR CODE -15	Unsigned Int 16	see LMV5 Lockout/Error Codes
665	R	LMV ERROR DIAG CODE -15	Unsigned Int 16	see LMV5 Lockout/Error Codes
666	R	LMV ERROR ERROR CLASS -15	Unsigned Int 16	not used
667	R	LMV ERROR ERROR PHASE -15	Unsigned Int 16	see LMV Phases
668	R	LMV ERROR FUEL -15	Unsigned Int 16	0=gas/fuel0,1=oil/fuel
669	R	LMV ERROR OUTPUT -15	Unsigned Int 16	x10, see Mapping Notes – Note 1
670	R	LMV ERROR STARTUPS -15	Unsigned Int 32	
672	R	LMV ERROR ERROR CODE -16	Unsigned Int 16	see LMV5 Lockout/Error Codes
673	R	LMV ERROR DIAG CODE -16	Unsigned Int 16	see LMV5 Lockout/Error Codes
674	R	LMV ERROR ERROR CLASS -16	Unsigned Int 16	not used
675	R	LMV ERROR ERROR PHASE -16	Unsigned Int 16	see LMV Phases
676	R	LMV ERROR FUEL -16	Unsigned Int 16	0=gas/fuel0,1=oil/fuel
677	R	LMV ERROR OUTPUT -16	Unsigned Int 16	x10, see Mapping Notes – Note 1
678	R	LMV ERROR STARTUPS -16	Unsigned Int 32	
680	R	LMV ERROR ERROR CODE -17	Unsigned Int 16	see LMV5 Lockout/Error Codes
681	R	LMV ERROR DIAG CODE -17	Unsigned Int 16	see LMV5 Lockout/Error Codes
682	R	LMV ERROR ERROR CLASS -17	Unsigned Int 16	not used

Modbus LMV5... Mapping

ADDRESS	ACCESS	DESCRIPTION	FORMAT	NOTES
683	R	LMV ERROR ERROR PHASE -17	Unsigned Int 16	see LMV Phases
684	R	LMV ERROR FUEL -17	Unsigned Int 16	0=gas/fuel0,1=oil/fuel
685	R	LMV ERROR OUTPUT -17	Unsigned Int 16	x10, see Mapping Notes – Note 1
686	R	LMV ERROR STARTUPS -17	Unsigned Int 32	
688	R	LMV ERROR ERROR CODE -18	Unsigned Int 16	see LMV5 Lockout/Error Codes
689	R	LMV ERROR DIAG CODE -18	Unsigned Int 16	see LMV5 Lockout/Error Codes
690	R	LMV ERROR ERROR CLASS -18	Unsigned Int 16	not used
691	R	LMV ERROR ERROR PHASE -18	Unsigned Int 16	see LMV Phases
692	R	LMV ERROR FUEL -18	Unsigned Int 16	0=gas/fuel0,1=oil/fuel
693	R	LMV ERROR OUTPUT -18	Unsigned Int 16	x10, see Mapping Notes – Note 1
694	R	LMV ERROR STARTUPS -18	Unsigned Int 32	
696	R	LMV ERROR ERROR CODE -19	Unsigned Int 16	see LMV5 Lockout/Error Codes
697	R	LMV ERROR DIAG CODE -19	Unsigned Int 16	see LMV5 Lockout/Error Codes
698	R	LMV ERROR ERROR CLASS -19	Unsigned Int 16	not used
699	R	LMV ERROR ERROR PHASE -19	Unsigned Int 16	see LMV Phases
700	R	LMV ERROR FUEL -19	Unsigned Int 16	0=gas/fuel0,1=oil/fuel
701	R	LMV ERROR OUTPUT -19	Unsigned Int 16	x10, see Mapping Notes – Note 1
702	R	LMV ERROR STARTUPS -19	Unsigned Int 32	
704	R	LMV ERROR ERROR CODE -20	Unsigned Int 16	see LMV5 Lockout/Error Codes
705	R	LMV ERROR DIAG CODE -20	Unsigned Int 16	see LMV5 Lockout/Error Codes
706	R	LMV ERROR ERROR CLASS -20	Unsigned Int 16	not used
707	R	LMV ERROR ERROR PHASE -20	Unsigned Int 16	see LMV Phases
708	R	LMV ERROR FUEL -20	Unsigned Int 16	0=gas/fuel0,1=oil/fuel
709	R	LMV ERROR OUTPUT -20	Unsigned Int 16	x10, see Mapping Notes – Note 1
710	R	LMV ERROR STARTUPS -20	Unsigned Int 32	

Modbus – Mapping (continued)

LMV3...

There is a read limit of 20 words per message. If a message is invalid, the LMV3... will not respond with an exception. Messages must begin and end on a valid register. Multi-register formats such as 32-bit or string data must be read entirely to be a valid message. Access marked with an asterisk (*) are EEPROM backed and should not be continuously written.

Modbus LMV3... Mapping

ADDRESS	ACCESS	DESCRIPTION	FORMAT	NOTES
0	R	LMV PHASE	Unsigned Int 16	see LMV Phases
1	R	LMV FUEL ACTUATOR	Signed Int 16	x10
4	R	LMV AIR ACTUATOR	Signed Int 16	X10
8	R	LMV VSD OUTPUT	Unsigned Int 16	x10
9	R	LMV CURRENT FUEL	Unsigned Int 16	0=gas/fuel0,1=oil/fuel1
10	R	LMV CURRENT OUTPUT	Unsigned Int 16	x10, see Mapping Notes – Note 1
13	R	LMV FLAME SIGNAL	Unsigned Int 16	x10
14	R	LMV FUEL THROUGHPUT	Unsigned Int 16	
21	R	LMV STARTUP COUNTER	Unsigned Int 32	
25	R	LMV CURRENT ERROR CODE	Unsigned Int 16	see LMV3 Error Codes
26	R	LMV CURRENT DIAGNOSTIC CODE	Unsigned Int 16	see LMV3 Error Codes
27	R	LMV CURRENT ERROR CLASS	Unsigned Int 16	not used
28	R	LMV CURRENT ERROR PHASE	Unsigned Int 16	see LMV Phases
35	R	LMV INPUT WORD	Unsigned Int 16	word of bits
35 bit 0	R	LMV CONTROLLER SWITCH	Boolean	
35 bit 7	R	LMV VALVE PROVING SW	Boolean	
35 bit 8	R	LMV SAFETY LOOP	Boolean	
35 bit 10	R	LMV GAS PRESS SW MIN	Boolean	
35 bit 11	R	LMV GAS PRESS SW MAX	Boolean	
35 bit 13	R	LMV AIR PRESSURE SW	Boolean	
37	R	LMV OUTPUT WORD	Unsigned Int 16	word of bits
37 bit 0	R	LMV ALARM	Boolean	
37 bit 4	R	LMV IGNITION	Boolean	
37 bit 6	R	LMV FAN OUTPUT	Boolean	
37 bit 13	R	LMV FUEL VALVE V1 GAS	Boolean	
37 bit 14	R	LMV FUEL VALVE V2 GAS	Boolean	
37 bit 15	R	LMV FUEL VALVE PV GAS	Boolean	
38	RW*	LMV PROGRAM STOP	Unsigned Int 16	see Mapping Notes – Note 3
41	RW	LMV MODBUS LOCAL/REMOTE	Unsigned Int 16	0=local,1=remote
42	RW*	LMV MODBUS WATCHDOG	Unsigned Int 16	
43	RW	LMV MODBUS OPERATING MODE	Unsigned Int 16	0=auto,1=on,2=off
45	RW	LMV MODBUS OUTPUT	Unsigned Int 16	x10, see Mapping Notes – Note 1
55	RW	LMV SECOND	Unsigned Int 16	
56	RW*	LMV HOURS RUN FUEL 0 RESET	Unsigned Int 32	
58	RW*	LMV HOURS RUN FUEL 1 RESET	Unsigned Int 32	
68	R	LMV HOURS CONNECTED TO POWER	Unsigned Int 32	
70	RW*	LMV STARTUPS FUEL 0 RESET	Unsigned Int 32	
72	RW*	LMV STARTUPS FUEL 1 RESET	Unsigned Int 32	
76	R	LMV STARTUPS TOTAL FIXED	Unsigned Int 32	
78	RW*	LMV TOTAL VOLUME FUEL 0	Unsigned Int 32	

Modbus LMV3... Mapping

ADDRESS	ACCESS	DESCRIPTION	FORMAT	NOTES
80	RW*	LMV TOTAL VOLUME FUEL 1	Unsigned Int 32	
82	R	LMV NUMBER OF LOCKOUTS	Unsigned Int 16	
84	RW*	LMV PRESELECT OUTPUT FUEL 0	Unsigned Int 16	
85	RW*	LMV PRESELECT OUTPUT FUEL 1	Unsigned Int 16	
98	R	LMV BURNER CONTROL STRING	String (8 words)	
106	R	LMV BC PARAMETER SET CODE	Unsigned Int 16	
107	R	LMV BC PARAMETER SET VER	Unsigned Int 16	
108	R	LMV BC ID DATE YEAR 2-DIGIT	Unsigned Int 16	
109	R	LMV BC ID DATE MONTH	Unsigned Int 16	
110	R	LMV BURNER CONTROL ID DATE DAY	Unsigned Int 16	
111	R	LMV BURNER CONTROL ID NUMBER	Unsigned Int 16	
113	R	LMV SW VER BURNER CONTROL	Unsigned Int 16	read in hexadecimal
115	R	LMV BURNER ID STRING	String (8 words)	
123	R	LMV MINIMUM OUTPUT FUEL 0	Unsigned Int 16	x10, see Mapping Notes – Note 1
124	R	LMV MAXIMUM OUTPUT FUEL 0	Unsigned Int 16	x10, see Mapping Notes – Note 1
125	R	LMV MINIMUM OUTPUT FUEL 1	Unsigned Int 16	x10, see Mapping Notes – Note 1
126	R	LMV MAXIMUM OUTPUT FUEL 1	Unsigned Int 16	x10, see Mapping Notes – Note 1
127	R	LMV OPERATING MODE FUEL 0	Unsigned Int 16	software version 3.40 and above
128	R	LMV OPERATING MODE FUEL 1	Unsigned Int 16	software version 3.40 and above
129	R	LMV CYCLES REVERT TO PILOT	Unsigned Int 32	software version 3.40 and above
140	R	LMV OPERATING MODE FUEL 0	Unsigned Int 16	software version 3.70 and above
141	R	LMV OPERATING MODE FUEL 1	Unsigned Int 16	software version 3.70 and above
142	R	LMV CYCLES REVERT TO PILOT	Unsigned Int 32	software version 3.70 and above
144	R	LMV LOW RANGE TRIM FUEL 0	Signed Int 16	software version 3.70 and above
145	R	LMV HIGH RANGE TRIM FUEL 0	Signed Int 16	software version 3.70 and above
146	R	LMV LOW RANGE TRIM FUEL 1	Signed Int 16	software version 3.70 and above
147	R	LMV HIGH RANGE TRIM FUEL 1	Signed Int 16	software version 3.70 and above
148	R	LMV ANALOG TRIM INPUT	Signed Int 16	software version 3.70 and above
149	R	LMV CURRENT TRIM CORRECTION	Signed Int 16	software version 3.70 and above
150	R	LMV ABSOLUTE SPEED	Unsigned Int 16	software version 3.70 and above
151	R	LMV MAINS VOLTAGE	Unsigned Int 16	software version 3.70 and above
544	R	LMV ERROR ERROR CODE CURRENT	Unsigned Int 16	see LMV3 Error Codes
545	R	LMV ERROR DIAG CODE CURRENT	Unsigned Int 16	see LMV3 Error Codes
546	R	LMV ERROR ERROR CLASS CURRENT	Unsigned Int 16	not used
547	R	LMV ERROR ERROR PHASE CURRENT	Unsigned Int 16	see LMV Phases
548	R	LMV ERROR FUEL CURRENT	Unsigned Int 16	0=gas/fuel0,1=oil/fuel
549	R	LMV ERROR OUTPUT CURRENT	Unsigned Int 16	x10, see Mapping Notes – Note 1
550	R	LMV ERROR STARTUPS CURRENT	Unsigned Int 32	
552	R	LMV ERROR ERROR CODE -1	Unsigned Int 16	see LMV3 Error Codes
553	R	LMV ERROR DIAG CODE -1	Unsigned Int 16	see LMV3 Error Codes
554	R	LMV ERROR ERROR CLASS -1	Unsigned Int 16	not used
555	R	LMV ERROR ERROR PHASE -1	Unsigned Int 16	see LMV Phases
556	R	LMV ERROR FUEL -1	Unsigned Int 16	0=gas/fuel0,1=oil/fuel
557	R	LMV ERROR OUTPUT -1	Unsigned Int 16	x10, see Mapping Notes – Note 1
558	R	LMV ERROR STARTUPS -1	Unsigned Int 32	
560	R	LMV ERROR ERROR CODE -2	Unsigned Int 16	see LMV3 Error Codes
561	R	LMV ERROR DIAG CODE -2	Unsigned Int 16	see LMV3 Error Codes
562	R	LMV ERROR ERROR CLASS -2	Unsigned Int 16	not used
563	R	LMV ERROR ERROR PHASE -2	Unsigned Int 16	see LMV Phases

Modbus LMV3... Mapping

ADDRESS	ACCESS	DESCRIPTION	FORMAT	NOTES
564	R	LMV ERROR FUEL -2	Unsigned Int 16	0=gas/fuel0,1=oil/fuel
565	R	LMV ERROR OUTPUT -2	Unsigned Int 16	x10, see Mapping Notes – Note 1
566	R	LMV ERROR STARTUPS -2	Unsigned Int 32	
568	R	LMV ERROR ERROR CODE -3	Unsigned Int 16	see LMV3 Error Codes
569	R	LMV ERROR DIAG CODE -3	Unsigned Int 16	see LMV3 Error Codes
570	R	LMV ERROR ERROR CLASS -3	Unsigned Int 16	not used
571	R	LMV ERROR ERROR PHASE -3	Unsigned Int 16	see LMV Phases
572	R	LMV ERROR FUEL -3	Unsigned Int 16	0=gas/fuel0,1=oil/fuel
573	R	LMV ERROR OUTPUT -3	Unsigned Int 16	x10, see Mapping Notes – Note 1
574	R	LMV ERROR STARTUPS -3	Unsigned Int 32	
576	R	LMV ERROR ERROR CODE -4	Unsigned Int 16	see LMV3 Error Codes
577	R	LMV ERROR DIAG CODE -4	Unsigned Int 16	see LMV3 Error Codes
578	R	LMV ERROR ERROR CLASS -4	Unsigned Int 16	not used
579	R	LMV ERROR ERROR PHASE -4	Unsigned Int 16	see LMV Phases
580	R	LMV ERROR FUEL -4	Unsigned Int 16	0=gas/fuel0,1=oil/fuel
581	R	LMV ERROR OUTPUT -4	Unsigned Int 16	x10, see Mapping Notes – Note 1
582	R	LMV ERROR STARTUPS -4	Unsigned Int 32	
584	R	LMV ERROR ERROR CODE -5	Unsigned Int 16	see LMV3 Error Codes
585	R	LMV ERROR DIAG CODE -5	Unsigned Int 16	see LMV3 Error Codes
586	R	LMV ERROR ERROR CLASS -5	Unsigned Int 16	not used
587	R	LMV ERROR ERROR PHASE -5	Unsigned Int 16	see LMV Phases
588	R	LMV ERROR FUEL -5	Unsigned Int 16	0=gas/fuel0,1=oil/fuel
589	R	LMV ERROR OUTPUT -5	Unsigned Int 16	x10, see Mapping Notes – Note 1
590	R	LMV ERROR STARTUPS -5	Unsigned Int 32	
592	R	LMV ERROR ERROR CODE -6	Unsigned Int 16	see LMV3 Error Codes
593	R	LMV ERROR DIAG CODE -6	Unsigned Int 16	see LMV3 Error Codes
594	R	LMV ERROR ERROR CLASS -6	Unsigned Int 16	not used
595	R	LMV ERROR ERROR PHASE -6	Unsigned Int 16	see LMV Phases
596	R	LMV ERROR FUEL -6	Unsigned Int 16	0=gas/fuel0,1=oil/fuel
597	R	LMV ERROR OUTPUT -6	Unsigned Int 16	x10, see Mapping Notes – Note 1
598	R	LMV ERROR STARTUPS -6	Unsigned Int 32	
600	R	LMV ERROR ERROR CODE -7	Unsigned Int 16	see LMV3 Error Codes
601	R	LMV ERROR DIAG CODE -7	Unsigned Int 16	see LMV3 Error Codes
602	R	LMV ERROR ERROR CLASS -7	Unsigned Int 16	not used
603	R	LMV ERROR ERROR PHASE -7	Unsigned Int 16	see LMV Phases
604	R	LMV ERROR FUEL -7	Unsigned Int 16	0=gas/fuel0,1=oil/fuel
605	R	LMV ERROR OUTPUT -7	Unsigned Int 16	x10, see Mapping Notes – Note 1
606	R	LMV ERROR STARTUPS -7	Unsigned Int 32	
608	R	LMV ERROR ERROR CODE -8	Unsigned Int 16	see LMV3 Error Codes
609	R	LMV ERROR DIAG CODE -8	Unsigned Int 16	see LMV3 Error Codes
610	R	LMV ERROR ERROR CLASS -8	Unsigned Int 16	not used
611	R	LMV ERROR ERROR PHASE -8	Unsigned Int 16	see LMV Phases
612	R	LMV ERROR FUEL -8	Unsigned Int 16	0=gas/fuel0,1=oil/fuel
613	R	LMV ERROR OUTPUT -8	Unsigned Int 16	x10, see Mapping Notes – Note 1
614	R	LMV ERROR STARTUPS -8	Unsigned Int 32	
616	R	LMV ERROR ERROR CODE -9	Unsigned Int 16	see LMV3 Error Codes
617	R	LMV ERROR DIAG CODE -9	Unsigned Int 16	see LMV3 Error Codes
618	R	LMV ERROR ERROR CLASS -9	Unsigned Int 16	not used
619	R	LMV ERROR ERROR PHASE -9	Unsigned Int 16	see LMV Phases

Modbus LMV3... Mapping

ADDRESS	ACCESS	DESCRIPTION	FORMAT	NOTES
620	R	LMV ERROR FUEL -9	Unsigned Int 16	0=gas/fuel0,1=oil/fuel
621	R	LMV ERROR OUTPUT -9	Unsigned Int 16	x10, see Mapping Notes – Note 1
622	R	LMV ERROR STARTUPS -9	Unsigned Int 32	
624	R	LMV ERROR ERROR CODE -10	Unsigned Int 16	see LMV3 Error Codes
625	R	LMV ERROR DIAG CODE -10	Unsigned Int 16	see LMV3 Error Codes
626	R	LMV ERROR ERROR CLASS -10	Unsigned Int 16	not used
627	R	LMV ERROR ERROR PHASE -10	Unsigned Int 16	see LMV Phases
628	R	LMV ERROR FUEL -10	Unsigned Int 16	0=gas/fuel0,1=oil/fuel
629	R	LMV ERROR OUTPUT -10	Unsigned Int 16	x10, see Mapping Notes – Note 1
630	R	LMV ERROR STARTUPS -10	Unsigned Int 32	
632	R	LMV ERROR ERROR CODE -11	Unsigned Int 16	see LMV3 Error Codes
633	R	LMV ERROR DIAG CODE -11	Unsigned Int 16	see LMV3 Error Codes
634	R	LMV ERROR ERROR CLASS -11	Unsigned Int 16	not used
635	R	LMV ERROR ERROR PHASE -11	Unsigned Int 16	see LMV Phases
636	R	LMV ERROR FUEL -11	Unsigned Int 16	0=gas/fuel0,1=oil/fuel
637	R	LMV ERROR OUTPUT -11	Unsigned Int 16	x10, see Mapping Notes – Note 1
638	R	LMV ERROR STARTUPS -11	Unsigned Int 32	
640	R	LMV ERROR ERROR CODE -12	Unsigned Int 16	see LMV3 Error Codes
641	R	LMV ERROR DIAG CODE -12	Unsigned Int 16	see LMV3 Error Codes
642	R	LMV ERROR ERROR CLASS -12	Unsigned Int 16	not used
643	R	LMV ERROR ERROR PHASE -12	Unsigned Int 32	see LMV Phases
644	R	LMV ERROR FUEL -12	Unsigned Int 16	0=gas/fuel0,1=oil/fuel
645	R	LMV ERROR OUTPUT -12	Unsigned Int 16	x10, see Mapping Notes – Note 1
646	R	LMV ERROR STARTUPS -12	Unsigned Int 16	
648	R	LMV ERROR ERROR CODE -13	Unsigned Int 16	see LMV3 Error Codes
649	R	LMV ERROR DIAG CODE -13	Unsigned Int 16	see LMV3 Error Codes
650	R	LMV ERROR ERROR CLASS -13	Unsigned Int 16	not used
651	R	LMV ERROR ERROR PHASE -13	Unsigned Int 16	see LMV Phases
652	R	LMV ERROR FUEL -13	Unsigned Int 16	0=gas/fuel0,1=oil/fuel
653	R	LMV ERROR OUTPUT -13	Unsigned Int 16	x10, see Mapping Notes – Note 1
654	R	LMV ERROR STARTUPS -13	Unsigned Int 32	
656	R	LMV ERROR ERROR CODE -14	Unsigned Int 16	see LMV3 Error Codes
657	R	LMV ERROR DIAG CODE -14	Unsigned Int 16	see LMV3 Error Codes
658	R	LMV ERROR ERROR CLASS -14	Unsigned Int 16	not used
659	R	LMV ERROR ERROR PHASE -14	Unsigned Int 16	see LMV Phases
660	R	LMV ERROR FUEL -14	Unsigned Int 16	0=gas/fuel0,1=oil/fuel
661	R	LMV ERROR OUTPUT -14	Unsigned Int 16	x10, see Mapping Notes – Note 1
662	R	LMV ERROR STARTUPS -14	Unsigned Int 32	
664	R	LMV ERROR ERROR CODE -15	Unsigned Int 16	see LMV3 Error Codes
665	R	LMV ERROR DIAG CODE -15	Unsigned Int 16	see LMV3 Error Codes
666	R	LMV ERROR ERROR CLASS -15	Unsigned Int 16	not used
667	R	LMV ERROR ERROR PHASE -15	Unsigned Int 16	see LMV Phases
668	R	LMV ERROR FUEL -15	Unsigned Int 16	0=gas/fuel0,1=oil/fuel
669	R	LMV ERROR OUTPUT -15	Unsigned Int 16	x10, see Mapping Notes – Note 1
670	R	LMV ERROR STARTUPS -15	Unsigned Int 32	
672	R	LMV ERROR ERROR CODE -16	Unsigned Int 16	see LMV3 Error Codes
673	R	LMV ERROR DIAG CODE -16	Unsigned Int 16	see LMV3 Error Codes
674	R	LMV ERROR ERROR CLASS -16	Unsigned Int 16	not used
675	R	LMV ERROR ERROR PHASE -16	Unsigned Int 16	see LMV Phases

Modbus LMV3... Mapping

ADDRESS	ACCESS	DESCRIPTION	FORMAT	NOTES
676	R	LMV ERROR FUEL -16	Unsigned Int 16	0=gas/fuel0,1=oil/fuel
677	R	LMV ERROR OUTPUT -16	Unsigned Int 16	x10, see Mapping Notes – Note 1
678	R	LMV ERROR STARTUPS -16	Unsigned Int 32	
680	R	LMV ERROR ERROR CODE -17	Unsigned Int 16	see LMV3 Error Codes
681	R	LMV ERROR DIAG CODE -17	Unsigned Int 16	see LMV3 Error Codes
682	R	LMV ERROR ERROR CLASS -17	Unsigned Int 16	not used
683	R	LMV ERROR ERROR PHASE -17	Unsigned Int 16	see LMV Phases
684	R	LMV ERROR FUEL -17	Unsigned Int 16	0=gas/fuel0,1=oil/fuel
685	R	LMV ERROR OUTPUT -17	Unsigned Int 16	x10, see Mapping Notes – Note 1
686	R	LMV ERROR STARTUPS -17	Unsigned Int 32	
688	R	LMV ERROR ERROR CODE -18	Unsigned Int 16	see LMV3 Error Codes
689	R	LMV ERROR DIAG CODE -18	Unsigned Int 16	see LMV3 Error Codes
690	R	LMV ERROR ERROR CLASS -18	Unsigned Int 16	not used
691	R	LMV ERROR ERROR PHASE -18	Unsigned Int 16	see LMV Phases
692	R	LMV ERROR FUEL -18	Unsigned Int 16	0=gas/fuel0,1=oil/fuel
693	R	LMV ERROR OUTPUT -18	Unsigned Int 16	x10, see Mapping Notes – Note 1
694	R	LMV ERROR STARTUPS -18	Unsigned Int 32	
696	R	LMV ERROR ERROR CODE -19	Unsigned Int 16	see LMV3 Error Codes
697	R	LMV ERROR DIAG CODE -19	Unsigned Int 16	see LMV3 Error Codes
698	R	LMV ERROR ERROR CLASS -19	Unsigned Int 16	not used
699	R	LMV ERROR ERROR PHASE -19	Unsigned Int 16	see LMV Phases
700	R	LMV ERROR FUEL -19	Unsigned Int 16	0=gas/fuel0,1=oil/fuel
701	R	LMV ERROR OUTPUT -19	Unsigned Int 16	x10, see Mapping Notes – Note 1
702	R	LMV ERROR STARTUPS -19	Unsigned Int 32	
704	R	LMV ERROR ERROR CODE -20	Unsigned Int 16	see LMV3 Error Codes
705	R	LMV ERROR DIAG CODE -20	Unsigned Int 16	see LMV3 Error Codes
706	R	LMV ERROR ERROR CLASS -20	Unsigned Int 16	not used
707	R	LMV ERROR ERROR PHASE -20	Unsigned Int 16	see LMV Phases
708	R	LMV ERROR FUEL -20	Unsigned Int 16	0=gas/fuel0,1=oil/fuel
709	R	LMV ERROR OUTPUT -20	Unsigned Int 16	x10, see Mapping Notes – Note 1
710	R	LMV ERROR STARTUPS -20	Unsigned Int 32	
712	R	LMV ERROR ERROR CODE -21	Unsigned Int 16	see LMV3 Error Codes
713	R	LMV ERROR DIAG CODE -21	Unsigned Int 16	see LMV3 Error Codes
714	R	LMV ERROR ERROR CLASS -21	Unsigned Int 16	not used
715	R	LMV ERROR ERROR PHASE -21	Unsigned Int 16	see LMV Phases
716	R	LMV ERROR FUEL -21	Unsigned Int 16	0=gas/fuel0,1=oil/fuel
717	R	LMV ERROR OUTPUT -21	Unsigned Int 16	x10, see Mapping Notes – Note 1
718	R	LMV ERROR STARTUPS -21	Unsigned Int 32	
720	R	LMV ERROR ERROR CODE -22	Unsigned Int 16	see LMV3 Error Codes
721	R	LMV ERROR DIAG CODE -22	Unsigned Int 16	see LMV3 Error Codes
722	R	LMV ERROR ERROR CLASS -22	Unsigned Int 16	not used
723	R	LMV ERROR ERROR PHASE -22	Unsigned Int 16	see LMV Phases
724	R	LMV ERROR FUEL -22	Unsigned Int 16	0=gas/fuel0,1=oil/fuel
725	R	LMV ERROR OUTPUT -22	Unsigned Int 16	x10, see Mapping Notes – Note 1
726	R	LMV ERROR STARTUPS -22	Unsigned Int 32	
728	R	LMV ERROR ERROR CODE -23	Unsigned Int 16	see LMV3 Error Codes
729	R	LMV ERROR DIAG CODE -23	Unsigned Int 16	see LMV3 Error Codes
730	R	LMV ERROR ERROR CLASS -23	Unsigned Int 16	not used
731	R	LMV ERROR ERROR PHASE -23	Unsigned Int 16	see LMV Phases

Modbus LMV3... Mapping

ADDRESS	ACCESS	DESCRIPTION	FORMAT	NOTES
732	R	LMV ERROR FUEL -23	Unsigned Int 16	0=gas/fuel0,1=oil/fuel
733	R	LMV ERROR OUTPUT -23	Unsigned Int 16	x10, see Mapping Notes – Note 1
734	R	LMV ERROR STARTUPS -23	Unsigned Int 32	
736	R	LMV ERROR ERROR CODE -24	Unsigned Int 16	see LMV3 Error Codes
737	R	LMV ERROR DIAG CODE -24	Unsigned Int 16	see LMV3 Error Codes
738	R	LMV ERROR ERROR CLASS -24	Unsigned Int 16	not used
739	R	LMV ERROR ERROR PHASE -24	Unsigned Int 16	see LMV Phases
740	R	LMV ERROR FUEL -24	Unsigned Int 16	0=gas/fuel0,1=oil/fuel
741	R	LMV ERROR OUTPUT -24	Unsigned Int 16	x10, see Mapping Notes – Note 1
742	R	LMV ERROR STARTUPS -24	Unsigned Int 32	

Modbus – Mapping (continued)

LME7...

Modbus LME7... Mapping

ADDRESS	ACCESS	DESCRIPTION	FORMAT	NOTES
0	R	PHASE	Unsigned Int 16	see LME7 Phases
1	R	FLAME PERCENT LME71/LME73	Unsigned Int 16	x10
2	R	MAINS VOLTAGE	Unsigned Int 16	x10
3	R	STARTUPS RESETTABLE	Unsigned Int 32	
5	R	STARTUPS TOTAL	Unsigned Int 32	
7	R	RELAY K12 CYCLES	Unsigned Int 32	
9	R	RELAY K11 CYCLES	Unsigned Int 32	
11	R	RELAY K2 CYCLES	Unsigned Int 32	
13	R	RELAY K1 CYCLES	Unsigned Int 32	
15	R	MAX RELAY CYCLES	Unsigned Int 32	
17	R	CURRENT OUTPUT PERCENT	Unsigned Int 16	> 100 is stages (101=S1, 102=S2)
18	R	ACTUATOR ACTUAL PERCENT	Unsigned Int 16	65535 (-1) = not optioned
19	R	ACTUATOR TARGET PERCENT	Unsigned Int 16	65535 (-1) = not optioned
20	R	EXT LOAD CONTROLLER PERCENT	Unsigned Int 16	65535 (-1) = not optioned
21	R	FAN SPEED RPM	Unsigned Int 16	65535 (-1) = not optioned
22	R	FAN SPEED PERCENT	Unsigned Int 16	65535 (-1) = not optioned
23	R	TARGET FAN SPEED PERCENT	Unsigned Int 16	65535 (-1) = not optioned
24	R	PWM SIGNAL PERCENT	Unsigned Int 16	65535 (-1) = not optioned
25	R	STATUS INPUT WORD LME71/LME73	Unsigned Int 16	word of bits
25 bit 0	R	SAFETY LIMIT	Boolean	terminal X3.04.1
25 bit 1	R	PROOF OF CLOSURE	Boolean	terminal X2.02.4
25 bit 4	R	PRESS SW VALVE PROVING	Boolean	terminal X9.04.2
25 bit 5	R	LOW GAS PRESSURE SWITCH	Boolean	terminal X5.01.2
25 bit 6	R	CONTROL SWITCH	Boolean	terminal X5.03.1
25 bit 7	R	COMBUSTION AIR SWITCH	Boolean	terminal X3.02.1
25 bit 8	R	RESET REMOTE TERMINAL	Boolean	terminal X2.03.1
25 bit 10	R	INCREASE MODULATION	Boolean	terminal X5.03.3
25 bit 11	R	DECREASE MODULATION	Boolean	terminal X5.03.2
25 bit 14	R	RESET BUTTON LME	Boolean	
26	R	STATUS OUTPUT WORD	Unsigned Int 16	word of bits
26 bit 0	R	FLAME PRESENT LME71/LME73 FLAME 1 PRESENT LME75	Boolean	
26 bit 1	R	ALARM	Boolean	terminal X2.03.3
26 bit 2	R	NO COMM TO LME	Boolean	status from OCI417
26 bit 3	R	FLAME 2 PRESENT LME75	Boolean	
26 bit 6	R	ACTUATOR FEEDBACK	Boolean	terminal X2.09.4
26 bit 7	R	SAFETY VALVE	Boolean	terminal X6.03.3
26 bit 8	R	ACTUATOR LOW FIRE	Boolean	terminal X2.09.2
26 bit 9	R	ACTUATOR HIGH FIRE	Boolean	terminal X2.09.3
26 bit 10	R	PILOT VALVE	Boolean	terminal X7.01.3
26 bit 12	R	IGNITION	Boolean	terminal X4.02.3
26 bit 13	R	FAN	Boolean	terminal X2.01.3
26 bit 14	R	VALVE 1	Boolean	terminal X7.04.4
26 bit 15	R	VALVE 2	Boolean	terminal X7.02.3
27	R	STATUS INPUT WORD LME75	Unsigned Int 16	word of bits

Modbus LME7... Mapping

ADDRESS	ACCESS	DESCRIPTION	FORMAT	NOTES
27 bit 0	R	PRESS SW VALVE PROVING (P LT)	Boolean	TERMINAL X9.04.2
27 bit 1	R	VALVE PROVING ENABLE (LT) HIGH GAS PRESSURE SWITCH (Pmax) PROOF OF CLOSURE (POC)	Boolean	TERMINAL X2.02.4
27 bit 2	R	INCREASE MODULATION (LR-OPEN)	Boolean	TERMINAL X5.03.3
27 bit 3	R	DECREASE MODULATION (LR-CLOSED)	Boolean	TERMINAL X5.03.2
27 bit 4	R	COMBUSTION AIR SWITCH (LP)	Boolean	TERMINAL X3.02.1
27 bit 5	R	LOW GAS PRESSURE SWITCH (Pmin)	Boolean	TERMINAL X5.01.2
27 bit 6	R	RESET BUTTON LME	Boolean	
27 bit 7	R	RESET TERMINAL (EK2)	Boolean	TERMINAL X2.03.1
27 bit 8	R	ACTUATOR FEEDBACK (SA-R)	Boolean	TERMINAL X2.09.4
27 bit 9	R	SAFETY LIMIT (SK)	Boolean	TERMINAL X3.04.1
27 bit 10	R	CONTROL SWITCH (ON/OFF)	Boolean	TERMINAL X5.03.1
27 bit 11	R	INPUT CAMS (SA-ZL)	Boolean	TERMINAL X2.09.8
28	R	FLAME 1 PERCENT LME75	Unsigned Int 16	x10
29	R	FLAME 2 PERCENT LME75	Unsigned Int 16	x10
50	R	PRODUCT ID	String (10 words)	
60	R	BURNER ID	String (10 words)	
70	R	OEM PRODUCT ID	String (10 words)	
80	R	PME PRODUCT ID	String (10 words)	
90	RW	OCI PRODUCT ID	String (10 words)	writable data area
100	R	CURRENT ERROR CODE	Unsigned Int 16	see LME7 Error Codes
101	R	CURRENT ERROR STARTUPS	Unsigned Int 32	
103	R	CURRENT ERROR PHASE	Unsigned Int 16	see LME7 Phases
104	R	CURRENT ERROR LOAD	Unsigned Int 16	
110	R	HISTORY 1 ERROR CODE	Unsigned Int 16	see LME7 Error Codes
111	R	HISTORY 1 ERROR STARTUPS	Unsigned Int 32	
113	R	HISTORY 1 ERROR PHASE	Unsigned Int 16	see LME7 Phases
114	R	HISTORY 1 ERROR LOAD	Unsigned Int 16	
120	R	HISTORY 2 ERROR CODE	Unsigned Int 16	see LME7 Error Codes
121	R	HISTORY 2 ERROR STARTUPS	Unsigned Int 32	
123	R	HISTORY 2 ERROR PHASE	Unsigned Int 16	see LME7 Phases
124	R	HISTORY 2 ERROR LOAD	Unsigned Int 16	
130	R	HISTORY 3 ERROR CODE	Unsigned Int 16	see LME7 Error Codes
131	R	HISTORY 3 ERROR STARTUPS	Unsigned Int 32	
133	R	HISTORY 3 ERROR PHASE	Unsigned Int 16	see LME7 Phases
134	R	HISTORY 3 ERROR LOAD	Unsigned Int 16	
140	R	HISTORY 4 ERROR CODE	Unsigned Int 16	see LME7 Error Codes
141	R	HISTORY 4 ERROR STARTUPS	Unsigned Int 32	
143	R	HISTORY 4 ERROR PHASE	Unsigned Int 16	see LME7 Phases
144	R	HISTORY 4 ERROR LOAD	Unsigned Int 16	
150	R	HISTORY 5 ERROR CODE	Unsigned Int 16	see LME7 Error Codes
151	R	HISTORY 5 ERROR STARTUPS	Unsigned Int 32	
153	R	HISTORY 5 ERROR PHASE	Unsigned Int 16	see LME7 Phases
154	R	HISTORY 5 ERROR LOAD	Unsigned Int 16	
160	R	HISTORY 6 ERROR CODE	Unsigned Int 16	see LME7 Error Codes
161	R	HISTORY 6 ERROR STARTUPS	Unsigned Int 32	
163	R	HISTORY 6 ERROR PHASE	Unsigned Int 16	see LME7 Phases
164	R	HISTORY 6 ERROR LOAD	Unsigned Int 16	

Modbus LME7... Mapping

ADDRESS	ACCESS	DESCRIPTION	FORMAT	NOTES
170	R	HISTORY 7 ERROR CODE	Unsigned Int 16	see LME7 Error Codes
171	R	HISTORY 7 ERROR STARTUPS	Unsigned Int 32	
173	R	HISTORY 7 ERROR PHASE	Unsigned Int 16	see LME7 Phases
174	R	HISTORY 7 ERROR LOAD	Unsigned Int 16	
180	R	HISTORY 8 ERROR CODE	Unsigned Int 16	see LME7 Error Codes
181	R	HISTORY 8 ERROR STARTUPS	Unsigned Int 32	
183	R	HISTORY 8 ERROR PHASE	Unsigned Int 16	see LME7 Phases
184	R	HISTORY 8 ERROR LOAD	Unsigned Int 16	
190	R	HISTORY 9 ERROR CODE	Unsigned Int 16	see LME7 Error Codes
191	R	HISTORY 9 ERROR STARTUPS	Unsigned Int 32	
193	R	HISTORY 9 ERROR PHASE	Unsigned Int 16	see LME7 Phases
194	R	HISTORY 9 ERROR LOAD	Unsigned Int 16	
200	R	HISTORY 10 ERROR CODE	Unsigned Int 16	see LME7 Error Codes
201	R	HISTORY 10 ERROR STARTUPS	Unsigned Int 32	
203	R	HISTORY 10 ERROR PHASE	Unsigned Int 16	see LME7 Phases
204	R	HISTORY 10 ERROR LOAD	Unsigned Int 16	

Modbus – Mapping (continued)

RWF10

Modbus RWF10 Mapping

ADDRESS	ACCESS	DESCRIPTION	FORMAT	NOTES
8192	R	PROCESS VARIABLE	Unsigned Int 16	
8193	R	STATUS WORD	Unsigned Int 16	
8192 bit 12	R	OUTPUT ALARM 1 BURNER	Boolean	
8192 bit 13	R	OUTPUT ALARM 2 LF HOLD	Boolean	
8196	R	ANALOG OUTPUT	Unsigned Int 16	x10
8451	RW	CURRENT SETPOINT	Unsigned Int 16	x10 or x100 if decimal places used
8452	RW	SETPOINT ALARM 1	Unsigned Int 16	
8455	RW	SETPOINT ALARM 2	Unsigned Int 16	
10752	RW	PROPORTIONAL BAND	Unsigned Int 16	x10
10753	RW	INTEGRAL TIME	Unsigned Int 16	
10754	RW	DERIVATIVE TIME	Unsigned Int 16	
12034	RW	HYSTERESIS ALARM 1	Unsigned Int 16	
12037	RW	HYSTERESIS ALARM 2	Unsigned Int 16	

Modbus – Mapping (continued)

RWF55

Modbus RWF55 Mapping

ADDRESS	ACCESS	DESCRIPTION	FORMAT	NOTES
0	R	INPUT 1 X1	Float	
2	R	INPUT 2 X2	Float	
4	R	INPUT 3 X3	Float	
6	R	CURRENT SETPOINT WR	Float	
8	RW	FIRST SETPOINT SP1	Float	
10	RW	SECOND SETPOINT SP2	Float	
512	R	OUTPUTS AND STATES	Unsigned Int 16	
512 bit 12	R	INPUT 1 FAULT	Boolean	
512 bit 13	R	INPUT 2 FAULT	Boolean	
512 bit 14	R	INPUT 3 FAULT	Boolean	
513	R	INPUTS AND SIGNALS	Unsigned Int 16	
513 bit 0	R	STAGE MODE	Boolean	
513 bit 1	R	MANUAL OPERATION	Boolean	
513 bit 2	R	BINARY INPUT 1	Boolean	
513 bit 3	R	BINARY INPUT 2	Boolean	
513 bit 4	R	STAT ACTIVE	Boolean	
513 bit 5	R	UP ACTIVE	Boolean	
513 bit 6	R	DOWN ACTIVE	Boolean	
513 bit 7	R	K6 ACTIVE	Boolean	
1280	RW	REMOTE OPERATING MODE REM	Unsigned Int 16	
1281	RW	REMOTE MODE OFF ROFF	Unsigned Int 16	
1282	RW	REMOTE ON HYSTERESIS RHYS1	Float	
1284	RW	REMOTE OFF HYST BOT RHYS2	Float	
1286	RW	REMOTE OFF HYST TOP RHYS3	Float	
1288	RW	REMOTE SETPOINT SPR	Float	
1290	RW	REMOTE BURNER OUTPUT RK1	Unsigned Int 16	
1291	RW	REMOTE K2 OUTPUT RK2	Unsigned Int 16	
1292	RW	REMOTE K3 OUTPUT RK3	Unsigned Int 16	
1293	RW	REMOTE K6 OUTPUT RK6	Unsigned Int 16	
1294	RW	REMOTE STAGE MODE RSTEP	Unsigned Int 16	
1295	RW	REMOTE OUTPUT RY	Float	
1297	RW	REM ON HYST COOLING RHYS4	Float	
1299	RW	REM OFF HYST BTM COOL RHYS5	Float	
1301	RW	REM OFF HYST TOP COOL RHYS6	Float	
4149	R	INPUT 3 UNFILTERED TEMP	Float	
4163	R	ACTUAL OUTPUT Y	Float	
4184	R	BURNER ALARM	Unsigned Int 16	
4195	RW	RAMP FUNCTION FnCt	Float	
4197	RW	RAMP SLOPE rASL	Float	
4199	RW	TOLERANCE BAND RAMP toLP	Float	
4201	RW	LIMIT VALUE rAL	Float	
4205	RW	ALARM RELAY FUNCTION FnAL	Float	
4207	RW	ALARM LIMIT COMPARATOR AL	Float	
4209	RW	HYSTERESIS LIMIT COMP HYST	Float	
4213	RW	MODBUS WATCHDOG dtt	Float	

Modbus RWF55 Mapping

ADDRESS	ACCESS	DESCRIPTION	FORMAT	NOTES
4215	RW	FILTER INPUT 1 dF1	Float	
4217	RW	FILTER INPUT 2 dF2	Float	
4219	RW	FILTER INPUT 3 dF3	Float	
4221	R	ACTUAL VALUE LIMIT LOW oLLo	Float	
4223	R	ACTUAL VALUE LIMIT HIGH oLHi	Float	
12288	RW	PROPORTIONAL BAND Pb1	Float	
12292	RW	DERIVATIVE ACTION TIME dt	Float	
12294	RW	INTEGRAL ACTION TIME rt	Float	
12300	RW	DEAD BAND db	Float	
12306	RW	ACTUATOR RUNNING TIME tt	Float	
12310	RW	ON HYSTERESIS HYS1	Float	
12312	RW	OFF HYSTERESIS BOTTOM HYS2	Float	
12314	RW	OFF HYSTERESIS TOP HYS3	Float	
12316	RW	ON HYST COOLING HYS4	Float	
12318	RW	OFF HYST BTM COOLING HYS5	Float	
12320	RW	OFF HYST TOP COOLING HYS6	Float	
12322	RW	REACTION THRESHOLD q	Float	
12416	RW	OUTSIDE TEMPERATURE 1 At1	Float	
12418	RW	BOILER TEMPERATURE 1 Ht1	Float	
12420	RW	OUTSIDE TEMPERATURE 2 At2	Float	
12422	RW	BOILER TEMPERATURE 2 Ht2	Float	
13350	RW	INPUT 1 SCALE LOW SCL1	Float	
13352	RW	INPUT 1 SCALE HIGH SCH1	Float	
13354	RW	OFFSET INPUT 1 OFF1	Float	
13362	RW	INPUT 2 SCALE LOW SCL2	Float	
13364	RW	INPUT 2 SCALE HIGH SCH2	Float	
13366	RW	OFFSET INPUT 2 OFF2	Float	
13370	RW	OFFSET INPUT 3 OFF3	Float	
13446	RW	SETPOINT LIMIT SCALE LOW SPL	Float	
13448	RW	SETPOINT LIMIT SCALE HIGH SPH	Float	
32768	R	SOFTWARE VERSION	String (6 words)	
32774	R	VdN NUMBER	String (8 words)	

Modbus – Mapping (continued)

TS Series

See the corresponding documentation for each device to find the native Modbus mapping:

- **TS Series Touchscreen Kit (standalone):** Document No. TS-1100
- **TS Series Lead/Lag Master:** Document No. TS-2100
- **TS Series Deaerator/Surge Tank:** Document No. TS-3100
- **TS Series Hardwired Draft Control:** Document No. TS-4100

Mapping Notes

TS Series Lead/Lag Master Remote Control Strategies

A remote setpoint can be sent to **LLM REMOTE SETPOINT**. The value sent will be displayed on the SETPOINTS screen. In order for this setpoint to be used, the System Local-Off-Remote switch must be in 'Remote' and at least one boiler must be available. The value of **LLM REMOTE ENABLE** must be **1** or **enable**. This is the value that will toggle the enabled state. The enabled state is also shown on the SETPOINTS screen as '**REMOTE ENABLED**' or '**REMOTE DISABLED**'. The value of **LLM REMOTE VALID** must be actively written to **1** or **enable** (at least once every 30 seconds). This is a heartbeat to indicate that the BMS is still connected. If **LLM REMOTE VALID** is not written in the appropriate time the system will revert to being enabled as if it were in 'Local' mode. The status of **LLM REMOTE VALID** is shown on the SETPOINTS screen as '**REM OK**' or '**INVALID**'.

Notations

Note 1 – This value is a percent x10. If the value exceeds 1000, it indicates stages.

- **1001**: 1 stage
- **1002**: 2 stages
- **1003**: 3 stages

Note 2 – LMV5 sensor selection.

- **0**: Pt100
- **1**: Pt1000
- **2**: Ni1000
- **3**: temperature sensor
- **4**: pressure sensor
- **5**: Pt100/Pt1000
- **6**: Pt100/Ni1000
- **7**: no sensor

Note 3 – LMV program stop.

- **0**: deactivated (LMV5, LMV3)
- **1**: prepurge phase 24 (LMV5, LMV3)
- **2**: prepurge FGR phase 32 (LMV5), ignition position phase 36 (LMV3)
- **3**: ignition position phase 36 (LMV5), interval 1 phase 44 (LMV3)
- **4**: interval 1 phase 44 (LMV5), interval 2 phase 52 (LMV3)
- **5**: interval 2 phase 52 (LMV5)
- **6**: postpurge phase 72 (LMV5)
- **7**: postpurge FGR phase 76 (LMV5)

Mapping Notes (continued)

Note 4 – LMV5 operating mode.

- **0:** external load control X5-03
- **1:** internal load control
- **2:** internal load control bus
- **3:** internal load control X62
- **4:** external load control X62
- **5:** external load control bus

Note 5 – LMV5 adaption state.

- **0:** undefined
- **1:** identification completed, parameter determined
- **2:** undefined
- **3:** adaption aborted by user
- **4:** temperature difference too small, temperature will be lowered with low fire
- **5:** monitoring time running
- **6:** delivery of identification load set
- **7:** error during identification (path)
- **8:** error during identification (internal)
- **9:** monitoring time running
- **10:** changeover from modulating to multistage during an identification
- **11:** timeout monitoring time
- **12:** timeout heating output on path with monitoring

Note 6 – Lockout code string lookup. Write the lockout code to convert to register 159 as a decimal number and the string representation will be returned to register 160. For example, writing '33' to register 159 will result in register 160 returning 'SAFETY LOOP OPEN'. Writing '0' to register 159 will result in the current lockout string being returned.

Mapping Notes (continued)

Note 7 – LMV3 fuel train.

Mode	Fuel Train	Fuel-Air Ratio Control	Ignition	Fuel Act.	Air Act.	Monitored VSD
1	G mod	modulating electronic	direct spark	x	x	x
2	Gp1 mod	modulating electronic	pilot between V1/V2	x	x	x
3	Gp2 mod	modulating electronic	pilot before V1/V2	x	x	x
4	Lo mod	modulating electronic	direct spark	x	x	x
5	Lo 2-stage	2-stage electronic	direct spark		x	x
6	Lo 3-stage	3-stage electronic	direct spark		x	x
7	G mod pneu	modulating pneumatic	direct spark		x	
8	Gp1 mod pneu	modulating pneumatic	pilot between V1/V2		x	
9	Gp2 mod pneu	modulating pneumatic	pilot before V1/V2		x	
10	LoGp mod	modulating electronic	gas pilot	x	x	x
11	LoGp 2-stage	2-stage electronic	gas pilot		x	x
12	Lo mod (2 valves)	modulating electronic	direct spark	x	x	x
13	LoGp mod (2 valves)	modulating electronic	gas pilot	x	x	x
14	G mod pneu	modulating pneumatic	direct spark			
15	Gp1 mod pneu	modulating pneumatic	pilot between V1/V2			
16	Gp2 mod pneu	modulating pneumatic	pilot before V1/V2			
17	Lo 2-stage	2-stage electronic	direct spark			x
18	Lo 3-stage	3-stage electronic	direct spark			x
19	G mod pneu	modulating pneumatic	direct spark	x		x
20	Gp1 mod pneu	modulating pneumatic	pilot between V1/V2	x		x
21	Gp2 mod pneu	modulating pneumatic	pilot before V1/V2	x		x
22	Lo mod	modulating electronic	direct spark	x		x
23	Ho mod circ	mod. electronic, pump control	direct spark	x	x	x
24	Ho 2-stage circ	2-st. electronic, pump control	direct spark		x	x
25	Ho mod	modulating electronic	direct spark	x	x	x
26	Ho 2-stage	2-stage electronic	direct spark		x	x
27	Ho 3-stage	3-stage electronic	direct spark		x	x
28	G mod mech	modulating mechanical	direct spark		x	x
29	Gp2 mod mech	modulating mechanical	pilot before V1/V2		x	x
255	not defined	---	---			

Mapping Notes (continued)

Note 8 – TS Series Hardwired Draft Control operating phases.

- **0:** Flame Safeguard Lockout
- **1:** No call for heat, timing to close damper
- **2:** No call for heat, drive damper closed
- **3:** Drive damper open to prepurge, start timing to close permissive relay
- **4:** Waiting for signal from high fire purge switch
- **5:** Waiting for high fire purge switch to change state
- **6:** Start timing to send ignition command to damper
- **7:** Drive damper to ignition
- **8:** Timing to release to modulation
- **9:** Released to modulation
- **10:** Start timing to open damper for postpurge
- **11:** Drive damper open to postpurge

Note 9 – TS Series Hardwired Draft Control sensor type.

- **0:** 0-10V
- **1:** 0-20mA
- **2:** 2-10V
- **3:** 4-20mA

LMV Phases

NUMBER	DESCRIPTION
0	LOCKOUT PHASE
1	SAFETY PHASE
2	SAFETY PHASE
10	HOME RUN POSITION
12	STANDBY STATIONARY
20	SAFETY RELAY ON
21	RELEASE OF STARTUP
22	FAN MOTOR ON
24	DRIVE TO PURGE
30	PREPURGE
32	PREPURGE FGR
34	PREPURGE
35	VSD DRIVE TO IGNITION
36	DRIVE TO IGNITION
38	PREIGNITION SPARK ON
39	GAS VALVE TEST MINIMUM PRESSURE
40	PILOT VALVE OPEN
42	SPARK OFF
44	FLAME STABILIZATION
50	FUEL VALVE OPEN SAFETY TIME
52	FLAME STABILIZATION
54	DRIVE TO LOW FIRE
60	NORMAL OPERATION
62	DRIVE TO LOW FIRE POST
64	DRIVE TO IGNITION
65	FLAME STABILIZATION
66	IGNITION/PILOT ON
67	MAIN VALVE OFF
68	PILOT WAITING TIME
69	PILOT WAITING - STARTUP
70	FUEL VALVE CLOSED AFTER BURN TIME
72	DRIVE TO POSTPURGE
74	MANDATORY POSTPURGE
76	MANDATORY POSTPURGE
78	OPTIONAL POSTPURGE
79	DIRECT START (APS CHECK)
80	GV TEST EVACUATION OF TEST SPACE
81	GV TEST ATMOSPHERIC PRESSURE TEST
82	GV TEST FILL TEST SPACE
83	GV TEST PRESSURE TEST
90	GAS SHORTAGE WAITING TIME
97	NO CONFIGURATION
98	WAITING TO ESTABLISH COMMUNICATION
99	COMMUNICATION FAULT

LMV5 Lockout/Error Codes

LMV5 Lockout/Error Codes

CODE DECIMAL	CODE HEX	DESCRIPTION
0	0	NO ERROR
1	1	ROM ERROR
2	2	RAM ERROR
3	3	INTERNAL COMMUNICATION ERROR
4	4	UNSUCCESSFUL SYNC OF 2uCs
5	5	FAULT DURING FLAME AMP TEST
6	6	FAULT INTERNAL HARDWARE TEST
16	10	DIGITAL OUTPUT FAULT
17	11	SHORT CIRCUIT CONTACT FEEDBACK
21	15	ACTUATOR FAULT/VSD SPEED NOT REACHED
22	16	FAULT IN RATIO CONTROL SYSTEM
23	17	LMV5 INTERNAL COM ERROR
24	18	CORRUPTION IN COMBUSTION CURVE DATA
25	19	ACTUATOR POT ERROR
26	1A	ACTUATOR CURVE TOO STEEP
27	1B	ACT CURVE PROGRAMMING ACTIVE PHASE 62
28	1C	ACTUATOR IGNITION POSITION NOT SET
29	1D	RUNNING TIME FAULT ACTUATORS/VSD
30	1E	ACTUATOR/VSD NOT REACHED POSITION
31	1F	VSD MODULE CONNECTION ERROR
33	21	SAFETY LOOP OPEN
34	22	TEMP LIMITER OFF (CHECK SENSOR)
35	23	EXTRANEIOUS LIGHT DURING STARTUP
36	24	EXTRANEIOUS LIGHT DURING SHUTDOWN
37	25	NO FLAME AT END OF SAFETY TIME
38	26	LOSS OF FLAME PHASE 60-62
39	27	AIR PROVE SW ON SHOULD BE OFF
40	28	AIR PROVE SW OFF SHOULD BE ON
41	29	FAN CONTACT SIGNAL ON SHOULD BE OFF
42	2A	FAN CONTACT SIGNAL OFF SHOULD BE ON
43	2B	FGR PRESSURE SW ON SHOULD BE OFF
44	2C	FGR PRESSURE SW OFF SHOULD BE ON
45	2D	CPI (POC) ON SHOULD BE OFF
46	2E	CPI (POC) OFF SHOULD BE ON
47	2F	LOW GAS PRESSURE SWITCH OPEN
48	30	HIGH GAS PRESSURE SWITCH OPEN
49	31	VALVE PROVE – GAS SIDE LEAK
50	32	VALVE PROVE – BURNER SIDE LEAK
51	33	OIL PRESSURE WHEN OIL PUMP OFF
52	34	LOW OIL PRESSURE WHEN PUMP RUNNING
53	35	HIGH OIL PRESSURE SWITCH OPEN
54	36	NO START RELEASE FOR OIL
55	37	NO HEAVY OIL DIRECT START
56	38	SHORTAGE OF GAS PROGRAM IN PROGRESS
57	39	PARAMETER OF MAX SAFETY TIME FAULTY
58	3A	NO BURNER ID DEFINED
59	3B	NO SERVICE PASSWORD DEFINED
64	40	WRONG CONTACT POSITION OF SAFETY TIME

LMV5 Lockout/Error Codes

CODE DECIMAL	CODE HEX	DESCRIPTION
65	41	WRONG CONTACT POSITION OF IGNITION
66	42	WRONG CONTACT POSITION OF FUEL RELAY
67	43	PLAUSIBILITY CHECK FAULT
68	44	FAULT AT DEACTIVATED INPUTS
69	45	SHUTDOWN VIA SAFETY LIMIT TEST
70	46	PROGRAM STOP ACTIVATED
71	47	START RELEASE GAS IS OFF
72	48	TWO FLAME SIGNALS WITH ONE PARMETERIZED
80	50	FAULT DURING KEY VALUE CHECK
81	51	TIME BLOCK OVERFLOW
82	52	STACK ERROR
83	53	FAULTY RESET STATE OCCURRED
87	57	INVALID PARAMETERIZATION
88	58	INTERNAL COMMUNICATION (uC1<>uC2)
89	59	EEPROM PAGE IS ON ABORT
90	5A	CRC ERROR OF PARAMETER RANGE
91	5B	PAGE ON ABORT
92	5C	PAGE ON WR_RESTO (BACKUP RESTORE MADE)
93	5D	PAGE OPEN TOO LONG
94	5E	PAGE HAS UNDEFINED STATUS
95	5F	LAST BACKUP RESTORE INVALID (INTERRUPTED)
96	60	FAULT COPYING A PARAMETER PAGE
97	61	FAULT WITH EEPROM INITIALIZATION
112	70	FAULT DURING RESTORING LOCKOUT INFO
113	71	MANUAL LOCKOUT VIA CONTACT
114	72	PLAUSIBILITY FAULT WITH FAULT ENTRY
128	80	WRONG STATE OF AUX3 ACTUATOR
129	81	WRONG STATE OF AIR ACTUATOR
130	82	WRONG STATE OF GAS ACTUATOR
131	83	WRONG STATE OF OIL ACTUATOR
132	84	WRONG STATE OF AUX1 ACTUATOR
133	85	WRONG STATE OF AUX2 ACTUATOR
134	86	WRONG STATE OF INTERNAL LOAD CONTROLLER
135	87	WRONG STATE OF AZL
136	88	PLAUSIBILITY FAULT (NMT)
144	90	ROM-CRC ERROR ON AUX3 FEEDBACK
145	91	ROM-CRC ERROR ON AIR FEEDBACK
146	92	ROM-CRC ERROR ON GAS FEEDBACK
147	93	ROM-CRC ERROR ON OIL FEEDBACK
148	94	ROM-CRC ERROR ON AUX1 FEEDBACK
149	95	ROM-CRC ERROR ON AUX2 FEEDBACK
150	96	ROM-CRC ERROR ON LC FEEDBACK
151	97	ROM-CRC ERROR ON AZL FEEDBACK
152	98	CANBUS DEVICE WITH SAME ADDRESS CONFLICT
153	99	CANBUS IS OFF
154	9A	CANBUS WARNING LEVEL
155	9B	CANBUS QUEUE OVERRUN
160	A0	AUX3 ACTUATOR DETECTED A FAULT
161	A1	AIR ACTUATOR DETECTED A FAULT

LMV5 Lockout/Error Codes

CODE DECIMAL	CODE HEX	DESCRIPTION
162	A2	GAS ACTUATOR DETECTED A FAULT
163	A3	OIL ACTUATOR DETECTED A FAULT
164	A4	AUX1 ACTUATOR DETECTED A FAULT
165	A5	AUX2 ACTUATOR DETECTED A FAULT
166	A6	LOAD CONTROL DETECTED A FAULT
167	A7	AZL DETECTED A FAULT
169	A9	VSD MODULE DETECTED A FAULT
171	AB	O ₂ MODULE DETECTED A FAULT
176	B0	FAULT DURING TEST OF PORT OUTPUTS
177	B1	FAULT DURING SHORT CIRCUIT TEST
181	B5	O ₂ MONITOR FAULT
186	BA	O ₂ SENSOR TEST FAILED
187	BB	O ₂ TRIM CONTROL REMOVED
190	BE	INVALID PARAMETERIZATION O ₂ CONTROL
191	BF	O ₂ CONTROL AUTO DEACTIVATION
197	C5	AZL HAS DETECTED OLD UNIT VERSIONS
209	D1	WRONG STATE OF VSD MODULE
211	D3	WRONG STATE OF O ₂ MODULE
225	E1	ROM-CRC ERROR ON VSD MODULE FEEDBACK
227	E3	ROM-CRC ERROR ON O ₂ MODULE FEEDBACK
240	F0	PLAUSIBILITY FAULT (INTERPOLATION)
241	F1	FAULT CALCULATING PRECONTROL
242	F2	FAULTY TEMP VALUES FROM O ₂ MODULE
243	F3	O ₂ TRIM CONTROL FAULT
244	F4	O ₂ MODULE FAULT (FGR)
245	F5	CANBUS FEEDBACK FAULT X60 TEMP INPUT
246	F6	FGR FAULT

LMV3 Error Codes

LMV3 Error Codes

CODE	DESCRIPTION
2	NO FLAME AT END OF SAFETY TIME
3	AIR PRESSURE FAILURE
4	EXTRANEIOUS LIGHT
7	LOSS OF FLAME
12	VALVE PROVING
14	PROOF OF CLOSURE
18	AIR PRESSURE SWITCH SPEED DEPENDENT
19	COMBUSTION PRESSURE POC
20	PRESSURE SWITCH – MINIMUM
21	PRESSURE SWITCH – MAXIMUM
22	SAFETY LOOP / BURNER FLANGE
23	LOW GAS / HEAVY OIL DIRECT START
50	INTERNAL ERROR
51	INTERNAL ERROR
55	INTERNAL ERROR
56	INTERNAL ERROR
57	INTERNAL ERROR
58	INTERNAL ERROR
60	INTERNAL ERROR – NO VALID HEAT SOURCE
61	FUEL CHANGEOVER
62	INVALID FUEL SIGNALS OR INFORMATION
65	INTERNAL ERROR
66	INTERNAL ERROR
67	INTERNAL ERROR
70	INTERNAL ERROR – FUEL/AIR RATIO CONTROL
71	SPECIAL POSITION UNDEFINED
72	INTERNAL ERROR – FUEL/AIR RATIO CONTROL
73	INTERNAL ERROR – FUEL/AIR RATIO CONTROL
75	INTERNAL ERROR – FUEL/AIR RATIO CONTROL
76	INTERNAL ERROR – FUEL/AIR RATIO CONTROL
80	CONTROL RANGE LIMIT OF VSD
81	VSD ELECTROMAGNETIC INTERFERENCE
82	ERROR DURING VSD SPEED STANDARDIZATION
83	SPEED ERROR VSD
84	CURVE SLOPE ACTUATORS
85	ACTUATOR REFERENCING ERROR
86	ERROR FUEL ACTUATOR
87	ERROR AIR ACTUATOR
90	INTERNAL ERROR – BASIC UNIT
91	INTERNAL ERROR – BASIC UNIT
93	ERROR FLAME SIGNAL ACQUISITION
95	ERROR RELAY SUPERVISION
96	ERROR RELAY SUPERVISION
97	ERROR RELAY SUPERVISION
98	ERROR RELAY SUPERVISION
99	INTERNAL ERROR – RELAY CONTROL
100	INTERNAL ERROR – RELAY CONTROL
105	INTERNAL ERROR – CONTACT SAMPLING

LMV3 Error Codes

CODE	DESCRIPTION
106	INTERNAL ERROR – CONTACT REQUEST
107	INTERNAL ERROR – CONTACT REQUEST
108	INTERNAL ERROR – CONTACT REQUEST
110	INTERNAL ERROR – VOLTAGE MONITOR TEST
111	POWER FAILURE
112	MAINS VOLTAGE RECOVERY
113	INTERNAL ERROR – MAINS VOLTAGE
115	INTERNAL ERROR – SYSTEM COUNTER
116	DESIGN THRESHOLD EXCEEDED
117	LIFETIME EXCEEDED – OPERATION NOT ALLOWED
120	FUEL METERING INTERFERENCE
121	INTERNAL ERROR – EEPROM ACCESS
122	INTERNAL ERROR – EEPROM ACCESS
123	INTERNAL ERROR – EEPROM ACCESS
124	INTERNAL ERROR – EEPROM ACCESS
125	INTERNAL ERROR – EEPROM READ ACCESS
126	INTERNAL ERROR – EEPROM WRITE ACCESS
127	INTERNAL ERROR – EEPROM ACCESS
128	INTERNAL ERROR – EEPROM ACCESS
129	INTERNAL ERROR – EEPROM ACCESS
130	INTERNAL ERROR – EEPROM ACCESS
131	INTERNAL ERROR – EEPROM ACCESS
132	INTERNAL ERROR – EEPROM REG INITIALIZATION
133	INTERNAL ERROR – EEPROM REQUEST SYNC
134	INTERNAL ERROR – EEPROM REQUEST SYNC
135	INTERNAL ERROR – EEPROM REQUEST SYNC
136	RESTORE STARTED
137	INTERNAL ERROR – BACKUP/RESTORE
146	TIMEOUT – BAS MODBUS
150	TUV TEST
154	TRIM FUNCTION – INVALID ANALOG
155	TRIM FUNCTION – INVALID CURVE
156	TRIM FUNCTION – TIMEOUT
157	TRIM FUNCTION – TEST FAIL
165	INTERNAL ERROR
166	INTERNAL ERROR – WATCHDOG TEST
167	MANUAL LOCKING
168	INTERNAL ERROR – MANAGEMENT
169	INTERNAL ERROR – MANAGEMENT
170	INTERNAL ERROR – MANAGEMENT
171	INTERNAL ERROR – MANAGEMENT
200	NO ERROR
201	PREVENTION OF STARTUP
202	INTERNAL ERROR – OPERATING MODE SELECT
203	INTERNAL ERROR
204	PROGRAM STOP
205	INTERNAL ERROR
206	COMBINATION OF UNITS NOT ALLOWED
207	AZL VERSION COMPATIBILITY ERROR

LMV3 Error Codes

CODE	DESCRIPTION
208	INTERNAL ERROR
209	INTERNAL ERROR
210	SELECTED MODE NOT RELEASED FOR BASIC UNIT
240	INTERNAL ERROR
242	INVALID PARAMETERIZATION
245	INTERNAL ERROR
250	INTERNAL ERROR

LME7 Phases

NUMBER	DESCRIPTION
0	LOCKOUT PHASE
1	UNDERVOLTAGE
2	OVERVOLTAGE
3	START PREVENTION SAFETY LOOP
4	START PREVENTION EXTRANEIOUS LIGHT
8	TEST
10	HOME RUN
12	STANDBY
21	START RELEASE
22	FAN ON
24	DRIVE TO PREPURGE
30	PREPURGE 1
32	PREPURGE 2
34	PREPURGE 3
36	DRIVE TO IGNITION
38	IGNITION ON
40	TSA1 VALVE ON
42	TSA1 IGNITION OFF
43	POSTIGNITION
44	INTERVAL 1
50	SAFETY TIME 2
52	INTERVAL 2
54	DRIVE TO LOW FIRE
60	NORMAL OPERATION
62	OPERATION AT LOW FIRE
70	AFTERBURN
72	DRIVE TO POSTPURGE
74	POSTPURGE 1
76	POSTPURGE 2
78	POSTPURGE 3
79	HOME RUN 2
80	VALVE PROVING EVACUATION
81	VALVE PROVING ATMOSPHERIC
82	VALVE PROVING FILLING
83	VALVE PROVING PRESSURE
90	GAS SHORTAGE
99	NO COMMUNICATION TO LME

LME7 Error Codes

CODE	DESCRIPTION
0	NO ERROR
2	NO FLAME AT END OF SAFETY TIME TSA1
3	AIR PRESSURE FAILURE OFF
4	EXTRANEIOUS LIGHT ON BURNER START
5	AIR PRESSURE FAILURE ON
6	ACTUATOR FAILURE
7	LOSS OF FLAME
8	ERROR TIME EXCEEDED OIL PREHEATER
9	LOSS OF FLAME TWO-STAGE
10	INTERNAL ERROR
12	VALVE PROVING – VALVE 1 LEAKING
13	VALVE PROVING – VALVE 2 LEAKING
14	CPI / POC ERROR
20	LOW GAS PRESSURE SWITCH
21	HIGH GAS PRESSURE SWITCH
22	SAFETY LIMIT OPEN
60	LOAD CONTROLLER INPUT INVALID
83	FAN SPEED ERROR
137	RESTORE OR BACKUP ABORTED
138	LOCKOUT AFTER PME RESTORE
139	UNKNOWN PME MODULE
140	PC TOOL RESTORE NOT COMPLETED
167	MANUAL LOCKOUT
225	PARAMETER PLAUSIBILITY ERROR PWM
226	PARAMETER PLAUSIBILITY ERROR
227	PARAMETER PLAUSIBILITY ERROR MIN / MAX

TS Series Configuration for Modbus

TS Series Hardwired Draft Control

The default IP address for the TS Series Hardwired Draft Control is 10.100.0.42 with a subnet mask of 255.255.255.0.

TS Series Deaerator/Surge Tank

The default IP address for the TS Series Deaerator/Surge Tank Master is 10.100.0.31 with a subnet mask of 255.255.255.0.

TS Series Touchscreen Kit

The default IP address for the TS Series Touchscreen Kit is 10.100.0.11 with a subnet mask of 255.255.255.0 and a boiler number of 1. If multiple TS Series Touchscreen Kits are connected to the network, each must be assigned a unique IP address and boiler designation.

Default IP Addresses by Designation

Boiler 1: 10.100.0.11

Boiler 2: 10.100.0.12

Boiler 3: 10.100.0.13

Boiler 4: 10.100.0.14

Boiler 5: 10.100.0.15

Boiler 6: 10.100.0.16

Boiler 7: 10.100.0.17

Boiler 8: 10.100.0.18

Subnet: 255.255.255.0

Default Gateway: 10.100.0.1

TS Series Lead/Lag Master

For ETHERNET port connections, the default IP address for the TS Series Lead/Lag Master is 192.168.1.10 with a subnet mask of 255.255.255.0 (connection to ETHERNET2 port on HMI). For HOST port connections, the default settings for the RS-485 connection is node address 1, 38400 baud, 8 data bits, 1 stop bit and no parity. If necessary, these parameters can be changed.

The ETHERNET1 port on the HMI can be used if direct connection to other devices such as a TS Series Touchscreen Kit or TS Series Deaerator/Surge Tank is required. The default IP address for this port is 10.100.0.10 with a subnet mask of 255.255.255.0. If this port is used the IP address of the protocol converter cannot be changed since this is the internal control network of the TS Series Lead/Lag Master. It is recommended to use ETHERNET2 since it is isolated from this network and has no restrictions on what the IP address can be set to.

LMV5 Configuration for Modbus

The LMV5... controller must be properly configured for Modbus operation. Use the **Select <** and **Select >** buttons to navigate up and down the screen and the **Enter** button when the desired option is selected with the cursor. Use **Esc** to go back to the previous menu. When a parameter needs to be changed, the **Select <** and **Select >** buttons allow the value to be changed and **Enter** confirms the change. Press the **Esc** button to return after the change is made.

First, activate the Modbus port on the AZL (no password required):

1. Operation > OptgModeSelect > Type of Gateway = **Modbus**
2. Operation > OptgModeSelect > **GatewayBASon** (older units **GatewayDDCon**)
3. The AZL should now read 'Gateway Mode active'.

Next, set up the required parameters through the AZL (no password required):

1. Params & Display > Access w-out PW > AZL > Modbus > Address = **<required node ID>**
2. Params & Display > Access w-out PW > AZL > Modbus > Baudrate = **19200 bit/s**
3. Params & Display > Access w-out PW > AZL > Modbus > Parity = **no**
4. Params & Display > Access w-out PW > AZL > Modbus > Timeout = **30s**

Last, change the controller mode to allow Modbus operation (no password required):

1. Params & Display > Access w-out PW > LoadController > Configuration > LC_OptgMode = **IntLC Bus**

The changes take effect immediately (no reboot required).

Log in to the AZL at the Service level (default password 9876) and change the following:

1. Params & Display > Access Serv > LoadController > Configuration > Ext MaxSetpoint = **100%**

If X62.1 and X62.2 are switched with a Local/Remote switch or similar as part of a remote enable package, disconnect the wires from these terminals. Failing to do so may result in the control not accepting a remote setpoint properly.

LMV3 Configuration for Modbus

The LMV3.. controller must have a compatible OCI option installed (OCI412.10 or OCI413.20) in order to communicate with the system via Modbus.

The service (heating engineer) password must be entered for these parameters to be accessed. The default service password is 9876. If the password has been changed, please consult the equipment OEM for the correct password.

To configure the LMV3... controller to communicate using Modbus, use the following procedure:

1. Hold down both the **F** and the **A** buttons until the display reads 'Code', followed by a string of seven underscores.
2. Use the **+** and **-** buttons to enter the password. Press **ENTER** (the button to the right of the display) after each entry, and again once the complete password is entered. If the password is incorrect, 'Error' will be displayed and the process will have to be restarted.
3. If the password is entered successfully, the screen will display 'Para' and then '400: Set' with the '400:' flashing.
4. Use the **-** button to navigate to '100: PArA', then press **ENTER**.
5. Use the **+** and **-** buttons to navigate to a flashing '141:'. If this value does not read **1**, press **ENTER** and then use the **+** and **-** buttons to change it to **1**, then press **ENTER** to confirm the change. This parameter activates Modbus. To return to the parameter navigation, press the **+** and **-** buttons simultaneously (**ESC**). The display should return to flashing '141:'. This procedure will be used to change all parameters.
6. Change '142:' to **120**. This parameter sets the timeout.
7. Change '145:' to **<required node ID>**. This parameter sets the Modbus address.
8. Change '146:' to **1**. This parameter sets the baud rate to 19200 bit/s.
9. Change '147:' to **0**. This parameter sets the parity to none.
10. When all the parameters are entered, press **ESC** in two successions to back up to the main screen. The changes take effect immediately (no reboot required).

LME7 Configuration for Modbus

The LME7.. controller must have an OCI417.10 connected in order to communicate with the system via Modbus.

Modbus/RTU protocol selection and addressing is done using the PC tool **OCI417 Configuration Utility** (download from <http://www.scccombustion.com>, sorted under Products → Flame Safeguards).

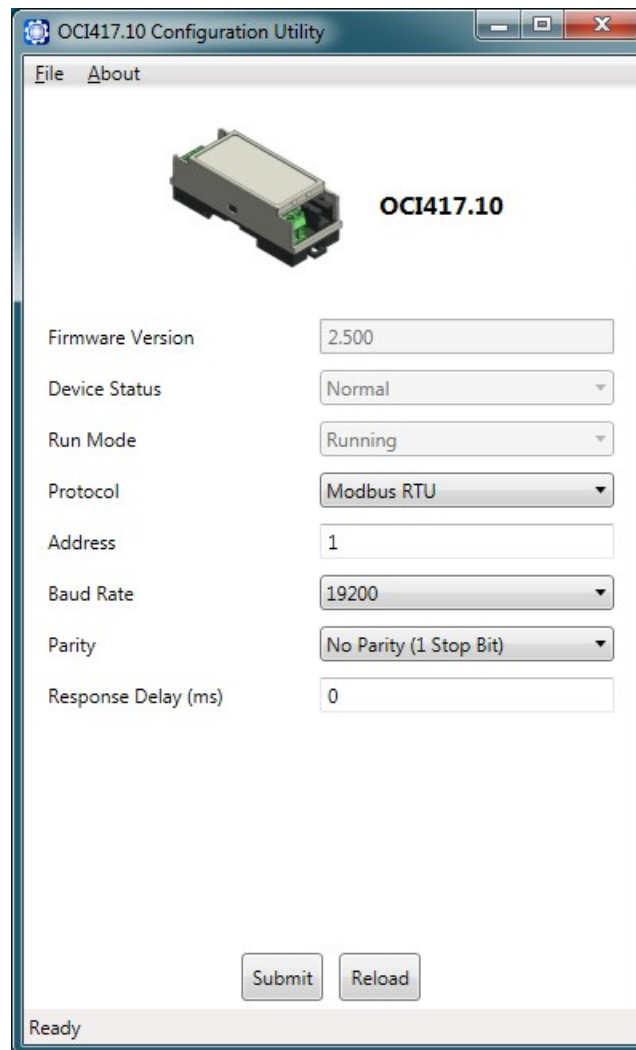

RWF10 Configuration for Modbus

The RWF10 must have the Modbus option in order to communicate with the system. This is an option card that is inserted into the controller when required.

To configure the RWF10 controller to communicate using Modbus, use the following procedure:

1. Press the **LEVEL** (left-most) button until the red display reads 'CN-t'.
2. Press the **LEVEL** button again; the red display should read 'PSEL'.
3. If the value of 'PSEL' does not read **Mod**, use the up and down arrow buttons to change the value.
4. Press the **MODE** (loop with arrow on end, second from left) button to move to the next parameter, 'U-No'. Change the value to **<required node ID>** with the up and down arrow buttons and then press **MODE**. This parameter sets the Modbus address.
5. Change parameter 'bPS' to **19.2** and then press **MODE**. This parameter sets the baud rate to 19,200 bit/s.
6. Change parameter 'PRtY' to **None** and then press **MODE**. This parameter sets the parity to none.
7. Change parameter 'SdWt' to **20** and then press **MODE**. This parameter sets the timeout.
8. Once 'PSEL' is displayed again, press and hold the **LEVEL** button to save the changes. The unit will reboot with the new parameters and the changes will take effect immediately.

RWF55 Configuration for Modbus

The RWF55 must be properly configured for Modbus operation.

Use the up and down arrow buttons to navigate through the menus and the **Enter** button when the desired menu is selected. Use **Esc** to go back to the previous menu. When a parameter needs to be changed, the up and down arrow buttons allow the value to be changed and **Enter** confirms the change. The parameter name will flash on the green display when the parameter entry mode is entered. Press the **Esc** button to return after the change is made.

To configure the RWF55 controller to communicate using Modbus, use the following procedure:

1. Press **Enter** to go into the menu list. The green display should read 'Opr'.
2. ConF > IntF > r485 > bdr = **2** (19200 bit/s baud rate)
3. ConF > IntF > r485 > dtt = **30** (timeout)
4. ConF > IntF > r485 > Adr = **<required node ID>**
5. Press **Esc** in four successions or until the parameter menus are completely exited. The changes take effect immediately (no reboot required).

Change Log

Revision 18D1

- New Modbus points for LMV3 software V3.70 and higher were added.
- LME7 via OCI417.10 protocol conversion available in all protocols.
- Ethernet/IP conversion available for all devices.
- Ethernet/IP utilities provided in zip file format downloadable from web interface.
- Lead/Lag Master boiler data updated to include all expanded annunciator points from boilers.
- Deaerator/Surge Tank Panel points all re-mapped.

Revision 18J1

- New data points from Lead/Lag Master in all protocols.
- RWF40 removed as device.
- New model TS-PW added. This model adds WiFi client and access point for ease in accessing the web-based configuration utility.
- Protocol selection changed from DIP switches to web-based configuration.
- Web-based configuration utility updated to restrict uploading csv files.
- Drop-down profile names changed to clear text.
- Added port addressing as parameters to replace port designation in profile names.
- Consolidated BACnet MS/TP to one device instance (removed virtual nodes). BACnet MS/TP object addressing now incorporates the node ID of the connected device.

Revision 19C1

- Common profile for all hardware platforms with "arm7v" processor.
- Boiler object configuration for Lead/Lag Master is now manual.

Revision 19F1

- Updates to LME7 profiles to include LME75 information.
- Updates to TS Series Touchscreen Kit and Lead/Lag Master profiles to reflect 19F1 changes.
- Added TS Series Hardwired Draft Control profiles.
- New IP addresses for all devices (10.100.0.x) to replace old scheme (192.168.1.x).

Information in this publication is based on current specifications. The company reserves the right to make changes in specifications and models as design improvements are introduced. Product or company names mentioned herein may be the trademarks of their respective owners. © 2019 SCC Inc.