



**DIGITAL CONTROLLER  
<MICRO CONTROLLER X>  
COMMUNICATION  
FUNCTION  
(RS-485 MODBUS)**

MODEL : PXG



---

# Introduction

Thank you for purchasing the Fuji Digital Temperature Controller.

This document describes how to connect the Micro controller PXG Series (referred to below as "Micro controller") to the personal computer or programmable controller. It also describes communication specifications for controlling and monitoring the communications with the micro controller, MODBUS protocol, and address map for the micro controller.

In addition to this document, please make sure to read the Instruction Manual (which comes with the product) and the Operations Manual (packaged separately).

## NOTE

### ■ Exclusions

The contents of this document may change without prior notice.

Although great care has been taken in the accuracy of this document, Fuji Electric takes no responsibility for loss or indirect damages caused by mistakes, missing information, or use of information in this document.

# Contents

## 1. Communication Functions

Overview.....	4
Connecting to a programmable controller .....	5
Connecting to a personal computer .....	5

## 2. Specifications

Communication Specifications .....	8
RS-485 .....	8
PC Loader Interface .....	8

## 3. Connection

Communication Terminal Configuration.....	10
Wiring .....	11

## 4. Setting Communication Parameters

List of Setting Parameters .....	16
Parameter Setting Procedure .....	17

## 5. MODBUS Communication Protocol

Overview.....	20
Message Composition .....	21
Station No. ....	21
Function Code.....	21
Data Part.....	21
Error Check Code .....	21
Slave Response .....	22
Function Code.....	23
Calculating Error Check Code (CRC-16).....	24
Transmission Control Steps.....	25
Master Communication Method .....	25
Explanation .....	25
Precautions when Writing Data .....	26

## 6. Command and Transmission Frame Details

Reading Data .....	28
Reading Read-Only Bit Data (Function Code: 02H) .....	28
Reading Word Data (Function Code: 03H).....	30
Reading Read-Only Word Data (Function Code: 04H) ....	32
Writing Data.....	34
Writing Word Data (1 word, function code: 06H) .....	34
Writing Continuous Word Data (Function code: 10H) .....	36

## 7. Address Map and Data Format

Data Format .....	40
Sent Data Format .....	40
Internal Calculation Value and Engineering Unit .....	40
Managing the Decimal Point.....	40
Data during Input Error .....	41
Written Data .....	41
Addresses Not Written.....	41
Internal Calculation Value Data Address Map .....	42
Bit Data (read only): function code [02 (H)] .....	42
Word Data (read/write): function code [03 (H), 06 (H), 10 (H)].....	43
Word Data (read only): function code [04 (H)] .....	63

## 8. Sample Program

Sample Program .....	68
----------------------	----

## 9. Troubleshooting

Troubleshooting.....	78
----------------------	----

# Chapter 1

## Communication Functions

Overview – 4

# Overview

- The micro controller is equipped with communication functions from the RS-485 interface and PC loader interface, which enables the transmission and reception of data between such devices as the personal computer, programmable controller, and graphic panel.
- The communication system is composed of a master and slave relationship. Up to thirty-one slaves (micro controllers) may be connected to one master (such as a personal computer) based on a "single master/multiple slave" method.
- However, the master can only communicate with one slave at a time. Therefore, each slave is specified by the "Station No." setting. With PC loader communication, only one slave can be connected to one master.

**Caution**

- Systems constructed with the micro controller as slaves do not respond to messages issued by the master with broadcast queries where the station number is "0".
- PC loader communication is not compatible with the multiple slave method.

- In order to have proper communication between master and slave, the transmission data must be in the same format. This document explains how to transmit data using the MODBUS protocol format.
- When using equipment with an RS-232C interface, such as a personal computer, as the master, make sure to use an RS-232C to RS-485 converter.
- When using PC loader communication, you can use RS-232C communication with the personal computer by connecting the PC loader interface on the bottom of this unit with the PC loader communication cable (RS-232C, model: ZZPPXH1\*TK4H4563) sold separately.

## [RS-232C to RS-485 converter] (Recommended)

Model number/Type	Contact	URL
KS3C-10 (insulating type)	Made by Omron Corporation	<a href="http://www.omron.co.jp">http://www.omron.co.jp</a>
RC-77 (insulating type)	Made by RA Systems Corporation	<a href="http://www.ras.co.jp">http://www.ras.co.jp</a>

## Connecting to a programmable controller

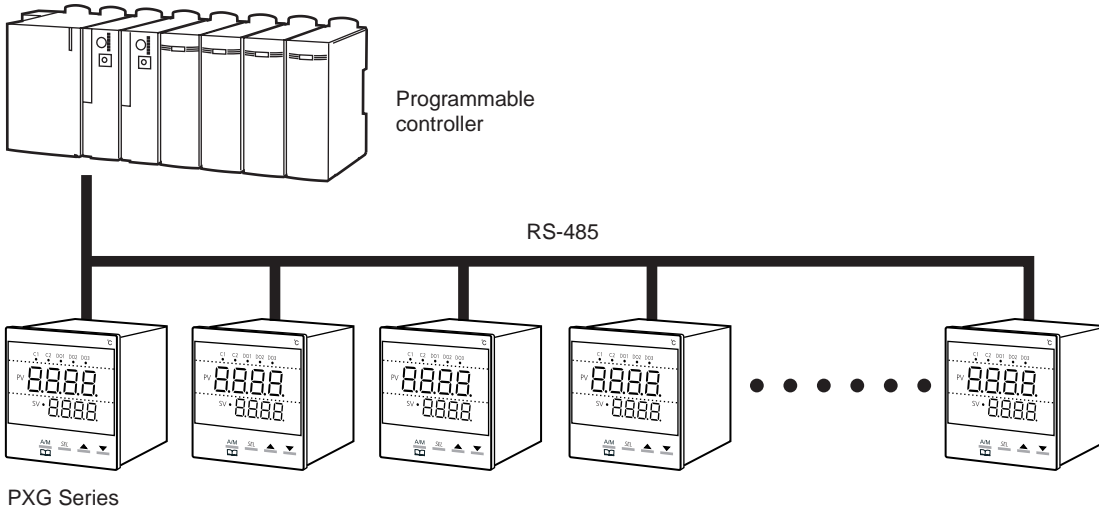

## Connecting to a personal computer

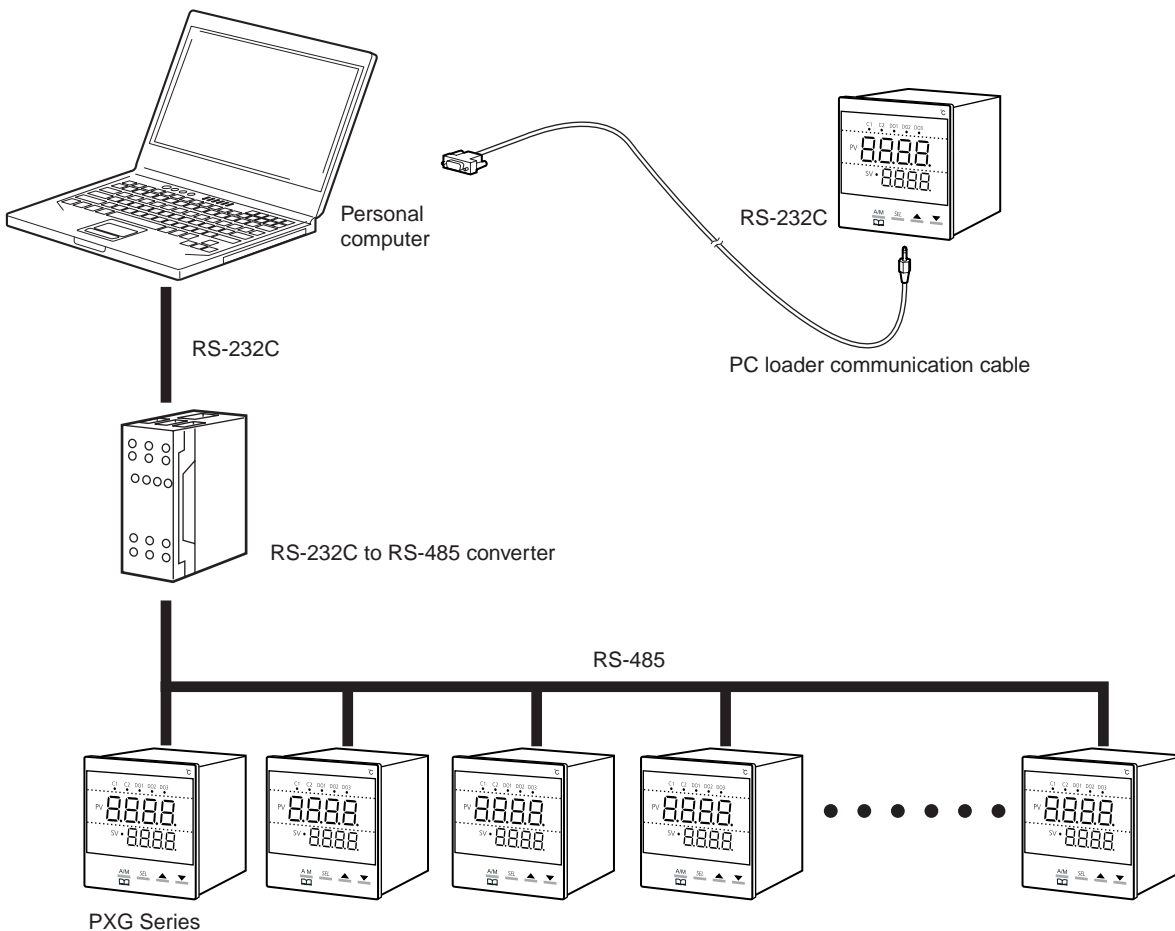

**Caution**

When using the RS-232C to RS-485 converter, check to make sure that the cable is properly connected between the converter and master. Communication will not work properly if the connection is incorrect. Also be sure to correctly set the communication settings (such as communication speed and parity) on the RS-232C to RS-485 converter. Communication will not work properly if the settings are incorrect.

---

# MEMO

Chapter  
1

# Chapter 2

## Specifications

Communication Specifications – 8



# Communication Specifications

## RS-485

Item	Specifications	
Electrical specifications	EIA RS-485 compliant	
Communication method	Two wire system, half double-bit serial	
Synchronous method	Asynchronous	
Connection status	1:N	
Max. no. of connections	31 units	
Communication distance	Max 500m (total length)	
Communication speed	9600bps, 19200 bps	
Data format	Data length	8 bits
	Stop bit	1 bit
	Parity	None/Even/Odd (Selectable)
Transmission code	HEX value (MODBUS RTU mode)	
Error detection	CRC-16	
Insulation	Functional insulation for the transmission area and other areas (withstanding AC 500V)	

## PC Loader Interface

Item	Specifications	
Electrical specifications	EIA RS232 C	
Communication method	3wire system, half double-bit serial	
Synchronous method	Asynchronous	
Connection status	1:1	
Station No.	1 (Not to be changed)	
Communication speed	9600 bps (Not to be changed)	
Data format	Data length	8 bits
	Stop bit	1 bit
	Parity	none (Not to be changed)
Transmission code	HEX value (MODBUS RTU mode)	
Error detection	CRC-16	
Insulation	Non-insulated internal circuit	

# Chapter 3

## Connection

Communication Terminal Configuration – 10

●  
Wiring – 11

**⚠ Warning**

Do not turn on power until all of the wiring is completely finished.  
There is a risk of electrical shock or damage.

# Communication Terminal Configuration

■ RS-485 (rear terminal)

**PXG4**

Terminal Number	Signal Name
7	RS-485 +
8	RS-485 -

1	7	13
2	8	14
3	9	15
4	10	16
5	11	17
6	12	18

**PXG5, PXG9**

Terminal Number	Signal Name
1	RS-485 +
2	RS-485 -

1		25
2		26
3		27
4		28
5		29
6		30
7		31
8		32
9		33
10		34
11		35
12		36

■ PC Loader Interface

(Bottom, φ2.5, three prong miniature jack)

**PXG4**

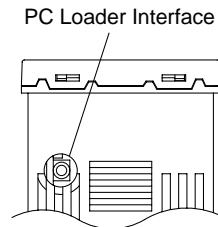

**PXG5**

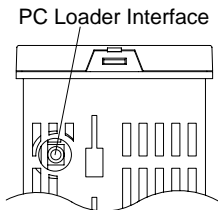

**PXG9**

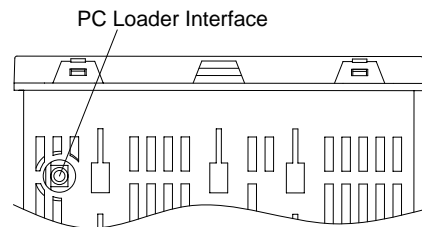

# Wiring

## ■ RS-485

- Please use a shielded twist pair cable. (Recommended cable: KPEV-SB (made by The Furukawa Electric Co., Ltd.))
- The maximum cable length should be 500m. One master and up to thirty-one micro controllers (slaves) can be connected per circuit.
- Terminate both ends of the circuit with a terminating resistance of  $100\Omega$  ( $1/2W$  or more).
- Ground the shielded cable once towards the master side.

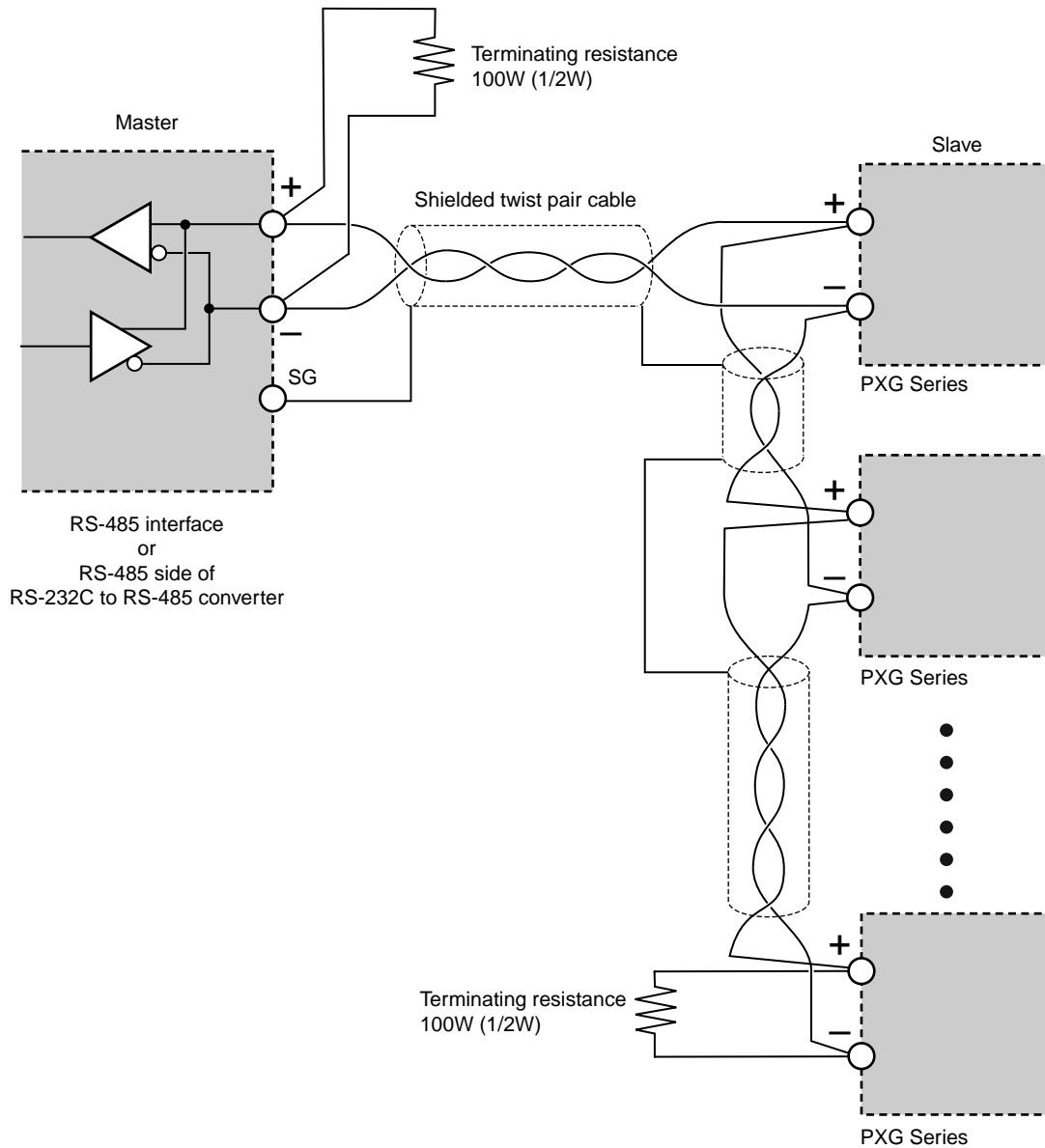

- SG does not have to be connected, but it can be used as an effective countermeasure against communication errors due to noise.

- When using the micro controller in an area where the imposed noise level is expected to exceed 1000V, we recommend using a noise filter on the master side as seen in the figure below.  
[Noise filter] (recommended): ZRAC2203-11 (made by TDK Corporation)

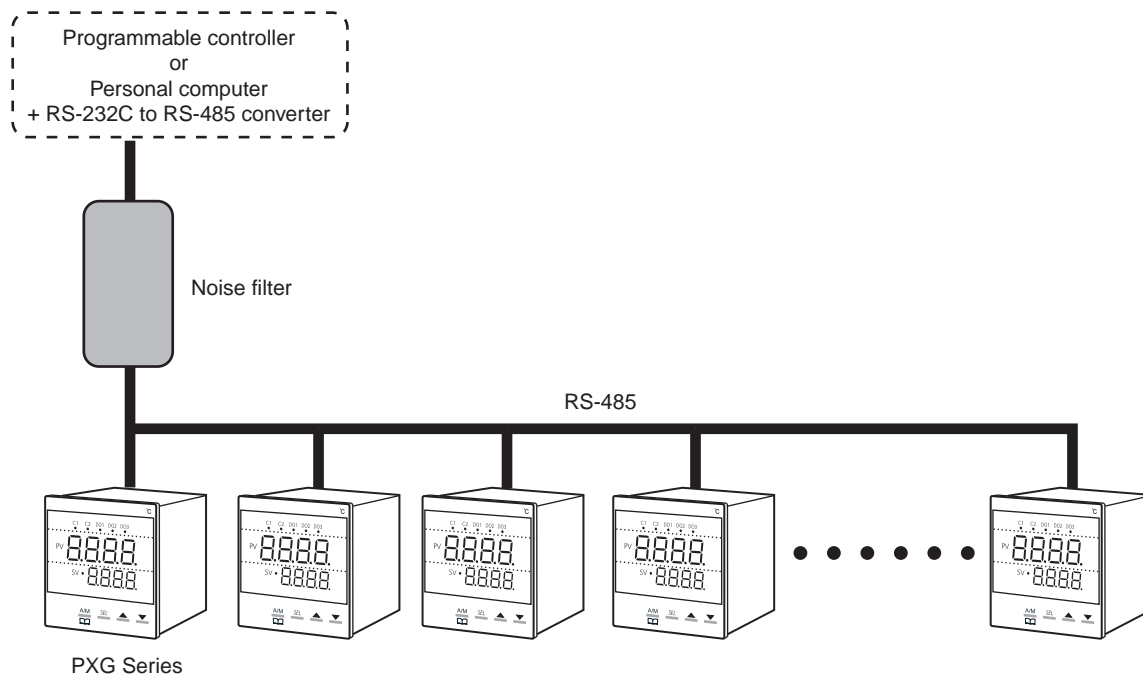

- If there are problems with EMC during communication, the noise level can be reduced by using a communication cable with a ferrite core.  
Ferrite core (recommended): ZCAT series (made by TDK Corporation)  
MSFC series (made by Morimiya Electric Co., Ltd.)

■ PC Loader Interface

- Use the PC loader communication cable (RS-232C) sold separately.

PXG4

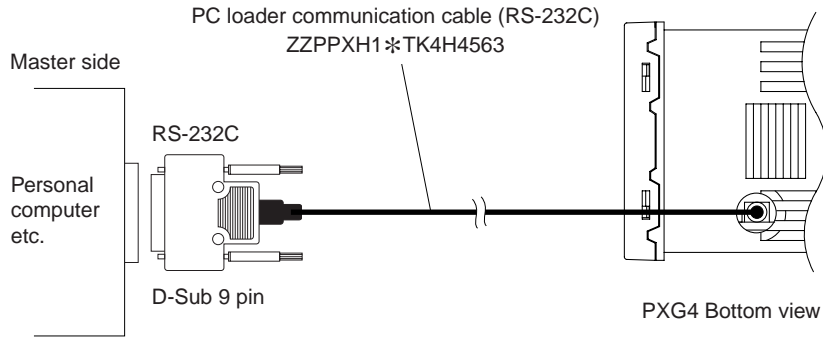

PXG5

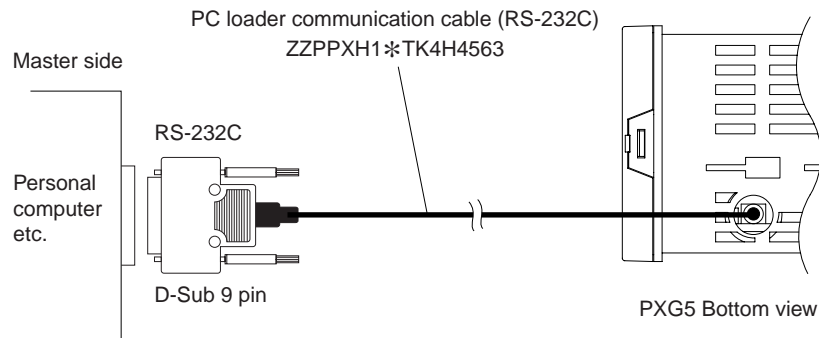

PXG9

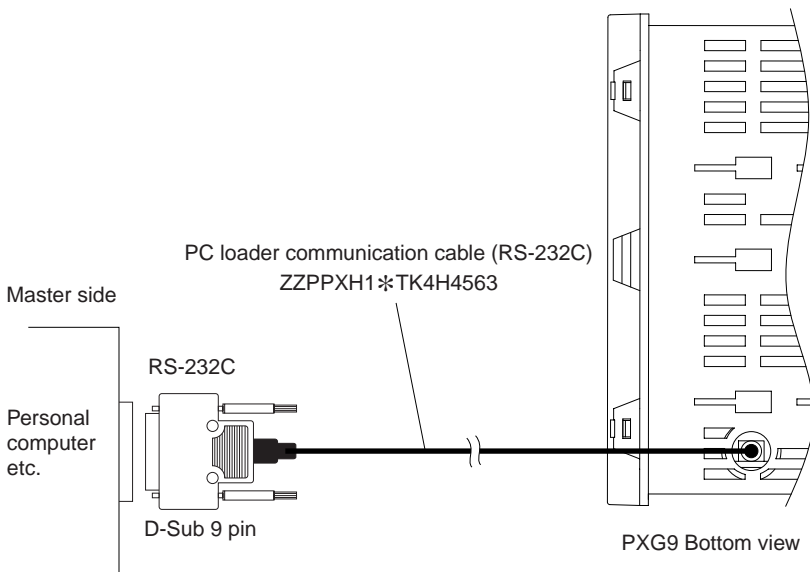

---

## MEMO

# Chapter 4

## Setting Communication Parameters

List of Setting Parameters – 16

Parameter Setting Procedure – 17



The following settings are required for proper communication between the master and micro controller units.

- The communication parameters for the master and all of the units must be set the same.
- During RS-485 communication, all of the micro controllers on a circuit must be set with different "Station No. (STno)" other than "0 (zero)". (Multiple micro controllers must not have the same "Station No.".)
- When using the PC loader interface, settings are not necessary on the main unit (the micro controller).

## List of Setting Parameters

The setting parameters are shown in the chart shown below. Change the settings using the keys on the front of the micro controller.

### ■ RS-485 (main unit side)

Parameter channel	Parameter display symbol	Parameter name	Initial value	Setting range	Remarks
"CoM Ch9" (CoM Ch9)	"STno" (STno)	Station No.	1	0 to 255	Unit does not respond to communication when 0 is set.
	"CoM" (CoM)	baud rate/parity settings	96od	96od (9600 bps/odd) 96Ev (9600 bps/even) 96no (9600 bps/none) 19od (19200 bps/odd) 19Ev (19200 bps/even) 19no (19200 bps/none)	This is the procedure to specify communications speed and parity check. Set the master and all of the slaves with the same settings.
	"SCC" (SCC)	Communication permissions	rW	r (read only) rW (read and writable)	
	–	Data length	8 bits	Fixed (cannot be changed)	Set the master and all of the slaves with the same settings.
	–	Stop bit	1 bit	Fixed (cannot be changed)	

### ■ Loader interface (main unit side)

The parameters do not need to be set. Set the loader software (master) with the following settings.

- Communication speed: 9600 bps
- Parity: none

# Parameter Setting Procedure

The following steps explain how to change the settings to station number "3", parity setting "9600bps/none", and communication permissions "read and writable" as an example.

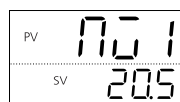

- 1 Press and hold the  key to display "no 1".  
The MV1 of the monitoring screen is displayed.



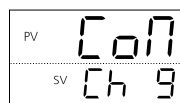



- 2 Press and hold the  key to display the setup mode operation menu ("ope ch 1"), then use the   keys to display "con ch 9".  
The communication menu is displayed.

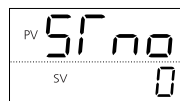

(Note) If your micro controller does not have a communication function, "con ch 9" will not be displayed. Please check with your model.



- 3 Press and hold the  key, then use the   keys to display "st no".  
The station number is displayed.



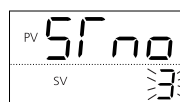



- 4 Press the  key, then use the   keys to set station number to "3" when the bottom part of the display begins to blink.  
This sets the parameter to "3".

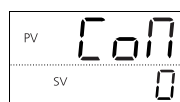

- 5 Press the  key to confirm the setting.

- 6 Use the   keys to select the parity setting ("con").





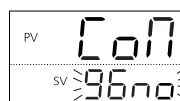

- 7 Press the  key, then use the   keys to set the parity setting to "96no" when the bottom part of the display begins to blink.  
The baud rate/parity setting is set to "9600 bps/none".



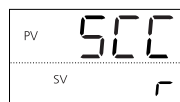

- 8 Press the  key to confirm the setting.

- 9 Use the   keys to select the communication permissions ("sc").

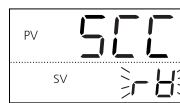

- 10 Press the  key, then use the   keys to set the communication permissions to "rw" when the bottom part of the display begins to blink.  
"read/write" is selected.



- 11 Press the  key to confirm the setting.

---

**12** Press the  key to return to the operation mode PV/SV display.

**13** **Turn the power to the micro controller off and on again.**  
The changes to the communication parameters become effective after the power turns off and on again.

# Chapter 5

## MODBUS Communication Protocol

Overview – 20



Message Composition – 21



Calculating Error Check Code (CRC-16) – 24



Transmission Control Steps – 25



Precautions when Writing Data – 26

# Overview

The communication system with the MODBUS protocol always operates using a method where the master first sends a command message and the applicable slave replies with a response message.

The following describes the communication steps.

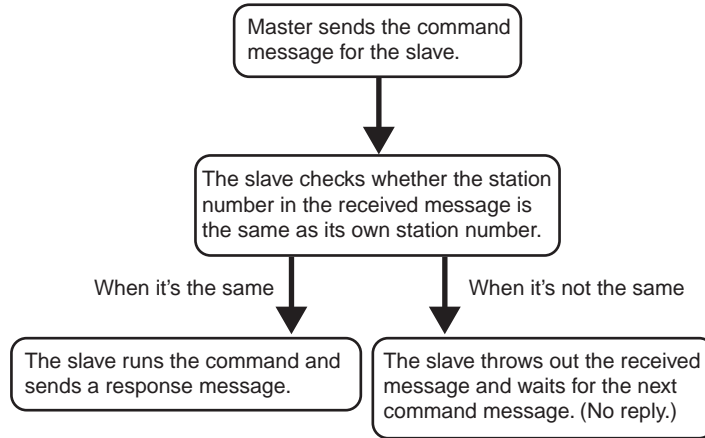

Chapter  
5

- When the station number in the command message is the same as the unit's station number

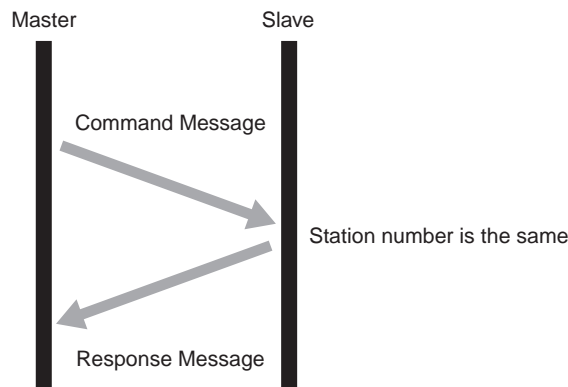

- When the station number in the command message is not the same as the unit's station number

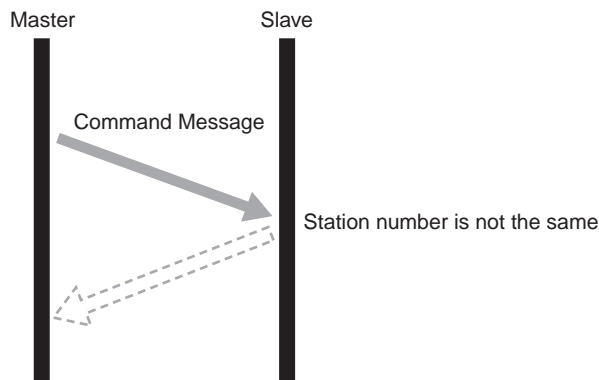

The master can communicate with an individual slave when multiple slaves are connected on the same circuit by the station number specified in the master's command message.

# Message Composition

The command message and response message are composed of four parts: the station number, function code, data part, and error check code. These four parts are sent in that order.

Field name	No. of bytes
Station No.	1 byte
Function Code	1 byte
Data Part	2 to 125 bytes
Error Check Code (CRC-16)	2 bytes

The following describes each part of the message.

## Station No.

This is the number specifying the slave. Commands can only be processed by slaves that have the same value set in the "STno" parameter.

 For more about setting the "STno" parameter, see "Chapter 4, Setting Communication Parameters" (p. 15).

## Function Code

This code specifies the function for the slave to perform.

 For more about function codes, see "Function Code" (p. 23).

## Data Part

This data is required to run the function code. The composition of the data part is different depending on the function code.

 See "Chapter 6, Command and Transmission Frame Details" (p. 27).

The data in the micro controller is assigned a coil number or resistor number. This coil number or resistor number is specified when the data is read or written through communication.

The coil number or resistor number used by the message employs a relative address.

The relative address is calculated using the following formula.

**Relative address = (last four digits of the coil number or resistor number) – 1**

(Ex.) When a function code specifies resistor number "40003"

Relative address= (the last four digits of 40003) – 1

= 0002

is used in the message.

## Error Check Code

This code detects whether there are errors (changes in the bits) during the signal transmission processes. MODBUS protocol (RTU mode) uses CRC-16 (Cyclic Redundancy Check).

 For more about calculating CRC, see Section 5, "Calculating Error Check Code (CRC-16)" (p. 24).

## Slave Response

### ■ Normal Slave Response

The slave creates and replies with a response message for each command message. The response message has the same format as the command message.

The contents of the data part are different depending on the function code.

Refer to



See "Chapter 6, Command and Transmission Frame Details".

### ■ Irregular Slave Response

If there are problems (such as specification of a nonexistent function code) with the contents of the command message other than transmission error, the slave creates and replies with an error response message without following the command.

The composition of the error response message uses the value of the function code in the command message plus 80H, as seen below.

Field name	No. of bytes
Station No.	1 byte
Function Code + 80 H	1 byte
Error Code	1 byte
Error Check Code (CRC-16)	2 bytes

The error code is shown as follows.

Error Code	Contents	Explanation
01H	Faulty function code	A nonexistent function code was specified. Please check the function code.
02H	Faulty address for coil or resistor	The specified relative address for the coil number or resistor number cannot be used by the specified function code.
03H	Faulty coil or resistor number	The specified number is too large and specifies a range that does not contain coil numbers or resistor numbers.

### ■ No Response

In the following situations, the slave will ignore the command message and not send a response message.

- The station number specified by the command message is not the same as the slave's specified station number.
- The error check code does not correspond, or a transmission error (such as parity error) is detected.
- The interval between the data comprising the message is empty for more than 24 bit time.

Refer to



See Section 5 "Transmission Control Steps" (p. 25).

- The slave station number is set to "0".

## Function Code

For MODBUS protocol, coil numbers or resistor numbers are assigned by the function code, and each function code only works for the assigned coil number or resistor number.

The correspondence between the function code and the coil number or resistor number is as follows.

Function Code			Coil Number, Resistor Number	
Code	Function	Target	Number	Contents
02H	Read (continuous)	Input relay	1xxx	Read bit data
03H	Read (continuous)	Hold resistor	3xxx	Read word data
04H	Read (continuous)	Input resistor	4xxx	Read/write word data
06H	Write	Hold resistor		
10H	Write (continuous)	Retention resistor		

The message length for each function is as follows.

[unit: byte]

Code	Contents	Assignable Data Number	Command Message		Response Message	
			Minimum	Maximum	Minimum	Maximum
02H	Read bit data (read-only)	8 bit <sup>*1</sup>	8	8	6	6
03H	Read word data	60 words <sup>*1</sup>	8	8	7	125
04H	Read word data (read-only)	37 words <sup>*1</sup>	8	8	7	79
06H	Write word data	1 word	8	8	8	8
10H	Continuously write word data	60 words <sup>*1</sup>	11	129	8	8

\*1: "Assignable Data Number" above is limited by the data number that the micro controller assigned to the coil number or address number.

(Excluding function code 06H).



# Calculating Error Check Code (CRC-16)

CRC-16 is a 2-byte (16-bit) error check code. The calculation range extends from the start of the message (station number) to the end of the data part.

The slave calculates the CRC of the received message and ignores the message if this value is not the same as the received CRC code.

CRC-16 is calculated as follows.

Chapter  
5

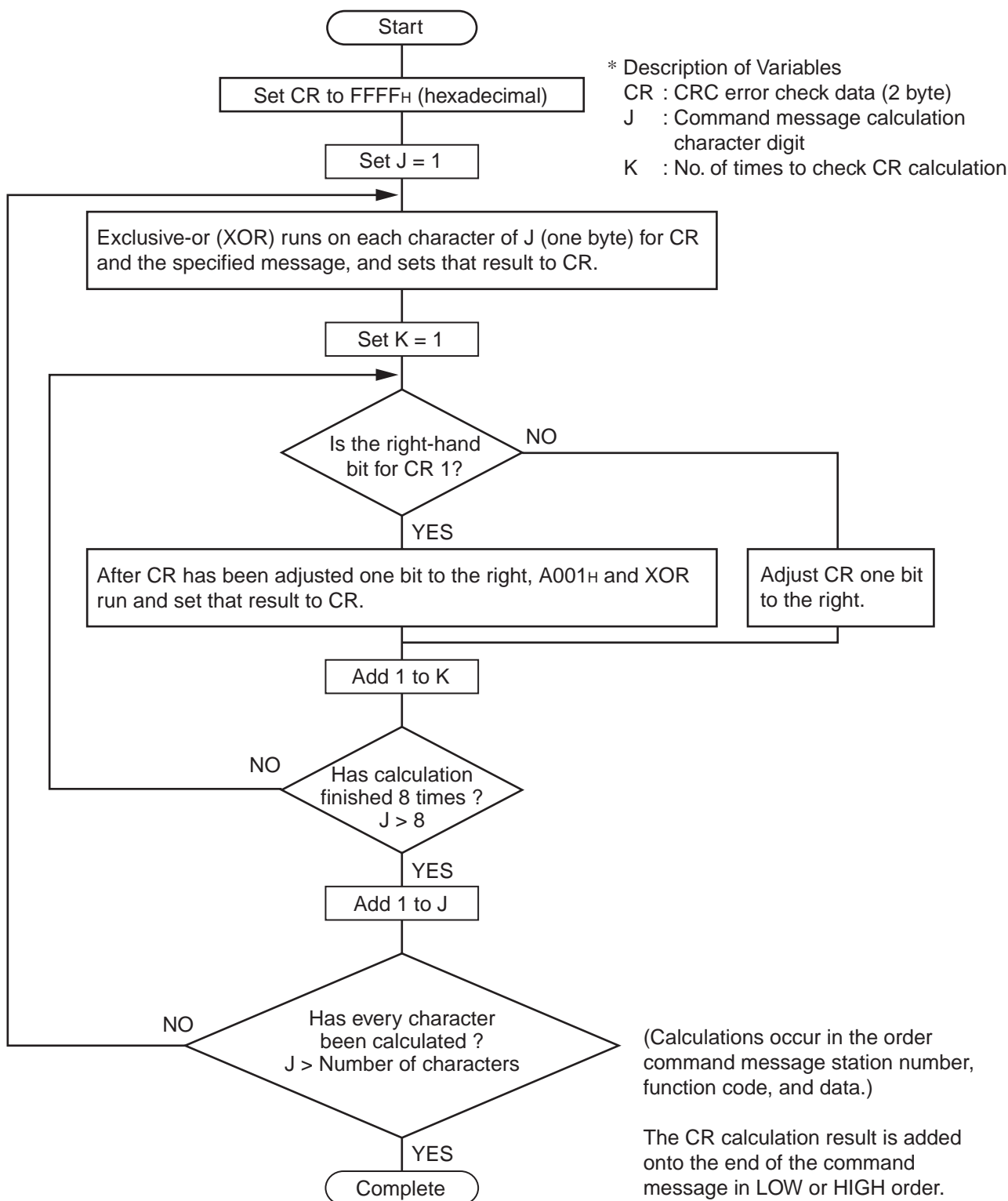

# Transmission Control Steps

## Master Communication Method

Start communication from the master while following the rules below.

1. The command message, must be sent after an empty space of at least 48 bit time.
2. The interval between each byte in a command message should be less than 24 bit time.
3. After sending a command message, for less than 24 bit time the master will enter receiving standby.
4. After receiving the response message, the next command message must be sent after at least 48 bit time. (Similar to #1.)
5. For safety reasons, create a framework where the master checks the response message, and if there is no response or an error occurs, retry at least three times.

### Caution

The definitions written above are for the minimum required value. For safety reasons, we recommend creating a master side program that keeps margins two to three times as large. For a concrete example, with 9600 bps, we recommend programming a blank state (#1 above) of at least 10ms, and the interval between bytes (#2 above) and switching time from sending to receiving (#3 above) within 1 ms.

## Explanation

### ■ Frame Detection

This communication system uses a two-wire RS-485 interface, and the circuit can therefore enter one of the following two states.

- Empty state (no data on the circuit)
- Communication state (data running on the circuit)

The units connected on the circuit start in receiving state and monitor the circuit. When a blank state appears on the circuit for at least 24 bit time, the unit detects the end of the previous frame, and within the next 24 bit time, enters receiving standby. When data appears on the circuit, the unit begins receiving data, and once another blank state of at least 24 bit time is detected, that frame is ended. In other words, the data on the circuit from the first time that a 24 bit time blank state appears to the second time one appears is loaded as one frame (a bundle of data). Therefore, one frame (command message) must be sent while following the rules below.

- Before sending the command message, leave an empty space of at least 48 bit time.
- The interval between each byte in a command message should be less than 24 bit time.

### ■ Micro controller Response

After the micro controller detects the frame (detects blank states at least 24 bit time long), that frame is used to send a command message. When a command message is sent locally, the response message is returned, but the processing time is about 1 to 30 ms. (The time may change depending on the contents of the command message.) Therefore, one frame (command message) must be sent while following the rules below.

- After sending a command message, for less than 24 seconds the master will enter receiving standby.

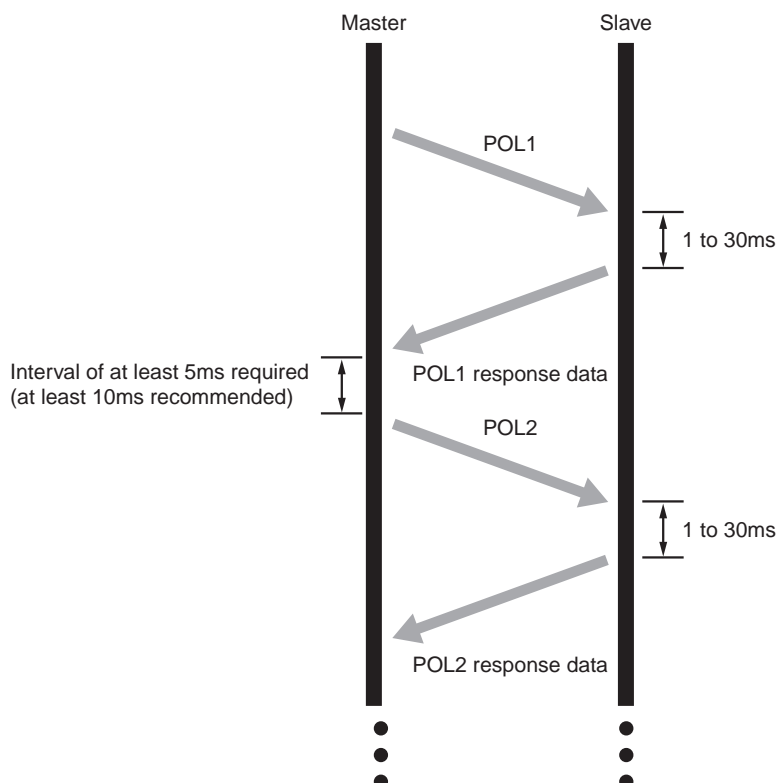

# Precautions when Writing Data

PXG contains internal nonvolatile memory (EEPROM) that is used to save the setting parameters. The data written to the nonvolatile memory (EEPROM) remains even after the power for PXG is turned off. Parameters that are written via communication are automatically saved in the internal nonvolatile memory (EEPROM). However, please note that there are two limitations as follows.

**Caution**

1. There is a limit to the number of times that data can be transferred to the nonvolatile memory (EEPROM) (100,000 times). Data cannot be guaranteed if written more than 100,000 times.  
Be careful not to transfer unnecessary data when writing data via communication.  
In particular, when constructing a communication system with master POD (such as a touch panel), make sure that the POD writing and trigger settings are appropriate.  
Avoid writing at fixed cycles.
2. Writing to the nonvolatile memory (EEPROM) takes several milliseconds. If the power for PXG is turned off during this operation, the data saved to the nonvolatile memory (EEPROM) may be corrupted.  
Wait several seconds after writing data before turning off the power.  
In particular, when writing data in a cycle from master device, there is a greater danger of the writing timing and power shutoff timing coinciding.  
Avoid writing at fixed cycles.

# Chapter 6

## Command and Transmission Frame Details

Reading Data – 28

●  
Writing Data – 34

# Reading Data

## Reading Read-Only Bit Data (Function Code: 02H)

The unit reads bit data continuously for the specified number of bits from the first number to start reading from. The slaves systematically send the read data in 8-bit units.

**Caution** When the number of bits to be read is not a multiple of eight, unrelated bits (on the MSB side) all become "0".

Function Code	02H
Max. No. of Bits to Read in One Message	8 bits
Relative Address	0000H to 000CH
Coil Number	10001H to 10013H

### Message Composition

#### Command Message (bytes)

Station No.	
Function Code	
Number to Start Reading (Relative Address)	Upper
	Lower
No. of Bits to Read	00H
	Lower
CRC Data	Upper
	Lower

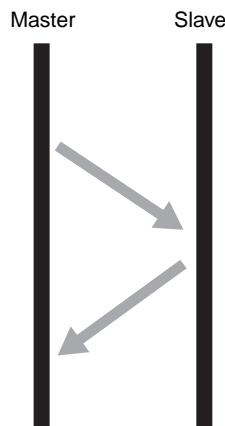

#### Reply Message Composition (bytes)

Station No.	
Function Code	
No. of Bytes to Read (01H)	
State of first 8 bits	
CRC Data	Upper
	Lower

#### Bit Data to Read List

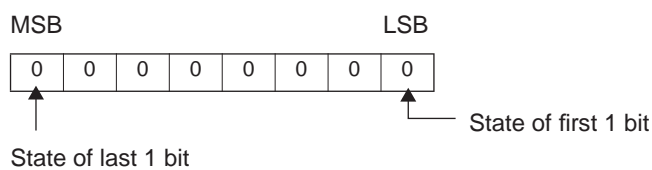

**Example of Transmitting a Message**

This following example explains how to read ALM1 and ALM2 on station number 31.

- ALM1 detection data bit Relative address: 0000H Data number: 2H
- ALM2 detection data bit Relative address: 0001H

**Command Message (bytes)**

Station No.	1FH	
Function Code	02H	
No. to Start Reading (Relative Address)	Upper	00H
	Lower	00H
No. of Bits to Read	Upper	00H
	Lower	02H
CRC Data	Upper	FAH
	Lower	75H

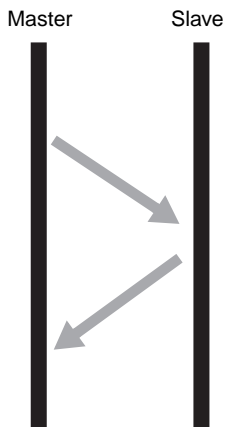

**Response Message (bytes)**

Station No.	1FH	
Function Code	02H	
No. of Bytes to Read	01H	
State of first 8 bits	01H	
CRC Data	Upper	66H
	Lower	60H

■ **Meaning of Read Data**

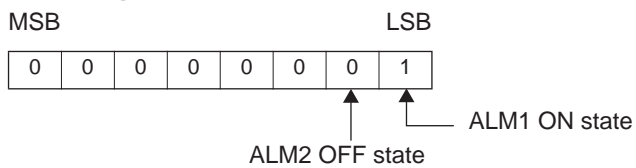



**Example of Transmitting a Message (For Engineering Unit)**

The message is composed as follows when reading the PV input lower limit and PV input upper limit from station number 2.

- PV Lower Limit Relative Address: 03F9H

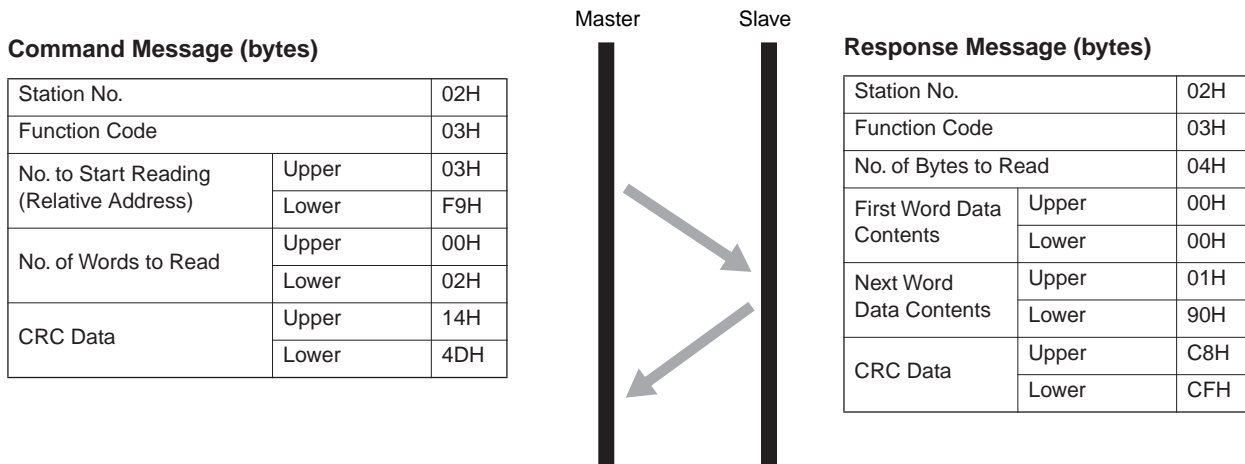

**■ Meaning of Read Data**

PV Input Lower Limit 00 00H = 0

PV Input Upper Limit 01 90H = 400

If Decimal Point Position = 0, then the PV input upper limit and lower limit are as follows.

PV Lower Limit = 0°C

PV Upper Limit = 400°C

**Refer to** For more about the internal calculation value, engineering unit, and decimal point see "Chapter 7, Address Map and Data Format" (p. 39).



## Reading Read-Only Word Data (Function Code: 04H)

The unit reads word data continuously for the specified number of words from the first number to start reading from. The slave forwards the read word data from the upper number of bytes to the lower number.

Function Code	04H	
Max. No. of Words to Read in One Message	37 bytes	
Relative Address	0000H to 0064H	03E8H to 044CH
Resistor Number	30001 to 30100	31001 to 31100
Contents	Internal Calculation Value	Engineering Unit

### Message Composition

Chapter  
6

#### Command Message Composition (bytes)

Station No.	
Function Code	
No. to Start Reading (Relative Address)	Upper
	Lower
No. of Words to Read (1 to 15 words)	Upper
	Lower
CRC Data	Upper
	Lower

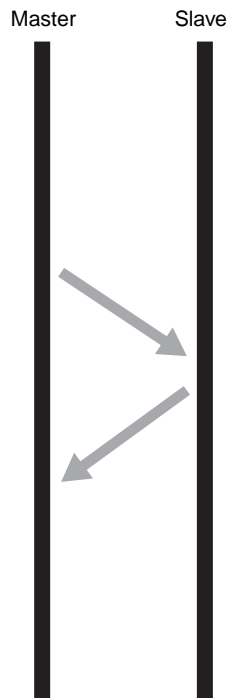

#### Reply Message Composition (bytes)

Station No.	
Function Code	
No. of Bytes to Read (No. of Words to Read x 2)	
First Word Data Contents	Upper
	Lower
Next Word Data Contents	Upper
	Lower
⋮	
Last Word Data Contents	Upper
	Lower
CRC Data	Upper
	Lower



#### ■ Meaning of Read Word Data

MSB	LSB
First Word Data upper byte	
First Word Data lower byte	
Next Word Data upper byte	
Next Word Data lower byte	
⋮	
Last Word Data upper byte	
Last Word Data lower byte	

**Example of Transmitting a Message (Internal Calculation Data)**

The message is composed as follows when reading the PV input value from station number 1.

- PV value relative address: 0000H Number of data: 01H

**Command Message (bytes)**

Station No.	01H	
Function Code	04H	
No. to Start Reading (Relative Address)	Upper	00H
	Lower	00H
No. of Bits to Read	Upper	00H
	Lower	01H
CRC Data	Upper	31H
	Lower	CAH

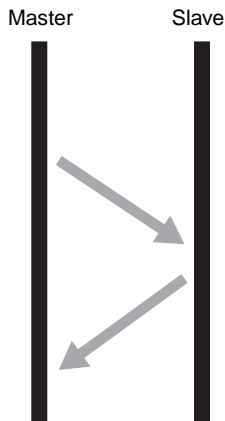

**Response Message (bytes)**

Station No.	01H	
Function Code	04H	
No. of Bytes to Read	02H	
First Word Data Contents	Upper	03H
	Lower	46H
CRC Data	Upper	38H
	Lower	32H

**■ Meaning of Read Data**

Word Data Contents 03 46H = 838 (8.38% FS)

When the input range is 0 to 400°C

PV = 33.5°C (= 8.38% FS x 400 (input range width))

**Refer to** For more about the internal calculation value, engineering unit, and decimal point see "Chapter 7, Address Map and Data Format" (p. 39).



**Example of Transmitting a Message (For Engineering Unit)**

The message is composed as follows when reading the PV value from station number 1.

- PV value relative address: 03E8H Number of data: 01H

**Command Message (bytes)**

Station No.	01H	
Function Code	04H	
No. to Start Reading (Relative Address)	Upper	03H
	Lower	E8H
No. of Words to Read	Upper	00H
	Lower	01H
CRC Data	Upper	B1H
	Lower	BAH

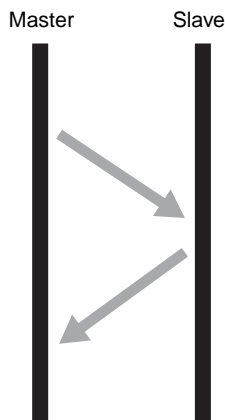

**Response Message (bytes)**

Station No.	01H	
Function Code	04H	
No. of Bytes to Read	02H	
First Word Data Contents	Upper	01H
	Lower	4FH
CRC Data	Upper	F9H
	Lower	54H

**■ Meaning of Read Data**

Word Data Contents 01 4FH = 335

When the decimal point position = 1

PV = 33.5°C

**Refer to** For more about the internal calculation value, engineering unit, and decimal point see "Chapter 7, Address Map and Data Format" (p. 39).



# Writing Data

## Writing Word Data (1 word, function code: 06H)

This writes the specified data to the specified number for word data. The master sends the data to be written from the upper number of bytes to the lower number.

Function Code	06H	
Max. No. of Bits to Read in One Message	1 words	
Relative Address	0001H to 0274H	03E9H to 065CH
Resistor Number	40002 to 40628	41002 to 41628
Contents	Internal Calculation Value	Engineering Unit

## Message Composition

Chapter  
6

### Command Message Composition (bytes)

Station No.	
Function Code	
Specified Write Number (Relative Address)	Upper
	Lower
Word Data to Write	Upper
	Lower
CRC Data	Upper
	Lower

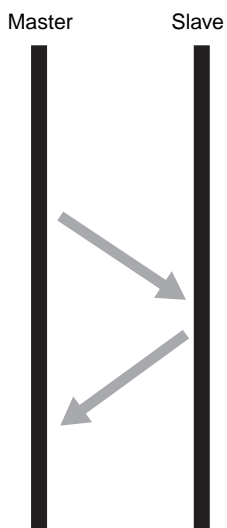

### Response Message Composition (bytes)

Station No.	
Function Code	
Specified Write Number (Relative Address)	Upper
	Lower
Word Data to Write	Upper
	Lower
CRC Data	Upper
	Lower

### Example of Transmitting a Message

This example explains how to set PID parameter "P" to 100.0 (1000D = 03E8H) on station number 1.

Parameter "P" relative address: 0005H (internal calculation value table)  
03EDH (initial value table)

#### Command Message (bytes)

Station No.		01H
Function Code		06H
Specified Write Number (Relative Address)	Upper	00H
	Lower	05H
Word Data to Write	Upper	03H
	Lower	E8H
CRC Data	Upper	99H
	Lower	75H

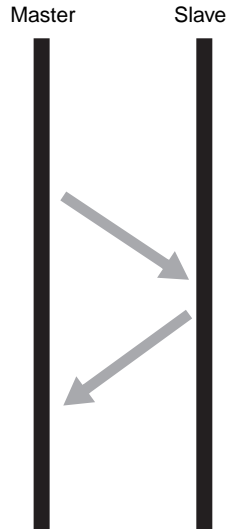

#### Response Message (bytes)

Station No.		01H
Function Code		06H
Specified Write Number (Relative Address)	Upper	00H
	Lower	05H
Write Specification State	Upper	03H
	Lower	E8H
CRC Data	Upper	99H
	Lower	75H

#### Point

For more about the internal calculation value, engineering unit, and decimal point see "Sent Data Format" (p. 40).

## Writing Continuous Word Data (Function code: 10H)

This writes continuous word information for a number of written words from the first number for writing. The master sends the data to be written from the upper number of bytes to the lower number.

Function Code	10H	
Max. No. of Bits to Read in One Message	60 words	
Relative Address	0000H to 0077H	03E8H to 045FH
Resistor Number	40001 to 40120	41001 to 41120
Contents	Internal Calculation Value	Engineering Unit

### Message Composition

Chapter  
6

#### Command Message Composition (bytes)

Station No.		
Function Code		
Specified Write Number (Relative Address)	Upper	} 1 to 60 } No. of Words to Write x 2
	Lower	
No. of Words to Write	Upper	
	Lower	
No. of Bytes to Write		
First Word Data to Write	Upper	
	Lower	
Next Word Data to Write	Upper	
	Lower	
...		
Last Word Data to Write	Upper	
	Lower	
CRC Data	Upper	
	Lower	

#### Reply Message Composition (bytes)

Station No.	
Function Code	
Specified Write Number (Relative Address)	Upper
	Lower
No. of Words to Write	Upper
	Lower
CRC Data	
Upper	
Lower	

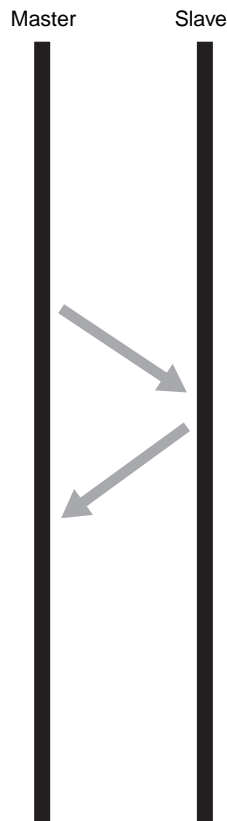

#### ■ Meaning of Read Word Data

MSB	LSB
First Word Data upper byte	
First Word Data lower byte	
Next Word Data upper byte	
Next Word Data lower byte	
...	
Last Word Data upper byte	
Last Word Data lower byte	

**Example of Transmitting a Message (Internal Calculation Data)**

The message is composed as follows when writing the following PID parameters to station number 1.

P = 100.0 (= 1000D = 03E8H)

I = 10 (= 100D = 0064)

D = 5.0 (= 50D = 0032H)

- Parameter "P" relative address: 0005H, Data number: 03H

**Command Message (bytes)**

Station No.		01H
Function Code		10H
Specified Write Number (Relative Address)	Upper	00H
	Lower	05H
No. of Words to Write	Upper	00H
	Lower	03H
No. of Bytes to Write		06H
First Word Data to Write	Upper	03H
	Lower	E8H
Next Word Data to Write	Upper	00H
	Lower	64H
Last Word Data to Write	Upper	00H
	Lower	32H
CRC Data	Upper	56H
	Lower	BEH

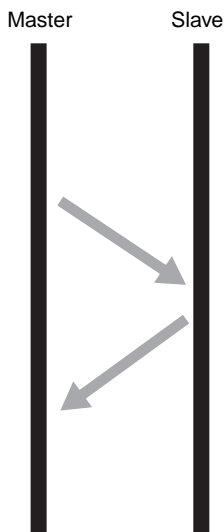

**Response Message (bytes)**

Station No.		01H
Function Code		10H
Specified Write Number (Relative Address)	Upper	00H
	Lower	05H
Write Specification State	Upper	00H
	Lower	03H
CRC Data	Upper	90H
	Lower	09H

**Point** The decimal point cannot be included in the sent data, so data such as "100.0" above is sent as "1000".

**Refer to** For each type of send data format, see "Chapter 7, Address Map and Data Format" (p. 39).

---

## MEMO

# Chapter 7

## Address Map and Data Format

Data Format – 40



Internal Calculation Value Data Address Map – 42



# Data Format

## Sent Data Format

The MODBUS protocol used by this equipment employs RTU (Remote Terminal Unit) mode. The data is sent as "numerical value", not as ASCII code.

## Internal Calculation Value and Engineering Unit

In this unit, parameter data and data dependent on an input range can handle the following two types of data.

Internal Calculation Value: Values listed as percentages of the input range (0.00 to 100.00, without decimal point)

Engineering Unit: Values subjected to scaling to actual values depending on the input range

"Engineering Unit" data is handled as the address (resister number) of 1000 added to the address (resister number) for "Internal Calculation Value".

(Ex.) The value is calculated as follows when the full scale is 400°C and the PV value is "150".

Class	Resistor Number	Data (HEX)		Data
Internal Calculation Value	30001	0EA6 (H)	→	3750 (37.5%)
Engineering unit	31001	0096 (H)		150

The PV value is received as follows.

$$37.50 (\%) \times 400 (\text{full scale } ^\circ\text{C}) = 150 \text{ } ^\circ\text{C}$$

Data not dependent on an input range the same data in both addresses.

Also, bit data cannot be handled in this manner. (Not effective for addresses with 1,000 added.)



For more about data dependent on an input range, see "Chapter 7 Address Map and Data Format" (page 39).



Pay attention to the position of the decimal point when changing the input range by writing with communication. When changing the position of the decimal point by writing with communication, change the lower limit and upper limit of the input range at the same time.

(Ex.) When changing the input range from 0 to 400 to 0.0 to 400.0

### ■ Operating the keys on the front of the equipment

Change the position of the decimal point ("P<sub>UD</sub>") in the setup menu ("SEt Ch 6").

"P<sub>UD</sub>" = 0 → 1 (or 2)

### ■ Changing by communication

Set the decimal position parameter ("P<sub>UD</sub>"), as well as the corresponding values for PF input lower limit ("P<sub>LB</sub>") and PV input upper limit ("P<sub>UF</sub>").

"P<sub>UD</sub>" = 0 → 1

"P<sub>LB</sub>" = 0 → 0

"P<sub>UF</sub>" = 400 → 4000

## Managing the Decimal Point

Some of the internally stored data may contain may digits lower than the decimal point on the front display. Also, the decimal point is not added to sent data.

Carry out processes for the decimal point position (erasing the decimal point when sending data and adding the decimal point when receiving data).

Attention must be paid to the position of the decimal point for data where the parameters are dependent on a range in "Chapter 7 Address Map and Data Format". Refer to Address Map.

---

## Data during Input Error

For situations such as overrange, underrange, and input breaks where "UUUU" or "LLLL" display on the front, read PV value becomes 105% or -5% of the input range.

Input errors can be detected via communication using "resistor number 30008 (or 31008): Input/Unit Error Status".

## Written Data

When writing data to each parameter, set that written data within the range for the data. PXG can accept written data outside of the range, but do so with care as correct operations are not guaranteed.

## Addresses Not Written

Do not write to addresses that are not public. Doing so may cause damage.

# Internal Calculation Value Data Address Map

Handles data dependent on an input range as an internal value before scaling (0.00 to 100.00%).

See "Operation Manual" for more details about individual parameter functions and settings ranges.

## Bit Data (read only): function code [02 (H)]

Relative address	Coil Number	Type	Memory contents	Read data	Dependent on range	Remarks/ related parameters
0000H	10001	bit	DO1 OUTPUT ON/OFF	0: DO1 OFF 1: DO1 ON		
00001H	10002	bit	DO2 OUTPUT ON/OFF	0: DO2 OFF 1: DO2 ON		
00002H	10003	bit	DO3 OUTPUT ON/OFF	0: DO3 OFF 1: DO3 ON		
00003H	10004	bit	DO4 OUTPUT ON/OFF	0: DO4 OFF 1: DO4 ON		
00004H	10005	bit	DO5 OUTPUT ON/OFF	0: DO5 OFF 1: DO5 ON		
00008H	10009	bit	DO1 Lamp ON/OFF	0: DO1 Lamp OFF 1: DO1 Lamp ON		
00009H	10010	bit	DO2 Lamp ON/OFF	0: DO2 Lamp OFF 1: DO2 Lamp ON		
0000AH	10011	bit	DO3 Lamp ON/OFF	0: DO3 Lamp OFF 1: DO3 Lamp ON		
0000BH	10012	bit	DO4 Lamp ON/OFF	0: DO4 Lamp OFF 1: DO4 Lamp ON		
0000CH	10013	bit	DO5 Lamp ON/OFF	0: DO5 Lamp OFF 1: DO5 Lamp ON		

## Word Data (read/write): function code [03 (H), 06 (H), 10 (H)]

### Operation (Ch1)

Parameter display	Parameter name	Contents	Relative address	Resistor Number		Type	Read data	Written data range	Factory Setting	Dependent on range
				Internal	Engineering unit					
"MAn"	MAn	Switches to manual mode	0084H	40121	41121	Word	0: oFF (during auto) 1: on (during manual)	0: oFF (auto) 1: on (manual)	oFF	
"STbY"	STbY	Switches between RUN and standby	0003H	40004	41004	Word	0: oFF (during RUN) 1: on (during standby)		oFF	
"rEM"	rEM	Switches to remote mode	0074H	40117	41117	Word	0: LoCL (during Local) 1: rEM (during Remote)	0: LoCL (Local) 1: rEM (Remote)	LoCL	
"PrG"	PrG	Ramp/soak controls Command	0051H	40082	41082	Word	0: oFF (during stop) 1: rUn (during run) 2: hLd (during hold)	0: oFF (stop) 1: rUn (run) 2: hLd (hold)	oFF	
"AT"	AT	Auto-tuning run command	0004H	40005	41005	Word	0: oFF 1: rUn 2: Low		oFF	
"LACH"	LACH	Cancels the DO output latch Command	00A0H	40161	41161	Word	0: oFF 1: rST (latch reset)		oFF	
"SvN" (note 1)	SvN	Selectable SV numbers	00DC <sub>H</sub>	40221	41221	Word	0: Sv0 (Local SV) 1: Sv1 (SV = SV-1) 2: Sv2 (SV = SV-2) 3: Sv3 (SV = SV-3) 4: Sv4 (SV = SV-4) 5: Sv5 (SV = SV-5) 6: Sv6 (SV = SV-6) 7: Sv7 (SV = SV-7) 8: di : SV = choose Di		Sv0	
"PLN I"	PLN1	Currently selected PID No.	00DD <sub>H</sub>	40222	41222	Word	0: Pid0 (PID group local) 1: Pid1 (PID group No. 1) 2: Pid2 (PID group No. 2) 3: Pid3 (PID group No. 3) 4: Pid4 (PID group No. 4) 5: Pid5 (PID group No. 5) 6: Pid6 (PID group No. 6) 7: Pid7 (PID group No. 7) 8: di (PID group Di selection)		Pid0	
"AL 1"	AL1	ALM1 set value or A1-L	00A2 <sub>H</sub>	40163	41163	Word	0% to 100% FS		10°C	○
"AL 1L"	AL1L	AL1L set value				Word	0% to 100% FS (absolute alarm) -100% to 100 % FS (deviation alarm)			○
"AL 1h"	AL1h	AL1h set value	00A3 <sub>H</sub>	40164	41164	Word	0% to 100% FS (absolute alarm) -100% to 100 % FS (deviation alarm)			○
"AL 2"	AL2	ALM2 set value or A2-L	00A9 <sub>H</sub>	40170	41170	Word	0% to 100% FS		10°C	○
"AL 2L"	AL2L	AL2L set value				Word	0% to 100% FS (absolute alarm) -100% to 100 % FS (deviation alarm)			○
"AL 2h"	AL2h	AL2h set value	00AA <sub>H</sub>	40171	41171	Word	0% to 100% FS (absolute alarm) -100% to 100 % FS (deviation alarm)			○
"AL 3"	AL3	ALM3 set value or A3-L	00B0 <sub>H</sub>	40177	41177	Word	0% to 100% FS		10°C	○
"AL 3L"	AL3L	AL3L set value				Word	0% to 100% FS (absolute alarm) -100% to 100 % FS (deviation alarm)			○
"AL 3h"	AL3h	AL3h set value	00B1 <sub>H</sub>	40178	41178	Word	0% to 100% FS (absolute alarm) -100% to 100 % FS (deviation alarm)			○

Note 1: If SV is changed using the front keys of the equipment and "SvN" is changed via communication at the same time, the SV set from the front panel may be reflected to the SV number changed via communication.

Parameter display	Parameter name	Contents	Relative address	Resistor Number		Type	Read data	Written data range	Factory Setting	Dependent on range
				Internal	Engineering unit					
"AL4"	AL4	ALM4 set value or A4-L	00B7H	40184	41184	Word	0% to 100% FS		10°C	○
"AL4L"	AL4L	AL4L set value				Word	0% to 100% FS (absolute alarm) -100% to 100 % FS (deviation alarm)		○	
"AL4h"	AL4h	AL4h set value	00B8H	40185	41185	Word	0% to 100% FS (absolute alarm) -100% to 100 % FS (deviation alarm)			○
"AL5"	AL5	ALM5 set value or A5-L	00BEH	40191	41191	Word	0% to 100% FS		10°C	○
"AL5L"	AL5L	AL5L set value				Word	0% to 100% FS (absolute alarm) -100% to 100 % FS (deviation alarm)		○	
"AL5h"	AL5h	AL5h set value	00BFH	40192	41192	Word	0% to 100% FS (absolute alarm) -100% to 100 % FS (deviation alarm)			○
"LoC"	LoC	Key lock	0027H	40040	41040	Word	0 : no lock 1 : all lock 2 : All but SV locked			

Note 1: If SV is changed using the front keys of the equipment and "SVn" is changed via communication at the same time, the SV set from the front panel may be reflected to the SV number changed via communication.

## PID (Ch2)

Parameter display	Parameter name	Contents	Relative address	Resistor Number		Type	Read data	Written data range	Factory Setting	Dependent on range
				Internal	Engineering unit					
"P"	P	Proportional band	0005H	40006	41006	Word	0 to 9999 (0.0% to 999.9%)	5.0%		
"I"	i	Integration time	0006H	40007	41007	Word	0 to 32000 (0 to 3200 sec)	240 sec		
"d"	d	Derivation time	0007H	40008	41008	Word	0 to 9999 (0.0 to 999.9sec)	60.0 sec		
"hYS"	hYS	ON/OFF control hysteresis	0008H	40009	41009	Word	0% to 50% FS	1°C		○
"CoL"	CoL	Cooling proportional band coefficient	0009H	40010	41010	Word	0 to 1000 (0.0 to 100.0)	1.0		
"db"	db	Dead band	000AH	40011	41011	Word	-5000 to 5000 (-50 to 50%)	0%		
"bAL"	bAL	Output convergence value	000CH	40013	41013	Word	-10000 to 10000 (-100 to 100%)	0/50 (single/dual)		
"Ar"	Ar	Anti-reset windup	000BH	40012	41012	Word	0% to 100% FS	100%		○
"rEv"	rEv	Sets normal/reverse operations	0057H	40088	41088	Word	0: rv-- (heat (reverse) / cool (none)) 1: no-- (heat (normal) / cool (none)) 2: rvno (heat (reverse) / cool (normal)) 3: norv (heat (normal) / cool (reverse)) 4: rvrv (heat (reverse) / cool (reverse)) 5: nono (heat (normal) / cool (normal))	rv--/rvno (single/ dual)		
"SvL"	SvL	SV limit (lower)	001EH	40031	41031	Word	0% to 100% FS	0% FS		○
"Svh"	Svh	SV limit (upper)	001FH	40032	41032	Word	0% to 100% FS	100% FS		○
"TC1"	TC1	OUT1 proportion cycle	0058H	40089	41089	Word	1 sec to 150 sec	30 or 2 sec		
"TC2"	TC2	OUT2 proportion cycle	0059H	40090	41090	Word	1 sec to 150 sec	30 or 3 sec		
"PLC1"	PLC1	OUT1 lower limit	0018H	40025	41025	Word	-300 to 10300 (-3.0 to 103.0%)	-3.0%		
"PhC1"	PhC1	OUT1 upper limit	0019H	40026	41026	Word	-300 to 10300 (-3.0 to 103.0%)	103.0%		
"PLC2"	PLC2	OUT2 lower limit	001AH	40027	41027	Word	-300 to 10300 (-3.0 to 103.0%)	-3.0%		
"PhC2"	PhC2	OUT2 upper limit	001BH	40028	41028	Word	-300 to 10300 (-3.0 to 103.0%)	103.0%		
"PCUT"	PCUT	Selects the output limiter type	0017H	40024	41024	Word	0 to 15	0		

**PID Palette (Ch3)**

Parameter display	Parameter name	Contents	Relative address	Resistor Number		Type	Read data	Written data range	Factory Setting	Dependent on range
				Internal	Engineering unit					
"Sv1"	Sv1	SV set value 1	00F0H	40241	41241	Word	0% to 100% FS	0% FS		○
"P1"	P1	Proportional band 1	00F1H	40242	41242	Word	0 to 9999 (0.0 to 999.9%)	5.0%		
"i1"	i1	Integration time 1	00F2H	40243	41243	Word	0 to 32000 (0 to 3200sec)	240 sec		
"d1"	d1	Derivation time 1	00F3H	40244	41244	Word	0 to 9999 (0.0 to 999.9sec)	60.0sec		
"hYS1"	hYS1	ON/OFF Control hysteresis 1	00F4H	40245	41245	Word	0% to 50% FS	1°C		○
"CoL1"	CoL1	Cooling proportional band 1	00F5H	40246	41246	Word	0 to 1000 (0.0 to 100.0)	1.0		
"db1"	db1	Dead band 1	00F6H	40247	41247	Word	-5000 to 5000 (-50.0 to 50.0%)	0%		
"bAL1"	bAL1	Output convergence value 1	00F7H	40248	41248	Word	-10000 to 10000 (-100.0 to 100.0%)	0/50 (single/dual)		
"Ar1"	Ar1	Anti-reset windup 1	00F8H	40249	41249	Word	0% to 100% FS	100% FS		○
"rEv1"	rEv1	Normal/Reverse setting 1	00F9H	40250	41250	Word	0: rv-- (heat (reverse) / cool (none)) 1: no-- (heat (normal) / cool (none)) 2: rvno (heat (reverse) / cool (normal)) 3: norv (heat (normal) / cool (reverse)) 4: rvrv (heat (reverse) / cool (reverse)) 5: nono (heat (normal) / cool (normal))	rv--/rvno (single/dual)		
"Sv2"	Sv2	SV set value 2	00FAH	40251	41251	Word	0% to 100% FS	0% FS		○
"P2"	P2	Proportional band 2	00FBH	40252	41252	Word	0 to 9999 (0.0 to 999.9%)	5.0%		
"i2"	i2	Integration time 2	00FCH	40253	41253	Word	0 to 32000 (0 to 3200sec)	240 sec		
"d2"	d2	Derivation time	00FDH	40254	41254	Word	0 to 9999 (0.0 to 999.9sec)	60.0sec		
"hYS2"	hYS2	ON/OFF control hysteresis 2	00FEH	40255	41255	Word	0% to 50% FS	1°C		○
"CoL2"	CoL2	Cooling proportional band 2	00FFH	40256	41256	Word	0 to 1000 (0.0 to 100.0)	1.0		
"db2"	db2	Dead band 2	0100H	40257	41257	Word	-5000 to 5000 (-50.0 to 50.0%)	0%		
"bAL2"	bAL2	Output convergence value 2	0101H	40258	41258	Word	-10000 to 10000 (-100.0 to 100.0%)	0/50 (single/dual)		
"Ar2"	Ar2	Anti-reset windup 2	0102H	40259	41259	Word	0% to 100% FS	100% FS		○
"rEv2"	rEv2	Normal/Reverse setting 2	0103H	40260	41260	Word	0: rv-- (heat (reverse) / cool (none)) 1: no-- (heat (normal) / cool (none)) 2: rvno (heat (reverse) / cool (normal)) 3: norv (heat (normal) / cool (reverse)) 4: rvrv (heat (reverse) / cool (reverse)) 5: nono (heat (normal) / cool (normal))	rv--/rvno (single/dual)		
"Sv3"	Sv3	SV set value 3	0104H	40261	41261	Word	0% to 100% FS	0% FS		○
"P3"	P3	Proportional band 3	0105H	40262	41262	Word	0 to 9999 (0.0 to 999.9%)	5.0%		

Parameter display	Parameter name	Contents	Relative address	Resistor Number		Type	Read data	Written data range	Factory Setting	Dependent on range
				Internal	Engineering unit					
"i3"	i3	Integration time 3	0106 <sub>H</sub>	40263	41263	Word	0 to 32000 (0 to 3200sec)	240 sec		
"d3"	d3	Derivation time 3	0107 <sub>H</sub>	40264	41264	Word	0 to 9999 (0.0 to 999.9sec)	60.0 sec		
"hYS3"	hYS3	ON/OFF control hysteresis 3	0108 <sub>H</sub>	40265	41265	Word	0% to 50% FS	1°C		○
"CoL3"	CoL3	Cooling proportional band 3	0109 <sub>H</sub>	40266	41266	Word	0 to 1000 (0.0 to 100.0)	1.0		
"db3"	db3	Dead band 3	010A <sub>H</sub>	40267	41267	Word	-5000 to 5000 (-50.0 to 50.0%)	0%		
"bAL3"	bAL3	Output convergence value 3	010B <sub>H</sub>	40268	41268	Word	-10000 to 10000 (-100.0 to 100.0%)	0/50 (single/dual)		
"Ar3"	Ar3	Anti-reset windup 3	010C <sub>H</sub>	40269	41269	Word	0% to 100% FS	100% FS		○
"rEv3"	rEv3	Normal/Reverse setting 3	010D <sub>H</sub>	40270	41270	Word	0: rv-- (heat (reverse) / cool (none)) 1: no-- (heat (normal) / cool (none)) 2: rvno (heat (reverse) / cool (normal)) 3: norv (heat (normal) / cool (reverse)) 4: rrvv (heat (reverse) / cool (reverse)) 5: nono (heat (normal) / cool (normal))	rv--/rvno (single/dual)		
"Sv4"	Sv4	SV set value 4	010E <sub>H</sub>	40271	41271	Word	0% to 100% FS	0% FS		○
"P4"	P4	Proportional band 4	010F <sub>H</sub>	40272	41272	Word	0 to 9999 (0.0 to 999.9%)	5.0%		
"i4"	i4	Integration time 4	0110 <sub>H</sub>	40273	41273	Word	0 to 32000 (0 to 3200sec)	240 sec		
"d4"	d4	Derivation time 4	0111 <sub>H</sub>	40274	41274	Word	0 to 9999 (0.0 to 999.9sec)	60.0sec		
"hYS4"	hYS4	ON/OFF control hysteresis 4	0112 <sub>H</sub>	40275	41275	Word	0% to 50% FS	1°C		○
"CoL4"	CoL4	Cooling proportional band 4	0113 <sub>H</sub>	40276	41276	Word	0 to 1000 (0.0 to 100.0)	1.0		
"db4"	db4	Dead band 4	0114 <sub>H</sub>	40277	41277	Word	-5000 to 5000 (-50.0 to 50.0%)	0%		
"bAL4"	bAL4	Output convergence value 4	0115 <sub>H</sub>	40278	41278	Word	-10000 to 10000 (-100.0 to 100.0%)	0/50 (single/dual)		
"Ar4"	Ar4	Anti-reset windup 4	0116 <sub>H</sub>	40279	41279	Word	0% to 100% FS	100% FS		○
"rEv4"	rEv4	Normal/Reverse setting 4	0117 <sub>H</sub>	40280	41280	Word	0: rv-- (heat (reverse) / cool (none)) 1: no-- (heat (normal) / cool (none)) 2: rvno (heat (reverse) / cool (normal)) 3: norv (heat (normal) / cool (reverse)) 4: rrvv (heat (reverse) / cool (reverse)) 5: nono (heat (normal) / cool (normal))	rv--/rvno (single/dual)		
"Sv5"	Sv5	SV set value 5	0118 <sub>H</sub>	40281	41281	Word	0% to 100% FS	0% FS		○
"P5"	P5	Proportional band 5	0119 <sub>H</sub>	40282	41282	Word	0 to 9999 (0.0 to 999.9%)	5.0%		
"i5"	i5	Integration time 5	011A <sub>H</sub>	40283	41283	Word	0 to 32000 (0 to 3200sec)	240 sec		
"d5"	d5	Derivation time 5	011B <sub>H</sub>	40284	41284	Word	0 to 9999 (0.0 to 999.9sec)	60.0sec		
"hYS5"	hYS5	ON/OFF control hysteresis 5	011C <sub>H</sub>	40285	41285	Word	0% to 50% FS	1°C		○
"CoL5"	CoL5	Cooling proportional band 5	011D <sub>H</sub>	40286	41286	Word	0 to 1000 (0.0 to 100.0)	1.0		
"db5"	db5	Dead band 5	011E <sub>H</sub>	40287	41287	Word	-5000 to 5000 (-50.0 to 50.0%)	0%		

Parameter display	Parameter name	Contents	Relative address	Resistor Number		Type	Read data	Written data range	Factory Setting	Dependent on range
				Internal	Engineering unit					
"bAL5"	bAL5	Output convergence value 5	011FH	40288	41288	Word	-10000 to 10000 (-100.0 to 100.0%)	0/50 (single/dual)		
"Ar5"	Ar5	Anti-reset windup 5	0120H	40289	41289	Word	0% to 100% FS	100% FS		○
"rEv5"	rEv5	Normal/Reverse setting 5	0121H	40290	41290	Word	0: rv-- (heat (reverse) / cool (none)) 1: no-- (heat (normal) / cool (none)) 2: rvno (heat (reverse) / cool (normal)) 3: norv (heat (normal) / cool (reverse)) 4: rvrv (heat (reverse) / cool (reverse)) 5: nono (heat (normal) / cool (normal))	rv--/rvno (single/dual)		
"Sv6"	Sv6	SV set value 6	0122H	40291	41291	Word	0% to 100% FS	0% FS		○
"P6"	P6	Proportional band 6	0123H	40292	41292	Word	0 to 9999 (0.0 to 999.9%)	5.0%		
"i6"	i6	Integration time 6	0124H	40293	41293	Word	0 to 32000 (0 to 3200sec)	240 sec		
"d6"	D6	Derivation time 6	0125H	40294	41294	Word	0 to 9999 (0.0 to 999.9sec)	60.0sec		
"hYS6"	hYS6	ON/OFF control hysteresis 6	0126H	40295	41295	Word	0% to 50% FS	1°C		○
"CoL6"	CoL6	Cooling proportional band 6	0127H	40296	41296	Word	0 to 1000 (0.0 to 100.0)	1.0		
"db6"	db6	Dead band 6	0128H	40297	41297	Word	-5000 to 5000 (-50.0 to 50.0%)	0%		
"bAL6"	bAL6	Output convergence value 6	0129H	40298	41298	Word	-10000 to 10000 (-100.0 to 100.0%)	0/50 (single/dual)		
"Ar6"	Ar6	Anti-reset windup 6	012AH	40299	41299	Word	0% to 100% FS	100% FS		○
"rEv6"	rEv6	Normal/Reverse setting 6	012BH	40300	41300	Word	0: rv-- (heat (reverse) / cool (none)) 1: no-- (heat (normal) / cool (none)) 2: rvno (heat (reverse) / cool (normal)) 3: norv (heat (normal) / cool (reverse)) 4: rvrv (heat (reverse) / cool (reverse)) 5: nono (heat (normal) / cool (normal))	rv--/rvno (single/dual)		
"Sv7"	Sv7	SV set value 7	012CH	40301	41301	Word	0% to 100% FS	0% FS		○
"P7"	P7	Proportional band 7	012DH	40302	41302	Word	0 to 9999 (0.0 to 999.9%)	5.0%		
"i7"	i7	Integration time 7	012EH	40303	41303	Word	0 to 32000 (0 to 3200sec)	240 sec		
"d7"	d7	Derivation time 7	012FH	40304	41304	Word	0 to 9999 (0.0 to 999.9sec)	60.0sec		
"hYS7"	hYS7	ON/OFF control hysteresis7	0130H	40305	41305	Word	0% to 50% FS	1°C		○
"CoL7"	CoL7	Cooling proportional band 7	0131H	40306	41306	Word	0 to 1000 (0.0 to 100.0)	1.0		
"db7"	db7	Dead band 7	0132H	40307	41307	Word	-5000 to 5000 (-50.0 to 50.0%)	0%		
"bAL7"	bAL7	Output convergence value 7	0133H	40308	41308	Word	-10000 to 10000 (-100.0 to 100.0%)	0/50 (single/dual)		
"Ar7"	Ar7	Anti-reset windup 7	0134H	40309	41309	Word	0% to 100% FS	100% FS		○



Parameter display	Parameter name	Contents	Relative address	Resistor Number		Type	Read data	Written data range	Factory Setting	Dependent on range
				Internal	Engineering unit					
"rEv7"	rEv7	Normal/Reverse setting 7	0135 <sub>H</sub>	40310	41310	Word	0: rv-- (heat (reverse) / cool (none)) 1: no-- (heat (normal) / cool (none)) 2: rvno (heat (reverse) / cool (normal)) 3: norv (heat (normal) / cool (reverse)) 4: rvrv (heat (reverse) / cool (reverse)) 5: nono (heat (normal) / cool (normal))	rv--/rvno (single/dual)		
"SvMH"	SvMX	Selectable SV numbers maximum	00DF <sub>H</sub>	40224	41224	Word	0: Sv0 (Local SV) 1: Sv1 (SV = SV-1) 2: Sv2 (SV = SV-2) 3: Sv3 (SV = SV-3) 4: Sv4 (SV = SV-4) 5: Sv5 (SV = SV-5) 6: Sv6 (SV = SV-6) 7: Sv7 (SV = SV-7) 8: di : SV = choose Di	Sv7		
"PL #"	PL1M	Selectable PID group maximum	00E0 <sub>H</sub>	40225	41225	Word	0: Pid0 (PID group local) 1: Pid1 (PID group No. 1) 2: Pid2 (PID group No. 2) 3: Pid3 (PID group No. 3) 4: Pid4 (PID group No. 4) 5: Pid5 (PID group No. 5) 6: Pid6 (PID group No. 6) 7: Pid7 (PID group No. 7) 8: di (PID group Di selection)	Pid7		

## Ramp/Soak (Ch4)

Parameter display	Parameter name	Contents	Relative address	Resistor Number		Type	Read data	Written data range	Factory Setting	Dependent on range
				Internal	Engineering unit					
"Pfn"	PTn	Ramp/Soak Activation Pattern	0230H	40561	41561	Word	0 (uses steps 1 to 4) 1 (uses steps 5 to 8) 2 (uses steps 1 to 8) 3 (uses steps 9 to 12) 4 (uses steps 13 to 16) 5 (uses steps 9 to 16) 6 (uses steps 1 to 16) 7 (according to DI)		6	
"fTnU"	TiMU	Ramp/soak time units	0231H	40562	41562	Word	0 : hh.MM ( hour: min) 1 : MM.SS (min: sec)		hh.MM	
"Sv-1"	Sv-1	Ramp/Soak 1 seg/SV Set Value	0244H	40581	41581	Word	0% to 100% FS		0% FS	○
"fTn1r"	TM1r	Ramp/Soak 1 seg ramp time	0245H	40582	41582	Word	00.00-99.59 (hour:min/min: sec)		00.00 (hour:min)	
"fTn1S"	TM1S	Ramp/Soak 1 seg soak time	0246H	40583	41583	Word	00.00-99.59 (hour:min/min: sec)		00.00 (hour:min)	
"Sv-2"	Sv-2	Ramp/Soak 2 seg/SV Set Value	0247H	40584	41584	Word	0% to 100% FS		0% FS	○
"fTn2r"	TM2r	Ramp/Soak 2 seg ramp time	0248H	40585	41585	Word	00.00-99.59 (hour:min/min: sec)		00.00 (hour:min)	
"fTn2S"	TM2S	Ramp/Soak 2 seg soak time	0249H	40586	41586	Word	00.00-99.59 (hour:min/min: sec)		00.00 (hour:min)	
"Sv-3"	Sv-3	Ramp/Soak 3 seg/SV Set Value	024AH	40587	41587	Word	0% to 100% FS		0% FS	○
"fTn3r"	TM3r	Ramp/Soak 3 seg ramp time	024BH	40588	41588	Word	00.00-99.59 (hour:min/min: sec)		00.00 (hour:min)	
"fTn3S"	TM3S	Ramp/Soak 3 seg soak time	024CH	40589	41589	Word	00.00-99.59 (hour:min/min: sec)		00.00 (hour:min)	
"Sv-4"	Sv-4	Ramp/Soak 4 seg/SV Set Value	024DH	40590	41590	Word	0% to 100% FS		0% FS	○
"fTn4r"	TM4r	Ramp/Soak 4 seg ramp time	024EH	40591	41591	Word	00.00-99.59 (hour:min/min: sec)		00.00 (hour:min)	
"fTn4S"	TM4S	Ramp/Soak 4 seg soak time	024FH	40592	41592	Word	00.00-99.59 (hour:min/min: sec)		00.00 (hour:min)	
"Sv-5"	Sv-5	Ramp/Soak 5 seg/SV Set Value	0250H	40593	41593	Word	0% to 100% FS		0% FS	○
"fTn5r"	TM5r	Ramp/Soak 5 seg ramp time	0251H	40594	41594	Word	00.00-99.59 (hour:min/min: sec)		00.00 (hour:min)	
"fTn5S"	TM5S	Ramp/Soak 5 seg soak time	0252H	40595	41595	Word	00.00-99.59 (hour:min/min: sec)		00.00 (hour:min)	
"Sv-6"	Sv-6	Ramp/Soak 6 seg/SV Set Value	0253H	40596	41596	Word	0% to 100% FS		0% FS	○
"fTn6r"	TM6r	Ramp/Soak 6 seg ramp time	0254H	40597	41597	Word	00.00-99.59 (hour:min/min: sec)		00.00 (hour:min)	
"fTn6S"	TM6S	Ramp/Soak 6 seg soak time	0255H	40598	41598	Word	00.00-99.59 (hour:min/min: sec)		00.00 (hour:min)	
"Sv-7"	Sv-7	Ramp/Soak 7 seg/SV Set Value	0256H	40599	41599	Word	0% to 100% FS		0% FS	○
"fTn7r"	TM7r	Ramp/Soak 7 seg ramp time	0257H	40600	41600	Word	00.00-99.59 (hour:min/min: sec)		00.00 (hour:min)	
"fTn7S"	TM7S	Ramp/Soak 7 seg soak time	0258H	40601	41601	Word	00.00-99.59 (hour:min/min: sec)		00.00 (hour:min)	

Parameter display	Parameter name	Contents	Relative address	Resistor Number		Type	Read data	Written data range	Factory Setting	Dependent on range
				Internal	Engineering unit					
"Sv-8"	Sv-8	Ramp/Soak 8 seg/SV Set Value	0259H	40602	41602	Word	0% to 100% FS		0% FS	○
"r78r"	TM8r	Ramp/Soak 8 seg ramp time	025AH	40603	41603	Word	00.00-99.59 (hour:min/min: sec)		00.00 (hour:min)	
"r78S"	TM8S	Ramp/Soak 8 seg soak time	025BH	40604	41604	Word	00.00-99.59 (hour:min/min: sec)		00.00 (hour:min)	
"Sv-9"	Sv-9	Ramp/Soak 9 seg/SV Set Value	025CH	40605	41605	Word	0% to 100% FS		0% FS	○
"r79r"	TM9r	Ramp/Soak 9 seg ramp time	025DH	40606	41606	Word	00.00-99.59 (hour:min/min: sec)		00.00 (hour:min)	
"r79S"	TM9S	Ramp/Soak 9 seg soak time	025EH	40607	41607	Word	00.00-99.59 (hour:min/min: sec)		00.00 (hour:min)	
"Sv 10"	Sv10	Ramp/Soak 10 seg/SV Set Value	025FH	40608	41608	Word	0% to 100% FS		0% FS	○
"r 10r"	T10r	Ramp/Soak 10 seg ramp time	0260H	40609	41609	Word	00.00-99.59 (hour:min/min: sec)		00.00 (hour:min)	
"r 10S"	T10S	Ramp/Soak 10 seg soak time	0261H	40610	41610	Word	00.00-99.59 (hour:min/min: sec)		00.00 (hour:min)	
"Sv 11"	Sv11	Ramp/Soak 11 seg/SV Set Value	0262H	40611	41611	Word	0% to 100% FS		0% FS	○
"r 11r"	T11r	Ramp/Soak 11 seg ramp time	0263H	40612	41612	Word	00.00-99.59 (hour:min/min: sec)		00.00 (hour:min)	
"r 11S"	T11S	Ramp/Soak 11 seg soak time	0264H	40613	41613	Word	00.00-99.59 (hour:min/min: sec)		00.00 (hour:min)	
"Sv 12"	Sv12	Ramp/Soak 12 seg/SV Set Value	0265H	40614	41614	Word	0% to 100% FS		0% FS	○
"r 12r"	T12r	Ramp/Soak 12 seg ramp time	0266H	40615	41615	Word	00.00-99.59 (hour:min/min: sec)		00.00 (hour:min)	
"r 12S"	T12S	Ramp/Soak 12 seg soak time	0267H	40616	41616	Word	00.00-99.59 (hour:min/min: sec)		00.00 (hour:min)	
"Sv 13"	Sv13	Ramp/Soak 13 seg/SV Set Value	0268H	40617	41617	Word	0% to 100% FS		0% FS	○
"r 13r"	T13r	Ramp/Soak 13 seg ramp time	0269H	40618	41618	Word	00.00-99.59 (hour:min/min: sec)		00.00 (hour:min)	
"r 13S"	T13S	Ramp/Soak 13 seg soak time	026AH	40619	41619	Word	00.00-99.59 (hour:min/min: sec)		00.00 (hour:min)	
"Sv 14"	Sv14	Ramp/Soak 14 seg/SV Set Value	026BH	40620	41620	Word	0% to 100% FS		0% FS	○
"r 14r"	T14r	Ramp/Soak 14 seg ramp time	026CH	40621	41621	Word	00.00-99.59 (hour:min/min: sec)		00.00 (hour:min)	
"r 14S"	T14S	Ramp/Soak 14 seg soak time	026DH	40622	41622	Word	00.00-99.59 (hour:min/min: sec)		00.00 (hour:min)	
"Sv 15"	Sv15	(Ramp/Soak 15 seg/SV Set Value)	026EH	40623	41623	Word	0% to 100% FS		0% FS	○
"r 15r"	T15r	Ramp/Soak 15 seg ramp time	026FH	40624	41624	Word	00.00-99.59 (hour:min/min: sec)		00.00 (hour:min)	
"r 15S"	T15S	Ramp/Soak 15 seg soak time	0270H	40625	41625	Word	00.00-99.59 (hour:min/min: sec)		00.00 (hour:min)	
"Sv 16"	Sv16	Ramp/Soak 16 seg/SV Set Value	0271H	40626	41626	Word	0% to 100% FS		0% FS	○
"r 16r"	T16r	Ramp/Soak 16 seg ramp time	0272H	40627	41627	Word	00.00-99.59 (hour:min/min: sec)		00.00 (hour:min)	

Parameter display	Parameter name	Contents	Relative address	Resistor Number		Type	Read data	Written data range	Factory Setting	Dependent on range
				Internal	Engineering unit					
"f 165"	T16S	Ramp/Soak 16 seg soak time	0273 <sub>H</sub>	40628	41628	Word	00.00-99.59 (hour:min/min: sec)	00.00 (hour:min)		
"Mod"	Mod	Ramp/soak mode	0050 <sub>H</sub>	40081	41081	Word	0 to 15	0		
"GSok"	GSok	Guaranty soak ON/OFF	023A <sub>H</sub>	40571	41571	Word	0:oFF (guaranty soak off) 1:on (guaranty soak on)	oFF		
"GS-L"	GS-L	Guaranty soak (lower limit)	023B <sub>H</sub>	40572	41572	Word	0% to 50% FS	5°C		○
"GS-h"	GS-h	Guaranty soak (upper limit)	023C <sub>H</sub>	40573	41573	Word	0% to 50% FS	5°C		○
"PvST"	PvST	PV start	023D <sub>H</sub>	40574	41574	Word	0:oFF (Not. PV start) 1:oN (PV start)	oFF		
"ConT"	ConT	Restore mode	023E <sub>H</sub>	40575	41575	Word	0:rES (Reset) 1:Con (Continue) 2:ini (Restart)	rES		
"PTnM"	PTnM	Sets the max pattern selection	0233 <sub>H</sub>	40564	41564	Word	0 to 7 (0 to 6 and di)	6		
"PMin"	PMin	Sets the min pattern selection	0234 <sub>H</sub>	40565	41565	Word	0 to 7 (0 to 6 and di)	0		

## Setup (Ch6)

Parameter display	Parameter name	Contents	Relative address	Resistor Number		Type	Read data	Written data range	Factory Setting	Dependent on range
				Internal	Engineering unit					
"P <sub>UV</sub> "	PvT	PV input type	000FH	40016	41016	Word	0 (JPT 100'3f) 1 (PT 100'3f) 2 (J) 3 (K) 4 (R) 5 (B) 6 (S) 7 (T) 8 (E) 9 (no function) 10 (no function) 11 (no function) 12 (N) 13 (PL- 2) 14 (no function) 15 (0V to 5V / 0mA to 20mA) 16 (1V to 5V/4mA to 20mA) 17 (0mV to 10V) 18 (2V to 10V) 19 (0mV to 100mV)	3 (K)		
"P <sub>Ub</sub> "	Pvb	PV input lower limit	0011H	40018	41018	Word	-1999-9999	0°C		
"P <sub>UF</sub> "	PvF	PV input upper limit	0012H	40019	41019	Word	-1999-9999	400°C		
"P <sub>Ud</sub> "	Pvd	Decimal position	0013H	40020	41020	Word	0 (no decimal point) 1 (one decimal place) 2 (two decimal places)	0		
"P <sub>U</sub> "	PvU	Unit display	0010H	40345	41345	Word	0: °C 1: °F	0		
"P <sub>UoF</sub> "	PvoF	PV input shift	000DH	40014	41014	Word	-10% to 10% FS	0% FS		
"S <sub>UoF</sub> "	SvoF	Sv shift	000EH	40015	41015	Word	-5000 to 5000 (-50.00% to 50.00% FS)			
"FF"	TF	PV input filter	0015H	40022	41022	Word	0 to 1200 (0.0 to 120.0 sec)	5 sec		
"AdJ0"	AdJ0	PV display zero adjustment	0062H	40099	41099	Word	-50% to 50% FS		○	
"AdJS"	AdJS	PV display Splan adjustment	0063H	40100	41100	Word	-50% to 50% FS		○	
"rCJ"	rCJ	Cold Junction Compensation	0016H	40023	41023	Word	0: oFF (off) 1: on (on)	on		
"rEM0"	rEM0	RSV zero adjustment	0075H	40118	41118	Word	-50% to 50% FS	0%FS		
"rEMS"	rEMS	RSV span adjustment	0076H	40119	41119	Word	-50% to 50% FS	0%		
"rEMr"	rEMr	RSV Input Range	0165H	40358	41358	Word	0: 0-5v (0V to 5V) 1: 1-5v (1V to 5V)	1-5		
"rTF"	rTF	RSV input filter	0166H	40359	41359	Word	0.0 sec to 120.0 sec	0.0 sec		
"C1r"	C1r	OUT1 range	017CH	40381	41381	Word	0: 0-5v (0V to 5V) 1: 1-5v (1V to 5V) 2: 0 to 10 (0V to 10V) 3: 2 to 10 (2V to 10V) 4: 0 to 20 (0mA to 20mA) 5: 4 to 20 (4mA to 20mA)	0 to 10 (voltage) 4 to 20 (current)		
"C2r"	C2r	OUT2 range	017DH	40382	41382	Word	0: 0-5v (0V to 5V) 1: 1-5v (1V to 5V) 2: 0 to 10 (0V to 10V) 3: 2 to 10 (2V to 10V) 4: 0 to 20 (0mA to 20mA) 5: 4 to 20 (4mA to 20mA)	0 to 10 (voltage) 4 to 20 (current)		

Parameter display	Parameter name	Contents	Relative address	Resistor Number		Type	Read data	Written data range	Factory Setting	Dependent on range
				Internal	Engineering unit					
"FLo1"	FLo1	Output 1 set value during FALT	0185 <sub>H</sub>	40390	41390	Word	-300 to 10300 (-3.00 to 103.00%)			
"FLo2"	FLo2	Output 2 set value during FALT	0186 <sub>H</sub>	40391	41391	Word	-300 to 10300 (-3.00 to 103.00%)			
"SFo1"	SFo1	Soft start OUT1 set value	0187 <sub>H</sub>	40392	41392	Word	-300 to 10300 (-3.00 to 103.00%)			
"SFTM"	SFTM	Soft start set time	0189 <sub>H</sub>	40394	41394	Word	00:00 to 99:59 (hour:min)		00:00 (hour:min)	
"Sbo1"	Sbo1	During standby, OUT1 set value	018D <sub>H</sub>	40398	41398	Word	-300 to 10300 (-3.00 to 103.00%)			
"Sbo2"	Sbo2	During standby, OUT2 set value	018E <sub>H</sub>	40399	41399	Word	-300 to 10300 (-3.00 to 103.00%)			
"SbMd"	SbMd	Standby mode setting	018F <sub>H</sub>	40400	41400	Word	0 to 7		0	
"AoT"	AoT	Types of AO output	0071 <sub>H</sub>	40114	41114	Word	0: PV 1: SV 2: MV 3: DV		PV	
"AoL"	AoL	AO lower limit scaling	0072 <sub>H</sub>	40115	41115	Word	-100% to 100%FS		0%	
"Aoh"	Aoh	AO upper limit scaling	0073 <sub>H</sub>	40116	41116	Word	-100% to 100%FS		100%	

## System (Ch7)

Parameter display	Parameter name	Contents	Relative address	Resistor Number		Type	Read data	Written data range	Factory Setting	Dependent on range
				Internal	Engineering unit					
"UKEY"	UKEY	USER key assignment settings	008C <sub>H</sub>	40141	41141	Word	0 (no function) 1 (Switches between STBY ON/OFF) 2 (Switches between Auto/Manual) 3 (Switches between Local/Remote) 4 (no function) 5 (Starts AT (standard)) 6 (Starts AT (low PV)) 7 (no function) 8 (Ramp SV HOLD) 9 (Ramp/soak RUN/OFF) 10 (Ramp/soak RUN/HOLD) 11 (no function) 12 (Latch cancel (all)) 13 (Latch cancel (DO1)) 14 (Latch cancel (DO2)) 15 (Latch cancel (DO3)) 16 (Latch cancel (DO4)) 17 (Latch cancel (DO5)) 18 (Start timer (DO1)) 19 (Start timer (DO2)) 20 (Start timer (DO3)) 21 (Start timer (DO4)) 22 (Start timer (DO5)) 23 (SV No. + 1 (send)) 24 (PID No. + 1 (send)) 25 (no function) 26 (Ramp/soak Pattern No. + 1 (send)) 27 (SV No. + 1, PID No. + 1 (send))		2	

Parameter display	Parameter name	Contents	Relative address	Resistor Number		Type	Read data	Written data range	Factory Setting	Dependent on range
				Internal	Engineering unit					
"dL1"	di1	DI-1 function select	008EH	40143	41143	Word	0 (no function) 1 (Switches between STBY ON/OFF) 2 (Switches between Auto/Manual) 3 (Switches between Local/Remote) 4 (Switches EXMV1) 5 (no function) 6 (Starts AT (standard)) 7 (Starts AT (low PV)) 8 (no function) 9 (no function) 10 (Ramp SV ON/OFF) 11 (Ramp SV HOLD) 12 (Ramp/soak OFF) 13 (Ramp/soak RUN/HOLD) 14 (no function) 15 (Latch cancel (all)) 16 (Latch cancel (DO1)) 17 (Latch cancel (DO2)) 18 (Latch cancel (DO3)) 19 (Latch cancel (DO4)) 20 (Latch cancel (DO5)) 21 (Start timer (DO1)) 22 (Start timer (DO2)) 23 (Start timer (DO3)) 24 (Start timer (DO4)) 25 (Start timer (DO5)) 26 (SV No. 1) 27 (SV No. 2) 28 (SV No. + 4) 29 (PID No. +1) 30 (PID No. +2) 31 (PID No. + 4) 32 (no function) 33 (no function) 34 (no function) 35 (SV No.+1, PID No. +1) 36 (SV No.+2, PID No. +2) 37 (SV No.+4, PID No. +4) 38 (Pattern No.+1) 39 (Pattern No.+2) 40 (Pattern No.+4) 41 (DI Soft start) 42 (Ramp soak RUN) 43 (Ramp soak HOLD) 44 (Ramp soak RUN at DO1 startup) 45 (Ramp soak RUN at DO2 startup) 46 (Ramp soak RUN at DO3 startup) 47 (Ramp soak RUN at DO4 startup) 48 (Ramp soak RUN at DO5 startup)	0		
"dL2"	di2	DI-2 function select	008FH	40144	41144	Word	Same as above	0		
"dL3"	di3	DI-3 function select	0090H	40145	41145	Word	Same as above	0		
"dL4"	di4	DI-4 function select	0091H	40146	41146	Word	Same as above	0		
"dL5"	di5	DI-5 function select	0092H	40147	41147	Word	Same as above	0		
"do1f"	do1T	DO1 output event type setting	0028H	40041	41041	Word	0-102	0		
"doP1"	doP1	Sets DO1 option function	00A5H	40166	41166	Word	0000 to 1111	0		
"do2f"	do2T	DO2 output event type setting	0029H	40042	41042	Word	0 to 102	0		
"doP2"	doP2	DO5 option function setting	00ACH	40173	41173	Word	0000 to 1111	0		
"do3f"	do3T	DO3 output event type setting	002AH	40043	41043	Word	0 to 102	0		

Parameter display	Parameter name	Contents	Relative address	Resistor Number		Type	Read data	Written data range	Factory Setting	Dependent on range
				Internal	Engineering unit					
"doP3"	doP3	DO3 option function setting	00B3H	40180	41180	Word	0000 to 1111		0	
"do4I"	do4T	DO4 output event type setting	00B6H	40183	41183	Word	0 to 102		0	
"doP4"	doP4	DO4 option function setting	00BAH	40187	41187	Word	0000 to 1111		0	
"do5I"	do5T	DO5 output event type setting	00BDH	40190	41190	Word	0 to 102		0	
"doP5"	doP5	DO5 option function setting	00C1H	40194	41194	Word	0000 to 1111		0	
"rMP"	rMP	Ramp SV effect/no effect	01ACH	40429	41429	Word	oFF:no effect   ON:effect		on	
"rMPL"	rMPL	Ramp SV - Decline	01ACH	40430	41430	Word	0% to 100% FS/°C		0°C	○
"rMPH"	rMPH	Ramp SV - Incline	01ADH	40431	41431	Word	0% to 100% FS/°C		0°C	○
"rMPU"	rMPU	Ramp SV slope time unit	01AFH	40432	41432	Word	0: hour (slope temperature/hour) 1: Min (slope temperature/min)		hoUr	
"SvT"	SvT	Ramp SV - SV display mode selection	01B0H	40433	41433	Word	0: rMP (Ramp SV HOLD) 1: TrG (target SV)		rMP	
"CTrL"	CTrL	Control methods	0001H	40002	41002	Word	0: PiD (PID control) 1: FUZY (Fuzzy Pid control) 2: SELF (Self-tuning control) 3: PiD2 (Pid2 control)			
"PrCS"	PrCS	Control target	01A7H	40424	41424	Word	0: SRV1 (Servo control 1) 1: SRV2 (Servo control 2) 2: PFb (Position feedback control)		PFb/Srv1 (PFb on/PFb off)	
"STMd"	STMd	Startup mode	01B1H	40434	41434	Word	0: Auto (starts up in auto mode) 1: MAn (starts up in manual mode) 2: Rem (start in the remote mode) 3: STby (start in the standby mode)		Auto	

### Alarm (Ch8)

Parameter display	Parameter name	Contents	Relative address	Resistor Number		Type	Read data	Written data range	Factory Setting	Dependent on range
				Internal	Engineering unit					
"A1hY"	A1hY	ALM1 hysteresis	0031H	40050	41050	Word	0% to 50% FS		1°C	○
"dLY1"	dLY1	ALM1 delay	0034H	40053	41053	Word	0-9999 [sec/min]		0	
"dL1U"	dL1U	ALM1 delay time units	00A7H	40168	41168	Word	0: sec 1: Min			
"A2hY"	A2hY	ALM2 hysteresis	0032H	40051	41051	Word	0% to 50% FS		1°C	○
"dLY2"	dLY2	ALM2 delay	0035H	40054	41054	Word	0 to 9999 [sec/min]		0	
"dL2U"	dL2U	ALM2 delay time units	00AEH	40175	41175	Word	0: sec 1: Min			
"A3hY"	A3hY	ALM3 hysteresis	0033H	40052	41052	Word	0% to 50% FS		1°C	○
"dLY3"	dLY3	ALM3 delay	0036H	40055	41055	Word	0 to 9999 [sec/min]		0	
"dL3U"	dL3U	ALM3 delay time units	00B5H	40182	41182	Word	0: sec 1: Min			
"A4hY"	A4hY	ALM4 hysteresis	00B9H	40186	41186	Word	0% to 50% FS		1°C	○
"dLY4"	dLY4	ALM4 delay	00BBH	40188	41188	Word	0 to 9999 [sec/min]		0	
"dL4U"	dL4U	ALM4 delay time units	00BCH	40189	41189	Word	0: sec 1: Min			
"A5hY"	A5hY	ALM5 hysteresis	00C0H	40193	41193	Word	0% to 50% FS		1°C	○
"dLY5"	dLY5	ALM5 delay	00C2H	40195	41195	Word	0 to 9999 [sec/min]		0	



Parameter display	Parameter name	Contents	Relative address	Resistor Number		Type	Read data	Written data range	Factory Setting	Dependent on range
				Internal	Engineering unit					
"dL5U"	dL5U	ALM1 delay time units	00C3 <sub>H</sub>	40196	41196	Word	0: sec 1: Min			
"hb l"	hb1	HB Alarm Set Value	0026 <sub>H</sub>	40039	41039	Word	0 to 500 (0.0 to 50.0 (A))			
"hb lh"	hb1h	HB alarm hysteresis	00C5 <sub>H</sub>	40198	41198	Word	0 to 500 (0.0 to 50.0 (A))			
"hS l"	hS1	Load short-circuit alarm setting value	00C6 <sub>H</sub>	40199	41999	Word	0 to 500 (0.0 to 50.0 (A))		0.0A	
"hS lh"	hS1h	Load short-circuit alarm hysteresis	00C7 <sub>H</sub>	40200	41200	Word	0 to 500 (0.0 to 50.0 (A))		0.5A	
"LbTm"	LbTM	Loop break detection time	00CC <sub>H</sub>	40205	41205	Word	0 sec to 9999 sec		0 sec	
"LbAb"	LbAb	Loop break detection range	00CD <sub>H</sub>	40206	41206	Word	0 to 10000 (0% to 100% FS)		0 sec	○

### PFB (Ch10)

Parameter display	Parameter name	Contents	Relative address	Resistor Number		Type	Read data	Written data range	Factory Setting	Dependent on range
				Internal	Engineering unit					
"PGAP"	PGAP	PFB dead band	01A8 <sub>H</sub>	40425	41425	Word	0.0 to 100.0%		5%	○
"TrvL"	TrvL	Valve Stroke Time	01A9 <sub>H</sub>	40426	41426	Word	5 sec to 180 sec		30 sec	
"CAL"	CAL	PFB Input Adjustment Command	01AB <sub>H</sub>	40428	41428	Word	0 (none/forcible termination) 1 (zero adjustment) 2 (span adjustment) 3 (automatic adjustment)	0 (none/forcible termination) 1 (zero adjustment) 2 (span adjustment) 3 (automatic adjustment)	-	

### Password Setup (Ch11)

Parameter display	Parameter name	Contents	Relative address	Resistor Number		Type	Read data	Written data range	Factory Setting	Dependent on range
				Internal	Engineering unit					
"PAS1"	PAS1	Password1 setup	0209 <sub>H</sub>	40522	41522	Word	-32768 to 32767 (8000 to 7FFF)		0	
"PAS2"	PAS2	Password2 setup	020A <sub>H</sub>	40523	41523	Word	-32768 to 32767 (8000 to 7FFF)		0	
"PAS3"	PAS3	Password3 setup	020B <sub>H</sub>	40524	41524	Word	-32768 to 32767 (8000 to 7FFF)		0	

## Display (Ch12)

Parameter display	Parameter name	Contents	Relative address	Resistor Number		Type	Read data	Written data range	Factory Setting	Dependent on range
				Internal	Engineering unit					
"dP01"	dP01	Parameter display mask	01C2H	40451	41451	Word	-32768 to 32767 (8000 to 7FFF)		Different depending on model code.	
"dP02"	dP02	Parameter display mask	01C3H	40452	41452	Word	-32768 to 32767 (8000 to 7FFF)		Different depending on model code.	
"dP03"	dP03	Parameter display mask	01C4H	40453	41453	Word	-32768 to 32767 (8000 to 7FFF)		Different depending on model code.	
"dP04"	dP04	Parameter display mask	01C5H	40454	41454	Word	-32768 to 32767 (8000 to 7FFF)		Different depending on model code.	
"dP05"	dP05	Parameter display mask	01C6H	40455	41455	Word	-32768 to 32767 (8000 to 7FFF)		Different depending on model code.	
"dP06"	dP06	Parameter display mask	01C7H	40456	41456	Word	-32768 to 32767 (8000 to 7FFF)		Different depending on model code.	
"dP07"	dP07	Parameter display mask	01C8H	40457	41457	Word	-32768 to 32767 (8000 to 7FFF)		Different depending on model code.	
"dP08"	dP08	Parameter display mask	01C9H	40458	41458	Word	-32768 to 32767 (8000 to 7FFF)		Different depending on model code.	
"dP09"	dP09	Parameter display mask	01CAH	40459	41459	Word	-32768 to 32767 (8000 to 7FFF)		Different depending on model code.	
"dP10"	dP10	Parameter display mask	01CBH	40460	41460	Word	-32768 to 32767 (8000 to 7FFF)		Different depending on model code.	
"dP11"	dP11	Parameter display mask	01CCH	40461	41461	Word	-32768 to 32767 (8000 to 7FFF)		Different depending on model code.	
"dP12"	dP12	Parameter display mask	01CDH	40462	41462	Word	-32768 to 32767 (8000 to 7FFF)		Different depending on model code.	
"dP13"	dP13	Parameter display mask	01CEH	40463	41463	Word	-32768 to 32767 (8000 to 7FFF)		Different depending on model code.	
"dP14"	dP14	Parameter display mask	01CFH	40464	41464	Word	-32768 to 32767 (8000 to 7FFF)		Different depending on model code.	
"dP15"	dP15	Parameter display mask	01D0H	40465	41465	Word	-32768 to 32767 (8000 to 7FFF)		Different depending on model code.	
"dP16"	dP16	Parameter display mask	01D1H	40466	41466	Word	-32768 to 32767 (8000 to 7FFF)		Different depending on model code.	
"dP17"	dP17	Parameter display mask	01D2H	40467	41467	Word	-32768 to 32767 (8000 to 7FFF)		Different depending on model code.	
"dP18"	dP18	Parameter display mask	01D3H	40468	41468	Word	-32768 to 32767 (8000 to 7FFF)		Different depending on model code.	
"dP19"	dP19	Parameter display mask	01D4H	40469	41469	Word	-32768 to 32767 (8000 to 7FFF)		Different depending on model code.	
"dP20"	dP20	Parameter display mask	01D5H	40470	41470	Word	-32768 to 32767 (8000 to 7FFF)		Different depending on model code.	
"dP21"	dP21	Parameter display mask	01D6H	40471	41471	Word	-32768 to 32767 (8000 to 7FFF)		Different depending on model code.	
"dP22"	dP22	Parameter display mask	01D7H	40472	41472	Word	-32768 to 32767 (8000 to 7FFF)		Different depending on model code.	
"dP23"	dP23	Parameter display mask	01D8H	40473	41473	Word	-32768 to 32767 (8000 to 7FFF)		Different depending on model code.	
"dP24"	dP24	Parameter display mask	01D9H	40474	41474	Word	-32768 to 32767 (8000 to 7FFF)		Different depending on model code.	
"dP25"	dP25	Parameter display mask	01DAH	40475	41475	Word	-32768 to 32767 (8000 to 7FFF)		Different depending on model code.	

Parameter display	Parameter name	Contents	Relative address	Resistor Number		Type	Read data	Written data range	Factory Setting	Dependent on range
				Internal	Engineering unit					
"dP26"	dP26	Parameter display mask	01DB <sub>H</sub>	40476	41476	Word	-32768 to 32767 (8000 to 7FFF)		Different depending on model code.	
"dP27"	dP27	Parameter display mask	01DC <sub>H</sub>	40477	41477	Word	-32768 to 32767 (8000 to 7FFF)		Different depending on model code.	
"dP28"	dP28	Parameter display mask	01DD <sub>H</sub>	40478	41478	Word	-32768 to 32767 (8000 to 7FFF)		Different depending on model code.	
"dP29"	dP29	Parameter display mask	01DE <sub>H</sub>	40479	41479	Word	-32768 to 32767 (8000 to 7FFF)		Different depending on model code.	
"dP30"	dP30	Parameter display mask	01DF <sub>H</sub>	40480	41480	Word	-32768 to 32767 (8000 to 7FFF)		Different depending on model code.	

### Other

Parameter display	Parameter name	Contents	Relative address	Resistor Number		Type	Read data	Written data range	Factory Setting	Dependent on range
				Internal	Engineering unit					
SV	Front SV set value	Front SV set value	0002 <sub>H</sub>	40003	41003	Word	0 to 10000 (in the 0% to 100% FS set value limit)			○
			0082 <sub>H</sub>	40131	41131	Word				
MV	Front MV set value	Front MV set value	0079 <sub>H</sub>	40122	41122	Word	-300 to 10300 (-3.0 to 103.0%)			
			0083 <sub>H</sub>	40132	41132	Word				

## Resistor Number Order Read/Write Parameter List

Relative address	Resistor Number		Parameter contents
	Internal	Engineering unit	
0001 <sub>H</sub>	40002	41002	CTrL (control method)
0002 <sub>H</sub>	40003	41003	Front SV set value
0003 <sub>H</sub>	40004	41004	STbY (Switches between RUN and standby)
0004 <sub>H</sub>	40005	41005	AT (Auto-tuning run command)
0005 <sub>H</sub>	40006	41006	P (Proportional band)
0006 <sub>H</sub>	40007	41007	i (Integration time)
0007 <sub>H</sub>	40008	41008	d (Derivation time)
0008 <sub>H</sub>	40009	41009	hYS (ON/OFF control hysteresis)
0009 <sub>H</sub>	40010	41010	CoL (Cooling proportional band coefficient)
000A <sub>H</sub>	40011	41011	db (Dead band)
000B <sub>H</sub>	40012	41012	Ar (Anti-reset windup)
000C <sub>H</sub>	40013	41013	bAL (output convergence value)
000D <sub>H</sub>	40014	41014	PvoF (PV input shift)
000E <sub>H</sub>	40015	41015	SvoF (SV input shift)
000F <sub>H</sub>	40016	41016	PvT (PV input types)
0010 <sub>H</sub>	40017	41017	P-F (Unit display)
0011 <sub>H</sub>	40018	41018	Pvb (PV input lower limit)
0012 <sub>H</sub>	40019	41019	PvF (PV input upper limit)
0013 <sub>H</sub>	40020	41020	Pvd (decimal position)
0014 <sub>H</sub>	40021	41021	-
0015 <sub>H</sub>	40022	41022	TF (PV input filter)
0016 <sub>H</sub>	40023	41023	rCJ (Cold junction compensation)
0017 <sub>H</sub>	40024	41024	PCUT (Selects the output limiter type)
0018 <sub>H</sub>	40025	41025	PLC1 (OUT1 lower limit)
0019 <sub>H</sub>	40026	41026	PhC1 (OUT1 upper limit)
001A <sub>H</sub>	40027	41027	PLC2 (OUT2 lower limit)
001B <sub>H</sub>	40028	41028	PhC2 (OUT2 upper limit)
001E <sub>H</sub>	40031	41031	SvL (SV limit (lower))
001F <sub>H</sub>	40032	41032	Svh (SV limit (upper))
0026 <sub>H</sub>	40039	41039	hb1 (CT HB alarm set value)
0027 <sub>H</sub>	40040	41040	LoC (Key lock)
0028 <sub>H</sub>	40041	41041	do1T (DO1 output event type)
0029 <sub>H</sub>	40042	41042	do2T (DO2 output event type)
002A <sub>H</sub>	40043	41043	do3T (DO3 output event type)
002B <sub>H</sub>	40044	41044	AL1 (ALM1 set value) or A1-L
002C <sub>H</sub>	40045	41045	AL2 (ALM2 set value) or A2-L
002D <sub>H</sub>	40046	41046	AL3 (ALM3 set value) or A3-L
002E <sub>H</sub>	40047	41047	A1-h (Alarm 1 upper limit set value)
002F <sub>H</sub>	40048	41048	A2-h (Alarm 2 upper limit set value)
0030 <sub>H</sub>	40049	41049	A3-h (Alarm 3 upper limit set value)
0031 <sub>H</sub>	40050	41050	A1hY (ALM1 hysteresis)
0032 <sub>H</sub>	40051	41051	A2hY (ALM2 hysteresis)
0033 <sub>H</sub>	40052	41052	A3hY (ALM3 hysteresis)
0034 <sub>H</sub>	40053	41053	dLY1 (ALM1 delay)
0035 <sub>H</sub>	40054	41054	dLY2 (ALM2 delay)
0036 <sub>H</sub>	40055	41055	dLY3 (ALM3 delay)

Relative address	Resistor Number		Parameter contents
	Internal	Engineering unit	
0038 <sub>H</sub>	40057	41057	Sv-1 (Ramp/soak 1 seg/SV set value)
0039 <sub>H</sub>	40058	41058	Sv-2 (Ramp/soak 2 seg/SV set value)
003A <sub>H</sub>	40059	41059	Sv-3 (Ramp/soak 3 seg/SV set value)
003B <sub>H</sub>	40060	41060	Sv-4 (Ramp/soak 4 seg/SV set value)
003C <sub>H</sub>	40061	41061	Sv-5 (Ramp/soak 5 seg/SV set value)
003D <sub>H</sub>	40062	41062	Sv-6 (Ramp/soak 6 seg/SV set value)
003E <sub>H</sub>	40063	41063	Sv-7 (Ramp/soak 7 seg/SV set value)
003F <sub>H</sub>	40064	41064	Sv-8 (Ramp/soak 8 seg/SV set value)
0040 <sub>H</sub>	40065	41065	TM1r (Ramp/soak 1 seg ramp time)
0041 <sub>H</sub>	40066	41066	TM1S (Ramp/soak 1 seg soak time)
0042 <sub>H</sub>	40067	41067	TM2r (Ramp/soak 2 seg ramp time)
0043 <sub>H</sub>	40068	41068	TM2S (Ramp/soak 2 seg soak time)
0044 <sub>H</sub>	40069	41069	TM3r (Ramp/soak 3 seg ramp time)
0045 <sub>H</sub>	40070	41070	TM3S (Ramp/soak 3 seg soak time)
0046 <sub>H</sub>	40071	41071	TM4r (Ramp/soak 4 seg ramp time)
0047 <sub>H</sub>	40072	41072	TM4S (Ramp/soak 4 seg soak time)
0048 <sub>H</sub>	40073	41073	TM5r (Ramp/soak 5 seg ramp time)
0049 <sub>H</sub>	40074	41074	TM5S (Ramp/soak 5 seg soak time)
004A <sub>H</sub>	40075	41075	TM6r (Ramp/soak 6 seg ramp time)
004B <sub>H</sub>	40076	41076	TM6S (Ramp/soak 6 seg soak time)
004C <sub>H</sub>	40077	41077	TM7r (Ramp/soak 7 seg ramp time)
004D <sub>H</sub>	40078	41078	TM7S (Ramp/soak 7 seg soak time)
004E <sub>H</sub>	40079	41079	TM8r (Ramp/soak 8 seg ramp time)
004F <sub>H</sub>	40080	41080	TM8S (Ramp/soak 8 seg soak time)
0050 <sub>H</sub>	40081	41081	Mod (Ramp/soak mode)
0051 <sub>H</sub>	40082	41082	PrG (PROG) (Ramp/soak control command)
0052 <sub>H</sub>	40083	41083	PTn (Ramp/soak activation pattern)
0054 <sub>H</sub>	40085	41085	SLFb (Pv stable width during self-tuning)
0056 <sub>H</sub>	40087	41087	Communication DI
0057 <sub>H</sub>	40088	41088	rEv (Sets normal/reverse operations)
0058 <sub>H</sub>	40089	41089	TC1 (OUT1 proportion cycle)
0059 <sub>H</sub>	40090	41090	TC2 (OUT2 proportion cycle)
005B <sub>H</sub>	40092	41092	A1oP (Alarm 1 option function)
005C <sub>H</sub>	40093	41093	A2oP (Alarm 2 option function)
005D <sub>H</sub>	40094	41094	A3oP (Alarm 3 option function)
005E <sub>H</sub>	40095	41095	DI-1 operation setting
005F <sub>H</sub>	40096	41096	DI-2 operation setting
0060 <sub>H</sub>	40097	41097	onoF (Hysteresis mode setting)
0062 <sub>H</sub>	40099	41099	AdJ0 (PV display zero adjustment)
0063 <sub>H</sub>	40100	41100	AdJS (PV display Splan adjustment)
0071 <sub>H</sub>	40114	41114	AoT (AO output type)
0072 <sub>H</sub>	40115	41115	AoL (AO lower limit scaling)
0073 <sub>H</sub>	40116	41116	Aoh (AO upper limit scaling)
0074 <sub>H</sub>	40117	41117	rEM (CMOD) (switching remote mode)
0075 <sub>H</sub>	40118	41118	rEMO (RSV zero adjustment)
0076 <sub>H</sub>	40119	41119	rEMS (RSV span adjustment)

Relative address	Resistor Number		Parameter contents
	Internal	Engineering unit	
0077 <sub>H</sub>	40120	41120	rTF (RSV input filter)
0078 <sub>H</sub>	40121	41121	MAn (switching manual mode)
0079 <sub>H</sub>	40122	41122	Front MV set value
0082 <sub>H</sub>	40131	41131	Front SV set value
0083 <sub>H</sub>	40132	41132	Front MV set value
0084 <sub>H</sub>	40133	41133	MAn (switching manual mode)
0085 <sub>H</sub>	40134	41134	STbY (Switches between RUN and standby)
0086 <sub>H</sub>	40135	41135	AT (Auto-tuning run command)
0087 <sub>H</sub>	40136	41136	rEM (switching remote mode)
008C <sub>H</sub>	40141	41141	UkEY (USER key allocation settings)
008E <sub>H</sub>	40143	41143	di-1 (DI-1 function selection)
008F <sub>H</sub>	40144	41144	di-2 (DI-2 function selection)
0090 <sub>H</sub>	40145	41145	di-3 (DI-3 function selection)
0091 <sub>H</sub>	40146	41146	di-4 (DI-4 function selection)
0092 <sub>H</sub>	40147	41147	di-5 (DI-5 function selection)
00A0 <sub>H</sub>	40161	41161	LACh (DO output latch cancel command)
00A1 <sub>H</sub>	40162	41162	do1T (DO1 output event type)
00A2 <sub>H</sub>	40163	41163	AL1L (AL1 set value)
00A3 <sub>H</sub>	40164	41164	AL1h (AL1h set value)
00A4 <sub>H</sub>	40165	41165	A1hY (ALM1 hysteresis)
00A5 <sub>H</sub>	40166	41166	doP1 (Sets DO1 option function)
00A6 <sub>H</sub>	40167	41167	dLY1 (ALM1 delay)
00A7 <sub>H</sub>	40168	41168	dL1U (ALM1 delay time units)
00A8 <sub>H</sub>	40169	41169	do2T (DO2 output event type)
00A9 <sub>H</sub>	40170	41170	AL2L (AL2 set value)
00AA <sub>H</sub>	40171	41171	AL2h (AL2h set value)
00AB <sub>H</sub>	40172	41172	A2hY (ALM2 hysteresis)
00AC <sub>H</sub>	40173	41173	doP2 (DO2 option function setting)
00AD <sub>H</sub>	40174	41174	dLY2 (ALM2 delay)
00AE <sub>H</sub>	40175	41175	dL2U (ALM2 delay time units)
00AF <sub>H</sub>	40176	41176	do3T (DO3 output event type)
00B0 <sub>H</sub>	40177	41177	AL3L (AL3 set value)
00B1 <sub>H</sub>	40178	41178	AL3h (AL3h set value)
00B2 <sub>H</sub>	40179	41179	A3hY (ALM3 hysteresis)
00B3 <sub>H</sub>	40180	41180	doP3 (DO3 option function setting)
00B4 <sub>H</sub>	40181	41181	dLY3 (ALM3 delay)
00B5 <sub>H</sub>	40182	41182	dL3U (ALM3 delay time units)
00B6 <sub>H</sub>	40183	41183	do4T (DO4 output event type)
00B7 <sub>H</sub>	40184	41184	AL4L (AL4 set value)
00B8 <sub>H</sub>	40185	41185	AL4h (AL4h set value)
00B9 <sub>H</sub>	40186	41186	A4hY (ALM4 hysteresis)
00BA <sub>H</sub>	40187	41187	do4P (DO4 option function setting)
00BB <sub>H</sub>	40188	41188	dLY4 (ALM4 delay)
00BC <sub>H</sub>	40189	41189	dL4U (ALM4 delay time units)
00BD <sub>H</sub>	40190	41190	do5T (DO5 output event type)
00BE <sub>H</sub>	40191	41191	AL5L (AL5 set value)

Relative address	Resistor Number		Parameter contents
	Internal	Engineering unit	
00BF <sub>H</sub>	40192	41192	AL5h (AL5h set value)
00C0 <sub>H</sub>	40193	41193	A5hY (ALM5 hysteresis)
00C1 <sub>H</sub>	40194	41194	doP5 (Sets DO5 option function)
00C2 <sub>H</sub>	40195	41195	dLY5 (ALM5 delay)
00C3 <sub>H</sub>	40196	41196	dL5U (ALM5 delay time units)
00C4 <sub>H</sub>	40197	41197	hb1 (CT HB alarm set value)
00C6 <sub>H</sub>	40199	41999	hS1 (Load short-circuit alarm setting value for CT1)
00C7 <sub>H</sub>	40200	41200	hS1h (Load short-circuit alarm hysteresis for CT1)
00CC <sub>H</sub>	40205	41205	LbTM
00CD <sub>H</sub>	40206	41206	LbAb
00DC <sub>H</sub>	40221	41221	Svn (Selectable SV numbers)
00DD <sub>H</sub>	40222	41222	PLn1 (Currently selected PID No.)
00DF <sub>H</sub>	40224	41224	SvMX (Selectable SV numbers)
00E0 <sub>H</sub>	40225	41225	PL1M (Currently selected PID No.)
00E6 <sub>H</sub>	40231	41231	Front SV set value
00E7 <sub>H</sub>	40232	41232	P (Proportional band)
00E8 <sub>H</sub>	40233	41233	i (Integration time)
00E9 <sub>H</sub>	40234	41234	d (Derivation time)
00EA <sub>H</sub>	40235	41235	hYS (ON/OFF control hysteresis)
00EB <sub>H</sub>	40236	41236	CoL (Cooling proportional band coefficient)
00EC <sub>H</sub>	40237	41237	db (Dead band)
00ED <sub>H</sub>	40238	41238	bAL (output convergence value)
00EE <sub>H</sub>	40239	41239	Ar (Anti-reset windup)
00EF <sub>H</sub>	40240	41240	rEv (Sets normal/reverse operations)
00F0 <sub>H</sub>	40241	41241	Sv1 (SV set value 1)
00F1 <sub>H</sub>	40242	41242	P1 (Proportional band 1)
00F2 <sub>H</sub>	40243	41243	i1 (Integration time 1)
00F3 <sub>H</sub>	40244	41244	d1 (Derivation time 1)
00F4 <sub>H</sub>	40245	41245	hYS1 (ON/OFF control hysteresis 1)
00F5 <sub>H</sub>	40246	41246	CoL1 (Cooling proportional band 1)
00F6 <sub>H</sub>	40247	41247	db1 (Dead band)
00F7 <sub>H</sub>	40248	41248	bAL1 (output convergence value1)
00F8 <sub>H</sub>	40249	41249	Ar1 (Anti-reset windup 1)
00F9 <sub>H</sub>	40250	41250	rEv1 (Sets normal/reverse operations 1)
00FA <sub>H</sub>	40251	41251	Sv2 (SV set value 2)
00FB <sub>H</sub>	40252	41252	P2 (Proportional band 2)
00FC <sub>H</sub>	40253	41253	i2 (Integration time 2)
00FD <sub>H</sub>	40254	41254	d2 (derivation time 2)
00FE <sub>H</sub>	40255	41255	hYS2 (ON/OFF control hysteresis)
00FF <sub>H</sub>	40256	41256	CoL2 (Cooling proportional band 2)
0100 <sub>H</sub>	40257	41257	db2 (Dead band 2)
0101 <sub>H</sub>	40258	41258	bAL2 (output convergence value 2)
0102 <sub>H</sub>	40259	41259	Ar2 (Anti-reset windup 2)
0103 <sub>H</sub>	40260	41260	rEv2 (Sets normal/reverse operations 2)
0104 <sub>H</sub>	40261	41261	Sv3 (SV set value 3)

Relative address	Resistor Number		Parameter contents
	Internal	Engineering unit	
0105 <sub>H</sub>	40262	41262	P3 (Proportional band 3)
0106 <sub>H</sub>	40263	41263	i3 (Integration time 3)
0107 <sub>H</sub>	40264	41264	d3 (derivation time 3)
0108 <sub>H</sub>	40265	41265	hYS3 (ON/OFF control hysteresis)
0109 <sub>H</sub>	40266	41266	CoL3 (Cooling proportional band 3)
010A <sub>H</sub>	40267	41267	db3 (Dead band 3)
010B <sub>H</sub>	40268	41268	bAL3 (output convergence value 3)
010C <sub>H</sub>	40269	41269	Ar3 (Anti-reset windup 3)
010D <sub>H</sub>	40270	41270	rEv3 (Sets normal/reverse operations 3)
010E <sub>H</sub>	40271	41271	Sv4 (SV set value 4)
010F <sub>H</sub>	40272	41272	P4 (Proportional band 4)
0110 <sub>H</sub>	40273	41273	i4 (Integration time 4)
0111 <sub>H</sub>	40274	41274	d4 (derivation time 4)
0112 <sub>H</sub>	40275	41275	hYS4 (ON/OFF control hysteresis)
0113 <sub>H</sub>	40276	41276	CoL4 (Cooling proportional band 4)
0114 <sub>H</sub>	40277	41277	db4 (Dead band 4)
0115 <sub>H</sub>	40278	41278	bAL4 (output convergence value 4)
0116 <sub>H</sub>	40279	41279	Ar4 (Anti-reset windup 4)
0117 <sub>H</sub>	40280	41280	rEv4 (Sets normal/reverse operations 4)
0118 <sub>H</sub>	40281	41281	Sv5 (SV set value 5)
0119 <sub>H</sub>	40282	41282	P5 (Proportional band 5)
011A <sub>H</sub>	40283	41283	i5 (Integration time 5)
011B <sub>H</sub>	40284	41284	d5 (derivation time 5)
011C <sub>H</sub>	40285	41285	hYS5 (ON/OFF control hysteresis)
011D <sub>H</sub>	40286	41286	CoL5 (Cooling proportional band 5)
011E <sub>H</sub>	40287	41287	db5 (Dead band 5)
011F <sub>H</sub>	40288	41288	bAL5 (output convergence value 5)
0120 <sub>H</sub>	40289	41289	Ar5 (Anti-reset windup 5)
0121 <sub>H</sub>	40290	41290	rEv5 (Sets normal/reverse operations 5)
0122 <sub>H</sub>	40291	41291	Sv6 (SV set value 6)
0123 <sub>H</sub>	40292	41292	P6 (Proportional band 6)
0124 <sub>H</sub>	40293	41293	i6 (Integration time 6)
0125 <sub>H</sub>	40294	41294	d6 (Derivation time 6)
0126 <sub>H</sub>	40295	41295	hYS6 (ON/OFF control hysteresis)
0127 <sub>H</sub>	40296	41296	CoL6 (Cooling proportional band 6)
0128 <sub>H</sub>	40297	41297	db6 (Dead band 6)
0129 <sub>H</sub>	40298	41298	bAL6 (output convergence value 6)
012A <sub>H</sub>	40299	41299	Ar6 (Anti-reset windup 6)
012B <sub>H</sub>	40300	41300	rEv6 (Sets normal/reverse operations 6)
012C <sub>H</sub>	40301	41301	Sv7 (SV set value 7)
012D <sub>H</sub>	40302	41302	P7 (Proportional band 7)
012E <sub>H</sub>	40303	41303	i7 (Integration time 7)
012F <sub>H</sub>	40304	41304	d7 (Derivation time 7)
0130 <sub>H</sub>	40305	41305	hYS7 (ON/OFF control hysteresis)
0131 <sub>H</sub>	40306	41306	CoL7 (Cooling proportional band 7)
0132 <sub>H</sub>	40307	41307	db7 (Dead band 7)

Relative address	Resistor Number		Parameter contents
	Internal	Engineering unit	
0133 <sub>H</sub>	40308	41308	bAL7 (output convergence value 7)
0134 <sub>H</sub>	40309	41309	Ar7 (Anti-reset windup 7)
0135 <sub>H</sub>	40310	41310	rEv7 (Sets normal/reverse operations 7)
0154 <sub>H</sub>	40341	41341	PvT (PV input types)
0155 <sub>H</sub>	40342	41342	Pvb (PV input lower limit)
0156 <sub>H</sub>	40343	41343	PvF (PV input upper limit)
0157 <sub>H</sub>	40344	41344	Pvd (decimal position)
0158 <sub>H</sub>	40345	41345	PvU (Unit display)
015A <sub>H</sub>	40347	41347	PvoF (PV input shift)
015B <sub>H</sub>	40348	41348	SvoF (SV input shift)
015C <sub>H</sub>	40349	41349	SVL (SV limit (lower))
015D <sub>H</sub>	40350	41350	Svh (SV limit (upper))
015E <sub>H</sub>	40351	41351	TF (PV input filter)
015F <sub>H</sub>	40352	41352	AdJ0 (PV display zero adjustment)
0160 <sub>H</sub>	40353	41353	AdJS (PV display Splan adjustment)
0161 <sub>H</sub>	40354	41354	rCJ (Cold junction compensation)
0162 <sub>H</sub>	40355	41355	reM (Switching remote SV operation)
0163 <sub>H</sub>	40356	41356	rEM0 (RSV zero adjustment)
0164 <sub>H</sub>	40357	41357	rEMS (RSV span adjustment)
0165 <sub>H</sub>	40358	41358	rEMr (RSV Input Range)
0166 <sub>H</sub>	40359	41359	rTF (RSV input filter)
0167 <sub>H</sub>	40360	41360	-
017C <sub>H</sub>	40381	41381	C1r (OUT1 range)
017D <sub>H</sub>	40382	41382	C2r (OUT2 range)
017E <sub>H</sub>	40383	41383	TC1 (OUT1 proportion cycle)
017F <sub>H</sub>	40384	41384	TC2 (OUT2 proportion cycle)
0180 <sub>H</sub>	40385	41385	PLC1 (OUT1 lower limit)
0181 <sub>H</sub>	40386	41386	PhC1 (OUT1 upper limit)
0182 <sub>H</sub>	40387	41387	PLC2 (OUT2 lower limit)
0183 <sub>H</sub>	40388	41388	PhC2 (OUT2 upper limit)
0184 <sub>H</sub>	40389	41389	PCUT (Selects the output limiter type)
0185 <sub>H</sub>	40390	41390	FLo1
0186 <sub>H</sub>	40391	41391	FLo2
0187 <sub>H</sub>	40392	41392	SFo1
0189 <sub>H</sub>	40394	41394	SFTM (Soft start set time)
018D <sub>H</sub>	40398	41398	Sbo1
018E <sub>H</sub>	40399	41399	Sbo2
018F <sub>H</sub>	40400	41400	SbMd (Standby mode settings)
0190 <sub>H</sub>	40401	41401	AoT (AO output type)
0191 <sub>H</sub>	40402	41402	AoL (AO lower limit scaling)
0192 <sub>H</sub>	40403	41403	AoH (AO upper limit scaling)
01A4 <sub>H</sub>	40421	41421	CTrL (control method)
01A5 <sub>H</sub>	40422	41422	onoF (ON/OFF control hysteresis)
01A6 <sub>H</sub>	40423	41423	SLFb (Pv stable width during self-tuning)
01A7 <sub>H</sub>	40424	41424	PrCS (Control target)
01A8 <sub>H</sub>	40425	41425	PGAP (PFB Dead Band)

Relative address	Resistor Number		Parameter contents
	Internal	Engineering unit	
01A9H	40426	41426	TrvL (Valve stroke time)
01ABH	40428	41428	CAL (PFB input adjustment command)
01ACH	40429	41429	rMP (Ramp SV - effect/no effect)
01ADH	40430	41430	rMPL (Ramp SV - decline)
01AEH	40431	41431	rMPH (Ramp SV - incline)
01AFH	40432	41432	rMPU (Ramp SV slope time unit)
01B0H	40433	41433	SvT (Ramp SV - SV display mode selection)
01B1H	40434	41434	STMd (Startup mode)
01C2H	40451	41451	dP01 (Parameter display mask)
01C3H	40452	41452	dP02 (Parameter display mask)
01C4H	40453	41453	dP03 (Parameter display mask)
01C5H	40454	41454	dP04 (Parameter display mask)
01C6H	40455	41455	dP05 (Parameter display mask)
01C7H	40456	41456	dP06 (Parameter display mask)
01C8H	40457	41457	dP07 (Parameter display mask)
01C9H	40458	41458	dP08 (Parameter display mask)
01CAH	40459	41459	dP09 (Parameter display mask)
01CBH	40460	41460	dP10 (Parameter display mask)
01CCH	40461	41461	dP11 (Parameter display mask)
01CDH	40462	41462	dP12 (Parameter display mask)
01CEH	40463	41463	dP13 (Parameter display mask)
01CFH	40464	41464	dP14 (Parameter display mask)
01D0H	40465	41465	dP15 (Parameter display mask)
01D1H	40466	41466	dP16 (Parameter display mask)
01D2H	40467	41467	dP17 (Parameter display mask)
01D3H	40468	41468	dP18 (Parameter display mask)
01D4H	40469	41469	dP19 (Parameter display mask)
01D5H	40470	41470	dP20 (Parameter display mask)
01D6H	40471	41471	dP21 (Parameter display mask)
01D7H	40472	41472	dP22 (Parameter display mask)
01D8H	40473	41473	dP23 (Parameter display mask)
01D9H	40474	41474	dP24 (Parameter display mask)
01DAH	40475	41475	dP25 (Parameter display mask)
01DBH	40476	41476	dP26 (Parameter display mask)
01DCH	40477	41477	dP27 (Parameter display mask)
01DDH	40478	41478	dP28 (Parameter display mask)
01DEH	40479	41479	dP29 (Parameter display mask)
01DFH	40480	41480	dP30 (Parameter display mask)
0208H	40521	41521	PASS (Password input)
0209H	40522	41522	PAS1 (Password 1 setup)
020AH	40523	41523	PAS2 (Password 2 setup)
020BH	40524	41524	PAS3 (Password 3 setup)
0212H	40531	41531	ToUT (Display timeout setting)
0214H	40533	41533	r-Fk (During remote selection setting, SV display blinking settings)

Relative address	Resistor Number		Parameter contents
	Internal	Engineering unit	
0215H	40534	41534	SoFk (During soft start selection, SV display blinking settings)
0216H	40535	41535	ALMF (During ALM, DO lamp blink settings)
0217H	40536	41536	rST (Reset main unit)
0218H	40537	41537	bCon (Select controll at burnout)
0219H	40538	41538	PTnT (Ramp/soak pattern type)
021DH	40542	41542	L-C2 (LED lamp allocation (C2))
0230H	40561	41561	PTn (Ramp/soak progress)
0231H	40562	41562	TiMU (Ramp/soak time units)
0232H	40563	41563	Mod (Ramp/soak mode)
0233H	40564	41564	PTnM (Sets the max pattern selection)
0234H	40565	41565	PMin (Sets the min pattern selection)
023AH	40571	41571	Gsok (Guaranty soak ON/OFF)
023BH	40572	41572	GS-L (Guaranty soak (lower limit))
023CH	40573	41573	GS-h (Guaranty soak (upper limit))
023DH	40574	41574	PvST (PV start)
023EH	40575	41575	ConT (Restore mode)
0244H	40581	41581	Sv-1 (Ramp/soak 1 seg/SV set value)
0245H	40582	41582	TM1r (Ramp/soak 1 seg ramp time)
0246H	40583	41583	TM1S (Ramp/soak 1 seg soak time)
0247H	40584	41584	Sv-2 (Ramp/soak 2 seg/SV set value)
0248H	40585	41585	TM2r (Ramp/soak 2 seg ramp time)
0249H	40586	41586	TM2S (Ramp/soak 2 seg soak time)
024AH	40587	41587	Sv-3 (Ramp/soak 3 seg/SV set value)
024BH	40588	41588	TM3r (Ramp/soak 3 seg ramp time)
024CH	40589	41589	TM3S (Ramp/soak 3 seg soak time)
024DH	40590	41590	Sv-4 (Ramp/soak 4 seg/SV set value)
024EH	40591	41591	TM4r (Ramp/soak 4 seg ramp time)
024FH	40592	41592	TM4S (Ramp/soak 4 seg soak time)
0250H	40593	41593	Sv-5 (Ramp/soak 5 seg/SV set value)
0251H	40594	41594	TM5r (Ramp/soak 5 seg ramp time)
0252H	40595	41595	TM5S (Ramp/soak 5 seg soak time)
0253H	40596	41596	Sv-6 (Ramp/soak 6 seg/SV set value)
0254H	40597	41597	TM6r (Ramp/soak 6 seg ramp time)
0255H	40598	41598	TM6S (Ramp/soak 6 seg soak time)
0256H	40599	41599	Sv-7 (Ramp/soak 7 seg/SV set value)
0257H	40600	41600	TM7r (Ramp/soak 7 seg ramp time)
0258H	40601	41601	TM7S (Ramp/soak 7 seg soak time)
0259H	40602	41602	Sv-8 (Ramp/soak 8 seg/SV set value)
025AH	40603	41603	TM8r (Ramp/soak 8 seg ramp time)
025BH	40604	41604	TM8S (Ramp/soak 8 seg soak time)
025CH	40605	41605	Sv-9 (Ramp/soak 9 seg/SV set value)
025DH	40606	41606	TM9r (Ramp/soak 9 seg ramp time)
025EH	40607	41607	TM9S (Ramp/soak 9 seg soak time)
025FH	40608	41608	Sv10 (Ramp/soak 10 seg/SV set value)
0260H	40609	41609	T10r (Ramp/soak 10 seg ramp time)

Relative address	Resistor Number		Parameter contents
	Internal	Engineering unit	
0261 <sub>H</sub>	40610	41610	T10S (Ramp/soak 10 seg soak time)
0262 <sub>H</sub>	40611	41611	Sv11 (Ramp/soak 11 seg/SV set value)
0263 <sub>H</sub>	40612	41612	T11r (Ramp/soak 11 seg ramp time)
0264 <sub>H</sub>	40613	41613	T11S (Ramp/soak 11 seg soak time)
0265 <sub>H</sub>	40614	41614	Sv12 (Ramp/soak 12 seg/SV set value)
0266 <sub>H</sub>	40615	41615	T12r (Ramp/soak 12 seg ramp time)
0267 <sub>H</sub>	40616	41616	T12S (Ramp/soak 12 seg soak time)
0268 <sub>H</sub>	40617	41617	Sv13 (Ramp/soak 13 seg/SV set value)
0269 <sub>H</sub>	40618	41618	T13r (Ramp/soak 13 seg ramp time)
026A <sub>H</sub>	40619	41619	T13S (Ramp/soak 13 seg soak time)
026B <sub>H</sub>	40620	41620	Sv14 (Ramp/soak 14 seg/SV set value)
026C <sub>H</sub>	40621	41621	T14r (Ramp/soak 14 seg ramp time)
026D <sub>H</sub>	40622	41622	T14S (Ramp/soak 14 seg soak time)
026E <sub>H</sub>	40623	41623	Sv15 (Ramp/soak 15 seg/SV set value)
026F <sub>H</sub>	40624	41624	T15r (Ramp/soak 15 seg ramp time)
0270 <sub>H</sub>	40625	41625	T15S (Ramp/soak 15 seg soak time)
0271 <sub>H</sub>	40626	41626	Sv16 (Ramp/soak 16 seg/SV set value)
0272 <sub>H</sub>	40627	41627	T16r (Ramp/soak 16 seg ramp time)
0273 <sub>H</sub>	40628	41628	T16S (Ramp/soak 16 seg soak time)

### Word Data (read only): function code [04 (H)]

#### Monitor (Ch5)

Parameter display	Parameter name	Contents	Relative address	Resistor Number		Type	Read data	Dependent on range
				Internal	Engineering unit			
"STAT"	STAT	Ramp/soak progress	0028 <sub>H</sub>	30041	31041	Word	oFF (ramp/soak is stopped) 1rP (Step 1 Ramp) 1Sk (soak is in step 1) ⋮ 16rP (Step 16 Ramp) 16Sk (soak is in step 16) End (ramp/soak is finished)	
"Mv1"	Mv1	Control output 1	0029 <sub>H</sub>	30042	31042	Word	-300 to 10300 (-3.00 to 103.00%FS)	
"Mv2"	Mv2	Control output 2	002A <sub>H</sub>	30043	31043	Word	-300 to 10300 (-3.00 to 103.00%FS)	
"PFb"	PFb	PFB Input Value Display	002B <sub>H</sub>	30044	31044	Word	-300 to 10300 (-3.00 to 103.00%FS)	
"rSv"	rSv	RSV input value display	002C <sub>H</sub>	30045	31045	Word	-500 to 10500 (-5.00 to 105.00%FS)	
"CT1"	CT1	Heater current	002D <sub>H</sub>	30046	31046	Word	0 to 500 (0, 0.4 to 50.0A)	
"LC1"	LC1	Leak current value	002F <sub>H</sub>	30048	31048	Word	0 to 500 (0, 0.4 to 50.0A)	
"TM1"	TM1	Remaining time on timer 1	0031 <sub>H</sub>	30050	31050	Word	0 sec to 9999 sec / 0 min to 9999 min	
"TM2"	TM2	Remaining time on timer 2	0032 <sub>H</sub>	30051	31051	Word	0 sec to 9999 sec / 0 min to 9999 min	
"TM3"	TM3	Remaining time on timer 3	0033 <sub>H</sub>	30052	31052	Word	0 sec to 9999 sec / 0 min to 9999 min	
"TM4"	TM4	Remaining time on timer 4	0034 <sub>H</sub>	30053	31053	Word	0 sec to 9999 sec / 0 min to 9999 min	
"TM5"	TM5	Remaining time on timer 5	0035 <sub>H</sub>	30054	31054	Word	0 sec to 9999 sec / 0 min to 9999 min	
"FALT"	FALT	Error source display	0036 <sub>H</sub>	30055	31055	Word	0000 to 1100	
"PLno"	PLno	Current palette	0038 <sub>H</sub>	30057	31057	Word	0~7	
"PTno"	PTno	Current pattern	0039 <sub>H</sub>	30058	31058	Word	0~6	



Other

Parameter display	Parameter name	Contents	Relative address	Resistor Number		Type	Read data	Dependent on range
				Internal	Engineering unit			
Display PV value	Pv (measurement)		0000H	30001	31001	Word	0 to 10000 (0.00 to 100.00%FS)	○
Display SV Value	Sv (Currently used set value)		0001H	30002	31002	Word	0 to 10000 (0.00 to 100.00%FS)	○
-	DV (Currently used deviation)		0002H	30003	31003	Word	-10000 to 10000 (-100.00 to 100.00%FS)	○
"rV1"	Mv1	Output 1	0003H	30004	31004	Word	-300 to 10300 (-3.00 to 103.00%FS)	
"rV2"	Mv2	Output 2	0004H	30005	31005	Word	-300 to 10300 (-3.00 to 103.00%FS)	
"STNo"	STNo	STATION No.	0005H	30006	31006	Word	0 to 255	
-	DO STATUS		0006H	30007	31007	Word	See the table [DO STATUS] below.	
"FALT"	FALT	FALT STATUS	0007H	30008	31008	Word	0000 to 1100	
"STAT"	STAT	Ramp/Soak progress	0008H	30009	31009	Word	0: oFF (ramp/soak is stopped) 1: 1-rP (Step 1 Ramp) 2: 1-Sk (Step 1 Soak) ⋮ 31: 16-rP (Step 16 Ramp) 32: 16-Sk (Step 16 Soak) 33: End (ramp/soak is finished)	
"CT1"	CT1	Heater current	0009H	30010	31010	Word	0 to 500 (0.0 to 50.0A)	
"TM1"	TM1	Remaining time on timer 1	000AH	30011	31011	Word	0 sec to 9999 sec / 0 min to 9999 min	
"TM2"	TM2	Remaining time on timer 2	000BH	30012	31012	Word	0 sec to 9999 sec / 0 min to 9999 min	
"TM3"	TM3	Remaining time on timer 3	000CH	30013	31013	Word	0 sec to 9999 sec / 0 min to 9999 min	
"DI"	DI		000EH	30015	31015	Word		
-	rCJ (Cold junction compensation)	Terminal temperature	000FH	30016	31016	Word	-10000 to 10000 (-100.00 to 100.00%FS) -1999 to 9999 (-199.9 to 999.9°C)	
"rSV"	rSV	RSV input value display	0024H	30037	31037	Word		
-	DI STATUS		003CH	30061	31061	Word		
-	STAT		003DH	30062	31062	Word		

[DO STATUS]

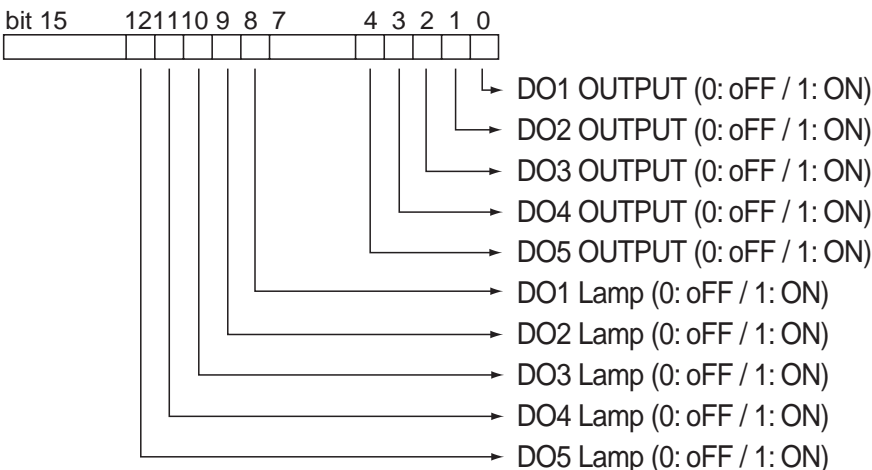

## Resistor Number Order Read Parameter List

Relative address	Resistor Number		Type	Memory contents
	Internal	Engineering unit		
0000 <sub>H</sub>	30001	31001	Word	PV (measurement)
0001 <sub>H</sub>	30002	31002	Word	SV (Currently used set value)
0002 <sub>H</sub>	30003	31003	Word	DV (Currently used deviation)
0003 <sub>H</sub>	30004	31004	Word	Mv1 (output 1)
0004 <sub>H</sub>	30005	31005	Word	Mv2 (output 2)
0005 <sub>H</sub>	30006	31006	Word	STATION No.
0006 <sub>H</sub>	30007	31007	Word	ALM STATUS
0007 <sub>H</sub>	30008	31008	Word	FALT STATUS
0008 <sub>H</sub>	30009	31009	Word	STAT (Ramp/soak progress)
0009 <sub>H</sub>	30010	31010	Word	HB INPUT
000A <sub>H</sub>	30011	31011	Word	TM1 (Remaining time on timer 1)
000B <sub>H</sub>	30012	31012	Word	TM2 (Remaining time on timer 2)
000C <sub>H</sub>	30013	31013	Word	TM3 (Remaining time on timer 3)
000E <sub>H</sub>	30015	31015	Word	DI STATUS
000F <sub>H</sub>	30016	31016	Word	rCJ (Cold junction compensation)
0024 <sub>H</sub>	30037	31037	Word	rEM (Remote switching status)
0028 <sub>H</sub>	30041	31041	Word	STAT (Ramp/soak progress)
0029 <sub>H</sub>	30042	31042	Word	Mv1 (output 1)
002A <sub>H</sub>	30043	31043	Word	Mv2 (output 2)
002B <sub>H</sub>	30044	31044	Word	PFb input value display
002C <sub>H</sub>	30045	31045	Word	rSv input value display
002D <sub>H</sub>	30046	31046	Word	CT1 (Heater current)
002F <sub>H</sub>	30048	31048	Word	LC1 (Leak current value)
0031 <sub>H</sub>	30050	31050	Word	TM1 (Remaining time on timer 1)
0032 <sub>H</sub>	30051	31051	Word	TM2 (Remaining time on timer 2)
0033 <sub>H</sub>	30052	31052	Word	TM3 (Remaining time on timer 3)
0034 <sub>H</sub>	30053	31053	Word	TM4 (Remaining time on timer 4)
0035 <sub>H</sub>	30054	31054	Word	TM5 (Remaining time on timer 5)
0036 <sub>H</sub>	30055	31055	Word	FALT STATUS
0038 <sub>H</sub>	30057	31057	Word	PLno (Current palette No.)
0039 <sub>H</sub>	30058	31058	Word	PTno (Current pattern No.)
003B <sub>H</sub>	30060	31060	Word	ALM STATUS
003C <sub>H</sub>	30061	31061	Word	DI STATUS
003D <sub>H</sub>	30062	31062	Word	STAT

---

## MEMO

# Chapter 8

## Sample Program

Sample Program – 68

# Sample Program

This chapter shows a sample program that runs in Microsoft Visual Basic 6.0 (SP6) for reading and writing data. The program shown here is meant to be used as a reference for your own program creation, and therefore all its actions are not guaranteed.

Before running the program, check the following summary of points for communication conditions.

- Parity, communication speed to be set in this program. Please match these values with the conditions of the micro controller.

## Warning when using an RS-232C to RS-485 converter

The sent data is sometimes added to the response data from the slave before it is received. In this case, when receiving the data, process the response data only after first getting rid of the number of bytes from the sent data.

## Compatible OS

Windows 2000 Professional

Windows XP Professional Edition

### Caution

- Windows® is a registered trademark of the Microsoft Corporation.
- Visual Basic® is a registered trademark of the Microsoft Corporation.

Fuji Electric Systems Co., Ltd. assumes no responsibility for damages or infringement upon third party rights as a result of using this sample program.

Use this program while conforming to the contents of the agreement listed within.

## ■ Example of data reading

- Operation: Reads and displays 2 word data of the set address at once.
- Function code to be used: 03H, 04H
- Number of read words: 2

```
' Variable Declaration *****
Dim idx As Integer
    Dim Ansdat() As Byte           ' Response data stack
    Dim Rxbuff As Variant         ' Received data buffer
    Dim PauseTime                 ' Sets the communication wait time.
                                ' The necessary wait time changes depending on the
                                ' transmission speed and transmission frame length.
    Dim Stno As Byte              ' Communication number

Private Sub Form_Load()

' Initializing the Variable *****
    Stno = 1
    Main.Visible = True

End Sub

'-----
'Read continuous words sample program
'Function code : 03H, 04H
'Number of words : 2
'-----

Private Sub TX1_Click()

    TX1.Enabled = False
```

```

' Communication Port Settings *****
If Com5.Value = True Then
    Comm_port = 5          ' COM5
ElseIf Com4.Value = True Then
    Comm_port = 4          ' COM4
ElseIf Com3.Value = True Then
    Comm_port = 3          ' COM3
ElseIf Com2.Value = True Then
    Comm_port = 2          ' COM2
Else
    Comm_port = 1          ' COM1
End If

If SPD192.Value = True Then
    Comm_speed = "19200,"  ' 19200bps
ElseIf SPD96.Value = True Then
    Comm_speed = "9600,"   ' 9600bps
Else
    Comm_speed = "38400,"  ' 38400bps
End If

If Even1.Value = True Then
    Comm_parity = "E,"     ' Even parity
ElseIf Odd1.Value = True Then
    Comm_parity = "O,"     ' Odd parity
Else
    Comm_parity = "N,"     ' Parity none
End If

PauseTime = 0.2          ' Sets the wait time. (0.2 sec)

idx = 0

' Opening the Communication Port *****
MSComm1.CommPort = Comm_port      ' COM port settings
MSComm1.Settings = Comm_speed & Comm_parity & "8,1" ' Speed / Party / 8bit_Data / Stop_1bit
MSComm1.PortOpen = True          ' Port open

' Setting the Communication Number for the Other Party *****
St = Val(Stno1(idx).Text)
Stno = St Mod 256
Stno1(idx).Text = Str(Stno)

' Processing the Address *****
AD$ = Str(Val(Address(idx).Text) - 1)
AD$ = Right$("00000" & AD$), 5)
Area = Val(Left$(AD$, 1))
Adrsh = Int(Val(Right$(AD$, 4)) / 256)
Adrs1 = Val(Right$(AD$, 4)) Mod 256

```

```

' Creating the Send Command *****
Select Case Area
Case 3
    ReDim Txdat(7) As Byte          ' Secured 8-byte array
    Txdat(0) = Stno                 ' Station No.
    Txdat(1) = &H4                  ' Command
    Txdat(2) = Adrsh                ' High address
    Txdat(3) = Adrsl               ' Low address
    Txdat(4) = &H0                  ' Read no. words (High)
    Txdat(5) = &H2                  ' Read no. of words (Low)
    Txsu = 5                        ' No. of sent data

Case 4
    ReDim Txdat(7) As Byte          ' Secured 8-byte array
    Txdat(0) = Stno                 ' Station No.
    Txdat(1) = &H3                  ' Command
    Txdat(2) = Adrsh                ' High address
    Txdat(3) = Adrsl               ' Low address
    Txdat(4) = &H0                  ' Read no. of words (High)
    Txdat(5) = &H2                  ' Read no. of words (Low)
    Txsu = 5                        ' No. of sent data

Case Else                          ' For other values
MSComm1.PortOpen = False          ' COM port close
    TX1.Enabled = True
    Exit Sub
End Select

' Sending the command.*****

' Creating CRC for Send Data
GoSub 10000                        ' CRC computation
Txdat(Txsu + 1) = CRC1             '
Txdat(Txsu + 2) = CRC2             '

' Send the created command.
MSComm1.Output = Txdat' Send one byte

' Wait until all of the response data is sent.
Start = Timer                      ' Saves the waiting start time.
Do While Timer < Start + PauseTime ' Has the set time passed?
    DoEvents                       ' Passes control to other processes.
    If ((Start + PauseTime) - Timer) > PauseTime Then
        Start = Timer
    End If
Loop

```

```

' Import the response data into a byte array.
MSComm1.InputMode = comInputModeBinary      ' Set binary mode
length = MSComm1.InBufferCount              ' Retrieve the no. of sent data bytes
MSComm1.InputLen = 0                        ' Set retrieval of all data
Rxbuff = MSComm1.Input                      ' Import received data into the received buffer
Ansdatt = Rxbuff                            ' Assign received data into the byte array

' Calculating CRC for Received Data
Ansu = length - 3                           ' Received data length
GoSub 20000                                  ' CRC computation

' Error check
If (length = 0) Then                          ' No answer
    Noans = Noans + 1: Rx_data.Caption = "Noans": GoTo 150'
ElseIf ((Ansdatt(length - 2) <> CRC1) + (Ansdatt(length - 1) <> CRC2)) Then ' CRC error
    CRCErr = CRCErr + 1: Rx_data.Caption = "CRCErr": GoTo 150
ElseIf Ansdatt(1) >= &H80 Then                ' Command error
    CMDErr = CMDErr + 1: Rx_data.Caption = "CMDErr": GoTo 150
End If

' Processing correctly received data
    wrk1 = Ansdatt(3)
    wrk2 = Ansdatt(4)
    wrk3 = Ansdatt(5)
    wrk4 = Ansdatt(6)
If Ansdatt(5) > 128 Then                      ' Received data minus time
    Rx_data.Caption = Str(((wrk3 * (2 ^ 24)) + (wrk4 * (2 ^ 16)) + (wrk1 * (2 ^ 8)) + wrk2) - (2 ^ 32))
Else
    Rx_data.Caption = Str(((wrk3 * (2 ^ 24)) + (wrk4 * (2 ^ 16)) + (wrk1 * (2 ^ 8)) + wrk2))
End If
150
MSComm1.PortOpen = False                     ' COM port close

TX1.Enabled = True

Exit Sub

```



```
' *****
10000 ' CRC calculation subroutine IN:Txdat(Txsu) / OUT CRC1,CRC2 *****
CRC = &HFFFF
For i = 0 To Txsu Step 1
  CRC = CRC Xor Txdat(i)
  For J = 1 To 8 Step 1
    CT = CRC And &H1
    If CRC < 0 Then CH = 1 Else: CH = 0: GoTo 11000
    CRC = CRC And &H7FFF
11000  CRC = Int(CRC / 2)
    If CH = 1 Then CRC = CRC Or &H4000
    If CT = 1 Then CRC = CRC Xor &HA001
  Next J
Next i
CRC1 = CRC And &HFF
CRC2 = ((CRC And &HFF00) / 256 And &HFF)
Return

20000 ' CRC calculation subroutine IN:Ansdat(Ansu) / OUT CRC1,CRC2 *****
CRC = &HFFFF
For i = 0 To Ansu Step 1
  CRC = CRC Xor Ansdat(i)
  For J = 1 To 8 Step 1
    CT = CRC And &H1
    If CRC < 0 Then CH = 1 Else: CH = 0: GoTo 21000
    CRC = CRC And &H7FFF
21000  CRC = Int(CRC / 2)
    If CH = 1 Then CRC = CRC Or &H4000
    If CT = 1 Then CRC = CRC Xor &HA001
  Next J
Next i
CRC1 = CRC And &HFF
CRC2 = ((CRC And &HFF00) / 256 And &HFF)
Return

End Sub
```

■ Example of data writing

- Operation: Writes 2 word data of the set address.
- Function code to be used: 10H
- Number of write words: 2

```

-----
'Write 2 words sample program
'Function code : 10H
'Number of words : 2
'-----

Private Sub Write_command_Click()
    Write_command.Enabled = False

    ' Communication Port Settings *****
    If Com5.Value = True Then
        Comm_port = 5                ' COM5
    ElseIf Com4.Value = True Then
        Comm_port = 4                ' COM4
    ElseIf Com3.Value = True Then
        Comm_port = 3                ' COM3
    ElseIf Com2.Value = True Then
        Comm_port = 2                ' COM2
    Else
        Comm_port = 1                ' COM1
    End If

    If SPD192.Value = True Then
        Comm_speed = "19200,"        ' 19200bps
    ElseIf SPD96.Value = True Then
        Comm_speed = "9600,"         ' 9600bps
    Else
        Comm_speed = "38400,"        ' 38400bps
    End If

    If Even1.Value = True Then
        Comm_parity = "E,"           ' Even parity
    ElseIf Odd1.Value = True Then
        Comm_parity = "O,"           ' Odd parity
    Else
        Comm_parity = "N,"           ' Parity none
    End If

    PauseTime = 0.2                  ' Sets the wait time. (0.2 sec)
    idx = 1
    ' Opening the Communication Port *****
    MSComm1.CommPort = Comm_port      ' Com port
    MSComm1.Settings = Comm_speed & Comm_parity & "8,1" ' Speed / Party / 8bit_Data / Stop_1bit
    MSComm1.PortOpen = True           ' Open com port

```

```

' Setting the Communication Number for the Other Party *****
St = Val(Stno1(idx).Text)
Stno = St Mod 256
Stno1(idx).Text = Str(Stno)

' Processing the Address *****
AD$ = Str(Val(Address(idx).Text) - 1)
AD$ = Right$("00000" & AD$, 5)
Area = Val(Left$(AD$, 1))
Adrsh = Int(Val(Right$(AD$, 4)) / 256)
Adrsl = Val(Right$(AD$, 4)) Mod 256

'Creating the Send Command *****

Select Case Area
Case 4

'Normal sending data is processed.
Dim byteData(3) As Byte
Dim sHex As String

sHex = Right("00000000" & Hex(Val(Write_data.Text)), 8) 'Decimal to hexadecimal
byteData(0) = CByte("&H" & Mid(sHex, 1, 2)) 'hh byte
byteData(1) = CByte("&H" & Mid(sHex, 3, 2)) 'hl byte
byteData(2) = CByte("&H" & Mid(sHex, 5, 2)) 'lh byte
byteData(3) = CByte("&H" & Mid(sHex, 7, 2)) 'll byte

ReDim Txdat(12) As Byte ' 13 bytes
Txdat(0) = Stno ' Station No.
Txdat(1) = &H10 ' Command
Txdat(2) = Adrsh ' High address
Txdat(3) = Adrsl ' Low address
Txdat(4) = &H0 ' Write no. of words (High)
Txdat(5) = &H2 ' Write no. of words (Low)
Txdat(6) = &H4 ' Write no. of bytes
Txdat(7) = byteData(2) ' Write data (Lo high)
Txdat(8) = byteData(3) ' Write data (Lo lo)
Txdat(9) = byteData(0) ' Write data (High high)
Txdat(10) = byteData(1) ' Write data (High lo)
Txsu = 10 ' No. of sent data

Case Else ' For other values
MSComm1.PortOpen = False ' COM port close
Write_command.Enabled = True
Exit Sub
End Select

```

```

' Sending the command. *****

' Creating CRC for Send Data
GoSub 10000          ' CRC computation
Txdat(Txsu + 1) = CRC1
Txdat(Txsu + 2) = CRC2

' Send the created command.
MSComm1.Output = Txdat          ' Send one byte

' Wait until all of the response data is sent.
Start = Timer          ' Saves the waiting start time.
Do While Timer < Start + PauseTime ' Has the set wait time passed?
  DoEvents          ' Passes control to other processes.
  If ((Start + PauseTime) - Timer) > PauseTime Then
    Start = Timer
  End If
Loop

MSComm1.PortOpen = False          ' COM port close

Write_command.Enabled = True

Exit Sub

' *****

10000  ' CRC calculation subroutine IN:Txdat(Txsu) / OUT CRC1,CRC2 *****
CRC = &HFFFF
For i = 0 To Txsu Step 1
  CRC = CRC Xor Txdat(i)
  For J = 1 To 8 Step 1
    CT = CRC And &H1
    If CRC < 0 Then CH = 1 Else: CH = 0: GoTo 11000
    CRC = CRC And &H7FFF
11000  CRC = Int(CRC / 2)
    If CH = 1 Then CRC = CRC Or &H4000
    If CT = 1 Then CRC = CRC Xor &HA001
  Next J
Next i
CRC1 = CRC And &HFF
CRC2 = ((CRC And &HFF00) / 256 And &HFF)
Return

End Sub

```

---

## MEMO

# Chapter 9

## Troubleshooting

Troubleshooting – 78

# Troubleshooting

Check the following items when the unit cannot communicate.

- Is the power turned on to all of the equipment related to communication?
- Are the wire connections correct? (Are the + and – poles matching?)
- Are the communication settings the same between the master (the top computer) and the slave (micro controller)?
  - Communication speed : 9600bps, 19200 bps
  - Data : 8-bit
  - Stop bit : 1-bit
  - Parity :  Odd
    - Even
    - None
- Does the transmission signal timing satisfy "Chapter 5, MODBUS Communication Protocol" (p. 19)?
- Is the station number specified as the sending location from the master set at something other than "0"?

The communication function does not work when set to "0".
- When using RS-485, is the 7th digit of the model number (PXG□□□■□□□□□□) any of M, V, K, J, U or F?
- When using RS-485, are the communication settings the same for the RS-232C to RS-485 converter?

---

## **Fuji Electric Co., Ltd.**

International Sales Div

Sales Group

Gate City Ohsaki, East Tower, 11-2, Osaki 1-chome,  
Shinagawa-ku, Tokyo 141-0032, Japan

<http://www.fujielectric.com>

Phone: 81-3-5435-7280, 7281 Fax: 81-3-5435-7425

<http://www.fujielectric.com/products/instruments/>

---