



This quad channel thermocouple controller is ideal for numerous industrial temperature applications. It accepts direct sensor input from all common thermocouple types.

One of the key features of this controller is its ability to average the inputs across 2, 3 or 4 temperature channels, and use this averaged value for a display source or for setpoint activation.

Contents

1 - Specifications	2
2 - Front Panel & Display	3
3 - Wiring	5
4 - Dimensions & Installation	8
5 - Data Sources	10
6 - Input Setup & Calibration	13
7 - Setpoint Setup	20
8 - Setpoint Direct Access	23
9 - Reset PIN Numbers / View Firmware Version	23
A - Appendix A - Serial Modes	24

Order Codes

PRO-TC

-HV	85–265V AC / 95–370V DC
-LV	15–48V AC / 10–72V DC

Options

-R2	2 x relay outputs
-R4	4 x relay outputs
-A	1 x mA/V analog output
-S2R	1 x RS232 (RJ11 terminal)
-S4S	1 x RS485 (screw terminal)

1

SPECIFICATIONS

Input

Sensor input Thermocouple types J, K, R, T or N

Power supply HV (85–265V AC/95–370V DC) or LV (15–48V AC/10–72V DC)

Temperature units Degrees C or F

Processing rate 10Hz

Resolution 0.1°C

Zero drift ±40nV/°C

Span drift ±20ppm/°C FS max

Non-linearity 1°C max

Input noise 160nVp-p typical at 1Hz output rate

Noise rejection 50/60Hz

Output rate Fixed 10Hz averaged per channel

Relay Output

OPTIONAL

Number of relay outputs None, 2, or 4

Relay output type 5A form A (3A 240V AC max or 3A 30V DC max)

Analog Output

OPTIONAL

Analog output type 1 x Isolated 16 bit 4–20mA / 0–10V (selectable)

Features Fully scalable. Window programmable over any range within the controller's full-scale range

Comm Port

OPTIONAL

Number of serial ports None or 1

Serial port options Isolated RS232 (RJ terminal) or RS485 (screw terminal)

Output mode Custom ASCII, Modbus RTU slave, or Ranger A (5 updates/sec)
Data rate: 1200–115k2 baud
Parity: Odd, even or none

Programming

Front panel buttons Up, Down, P (Prog/Enter), plus 2 Menu buttons (F)

Security Input and setpoint setups are independently accessible and PIN protected

Display

Display type LED display, 5 buttons

LED indicators 6 setpoint indicator LED's

Digits 1 row of 6 digits, 13mm (0.5"), 14 segment alphanumeric LED

Display range 0.1 to 99999.9

Construction	48 x 96 x 120mm (1.89 x 3.78 x 4.72")
Casing Panel mount case	Panel cutout 45 x 92mm (1.77 x 3.62")
Ingress protection rating	IP65 dust/splash proof (face only)
Dimensions (H x W x D)	

2

FRONT PANEL & DISPLAY

2.1 - Front panel

SPX The SP LED's are used to indicate active setpoints.

F1 This button is used to access the **Input Setup & Calibration** menu (Section 6).

P This button is used to save your settings and advance to the next step in the setup process.



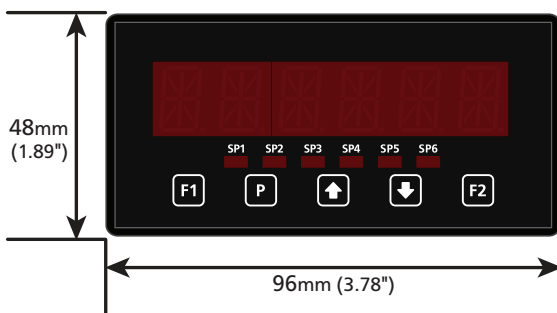

↑ This button is typically used to scroll through options or increase values in the setup menu. Pressing this button from the main display will allow you to view/reset the *Peak* value, or to view the current input values for channels 1–4 (see 2.3).

↓ This button is typically used to scroll through options or decrease values in the setup menu. Pressing this button from the main display will allow you to view/reset the *Valley* value, or to view the current channel average value (see 2.3).





F2 This button is used to access the **Setpoint Setup** menu (Section 7) and the **Setpoint Direct Access** menu (Section 8).





2.2 - Display brightness



To adjust the display brightness, press the  and  buttons together from the main display. **BRI** appears and toggles with the current setting. Use the  and  buttons to adjust the LED backlight, and then press  to finish.

2.3 - Up and down button shortcuts

Pressing the  and  buttons from the main operational display allows instant access to a number of values held in the controller's memory. These variables will appear in the order shown in the table below, and will cycle continuously at each press of the  or  button.

Press  at any time to return to normal operating mode. **PEAK** and **VALLEY** may be reset to zero by pressing the  and  buttons **at the same time** while the variable is being displayed.

Up and down button shortcuts

	PEAK	The maximum measured value since the instrument was turned on or reset (see 5.5)
	TEMP 1	Current input value for channel 1
	TEMP 2	Current input value for channel 2
	TEMP 3	Current input value for channel 3
	TEMP 4	Current input value for channel 4
	VALLEY	The minimum measured value since the instrument was turned on or reset (see 5.5)
	AVETMP	Average temperature value (see 5.4A)

3

WIRING

3.1 - Pinouts

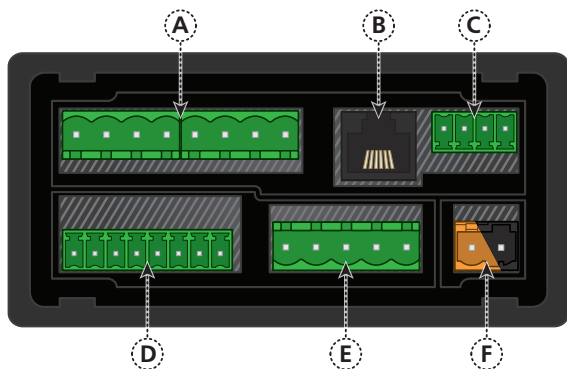

Key

- 3.1A Relay Output (see 3.3)
- 3.1B Serial Port (see 3.5)
- 3.1C Analog Output (see 3.4)
- 3.1D Analog Input (see 3.2)
- 3.1E Function Pins (see 3.6)
- 3.1F Power Supply HV/LV (see 3.7)

3.2 - Analog input

See 3.1D

Wire the analog input module as shown, referring to the product label. The unit accepts input from up to four thermocouple sensors. (To use less than four sensors, select your number of sensors in 6.2D.)

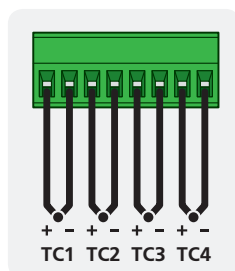

Note that you must start wiring from channel 1. (I.e. For 2 channels, use CH1–2, not CH3–4.)

3.3 - Relay outputs

See 3.1A

If your controller has relay outputs fitted, wire them as shown. Relays can be programmed to operate within the total span range of the controller.

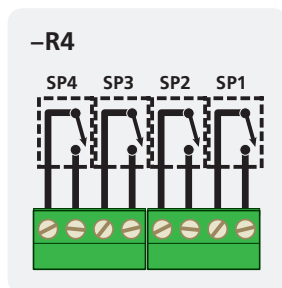
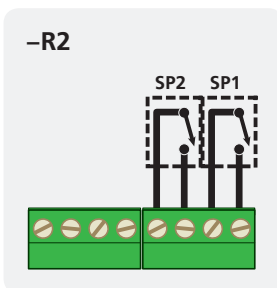

3.4 - Analog output

See 3.1C

If your controller has analog output fitted, wire it as shown for either voltage (0–10V) or current (4–20mA).

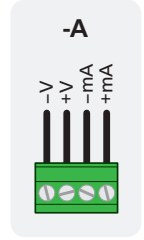

3.5 - Serial port

See 3.1B

If your controller has serial port fitted, wire it as shown in the applicable diagram. (S2R: RS232, RJ11 terminal, S4S: RS485, screw terminal).

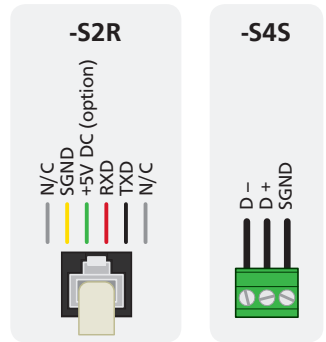

3.6 - Function pins

See 3.1E

Connect external switches as shown to enable a function to be executed when its switch is activated.

- › **Pk/Val** Resets the peak and valley readings
- › **Hold** Holds the current display value
- › **Test** Resets the meter

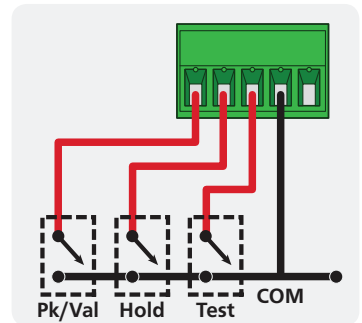

Note that if you have activated the multiplex feature by setting your analog output source to **MPX** in 6.6B, then the 'Pk/Val' and 'Hold' pins will not perform the functions described above. (See 5.4C for more information.)

3.7 - Power supply

See 3.1F

DO NOT attempt to wire your controller while the power is on. NEVER connect your low voltage controller to mains power.

Wire your controller for low or high voltage power supply, as show in the diagrams below. Check the label on the unit against the colour of the connector:

- › **Orange =**
High voltage (85–265V AC,
95–370V DC)
- › **Black =**
Low voltage (15–48V AC,
10–72V DC)

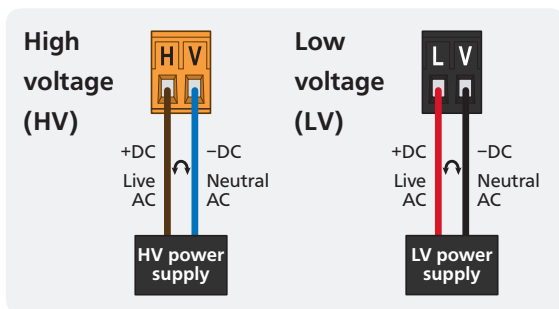

Once you have completed the wiring process it is safe to switch on your power supply. Ensure that your display is functioning before you proceed.

4

DIMENSIONS & INSTALLATION

4.1 - Case dimensions

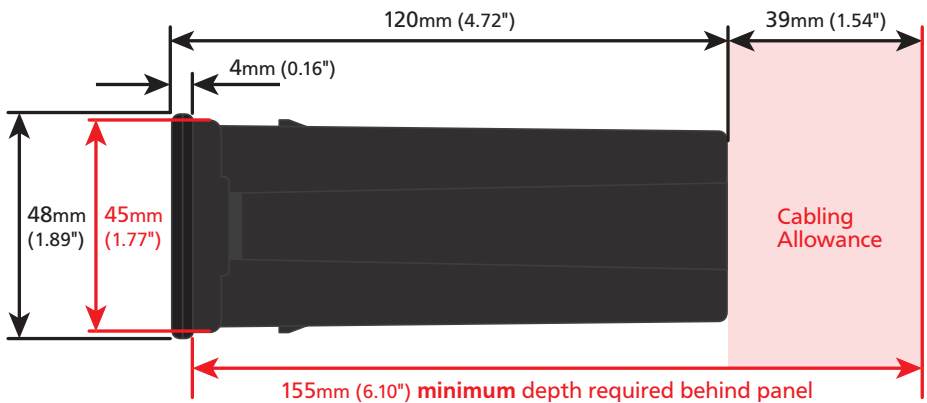
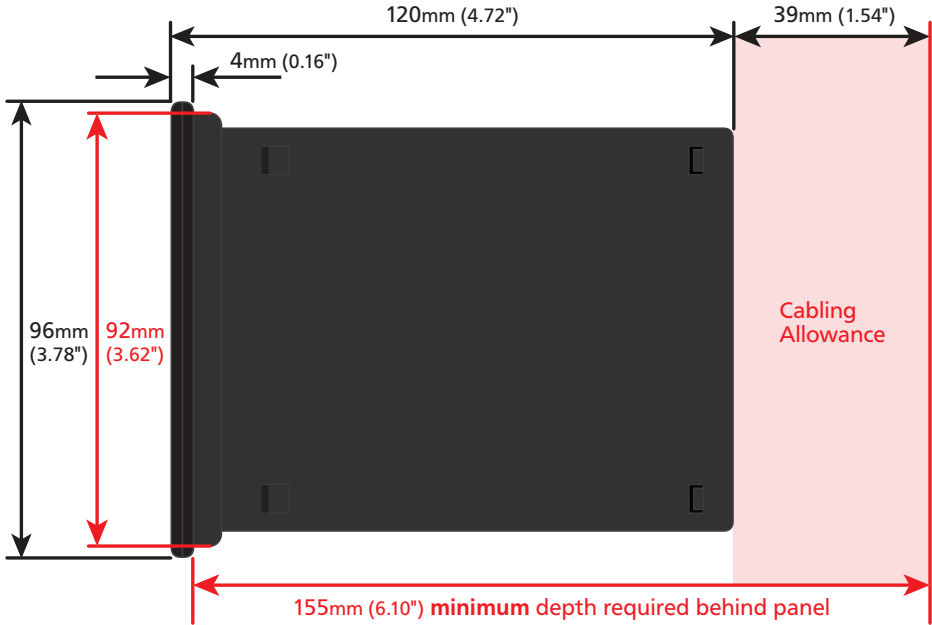

4.2 - Installation instructions

A Prepare the **Panel Cutout** to $92 \times 45\text{mm} \pm 0.5$ ($3.62 \times 1.77" \pm 0.02$), as shown below.

Allow at least 155mm (6.10") depth behind the panel to accommodate the meter body, protruding connectors and cabling.

B Remove the **Mounting Clips** from the meter back.

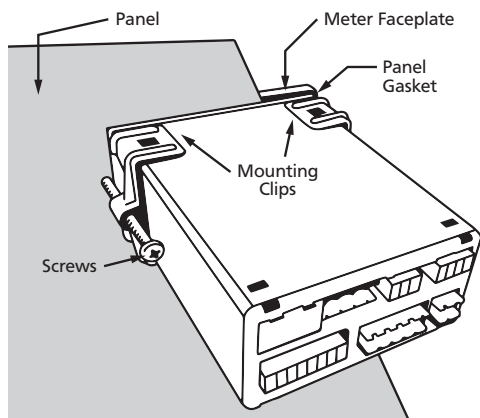

C Slide the **Panel Gasket** over the rear of the unit to the back of the **Meter Faceplate**.

D From the front of the panel, insert the meter into the **Panel Cutout**. Holding the unit in place, engage the **Mounting Clips** so that the tabs snap into place over the notches on the case.

E To achieve a proper seal, tighten the **Screws** evenly until the unit sits firmly against the panel. Do not over-tighten the screws.

Panel Cutout

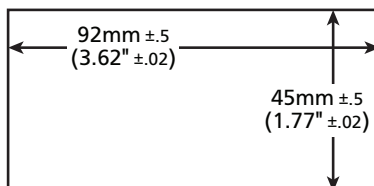

5.1 - Available data sources

The table below shows the data sources that are available for the various controller outputs. See 5.2–5.5 for more information.

	Display	SP	Analog O/P	Serial O/P	Peak/Valley
DISP		✓	✓	✓	✓
AUTO	✓				
TEMP 1–4	✓	✓	✓	✓	✓
AVETMP	✓	✓	✓	✓	✓
MAXTMP	✓	✓	✓	✓	✓
MINTMP	✓	✓	✓	✓	✓
MPX			✓		
PEAK	✓	✓	✓	✓	
VALLEY	✓	✓	✓	✓	

5.2 - Display

The data source for the Display determines what will be displayed on the screen when the controller is in normal operating mode - you can set this in 6.3B.

Most of the available data sources can be selected (see 5.1). You can also select 'AUTO', which will cause the display to cycle continuously through the four temperature input channels.

While 'Display' has its own data source, it can also be *used as a data source* - for a setpoint, the analog output, the serial output, or the peak and valley values. This will essentially mirror the display data source to the selected output, allowing the cycling 'AUTO' feature to be used with other outputs, if desired.

5.3 - Temp 1 – Temp 4

An individual temperature channel can be used as a data source by selecting **TEMP 1**, **TEMP 2**, **TEMP 3** or **TEMP 4**. Individual temperature channels can be used as a data source for any kind of controller output (see 5.1).

5.4 - Multi channel data sources

For multi channel functions to operate correctly, you must specify how many channels are to be included in the sample range (see 6.3G: 'Number of Channels for Multi Channel Functions').

Note that the controller will assign channels sequentially if you select less than 4. I.e. Selecting 2 CH will use channels 1–2; 3 CH will use channels 1–3. 4 CH will use channels 1–4.

A Average Temperature

The Average Temperature (rendered on your LED display as '**AVETMP**') is a calculated value, created by averaging 2, 3 or 4 of the thermocouple input channels, as selected in 'Number of Channels for Multi Channel Functions' (6.3G).

This value can be used as the default view for the operational display, or as a data source for analog output, serial output, setpoint control, or the peak and valley values. The **AVETMP** value can also be viewed via the  button on the main display (see 2.3).

B Max/Min Temperature

Max Temperature (**MAXTMP**) and Min Temperature (**MINTMP**) are the maximum and minimum instantaneous temperatures, taken over the number of channels selected in 'Number of Channels for Multi Channel Functions' (6.3G).

For example, if you selected **3 CH** in 6.3G, then the controller will sample channels 1–3 continually to maintain up-to-date **MAXTMP** and **MINTMP** values. If CH1=60.5, CH2=60.8 and CH3=60.6, then the **MAXTMP** value at that point in time will be 60.8, and the **MINTMP** value will be 60.5.

The **MAXTMP** or **MINTMP** value can be used as the default view for the operational display, or as a data source for analog output, serial output, setpoint control, or the peak and valley values.

C Multiplexing

The Multiplex (**MPX**) feature was designed for PLC interface, and allows the PLC to determine, via the controller's 'Pk/Val' and 'Hold' function pins (see 3.6), which temperature channel will be used as a data source for the analog output.

To activate this feature, your analog output data source must be set to **MPX** (see 6.6B). When you activate **MPX**, the default functions of the 'Pk/Val' and 'Hold' pins will be deactivated, and the pins will be used to determine which temperature channel is used for the analog output, as shown in the table below.

Channel	Pk/Val	Hold
TEMP 1	OFF	OFF
TEMP 2	ON	OFF
TEMP 3	OFF	ON
TEMP 4	ON	ON

Note that when changing the 'Pk/Val' or 'Hold' pins in **MPX** mode, you need to allow a settling time of at least 0.5 seconds before reading the analog output current.

5.5 - Peak & Valley

Peak and Valley are the maximum and minimum values measured since the instrument was turned on or reset. (These values differ from **MAXTMP** and **MINTMP**, in that they will hold the maximum and minimum values until they are reset.)

The Peak and Valley data source can be set (in 6.3F), to a range of options as shown in table 5.1.

Peak and Valley can be viewed from the front panel using shortcut keys (see 2.3), or appear continually on the main display (if you set one of these variables as your display data source). They can also be reset via the front panel (2.3), the rear pins (3.6), or by restarting the controller.

While 'Peak' and 'Valley' have their own data source, they can also be *used as data sources* - for the display, analog output, serial output, or setpoint control.

6

INPUT SETUP & CALIBRATION

6.1 - Enter F1 PIN number

A Enter the calibration mode by pressing the **F1** button.

___ **ENTER F1 PIN NUMBER** scrolls across the display and toggles with **0**. Use the **↑** and **↓** buttons to enter your security code (factory default 1). Then press **P**. If the correct PIN is entered, setup is started at 6.2.

If an incorrect PIN number is entered, ___ **INCORRECT PIN – ACCESS DENIED** scrolls across the display and it returns to normal operating mode.

You will have the opportunity to change your PIN number at the end of this section (6.8). If you have forgotten your PIN number, see Section 9.

6.2 - Input setup

A ___ **INPUT SETUP** scrolls across the display and toggles with **SKIP**. Press **P** to skip to 6.3, or the **↑** button and then **P** to **ENTER** input setup.



B ___ **MAINS FREQUENCY** scrolls across the display and toggles with the current selection. Use the **↑** and **↓** buttons to select **50HZ** or **60HZ**, and press **P**.

C ___ **SENSOR TYPE** scrolls across the display and toggles with the currently selected sensor type. Use the **↑** and **↓** buttons to select **J TYPE**, **K TYPE**, **R TYPE**, **T TYPE** or **N TYPE**, and then press **P**.

D ___ **NUMBER OF SENSORS** scrolls across the display and toggles with the current selection. Use the **↑** and **↓** buttons to select how many of the 4 temperature channels are connected. Then press **P**.

Channels are assigned sequentially. I.e. Selecting 2 CH will use channels 1–2; 3 CH will use channels 1–3, etc. See 3.2 for wiring.

E ___ **TEMPERATURE SCALE** scrolls across the display and toggles with the current scale. Use the **↑** and **↓** buttons to select **DEG C** (°C) or **DEG F** (°F), and then press **P**.



- F** ___ **AVERAGING SAMPLES** scrolls across the display and toggles with the current averaging. Using the  and  buttons, alter the number of input samples that the controller will average, and then press .

This feature allows signal averaging of each individual input channel, to optimise stable measurement. (This is different from Multi-Channel Averaging, as explained in 5.4A.)

If the change in input exceeds the averaging window value it will not average, ensuring fast response when there are large differences between readings.

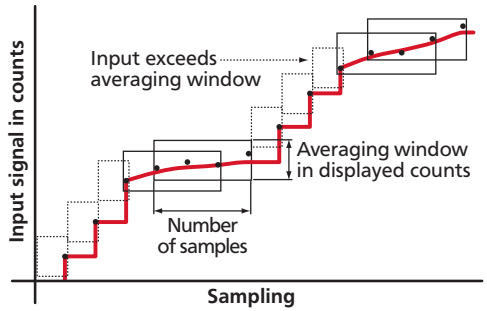





*Increasing the number of **AVERAGING SAMPLES** will stabilise measurement, but it will also slow down response rates.*



- G** ___ **AVERAGING WINDOW** scrolls across the display and toggles with the currently selected signal averaging window value. Using the  and  buttons, alter the signal averaging window. Then press .

*If your input signal contains large noise spikes, you can increase the size of the averaging window to ensure that these are still averaged. However, increasing the window size too far will reduce the ability of the controller to respond quickly to real changes in input signal. Setting **AV-ERAGING WINDOW** to 0 will give continuous averaging as per the selected averaging samples.*













6.3 - Display setup

- A** ___ **DISPLAY SETUP** scrolls across the display and toggles with **SKIP**. Press  to skip to 6.4, or the  button and then  to **ENTER** display setup.
- B** ___ **DISPLAY SOURCE** scrolls across the display and toggles with the currently selected display source. Use the  and  buttons to choose between: **AUTO**, **TEMP 1**, **TEMP 2**, **TEMP 3**, **TEMP 4**, **AVETMP**, **MAXTMP**, **MINTMP**, **PEAK**, or **VALLEY**. Then press .

- ➔ If you selected **AUTO**, continue to 6.3C now.
- ➔ If you selected something else, skip to 6.3D now.



Note that your options in this step will be limited by the 'Number of Sensors' selected in 6.2D. For more information about display data sources, see 5.2.

*In **Auto** mode, the main display constantly cycles through all available input channels (i.e. **TEMP 1**, followed by the current value for that channel, then **TEMP 2**, **TEMP 3** etc).*

- C** **___ DISPLAY TIME IN SECONDS** scrolls across and toggles with the current selection. This setting is only used for **AUTO** display (see 6.3B), and is the pause time between variables as they cycle on the display. Use the  and  buttons to adjust this value as required, and then press .
- D** **___ UNITS** scrolls across the display and toggles with the current setting. Use the  and  buttons to select either **YES** or **NO**, and then press .
- E** **___ RESOLUTION** scrolls across the display and toggles with the currently selected resolution. Use the  and  buttons to choose between **1DEG** and **0.1**, and then press .
- F** **___ PEAK/VALLEY SOURCE** scrolls across the display and toggles with the currently selected peak and valley source. Use the  and  buttons to select: **DISP**, **TEMP 1**, **TEMP 2**, **TEMP 3**, **TEMP 4**, **AVETMP**, **MAXTMP** or **MINTMP**, and then press .







Note that your options in this step will be limited by the 'Number of Sensors' selected in 6.2D. Additionally, if your display source (6.3B) is set to either 'PEAK' or 'VALLEY', then 'DISP' will not appear as an option, as this would create a circular reference.

For more information about Peak/Valley data sources, see 5.5.













- G** **___ NUMBER OF CHANNELS FOR MULTI CHANNEL FUNCTIONS** scrolls across and toggles with the number of channels to be included in multi channel calculations, including the **AVETMP**, **MINTMP** and **MAXTMP** values. Use the  and  buttons to select: **NONE**, **2 CH**, **3 CH** or **4 CH**, and then press .

Note that your options in this step will be limited by the 'Number of Sensors' selected in 6.2D. For more information about multi-channel data sources, see 5.4.

6.4 - Clock setup











- A** **___ CLOCK SETUP** scrolls across the display and toggles with **SKIP**. If you do not wish to configure your clock now, press  to skip to 6.5. Otherwise, press the  button and then  to **ENTER** and set the date and time.
- B** **___ HOURS** scrolls across the display and toggles with the current selection. Use the  and  buttons to adjust the hour (from **0** to **23**), and press .

The controller's internal clock uses 24 hour time; you cannot select a.m. or p.m.

- C **___ MINUTES** scrolls across the display and toggles with the current selection. Use the  and  buttons to adjust the minutes (from **0** to **59**), and press . After pressing  the seconds timer will be reset to zero, and will immediately begin counting.
- D **___ DATE** scrolls across the display and toggles with the current selection. Use the  and  buttons to adjust the date (from **1** to **31**), and press .
- E **___ MONTH** scrolls across the display and toggles with the current selection. Use the  and  buttons to select a month (from **JAN** to **DEC**), and press .
- F **___ YEAR** scrolls across the display and toggles with the current selection. Use the  and  buttons to adjust the display to the current year, and press .

6.5 - Calibration

When calibration is complete, you will be directed back to the start of the calibration menu (6.5A). To proceed to 6.6, you must select **SKIP** at 6.5A.

- A **___ CALIBRATE** scrolls across the display and toggles with **SKIP**. Press  now to skip to 6.6, or use the  and  buttons to select a channel to calibrate (**TEMP 1**, **TEMP 2**, **TEMP 3** or **TEMP 4**), and then press .
- The number of channels available for calibration are determined in 6.2D (Number of Sensors).*
- B **___ APPLY LOW TEMPERATURE** --- **ENTER LOW DISPLAY VALUE** scrolls across the display, and the currently selected low display value appears. Apply the required low level temperature to the meter, and wait a moment for the signal to stabilise. Then use the  and  buttons to set the required low level display value, and press  to accept.
- C **___ APPLY HIGH TEMPERATURE** --- **ENTER HIGH DISPLAY VALUE** scrolls across the display, and the currently selected high display value appears. Apply the required high level temperature to the meter, and wait a moment for the signal to stabilise. Then use the  and  buttons to set the required high level display value, and press  to accept.
- D If calibration was successful, you will be directed back to 6.5A to select a new

channel to calibrate. (To enter step 6.6, you must select **SKIP** at 6.5A.)

If calibration fails, **___ CALIBRATION FAILED** will scroll across the display twice, and then you will be directed back to 6.5A to try calibrating again.

The most likely cause of this message is that the controller has not detected any change in input signal during the calibration process. Check your signal and connections, and then repeat the calibration procedure.

6.6 - Analog output setup

*N.B. All new units are calibrated before shipping. Recalibration is **only** necessary if settings are wiped or the unit's accuracy requires verification after a long period of use. e.g. 1 year.*

A ___ ANALOG OUTPUT SETUP scrolls across the display and toggles with **SKIP**. If your controller does not have analog output installed, (or you do not wish to configure your analog output now), press **P** to skip to 6.7.

Otherwise, press the **↑** button and then **P** to **ENTER** analog output setup.

B ___ DATA SOURCE FOR ANALOG O/P scrolls across the display and toggles with the current analog output data source. Use the **↑** and **↓** buttons to select an option from: **DISP, TEMP 1, TEMP 2, TEMP 3, TEMP 4, AVETMP, MAXTMP, MINTMP, PEAK, VALLEY** or **MPX** (multiplex). Then press **P**.

*Note that your options in this step will be limited by the 'Number of Sensors' selected in 6.2D. See Section 5 for more information on analog output data sources, with specific reference to 5.4C for the **MPX** (multiplex) feature.*







C ___ LOW SCALE VALUE FOR ANALOG O/P scrolls across the display and toggles with the currently selected low scale display value. Use the **↑** and **↓** buttons and **↓** buttons to enter your cal low position, and then press **P**.

D ___ HIGH SCALE VALUE FOR ANALOG O/P scrolls across the display and toggles with the currently selected high scale display value. Use the **↑** and **↓** buttons to enter your cal high position, and then press **P**.

E ___ CALIBRATE ANALOG O/P? scrolls across and toggles with **SKIP**. Press **P** now to skip analog output calibration, or the **↑** button and then **P** to **ENTER**.

➔ If you selected **ENTER**, continue to 6.6F now.

➔ If you selected **SKIP**, skip to 6.7 now.



- F** **___ CAL LOW ANALOG O/P** scrolls across the display and toggles with a calibration number shown in internal units (around -16000). Before proceeding, connect a mA or volt meter across the analog output connector (see 3.4). Press the  or  buttons until the multimeter displays your target low output, then Press .
- G** **___ CAL HIGH ANALOG O/P** scrolls across the display and toggles with a calibration number shown in internal units (around 30000). Press the  or  buttons until the multimeter displays your target high output, then press .



Factory analog output calibration is precisely set before shipping this instrument, and should not be adjusted unless advised by the manufacturer.

6.7 - Serial setup

Refer to Appendix A for more information on serial modes and registers.

- A** **___ SERIAL SETUP** scrolls across the display and toggles with **SKIP**. If your controller does not have a serial port installed, (or you do not wish to configure your serial options now), please press  to skip to 6.8.

Otherwise, press the  button and then  to **ENTER** serial setup.

- B** **___ SERIAL MODE** scrolls across the display and toggles with the current serial mode. Use the  and  buttons to choose between: **ASCII** (custom), **MODBUS** (RTU), or **RNGR A** (Ranger A). Then press .

➔ If you selected **ASCII** or **MODBUS**, skip to 6.9D now.



➔ If you selected **RNGR A**, continue to 6.9C now.

ASCII is a simple, custom protocol that allows connection to various PC configuration tools. (This is different from the Modbus ASCII protocol.) See A.1 for more information.



MODBUS (RTU) is an industry standard RTU slave mode that allows connection to a wide range of devices, such as PC's or PLC's. See A.2 for more information.



RNGR A is a continuous output, used to drive instruments in the Rinstrum™ range. See A.3 for more information.



- C** **___ SERIAL DATA SOURCE** scrolls across the display and toggles with the

currently selected serial data source. Using the  and  buttons, select: **DISP**, **TEMP 1**, **TEMP 2**, **TEMP 3**, **TEMP 4**, **AVETMP**, **MAXTMP**, **MINTMP**, **PEAK**, or **VALLEY**, and then press .

Note that your options in this step will be limited by the 'Number of Sensors' selected in 6.2D. See Section 5 for more information about serial data sources.



D **___ BAUD RATE** scrolls across the display and toggles with the current selection. Use the  and  buttons to select one of: **1200**, **2400**, **4800**, **9600**, **19200**, **38400**, **57600** or **115200**. Then press .



E **___ PARITY** scrolls across the display and toggles with the currently selected parity. Using the  and  buttons, select: **NONE**, **ODD** or **EVEN**, and then press .

F **___ SERIAL ADDRESS** scrolls across the display and toggles with the currently selected serial address. Use the  and  buttons to alter the serial address, and then press .

*The serial address parameter is used to identify a particular device when it is used with other devices in a system. (It applies particularly to **MODBUS** mode when used on an RS485 serial network.) The serial address of the controller must be set to match the serial address defined in the master device.*

6.8 - Edit F1 PIN number

A **___ EDIT F1 PIN NUMBER** scrolls across the display and toggles with **SKIP**. Press  to skip and return to the operational display, or the  button and then  to **ENTER** and change your PIN number.

B **___ ENTER NEW F1 PIN NUMBER** scrolls across the display and toggles with the current PIN (default 1). Using the  and  buttons, enter your new F1 PIN number. Then press  to exit to the operational display.

7

SETPOINT SETUP

Your controller will allow configuration of up to 6 setpoints, however full functionality is only supported when relay output hardware is installed.

(Setpoints with no corresponding relay output hardware may be used as simple LED indicators, if desired. In this case, features requiring relay output functionality will continue to appear in the setup menu, but will be ignored by the controller.)

7.1 - Enter F2 PIN number

- A Enter setpoint setup mode by pressing and holding the **F2** button for 3 seconds. **__ _ _ ENTER F2 PIN NUMBER** scrolls across the display and toggles with **0**. Use the **↑** and **↓** buttons to enter your security code (factory default 1). Then press **P**. If the correct PIN is entered, setup is started at 7.2.

If an incorrect PIN number is entered, **__ _ _ INCORRECT PIN – ACCESS DENIED** scrolls across the display and it returns to normal operating mode.



You will have the opportunity to change your PIN number at the end of this section (7.3). If you have forgotten your PIN number, see Section 9.

7.2 - Setpoint setup

- A **__ _ _ EDIT SETPOINT** scrolls across the display and toggles with **SKIP**. Press **P** now to skip to 7.3, or use the **↑** and **↓** buttons to select a setpoint to edit, and then press **P**.
- B **__ _ _ SP VALUE** scrolls across the display and toggles with the current value for the selected setpoint. Using the **↑** and **↓** buttons, adjust the display value at which the selected setpoint will activate, and then press **P**.



C The step that you proceed to now will depend on which setpoint you are editing (selected in 7.2A):

- ➔ If you are currently editing **SP 1**, skip to 7.2E now.
- ➔ If you are currently editing **SP 2–6**, continue to 7.2D now.



D **___ TRACK SP1** scrolls across the display and toggles with the tracking setting for the selected setpoint. Using the  and  buttons, select **OFF** or **ON**, and then press .

- ➔ If you selected **OFF**, continue to 7.2E now.
- ➔ If you selected **ON**, skip to 7.2F now.



*A setpoint with **TRACK SP1** enabled will track the setpoint value of **SP 1**, with the setpoint value of the tracking setpoint becoming an offset value.*

E **___ SP SOURCE** scrolls across the display and toggles with the activation source for the selected setpoint. Use the  and  buttons to select an option from: **DISP**, **TEMP 1**, **TEMP 2**, **TEMP 3**, **TEMP 4**, **AVETMP**, **MAXTMP**, **MINTMP**, **PEAK**, or **VALLEY**, and then press .

Note that your options in this step will be limited by the 'Number of Sensors' selected in 6.2D. See Section 5 for more information on setpoint data sources.

F **___ SP ACTIVATION** scrolls across the display and toggles with the current activation for the selected setpoint. Using the  and  buttons, select the relay activation to operate **ABOVE** or **BELOW** the setpoint value, and then press .

***ABOVE**: Relay turns on above the setpoint value and off below it. **BELOW**: Relay turns on below the setpoint value and off above it.*

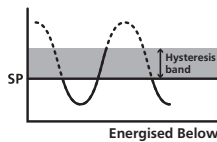
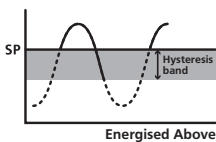

G **___ SP TYPE** scrolls across the display and toggles with the hysteresis type for the selected setpoint. Using the  and  buttons, select either **ALARM** or **CNTRL** (control), and then press .

***ALARM - SETPOINT VALUE** controls setpoint activation point. **HYSTERESIS VALUE** controls setpoint deactivation point.*



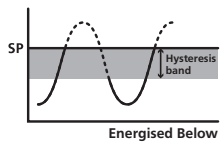
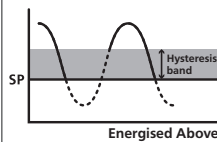





***CNTRL - SETPOINT VALUE** controls setpoint deactivation point. **HYSTERESIS VALUE** controls setpoint reactivation point.*





H ___ **HYSTERESIS VALUE** scrolls across the display and toggles with the hysteresis value for the selected setpoint. Use the  and  buttons to adjust this value if required, and then press .

*The **HYSTERESIS VALUE** defines the separation band between setpoint activation and deactivation, and will operate as per the **SP TYPE** setting selected in 7.2G.*



I ___ **MAKE DELAY** scrolls across the display and toggles with the current make delay time for the selected setpoint. This is the time delay between setpoint activation, and when the relay turns on. Adjust this value in 0.1 second increments using the  and  buttons, and then press .



J ___ **USER ACCESS?** scrolls across the display and toggles with the direct access permission setting for the selected setpoint. Use the  and  to select either **OFF** or **ON**, and then press .

When enabled, this option allows the selected setpoint's value to be edited directly after pressing the  button, without needing to enter a PIN number or go through all of the other options. Each setpoint can individually have this option enabled or disabled. See Section 8.

K ___ **EDIT SETPOINT** scrolls across the display and toggles with **SKIP**. You are now back at 7.2A. To edit another setpoint, follow the instructions from 7.2A–K again. If you do not wish to edit another setpoint, press  now to skip to 7.3.

7.3 - Edit F2 PIN number

A ___ **EDIT F2 PIN NUMBER** scrolls across the display and toggles with **SKIP**. Press  to skip and return to the operational display, or the  button and then  to **ENTER** and change your PIN number.

B ___ **ENTER NEW F2 PIN NUMBER** scrolls across the display and toggles with the current PIN (default 1). Using the  and  buttons, enter your new F2 PIN number. Then press  to exit to the operational display.

8

SETPOINT DIRECT ACCESS

When this feature is enabled, the selected setpoint will be editable via the **F2** button without entering a PIN.

If none of the setpoints have their direct access option enabled in 7.2J then this feature will be disabled and the **F2** button will not respond to a short button press.

- A Begin by pressing the **F2** button for less than 3 seconds.
- B The name of the first access-enabled setpoint will appear on the display and toggle with the current value for that setpoint. Using the **↑** and **↓** buttons, adjust the selected value. Then press **P** to accept and continue.
- C The name of the next access-enabled setpoint will appear on the display, along with its setpoint value. Repeat step 8B. The direct access menu will proceed through all access-enabled setpoints in this fashion. Pressing **P** for the last enabled setpoint will exit and return to the operational display.

9

RESET PIN NUMBERS / VIEW FIRMWARE VERSION

If you have forgotten your PIN number(s), follow the procedure below to reset both the F1 and F2 PINs to their factory default of 1.

This procedure will also allow you to view the current software installed on your controller, which may be required for support purposes.

- A Press **↑**, **↓** and **P** at the same time. (This key combination can be difficult to execute and you may need several tries to get it right.)
- B A message will appear on the display, with details of the unit's current software configuration (Product Name, Firmware Version, and Macro Version). At the end, you will see – **ALL PIN NUMBERS RESET TO 1**.
- C Reset the default PIN numbers if required by following the instructions in 6.8 and 7.3, entering '1' whenever you are prompted for your current PIN.

A.1 - Custom ASCII mode

Custom ASCII is a simple, custom protocol that allows connection to various PC configuration tools. ('Custom ASCII' differs from the 'Modbus (ASCII)' protocol used by some devices.) Custom ASCII command strings must be constructed in this order:

**<Start> <Controller Address> <Read/Write Command> <Register Address>
<Separator Character> <Data Value> <Message Terminator>**

Start - Use 'S' for the start character of a command string (not case sensitive). This must be the first character in the string.

Controller Address - Use an ASCII number from '1' to '255' for the controller address. If the character following the start character is not an ASCII number, then address '0' is assumed. All controllers respond to address '0'.

Read/Write Command - Use ASCII 'R' for read, 'U' for unformatted read, or 'W' for write (not case sensitive). Any other character aborts the operation.

In Custom ASCII mode, data is normally read as formatted data (which includes decimals and any text characters that may be selected to show units). However it is also possible to read unformatted data by using a 'U' in the read command. There is no unformatted write command, as when writing to fixed point registers, any decimal point and text characters are ignored.

Register Address - The register address for the read/write operation will be an ASCII number from '1' to '65535'. This character must be specified for a write command, but may be omitted for a read command, (in which case the controller will respond with the data value currently on the display).

Separator Character - The separator character can be either a space or a comma, and is used to separate the register address from the data value.

Data Value - Must be an ASCII number. The absolute limits for this number are -1000000 to +1000000, but note that not all registers will accept this range.

Message Terminator - This is the last character, and must be either a '\$' (dollar) or an '*' (asterisk). Neither of these characters should be used elsewhere in the

message string. If '\$' is used, a 50ms minimum delay is inserted before a reply is sent. If '*' is used, a 2ms minimum delay is inserted before a reply is sent.

Custom ASCII Read/Write Examples

Example	Description
SR\$	Read display value from all controllers, 50ms delay.
S15R\$	Read display value from controller address 15, 50ms delay.
S3U40*	Read unformatted data in channel 4 from controller address 3, 2ms delay.
S2W2 -10000\$	Write -10000 to the display register of controller address 2, 50ms delay.
SWT CHAN_1\$	Write ASCII text string Chan_1 to channel 1 text register, 50ms delay.

Custom ASCII Registers - *Active for models with relay output installed*

8 Bit Unsigned

Address	Function
8207	Baudrate
8211	Serial address
8215	Serial mode

16 Bit Unsigned

Address	Function
4181– 4184	Hysteresis (SP1=4181, SP2=4182, SP3 =4183, SP4=4184)
4197– 4200	Make delay (SP1=4197, SP2=4198, SP 3=4199, SP4=4200)

Note: Address **16543** is a read/write null terminated text string, into which you can write your own identification text (up to 62 characters).

32 Bit Signed

Address	Function
7	Temperature CH 1
17	Temperature CH 2
19	Temperature CH 3
21	Temperature CH 4
39	Average temperature
57	Peak
59	Valley
111	Setpoint 1
113	Setpoint 2
115	Setpoint 3
117	Setpoint 4
239	Alarm status
381	D/A scale low value
405	D/A scale high value

Controller Response - After the controller has completed a read or write instruction, it responds by sending a carriage return/line feed (CR/LF) back to the host. If the instruction was a read command, the CR/LF follows the last character in the

ASCII string. If it was a write command, CR/LF is the only response sent back. The host must wait for this before sending further commands to the controller. If the controller encounters an error, it will respond with a null (0x00) CR/LF.

A.2 - Modbus (RTU) mode

Modbus (RTU) is an industry standard RTU slave mode that allows connection to a wide range of devices. Modbus registers are all holding registers, and should be accessed via function codes 3 and 6.

Register addresses are displayed in the Modicon™ 5-digit addressing format. I.e. Register 65=400065 (subtract 1 for direct addressing).

Modbus (RTU) Registers - Active for models with relay output installed

8 Bit Unsigned

Address	Function
408207	Baudrate
408211	Serial address
408215	Serial mode

16 Bit Unsigned

Address	Function
404181– 404184	Hysteresis (SP1=404181, SP2=404182, SP3=404183, SP4=404184)
404197– 404200	Make delay (SP1=404197, SP2=404198, SP3=404199, SP4=404200)

32 Bit Signed (2 x 16 Bit)

LSW	MSW	Function
400007	400008	Temperature CH 1
400017	400018	Temperature CH 2
400019	400020	Temperature CH 3
400021	400022	Temperature CH 4
400039	400040	Average temperature
400057	400058	Peak
400059	400060	Valley
400111	400112	Setpoint 1
400113	400114	Setpoint 2
400115	400116	Setpoint 3
400117	400118	Setpoint 4
400239	400240	Alarm status
40587	40588	D/A scale low value
40591	40592	D/A scale high value

Note: Address **416543** is a read/write null terminated text string, into which you can write your own identification text (up to 62 characters). This is accessed using a standard Modbus read/write command for holding registers, where each 16 bit register holds 2 x ASCII string characters in sequence.

A.3 - Ranger A mode

Ranger A is a continuous output, used to drive remote displays and other instruments in the Rinstrum™ range. (Ranger is a trade name belonging to Rinstrum Pty Ltd.) Ranger A output strings are constructed as shown:

<Start> <Sign> <Output Value> <Status> <End>

Start - STX character (ASCII 02)

Sign - Output value sign (space for + and dash for -)

Output Value - Seven character ASCII string containing the current output value and decimal point. (If there is no decimal point, then the first character is a space. Leading zero blanking applies.)

Status - Single character output value status. 'U'=Under, 'O'=Over, 'E'=Error.

End - ETX character (ASCII 03)



Define Instruments

New Zealand (Head Office)

 10B Vega Place, Rosedale,
Auckland 0632, New Zealand
PO Box 245 Westpark Village,
Auckland 0661, New Zealand

Ph: +64 (9) 835 1550

Fax: +64 (9) 835 1250

 sales@defineinstruments.co.nz

www.defineinstruments.com

United States (Dallas, TX)

Ph: (214) 926 4950

 sales@defineinstruments.com

www.defineinstruments.com
