

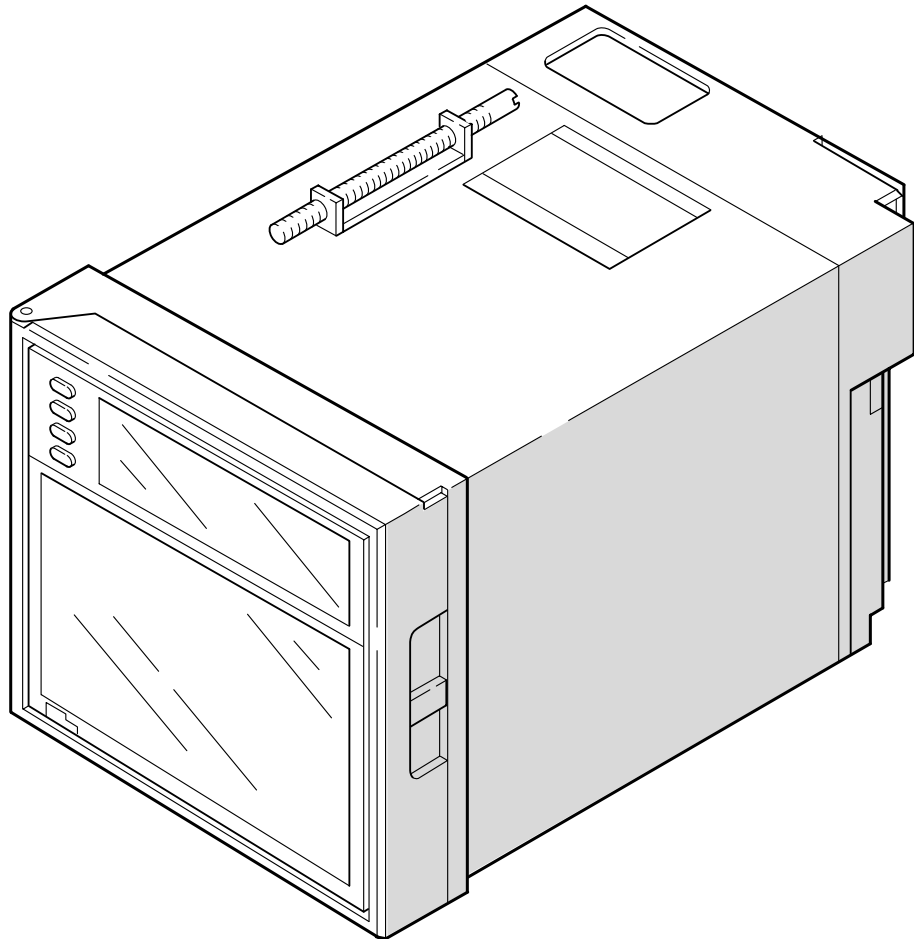

Instruction Manual

**MICROJET RECORDER**

**TYPE: PHC**



# PREFACE

---

Congratulations on your purchase of Fuji Micro-jet Recorder (Type: PHC)

- Read this instruction manual carefully to ensure correct installation, operation and preparation. Incorrect handling may lead to accident or injury.
- Specifications of this unit is subject to change without prior notice for improvement.
- Modification of this unit without permission is strictly prohibited.  
Fuji will not bear any responsibility for a trouble caused by such a modification.
- This instruction manual should be kept by the person who is actually using the unit.
- After reading the manual, be sure to keep it at a place easy to access.
- This instruction manual should be delivered to the end user without fail.

Manufacturer : Fuji Electric Co., Ltd.  
Type : Shown on nameplate of Micro-jet recorder  
Date of manufacture : Shown on nameplate of Micro-jet recorder  
Product nationality : Japan

## Request

- It is prohibited to transfer part or all of the manual without Fuji's permission.
- Description in this manual will be changed without prior notice.



© Fuji Electric Co., Ltd. 1996

Issued in Dec., 1996  
Rev. 1st edition July, 1997  
Rev. 2nd edition May, 1998  
Rev. 3rd edition March, 2000  
Rev. 4th edition Nov., 2002  
Rev. 5th edition April, 2005  
Rev. 6th edition March, 2008  
Rev. 7th edition April, 2011  
Rev. 8th edition Oct., 2011  
Rev. 9th edition March., 2012

# CAUTION ON SAFETY

First of all, read this "Caution on safety" before using the unit.

- The cautionary descriptions listed here contain important information about safety, so they should always be observed. Those safety precautions are ranked to 2 levels, DANGER and CAUTION.

 <b>DANGER</b>	Wrong handling may cause a dangerous situation, in which there is a risk of death or heavy injury.
 <b>CAUTION</b>	Wrong handling may invite a dangerous situation, in which there is a possibility of medium level trouble or slight injury or only physical damage is predictable.
 <b>PROHIBITION</b>	Items which must not be done are noted.

## Caution on Installation

 **DANGER**

- This unit is not an explosion-proof type. Do not use it in a place with explosive gases to prevent explosion, fire or other serious accident.

 **CAUTION**

- For installation, select a place observing the operating conditions noted in the instruction manual. Installation at an unsuited place may cause fall, trouble or malfunction.
- The unit must be installed correctly as shown in the instruction manual. Incorrect installation may cause fall, trouble or malfunction.
- During installation work, keep the inside of the unit free from entry of cable chips or other foreign objects as it may cause fire, trouble or malfunction.

 **CAUTION**

- This unit is a component device used for instrumentation. It is mounted on a panel or in a rack in an equipment.
- This unit conforms to IEC61010-1 Safety standards, overvoltage category II and pollution degree 2. Protection class is double insulation. However the heat sink of power supply on the rear side is basic insulation.
- Only power supply 24V DC and part of options(with limitations) are conformed to UL61010-1 standard. Regarding limitations of power supply, please refer to Item 4.3. Regarding limitations of option, please refer to Item 1.3 and 12. And if the equipment is used in a manner not specified by Fuji Electric Co., Ltd., the protection provided by the equipment may be impaired.



## CAUTION

- EMC conforms to EN61326-1, Class A (used for controlled electromagnetic environment((EMI)) and used for housing areas((EMS)) Therefore this unit is designed to operate in a controlled electromagnetic environment ,i.e. where radio frequency transmitters such as mobile phone may not be used in close proximity. In addition emissions which exceed the levels required by the standard may occur when this unit is connected to other equipment.
- Input signals and communication interface should be of SELV (safety separated from hazardous voltage).
- Only power supply 24DC V and part of options (with limitations) are conformed to UL61010-1 standard.  
Please refer to Item1.3 and 12.

### Caution of Wiring



## DANGER

- Wiring work must be performed as specified. If the unit is not earthed, it would result in electric shocks or malfunction.
- Be sure to connect power source that matches the rating. Connection of incorrect rating of power source may lead to fire.
- Before starting wiring work, be sure to turn OFF the main power to prevent electric shocks.
- Wiring materials to be used must meet the rating. Use of materials which do not withstand the rating may cause a fire accident.

### Caution on Maintenance



## DANGER

- When disposing of the recording head, put it in a vinyl bag and seal it to prevent the diffusion of ink. It should be handled as an imcombustible object when disposing of it.
- Ink is harmful to human body. Observe the following emergency treatments.
  - When ink gets in eyes, wash out for at least 5 minutes immediately with much clean water, and ask your doctor for treatment at once.
  - When ink gets on skin, wash out and clean skins with soap and water.
  - When ink is breathed in, move to a clean place immediately. If necessary, ask your doctor for treatment at once.
- Do not touch the connector at the rear of the carriage mounting the recording head to avoid the risk of electric shocks.

## Caution on Use



# DANGER

- If the fault or anomaly of the device may cause serious accident or troubles to other devices, externally install appropriate protective circuit to avoid accidents.
- The instrument has no power fuse. Install it if necessary. When fuse is blown out, check and remove the cause of it, and replace it with new one specified in the instruction manual. Do not use any other fuse or short it, as it may cause electric shocks or fire.
- The following safety symbols are used on PHC SERIES.



Caution (To avoid injury, operator must refer to the explanation in the manual.)



Be careful of electric shock.



Protective ground terminal



Functional ground terminal (do not use this terminal as a protective ground terminal)



Alternating current



Direct current



ON (power)



OFF (power)

# CONTENTS

---

PREFACE .....	i
CAUTION ON SAFETY .....	ii
1. INTRODUCTION .....	1-1
1.1 Microjet recorder .....	1-1
1.2 Product check .....	1-1
1.3 Check on type and specification .....	1-2
2. NAMES AND FUNCTIONS OF PARTS .....	2-1
3. MOUNTING METHOD .....	3-1
3.1 Mounting location .....	3-1
3.2 External dimensions and panel cut out dimensions .....	3-1
3.3 Method of mounting onto panel .....	3-2
4. WIRING .....	4-1
4.1 Before doing the wiring .....	4-1
4.2 Connection of wires to terminals .....	4-2
5. SET-UP .....	5-1
5.1 Loading chart paper .....	5-1
5.2 Recording head installation (replacement) .....	5-5
5.3 Changing the type of input signals .....	5-10
6. OPERATING AND ACTIONS .....	6-1
6.1 Before running the equipment .....	6-1
6.2 Power switch-on and states .....	6-2
6.3 Test pattern print-out .....	6-3
6.4 Actions during operation .....	6-3
6.5 Displays and print-outs on detection (cancellation of alarm) .....	6-5
6.6 Displays and print-outs on occurrence of burn-out .....	6-5
6.7 Over-range, under-range display and abnormal input display .....	6-6
6.8 Display and record when chart paper runs out ("Chart End" display) .....	6-6
6.9 Display and record when the recording head ink is low ("Ink Out" display) .....	6-6
6.10 Display when data backup batteries need to be replaced ("Battery End" display) .....	6-7
6.11 Display of fault in recording head carriage ("Carriage Alarm" display) .....	6-7
6.12 Order of priority of state displays .....	6-7
7. SETTING AND CHECKING PARAMETERS .....	7-1
7.1 Setting and checking .....	7-1
7.2 Outline of procedure for setting parameters .....	7-4
7.3 Pass code setting .....	7-6
7.4 Setting the chart speed .....	7-7
7.5 Setting alarms .....	7-9



Chapter 3,4 and chapter 8 should be observed for installation and maintenance of the unit. So, it must be performed by qualified engineers.

7.6	Setting the recording mode .....	7-10
7.7	Setting record ranges .....	7-14
7.8	Setting kind of input, skip, unit, filter, scaling and subtraction .....	7-16
7.9	Setting Tag Nos. ....	7-22
7.10	Message print specification .....	7-23
7.11	List print-out specification .....	7-26
7.12	Daily report specification .....	7-27
7.13	Specifying totalize function .....	7-28
7.14	Transmission specification (option) .....	7-30
7.15	Setting the time .....	7-32
7.16	Method of ink out clear .....	7-33
7.17	Turning the chart illumination lamp on/off (option) .....	7-34
8.	MAINTENANCE-INSPECTION .....	8-1
9.	APPLICATION FUNCTIONS .....	9-1
9.1	Adjustment of backlash .....	9-1
9.2	Zero/span adjustment for analog trend recording position .....	9-2
9.3	Setting of alarm latch and integrated total value print-out .....	9-3
9.4	Setting of PV shift .....	9-4
9.5	User definable unit .....	9-5
9.6	Setting of record error external output .....	9-6
9.7	Calibration of measured value .....	9-6
9.8	Change of record color .....	9-8
9.9	Language selection .....	9-8
10.	TROUBLESHOOTING .....	10-1
11.	EXAMPLES OF RECORD AND PRINT-OUTS .....	11-1
11.1	Periodic print-outs, scale print-outs .....	11-1
11.2	Digital print-out (Instantaneous values) .....	11-2
11.3	Parameter list print-out .....	11-2
11.4	Test pattern .....	11-3
11.5	Scale print-outs .....	11-3
11.6	Daily report print-out .....	11-4
11.7	Data sum list print-out .....	11-5
11.8	Message print (manual print) .....	11-5
11.9	Logging .....	11-6
11.10	Alarm print-outs .....	11-6
11.11	Burn-out print-out .....	11-6
11.12	Ink dry-up warning print-out .....	11-6
11.13	Record start mark .....	11-7
11.14	Chart speed change mark .....	11-7
11.15	Auto range change mark .....	11-7
12.	SPECIFICATION .....	12-1

# 1. INTRODUCTION

## 1.1 Microjet recorder

- ① This recorder is a multirange input recorder 100mm wide which can record up to a maximum of 6 points using thermocouple/resistance bulb and DC voltage input signals.
- ② It effects high-speed recording and gives clear analog trend records and digital print-outs in 6 colors.
- ③ The analog trend records can be given as continuous record type or as intermittent (dot) records. (See Section 1.3, Format specification.)
- ④ As well as providing records of measurement values, the standard unit has a wide range of print-out functions comprising, e.g., the print-out of dates, chart speed, measurement ranges, Tag Nos., daily reports and integrated totals.
- ⑤ Operation of the equipment is simple thanks to an easy-view display section which permits key-in of various items of set data.

## 1.2 Product check

Upon receiving the unit, check the appearance and accessories to make sure that they are not damages. Also, check that the accessories are supplied correctly.

Check on accessories

The unit comes with the accessories shown in Fig. 1-1. Please check that they are all there.

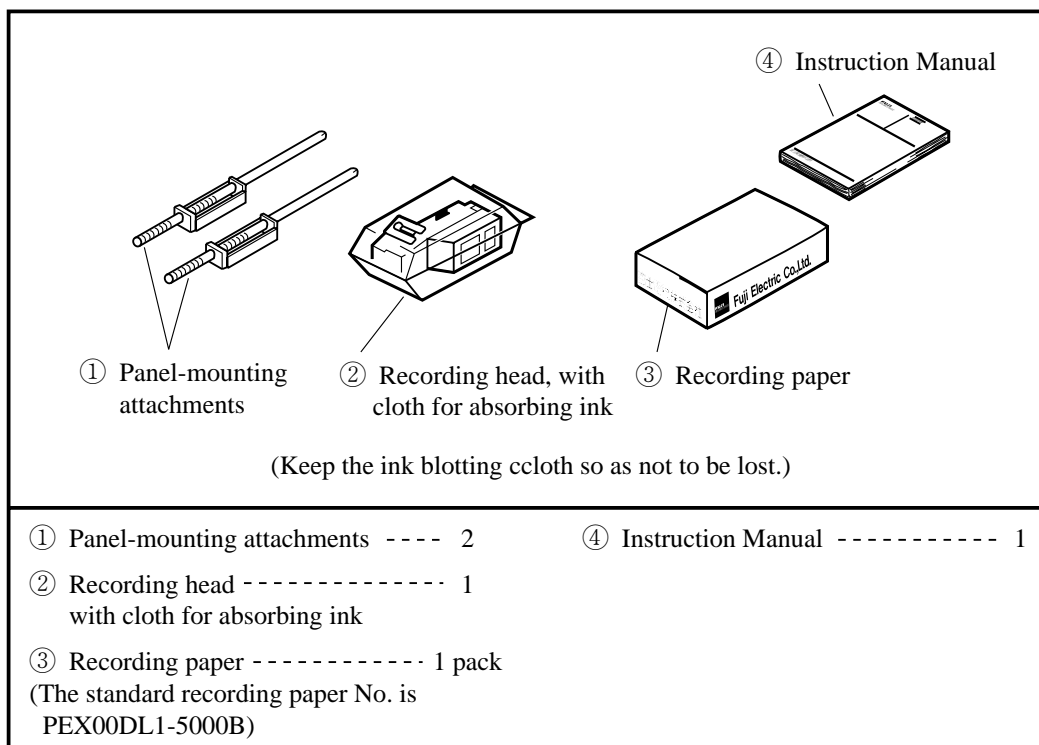

Fig. 1-1 Accessories



### 1.3 Check on type and specification

The data plates note the type name, etc. Please check to see that you have got a unit with the specification you ordered. (There are data plates on the top surface of the case and in the main unit.)

1 2 3 4 5 6 7 8			9 10 11 12 13 places					Description					
P	H	C					3		—				V/Y
			1										Number of recording points 1 continuous record 2 continuous record 3 continuous record 6 continuous record 6 dot records
			2										Number of input signal points (thermocouples)
			3										
			6										
			7										
			0										
			1										
			2										
			3										Number of input signal points (resistance bulbs)
			4										
			5										
			6										
			0										
			1										
			2										
			3										Number of input signal points (DC voltage)
			4										
			5										
			6										
			0										
			1										
			2										
			3										Power Supply 100 to 240V AC 50/60Hz Note 1) 24V DC
			4										
			5										CHART illumination * Without With
			6										
			0										Alarm output/external control * None 6-point alarm output (1a contact) /with 3-point external control Note 2) 6-point alarm output (1b contact) /with 3-point external control Note 1)
			1										
			2										
			Y										Communication * None With RS-485 Note 1)
			R										

The total number of points should be equal to the number of points of the 4th place.

- Value of input signal prior to delivery  
Thermocouple : K 0 to 1200°C  
Resistance bulbs : Pt100 0 to 500°C  
DC voltage : DC -5 to +5V

- Relations between input signal specifications and recording channels  
Ex.) If 3 thermocouple points, 2 resistance bulb points and 1 DC voltage points are specified. channels 1 - 3 are thermocouple channels 4 - 5 are resistance bulbs and channels 6 is DC voltage.

Note: After purchasing the unit, the type of input signal can be changed within the number of recording points (see Item 5.3).

Asterisks (\*) indicate options  
Note1) These functions are not conformed to UL61010-1 standard.  
Note2) It is conformed to UL61010-1 standard with conditions attached. Please refer to Item12 "Optional specifications" for details.

• Supplementary supplies

Product name	Type	Specification	Sales units
Recording head	PHZH1002	1 per unit	1
Recording paper (uniform 50 scale)	PEX00DL1-5000B	Approximately 15m (6 packs/box)	6 packs

## 2. NAMES AND FUNCTIONS OF PARTS

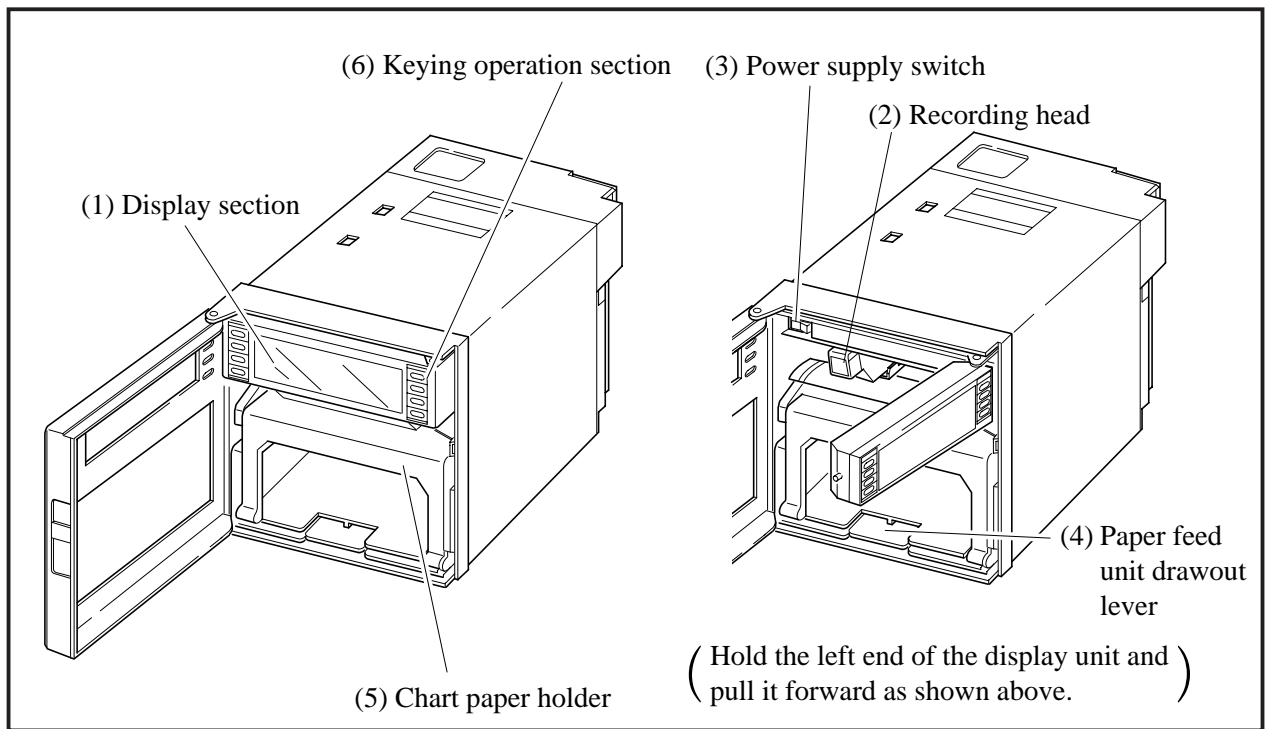

### (1) Display section

For displays such as measurement data and displays of various parameters and comments



← Display of units and data for each channel

← Display of various parameters, comments

### (2) Recording head

This is a recording head which serves for analog trend recording and digital print-outs. **As this is not installed in the main unit at the time of delivery, please install it referring to Section 5.2.**

### (3) Power supply switch

Used to turn the power on and off.

### (4) Paper feed unit drawout lever

When setting (or replacing) chart paper, push down the drawout lever. The paper feed unit will come out. If it does not come out, pull it forward while holding the lever down.



### (5) Chart paper holder

The chart paper holder is used to feed paper smoothly.

(6) Keying operation section

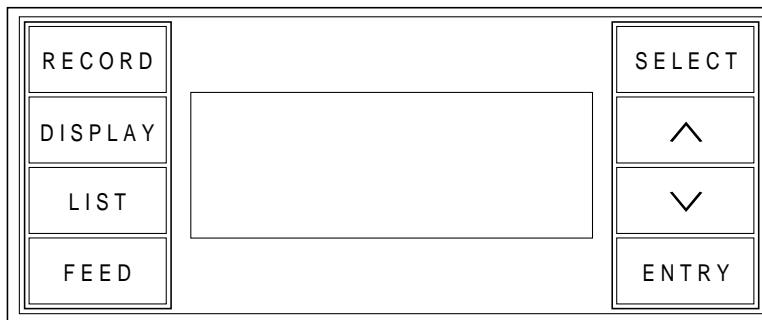
This is used for setting various parameters, making checks and running the equipment.



Name of key	Function
RECORD	Operation key for starting and stopping recording. Recording starts when the key is pressed once and stops when the key is pressed again. This key is ineffective during print-out of data or lists.
LIST	This is used for effecting print-out of data (instantaneous values). If you wish to stop the print-out partway through, press the key again. This key is always effective.
FEED	Chart paper fast-feed key Feed speed is 3mm/s at the beginning of press, and about 8mm/s after 1 second. This key is always effective.
DISPLAY	1. Used for changing the data display. The following 5 items are selected at each press. (1) Data of all channels are displayed in order, except for the skip channel. Data display is updated at intervals of 1 second and channels are selected every 3 seconds. (2) Display only of the data of specific channels. The data display is updated once every second. (3) No. 1 to 6 channels are displayed simultaneously, and data display is updated at 1 second intervals. (4) Display of the date and time. 2. This key is used for shifting from a set mode to the data display mode. This key is ineffective during print-out of data or lists.
SELECT	1. Used for shifting from the data display mode to a set mode. 2. Is used for effecting sequential read-out of parameters during operation in a set mode. This key is ineffective during print-out of data or lists.
ENTRY	Is used to register set data. This key is effective only during set mode operation.
  (up) (down)	Used to scroll numerical values up and down. The values are scrolled up or down 1 count each time the relevant key is pressed. Holding a key depressed for more than 0.5 seconds results in a fast up/down scroll at a rate of 5 counts/second and holding it depressed for a further 2 seconds results in an ultra-fast scroll of 55 counts/second.

Note) In this instruction manual some display of the keys are abbreviated as follows. RECORD key is indicated **[REC]**, DISPLAY key is indicated **[DISP]**, SELECT key is indicated **[SEL]**, ENTER key is indicated **[ENT]**.

### 3. MOUNTING METHOD

This unit is designed to be panel mounted.

#### 3.1 Mounting location

Select the following location for mounting the unit.

- (1) A place that is not subject to vibration or impact.
- (2) A place where there is no corrosive gas.
- (3) A place that is subject to little temperature variation and is close to normal temperature (23°C)
- (4) A place that is not struck directly by strong radiant heat.
- (5) As humidity affects the ink and recording paper, select a place that is in the range 20 to 80% RH.
- (6) Mount the unit horizontally, with no tilt to the left or right.  
(The forward tilt should be 0° but the unit may be inclined 0 to 30° rearwards.)

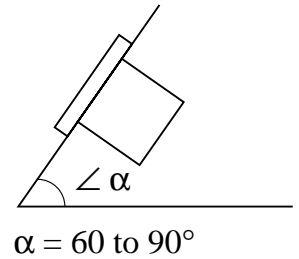

#### 3.2 External dimensions and panel cut out dimensions (unit: mm)

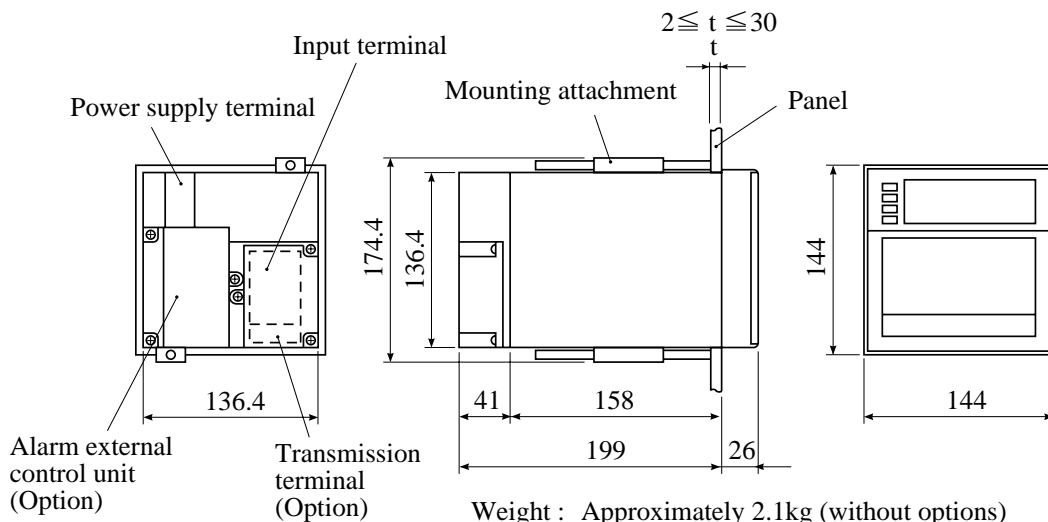

Power consumption : Approximately 26VA (100V AC with all options)  
Less than 26VA (26.4V DC with all options)

#### PANEL CUTOUT

For single unit mounting

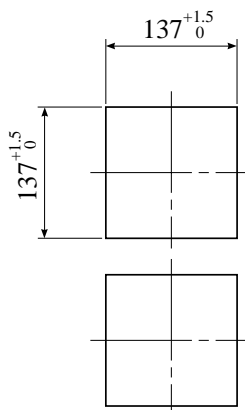

For left/right tight fit mounting

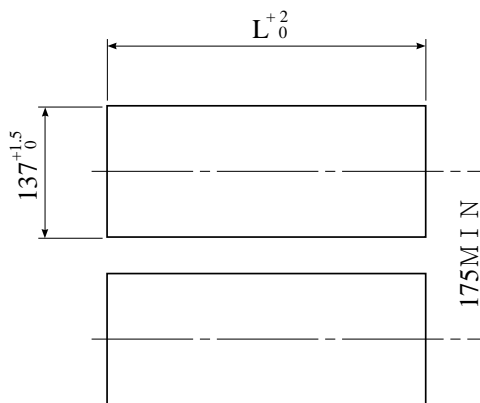

Number of units	$L_0^{+2}$ (mm)
2	282
3	426
4	570
5	714
6	858
7	1002
8	1146
9	1290
10	1434
n	$(144 \times n) - 6$

---

### 3.3 Method of mounting onto panel

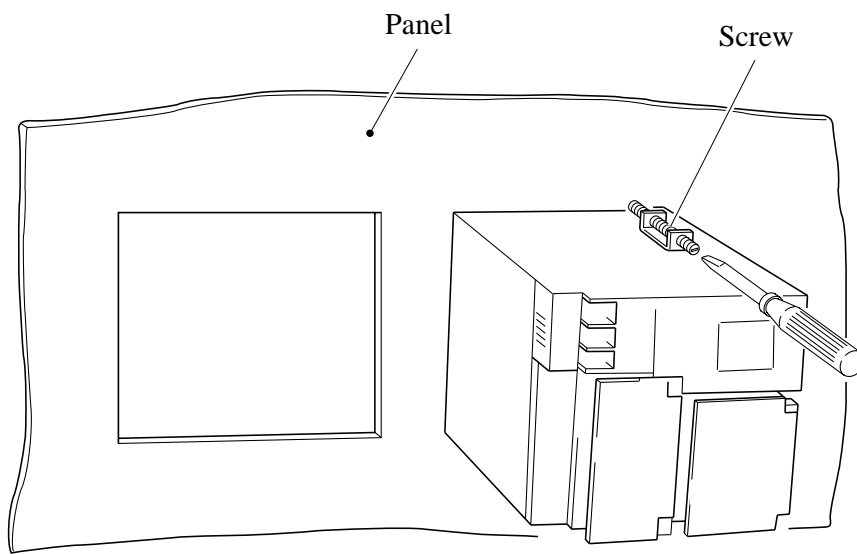

- Using the supplied mounting fixture, tighten the upper and lower screws until the panel is fixed.
- The panel to be used should be more than 2mm thick.

## 4. WIRING

### 4.1 Before doing the wiring

To carry out wiring, remove the unit's rear cover (Notes)

- ① When wiring the power supply unit, use vinyl-insulated 600V cables (JIS C 3307) or equivalent cables.
- ② For thermocouple input, be sure to use a compensated lead wire.
- ③ Input signal cables should be wired separately as far as possible (30cm or more) from power lines and high-voltage lines to minimize the effect of inductive noise. Shielded cables should preferably be used. In this case, the shield braids should be earthed at one point.
- ④ For wiring the terminals, use a maximum of 2 crimp style terminals.

Notes

- (1) At the completion of wiring of the input terminals, be sure to close the rear cover to ensure the compensation of reference contact when thermocouple input is used.
- (2) For connection of lead wires to terminals, use of sleeve-insulated clamping terminals (for M4 screws) is recommended.

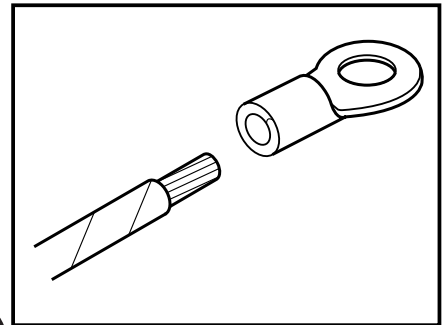

**CAUTION**

The recorder is not provided with a power fuse.

Use an external power fuse.

- In case the power supply is 100 to 240V AC  
Recommended fuse rating : T2A, 250V AC
- In case the power supply is 24V DC  
Recommended fuse rating : Maximum 3A,  
minimum 24V DC

## 4.2 Connection of wires to terminals

- (1) Input terminals ⇒ Connect signal leads for each channel.
- (2) Alarm, external control unit (option) ⇒ Connect the alarm signal outputs and external control signal inputs (for alarms 1 to 6, external controls 1 to 3).
- (3) Power terminal ⇒

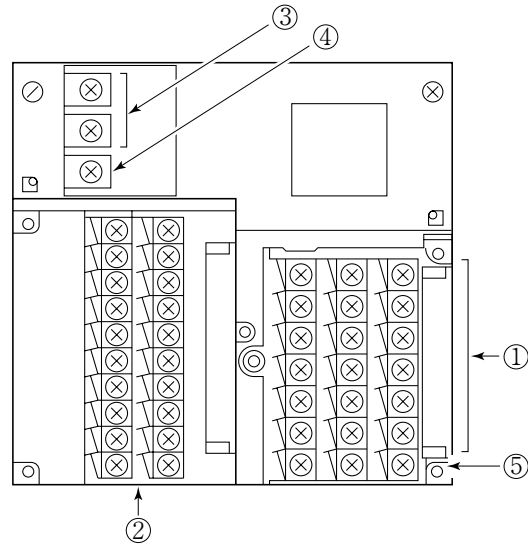

- 1) Connect the power cables to AC/AC terminals. (Supply voltage 100 to 240V AC products (9th digit of code symbol: “D”))  
This is the power for the specified type of 100 to 240 V AC (50/60Hz)
- 2) Connect power cable to  $\oplus$  DC24V  $\ominus$  terminals. (Power voltage 24V DC products (9th digit of code symbol: “L”))

 If you apply to exceeding 30V AC (Example: 100V AC and 240V AC) to 24V DC power materials, the equipment will be broken and never be fixed.

 For UL Certification, this unit is only supplied by 24V DC, complying with Limited Energy Circuit.

- 3) Power source to be connected should be free from noise.
- (4) Ground terminal ⇒ D-class grounding with ground resistance of 100Ω or less.
- (5) Transmission terminal (option) ⇒ Connect the transmission signals.



Alarm output terminals (⑭ to ⑰, ⑳ to ㉓) are of overvoltage category I. Other terminals (input signals, communication interface) are for SELV signals (safety separated from hazardous voltage).

**(1) Connection of input terminals**

- ① Each channel has its own input terminal No.
- ② Connect input terminals confirming the relation between the number of input points shown in the code symbols and their channels (see Item 1.3).
- ③ When the kinds of input signals have been changed after purchase of the unit (see Item 5.3), be sure to connect the terminals of corresponding channels.

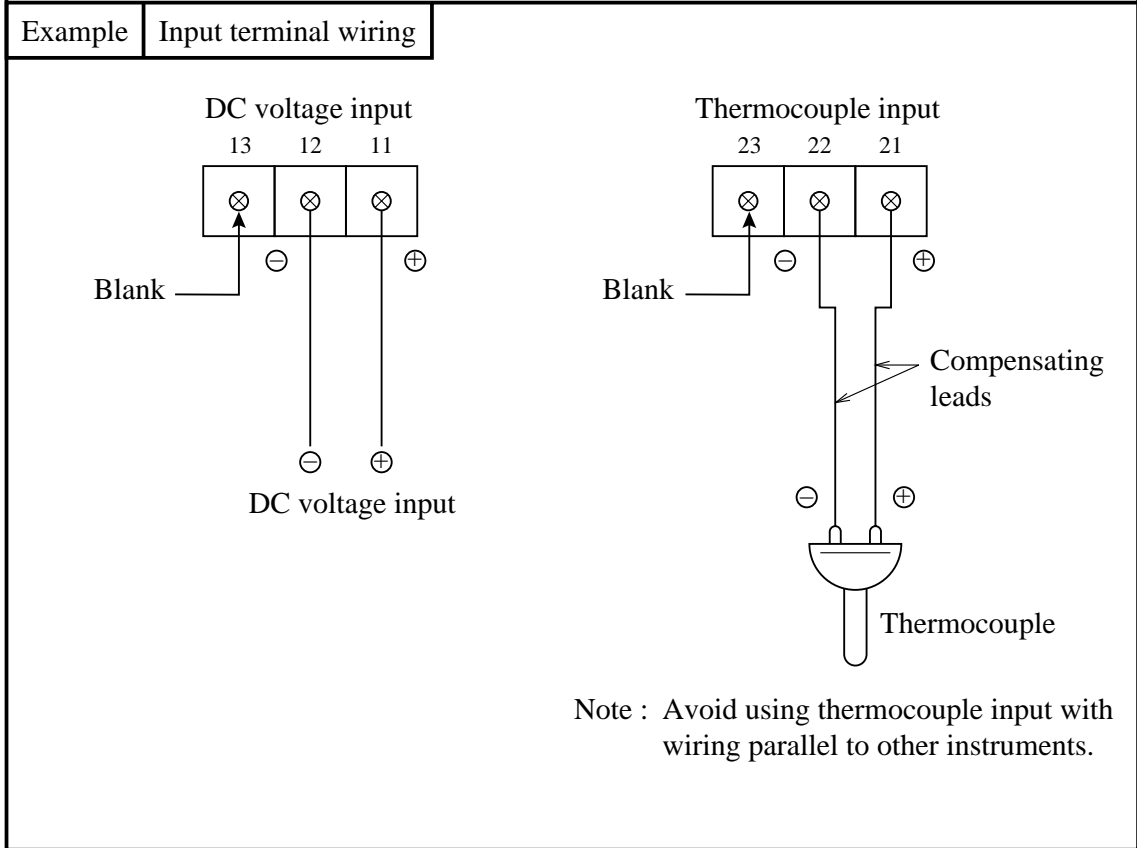
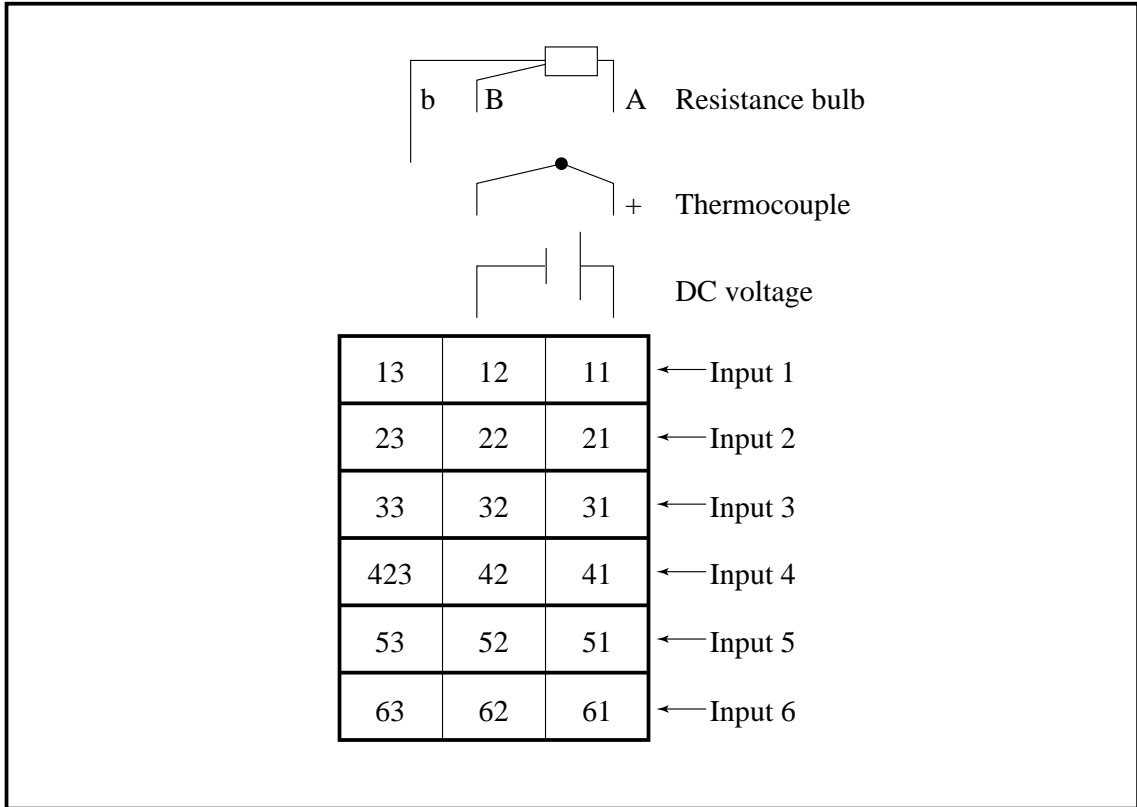



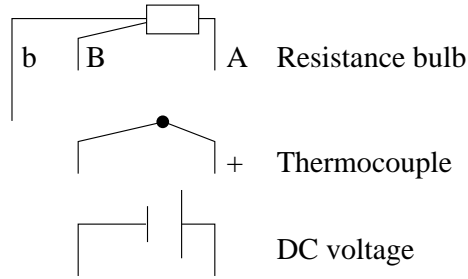

13	12	11	← Input 1
23	22	21	← Input 2
33	32	31	← Input 3
423	42	41	← Input 4
53	52	51	← Input 5
63	62	61	← Input 6

**Example**    **Input terminal wiring**

**Resistance bulb input**

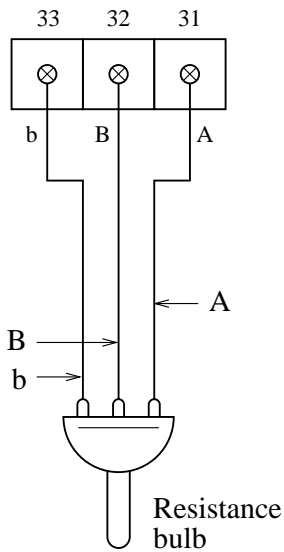

**DC current input**

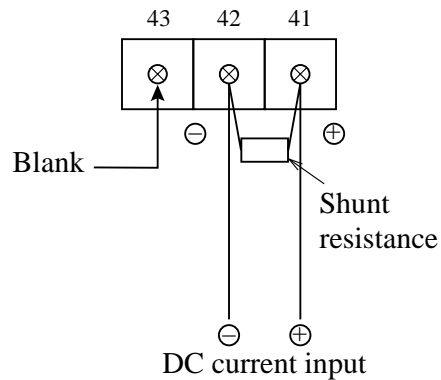

Example : 10Ω ±0.1% shunt resistance is used for 4 to 20mA and 10 to 50mA input.

[ In this case, ±500mV input range is available. See Item 5.3. ]

Note : DC current is converted into voltage by shunt resistor (10Ω):

In 4 to 20mA DC : 40 to 200mV DC

In 10 to 50mA DC : 100 to 500mV DC

---

## (2) Alarm output/remote control unit (option)

About alarm outputs :

- (1) Alarms can be set at 6 points in each channel and alarm outputs are provided as an option for up to a maximum of 6 points.
- (2) When an alarm is detected, the relevant terminals are shorted.  
1a contact output : Relay contact capacity 240V AC/3A, 30V DC/3A (resistive load)  
1b contact output : Relay contact capacity 125V AC/0.4A, 30V DC/2A (resistive load)

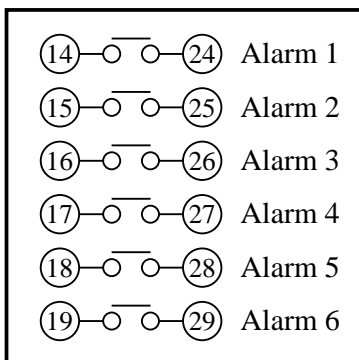

Note : If lamps are used on the outside, insert a resistor to prevent surge current.

Also, if relays or solenoids are used, insert elements for contact protection (diodes, surge killers, etc.).

About remote control inputs :

- (1) This performs the functions 'Recording operation start/stop', 'Two-stage changeover of recording paper speed' and 'Data (instantaneous value) print-out' in response to contact signals from outside the instrument.
- (2) There are separate wiring terminals for the different functions.

- |         |                          |       |   |
|---------|--------------------------|-------|---|
| ⑪—○—○—⑳ | (DI1) Record start       | ..... | Recording starts when the contact is closed and stops when it is open.  |
| ⑫—○—○—㉑ | (DI2) Chart speed change | ..... | The chart speed is the remote mode speed when the contact is closed and the normal operation speed when the contact is open.  |
| ⑬—○—○—㉒ | (DI3) Data print         | ..... | Print-out starts when the contact is closed and goes on right to the end even if the contact is opened partway through the print-out. If you wish to stop print-out partway through, press the <span style="border: 1px solid black; padding: 2px;">LIST</span> key on the front panel. |

Note 1: As the external control unit is not insulated, use it with interposition of an external relay.

External contact capacity 12V DC/0.05A 1a contact

Note 2: Operation with the external control unit and the front panel switches are shown in the table on next page.

(The sign "---" in the table does not affect the operation of the unit)

Note 3: When using the message print function or alarm latch function, the meaning of control input is different. Refer to "7.10 Message print specification" and "9.3 Alarm latch specification".

	Remote control						Front panel switch	
	Recording start (across terminals ①—②)		Chart speed change (across terminals ⑫—⑬)		Data print-out (across terminals ⑬—⑭)		RECORD	LIST
	ON	OFF	ON	OFF	ON	OFF		
While recording is stopped	Recording starts	---	---	---	List print-out starts	---	Recording starts	List print-out starts
During recording	---	Recording stops	Remote mode chart speed	Normal operation chart speed	List print-out starts	---	Recording stops	List print-out starts
List print out	Recording starts	---	---	---	---	---	---	List print-out stops

### (3) Caution on connection of input signal through barrier

- Thermocouple input and resistance bulb input.

Perform "Calibration of measured value" with the input connected to the barrier recorder because the barrier internal resistance is added and causes an error in the measured value.

For the calibration method, refer to Item 9.4.

## 5. SET-UP

### 5.1 Loading Chart Paper

Step 1

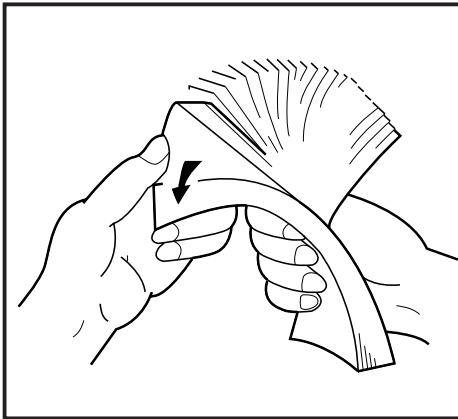

Prepare chart paper.

Loosen both ends of the chart paper thoroughly to prevent sheets from being fed together.

Step 2

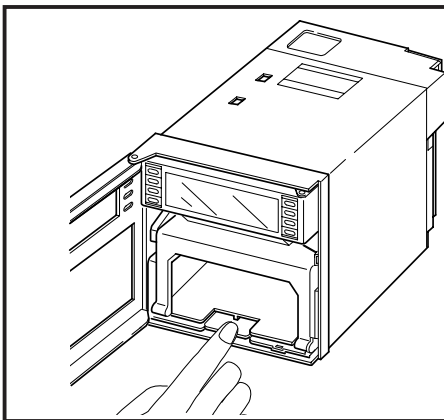

Open the front door and press down the paper feed unit drawout lever.

The paper feed unit will be drawn out.

Step 3

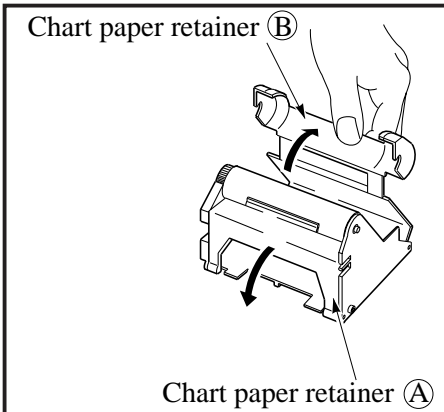

Chart paper retainer ②

Hold the chart paper retainer ② and open it backward.

Also, hold and open the chart paper retainer ①.

Chart paper retainer ①

Step 4

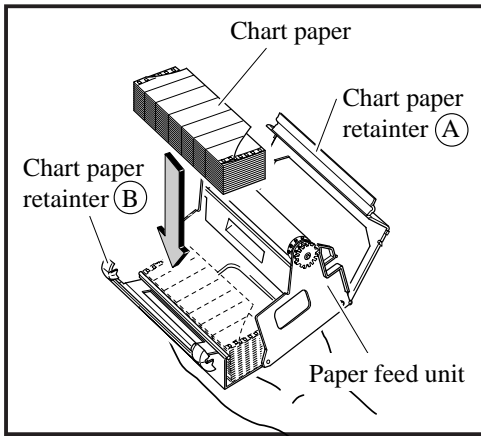

Set chart paper in the chart paper retainer (B) as illustrated.

Step 5

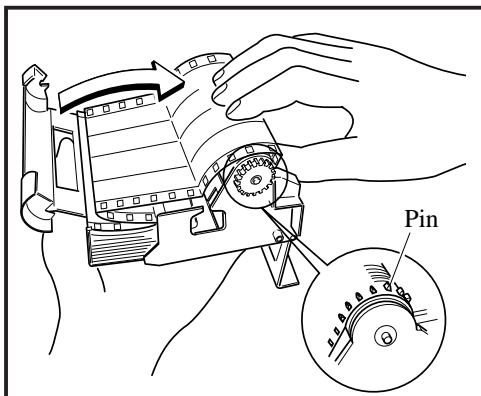

Align the perforations of the chart paper with the pins.

Step 6

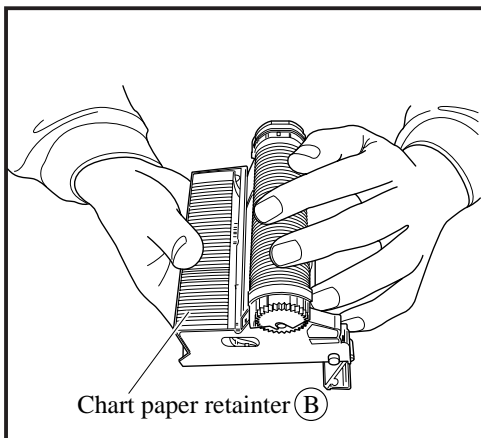

Close the chart paper retainer (B).  
(The chart paper is set vertically).

Step 7

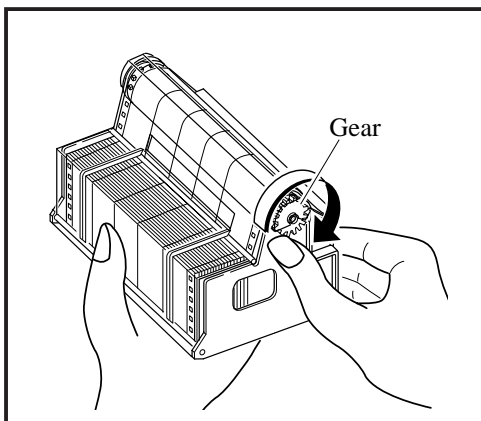

Turn clockwise the gear of the roller unit with hand and check that the chart paper shifts forward.

Step 8

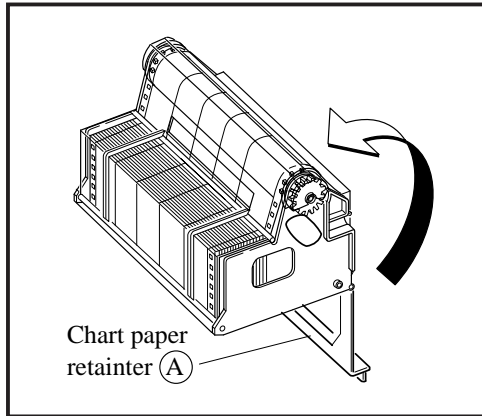

Transfer the chart paper that has been forwarded into the storage of the paper feed unit. Then close the chart paper retainer (A).

Step 9

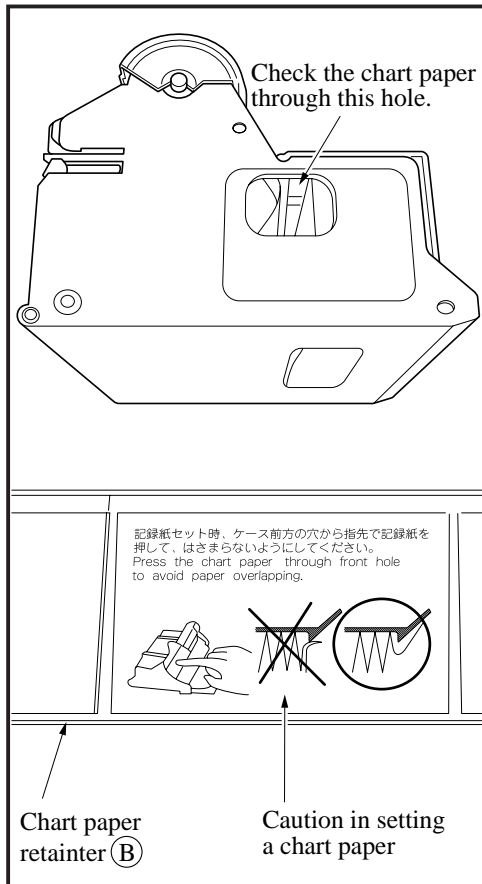

As shown by the caution display on the chart paper retainer (B), if paper is caught in the chart paper retainer (B), paper jam may result.

As shown by the figure at left, check through the holes on the left and the right side of the paper feed unit that the chart paper is not caught in the retainer.

Step 10

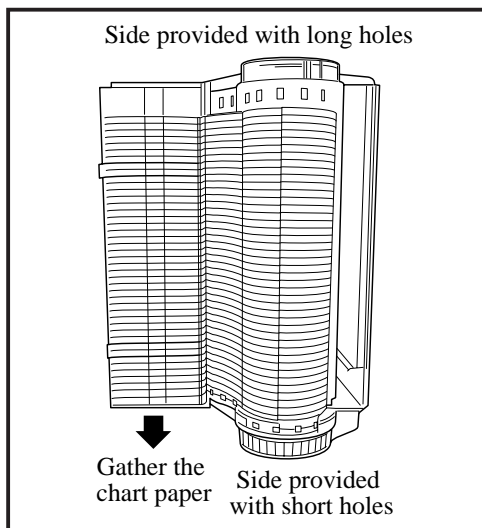

The chart paper is provided with long holes and short holes. Gather the chart paper in the storage to the side provided with short holes as illustrated on the left.

Step 11

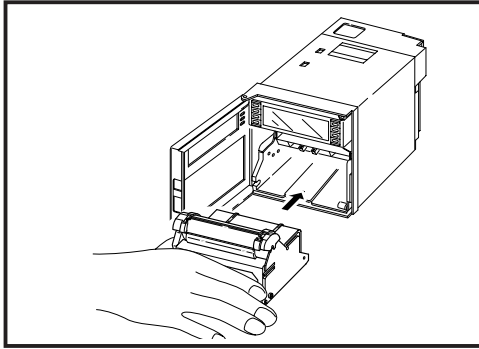

Mount the paper feed unit in the recorder. At this time, check that it is properly locked in position.

Step 12

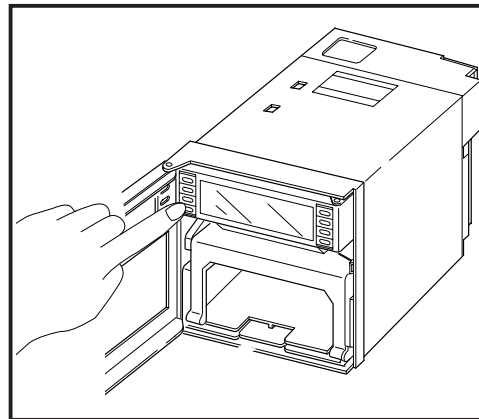

Press the **FEED** key and check that the chart paper is fed out smoothly.  
 (Feed out about 2 folds of paper.)  
 <If the paper is not fed out smoothly, go through the procedure from Step 2 again.>

Note 1	Selection of chart paper
--------	--------------------------

The chart paper greatly affects the quality of the printed recording and it is also related to problems such as paper jamming, etc.

Please be sure to use the pure-quality chart paper specified us.

Chart paper type : PEX00DL1-5000B (50 equal divisions, no time lines)

Note 2	Use of the recorder after it has been left unused for a long time
--------	---

If the recorder is left unused for a long time with chart paper still in the main unit, the paper 'packs down' and if the recorder is used straightway there can be problems of paper jamming, etc.

If you use the equipment after it has been left unused for a long time, first press the **FEED** key to feed out 2 to 3 folds of the paper.

Reference 1	Chart paper length
-------------	--------------------

The chart paper is approximately 15m long. This permits about 31 days continuous print-out at a paper feed speed of 20mm/h.

Reference 2	Chart paper end mark
-------------	----------------------

The amount of chart paper remaining is indicated by digits (units : 10cm) on the right-hand side of the paper. When there is only a small amount left, red letters appear on the right-hand edge.

If the recording paper runs out completely, a recording paper end indicator displays 'Chart end' in the display section and recording automatically stops.

## 5.2 Recording head installation (replacement)

The recording head is a combination of a head and ink.

When ink is used out or trouble arises with the head, it can easily be replaced.

Use the recording head carefully observing the “Caution” noted in the later paragraph.

Step 1

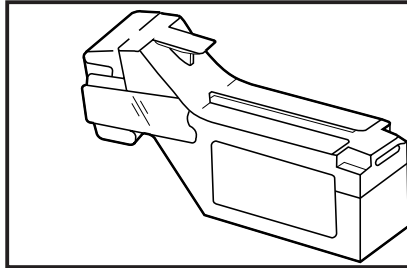

Get the recording head ready by taking it out of its aluminium pack.

Step 2

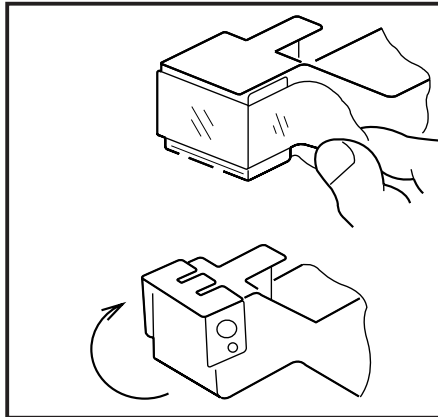

Tear the tape.

Open the cap by turning it in the direction indicated by the arrow.

(If the head is not going to be used for a long time, close the cap back in its original position.)

The cap is integral with the head unit. Turn it about 180° until it stops against the top of the head.

Step 3

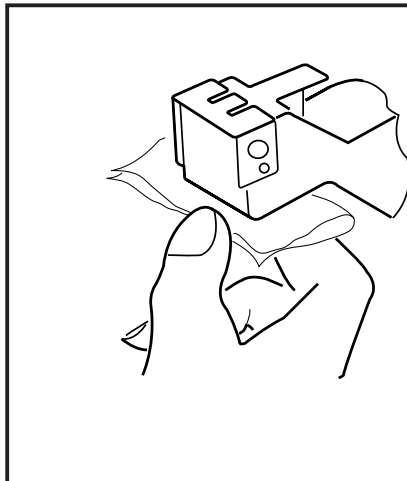

- **Lightly press** the nozzle surface (the surface from which ink is discharge). Make sure that the cloth is properly impregnated with the 4 colors blue, red, yellow and black.

( First press the cloth against the surface for 2 to 3 second; if the 4 colors ooze out, it is OK. )

Note) Do not use any cloth other than the supplied one. Also, do not rub the nozzle with the cloth.

How to close the cap

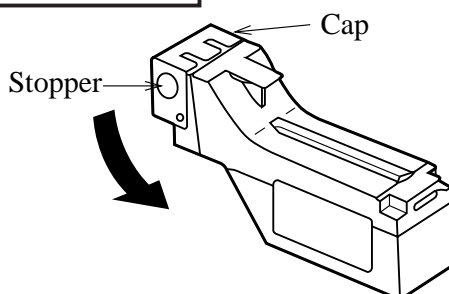

- Turn the cap in the direction indicated by the arrow and press it firmly until it is retained by the stopper.

- Ink may leak out if the cap is not properly in place.



Step 4

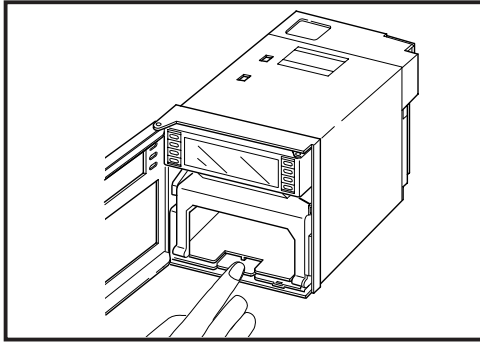

- Press the **RECORD** key. Operate the recorder after it has been set in recording stop mode.
- Open the front door and press down the paper feed unit drawout lever.  
The paper feed unit will be drawn out.

Step 5

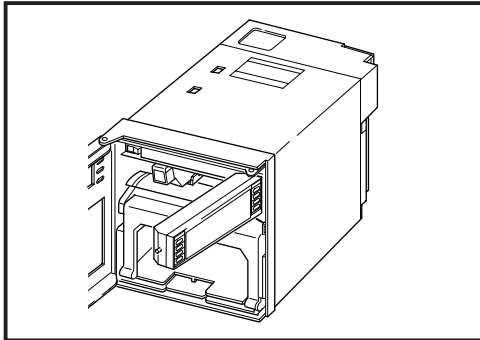

- Hold the left end of the indicator and pull it forward.  
The indicator will turn 90°.

Step 6

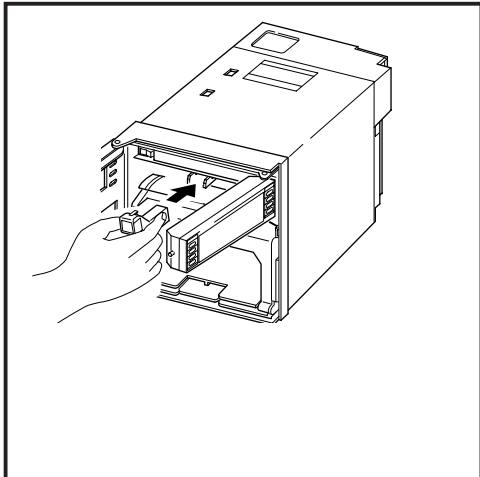

- Hold the recording head horizontal, **line it up with the carriage in the main unit** slide it in slowly and press it firmly until it does not go in any further.
- Take care not to bang the nozzle surface of the head. Also, avoid touching the nozzle surface with your hand.



Do not touch the connector at the rear of the carriage to avoid the risk of minor electric shocks.

Step 7

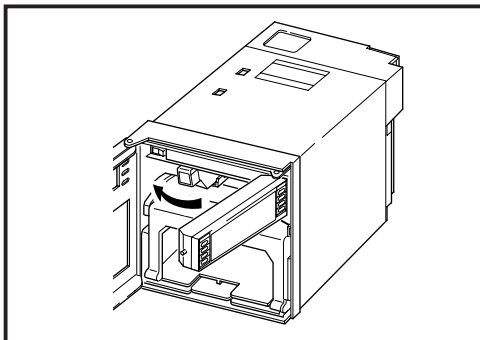

- Set the indicator in its original position.

Step 8

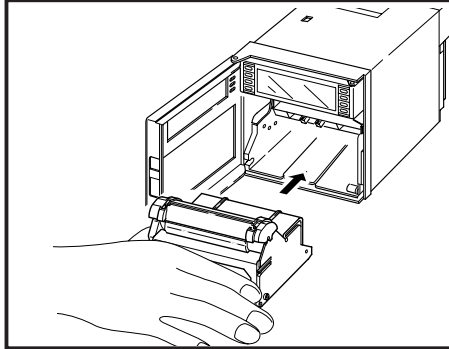

- Set the paper feed unit in its original position.

The above completes installation of the recording head.

**The recording head is a consumable part. Replace it with a new one when the ink it contains is used up.**

## Recording head replacement

Draw out the recording head in the manner that is opposite to what is described in **Step 6** of the recording head setting procedure, and replace it with a new recording head.

Always carry out the following procedure after replacing a recording head.

### (1) Setting the ink monitor

Perform the following keying actions in order to get correct performance of the ink dry-up warning-detection function.

As in “Clearing the ink monitor” of Section 7.16, press the **SELECT** key to give an “INK MONITOR CLEAR” display

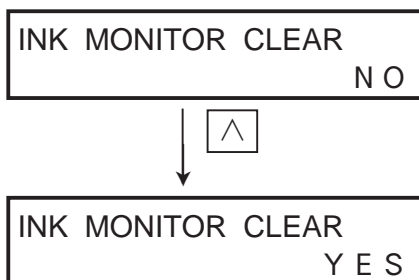

Press the **^** key to change the flickering “NO” to “YES”.

Next, press **ENTRY** key.

This completes the setting.

Press the **DISPLAY** key to return to a data display.

### (2) Test pattern print-out

Print out a test pattern to check that normal recording is possible. See Section 6.3 for the way of printing out a test pattern.

### (3) Adjustment of analog trend recording positions

Referring to Section 9.2, readjust the zero and span on the recording paper.

## Precautions in handling recording heads

Note 1 | If recording is halted and the recorder is not used for a long time

Carry out the following in order to prevent jamming and drying-up of the ink.

Remove the recording head from the main unit, make absolutely sure the cap is closed properly and store the head in a cool, dark place (average temperature 5 to 30°C).

If the head is left installed in the recorder:

Do not switch off the power to the recorder and do not close the cap.  
\* Periodically, there is an automatic discharge of ink to prevent drying-up.  
Leave the recording paper in place in the recorder.

If it is not possible to keep the power switched on, make sure that the cap is closed.

**Draw out the paper feed unit using the recording head setting method (Step 4) and (Step 5).  
Open the indicator and tighten the cap.**

Note 2 | At the start of use of a recording head

If you are starting to use a new recording head or if the recorder has been left unused for a long time, always wipe the head's nozzle surface lightly with the accessory cloth and check that the 4 colours black, blue, red and yellow ooze out properly into the cloth. (See Section 5.2.)

Also, after normal recording is possible. See Section 6.3 for the way of printing out a test pattern.

When the working environment is 15°C or less, perform print-out of "test pattern" after period of several minutes has elapsed since the recording head was mounted. (The recording head has a built-in heater.)

Note 3 | Handling recording heads

- Do not knock or shake recording heads as this can cause faults.
- The inks are not harmful but they are very difficult to remove if they adhere to the skin or to clothes, so handle heads carefully in order to avoid staining. Also, do not disassemble them.
- If, by accident, it happens that ink gets into your eyes, wash thoroughly with water as an emergency measure and then immediately consult a specialist doctor.
- When the ink is used out, dispose of its recording head as incombustible object.
- This product is intended to be used where are not dusty.
- Be sure to start to use the product soon after opening package. (Be sure to finish using this within 1 year after opening)

Note 4	Storage of recording heads
--------	----------------------------

- When they are delivered, recording heads are in aluminium packs.  
If you are not going to use a head straight-away, leave it sealed and store it in a cool, dark place with an average temperature of 5 to 30°C.
- Storage period: 1 year and half after purchased

Note 5	Shipping of recording head
--------	----------------------------

- Do not ship the unit recording head after the aluminum pack was opened up. If it is necessary to ship the unit recording head under avoidable circumstances, **be sure to close the cap**, and ship it as contained in a boxboard in the state where vibration and impact are eased using cushioning materials.
- Always close the cap if you are transporting a head while it is still installed in the recorder main unit.

Note 6	If the ink is not sprayed.
--------	----------------------------

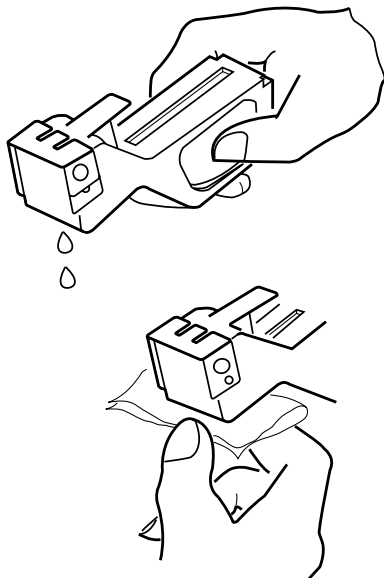

- ① Hold the recording head with turning the nozzle surface downward and push the side strong till spilling two drops.
  - ② Absorb the standing ink on the nozzle surface with the cloth attached.
  - ③ Hold the cloth to the nozzle surface again to find all colours flowed onto cloth.
- When ink does not come out, repeat the above operation ( ① through ③ ).
- \* When working environment is 15°C or less, perform print-out of "record" or "test pattern" after a period or several minutes has elapsed since the recording head was mounted. (The recording head has a built-in heater.)

Reference	Ink consumption
-----------	-----------------

When recording at 20mm/h of chart paper feed speed and a given input, the consumption of ink is as shown below, though it depends on operating conditions.

About 1 year ----- 1, 2, 3 continuous recording or 6 intermittent recording

About 6 months ----- 6 continuous recording

Alarm of ink consumption is displayed and printed by ink consumption detecting function.

(See Section 11.12 for an example of print-out.)

### 5.3 Changing the type of input signals

This recorder is a multi-input type which permits the input for any channel to be changed to thermocouple, resistance bulb or DC voltage input.

Follow the procedure described below if you wish to change the type of input signals subsequent to purchase.

**Step 1** Turn off the power.

**Step 2** Open the front flap and remove the main unit in the manner shown in the drawings below.

**Step  
2 - 1**

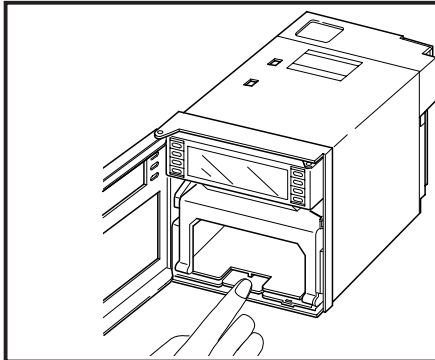

Open the front door and press down the paper feed unit drawout lever.  
The paper feed unit will be drawn out.

**Step  
2 - 2**

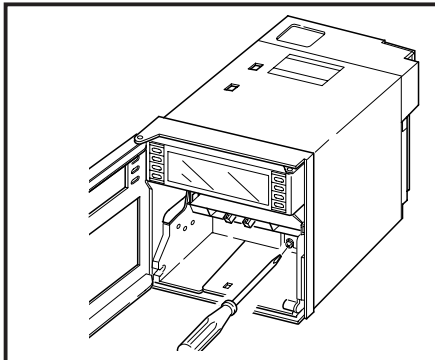

Loosen the lock screw (M4) in the unit with a Phillips driver.

**Step  
2 - 3**

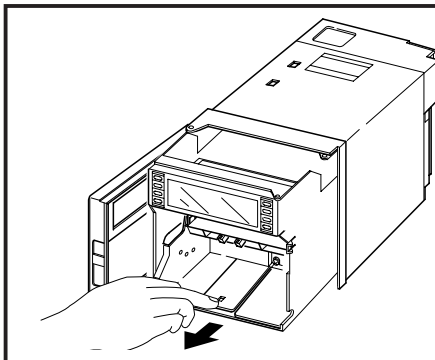

Hold the side or bottom of the frame and pull the unit forcibly to remove it from the case. It can be removed easily when the door is opened by about 90°.

**Step  
2 - 4**

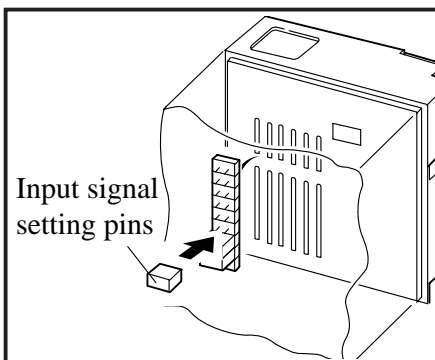

Change the setting of each channel pin on the printed circuit board in the unit.  
(See the next page for changing the position of pin.)  
\* To remove or attach the pins, use pincette or pliers.

## Method of changing pin positions

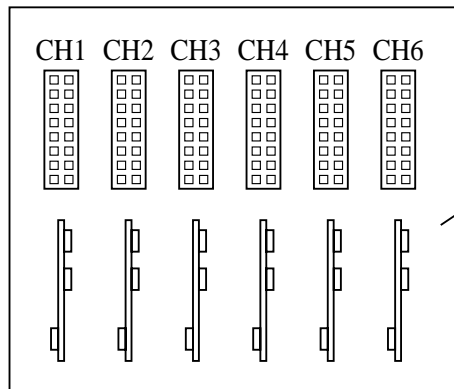

Large PC board installed in depth of the case

### Pin positions for different types of inputs

- Pin setting is required in correspondence with types of inputs for each channel.
- The set position is as shown below.

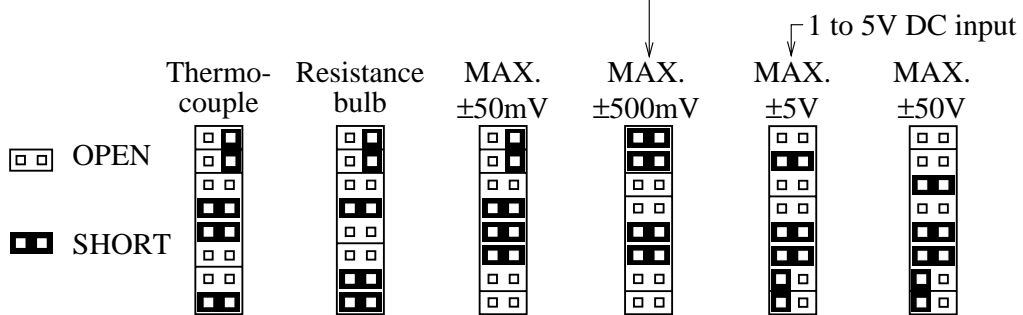

Step  
2 - 5

- After completing the change, push the main unit back into its original place and fix it with the left and right lock screws.
- Push in the paper feed until it is set as before.

Step  
2 - 6

- Change the input terminal wiring to make it correspond to the new input signal type.
- For DC voltage input, provide the input terminals with shunt resistors.  
Example: In the case of 4 to 20mA DC input, fit the separately sold shunt resistors (10Ω and set to ±500mV range input pin positions).

Step  
2 - 7

Refer to Section 7.8 and carry out front-panel keyboard operations in order to change setting in correspondence to changed types of input signals.

[Note] DC current input is converted into voltage by shunt resistor (10Ω):  
In 4 to 20mA DC : 40 to 200mV DC range  
In 10 to 50mA DC : 100 to 500mV DC range

## 6. OPERATION AND ACTIONS

---

### 6.1 Before running the equipment:

Check the following points before starting operation.

#### 1 Setting the chart paper and recording head

- ① Setting the chart paper ..... See Section 5.1
- ② Setting the recording head ..... See Section 5.2

#### 2 Wiring

- ① Input terminals .....
  - ② Alarm terminals (option) .....
  - ③ Power and earth terminals .....
- } See Section 4.2

#### 3 Conformity of input connection to recording channel

- ① Code symbols ..... See Section 1.3
- ② Change and settingo type of input signal ..... See Section 5.3

---

## 6.2 Power switch-on and states

- (1) Open the front door. Then hold the left end of the indicator and turn it forward.
- (2) The power supply switch is at the above left; switch it on.

### 1) Initial switch-on of power

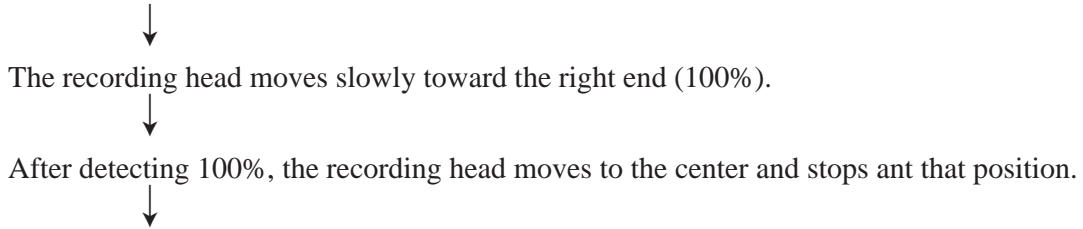

1	1 0 0 °C
---	----------

The input data and Tag No. are displayed in the display section.  
(No recording takes place.)

- 2) If the power is switched off while recording is stopped and switched on again.  
(The state becomes "Recording stopped")
- 3) If the power is switched off during recording operation and switched on again.  
(The state becomes "Recording in progress")

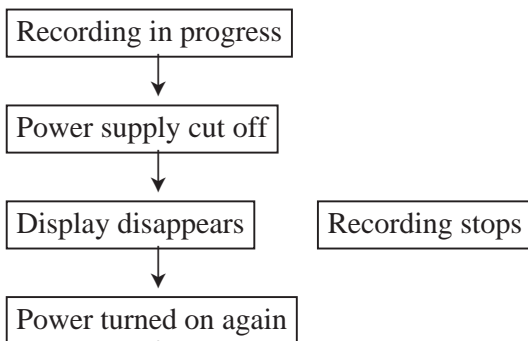

The recording head moves slowly tooward the right end (100%).

After detecting 100%, the recording head moves to the center and then the right end, and it stops at that position.

1	1 0 0 °C
Rec.	ON

The input data is displayed in the display section and recording re-starts.



### 6.3 Test pattern print-out

- (1) Open the front flap, switch the power supply switch on the press the **SELECT** key.
- (2) Pressing the **SELECT** key several more times results in the following display.

```
LIST = 1
PARAMETER LIST
```

- (3) Press the **^** key twice; this gives the following display.

```
LIST = 1
TEST PATTERN
```

- (4) When the **ENTRY** key is pressed, the following test pattern is printed out.

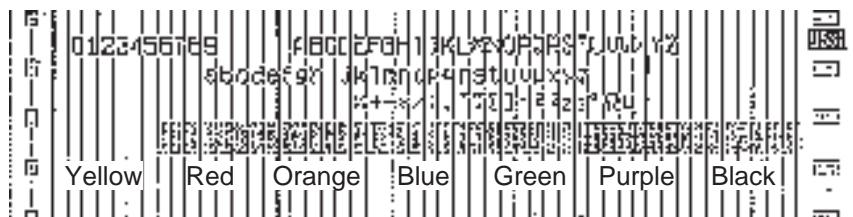

- Check that there is a complete recording in each colour.  
If the colours do not come out or are blurred, follow the procedure of Section 5.2 to clean the recording head nozzle surface.

### 6.4 Actions during operation

- (1) **Stopping and starting recording operation** (**RECORD** key)
  - Stopping the recording is possible at anytime during operation.
  - Recording is alternately started and stopped each time the **RECORD** key is pressed.

```
6          3 1 5 °C
  Rec.      O N
```

During recording operation

```
6          3 1 5 °C
```

When recording is stopped

- (2) **Digital print-out (instantaneous values)** (**LIST** key)

Example of record

6:	06/20/23:39					
1:	27.6 °C	2:	27.9 °C			
3:	27.8 °C	4:	27.4 °C			
5:	26.9 °C	6:	26.3 °C			

- Measured values can be printed out any time during operation.
- Pressing the **LIST** key results in a digital print of the time at which the key was pressed and the measured values and units of all the channels at that time.
- Analog trend recording is stopped during digital printing.
- Completion of digital print-out is followed by a return to analog recording.
- To stop printing during operation, press the **LIST** key. Analog trend recording is started again.
- Channels which are skipped are printed with the sign “-” (lateral line).

**(3) Chart paper fast feed** ( **FEED** key)

- To effect fast feed regardless of recording, press the **FEED** key.
- The speed is 3mm/s during the first second that the key is held depressed and goes to 8mm/sec after the elapse of 1 second.
- When the **FEED** key is released, there is a return to the set speed.

**(4) Changing the display mode** ( **DISPLAY** key)

- Display modes can be selected at any time pressing the **DISPLAY** key during operation.
- There are the following changes in the display mode each time the **DISPLAY** key is pressed.

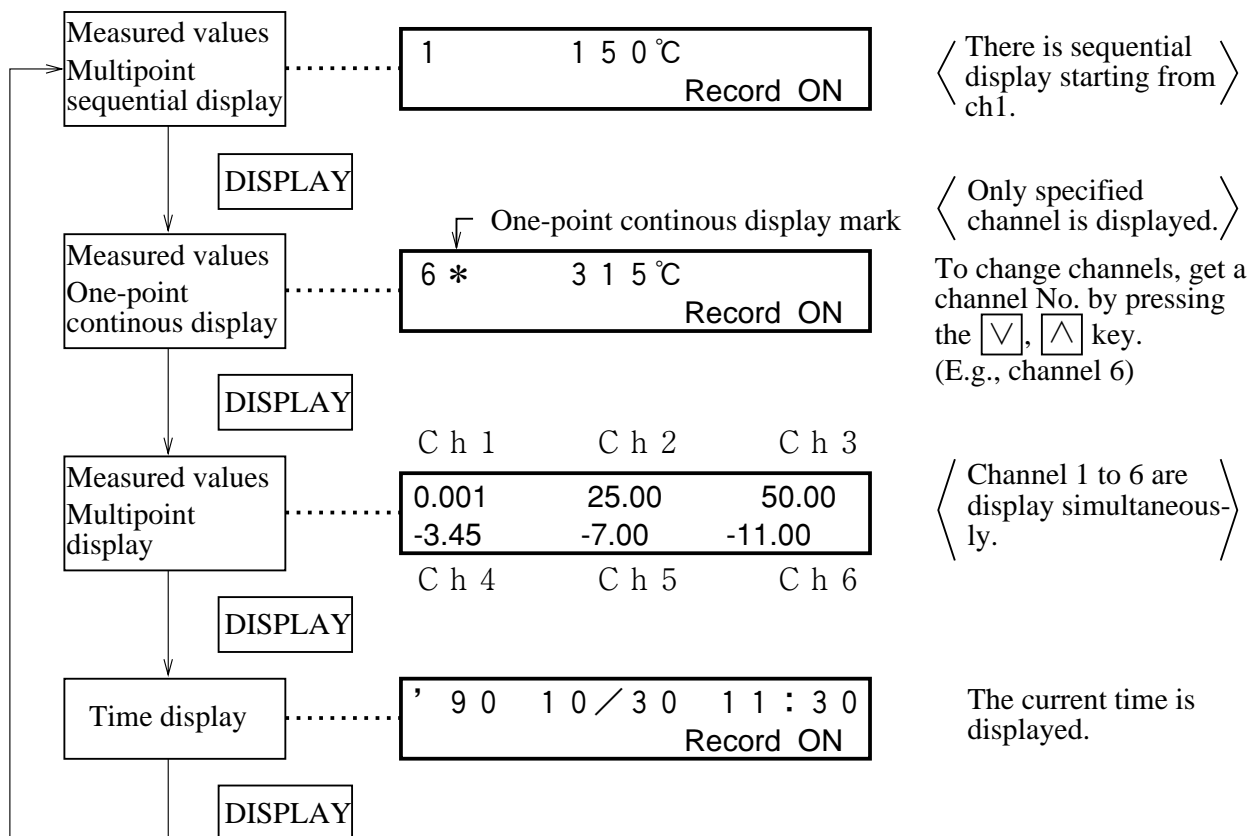

Note) No Record ON is displayed when recording is stopped.

## 6.5 Displays and print-outs on detection (cancellation) of alarms

- (1) If an alarm is detected the display section gives a display as follows.

Example of alarm display

<table border="1" style="width: 100%; border-collapse: collapse;"> <tr> <td style="text-align: center;">2 1 2 3. 5 °C</td> </tr> <tr> <td style="text-align: center;">C h 6 ALARM H A L M 1</td> </tr> </table> <p>(This display continues until it is cancelled.)</p>	2 1 2 3. 5 °C	C h 6 ALARM H A L M 1	<p>Example: Upper section Ch 2 measured value</p> <p>Lower section Alarm in Ch 6</p> <p>H alarm, relay No. 1</p>
2 1 2 3. 5 °C			
C h 6 ALARM H A L M 1			

- (2) When an alarm detected and cancelled, the relevant details are printed on the right-hand side of the chart paper.

On detection: The time of detection, channel No., type of alarm, relay No.

..... Print-out color: Red

On cancellation: The time of cancellation, channel No., relay No.

..... Print-out color: Black

Example of alarm print-out

② Channel 1 No. 1 H alarm release  
Relay No. 1  
Release time: 14:58

① Channel 1 No. 1 H alarm generation  
Relay No. 1  
Generating time: 14:57

- (3) If an alarm is detected or a cancellation is made during data print-out or list print-out, the alarm print-out takes place after completion of the data or list print-out.
- (4) Up to a maximum of 30 alarm detection cancellation information can be stored and sequentially printed out, but if the storage capacity is exceeded because of a large number of detections/cancellations in a short time, information in the overflow portion is discarded and cannot be printed out.

## 6.6 Displays and print-outs on occurrence of burnt-out

- (1) If a thermocouple or resistance bulb wire breaks, the relevant details are indicated in a display

Example of burn-out display

<table border="1" style="width: 100%; border-collapse: collapse;"> <tr> <td style="text-align: center;">6</td> <td style="text-align: center;">BURN - OUT</td> </tr> <tr> <td></td> <td style="text-align: center;">Rec. ON</td> </tr> </table>	6	BURN - OUT		Rec. ON	<p>Example: Burn-out in Ch 6</p>		
6	BURN - OUT						
	Rec. ON						
<table border="1" style="width: 100%; border-collapse: collapse;"> <tr> <td style="text-align: center;">0.1</td> <td style="text-align: center;">0.01</td> <td style="text-align: center;">0.001</td> </tr> <tr> <td style="text-align: center;">Burnout -0.01</td> <td style="text-align: center;">-0.001</td> <td></td> </tr> </table>	0.1	0.01	0.001	Burnout -0.01	-0.001		<p>Multipoint display</p>
0.1	0.01	0.001					
Burnout -0.01	-0.001						

Note: The trend record is switched to the 100% side.

- (2) When alarm is generated or released, its data is printed on the right side of chart paper.  
(print color: red)

Example of burn-out print-out

<table border="1" style="width: 100%; border-collapse: collapse;"> <tr> <td style="text-align: center;">1</td> <td style="text-align: center;">BURN - OUT</td> <td style="text-align: center;">1 1 : 5 2</td> </tr> </table>	1	BURN - OUT	1 1 : 5 2	<p>Time of occurrence : 11. 52</p> <p>Channel No. : 1</p>
1	BURN - OUT	1 1 : 5 2		

## 6.7 Over-range, under-range display and abnormal input display

In all cases, for thermocouples, resistance bulbs and DC voltage input, there is a reference range for input signals. If input is outside preset range an 'Over' or 'Under' display is given.

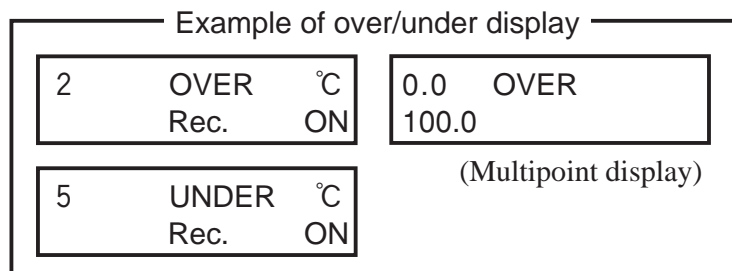

When voltage input is applied and the input signal cable breaks down or an over/under voltage is inputted, it is displayed as an abnormal input.

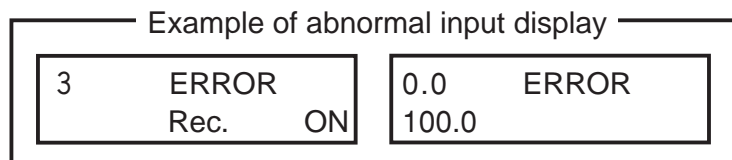

## 6.8 Display and record when chart paper runs out ("Chart End" display)

When chart paper is used out, the following is displayed and the recording stops automatically.

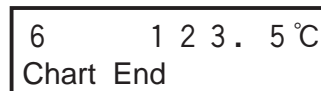

But display of measured value and alarm monitoring are continued.

## 6.9 Display and record when the recording head ink is low ("Ink Out" display)

- (1) A display as follows is given on the chart paper when the amount of remaining ink is low. 'Ink End' is displayed in the display section.

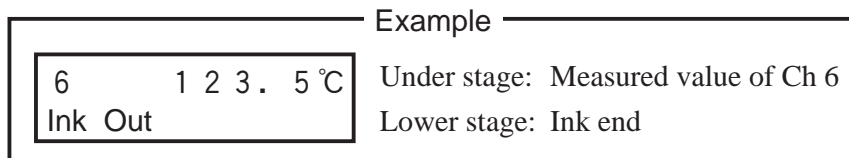

- (2) 'Ink Empty' is printed on the right-hand side of the chart paper.  
< Print-out color : The color of the ink whose remaining quantity is low >

Note) The sign "Ink End" is displayed when the ink left in the recorder reaches less than 10%, but recording continues for a while after "Ink End" is displayed. Use a new recording head.  
(When ink is used out, recording and printing operation is interrupted immediately)

---

## 6.10 Display when data backup batteries need to be replaced ("Battery End" display)

When the voltage of back-up batteries becomes low, a display indicating that they need to be replaced is given.

'Battery End' is displayed in the display section.

6      1 2 3 . 5 °C Battery End	Example
	Under stage: Measured value of Ch 6 Lower stage: Battery end

Replace the batteries promptly when a 'Battery End' display appears page 8-3.

## 6.11 Display of fault in recording head carriage ("Carriage Alarm" display)

If a fault in the recording head carriage occurs and the recording head can no longer function normally, a fault display is given and the recording operation stops.

6      1 2 3 . 5 °C Carriage Alarm	Example
	Under stage: Measured value of Ch 6 Lower stage: Carriage failure

When the sign "Carrier Failure" is displayed, turn OFF the power and check the following points.

- (1) Is foreign matter adhering to the recording head carrier shaft ?
- (2) Is the wire that drives the recording head broken or slack ?
- (3) Has the recording paper lifted up and come into contact with the recording head ?
- (4) Is the recording head set in place correctly ?

After eliminating the cause of the fault, switch on the power supply of the main unit.

## 6.12 Order of priority of state displays

If the items noted below occur simultaneously, the corresponding displays are given in the indicated order.

1. Chart end
2. Carriage alarm
3. Ink end
4. Battery end
5. Alarm

Note: When the state displays 1 and 2 above are given, the SELECT key is inoperative.

However, the DISPLAY and FEED keys are operative.

## 7. SETTING AND CHECKING PARAMETERS

---

### 7.1 Setting and Checking

- ① The parameters at the time of shipment are as indicated in the table below. Recorder operations (displays, analog trend recording) can be effected simply by switching the power on without making any adjustments, but you can set the parameters you require.
- ② The record ranges are multirange and it is necessary to set the required ranges.
- ③ Alarms, Tag Nos., Message, scaling, square root extracting and subtract calculation, daily report and totalize functions are not set. Please set these if they are required. Input filters are set to 3 seconds.
- ④ After setting up parameter, it is recommended to print out parameter list and retain parameter in order to find out setting contents later. (refer to the Item 7.1 regarding printing out parameter list.)

Note) If you set parameters, always do so after setting chart paper in place.  
If chart paper is not installed, the SELECT key is inoperative.

**(1) Values of parameters at the time of shipment (initial values)**

Parameter name	State at time of shipment (initial values)	Remarks	Method of setting, checking
Pass code	(Cancelled)	Setting range : 0 to 9999	Section 7.3
Main chart speed	20mm/h	Setting range : 5 to 1500mm/h	Section 7.4
Sub-chart speed (option)	20mm/h	Setting range : 5 to 1500mm/h Changed by external contact input	Section 7.4
Alarms	No. 1 to 4 : No Set value : 0 ALM : 0	4 kinds and 4 points, L, H, RH and RL, are available for each channel (relay output: option).	Section 7.5
Recording mode	Trend recording	Trend recording/logging recording selection	Section 7.6
	Periodic print-out : ON	Periodic digital print-out on/off selection	
	Scale print-out : ON	Fied interval scale lines, digital, units printout selection	
	Recording format : standard	Standard, auto-range recording, zoom records, zone recording selection	
Record range	Thermocouple system: 0 to 1200°C, K Resistance bulb system: 0 to 500°C, Pt DC voltage system: -5 to +5V DC	Specifiation of record range	Section 7.7
Input selection	Thermocouple: K thermocouples, °C Resistance bulb: Pt100, °C	Input type specification, °C, °F, specification	Skip/copy setting
	DC voltage : V	mV, V specification	
	Input filter : 3 seconds	Setting range : 0 to 900 seconds	Section 7.8
	Scaling : OFF	DC voltage input scaling can be set (working values, units)	
	Rooter : OFF	DC voltage input rooter (square root extractor ) can be specified	
	Subtract calculation : OFF Computation : OFF	Recording of differences between channels can be specified	
TAG No.	Blank	Up to 8 alphanumeric characters	Section 7.9
Message print	Blank Print position : 0.0mm Print timing : Manual	10-message, alphanumeric : Within 16 characters	Section 7.10
List print-out	_____	Parameter list print-out, scale print-out, test pattern print-out, daily report, totaling list	Section 7.11

Parameter name	State at time of shipment (initial values)	Remarks	Method of setting, checking
Daily report	Function : OFF Automatic print-out : ON Start time : 00:00 End time : 00:00	Daily report function on/off selection, start time selection Daily report list automatic print-out on/off selection Daily report operation on/off setting for each channel	Section 7.12
Totalize	Function : OFF Automatic print-out : ON Start time : 00:00 End time : 00:00	Totalize function on/off selection, start time selection Totalize list automatic print-out on/off selection Totalize operation on/off setting for each channel	Section 7.13
RS-485 transmission (option)	Station No. : 1 Baud rate : 19200bps Stop bit : 1 Parity : odd	Specified if there is connection with parent CPU.	Section 7.14
Time setting	Current time setting	Display in the order — Year — Month — Day — Hours — Minutes	Section 7.16
Ink monitor clear	NO	Setting of ink end warning-detection function. Always set to clear (YES) after recording head replacement.	Section 7.16
Recoding paper illumination lamp (option)	ON	Set to "OFF" to turn out the recording paper illumination lamp.	Section 7.17



## 7.2 Outline of Procedure for Setting Parameters

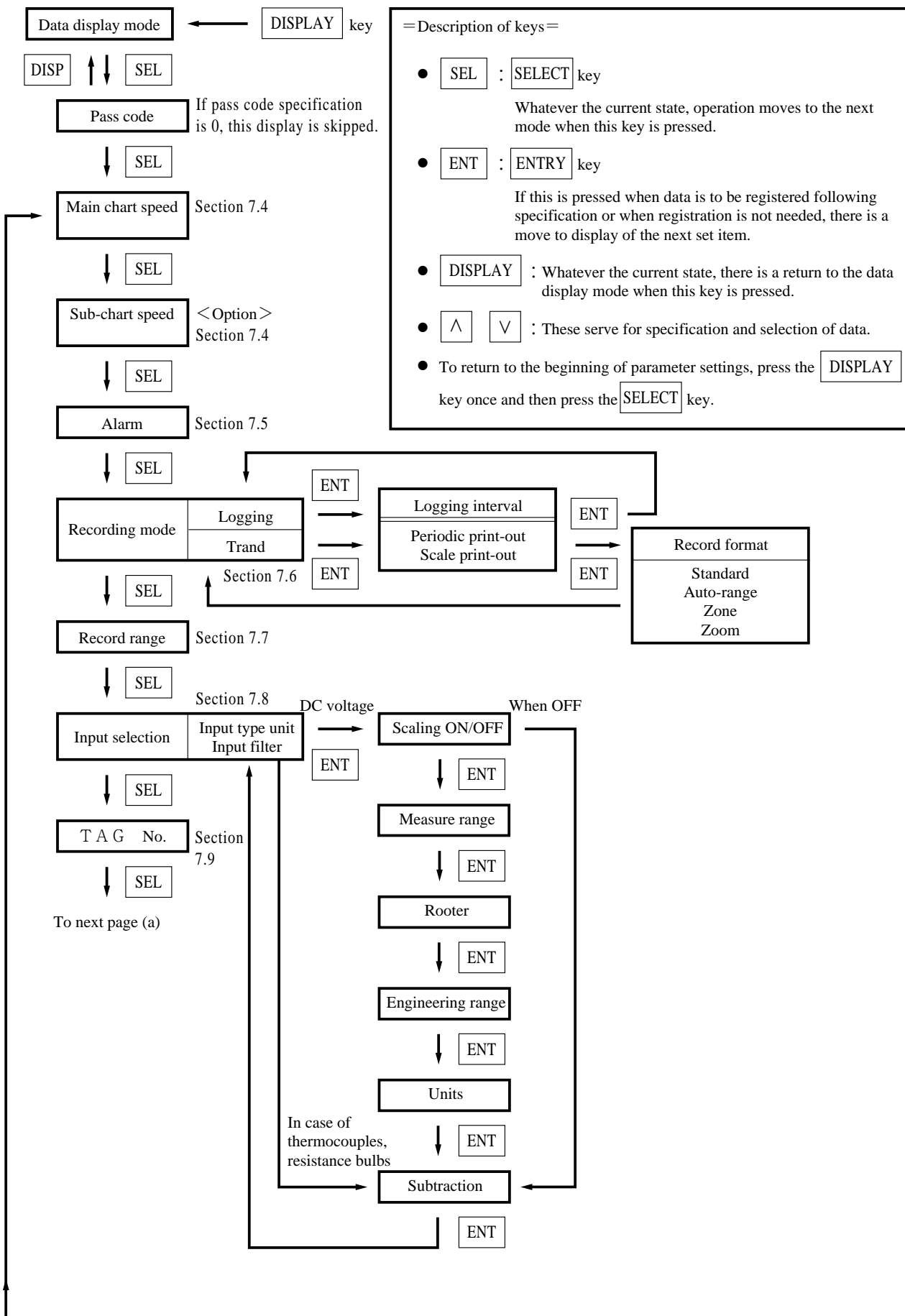

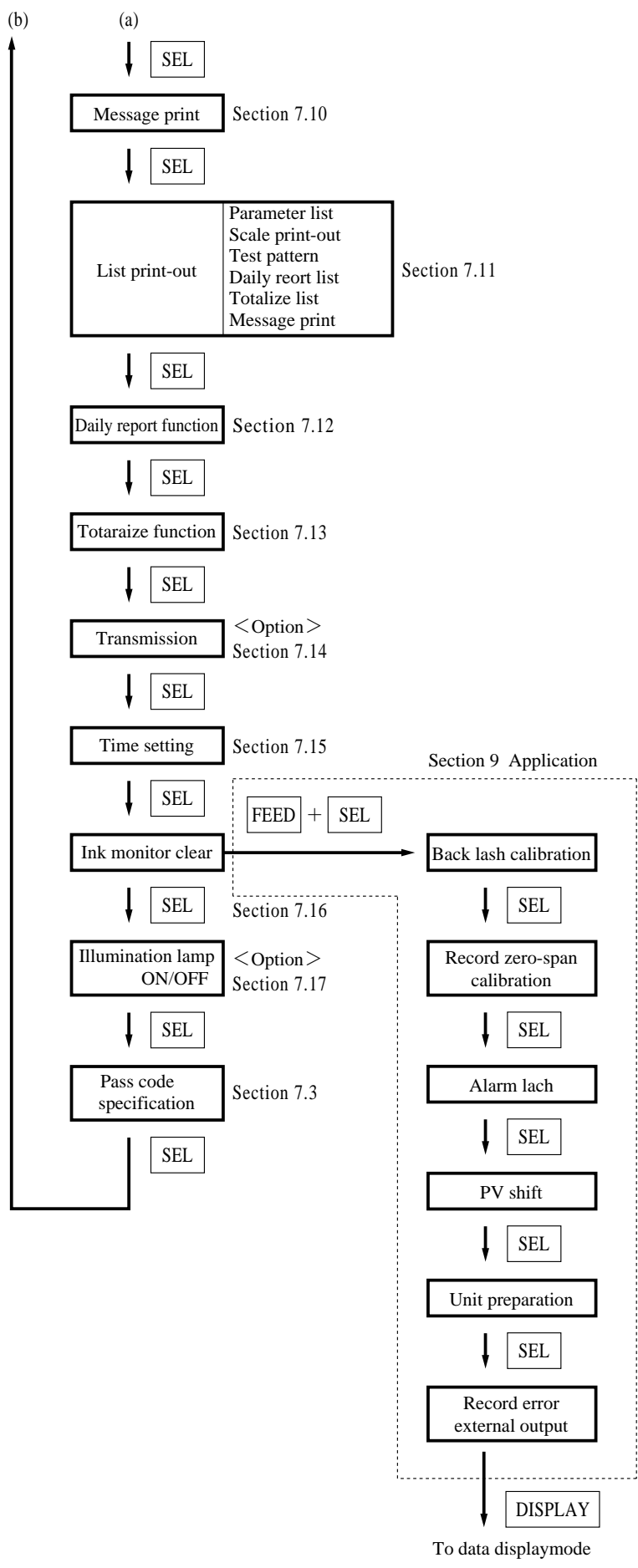

## 7.3 Pass code setting

### Explanation

If the pass code is set to a value other than 0, it is necessary to enter the correct pass code before changing parameter setting pass code. A numerical value is specified on the screen by means of the  $\wedge$  and  $\vee$  keys and is input by the  $\text{ENT}$  key. If this value is the same as the previously set pass code, there is a move to a display of the next parameter.

If the pass code is incorrectly specified, the keys are locked as follows.

Preset pass code  $< 5000$

Only the list display is given and it is not possible to change parameter setting.











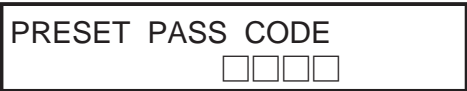

Preset pass code  $\geq 5000$

The list display is given, but list print-out is inhibited.

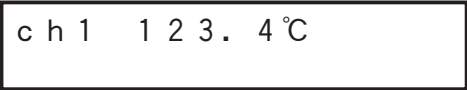
Furthermore,  $\text{RECORD}$ ,  $\text{LIST}$ , and  $\text{FEED}$  keys on the front panel are locked.

At the time of shipment, the pass code is set to 0 and the key lock is released.

If the pass code is 0, the pass code display is skipped.

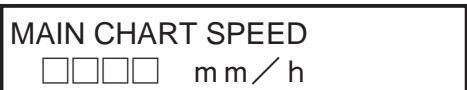
Example	Setting of the pass code	
Key actuation	Explanation	Display
$\text{SEL}$ 	Press the $\text{SEL}$ key several times to bring up the pass code specification display.	
$\wedge$ $\vee$ 	Press the $\wedge$ $\vee$ key to specify the value you want for the pass code (specification range: 1 to 9999).	
$\text{ENT}$ 	Press the $\text{ENT}$ key to register the value. When it has been registered, there is a move to the next parameter.	
$\text{DISP}$ 	Press the $\text{DISP}$ key to go to the data display mode.	
$\text{SEL}$ 	Press the $\text{SEL}$ key to bring up the pass code input screen.	
$\wedge$ 	Press the $\wedge$ key to give the value of the pass code that has been specified.	
$\text{ENT}$ 	Press the $\text{ENT}$ key to effect registration. Note: If the value input at this time is different from the pass code that has already been specified, the list screen comes up (key lock state).	
	In this case, it is not possible to clear the pass code, so go through the process again from the beginning and input the correct value. If the value input is the same as the pass code value, there is a move to the next parameter.	

## 7.4 Setting the Chart Speed (main chart speed/sub-chart speed)

### Explanation

- Main chart speed : This is the procedure for resetting the chart speed in normal operation.  
The setting range is 5 to 1500mm/h (Can be set in 1mm/h steps.)
- **If the case of a continuous recording type, if the chart speed is too fast, the result is dashed line recording instead of continuous recording.** (As a general criterion, 400mm/h or more)
- **Please note that the following digital print-outs are not possible** if the chart speed is 401mm/h or more for continuous recording or 51mm/h or more for dot recording.  
"Periodic print-out", "Message print-out", "Scale print-out", "Alarm printout", "Parameter print-out", "Ink Out print-out", "Burn-out".  
However, a "Scale print-out", "Message print-out" can be made manually. See Section 7.11.
- On an intermittent recording type, if the chart paper feed speed is fast, it becomes difficult to read recording due to increase in the space between break points. It is recommended that the recorder be used at a speed of 50mm/h or less.
- On a continuous recording type, the recording cycle varies with chart paper feed speed.



$$\text{Sample time (sec.)} = \frac{400}{\text{Chart speed (mm/h)}}$$

(But not faster than 2 seconds.)

Example)



Chart speed (mm/h)	10	20	25	50	100	200 or more
Sample time (sec.)	40	20	16	8	4	2

- Sample time of intermittent recording type is fixed to 30 seconds.

Example	Changing the normal chart speed of 25mm/h to 20mm/h.	
Key actuation	Explanation	Display
<div style="border: 1px solid black; padding: 2px; display: inline-block;">SEL</div> 	Press the <div style="border: 1px solid black; padding: 2px; display: inline-block;">SEL</div> key twice to display the main chart speed.	<div style="border: 1px solid black; padding: 5px; text-align: center;">           MAIN CHART SPEED            2 5 mm/h         </div>
<div style="border: 1px solid black; padding: 2px; display: inline-block;">∇</div> 	Press the <div style="border: 1px solid black; padding: 2px; display: inline-block;">∇</div> key to set to "20".	<div style="border: 1px solid black; padding: 5px; text-align: center;">           MAIN CHART SPEED            2 0 mm/h         </div>
<div style="border: 1px solid black; padding: 2px; display: inline-block;">ENT</div> 	Press the <div style="border: 1px solid black; padding: 2px; display: inline-block;">ENT</div> key to effect registration. There is a move to display of the next parameter.	<div style="border: 1px solid black; padding: 5px; text-align: center;">           SUB CHART SPEED            2 5 mm/h         </div>

## Explanation















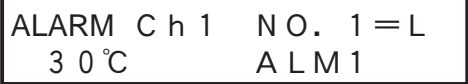





- Sub-chart speed : This is the chart speed when its rate is controlled by an remote control signal.  
The setting range is 5 to 1500mm/h. (Can be set in 1mm/h steps.)  
The optional external control unit is necessary.

Example	Changing the recording paper feed of speed 100mm/h to 150mm/h by an external control signal (DI)	
Key actuation	Explanation	Display
<div style="border: 1px solid black; padding: 2px; display: inline-block;">SEL</div> 	Press the <div style="border: 1px solid black; padding: 2px; display: inline-block;">SEL</div> key 3 times to display the sub-chart speed.	<div style="border: 1px solid black; padding: 5px; text-align: center;">             SUB CHART SPEED              1 0 0 mm/h           </div>
<div style="border: 1px solid black; padding: 2px; display: inline-block;">^</div> 	Press the <div style="border: 1px solid black; padding: 2px; display: inline-block;">^</div> key to set to "150".	<div style="border: 1px solid black; padding: 5px; text-align: center;">             SUB CHART SPEED              1 5 0 mm/h           </div>
<div style="border: 1px solid black; padding: 2px; display: inline-block;">ENT</div> 	Press the <div style="border: 1px solid black; padding: 2px; display: inline-block;">ENT</div> key to effect registration. There is a move to display of the next parameter.	<div style="border: 1px solid black; padding: 5px; text-align: center;">             ALARM C h 1    H H = O F F              0           </div>

## 7.5 Setting Alarms

### Explanation

- Channel : Setting of channel No. for object alarm.
- Alarm No. : Up to 4 points of alarm can be set per channel.
- Kind of alarm : 4 kinds, H, L, RL, RH (setting freely for each channel).  
Alarm operation stoops at selection of No. (alarm display, print and alarm output operations are not available).
- Alarm setting value: Setting in industrial values (absolute alarm value)
- ALM : Setting of option alarm unit relay No. (no output at 1 to 6, 0)

Example	Chang of alarm No. 1 of channel 1 L → H      30°C → 80°C      ALM → 6	
Key actuation	Explanation	Display
	Press the  key several times to give the alarm display. (In cases where pass code = 0)	
	Select channel to be changed, and press the  key.	
	Press the  key to change "L" to "H".	
	Press the  key.	
	Press the  key to change the set value from "30°C" to "80°C" and press the  key.	
		
	Press the  key to change the ALM No. from "1" to "6" and press the  key to effect registration.	
	<p>( When the  key is pressed, the channel No. flashes and the setting is completed. Follow the same procedure for setting in other channels. )</p>	

Note : RH, RL ..... High/low limit alarm for variation rate.

Alarm is emitted when variation rate per input exceeds the set value of each alarm.

## 7.6 Setting the recording mode

The following recording modes can be set in this section.

- ① Logging recording (logging)
- ② Periodic print-out
- ③ Scale print-out
- ④ Auto-range recording (auto-range)
- ⑤ Enlarged/reduced recording (zoom)
- ⑥ Zone recording (zone)

### Setting procedure

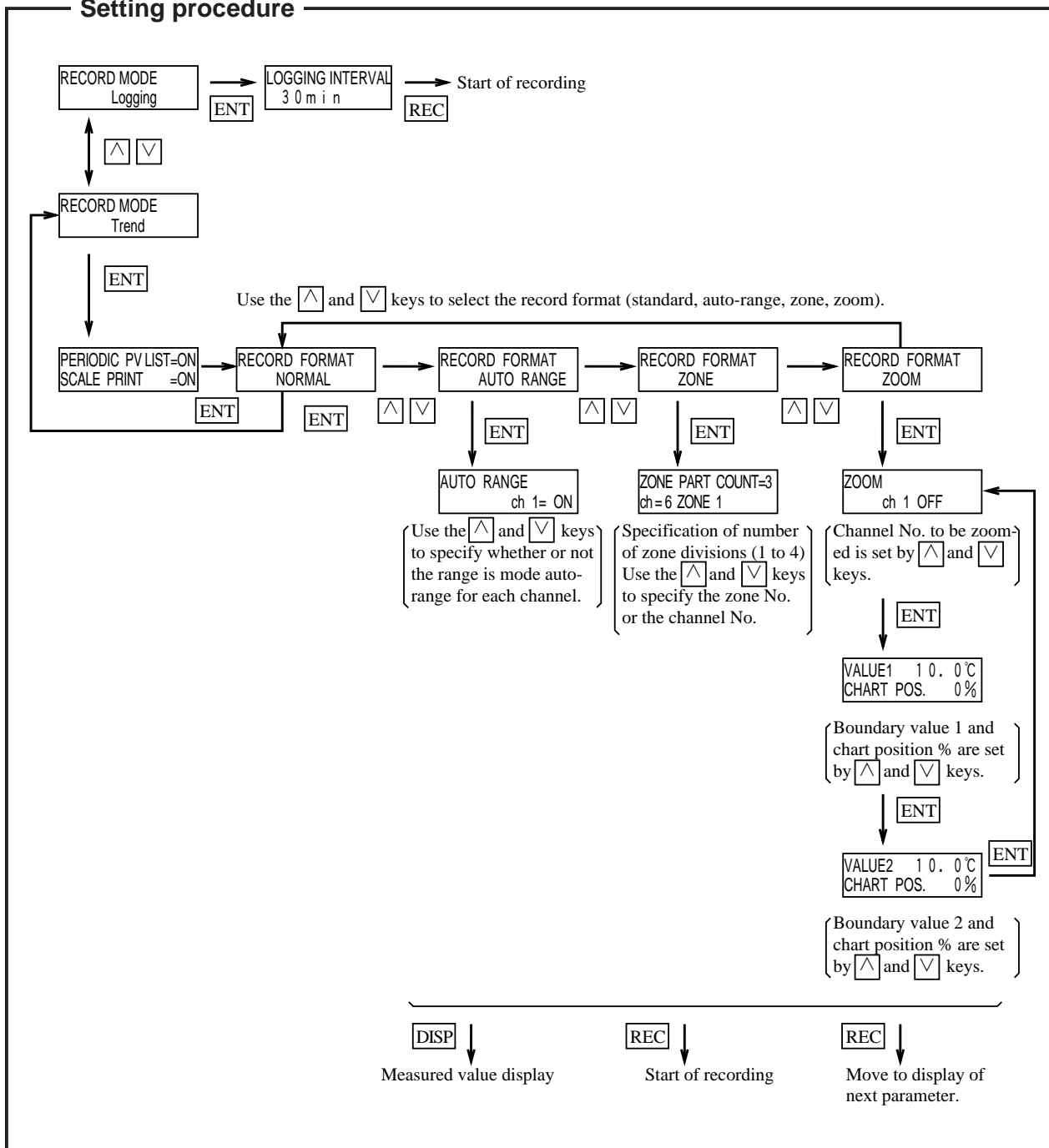

① Logging recording (logging)

- In this case, there is no analog trend recording but a record of data (the time channel Nos., measured values, units) is produced at specified intervals of time (10 - 60 minutes can be specified.)
- If there is detection or clearing of an alarm during logging print-out, this is printed on the right-hand side of the recording paper. (Example of print-out: Section 11.9)

② Periodic print-out

- The following items are printed out at set intervals in depending on chart speed.  
[Time line, time, chart speed, channel Nos., measured values, engineering units.]
- This print-out is effected alternately with scale print-outs.
- It is not effected if the periodic print-out is set to "OFF".

③ Scale print-out

- Scale lines, digits, unit and Tag Nos. are printed out at set intervals.
- This print-out is effected alternately with periodic print-outs.
- It is not effected if the scale print-out is set to "OFF".
- If both scale print-out and periodic print-out are set to "ON", the print-outs are effected alternately at set intervals.

Periodic print-out and scale print-out time intervals sub heading

The time intervals of print-outs vary depending on the chart speed.

(1) In the case of continuous recording

Chart speed (mm/h)	5 to 9	10 to 19	20 to 39	40 to 79	80 to 159	160 to 239	240 to 320
Print-out time interval	12 h	8 h	4 h	2 h	1 h	30 min	20 min

Chart speed (mm/h)	321 to 480	481 to 1500
Print-out time interval	15 min	10 min

When the chart speed exceeds 401mm/h, **only the time line is recorded.** Periodic print-out and scale print-out are not effected.

(2) In the case of intermittent recording

Chart speed (mm/h)	5 to 9	10 to 19	20 to 39	40 to 79	80 to 159	160 to 239	240 to 320
Print-out time interval	12 h	8 h	4 h	2 h	1 h	30 min	20 min

Chart speed (mm/h)	321 to 480	481 to 1500
Print-out time interval	15 min	10 min

When the chart speed exceeds 51mm/h, **only the time line is recorded.** Periodic print-out and scale print-out are not effected.

Note: If the time for a periodic print-out or scale print-out arrives while data printing or other list printing is in progress, the periodic print-out or scale print-out is not made.

If data print-out is started while a periodic print-out or scale print-out is in progress, the periodic print-out or scale print-out is halted partway through.



---

④ Auto-range recording (auto-range)

- If input outside the record range occurs, recording is effected with the record range automatically changed.
- The record range after a change goes 50% of the span to the plus side or the minus side. Note that the recording span does not change. (Made effective with an ON setting.)

Example : With a 0 to 100°C record range (recording span 100°C)

- If input goes beyond the range in the positive direction, there is a change to 50 to 150°C.
- If input goes outside the range in the negative direction, there is a change to -50 to +50°C.

Note 1: A change in the range is only effected once in a given direction.

Once a range has changed in the positive direction, it does not change again even if the record range is exceeded again.

Note 2: If the record range changes because it has been exceeded in the positive direction and then input below the new range in the negative direction there is a return to the original range. (The reverse also applies.)

Note 3: A mark is printed in black at the right-hand edge of the recording paper when the range changes.

Note 4: There is a record range MAX. value and MIN. value for each type of input.

Consequently, if a change means that a range is going to go beyond the MAX. value or MIN. value for the record range of the type of input in question, the MAX. value or MIN. value imposes a limit.

Example : For a K thermocouple 0 to 1000°C record range

If over-range occurs: change to 400 to 1400°C

If under-range occurs: change to -230 to 770°C

Note 5: Auto-range recording cannot be specified simultaneously with zoom recording or zone recording.

⑤ Enlarged/reduced recording (zoom)

- Within the record range (record range) for each channel, there are three recording scales. This makes it possible to have an enlarged record in one portion and a reduced record in the other portion.

Example: With a 0 to 100°C record range:

Suppose you want to enlarge 40 to 60°C record in a 10 to 90% range.

(The 0 to 10% range becomes a reduced record of 0 to 60°C, and the 90 to 100% range becomes a reduced record of 60 to 100°C)

Boundary value 1 = 40°C                      Boundary value 2 = 60°C

Chart position = 10%                      Chart position = 90%

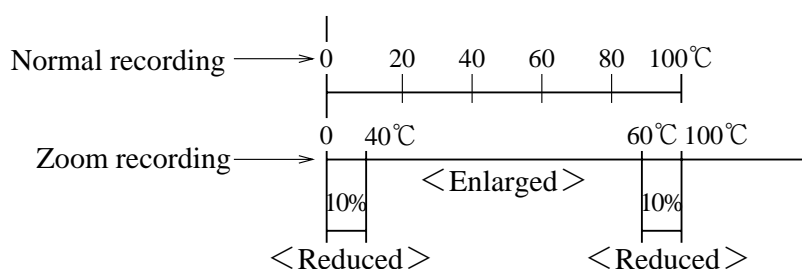

Note 1: Do not set the normal recording 0% value at the 100% recording position or the normal recording 100% value at the 0% recording position.

If you do, proper operation becomes impossible.

Note 2: If zoom recording is specified, scale print-out digits are printed only for the 4 points 0% and 100% of the record range, and the boundary value 1 and the boundary value 2. (Boundary value scale digits are printed only if the record position is 15 to 85% and when the difference between boundary value 1 and boundary value 2 is less than 7%, only the small chart position is printed.)

Example: With a record range 0 to 500°C, the boundary value 1 of 200°C, chart position of 30%, and the boundary value 2 of 300°C, chart position of 70%.



Note 3: Zoom recording cannot be specified simultaneously with auto-range recording or zone recording.

⑥ Zone recording (zone)

- The recording width is 100mm and overlap of the records of different channels is prevented by the provision of recording zones for the various channels.
- Any zone can carry the record of any channel.
- The number of divisions is up to a maximum of 3 zones.

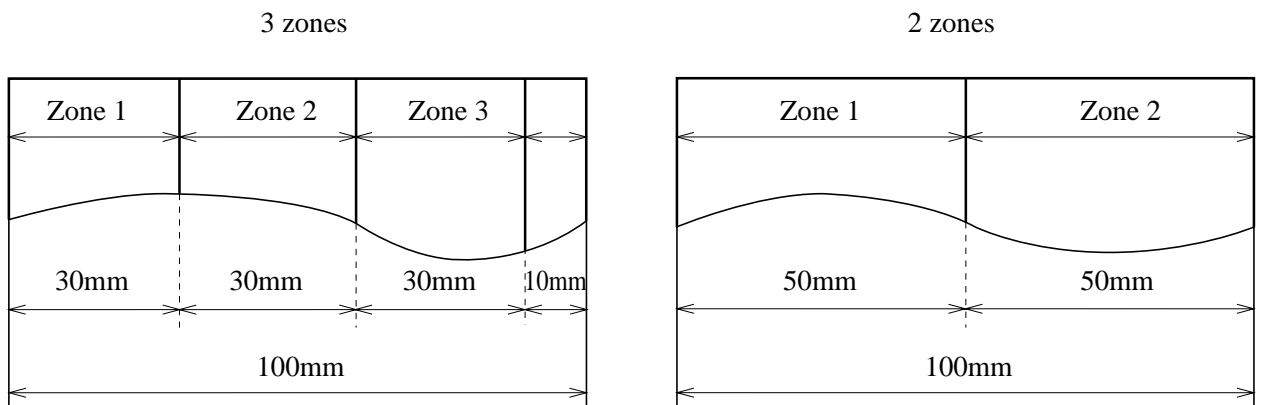

10mm at the right-hand edge is blank

Note 1: For scale print-outs when zone recording is specified, there is a print-out only of scale digits for the 2 points record range 0% and 100%.

Note 2: During zone recording, alarm print-outs and burn-out print-outs are produced at the right-hand edge whatever the zone.

Note 3: Zone recording cannot be specified simultaneously with auto-range recording or zoom recording.

## 7.7 Setting record ranges

### Explanation

An individual record range is set for each channel.

'Record range' means the 0% and 100% position scale on recording paper.

When the recorder is used with DC voltage input scaling, the recording range should be specified after setting the scaling.

When the scaling has been set, the decimal point position of the recording range is the same as the decimal point position specified by engineering values.



Example	The record range of channel 1 is changed from 0 to 100°C to -50 to 50°C.	
Key actuation	Explanation	Display
<div style="border: 1px solid black; padding: 2px; display: inline-block;">SEL</div> 	Press the <div style="border: 1px solid black; padding: 2px; display: inline-block;">SEL</div> key several times to give the recording range display.	<div style="border: 1px solid black; padding: 5px; width: fit-content;">           C h 1 RANGE °C            0.0 ~ 1 0 0.0         </div>
<div style="border: 1px solid black; padding: 2px; display: inline-block;">ENT</div> 	Since channel No. 1 is selected, press the <div style="border: 1px solid black; padding: 2px; display: inline-block;">ENT</div> key.	<div style="border: 1px solid black; padding: 5px; width: fit-content;">           C h 1 RANGE °C            0.0 ~ 1 0 0.0         </div>
<div style="border: 1px solid black; padding: 2px; display: inline-block;">∇</div> <div style="border: 1px solid black; padding: 2px; display: inline-block;">ENT</div>	Press the <div style="border: 1px solid black; padding: 2px; display: inline-block;">∇</div> key to change the range lower limit from "0" to "-50" and press the <div style="border: 1px solid black; padding: 2px; display: inline-block;">ENT</div> key.	<div style="border: 1px solid black; padding: 5px; width: fit-content;">           C h 1 RANGE °C            -5 0.0 ~ 1 0 0.0         </div>
<div style="border: 1px solid black; padding: 2px; display: inline-block;">∇</div> <div style="border: 1px solid black; padding: 2px; display: inline-block;">ENT</div> 	Press the <div style="border: 1px solid black; padding: 2px; display: inline-block;">∇</div> key to change "100" to "50" and press the <div style="border: 1px solid black; padding: 2px; display: inline-block;">ENT</div> key.  ( When the <div style="border: 1px solid black; padding: 2px; display: inline-block;">ENT</div> key is pressed, the channel No. flashes and the setting is completed. Follow the same procedure for setting in other channels. )	<div style="border: 1px solid black; padding: 5px; width: fit-content;">           C h 1 RANGE °C            -5 0.0 ~ 5 0.0         </div>

Table 1 Specifiable ranges record ranges

Type		Reference range	Reference range	Specifiable ranges for record range	
Thermo-couples	B	400 ~ 1760°C	752 ~ 3200°F	370.0 ~ 1790.0°C	698.0 ~ 3254.0°F
	R	0 ~ 1760°C	32 ~ 3200°F	- 30.0 ~ 1790.0°C	- 22.0 ~ 3254.0°F
	S	0 ~ 1760°C	32 ~ 3200°F	- 30.0 ~ 1790.0°C	- 22.0 ~ 3254.0°F
	K	-200 ~ 1370°C	-328 ~ 2498°F	- 230.0 ~ 1400.0°C	- 382.0 ~ 2552.0°F
	E	-200 ~ 800°C	-328 ~ 1472°F	- 230.0 ~ 830.0°C	- 382.0 ~ 1526.0°F
	J	-200 ~ 1100°C	-328 ~ 2012°F	- 230.0 ~ 1130.0°C	- 382.0 ~ 2066.0°F
	T	-200 ~ 400°C	-328 ~ 752°F	- 230.0 ~ 430.0°C	- 382.0 ~ 806.0°F
	N	0 ~ 1300°C	32 ~ 2372°F	- 30.0 ~ 1330.0°C	- 22.0 ~ 2426.0°F
	W	0 ~ 1760°C	32 ~ 3200°F	- 30.0 ~ 1790.0°C	- 22.0 ~ 3254.0°F
	L	-200 ~ 900°C	-328 ~ 1652°F	- 230.0 ~ 930.0°C	- 382.0 ~ 1706.0°F
	U	-200 ~ 400°C	-328 ~ 752°F	- 230.0 ~ 430.0°C	- 382.0 ~ 806.0°F
	P N	0 ~ 1300°C	32 ~ 2372°F	- 30.0 ~ 1330.0°C	- 22.0 ~ 2426.0°F
Resist- ance bulbs	JPt100	-200 ~ 600°C	-328 ~ 1112°F	- 230.0 ~ 630.0°C	- 382.0 ~ 1166.0°F
	Pt100	-200 ~ 600°C	-328 ~ 1112°F	- 230.0 ~ 630.0°C	- 382.0 ~ 1166.0°F
DC voltage		- 50 ~ + 50mV -500 ~ +500mV - 5 ~ + 5V - 50 ~ + 50V		- 55.00 ~ +55.00mV - 550.0 ~ +550.0mV - 5.500 ~ +5.500V - 55.00 ~ +55.00V	

\* JPt100 : Pt100Ω for JIS CI604 1981.

The range -32767 to 32767 (decimal points can be located wherever required) can be specified for the record range in scaling or difference calculation specifications.

## 7.8 Setting kind of input, skip, unit, filter, scaling and subtraction

### Explanation

Kind of input (B, R, S, K, E, J, T, N, W, L, U, PH thermocouples, JPt, Pt, voltage, com, copy skip), units (°C, °F, mV, V), filters (time constant) and scaling, input range, industrial value (scaling value), unit, rooter (square extraction) and logarithmic calculation for DC voltage input can be set for each channel. This parameter is also used for setting subtraction.

= Explanations of display =

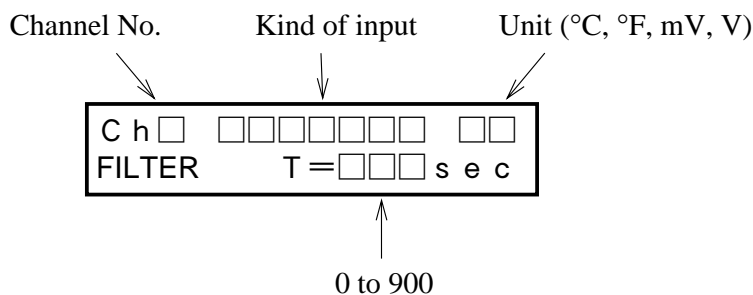

Note: When the kind of input is set to skip, indication, recording and alarm operations are not performed.

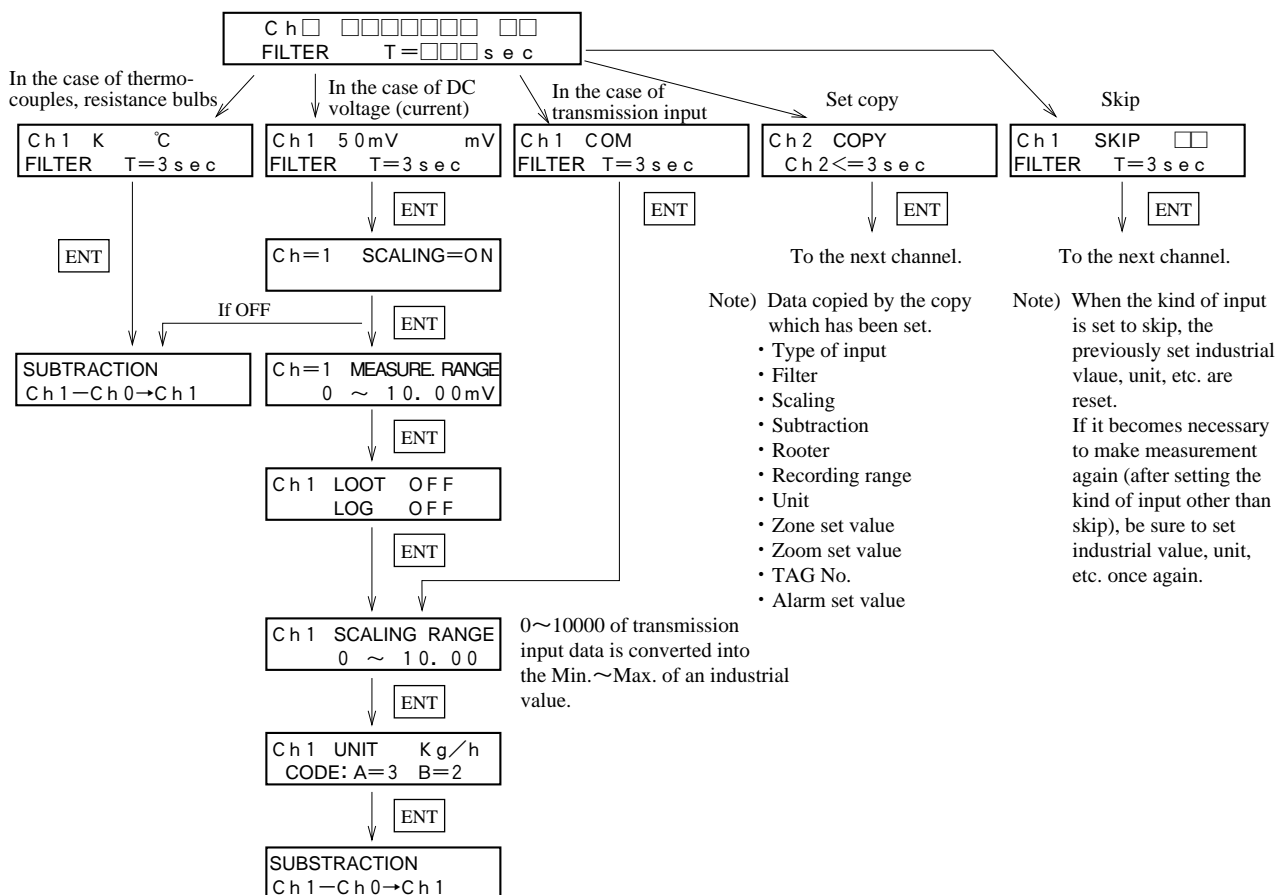

① Setting and changing input signal type

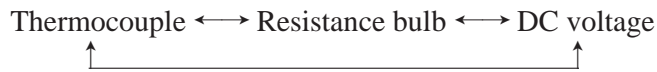

To effect the changes refer to Section 5.3 to change the positions of the setting pins. Then, use the following parameter specification to specify the correct input signal type.

Example: Changing 5V input signal type of channel 6 to thermocouple input

C h 1 K °C  
FILTER T = 3 s e c

Use the  $\uparrow$   $\downarrow$  keys to select channel 6 and press the  $\text{ENT}$  key.

$\downarrow$   $\text{ENT}$

C h 6 5 V V  
FILTER T = 3 s e c

The current "5V" value is flashing; press the  $\uparrow$   $\downarrow$  keys to select the "K" input type and press the  $\text{ENT}$  key. (Note)

(Note)

The type of input is displayed in the following order by pressing the  $\uparrow$  key (in reverse order with  $\downarrow$  key).

K → E → J → T → R → S → B → N → W → L → U → P N → P t → J P t → 50mV  
Skip ← Copy ← C O M ← 50 V ← 5 V ← 500mV

$\downarrow$   $\text{ENT}$

C h 6 K °C  
JUMPER SETTING O K ?

**There is output of a display asking you to check the change in setting pins and the type of input after the change. Please check that the work of changing the setting pins has been completed.**

$\text{ENT}$

If everything is OK, press the  $\text{ENT}$  key.

② Setting and changing the input filter

C h 6 K °C  
FILTER T = 3 s e c

If there is no change in the filter, press the  $\text{ENT}$  key.

$\downarrow$   $\text{ENT}$

Input filter setting range: 0 to 900 sec. (in 1 sec. Units)

SUBTRACTION  
C h 1 - C h 0 → C h 6

There is a move to the next parameter.

③ Scaling , scaling ranges, units

- For DC voltage input, scaling is set to "ON" or "OFF".
- The  $\boxed{\wedge}$  and  $\boxed{\vee}$  keys are used to set the measurement range.  
(The left-hand side is the lower limit and the right-hand side the upper limit.)
- The  $\boxed{\wedge}$  and  $\boxed{\vee}$  keys are used to specify scaling range for the corresponding measurement range.  
(Range of -32767 to 32767; decimal point can be located anywhere)
- The decimal point positioning  
When the  $\boxed{\text{ENT}}$  key is pressed following setting of the upper limit value, the lower limit value and the upper limit value both flash. The positions of the decimal points can now be changed by pressing the  $\boxed{\wedge}$  and  $\boxed{\vee}$  keys.  
Example: 0.00 to 10.00
- Referring to the 'Units code table' on page 7-21, press the  $\boxed{\wedge}$ ,  $\boxed{\vee}$  keys to specify the units.  
Example: Code A = 3, B = 2  $\Rightarrow$  kg/h

Note: Relation between measuring range, industrial value, recording range and indicated value.

Example:

		Example 1	Example 2	Example 3	Example 4
Specifica- tions	Input range	5V	5V	5V	5V
	Mesurement range	1 to 5V	1 to 5V	1 to 5V	1 to 5V
	Engineering value	0 to 1000	0 to 1000	0 to 1000	0 to 1000
	Record range	0 to 1000	0 to 500	0 to 2000	-1000 to 1000
	(Enginnering units)	(t/h)	(t/h)	(t/h)	(t/h)
If input is 1V	Indicated value	0 (t/h)	0 (t/h)	0 (t/h)	0 (t/h)
	Record	0% point	0% point	0% point	50% point
If input is 3V	Indicated value	500 (t/h)	500 (t/h)	500 (t/h)	500 (t/h)
	Record	50% point	100% point	25% point	75% point
If input is 5V	Indicated value	1000 (t/h)	1000 (t/h)	1000 (t/h)	1000 (t/h)
	Record	100% point	Over 100.5% point	50% point	100% point

Note: When setting scaling "ON", the recording range is cleared to zero. Set it again referring to Item 7.7 "Setting of recording range".

④ Square root extraction

- This sets a rooter (square root extraction) function for each channel.

ON : Operative

OFF : Inoperative

This calculates square root of input values converted to % taking the specified measurement range to be 0 to 100%. Negative input is regarded as 0%. Data (0 to 100%) after square root extraction are converted to scaling ranges.

Example: With Input range 5V

Measurement range 1 to 5V

Working value 0 to 1000 (t/h)

	Scaling range	Record
If the input is 1V (0%)	$(1000 - 0) \times \sqrt{0} = 0$ (t/h)	0% point
If the input is 3V (50%)	$(1000 - 0) \times \sqrt{0.5} = 707$ (t/h)	70.7% point
If the input is 5V (100%)	$(1000 - 0) \times \sqrt{1} = 1000$ (t/h)	100% point

⑤ Logarithmic calculation

- Setting of logarithmic calculation function of each channel.

ON : Valid

OFF : Invalid

- ① Instruction and print format : 9.9E ±9

Indication : -9 to 9

Numeric unit : 1 digit below decimal point

Data range :  $1.0 \times 10^{-9}$  to  $1.0 \times 10^9$

(When the index value is negative for simultaneous display of 6 channels,  $1.0^{-9}$  is displayed.)

- ② Setting of industrial value and recording range

Setting of industrial value

To be set by index only

C h 1	Industrial value
	0 ~ 9

(this means  $10^0$  to  $10^9$ )

Setting of threshold of recording range

and zoom recording

To be set by index only

C h 1	Recording range	V
	0 ~ 8	

(this means  $10^0$  to  $10^8$ )

Example of setting :

Input 1 to 5V is converted into  $10^0$  to  $10^8$  at setting of measurement range 1 to 5V and industrial value 0 to 9

	Industrial value
Input 10 (0%)	1.0E0
Input 30 (50%)	1.0E4
Input 50 (100%)	1.0E8

Example of scale print: (only  $10^n$  is printed)

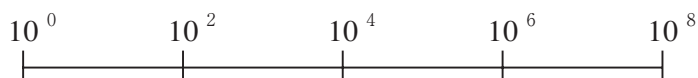

- ③ During logarithmic operation setting, subtract calculation and integration are not available, and average value is not printed on the daily report list.



## ⑥ Subtraction

- This is a specification for recording the result of calculation of the difference between 2 channels.  
Example: The result of Ch1 to Ch3 is recorded in Ch1.
- Subtract calculations are only possible between channels for which the units and decimal point position are the same. (If they are different, results cannot be guaranteed.)
- If Ch0 is specified, no subtract calculation is performed.
- When the channel requiring subtract calculation is skipped, the subtract calculation is skipped, the subtract calculation is not performed.

## Cautions on setting/change of input signal, scaling and subtract calculation

When setting or changing input signal, scaling or subtract calculation, the parameter of the corresponding channel is initialized as shown below. In this case, be sure to set the parameter once again.

Parameter \ Initializing timing	Change of input signal and setting of scaling OFF	Setting of scaling ON	Setting of subtract calculation CH = 0 < Subtract calculation OFF >
Recording range	Initial value corresponding to the type of input is obtained	Cleared to 0, 0 to 0	Initial value corresponding to the type of input is obtained
Alarm	All alarms (H, L, RL, RH) turn OFF. Alarm set value and output relay No. are cleared to 0.		
Auto range	Auto range setting for the channel to be changed turns OFF	_____	_____
Zoom	Zoom setting for the channel to be changed turns OFF, and threshold value and chart position are cleared to 0.	_____	Threshold value for the channel to be changed is cleared to 0.
Scaling	Scaling turns OFF and measuring range, industrial value and unit are initialized.	_____	_____
Router	OFF	_____	_____
Subtract calculation	Subtract calculation channel = 0 (Subtract calculation OFF)	_____	_____
PV shift	Initial value Shift = 0, inclination = 100%	Ditto	_____

Table of unit codes

Classification	Code B	1	2	3	4	5	6	7	8	9	10
	Code A										
Temperature, humidity	1	°C	°F					%RH	Vo1%		
Flow rate	2	t/day	kg/day	g/day	Nm <sup>3</sup> /day	m <sup>3</sup> /day	Nl/day	l/day	cc/day		
	3	t/h	kg/h	g/h	Nm <sup>3</sup> /h	m <sup>3</sup> /h	Nl/h	l/h	cc/h		
	4	t/min	kg/min	g/min	Nm <sup>3</sup> /min	m <sup>3</sup> /min	Nl/min	l/min	cc/min		
	5	t/sec	kg/sec	g/sec	Nm <sup>3</sup> /sec	m <sup>3</sup> /sec	Nl/sec	l/sec	cc/sec		
Pressure	6	mmH <sub>2</sub> O	mH <sub>2</sub> O	mmHg	cmHg	mHg	mmAq		mbar	bar	
	7	mg/cm <sup>2</sup>	g/cm <sup>2</sup>	kg/cm <sup>2</sup>		N/mm <sup>2</sup>	N/m <sup>2</sup>		psi	Torr	
	8	mPa	Pa	kPa	MPa						
Level, height	9	mm	cm	m					in	ft	
Capacity, weight, area	10	ml	l	k1		mm <sup>3</sup>	cm <sup>3</sup>	m <sup>3</sup>		cc	
	11	mm <sup>2</sup>	cm <sup>2</sup>	m <sup>2</sup>			g	kg	t		
Density	12	g/cm <sup>3</sup>	kg/cm <sup>3</sup>	g/m <sup>3</sup>	kg/m <sup>3</sup>	t/m <sup>3</sup>	g/l	kg/l	g/ml		
Analysis	13	ppm	ppmNH <sub>3</sub>	ppmSO <sub>2</sub>	ppmH <sub>2</sub> S	ppmCO	ppmO <sub>2</sub>	ppmNO <sub>x</sub>	ppb	pH	mol
	14	%	%H <sub>2</sub>	%CO <sub>2</sub>	%He	%Ar	%O <sub>2</sub>	%NaCl	%CO	CP	PO <sub>2</sub>
Force - energy	15	mN	N	Nm	gcm	kgcm	kgm		J	KJ	HP
Speed, acceleration	16	mm/sec	mm/min	mm/h	m/sec	m/min	m/h	km/h			
	17	rps	rpm	rph		m/sec <sup>2</sup>	rad/sec				
Time	18	μ sec	msec	sec	min	h					
Electromagnetism	19	mV	V	kV	μ A	mA	A		A/T	Hz	dB
	20	W	kW	VA	kVA	Var	kVar	Ω cm	kΩ cm	MΩ cm	μ S/cm
	21	μ F	F	mH	H	C	mΩ	Ω	kΩ	MΩ	μ
Heat, light	22	kcal	cal	kcak/m <sup>3</sup>		lx	cd	lm	cd/m <sup>2</sup>		
Radiation	23	cps	cpm	μ Sv/h	mSv/h	nGy/h	μ Gy/h	μ m	g/m <sup>2</sup>		
Others	24	Pa·s	mPa·s								

Note: Empty boxes are spaces.

Any units prepared by users can be registered in 12 places of the Code A=1-12 and B=10.

(See Section 9.4)

Example of specification: kg/h is specified.











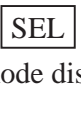



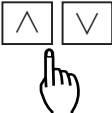
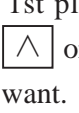

Code A : 3 Code B : 2 specified



C h 1	UNIT
A = 3	B = 2

## 7.9 Setting TAG Nos.

### Explanation

A Tag No. for each channel is specified by up to 8 alphanumeric characters. Specified Nos. are printed on the recording paper, so as to identify the channel to which measurement record applies.

Example	The Tag No. "TR1-1234" of Ch1 is changed to "RR1-ABCD".	
Key actuation	Explanation	Display
	Press the  key several times to give the Tag No. mode display.	
	Since channel No. 1 is selected, press the  key.	
	The 1st place of the Tag No. flashes. Press the  or  key to indicated the character you want.	
	Press the  key.	
	When the  key is pressed, the 2nd position of the Tag No. flashes. Specify this and subsequent place in the same way.	
	If 8 places are not needed, press the  key to make each position flash in turn. When the channel No. flashes, the specification is complete. Follow the same procedure to specify Tag Nos. for other channels	

TAG No. Table : The following characters and symbols can be specified. Select with the ,  keys.  
(Total of 67 characters/symbols)

A B C D E F G H I J K L M N O P Q R S T U V W X Y Z
a b c d e f g h i j k l m n o p q r s t u v w x y z
0 1 2 3 4 5 6 7 8 9 . + - * / % Space

Tag No. is printed on scale and displayed together with industrial value of corresponding channel as shown below.

1	100	°C
RR1-ABCD	Record on	

## 7.10 Message print specification

### Explanation

- Message print is possible at the occurrence of any events.
- Up to 10 messages, each containing a maximum of 16 characters, can be registered by the user.
- Messages can be specified in numerals, alphabets and other special symbols. Print colors (orange, red, blue, green, purple, black) and print positions (0 to 68mm) can also be specified.
- Message print timing can be specified for fixed time at the time of alarm, DI input and recording start.

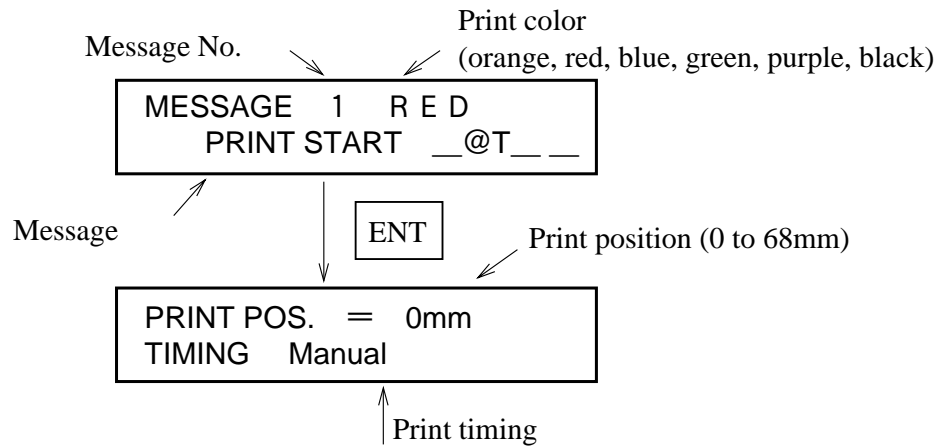

#### (1) Print color specification

- ① Message print color is selected by  $\wedge$ ,  $\vee$  keys. Press the  $\boxed{\text{ENT}}$  key after selection.
- ② Print color comes in 6 kinds (orange, red, blue, green, purple, black).
- ③ When OFF is set in print color, no message is printed.

#### (2) Message specification

- ① At the completion of print color specification, the first digit of message flashes. Press the  $\wedge$ ,  $\vee$  keys to display desired characters, then press the  $\boxed{\text{ENT}}$  key. At this time, the second digit flashes. Specify the next desired characters in the same manner.
- ② When '@Y', '@D' and '@T' are specified in message, "year", "month", "day" and "time" are printed (year is expressed in 3 characters, while month, day and time are expressed in 5 characters).  
Example: Specification: @Y    @D    @T     
Print: ' 9 3 0 6 / 0 9 1 2 : 0 0
- ③ When '@1 to 6' are specified in message, measured values (7 characters, without unit) corresponding to Ch1 to 6 are printed.  
Example: Specification: ch    1    @1    mV     
Print: ch 1 - 0 . 0 0 5 mV
- ④ When message contains more than 16 characters, up to 16 characters are printed.

### (3) Print position specification

- ① Message print position can be selected by the  $\boxed{\wedge}$ ,  $\boxed{\vee}$  keys. Press the  $\boxed{\text{ENT}}$  key after selection.
- ② The print range is 0 to 68mm. The size of each print character is 2mm.

Example : Print position for chart

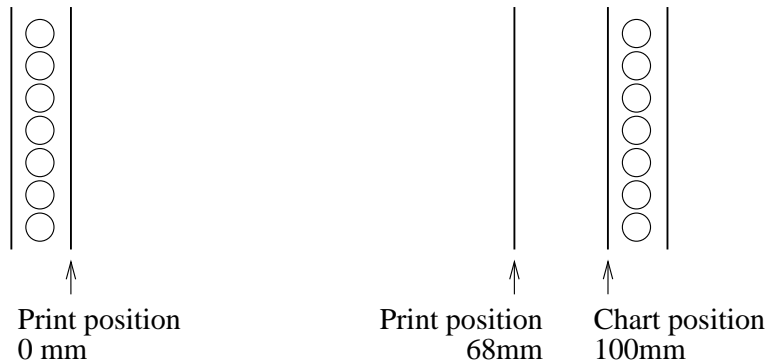

### (4) Print timing specification

- ① Select message print timing with  $\boxed{\wedge}$ ,  $\boxed{\vee}$  keys and press  $\boxed{\text{ENT}}$  key.
  - (a) Manual
    - When "manual" is selected, messages cannot be printed except for list print.
  - (b) Recording start
    - When "Record start" is selected, message are printed at the start of recording (record reset after power ON, and record start with  $\boxed{\text{REC}}$  key).
  - (c) DI 1 ON, DI 1 OFF
    - When DI 1 is selected, messages are printed at ON or OFF of DI 1 (terminals; ⑪ to ⑳). (When DI 2 is selected by message print timing, DI 1 record start/stop function is not operating)
  - (d) DI 2 ON, DI 2 OFF
    - When DI 2 is selected, message are printed at ON or OFF of DI 2 (terminals; ㉑ to ㉒). (When DI 2 is selected by message print timing, DI 2 chart paper feed speed select function is not operating)
  - (e) DI 3 ON, DI 3 OFF
    - When DI 3 is selected, message are printed at ON or OFF of DI 3 (terminals; ㉓ to ㉔). (When DI 3 is selected by message print timing, DI 3 data print function is not operating)
  - (f) 00:00 ~ 24H
    - When time is selected, messages are printed at set time, then printing is made at intervals of designated print time ("minute" not settable).

Example : Messages are printed at intervals of 2 hours starting from 8 o'clock.

PRINT POS. = 0 mm TIMING 8 : 0 0 ~ 2 H	Set 8:00 with $\boxed{\wedge}$ and $\boxed{\vee}$ keys and press $\boxed{\text{ENT}}$ key, then set 2H with $\boxed{\wedge}$ and $\boxed{\vee}$ keys and press $\boxed{\text{ENT}}$ key.
---	--

---

(g) ALM1 1 OFF

- When alarm is selected, message are printed at ON or OFF of alarm of the set channel.  
Example : Message are printed at ON of channel 2 No. 1 alarm.

PRINT POS. = 0 mm
TIMING ALM 2 1 ON

Set channel 2 with  ^ and  v keys and press  ENT key. Then set alarm No. with  ^ and  v keys and press  ENT key. Next, set ON with  ^ and  v keys and press  ENT key.



(h) Record end

Messages are printed at stop of recording.

## 7.11 List print-out specification

### Explanation

- This is used for any of the parameter list print-outs, scale print-outs, test pattern print-outs, daily report lists, totalize lists, message print-out and list print is used for printing parameter list, scaling, test pattern, daily report list, integration list and messages.
- The data display mode during printing of a list is the normal measurement display mode.
- If a list is printed during recording operation, analog trend recording is halted but it automatically restarts when print-out of the list ends. Message print is possible without suspending analog trend recording.

Example	Print-out of a test pattern is mode.	
Key actuation	Explanation	Display
<div style="border: 1px solid black; padding: 2px; display: inline-block; margin-bottom: 5px;">SEL</div> 	Press the <div style="border: 1px solid black; padding: 2px; display: inline-block;">SEL</div> key several times to give the list selecting display.	<div style="border: 1px solid black; padding: 5px; width: fit-content;">LIST = 1 PARAMETER LIST</div>
<div style="border: 1px solid black; padding: 2px; display: inline-block; margin-bottom: 5px;">^</div> 	Press the <div style="border: 1px solid black; padding: 2px; display: inline-block;">^</div> key to change to "List = 3" TEST PATTERN.	<div style="border: 1px solid black; padding: 5px; width: fit-content;">LIST = 3 TEST PATTERN</div>
<div style="border: 1px solid black; padding: 2px; display: inline-block; margin-bottom: 5px;">ENT</div> 	When the <div style="border: 1px solid black; padding: 2px; display: inline-block;">ENT</div> key is pressed, printing starts.  ( To stop the print-out partway through, ) press the <div style="border: 1px solid black; padding: 2px; display: inline-block;">LIST</div> key.	









































- LIST = 1 PARAMETER ..... Example of print-out: See Section 11.3
- 2 SCALE PRINT (Print-out for each channel is possible.)  
 ..... Example of print-out: See Section 11.5
- 3 TEST PATTERN ..... Example of print-out: See Section 11.4
- 4 DAILY REPORT ..... Example of print-out: See Section 11.6
- 5 SUM DATA LIST ..... Example of print-out: See Section 11.7
- 6 MESSAGE PRINT (Print-out for each No. is possible.)  
 ..... Example of print-out: See Section 11.8

Note 1: In the case of continuous recording, when a list print-out ends and analog trend recording restarts, the input value of immediately before the list print-out and the input value of immediately after the list print-out are recorded as a continuous line.

## 7.12 Daily report specification

### Explanation

- Instantaneous value data for each hour in each channel over a 24-hour period (up to 24 data items) and the average values, maximum values and minimum values of these lots of data items are printed out. (Printing time: about 24 minutes/6 channels for 24-hour setting) (Analog trend recording cannot be performed during print-out.)
- The specification consists of specifying operation start time and operation end time on/off for automatic print-out and on/off for operation in each channel.  
(Daily report operation is not performed for the channel set to OFF.)
- Both dairy report and automatic print-out is set ON, since the next day you have set up, dairy report will be printed out automatically everyday at the time you finish operation.
- To print out reports for 24hours, Set the same start and end time.
- Even if trend recording, logging recording and totalize operation is stopped, dairy report and automatic print-out is performed.

Example	Print-out of a test pattern is mode.	
Key actuation	Explanation	Display
 	Press the  key several times to display "DAILY REPORT"	
 	Press the  key to display "ON" and press the  key.	
  	Next, use the  ,  keys to display "ON" for causing automatic print-out and press the  key.	
  	Use the  ,  keys to set the operation start time to "09" and press the  key.	
  	Press the  ,  keys to set operation end time to "16", then press the  key.	
  	Use the  ,  keys to select channel No. 1 and press the  key.	
	Next, use the  ,  keys to select ON and press the  key.	
	Follow the same procedure to make setting for channel Nos. 2 to 6.	



Note: Relations between operation start times and printing time

When the setting of the start time and end time of daily report is changed, the print list thereafter is not compensated.

After changing the time setting, set the daily report or integration to OFF (buffer clear), then set it to ON and wait for 1 day (until the end time of the following day).

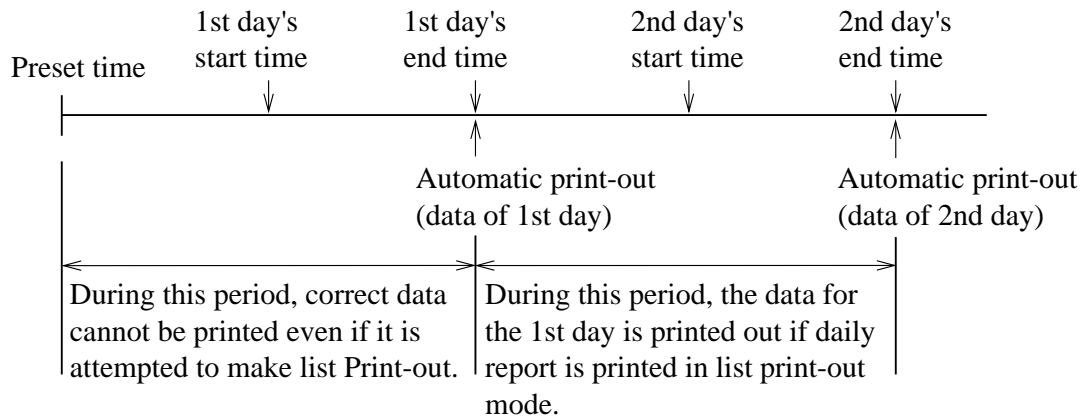



When printing 24-hour daily report, set the same start time and end time.

### 7.13 Specifying totalize function

#### Explanation

- A maximum 24-hour lots of wholly totalizing value data in each channel (up to 24 data items) and the value of the sum totals of these lots of 24 data items are printed out (Printing time: about 24 minutes/6 channels). (Analog trend recording cannot be performed during print-out.)
- The specification consists of specifying on/off for automatic print-out and on/off for operation in each channel.  
(Totalize function is not available for the channel set to OFF.)
- Both totalize operation and automatic print-out is set ON, since the next day you have set up, totalize result will be printed out automatically everyday at the time you finish operation.
- To print out reports for 24hours, Set the same start and end time.
- Even if trend recording, logging recording and dairy report is stopped, totalize operation and automatic print-out is performed.

Example	Totalize operation is performed from 9 to 16 o'clock and automatic print-out is effected for channel 1 to 6.	
Key actuation	Explanation	Display
<div style="border: 1px solid black; padding: 2px; display: inline-block;">SEL</div> 	Press the <div style="border: 1px solid black; padding: 2px; display: inline-block;">SEL</div> key several times to display "DATA SUM FUNCTION"	<div style="border: 1px solid black; padding: 5px; text-align: center;">           DATA SUM FUNCTION            O F F         </div>
<div style="border: 1px solid black; padding: 2px; display: inline-block;">^</div> <div style="border: 1px solid black; padding: 2px; display: inline-block;">ENT</div>	Press the <div style="border: 1px solid black; padding: 2px; display: inline-block;">^</div> key to display "ON" and press the <div style="border: 1px solid black; padding: 2px; display: inline-block;">ENT</div> key.	<div style="border: 1px solid black; padding: 5px; text-align: center;">           DATA SUM FUNCTION            O N         </div>
<div style="border: 1px solid black; padding: 2px; display: inline-block;">^</div> <div style="border: 1px solid black; padding: 2px; display: inline-block;">v</div> <div style="border: 1px solid black; padding: 2px; display: inline-block;">ENT</div>	Next, use the <div style="border: 1px solid black; padding: 2px; display: inline-block;">^</div> , <div style="border: 1px solid black; padding: 2px; display: inline-block;">v</div> keys to display "ON" for causing automatic print-out and press the <div style="border: 1px solid black; padding: 2px; display: inline-block;">ENT</div> key.	<div style="border: 1px solid black; padding: 5px; text-align: center;">           AUTO PRINT            O N         </div>
	Use the <div style="border: 1px solid black; padding: 2px; display: inline-block;">^</div> , <div style="border: 1px solid black; padding: 2px; display: inline-block;">v</div> keys to set the operation start time to "09" and press the <div style="border: 1px solid black; padding: 2px; display: inline-block;">ENT</div> key.	<div style="border: 1px solid black; padding: 5px;">           START TIME            0 9 : 0 0            STOP TIME             1 6 : 0 0         </div>
	Press the <div style="border: 1px solid black; padding: 2px; display: inline-block;">^</div> , <div style="border: 1px solid black; padding: 2px; display: inline-block;">v</div> keys to set operation end time to "16", then press the <div style="border: 1px solid black; padding: 2px; display: inline-block;">ENT</div> key.	
<div style="border: 1px solid black; padding: 2px; display: inline-block;">^</div> <div style="border: 1px solid black; padding: 2px; display: inline-block;">v</div> <div style="border: 1px solid black; padding: 2px; display: inline-block;">ENT</div>	Use the <div style="border: 1px solid black; padding: 2px; display: inline-block;">^</div> , <div style="border: 1px solid black; padding: 2px; display: inline-block;">v</div> keys to select channel No. 1 and press the <div style="border: 1px solid black; padding: 2px; display: inline-block;">ENT</div> key.	<div style="border: 1px solid black; padding: 5px; text-align: center;">           PRINT CHANNEL            C h <input type="checkbox"/> = O N         </div>
	Next, use the <div style="border: 1px solid black; padding: 2px; display: inline-block;">^</div> , <div style="border: 1px solid black; padding: 2px; display: inline-block;">v</div> keys to select ON and press the <div style="border: 1px solid black; padding: 2px; display: inline-block;">ENT</div> key.	
	Follow the same procedure to make setting for channel Nos. 2 to 6.	

Note: The relations between totalize operation start times and print-out times are the same as for the daily report function. See Section 7.12.

The input to the channel of integrating action ON is integrated in one second period, and it becomes 100% in an hour.

(Example) When the input 0 to 100L per hour:

The integrated value becomes 100L after integration of 100L per hour for one hour.

## 7.14 Transmission specification (option)

### Explanation

The transmission function (option) of this unit serves for transmission of measured values and reception of specified condition, etc. through an RS-485 interface.

For details, please see the separate booklet the 'RS-485 interface Manual'.

Items for specification in this unit are as follows.

COMMUNICATION STATION No <input type="checkbox"/>
--

The station No. can be set to 1 to 31 for RS-485. (It is set by means of the ,  keys.)

↓

BAUD RATE <input type="checkbox"/> <input type="checkbox"/> <input type="checkbox"/> b p s
---

The 4 rates 2400, 4800, 9600 and 19200 bps can be set for the baud rate (transmission rate).

(It is set by means of the ,  keys.)

↓

STOP BIT <input type="checkbox"/>
PARITY <input type="checkbox"/> <input type="checkbox"/> <input type="checkbox"/>

- The stop bit can be made 1 bit or 2 bits.
- Parity: Can be set to EVEN (even parity), ODD (odd parity), or NONE (no parity).

Items accessible by transmission are as follows.

	Item	READ	WRITE
Operation	Recording start/stop	×	×
	Extra value list print	×	×
	Chart fast-forward feed	×	×
Display	Measured value	○	○
	Time	○	×
	Alarm	○	×
	Chart end	○	×
	Carriage abnormal	○	×
	Battery end	○	×
	Burnout	○	×
Over/under range	○	×	
Manual print	Set value list print	×	×
	Test pattern print	×	×
	Scale print	×	×
	Daily report integration print	×	×
Setting	Main chart speed	○	○
	Sub chart speed	○	○
	Time setting	×	○
	Ink alarm clear	×	×
	Chart illumination lamp ON/OFF	○	○
Alarm	Alarm ON/OFF	○	○
	Alarm set value	○	○
	Output relay No.	○	○
Recording mode	Recording mode	○	○
	Fixed time print ON/OFF	○	○
	Scale print ON/OFF	○	○
	Logging interval	○	○
	Recording format	○	○
	Auto range channel ON/OFF	○	○
	Zoom record channel ON/OFF	○	○
	Zoom record position	○	○
	Zoom boundary value	○	○
	Zone record division number	○	○
Zone record channel zone No.	○	○	
Range	Record range	○	○
	Input unit	○	○
	Input filter value	○	○
	Scaling ON/OFF	○	○
	Router ON/OFF	○	○
	Measurement range	○	○
	Engineering value	○	○
	Decimal point position	○	○
	Engineering unit	○	○
	Subtraction channel No.	○	○
	TAG. No.	○	○
Daily report	Daily report ON/OFF	○	○
	Auto print ON/OFF	○	○
	Operation start time	○	○
	Channel ON/OFF	○	○
Integration	Integration ON/OFF	○	○
	Auto print ON/OFF	○	○
	Operation start time	○	○
	Channel ON/OFF	○	○
Transmission	Station No.	○	○
	Transmission speed	○	○
	Stop bit	○	○
	Parity	○	○

(Note 1)

○ : Possible

× : Not possible

(Note 2)





READ: Send data from recorder to personal computer

WRITE: Receive data from personal computer to recorder

## 7.15 Setting the time

### Explanation

Year, Month, Day, Hours, Minutes are displayed in that order going from the left.  
Initial value is set in Japan's time.

Example	Clock is 1 minute slow. (Correction of 35 minutes to 36 minutes)	
Key actuation	Explanation	Display
<div style="border: 1px solid black; padding: 2px; display: inline-block;">SEL</div> 	Press the <div style="border: 1px solid black; padding: 2px; display: inline-block;">SEL</div> key several times to display "DATE CLOCK".	<div style="border: 1px solid black; padding: 5px; width: fit-content;">           DATA CLOCK            ' 9 0 1 2 / 2 0 1 1 : 3 5         </div>
<div style="border: 1px solid black; padding: 2px; display: inline-block;">ENT</div> 	Since there is no change in the year, month, day or hours, press the <div style="border: 1px solid black; padding: 2px; display: inline-block;">ENT</div> key to get the "minutes" section flashing.	<div style="border: 1px solid black; padding: 5px; width: fit-content;">           DATA CLOCK            ' 9 0 1 2 / 2 0 1 1 : 3 5         </div>
<div style="border: 1px solid black; padding: 2px; display: inline-block;">^</div> 	Press the <div style="border: 1px solid black; padding: 2px; display: inline-block;">^</div> key to set to "36".	<div style="border: 1px solid black; padding: 5px; width: fit-content;">           DATA CLOCK            ' 9 0 1 2 / 2 0 1 1 : 3 6         </div>
<div style="border: 1px solid black; padding: 2px; display: inline-block;">ENT</div> 	Match the time to the recorded time on the telephone, etc, and press the <div style="border: 1px solid black; padding: 2px; display: inline-block;">ENT</div> key.	<div style="border: 1px solid black; padding: 5px; width: fit-content;">           DATA CLOCK            ' 9 0 1 2 / 2 0 1 1 : 3 6         </div>

Reference 1: The clock is set to the current time in JAPAN at the time of shipment.

It is backed up by a lithium battery and so continues counting even if there is a power failure or the power is cut off.

Reference 2: The time is indicated on a 24-hour clock basis. The setting is 00 hours 00 minutes e.g.-23 hours 59 minutes.

Reference 3: Seconds are not displayed.

When the minutes are set and the 

ENT

 key is pressed, a seconds counter is cleared to 0 and starts to count.



## 7.16 Method of ink out clear

### Explanation

This is a function or warning and detection of ink dry-up.

Normally, this operation is not required but **always set to "Clear" when you replace the recording head with a new one**. If you forget to make the setting "Clear", operation continues from the previous count value, and so the ink dry-up warning-detection count is actuated and there is a constant ink dry-up warning-detection print-out.













Note: If you set to "Clear" other than times of replacement with new parts, there will be no "Ink empty" display when low level is reached.

Example	Clearing ink out.	
Key actuation	Explanation	Display
<div style="border: 1px solid black; padding: 2px; display: inline-block;">SEL</div> 	Press the <div style="border: 1px solid black; padding: 2px; display: inline-block;">SEL</div> key several times to display "INK MONITOR CLEAR".	<div style="border: 1px solid black; padding: 5px; width: fit-content;">           INK MONITOR CLEAR?            N O         </div>
<div style="border: 1px solid black; padding: 2px; display: inline-block;">^</div> 	Press the <div style="border: 1px solid black; padding: 2px; display: inline-block;">^</div> key and change to "YES".	<div style="border: 1px solid black; padding: 5px; width: fit-content;">           INK MONITOR CLEAR?            Y E S         </div>
<div style="border: 1px solid black; padding: 2px; display: inline-block;">ENT</div> 	When the <div style="border: 1px solid black; padding: 2px; display: inline-block;">ENT</div> key is pressed the counter value is cleared.  Display moves to the next parameter.  Press the <div style="border: 1px solid black; padding: 2px; display: inline-block;">DISP</div> key to return to the measurement display.	<div style="border: 1px solid black; padding: 5px; width: fit-content;">           ILLUMINATION            O N         </div>

## 7.17 Turning the chart illumination lamp on/off (option)

### Explanation

If the unit is provided with recording paper illumination (option), the lamp can be turned on and off by keyboard operation.

Turning off chart illumination lamp		
Key actuation	Explanation	Display
 	Press the  key several times to display "ILLUMINATION".	
 	Use the  key to make it "OFF".	
 	When the  key is pressed, the lamp is turned off. Display moves to the next parameter.	

## 8. MAINTENANCE - INSPECTION

Carry out periodic maintenance and inspection to keep the equipment in good condition.

Pay particular attention to the items noted below and make replacement with spares when necessary.

Inspection, Maintenance Items	Procedure
Recording head replacement:	<p>The recording head is a consumable part.</p> <p>If there is no more ink, replace the head with a new one.</p> <p>Ink consumption varies depending on the contents of records, but writing for about 6 months is possible for 6 points continuous recording at a recording paper speed of 20mm/h.</p> <p>If the ink dry-up warning display “Ink end” appears in the display section, refer to ‘5.2 Recording head installation’ and replace the recording head with a new head.</p> <p>To get spares, quote the following type.</p> <p style="text-align: center;">Recording head type:PHZH1002</p> <p>Recording is possible for a little while after the warning display “Ink end” appears. (There is about 10% of the total amount of ink remaining)</p>
Inspection of the recording head	<p>In normal conditions, there is no need for preventive maintenance of the recording head.</p> <p>However, in a high-temperature or very dusty environment, periodically wiping the nozzle surface prevents accumulation of dust and ink and so prevents nozzle blockage that is liable to be caused by such accumulation.</p> <p>To absorb ink, use the supplied “Ink blotting cloth”</p> <p><b>If the recording head is left unused for a long time without using the cap, ink may not be absorbed when the blotting cloth is attached to the nozzle of the recording head. In such a case, wet the blotting cloth with water and attach it to the nozzle for several 10 seconds until the 4 colors (red, blue, yellow, black) are absorbed sufficiently.</b></p>
Recording paper replacement	<p>In continuous operation at a paper feed speed of 20mm/h, the recording paper lasts about 31 days.</p> <p>When there is only a small amount of recording paper left, red characters are printed on the right-hand edge of the paper. When this happens, refer to Section 5.1 and replace the recording paper.</p> <p>When there is no more recording paper, recording operations stop and ‘Chart end’ is displayed in the display section.</p> <p>To get supplementary paper, quote the following type.</p> <p style="text-align: center;">Recording paper type:PEX00DL1-5000B</p>



Inspection, Maintenance Items	Procedure
Cleaning of traveling shaft	<p>Wipe off dust, if found, on the shaft for traveling the record head horizontally with clean cloth. Otherwise accurate recording may not be made.</p> <p><b>Do not lubricate the traveling shaft. Lubricating can cause inaccurate re-cording.</b></p>
Transfer of record head	<ul style="list-style-type: none"> <li>• Do not transfer the record head taken out of the aluminum bag alone. If the transfer is unavoidable, <b>make sure to tighten the cap</b> and place the record head in a cardboard box with sufficient cushioning materials to reduce vibration and impact.</li> <li>• <b>Make sure to tighten the cap</b> when transferring the record head in a state installed in a recorder main unit.</li> </ul>

## Replacing the battery

- When the sign "Battery End" appears on the indicator, be sure to replace the battery as soon as possible. [It should be noted that the set data may be erased if the power is turned OFF after the sign "Battery End" has been displayed for a long time.

In such a case, print the parameter list before replacing the battery for printing and storage of the set data so that the same data can be set once again.]

- Turn OFF the power.
- Open the front door and replace the battery using the following procedures.
- The battery unit requires a special Fuji's battery to replace. Please order it with following part number. Part number of battery unit: TK7G8473P1
- When battery is replaced, following battery for retaining setting is needed to maintain the setting value. Please order the following battery to us prior to replacement. Be sure to use the correct battery. Part number of battery for retaining setting: TK7E2340C1

Step 1

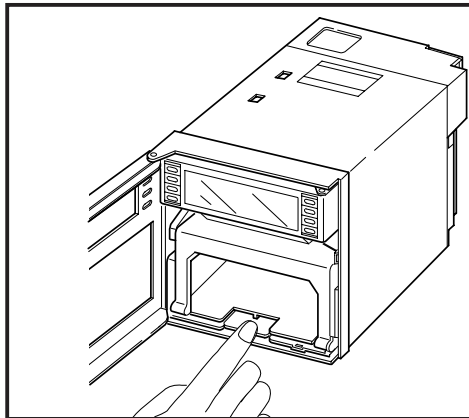

Open the front door and press down the paper feed unit drawout lever.  
The paper feed unit will be drawn out.

Step 2

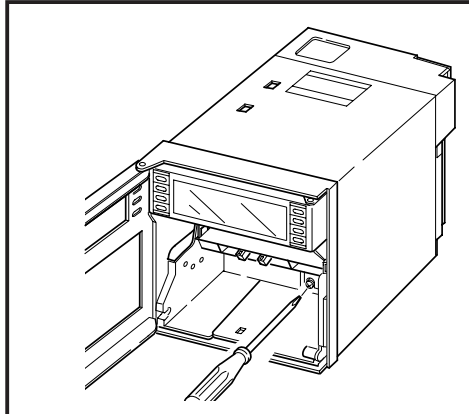

Loosen lock screw (M4), by using a (+) driver.

Step 3

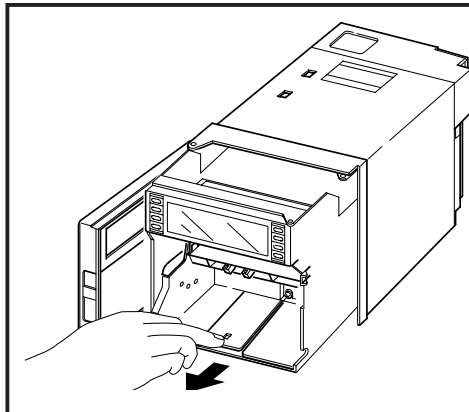

Hold the side or bottom of the main unit and pull it forcedly until it is removed.

Step 4

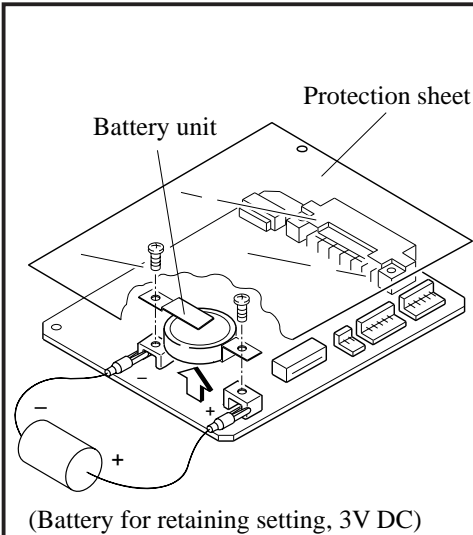

Please order the battery for retaining setting with following part number to us prior to replacement. Be sure to use the correct battery.

Part number of battery for retaining setting: TK7E2340C1

(1) Flip the protection sheet attached to the top of the unit and hold it by hand.

Note) Do not remove the protection sheet completely.

(2) Please make sure the voltage of the battery for retaining setting is 3V DC or more. Then be sure to connect the positive electrode of the battery for retaining setting to the positive electrode of battery unit and negative electrode of the battery for retaining setting to the negative electrode of the battery unit installed on the terminal as shown in the left figure. and then remove the battery unit.

Note) In case the battery unit is removed before connecting the battery for retaining setting, all the setting will be lost and cannot be restored. Be sure to connect the battery for retaining setting first and then remove the battery unit.

(3) Remove the 2 screws that fasten the battery unit, and then remove the battery unit.

(4) Mount a new battery unit with screws (2 places). Make sure that the battery polarity is correct. In case the battery is installed with improper polarity, battery life will be shortened significantly.

(5) Disconnect the battery for retaining setting power connected in (2).

(6) The battery unit is of a special type and should be ordered specifying the following Part No.  
Part No. of battery unit: TK7G8473P1

Step 5

- After replacing the battery, set the recorder as it was. Be sure that the lock screw inside the recorder is firmly tightened.
- Set the paper feed unit as it was.
- Make sure that the sign "Battery End" on the indicator has disappeared.

Reference	Battery life
-----------	--------------

- The battery life is about 10 years at normal temperature.

## 9. APPLICATION FUNCTIONS

The following operations are available by the application functions in this Chapter.

- ① Print/record adjustment
- ② Adjustment of zero/span of analog trend record position
- ③ Setting of alarm latch function and print of integrated total value
- ④ Shift of measured value
- ⑤ Preparation of unit
- ⑥ Record error external output

Any adjustment can be processed on software for easy operation.

### 9.1 Adjustment of backlash

#### Explanation

Make adjustment when character kink and/or disturbance of record (round trip difference) occur. Connection of calibration equipment is not required for this adjustment.

#### Operation

- ① Stop the recording operation by pressing the **REC** key.
- ② Have parameter "INK ALARM CLEAR" displayed by pressing the **SEL** key.
- ③ Press the **SEL** key while the **FEED** key is kept pressed. The parameter for calibration will be displayed.

```
ADJUST HEAD
BACKLASH=5
```

Adjustment of print/record is displayed.  
Normally, 4, 5 or 6 is displayed.

#### <Example>

Have BACKLASH=6 displayed by pressing the **^** key.

Press the **ENT** key.

Return to the display mode by pressing the **DISPLAY** key.

(See section 6.3 for the test pattern printing method.)

If improvement of character kink is insufficient, repeat the operation of step ② and subsequent and increase the value of BACKLASH= .

If character kink has become worse, repeat the operation of step ② and subsequent and decrease the value of BACKLASH= .

Obtain the best condition of repeating

#### Note:

The value of BACKLASH can be changed from 0 to 9, but the maximum value changes with setting of zero/span of head. The standard value is 5. In general, normal print and record are made between 4 and 6.

## 9.2 Zero/span adjustment of analog trend recording position

### Explanation

The zero point (0% point) and span point (100% point) for analog trend records on the recording paper and adjusted. There is no need to connect a calibration instrument for this adjustment.

### Procedure

- ① Press the **REC** key to stop recording operation.
- ② Press the **SEL** key to bring up a display of the parameter 'Ink alarm clear'.
- ③ Press the SEL key while holding the **FEED** key depressed. This effects a shift to a display of parameters for calibration. The first display shows manufacture's test parameters, ignore this and press the **SEL** key.

ADJUST HEAD  
BACKLASH=3

An analog trend record zero span calibration display appears.

↓ **SEL**

HEAD ZERO/SPAN?  
NO

Use the **^**, **v** keys to indicate whether calibration is required or not.

Calibration  
not required  
(NO)

**SEL** key

Calibration  
required  
(YES)

To alarm latch  
ON/OFF

**ENT** Press the ENT key.

The recording head moves and records a black straight line at the zero point (0% point). If the place where this line is recorded is not at the 0% point of the recording paper, make an adjustment.  
Pressing the **^** key moves the recording point to the right.  
Pressing the **v** key moves the recording point to the left.

After bringing the recording point to the zero point, press the **ENT** key. ...This completes zero point calibration.

The recording head moves to the 100% side and records a black straight line at the span point (100% point). If the place where this line is recorded is not at the 100% point of the recording paper, make an adjustment.  
Pressing the **^** key moves the recording point to the right.  
Pressing the **v** key moves the recording point to the left.

After bringing the recording point to the span point, press the **ENT** key. The recording head moves and recording stops. ... End of span point calibration

\* You can switch to the display mode by pressing the **DISPLAY** key.

Note: When list print is requested during calibration of zero/span of head, "message print" or "list print" is displayed. During zero/span calibration, do not request list print.

## 9.3 Setting of alarm latch and integrated total value print-out

### (1) Setting of alarm latch

#### Explanation

- Alarm display output is retained even when alarm is released.
- Latch release and alarm release are performed when the alarm latch function is set to OFF or DI3 (terminal 13 - 33) is inputted.
- When alarm latch function is ON, a list of instantaneous values is not printed at ON of DI3

### (2) Setting of integrated total value

#### Explanation

- When integrated total value is ON, only the total value is printed during printing an integrated list.
- Example of print

Integrated list '95-04-03

	ch1	ch2	ch3	ch4	ch5	ch6
Total	5.000	5.000	5.000	5.000	5.000	5.000

#### Operation

Example: Procedure to turn ON alarm latch function and integrated total value print.

- ① Press **SEL** key to display parameter "Ink Alarm Clear".
- ② Press the **SEL** key while pressing the **FEED** key.
- ③ Press the **SEL** key to display "Alarm latch" on screen.

ALARM LATCH OFF  
TOTAL PRINT OFF

- ④ Press **^** key to set alarm latch from OFF to ON.
- ⑤ Press **ENT** key for setting.
- ⑥ Press **^** key to set total print from OFF to ON.
- ⑦ Press **ENT** key to complete setting.

\* By pressing **DISPLAY** key, the unit is set in display mode.

## 9.4 Setting of PV shift

### (1) PV shift function

- Measured value can be calculated by PV shift constant for record and display.
- PV shift calculation is used for setting slope and shift values.

A conversion graph obtained from shift and slope calculation is shown below.

- Shift calculation

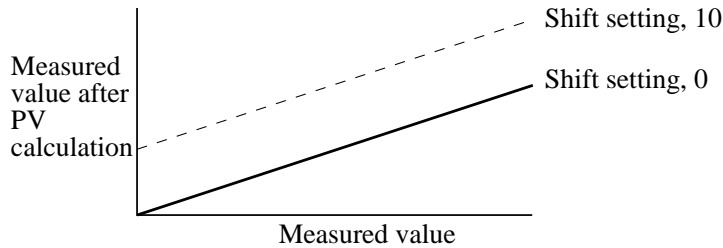

- Gain calculation

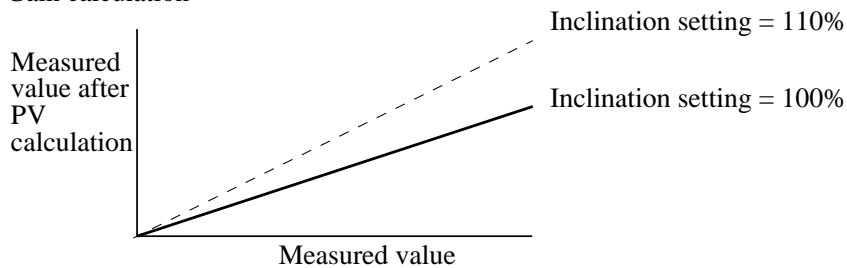

- Details of PV shift calculation is as follows.

$$P' = A P + B$$

$P'$  : Measured value after PV calculation

$P$  : Measured value

$A$  : Gain (0.01 to 327.67%)

$B$  : Shift value (-32767 to 32767 industrial value, decimal point depending on type of input)

- \* Measured value after PV shift calculation, is limited to be set within the record setting range of the type of input set in each channel.
- When the type of input is changed or scaling function is set to ON/OFF, the PV shift set value of that channel is cleared.
- PV shift set value cannot be copied even when the set value is copied using the copy function being set.

<Set panel>

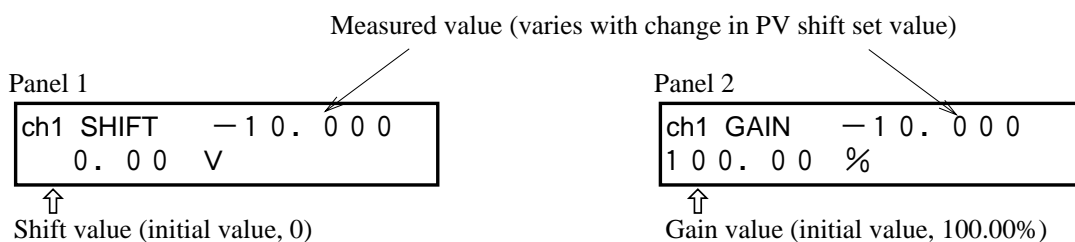

- Do not use PV shift during logarithmic value operation setting.

## 9.5 User definable unit

### Explanation

It is possible to create arbitrary units with numerals, alphabets, etc., which can be defined up to 7 digits for registration of 12 different units.

### Operation

Example) Creation of unit kgf/cm<sup>2</sup> to Code A=2, B=10

- ① Press the **SEL** key to display parameter "Ink Alarm Clear".
- ② Press the **SEL** key while pressing the **FEED** key to display calibration parameter.
- ③ Press the **SEL** key to display "Unit" image.

Unit : A = 1    B = 10  
\_ \_ \_ \_ \_

- ④ Using the **^** and **v** keys, specify the unit register code A=2 and press the **ENT** key.

(A=1-12 can be specified. B=10 is fixed.)

- ⑤ The first digit of unit flashes. Specify "K" with the **^** and **v** keys and press the **ENT** key.
- ⑥ Next, the second digit flashes. Specify the unit in the same manner.

Unit : A = 2    B = 10  
kgf /cm<sup>2</sup>

- ⑦ All the digits flash one by one in order, and the numeral of A=**2** flashes to indicate that the unit has been specified.

\* By pressing the **DISPLAY** key, the recorder is changed over to display mode.



## 9.6 Setting of record error external output

### Explanation

- Relay output is given to external device at occurrence of chart end, battery end, carriage failure of ink end.
- When output is set to the same relay as the relay No. designated by "Alarm Setting", output is given at occurrence of alarm or record error.

### Explanation

- ① Output is given to relay 6 at ink end.

```
Chart end
OFF          ALM 0
```

- ② Press  and  keys to display ink end.

```
Ink end
OFF          ALM 0
```

- ③ Press  key to set alarm from OFF to ON.

- ④ Press  key to set ALM 6.

```
Ink end
ON          ALM 6
```

- ⑤ Press  key to complete setting.

## 9.7 Calibration of measured value

### Explanation

Calibrate measured values for inputs.

Annual calibration is recommended to maintain the measurement accuracy.

(1) Necessary equipment

You need a calibration equipment with required accuracy for calibration of this unit.

(2) Calibration equipments

- Standard DC current-voltage generator :  $\pm 0.01\%$  of input span or less

- Adjustable dial resistor :  $\pm 0.03\%$  of the set value or less

- Install wiring for an input and perform warm-up of each equipment (Warm-up for a recorder: 30min or longer)

Adjustment is performed automatically using the software by adding an input signal for calibration.

Add an input signal for calibration to the target channel.

Note) If a wrong input signal for calibration is added, calibration is performed in an improper state.

## Operation

- ① Press **REC** key to stop record operation.
- ② Press **SEL** key to display parameter "Ink Alarm Clear".
- ③ Press **SEL** key while pressing **FEED** key. The unit will shift to calibration parameter display.

```

A D J U S T   H E A D
B A C K L A S H = 3
    
```

Print/record adjustment display

Press **SEL** key

```

H E A D   Z E R O / S P A N ?
N O
    
```

Analog trend record zero/span calibration display

Press **SEL** key

```

A L A R M   L A T C H   O F F
T O T A L   P R I N T   O F F
    
```

Press **SEL** key while pressing **FEED** key.

```

A D J U S T   C h □
Z E R O     S P A N
    
```

Measured value zero/span calibration display

NOTE) To stop measured value zero/span calibration for a brief time, press **DISPLAY** key. Do not press **ENT** key (Unit is set in display mode).

- ④ Press **^**, **v** keys to select channels to be calibrated.  
 C h 1 ~ C h 6 = DC voltage, input, resistance bulb input, thermocouple input  
 C h 7 ~ C h 8 = Used for maker's test. Do not use for operation

Press **ENT** key

- ⑤ \* 1 Apply 0% input

\* 1

0% Calibration input signal is as follows.  
 Voltage input : 0 mV or 0V  
 Thermocouple input: 0 mV  
 Resistance bulb input (Pt, JPt): 100 Ω

Press **ENT** key. Zero calibration is automatically started.  
 (Press ENT key after applying 0% input in \*1)

Zero calibration end... OK is displayed. The unit is set in span calibration mode.

- ⑥ \* 2 Apply 100% input

\* 2

100% calibration input signal is as follows.  
 ±50 mV :50 mV  
 ±500 mV :500 mV  
 ±5V :5V  
 ±50V :50V  
 ±Thermocouple: 50 mV (room temperature compensation is not required)  
 Resistance bulb (Pt, JPt: 324.26 Ω)

Press **ENT** key. Span calibration is automatically started.  
 (Press ENT key after applying 100% input in \*2)

Span calibration end... OK is displayed. When adjusting other channels, press **^** and **v** keys for setting channels.

- ⑦ Press **DISPLAY** key. The unit is set in display mode and calibration is completed.

Note: When list print or message print is requested during input adjustment, function keys other than **FEED** key may not become effective. Input adjustment should be made when list or message print is not requested.

## 9.8 Change of record color

### Explanation

- Record color for each channel can be changed.

### Operation

- Display calibration panel using the operation in Item 9.5.

```
ADJUST Ch□  
ZERO SPAN
```

Press **[SEL]** key to display record color change panel.

```
Ch□  
COLOR = ORANGE
```

Press **[^]** and **[v]** keys to select channel to be changed, then press **[ENT]** key. Once again, press

```
Ch□  
COLOR = GREEN
```

**[^]** and **[v]** keys to select record color, then press **[ENT]** key to complete the setting operation.

## 9.9 Language selection

### Explanation

The characters for display and print-out with this machine may be selected out of the following three language.

English

German

French

### Operation

```
LANGUAGE  
ENGLISH
```

The display is switched when the **[^]** key or the **[v]** key is pressed while the message shown on the left is display.

Select a display language and then press **[ENT]** key. display and print-out in the selected language will be made.

## 10. TROUBLESHOOTING

If the unit fails to operate properly, check the operating conditions and take necessary steps referring to the following.

If any uncontrollable problem arises, contact your dealer or your nearest Fuji service station.

State	Points to check	Action to take
Does not work at all	(1) Is the power supply terminal connection correct?	Connect correctly
	(2) Is power being supplied properly?	Effect proper supply
Keys do not work	(1) Have you caused data print-out by pressing the <b>LIST</b> key?	Wait until the end of print-out. Press the <b>LIST</b> key to stop the print-out
	(2) Is a parameter list, scale print-out, test pattern, daily report list or integration list print-out in progress? "The following keys are inoperative during data print-out and list print-out. See section 2) <b>RECORD</b> <b>DISPLAY</b> <b>SELECT</b>	
	(3) Is Chart end, Carriage alarm being displayed?  * The <b>SELECT</b> key is inoperative when the above state displays are produced.	Eliminate the displayed state.  ( Put recording paper in, Check the carrier fault. )
The record swings over to the 0% side or the 100% side	(1) Is the input signal wiring correct?	Correct the wiring
	(2) Is the record range correct ( $\ominus$ , $\oplus$ sides)?	Set a correct range
	(3) Has a thermocouple or resistance bulb wire broken? (If wire breakage occurs, there is a burn-out display and a swing over to the 100% side.) Refer to Section 9.2 and adjust.	Replace the thermocouple or resistance bulb.
The record zero/span point is out of position	Refer to Section 9.2 and adjust. Always make the adjustment of Section 9.2 after replacing the recording head.	
There are large errors	Do the input signals match the specification? (Signal source resistance, etc.)	Bring them to the proper specification.
The data display goes to 'Over', 'Under' or 'Error'	(1) The specification of the input signal setting pins and the input signal type specification made using the front panel do not agree	Adjust so that they agree
	Is there supply of excessively large or excessively small input?	Effect supply of correct input
The display goes to 'Carriage Alarm'.	Refer to section 6.11	

State	Points to check	Action to take
<p>Ink does not come out even though there is no 'Ink out' display or the ink colours are blurred.</p> <p>Characters are deformed.</p> <p>The record colours are wrong.</p>	<p>Carefully note the points described on page 5-8 in relation to the recording head (i.e., the notes on storage and avoiding imposition of vibration or impact). If ink does not flow properly, take the action described on the right. If this has no effect, the recording head must be replaced.</p>	<p>Refer to "Note 6: If the ink is not sprayed" on page 5-8. When the working environment is 15°C or less, perform print-out of "record" or "test pattern" after a period of several minutes has elapsed since the recording head was mounted. (The recording head has a built-in heater.)</p>
<p>Ink does not flow.</p>	<p>Is the head inserted into the carrier sufficiently?</p>	<p>Push the head on properly. (Refer to Step 6 of section 5.2.)</p>
<p>Trend record or characters turn to double-line (round trip difference appears) or characters are disordered.</p>	<ol style="list-style-type: none"> <li>1) Wipe the carriage drive shaft with dry, clean cloth.</li> <li>2) When this procedure 1) is not effective, follow Section 9.1 Adjustment of backlash</li> </ol>	

# 11. EXAMPLES OF RECORDS AND PRINT-OUTS

Note: If the chart speed is  $\geq 401$  mm/h for continuous recording or  $\geq 51$  mm/h for dot recording, there are no periodic print-outs, scale print-outs (but print-out can be made manually; see Section 7.11) message print-out, alarm print-out, burn-out print-outs or ink end print-outs.

## 11.1 Periodic print-outs, scale print-outs

- ① Periodic print-outs: Time lines, dates, times, the chart speed and the measured values for each channel are automatically printed out at set intervals in correspondence to the chart speed.  
(There is print-out only if periodic print-out is set to "ON", See Section 7.6.)
- ② Scale print-outs: Scale lines, figures and units are automatically printed out at set intervals in correspondence to the chart speed.(There is print-out only if scale print-out is set to "ON". See Section 7.6.)

Example of 6 continuous records

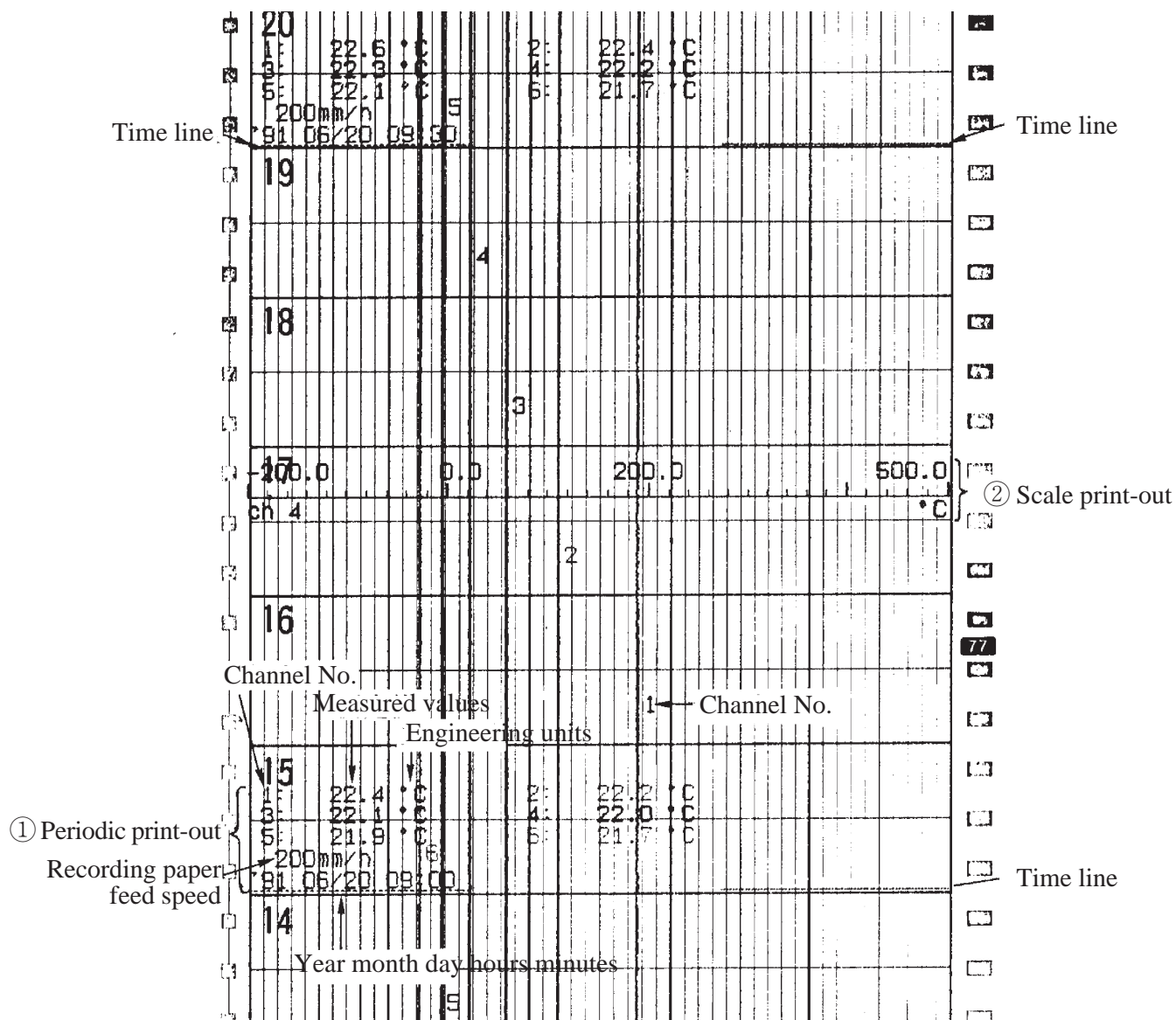

## 11.2 Digital print-out (Instantaneous value)

Pressing the LIST key effects immediate print-out of current values. (See Section 6.4.)

Date, time	*93 06/20 23:39					
	1:	27.6	°C	2:	27.9	°C
	3:	27.8	°C	4:	27.4	°C
	5:	26.9	°C	6:	26.3	°C
Channel No.	Engineering units					
Measured value						

Note) On a channel in which skip has been set, the measured value is printed with a mark "-" (horizontal line) and industrial unit is not printed.

## 11.3 Parameter list print-out

The specified contents of parameters are all printed out together on the recording paper.

(See Section 7.11.)

When you start to use recorder, It is recommended to print out parameter list and retain the parameter in order to find out the setting contents later.

	*93 06/22 16:38									
	TREND MODE									
Specified content of recording mode	MAIN CHART SPEED		300 mm/h							
	SUB CHART SPEED		200 mm/h							
	LOGGING INTERVAL		10 min							
	REC.FORMAT		Zone							
	PERIODIC PU LIST		On							
	SCALE PRINT		On							
	10									
Specified content for input range	ch	TAG	INPUT TYPE	MEAS RANGE	SCALING RANGE	REC. RANGE	UNIT			
	1	CHANNEL1	SU	-5.000 5.000	-5.00 5.00	50.00 -50.00	μ			
	2	Channel12	SU	-	-	0.000 5.000	V			
	3	CHANNEL3	K	-	-	200.0	°C			
	4	Channel14	SU	1.000 5.000	1.00 300.00	2.00 20.00	kVar			
	8	Channel15	SU	-5.500 5.500	0.0 1000.0	500.0	Nm <sup>3</sup> /h			
	5	channel16	SU	-	-	-5.000 5.000	V			
		FILTEE		SUBT.						
Filter Difference calculation	ch	(s)	ROOT	ch						
	1	0	Off	0						
	2	3	Off	1						
	3	0	Off	0						
	4	200	On	0						
	5	5	Off	0						
	8	0	Off	0						
Specified content for alarms	ALARM									
	ch	LL	NO	L	NO	H	NO	HH	NO	
	1	-		-		0.85	0	0.50	0	
	ch	RL	NO	RH	NO					
	1	-		-						
	6	0.015	0	0.020	1					

## 11.4 Test pattern

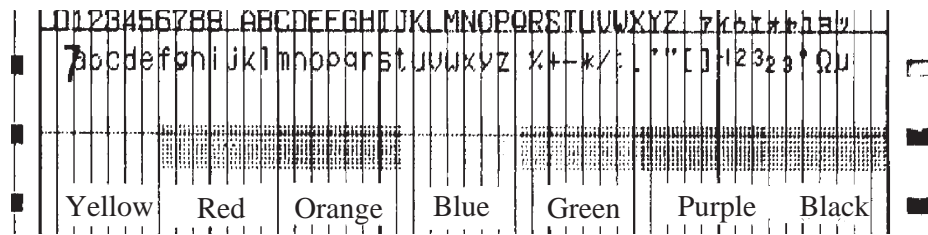

## 11.5 Scale print-outs

The scales of specified channels are printed. (See Section 7.11.)

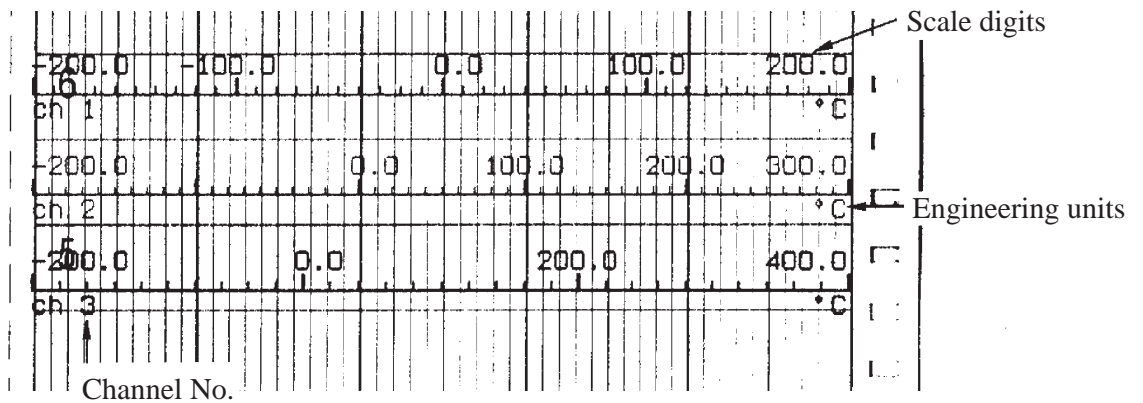



## 11.6 Daily report print-out

This consists of print-out of the data for a max. 24-hour period (max. 24 data items in hourly units) for specified channels.

The maximum, minimum and average values of the instantaneous values on the every full hour from the daily report start time to the daily report end time and printed out. (For setting, refer to Section 7.12.)

report list		01 06/20 23:13			Channel No.
Month day	TAG	ch 1	ch 2	ch 3	TAG No.
Time	Units	°C	°C	°C	Working units
06/20 00:00		0.0	0.0	0.0	
06/20 01:00		22.3	22.2	-230.0	
06/20 02:00		26.0	25.5	25.3	
06/20 03:00					
06/20 04:00		24.4	24.8	25.2	
06/20 05:00		35.9	35.4	34.9	
06/20 06:00		33.5	33.3	33.3	
06/20 07:00		21.2	21.0	21.1	
06/20 08:00		30.9	30.5	30.5	
06/20 09:00		22.4	22.2	22.1	Instantaneous values In each channel
06/20 10:00		21.1	20.8	20.7	
06/20 11:00		199.9	218.8	190.1	
06/20 12:00		33.7	37.9	76.1	
06/20 13:00		345.3	369.1	333.1	
06/20 14:00		222.1	228.9	121.3	
06/20 15:00		25.2	25.4	24.2	
06/20 16:00		25.2	25.0	25.0	
06/20 17:00		25.5	25.2	25.2	
06/20 18:00		25.8	25.6	25.5	
06/20 19:00		25.7	25.5	25.5	
06/20 20:00		26.3	26.0	26.0	
06/20 21:00		26.3	26.1	26.1	
06/20 22:00		26.4	26.2	26.1	
	MAX	10:08	10:08	10:08	Times of occurrence of maximum value
		1400.0	1400.0	1400.0	Maximum value
	MIN	01:59	01:59	01:59	Time of occurrence of minimum value
		-230.0	-230.0	-230.0	Minimum value
	Average	59.2	61.6	43.2	Average values of data in list

Note 1) In the event of input error, the following items are printed.

- \* Under-range: Minimum value of recording range
- \* Over-range: Maximum value of recording range
- \* Error: Maximum value of recording range
- \* Burnout: "-" (horizontal bar)

## 11.7 Data sum list print-out

This consists of print-out of the data for a max. 24-hour period (max. 24 data items in hourly units) for specified channels.

The integrated values for each hour and the totals of the integrated values from the integration start time to end time are printed out. (For setting, refer to Section 7.13.)

Integration list				ch 1	ch 2	ch 3	
7	TAG	Units	°C	°C	°C		Channel No.
06/20	00:00		0.0	0.0	0.0		TAG No.
06/20	01:00		-0.7	-1.8	-3.1		Working units
06/20	02:00		18.5	18.2	16.3		Integration values for 1 hour from 01.00 to 0.200
06/20	03:00		0.0	0.0	0.0		
06/20	04:00		27.2	26.9	26.8		
06/20	05:00		381.7	378.1	377.2		
06/20	06:00		16.2	16.0	16.0		
06/20	07:00		23.5	23.3	23.3		
06/20	08:00		29.2	28.9	28.9		
06/20	09:00		27.5	27.3	27.2		
06/20	10:00		23.3	23.2	23.1		Hourly integration values for each channel
06/20	11:00		159.3	152.8	164.8		
06/20	12:00		397.8	418.3	393.9		
06/20	13:00		260.4	244.2	231.1		
06/20	14:00		409.5	408.9	383.6		
06/20	15:00		59.9	63.7	34.8		
06/20	16:00		25.0	24.8	24.6		
06/20	17:00		25.3	25.0	25.1		
06/20	18:00		25.5	25.4	25.3		
06/20	19:00		25.7	25.5	25.4		
06/20	20:00		25.9	25.7	25.7		
06/20	21:00		25.3	25.0	25.0		
06/20	22:00		25.3	25.2	25.1		
06/20	23:00		26.4	25.1	25.1		
			2039.7	2042.7	1948.2		Totals of data in list

Note 1) In the event of input error, the following items are printed.

- \* Under-range: Minimum value of recording range
- \* Over-range: Maximum value of recording range
- \* Error: Maximum value of recording range
- \* Burnout: 0

## 11.8 Message print (manual print)

Specified message is printed. (Refer to Section 7.10)

NO. 1 bulb open

Recording start

D11 ON 10:09

## 11.9 Logging

The instantaneous values of the various channels are printed out at set intervals of time. (See Section 7.6 ①.)

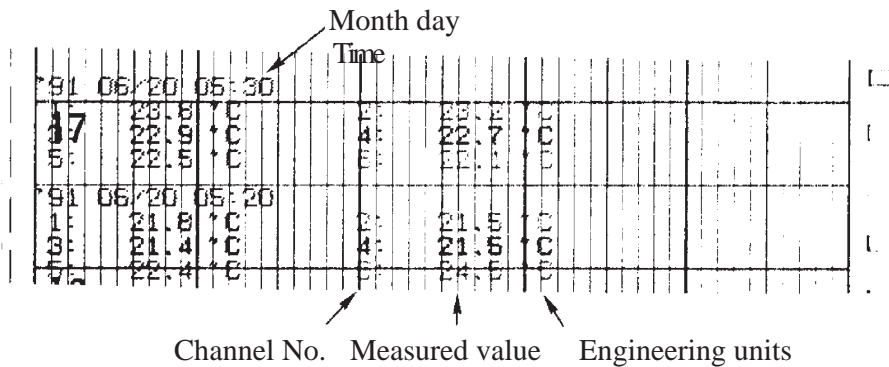

## 11.10 Alarm print-outs

When an alarm is detected and canceled, the time of detection and cancellation, the channel No., the type of alarm and the relay No. are printed on the right-hand side of the recording paper.

On detection: print-out colour red, on cancellation: print-out colour: black

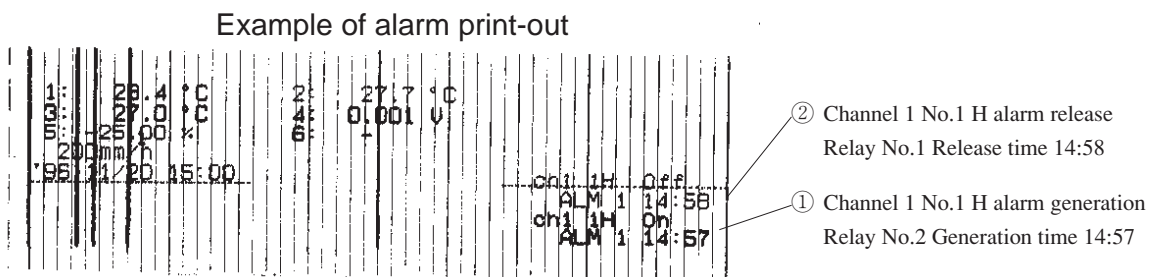

## 11.11 Burn-out print-out

If a burn-out occurs, the channel No. burn-out and time of occurrence are printed in red at the right-hand edge of the recording paper.

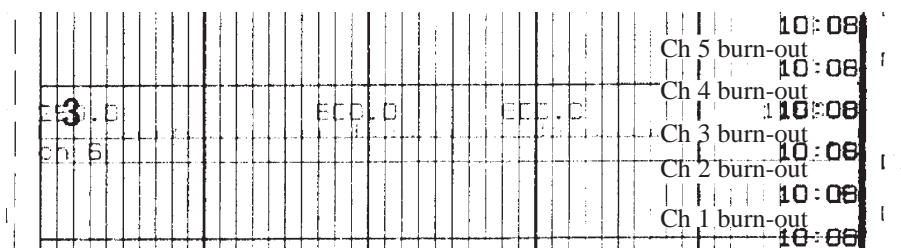

## 11.12 Ink dry-up warning print-out

When only about 10% or less of an ink remains, 'Ink Empty' is printed out in the colour of this ink on the right-hand side of the recording paper.

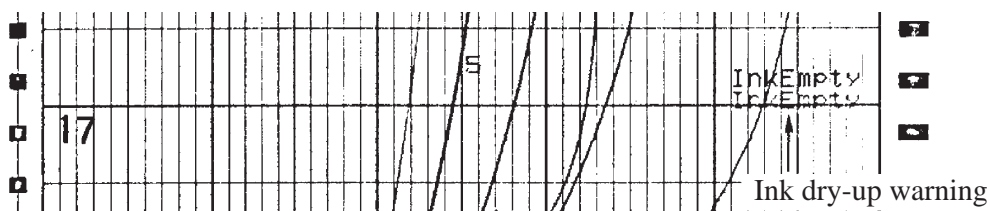

### 11.13 Record start mark

When recording starts, a record start mark is printed at the left-hand edge of the recording paper (outside the 0% scale line).

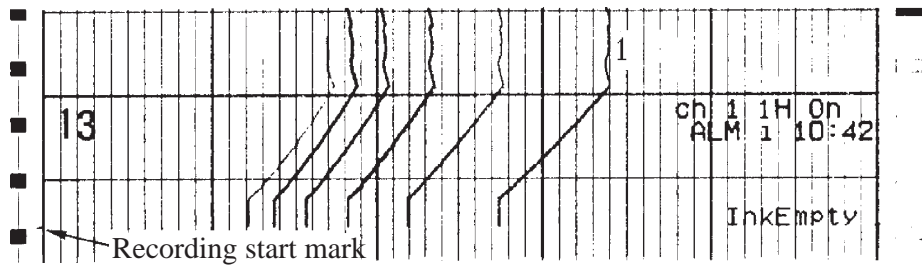

### 11.14 Chart speed change mark

If a change in the speed of the recording paper is ordered, a chart speed change mark is printed at the left-hand edge of the recording paper (inside the 0% scale line).

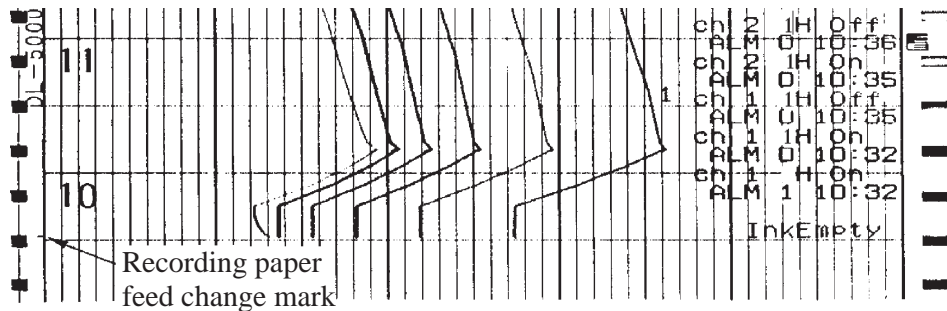

### 11.15 Auto-range change mark

If the auto-range function changes the range during recording, a change mark is printed at the right-hand edge of the recording paper.

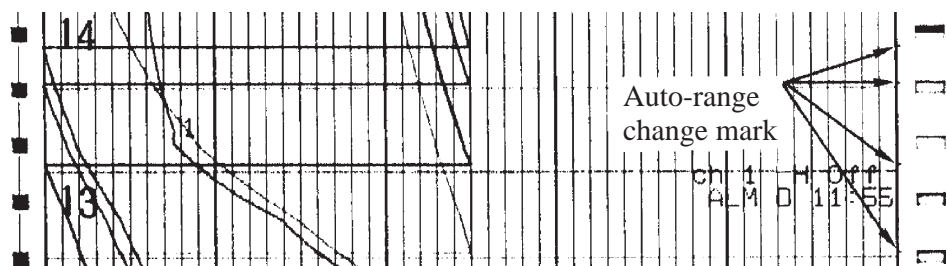

## 12. SPECIFICATION

### Input Section

Number of input points: 5 classes: 1, 2, 3 or 6 continuous records and 6 dot record

Input signals: Thermocouple input: B, R, S, K, E, J, T, N, W, L, U, PN  
 Resistance bulb input: Pt100, JPt100 (JPt means special input in Japanese)  
 DC voltage input: 50 mV range, 500 mV range, 5V range, 50V range  
 Direct current input: 4 to 20 mA DC. 10 to 50 mA DC  
 (Note: Terminal section to be fitted with separately sold 10Ω shunt resistor and range to be made 500 mV.)  
 Maximum allowable input voltage:  
 Thermocouples, resistance bulbs, DC voltage (50 mV, 500 mV range): ±10V  
 Direct current input (5V, 50V range): ±100V

Setting and changing of input signals: For each channel, any combination of thermocouples, resistance bulbs and DC voltage (50 mV, 500 mV, 5V, 50V ranges) can be made or altered by changing the setting pins inside the instrument.

Record range specification: Can be made any range within the input range from the keyboard.

Burn-out function: If a thermocouple of resistance bulb input lead breaks, the record will go to full scale.

### Reference ranges

Type		Input range	Input range
Thermocouple	B	400 to 1760°C	752 to 3200°F
	R	0 to 1760°C	32 to 3200°F
	S	0 to 1760°C	32 to 3200°F
	K	-200 to 1370°C	-328 to 2498°F
	E	-200 to 800°C	-328 to 1472°F
	J	-200 to 1100°C	-328 to 2012°F
	T	-200 to 400°C	-328 to 752°F
	N	0 to 1300°C	32 to 2372°F
	W	0 to 1760°C	32 to 3200°F
	L	-200 to 900°C	-328 to 1652°F
	U	-200 to 400°C	-328 to 752°F
	P N	0 to 1300°C	32 to 2372°F
Resistance bulb	JPt100	-200 to 600°C	-328 to 1112°F
	Pt100	-200 to 600°C	-328 to 1112°F
DC voltage		- 50 to + 50mV -500 to +500mV - 5 to + 5V - 50 to + 50V	Scaling in the range -32767 to 32767 is possible. (Decimal point may located where required.)

Note: N : NICOSIL-NISIL (IEC584)  
 W : +Foot 5% Re, -Foot 26% Re.W (Hoskins Mfg. Co., U.S.A)  
 L : +Foot Fe, -Foot Cu. Ni alloy (DIN43710)  
 U : +Foot Cu, -Foot Cu. Ni alloy (DIN43710)  
 PN : Platinum  
 JPt100 : JIS C 1604, 1606 (old JIS Pt100)  
 Pt100 : JIS C 1604, 1606, DIN IEC 751

Accuracy resolution: Performance at standard conditions (23±2°C, 65±10% RH, power supply voltage and frequency fluctuation within ±1%, warm-up time ≥30 minutes, vertical mounting, environment with no adverse effects of external noise, etc.)

Type of input		Indication (digital display)		Record	
		Accuracy	Resolution	Accuracy	Resolution
Thermocouple	B	± (0.15% + 1 digit) (Does not include reference junction compensation error.)	0.1°C	Indication precision ± (0.25% record span)	0.1mm
	R		0.1°C		
	S		0.1°C		
	K		0.1°C		
	E		0.1°C		
	J		0.1°C		
	T		0.1°C		
	N		0.1°C		
	W		0.1°C		
	L		0.1°C		
U	0.1°C				
P N	0.1°C				
Resistance bulb	JPt100 Pt100	± (0.15% + 1 digit)	0.1°C		
DC voltage	- 50 to + 50mV	± (0.15% + 1 digit)	10 μV		
	-500 to +500mV		100 μV		
	- 5 to + 5V		1mV		
	- 50 to + 50V		10mV		

Note 1) The rating of indication accuracy is shown in % within the input span.

Note 2) Indication accuracy at 400 to 600°C of B-thermocouple is ± (0.36%+1 digit).

Note 3) Indication accuracy at -200 to -100°C of K, E, J, T, L, U-thermocouple is ± (0.36%+1 digit).

## Recording section

Recording system:	Ink jet system, 6 colours
Effective recording width:	100 mm
Recording colours:	1st, (orange), 2nd, (green), 3rd, (purple), 4th, (red), 5th, (black), 6th, (blue)
Chart paper:	folding, total length 15.08m
Chart speed:	5 to 400 mm/h continuous record (400 mm/h is the general standard) 401 to 1500 mm/h discontinuous records Dot record type: 5 to 1500 mm/h All settable in 1 mm/h steps.
Speed setting method:	Set from keyboard.
Sample time:	Dot records ... 30 seconds/for all channels. Continuous records ... Depends on chart speed. Calculation formula ... Recording cycle (seconds) = 400/[chart speed (mm/h)] But is not faster than 2 seconds.
Measurement period:	1 - 3 input points: 160 ms 6 input points: 320 ms
Ink life (depends on conditions):	approximately 6 months for 6 point continuous records at a recording paper feed speed of 20 mm/h

---

## Display section

- Display system: Fluorescent display (blue-green), 20 characters × 2 lines
- Display characters: 5 × 7 dots, character height 4.16 mm, width 2.25 mm
- Display contents:
- (1) Measured values: Temperature ... to 1st decimal place  
Voltage ... 6 places (including symbols decimal point)
  - (2) Channel Nos.: 2 places (1 - 6)
  - (3) Engineering units: Maximum 7 places  
(°C, °F, %, kg/cm<sup>2</sup>, mmH<sub>2</sub>O, ppm, m<sup>3</sup>/h, etc.)
  - (4) Time: Year, month, day, hours, minutes
  - (5) Status display: Under recording, under digital data printing, under list printing, chart end, battery alarm, alarm, ink run-out alarm, burn-out, carriage failure
  - (6) Commands for setting parameters: Displayed as alphanumeric characters

## Printing section

- Printing system: Ink jet system, 6 colours
- Periodic printing: Instantaneous values, units, date, time, time lines, chart speed
- Scale print: Scale value, scale line, Channel No., TAG No., unit
- Message printing: Any message with 10 kinds of 16 characters
- List printing:
- (1) Instantaneous value lists (date, time, channel Nos., instantaneous values, units)
  - (2) Set value lists (date, time channel Nos., record range, scaling, units, alarm set values, chart speed, Tag Nos.)
  - (3) Test pattern (all characters and colour patterns)
- Alarm print-outs: Channel No., type of alarm (H, L, RH., RL), output relay No., time of detection/cancellation
- Burn-out print-out: Channel where burn-out occurred and time
- Others: Ink low warning print-out, auto-range change mark, recording start mark, recording paper feed speed change

## Performance, characteristics

- Input resistance:  $\geq 10\text{ M}\Omega$  (50 mV range, thermocouples)  
Approximately  $100\text{ k}\Omega$  (500 mV range)  
Approximately  $1\text{ M}\Omega$  (5V, 50V range)
- Chart speed accuracy:  $\pm 0.1\%$  (For continuous feed of 1m or more. Does not include paper elongation/shrinkage.)
- Clock precision:  $\leq \pm 50\text{ ppm}$  (monthly variation about 2 minutes)

---

Insulation resistance: 100 M $\Omega$  or more (across each terminal and ground at DC 500V)

Withstand voltage: Input terminal - input terminal: 500VAC 1 minute  
Power supply terminal - ground: 2000VAC 1 minute  
Input terminal - ground: 500V AC 1 minute  
Power terminal - input terminal: 500VAC, 1 minute  
Between alarm terminals: 750VAC, 1 minute  
(Leakage current 5mA or less, however, if the power supply is 24V DC, Leakage current of "Power supply terminal - ground" is 10mA or less)

Reference junction compensation precision: K, E, J, T, N, L, U, PN ....  $\pm 0.5^{\circ}\text{C}$   
(In case of minus input measurement :  $\pm 1.2^{\circ}\text{C}$ )  
R, S, B, W .....  $\pm 1^{\circ}\text{C}$   
(In case of minus input measurement :  $\pm 2.4^{\circ}\text{C}$ )

## Construction

Mounting method: Mounted in panel (vertical panel)  
Tilt angle  $\alpha = 90$  to  $60^{\circ}$

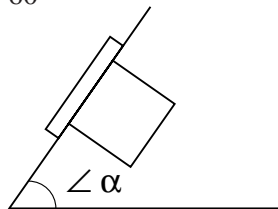

$\alpha = 60$  to  $90^{\circ}$

Material: Case: steel plate  
Front flap frame: glass-containing polycarbonate

Mass: Approximately 2.1 kg (without options)  
Approximately 2.2 kg (with all options)

External dimensions: 144  $\times$  144  $\times$  199 mm

Painted colour: Case black; front flap frame black

External terminals: Screw terminals (M4 thread)

## Power supply section

1) Supply voltage 100 to 240V AC products (9th digit of code symbol = "D")

Power supply voltage: 100V (-15%) to 240V (+10%) AC (design nation)

Power consumption: 100VAC with all options approximately 26 VA

2) Supply voltage 24V DC products (9th digit of code symbol = "L")

Power supply voltage: 24V ( $\pm 10\%$ ) DC

Power consumption: 26.4V DC with all options less than 26 VA



---

## Normal operating condition (Condition of device designed for normal continuous operation)

Usage environment: Indoor

Ambient temperature: 0 to 50°C

Ambient humidity: 20 to 80% RH, but temperature × humidity < 3200

Vibration: 10 to 60 Hz, 0.2m/s<sup>2</sup> {0.02G} or less

Mounting attitude: Forward tilt 0°, rearward tilt within 30°, left/right 0°

Signal source resistance: Thermocouple input .... Less than 1kΩ

Voltage input .... Less than 0.1% of input resistance

Resistance bulb input .... Less than 10Ω/wire (resistance of each wire of 3-wire system should be balanced).

Warm-up time: ≥ 30 minutes

Impact: none

Environmental protection: IEC IP50 (Front) / 20 (Terminal) [Not covered by UL approval]

Installation category: II

Pollution degree: 2

Operating altitude: 2000m max.

## Effects of operating conditions

Effects of power supply fluctuation:

- 1) Supply voltage 100 to 240 V AC products (9th digit of code symbol = "D")  
With 85 to 264VAC fluctuation (frequency 50 or 60 Hz) 100VAC base  
Indication variation: ±(0.1% of reference range + 1 digit) or less  
Recording variation: ±0.2% of record span or less  
With 47 to 63 Hz fluctuation (power supply voltage: 100VAC) 50 Hz base  
Indication variation: ±(0.1% of reference range + 1 digit) or less  
Recording variation: ±0.2% of record span or less
- 2) Supply voltage 24V DC products (9th digit of code symbol = "L")  
With 21.6 to 26.4V DC fluctuation 24V DC base  
Indication variation: ±(0.1% of reference range + 1 digit) or less  
Recording variation: ±0.2% of record span or less

---

Effect of input source resistance and wiring resistance:

Thermocouples ..... 10 $\mu$ V per 100 $\Omega$

Variation with resistance value equivalent to 0.1% of the input value in the case of voltage

Indication variation:  $\pm(0.1\%$  of reference range + 1 digit) or less

Recording variation:  $\pm 0.2\%$  of record span or less

Variation with fluctuation of 10 $\Omega$  per line in the case of resistance bulbs

Indication variation:  $\pm(0.1\%$  of reference range + 1 digit) or less

Recording variation:  $\pm 0.2\%$  of record span or less (if all 3 lines have the same resistance)

Effect of ambient temperature: Indication variation:  $\pm(0.3\%$  of reference range + 1 digit) or less/10 $^{\circ}$ C

Recording variation:  $\pm 0.5\%$  of record span or less/10 $^{\circ}$ C

Effect of mounting attitude: With rearward tilt within 30 $^{\circ}$

Indication variation:  $\pm(0.1\%$  of reference range + 1 digit) or less

Recording variation:  $\pm 0.2\%$  of record span or less

Effect of vibration: On 2 hours imposition of frequency 10 to 60 Hz, acceleration 0.2m/s $^2$  {0.02G} linear vibration in each of 3 axes

Indication variation:  $\pm(0.1\%$  of reference range + 1 digit) or less

Recording variation:  $\pm 0.2\%$  of record span or less

Effect of external noise: Normal mode noise: (50, 60 Hz  $\pm 0.1$  Hz):  $\geq 30$  dB or more

Common mode noise: (50, 60 Hz  $\pm 0.1$  Hz):  $\geq 120$  dB or more

Recording paper: On 20 $^{\circ}$ C, 65% RH base

Elongation at 85% RH:  $\leq 0.4\%$

Shrinkage at 35% RH:  $\leq 0.5\%$

## Alarms

Setting method: Set from keyboard.

Number of settings: Optional setting of Max. 4 points, 4 kinds (H, L, RH, RL) for each channel.

Display: On detection, display section indication of alarm types, and output relay Nos. for each channel

Print-out: Print-out of Channel Nos., alarm types, output relay Nos. and detection/cancellation times on recording paper

Output: As in supplementary specification

Hysteresis amplitude: About 0.5% of record span

## Transport, storage conditions

Temperature: -10 to +60 $^{\circ}$ C

Humidity: 5 to 90% RH (but to be no dew condensation)

---

Vibration: 10 to 60 Hz, 2.45m/s<sup>2</sup> {0.25G} or less

Impact:  $\leq 294\text{m/s}^2$  {30G} or less

## Reference standards

Safety standards: IEC 61010-1

EMC standards: EN 61326

### Caution

- 1) When this product is used connecting with other equipment, radiation may exceed the required level of standard.
- 2) Do not use this product near the handy phone or transmitter with radio frequency. This product is intended to be used under the circumstance of controlled electromagnetically field.

## UL standards

Only specific part of the functions are conformed to UL61010-1 standard.

Please refer to Item 1.3 and “Optional specifications” on this page.

## Supplementary specification

1. Recording paper illumination: cold cathode fluorescent lamp

2. Alarm output/external control: Special-purpose unit needed.

Unit can be mounted in rear of instrument as extra equipment at a later date.

(1) Alarm output (DO): 6 point of relay contact output, each being used for individual channel or OR operation.

Relay contact capacity: 1a contact, 240VAC, 3A (resistive load), 30VDC, 3A (resistive load)  
1b contact, 125VAC, 0.4A (resistive load), 30VDC, 2A (resistive load)

Note: Only following specifications obtain UL approval.

1a contact 30V AC /30V DC 3A (resistive load)

(2) External control (DI): The following functions can be performed in response to external contact signals:

Recording operation start/stop (DI1): Contact signals can start/stop recording operations. Recording starts when contact is closed and stops when contact is open.  
Message print is started when DI1 is specified. It is also started during recording when the contact is closed.

2-stage change of chart speed (DI2): Contact signals can effect a change from normal recording paper feed speed to remote mode chart speed. Closing the contact gives remote mode chart speed.  
Opening the contact gives normal chart speed.  
Message print is started when DI2 is specified. It is also started during recording when the contact is closed.

Instantaneous value print-out (DI3): Instantaneous value lists (dates, times, channel Nos., measured values, units) are printed out in response to contact signals.  
 Print-out starts when the contact is closed and stops when the contact is opened.

But, latch is OFF when alarm latch function is ON.

Note: As the external control unit is not insulated, use it with insertion of an external relay.

Contact capacity: 12VDC 0.05A 1a contact

### 3. Transmission function: RS-485 interface

Serves to transmit measured values and receive specified conditions.

#### RS-485

Transmission system	Half duplex bit-serial
Synchronization type	Start-stop synchronization
Coding type	Binary      Date length 8 bits Parity odd/even/none Stop bits 1 or 2
Transmission rate	2400, 4800, 9600, 19200 bps
Number of units connected	Maximum 31 units
Transmission distance	Total length maximum 1 km

Note: For connection through RS-232C, Use a 232/485 converter.

Use of the following converter is recommended:

Maker: System Sakomu Co., Japan

Phone: +81-45-474-4062

Type: KS-485

### Optional accessories (available separately)

Item	type	Specification
Shunt resistor	PHZT1101	10Ω±0.1%, DC 4 to 20mA, 10 to 50mA input

## Standard functions

Function		Contents
Arbitrary range setting		Any record range can be set for each individual channel.
Arbitrary specification of input signals		Any type of input can be specified for each individual channel.
Skip function		Function for skipping the records, indication sand alarms at any measurement point.
List print-out function	Instantaneous values list	Dates, times and the measured values and units for each channel are printed out.
	Set value list	Dates, times, recording ranges, scaling, units, input types, alarm set values, recording paper feed speed and Tag Nos. are printed out.
	Test pattern	All the types of characters and color patterns are printed out.
Periodic print-out function		Time lines, dates, times, recording paper feed speed and measured values for each channel are printed out at set intervals of time. The keyboard can be used to allow or to prohibit print-outs.
Message print function		Messages of up to 10 kinds and 16 characters which have arbitrarily specified are printed. Message print is started when the contact is closed.
Alarm print-out function		The times of detection of alarms and clearing of alarms, the channel Nos. alarm types and output relay Nos. are printed out.
Units display		°C, °F, %, mV, mA, kg/cm <sup>2</sup> and other working units are displayed. (Units can be specified from the keyboard.)
Scaling function		In the case of DC voltage input, any scaling is possible. Any specification in the range -32767 to 32767, with the decimal point anywhere, is possible.
Difference records		The difference between any specified channels are recorded. (Channels are specified from the keyboard.)
Auto-range change function		Function whereby if input goes above or below the current range the range is automatically changed and the change is recorded (specified from the keyboard). However, this function cannot be used if zone recording or zoom recording used.
Zone recording function		Function for effecting recording with the recording area divided into a maximum of 3 zones. However, this function cannot be used if auto-range recording or zoom recording is used.
Zoom function		Function for effecting recording with one part of the recording area for each channel enlarged and another reduced. However, this function cannot be used if auto-range recording or zone recording is used.
Square root extraction function		DC voltage input $\sqrt{\quad}$ calculations can be performed.
Logarithmic calculation function		10 <sup>n</sup> input with DC input is possible. Display, 1.0E - 9 to 1.0E + 9
PV shift function		Setting of zero shift and gain shift of measured value.
Record color change function		Function for changing record print color for each channel.

Function	Contents
Daily report function	<p>Max. 1-day lots (lots of max. 24 data items) of the instantaneous values at each full hour for each channel each day are stored and printed out. At the same time, maximum values, minimum values and average values are printed out too.</p> <p>The operation is turned on/off for individual channels and the operation start time is specified from the keyboard.</p>
Data sum function	<p>Max. 1-day lots (lots of max. 24 data items) of the integration values for 1-hour periods in each channel each day are stored and printed out. At the same time, maximum values, minimum values and average values are printed out too.</p> <p>The operation is turned on/off for individual channels and the operation start time is specified from the keyboard.</p>
Memory backup function	<p>Set data and clock functions are protected by a lithium battery incorporated in the recorder. (Battery life is about 10 years at normal temperature.)</p>
Input filter	<p>Filter function for delaying the response of each channel to counter sharp changes in input. (Primary delay filters)</p> <p>Time constant setting range : 0 to 900 seconds (set from the keyboard)</p>
Burn-out function	<p>If thermocouple or resistance bulb wire breakage occurs, there is a swing to the maximum value of recording range and at the same time a display is given and a printed record is made.</p>
Alarm latch function	<p>Used to hold alarm display and alarm output even after alarm is recovered.</p> <p>ON/OFF operation is made from the keyboard.</p> <p>Alarm in hold mode is released by external control (DI).</p>
Set value copying function	<p>Used to copy the value, which has been set in any channel, to another channel.</p>

---

## **Fuji Electric Co., Ltd.**

### **International Sales Div**

#### **Sales Group**

Gate City Ohsaki, East Tower, 11-2, Osaki 1-chome,  
Shinagawa-ku, Tokyo 141-0032, Japan

<http://www.fujielectric.com>

Phone: 81-3-5435-7280, 7281 Fax: 81-3-5435-7425

<http://www.fujielectric.com/products/instruments/>

---