

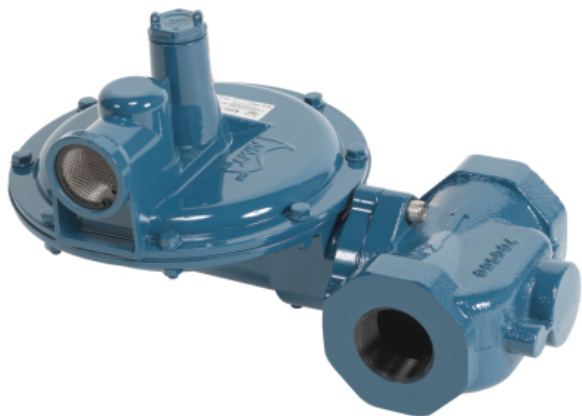

NGR04 Series

PRESSURE REDUCING REGULATORS
for Residential, Commercial or Industrial Applications



The NGR04 Series spring loaded gas regulators with internal relief provide consistent and controlled pressure in a variety of residential, industrial and commercial applications. The NGR04 meets ANSI Z21.80/CSA 6.22 for Class I, Class II, Vent Limiting and OPD (Overpressure Protection Device) applications and are designed to be used in many applications where non-corrosive dry gases are used.

FEATURES

- Vent Limiting Option
- Internal Relief - OPD
- Outlet pressures up to 3 psig
- Conforms to ANSI B109.4
- Corrosion resistant exterior

SPECIFICATIONS

Pipe Sizes:	1-1/4" NPT to 3" FL
Gas Types:	Natural Gas, LPG, other non-corrosive dry gases
Maximum Inlet Pressure:	10 to 125 psig per Orifice
Outlet Pressure Range:	3" w.c. to 3 psig
Maximum Emergency Inlet Pressure:	175 psig
Operating Temp:	-40F - +140F
Materials:	Housing: Epoxy Coated Aluminum Valve Body: Cast Iron Diaphragm/Valve Seat: Buna N Orifice: High Strength Brass

NGR04 Series PRESSURE REDUCING REGULATORS

7" wc Outlet Pressure - BTU x1000 - 1" Pressure Drop

INLET PRESSURE	ORIFICE											
	1/4"		3/8"		1/2"		5/8"		3/4"		7/8"	
	NG	LP	NG	LP	NG	LP	NG	LP	NG	LP	NG	LP
10" wc	150	236	400	630	710	1118	780	1229	1100	1733	1310	2063
14" wc	300	473	600	945	800	1260	820	1292	1450	2284	1650	2599
1	377	594	740	1166	1013	1595	1039	1636	2065	3252	2078	3273
2	623	981	1140	1796	1636	2577	1818	2863	3740	5891	3896	6136
3	805	1268	1299	2046	2143	3375	2961	4664	4948	7793	5610	8836
5	935	1473	2104	3314	4403	6935	5000	7875	6935	10923	8571	13499
8	1325	2087	3000	4725	5844	9204	6429	10126	9195	14482	10987	17305
10	1558	2454	3299	5196	6390	10064	7052	11107	10286	16200	11065	17427
15	2026	3191	3896	6136	8104	12764	8571	13499				
25	2610	4111	4156	6546	11610	18286						
35	3195	5032	4909	7732								
50	4286	6750	5961	9389								
75	6234	9819										
100	7247	11414										
125	9399	14803										

Gray S04B/2" VB to obtain values

NG = 0.63 S.G. gas = 1CF/1000BTU

LP = 1.53 S.G. gas = 1CF/2500BTU

14" wc Outlet Pressure - BTU x1000 - 2" Pressure Drop

INLET PRESSURE	ORIFICE											
	1/4"		3/8"		1/2"		5/8"		3/4"		7/8"	
	NG	LP	NG	LP	NG	LP	NG	LP	NG	LP	NG	LP
1	370	583	690	1087	780	1229	820	1292	1120	1764	2340	3686
2	603	950	1090	1717	1150	1811	1280	2016	1860	2930	2420	3812
3	780	1229	1560	2457	2100	3308	2340	3686	2960	4662	4130	6505
5	1170	1843	2490	3922	2540	4001	3150	4961	5060	7970	5450	8584
8	1400	2205	3300	5198	4200	6615	4350	6851	7950	12521	9970	15703
10	1630	2567	3500	5513	5760	9072	6450	10159	10120	15939	13170	20743
15	2030	3197	4900	7718	8330	13120	9580	15089				
25	2730	4300	6380	10049	11680	18396						
35	3500	5513	7950	12521								
50	4600	7245	10360	16317								
75	5900	9293										
100	6880	10836										
125	9579	15087										

Silver S04E/2" VB to obtain values

NG = 0.63 S.G. gas = 1CF/1000BTU

LP = 1.53 S.G. gas = 1CF/2500BTU

Relief & Lever Disconnect curves available upon request. Results in chart may vary for every application.

NGR04 Series PRESSURE REDUCING REGULATORS

1 psig Outlet Pressure - BTU x1000 - 20% Pressure Drop

INLET PRESSURE	ORIFICE											
	1/4"		3/8"		1/2"		5/8"		3/4"		7/8"	
	NG	LP	NG	LP	NG	LP	NG	LP	NG	LP	NG	LP
2	468	737	545	858	623	981	701	1104	1247	1964	1870	2945
3	623	981	779	1227	1091	1718	1169	1841	2182	3437	2727	4295
5	935	1473	1091	1718	1948	3068	1955	3079	3506	5522	4052	6382
8	1247	1964	1558	2454	2883	4541	3117	4909	5143	8100	6857	10800
10	1403	2210	2026	3191	3896	6136	3974	6259	6701	10554	8727	13745
15	1870	2945	2416	3805	6390	10064	7169	11291				
25	2649	4172	6234	9819	9896	15586						
35	3117	4909	7870	12395								
50	4442	6996	9800	15435								
75	6449	10157										
100	8374	13189										
125	10367	16328										

Red-Gray S04F/2" VB to obtain values NG = 0.63 S.G. gas = 1CF/1000BTU LP = 1.53 S.G. gas = 1CF/2500BTU

2 psig Outlet Pressure - BTU x1000 - 20% Pressure Drop

INLET PRESSURE	ORIFICE											
	1/4"		3/8"		1/2"		5/8"		3/4"		7/8"	
	NG	LP	NG	LP	NG	LP	NG	LP	NG	LP	NG	LP
3	623	981	1013	1595	1403	2210	1714	2700	2104	3314	2260	3560
5	857	1350	1870	2945	2104	3314	2805	4418	3429	5401	3974	6259
8	1169	1841	2494	3928	3584	5645	4753	7486	5900	9293	5922	9327
10	1403	2210	3506	5522	4519	7117	5688	8959	6234	9819	7325	11537
15	1792	2822	4442	6996	6545	10308	8104	12764				
25	2649	4172	6312	9941	9351	14728						
35	3351	5278	7792	12272								
50	4442	6996	9740	15341								
75	6548	10313										
100	8517	13414										
125	10538	16597										

White S0204E/2" VB to obtain values NG = 0.63 S.G. gas = 1CF/1000BTU LP = 1.53 S.G. gas = 1CF/2500BTU

Relief & Lever Disconnect curves available upon request. Results in chart may vary for every application.

Model	Pipe Size	Vent (NPT)	Wt. (lb)
NGR04	1-1/4", 1-1/2", 2"	1"	10.75
	2" FL		21.55
	3" FL		28.80

Orifice Max Pressure		
Size	Max Inlet Pressure	P/N
1/4"	125 psig	F0406A
3/8"	50 psig	F0406B
1/2"	25 psig	F0406C
5/8"	15 psig	F0406D
3/4"	10 psig	F0406E
7/8"	10 psig	F0406F

Spring Chart		
Color	Outlet Range	P/N
Brown	3"wc - 7"wc	S04A
Gray	4"wc - 13"wc	S04B
Black	9"wc - 14"wc	S04C
Blue	9"wc - 15"wc	S04D
Silver	12"wc - 20"wc	S04E
Red/Gray (HP)	13"wc - 28"wc	S04F
Yellow (HP)	1psig - 2psig	S04G
Red (HP)	1psig - 2.5psig	S04H
White (HP)	1psig - 3psig	S0204E

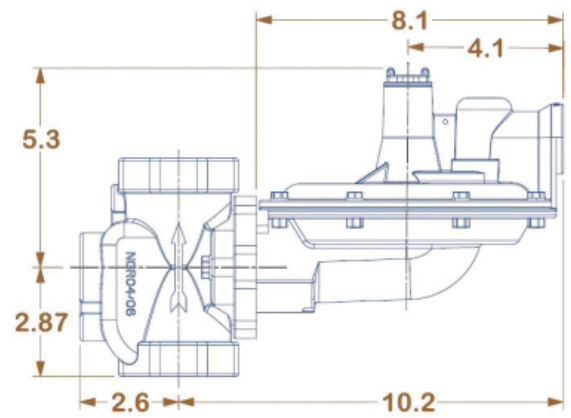

Flange to Flange (2" & 3"): 10"

Gas Type	Specific Gravity	Correction Factor (CF)
Natural Gas	0.60	1.00
Propane	1.53	0.63
Air	1.00	0.77
Propane-Air-Mix	1.20	0.71
Nitrogen	0.97	0.79
Butane	2.01	0.55
Carbon Dioxide (Dry)	1.52	0.63
Carbon Monoxide (Dry)	0.97	0.79