

Instructions

Solenoid valves for gas VAS 1 – 3, VCS 1 – 3, pressure regulators with solenoid valve VAX 1 – 3, VCx 1 – 3, magnetic relief valve VAN: replacing screws or the device

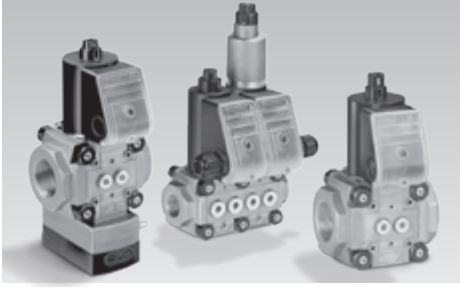

Contents

Solenoid valves for gas VAS 1 – 3, VCS 1 – 3, pressure regulators with solenoid valve VAX 1 – 3, VCx 1 – 3, magnetic relief valve VAN: replacing screws or the device 1

Contents 1

Safety 1

Check whether the valve is affected 2

Checking the usage 2

Preparing the replacement 2

Replacing the countersunk screws 3

Replacing a valve without solenoid actuator 5

Replacing a valve with solenoid actuator . . . 5

Tightness test 6

Accessories 6

Feedback form 7

Returns 8

Contact 8

Safety

Please read and keep in a safe place



Please read through these instructions carefully before installing or operating. Following the installation, pass the instructions on to the operator. This unit must be installed and commissioned in accordance with the regulations and standards in force. These instructions can also be found at www.docuthek.com.

Explanation of symbols

■, **1**, **2**, **3**... = Action
 ▷ = Instruction

Liability

We will not be held liable for damage resulting from non-observance of the instructions and non-compliant use.

Safety instructions

Information that is relevant for safety is indicated in the instructions as follows:

⚠ DANGER

Indicates potentially fatal situations.

⚠ WARNING

Indicates possible danger to life and limb.

! CAUTION

Indicates possible material damage.

All interventions may only be carried out by qualified gas technicians. Electrical interventions may only be carried out by qualified electricians.

Conversion, spare parts

All technical changes are prohibited. Only use OEM spare parts.

Changes to edition 01.17

The following chapters have been changed:

- Replacing the countersunk screws
- Feedback form
- Returns

Check whether the valve is affected

Whether the valve is affected by the replacement of the screws depends on its date of manufacture, see type label.

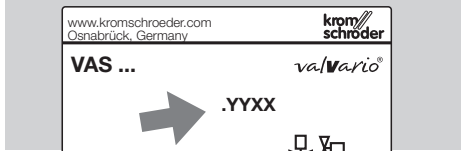

YY = Year of manufacture, XX = Production week

All valves with the following date of manufacture are affected: week 9 of 2015 to week 43 of 2015 (.1509 to .1543).

So are all valves with proof of closure (POC) switch and visual position indicator. The valves feature the additional code "GR", "GL", "SR" or "SL" in the type code. Date of manufacture: week 27 of 2014 to week 43 of 2015 (.1427 to .1543).

Checking the usage

Intended use

These instructions describe the replacement of the countersunk screws on the guide tube of valVario valves, size 1 to 3, and the replacement of the valve itself.

Affected valVario valves:

VAS solenoid valve for gas

VAN magnetic relief valve

VAD pressure regulator with solenoid valve

VAG air/gas ratio control with solenoid valve

VAV variable air/gas ratio control with solenoid valve

VAH flow rate regulator with solenoid valve

VRH flow rate regulator

Combination sections:

VCS double solenoid valve

VCD, VCG, VCV, VCH pressure regulators with double solenoid valve

Correct functioning of these valves is only guaranteed when used within the limits specified in the section entitled "Technical data" in the operating instructions of the valve to be converted. Any other use is considered as non-compliant.

All other information regarding commissioning, technical data, maintenance, etc. can be found in the corresponding operating instructions of the valve to be converted

or

see www.docuthek.com → Home → Elster Thermal Solutions → Products → O3 Valves and butterfly valves → Solenoid valves for gas VAS ..., VCS ... or Pressure regulators with solenoid valve VAD, VAG ... or Magnetic relief valves VAN.

Part designations

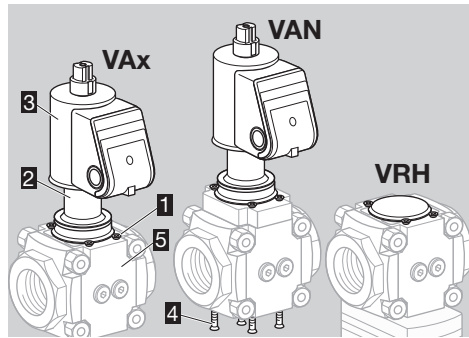

- 1 4 x M4 x 12 countersunk screws
- 2 Guide tube
- 3 Solenoid actuator
- 4 4 x M4 x 12 countersunk screws (VAN only)
- 5 Valve body

Preparing the replacement

- ▷ Make a note of the serial number of the affected valve on your feedback form, see page 7 (Feedback form). The label can be found on the valve body of the fitted valve (bottom number).



! IMPORTANT!

Assign your valve to the applicable service intervention:

VAX../N, quick opening individual valves and individual regulators without proof of closure switch

Type	Designation
VAN 1–2	Magnetic relief valve
VAS 1–3	Solenoid valve for gas
VAD 1–3	Pressure regulator with solenoid valve
VAG 1–3	Air/gas ratio control with solenoid valve
VAV 1–3	Variable air/gas ratio control with solenoid valve
VAH 1–3	Flow rate regulator with solenoid valve
VRH 1–3	Flow rate regulator

VCx../N, combination section consisting of a valve or regulator with solenoid valve without proof of closure switch

Type	Designation
VCS 1–3	VAS + VAS
VCD 1–3	VAS + VAD
VCG 1–3	VAS + VAG
VCV 1–3	VAS + VAV
VCH 1–3	VAS + VAH

- ▷ If the affected valve is described here: see page 3 (Replacing the countersunk screws) or if the screws are defective or corroded, see page 5 (Replacing a valve without solenoid actuator) or page 5 (Replacing a valve with solenoid actuator).

VAX../L, VCx../L, slow opening valves without proof of closure switch

Type	Designation
VAS 1 – 3	Solenoid valve for gas
VCS 1–3	Double solenoid valve

- ▷ If the affected valve is described here: see page 3 (Replacing the countersunk screws) or if the screws are defective or corroded, see page 5 (Replacing a valve with solenoid actuator).

VAX../S, VAx../G, VCx../S, VCx../G individual valves or combination section with proof of closure switch

- ▷ See page 5 (Replacing a valve with solenoid actuator).

Accessories to be kept available

- ▷ Countersunk screws on the guide tube, see page 6 (Accessories).
- ▷ Seals, see page 6 (Accessories).
- ▷ Other spare parts can also be found using PartDetective → www.partdetective.de

⚠ WARNING
Attention! Please observe the following to ensure that no damage occurs:

- Electric shocks can be fatal! Before working on possible live components, ensure the unit is disconnected from the power supply.
- The solenoid actuator heats up during operation. Surface temperature approx. 85°C (approx. 185°F).



Replacing the countersunk screws

- ▷ Only replace the countersunk screws currently in place if they appear to be in perfect condition.



- ▷ If the screws are defective or corroded, see page 5 (Replacing a valve without solenoid actuator) or page 5 (Replacing a valve with solenoid actuator).
- ▷ Only genuine replacement screws supplied by Elster are to be used, see page 6 (Accessories).
- ▷ If other screws are used for fastening, the warranty will be void.
- ▷ Depending on the valve version, the illustration may not correspond entirely.

- 1 Disconnect the system from the electrical power supply.
- 2 Shut off the gas supply.

Removing the actuator

- ▷ The electrical connection remains in place.

VAN, VAX../N, VCx../N without damping

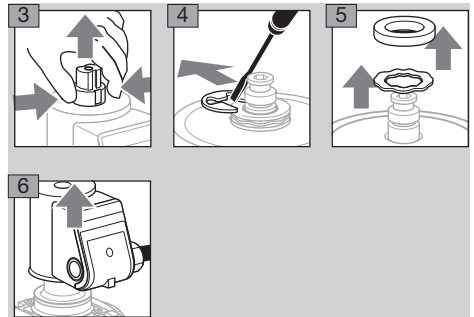

VAX../L, VCx../L with damping

- ▷ Loosen the setscrews, but do not unscrew completely (M3 = 1.5 mm hexagon socket, M5 = 2.5 mm hexagon socket).
- ▷ We recommend replacing the O-ring for the damping unit, see “Accessories”, page 7 (Seal for damping unit).

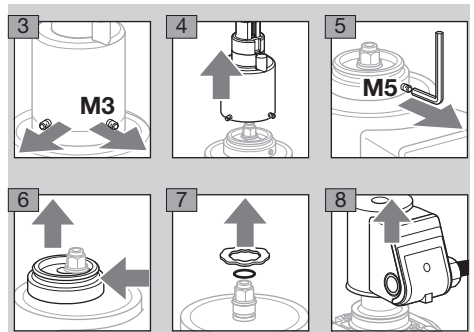

Replacing screws

! CAUTION

Attention! To avoid leakage, please observe the following:

- To ensure that the gas-filled space remains sealed, replace the countersunk screws with new screws one at a time, not all at the same time.
- If a screw is damaged when it is undone, stop the process, leave the remaining screws in place and replace the valve, see page 5 (Replacing a valve without solenoid actuator) or page 5 (Replacing a valve with solenoid actuator).

- ▷ To undo the screws: Torx bit T20.
- ▷ To tighten the screws: Torx bit T15.
- ▷ Do not use lubricant for the installation work.

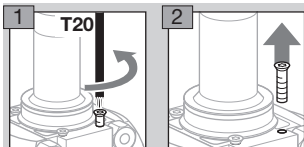

- ▷ When tightening the self-tapping threaded screws, a second thread must not be formed in the valve body. We therefore recommend that the screws are positioned and tightened by hand first.

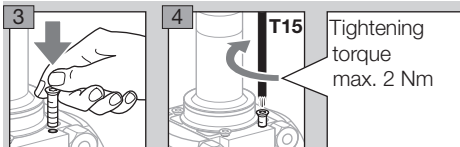

5 Check that all the screws and the guide tube are secure.

6 Once the screws have been replaced, apply the supplied sticker to the valve body so that it is clearly visible. Clean the sticking location on the valve body beforehand so that the sticker adheres perfectly.

VAN

- ▷ Repeat the process on the underside of the VAN. Here too, replace the screws one by one, not all together.

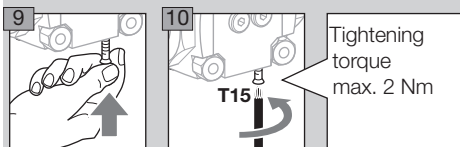
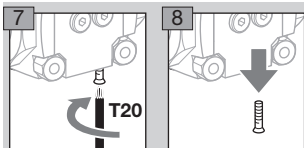

Assembly

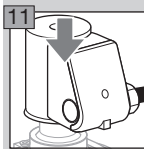

VAN, VAx..N, VCx..N without damping

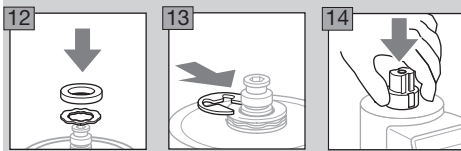

VAx..L, VCx..L with damping

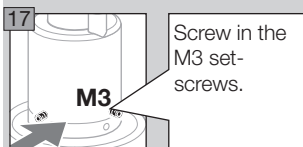
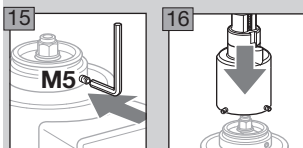
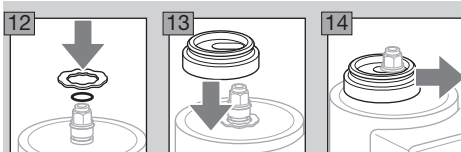

18 Open the gas solenoid valve and the gas supply.

19 Adjust the start gas rate, see Solenoid valves for gas VAS 1 – 3, VCS 1 – 3 operating instructions, section entitled “Setting the start gas rate”.

Tightness test

- ▷ Check the damping unit for tightness, see “Tightness test”, page 6 (VAx..L, VCx..L with damping).
- ▷ Check the valve for tightness, see page 6 (Tightness test).
- ▷ Other information regarding commissioning, technical data, maintenance, etc. can be found in the corresponding operating instructions of the valve to be converted.

Replacing a valve without solenoid actuator

- ▷ If the screws are defective or corroded, replace the valve without the solenoid actuator. The solenoid actuator is not to be replaced.

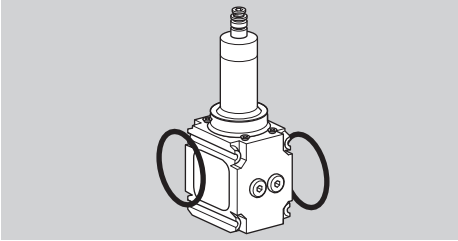

- ▷ We recommend replacing all the sealing rings, see "Seal set", page 6 (Accessories).
- ▷ Depending on the valve version, the illustration may not correspond entirely.

- 1** Disconnect the system from the electrical power supply.
- 2** Shut off the gas supply.

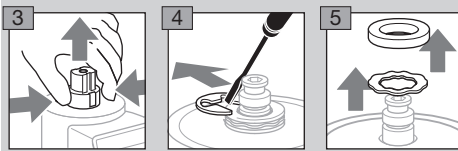

- ▷ Remove the solenoid actuator along with its wiring.

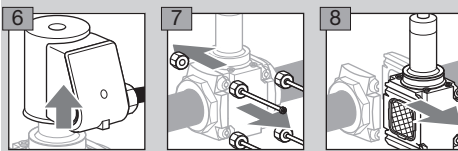

- ▷ Remove any accessories, e.g. pressure switches, if fitted.
- ▷ Before installing the new valve, check the strainer, clean it and fit new sealing rings.

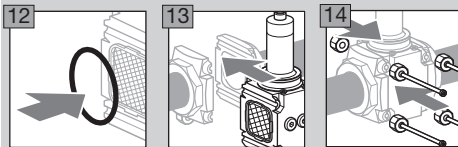
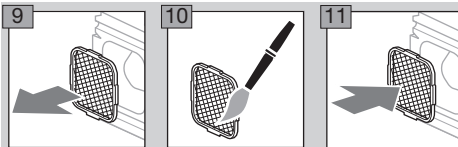

- ▷ Install accessories with new seals, see operating instructions of the valve to be converted.

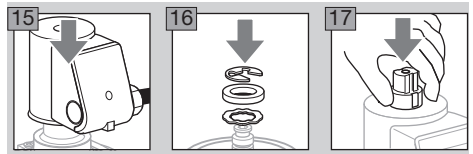

- 18** Check for tightness, see page 6 (Tightness test).

- ▷ All other information regarding commissioning, technical data, maintenance, etc. can be found in the corresponding operating instructions of the valve to be converted.
- ▷ Return the removed valve, see page 8 (Returns).

Replacing a valve with solenoid actuator

- ▷ If the screws are defective or corroded, valves with proof of closure switch, with damping unit or with pressure regulator must be replaced complete with the solenoid actuator.

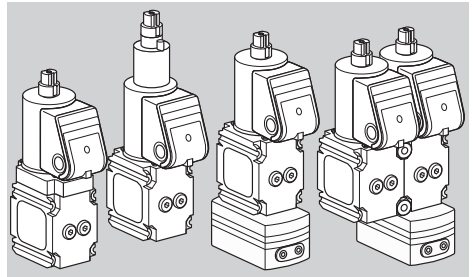

- ▷ Pressure regulators are equipped with a differential pressure orifice at the outlet. Ensure that a DN 25 differential pressure orifice is fitted on regulators of size 1 which are not installed direct on an outlet flange. For further information, see the corresponding operating instructions of the valve to be converted.
- ▷ Remove any accessories, e.g. pressure switches, and impulse lines if fitted.
- ▷ We recommend replacing all the sealing rings, see page 6 (Accessories).
- ▷ Depending on the valve version, the illustration may not correspond entirely.

- 1** Disconnect the system from the electrical power supply.
- 2** Shut off the gas supply.
- 3** Remove the electrical connection.

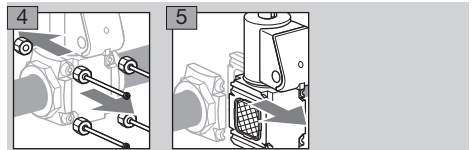

- ▷ Before installing the new valve, check the strainer, clean it and fit new sealing rings.

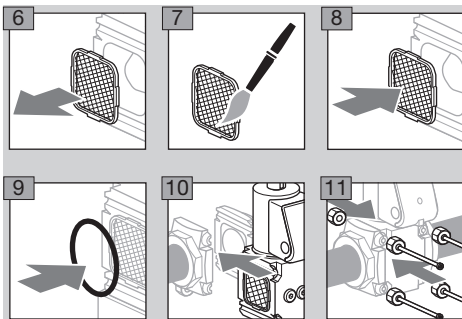

12 Follow the reverse procedure to reassemble the valve.

▷ Install accessories and impulse lines with new seals, see operating instructions of the valve to be converted.

13 Check for tightness, see page 6 (Tightness test).

▷ Other information regarding commissioning, technical data, maintenance, etc. can be found in the corresponding operating instructions of the valve to be converted.

▷ Return the removed valve, see page 8 (Returns).

Tightness test

▷ Depending on the valve version, the illustration may not correspond entirely.

1 Close the gas solenoid valve.

2 To be able to check the tightness, shut off the downstream pipeline close to the valve.

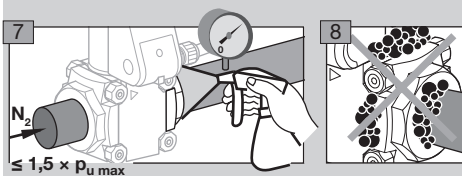
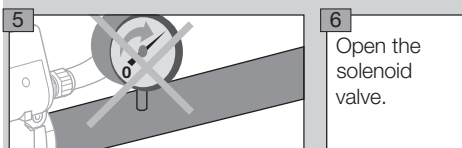
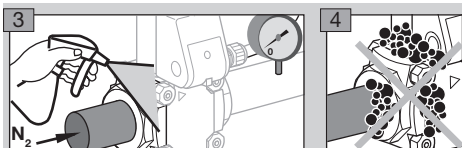

VAX../L, VCx../L with damping

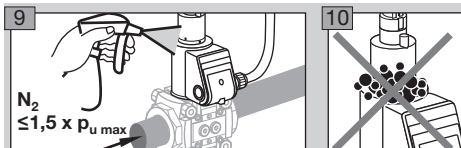

11 Check the accessories and impulse lines for tightness, see operating instructions of the valve to be converted.

12 Tightness OK: open the gas supply.

▷ Valve leaking: remove the valve block and return it to the manufacturer.

▷ Other information regarding commissioning can be found in the corresponding operating instructions of the valve to be converted.

Accessories

Seal set for sizes 1 – 3

When fitting accessories or a second valVario control or when servicing, we recommend replacing the seals.

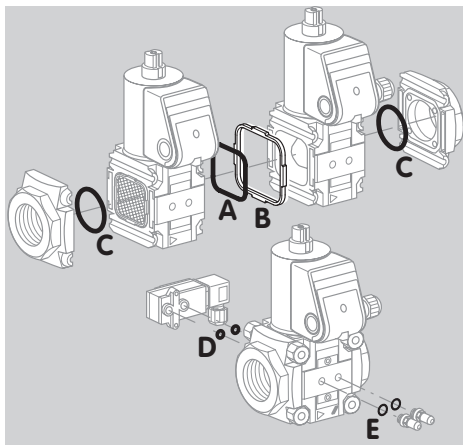

▷ Order No. for
size 1: Order No. 74921988,
size 2: Order No. 74921989,
size 3: Order No. 74921990.

▷ Scope of delivery:

- A** 1 x double block seal,
- B** 1 x retaining frame,
- C** 2 x O-rings (flange),
- D** 2 x O-rings (pressure switch),
for pressure test point/screw plug:
- E** 2 x sealing rings (flat sealing),
2 x profiled sealing rings.

Seal set for double solenoid valves

For replacing valves from a combination section.

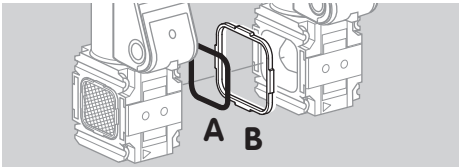

- ▷ Order No. for
size 1: Order No. 74924978,
size 2: Order No. 74924979,
size 3: Order No. 74924980.
- ▷ Scope of delivery:
 - A** 1 x double block seal,
 - B** 1 x retaining frame.

Countersunk screws

Genuine replacement screws from Elster. If other screws are used for fastening, the warranty will be void.

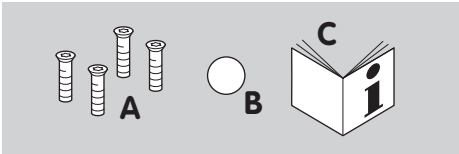

- ▷ Order No. 74924998
- ▷ Scope of delivery:
 - A** 4 x countersunk screws M4 x 12 mm, self-tapping thread,
 - B** 1 x valve body sticker,
 - C** 1 x "Replacing screws or the device" instructions

Countersunk screws for VAN

Genuine replacement screws from Elster. If other screws are used for fastening, the warranty will be void.

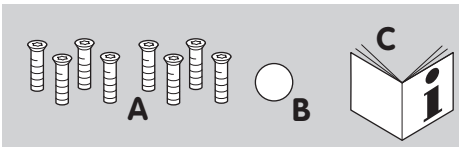

- ▷ Order No. 74924999
- ▷ Scope of delivery:
 - A** 8 x countersunk screws M4 x 12 mm, self-tapping thread,
 - B** 1 x valve body sticker,
 - C** 1 x "Replacing screws or the device" instructions

Seal for damping unit

If the damping unit is removed, replace the seal. Grease the new seal.

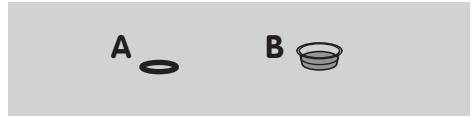

- ▷ Order No. 74924997
- ▷ Scope of delivery:
 - A** 1 x O-ring,
 - B** 1 x cap with grease.

Feedback form

- ▷ For technical evaluation, it is important to obtain information about the affected valve. Please help us by taking a little time to insert crosses against the relevant sections on the feedback form. Thank you!
- ▷ Please send the completed feedback form to **valVarioRetrofit@honeywell.com**.

Serial number

- ▷ Make a note of the serial number of the valve body on your feedback form, see page 7 (Feedback form). The label can be found on the valve body of the affected valve (bottom number).



Address

Insert your customer address so that we can assign the serial numbers to your customer master data.

Environment

For technical evaluation, it is important to obtain information about the environment in which the device is installed.

Feedback form

Serial numbers of the valves with replaced countersunk screws:

Valve 1	Valve 4	Valve 7	Valve 10
Valve 2	Valve 5	Valve 8	
Valve 3	Valve 6	Valve 9	

Serial numbers of the valves which are to be sent back:

Valve 1	Valve 4	Valve 7	Valve 10
Valve 2	Valve 5	Valve 8	
Valve 3	Valve 6	Valve 9	

Address:

Company	
Country	
Name of contact person	
Contact person's e-mail address	

Environment:

Damp	
Dry	
Indoors	
Outdoors	

Please send the completed feedback form to valVarioRetrofit@honeywell.com
or fax it to +49 541 1214-547

Returns

Please send removed valves to the following address:

Americas

Eclipse Inc.
Rep.-Management
valVario Project
1665 Elmwood Rd
Rockford, IL 61103
USA

Asia/Pacific

Eclipse Combustion Equipment Co Ltd.
Rep.-Management
valVario Project
Bldg. 3-1, 136 Yinsheng Road
Shengpu, SIP
215126 Suzhou, Jiangsu
China

Europe/Middle East/Africa

Elster GmbH
Rep.-Management
valVario Project
Strotheweg 1
49504 Lotte
Germany

If it is not possible to return the goods, please contact valVarioRetrofit@honeywell.com

Contact

If you have any technical questions, please contact your local branch office/agent. The addresses are available on the Internet or from Elster GmbH.

We reserve the right to make technical modifications in the interests of progress.

Honeywell

**krom
schroder**

Elster GmbH
Strotheweg 1, D-49504 Lotte (Büren)
Tel. +49 541 1214-0

hts.lotte@honeywell.com, www.kromschroeder.com