

# Honeywell

krom  
schroder

## Pressure switch for air DL

Technical Information · GB  
4 Edition 07.17

- Monitoring of air, flue gas and other non-aggressive gases
- High switching point stability
- Switching point selection via hand wheel or adjusting screw
- Screw terminals or AMP plugs for electrical connections
- Flexible mounting options



# Contents

Pressure switch for air DL .....	1
Contents .....	2
<b>1 Application .....</b>	<b>4</b>
1.1 Application examples .....	4
1.2 Mounting examples .....	7
1.2.1 Simple mounting .....	7
1.2.2 Mounting without the need for tools or screws .....	7
1.2.3 Pressure-resistant mounting on mounting plate .....	7
1.2.4 Rugged, locked mounting .....	8
1.2.5 Mounting directly on the fan motor .....	8
1.2.6 Protection against pressure surges .....	8
1.2.7 Clearer handling in complex installations .....	9
1.2.8 Tube set with diverse possible applications .....	9
1.2.9 Easier diagnosis and maintenance .....	10
<b>2 Certification .....</b>	<b>11</b>
2.1 Overview .....	12
<b>3 Function .....</b>	<b>13</b>
3.1 Positive pressure measurement .....	13
3.1.1 DL 1,5 A: hand wheel setting in the negative range .....	13
3.2 Negative pressure measurement .....	13
3.2.1 DL 1,5 A: hand wheel setting in the negative range .....	13
3.3 Differential pressure measurement .....	13
3.3.1 DL 1,5 A: hand wheel setting in the negative range .....	14
3.4 Overview: measuring the pressure in the positive and negative ranges .....	14
3.5 Wiring .....	15
3.5.1 Increasing pressure control .....	15
3.5.2 Decreasing pressure control .....	15
3.5.3 DL 1,5A .....	16
3.6 DL..A, DL..K, DL..T, DL..KT, DL..AT in Zone 1 (21) and 2 (22) hazardous areas .....	17
3.7 Animation .....	18

<b>4 Selection .....</b>	<b>19</b>
4.1 DL 3,3 – 40K selection table .....	20
4.1.1 Type code .....	20
4.1.2 Electrical connection .....	20
4.2 DL 2 – 35E selection table .....	21
4.2.1 Type code .....	21
4.2.2 Electrical connection .....	21
4.2.3 Switching differential/switching point depends on installation position .....	21
4.3 DL 1,5 – 150A, DL 3 – 150K, DL 10 – 150AH/..AN, DL 10 – 150KH/..KN selection table .....	22
4.3.1 Type code .....	22
4.3.2 Electrical connection .....	22
4.3.3 Test key .....	22
4.4 DL 1 – 50E selection table .....	23
4.4.1 Type code .....	23
4.4.2 Electrical connection .....	23
4.4.3 Test tapping point .....	23
<b>5 Project planning information .....</b>	<b>24</b>
5.1 Pressure switch with NBR diaphragm .....	24
5.2 Installation .....	24

---

<b>6 Accessories</b> .....	<b>26</b>
6.1 Securing clip S.....	26
6.2 Securing clip D.....	26
6.3 L-angle bracket.....	26
6.4 Z-angle bracket.....	27
6.5 U-angle bracket.....	27
6.6 Tube set.....	27
6.7 Pilot lamp set, red or blue.....	28
6.8 LED set, red/green.....	28
6.9 Standard socket set.....	28
6.10 Motor flange adapter.....	28
6.11 Damping nozzle.....	28
6.12 Restrictor orifice.....	29
6.13 Colour coordination set.....	29
6.14 External adjustment.....	29
6.15 Pressure equalization element.....	29
6.16 Grommet.....	30
<b>7 Technical data</b> .....	<b>31</b>
7.1 DL..K.....	32
7.1.1 Dimensions.....	33
7.1.2 Adjusting range, switching differential.....	33
7.2 DL..A, DL..K, DL..AH/..AN, DL..KH/..KN.....	34
7.2.1 Dimensions.....	35
7.2.2 Adjusting range, switching differential.....	36
7.3 DL 1E – DL 50E.....	37
7.3.1 Dimensions.....	38
7.3.2 Adjusting range, switching differential.....	38
7.4 DL 2E – DL 35E.....	39
7.4.1 Dimensions.....	40
7.4.2 Adjusting range, switching differential.....	40
<b>8 Maintenance cycles</b> .....	<b>41</b>
<b>Feedback</b> .....	<b>42</b>
<b>Contact</b> .....	<b>42</b>

### 1 Application

Pressure switches for air DL can be used as positive pressure switches, vacuum sensors or differential pressure switches for air, flue gas and other non-aggressive gases. They are not suitable for fuel gases. They monitor extremely low pressure differentials.

They trigger switch-on, switch-off or switch-over operations if a set switching point is reached. This switching point can be adjusted using a hand wheel or, if required, it can be fixed using an adjusting screw.

The diaphragm pressure switch with micro switch features particularly high contact reliability as low gas release components are used.

#### 1.1 Application examples



DL..K is used in air-conditioning systems and kitchens due to its low adjusting range (from 20 Pa).

The pneumatic and electrical connections on DL 3,3 – 40K are accessible from the same side in order to ensure space-saving and easy-to-fit installation.

The switching point can be infinitely adjusted using the hand wheel.



*Filter monitoring in kitchens*

## Application

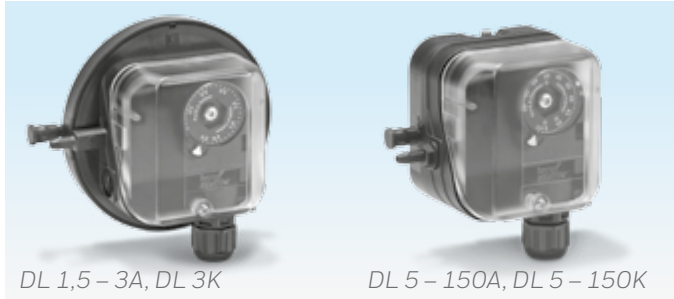

DL..A, DL..K are used for controlling butterfly valves for air and fire dampers in firing systems, and for fan monitoring.

DL 1,5 A (-0.5 to +1.5 mbar) is used in laboratories and special applications in particular.

On DL..A, the positive pressure can be connected via a threaded connection (Rp 1/4) in the lower housing section.

DL..A-3Z with tube connection for negative pressure also has a threaded connection Rp 1/8 for negative pressure. To use the threaded connection, the tube connection must be unscrewed (minus).

The DL..AH/..HN, DL..KH/..KN can be supplied with manual reset function and is used, for example, for siphon monitoring on heating systems.



*Fan monitoring in laboratories*

## Application

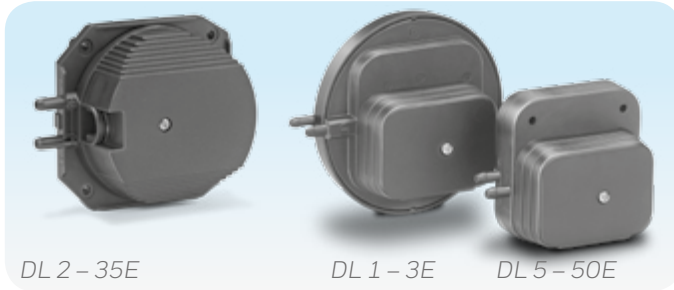

Thanks to its slim design and low adjusting range (20 to 5000 Pa/0.08 to 20 "WC), the fields of application of DL..E include fan monitoring on condensing boiler units or on atmospheric wall-mounted units with flue gas fan. On request, the air pressure switch DL..E can be supplied with only one NO contact, e.g. for a non-interchangeable connection to boiler control systems.

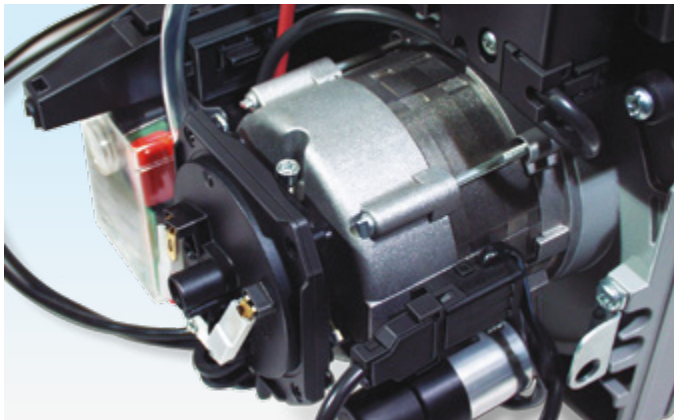

*Pressure switch DL mounted on heating boiler*



*Heating boilers connected in cascade*

## 1.2 Mounting examples

### 1.2.1 Simple mounting

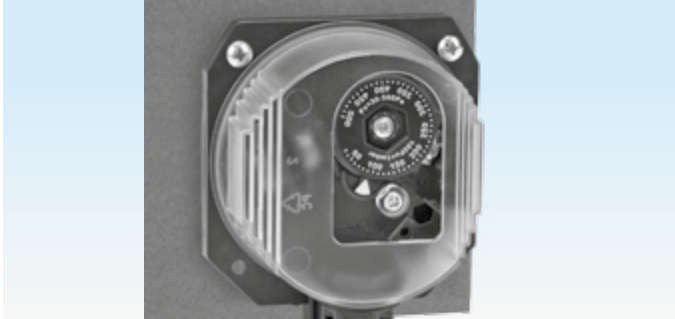

Simple front mounting. Mounting using two screws on the same side is usually sufficient and prevents the pressure switch being subjected to mechanical stress, see page 24 (Project planning information).

### 1.2.2 Mounting without the need for tools or screws

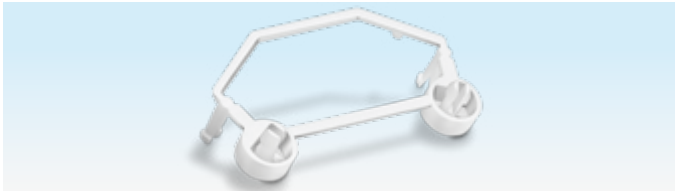

The securing clip S allows the pressure switch to be easily installed and removed. Only two holes in the mounting plate or air duct are required for secure mounting. Securing clip S, see page 26 (Accessories).

### 1.2.3 Pressure-resistant mounting on mounting plate

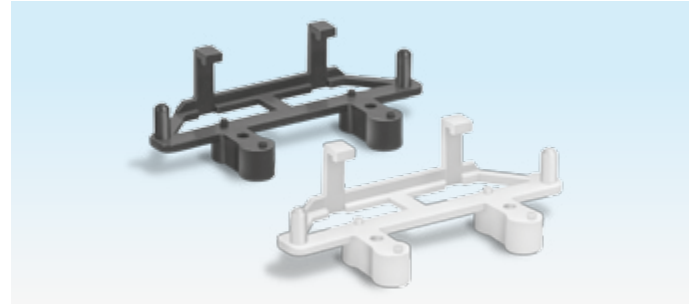

Attach the D clip to the mounting plate with the two screws supplied. Simply push the pressure switch onto the clip. The pressure switch can now be detached again at any time without the need for tools.

To reduce the amount of assembly work required, the pressure switch may, on request, be supplied with the clip already fitted. D clip, see page 26 (Accessories).

### 1.2.4 Rugged, locked mounting

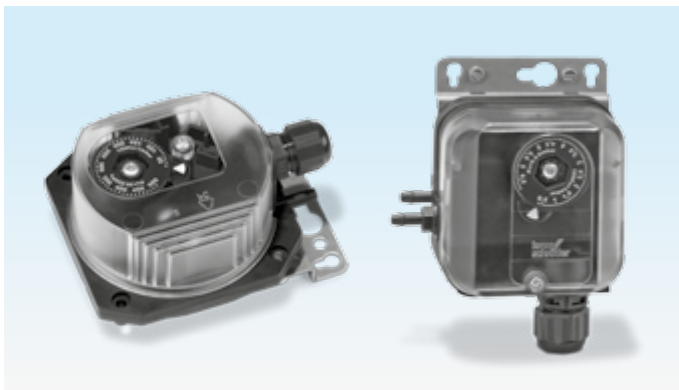
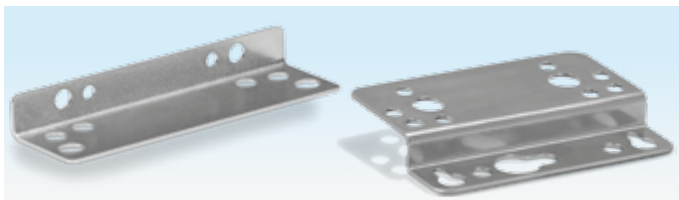

The L-shaped or Z-shaped angle bracket offers diverse mounting options, even with only one screw, and fast installation and removal. The angle bracket increases the distance between the pressure switch and warm boiler walls. Fastening set, see page 26 (Accessories).

### 1.2.5 Mounting directly on the fan motor

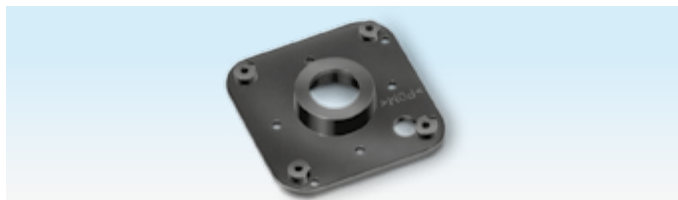

The pressure switch can be installed in a space-saving manner using the motor flange adapter. It is not necessary to drill holes for mounting. Motor flange adapter, see page 26 (Accessories).

### 1.2.6 Protection against pressure surges



The damping nozzle attenuates pressure fluctuations and pressure surges. A brief pressure surge occurs in the air supply line when igniting a burner, for example. Damping nozzle, see page 26 (Accessories).



### 1.2.7 Clearer handling in complex installations

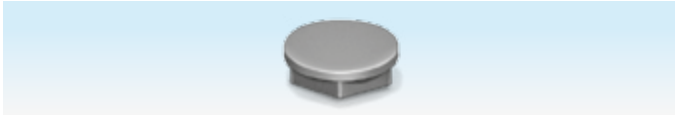

In order to facilitate reading for pressure switches with the same switching point setting, for example, a scale mark can be used. The scale mark can simply be clipped on and is available in different colours as a colour coordination set, see page 26 (Accessories).

### 1.2.8 Tube set with diverse possible applications



Duct connection flanges and angle connectors connect the pressure switch and pressure test point.

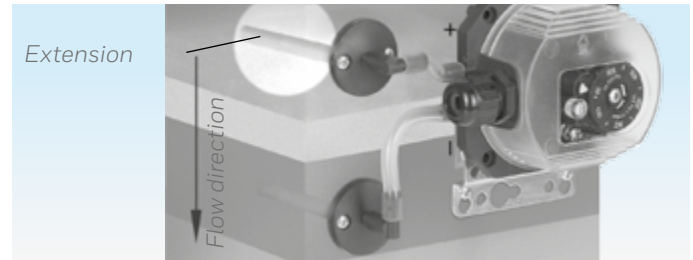
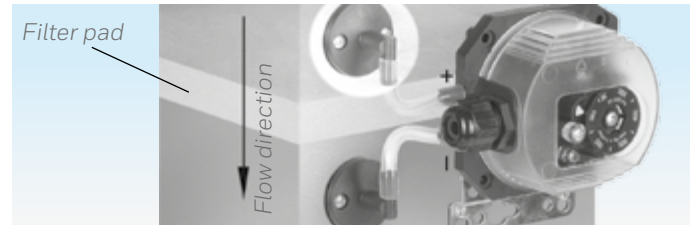

Using the extension, the pressure switch can be used on insulated and lagged ducts.

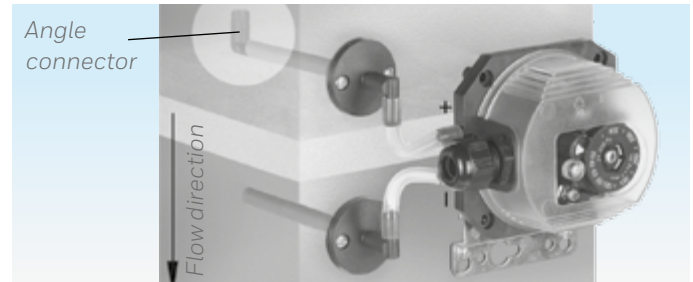

The angle connector reinforces the  $\Delta p$  signal if it is too low for the pressure switch adjusting range.

Tube set, see page 26 (Accessories).

### 1.2.9 Easier diagnosis and maintenance

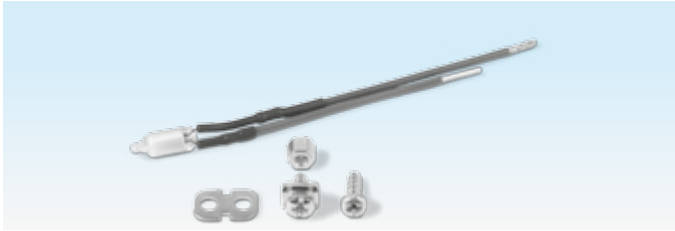

Either a red or a blue pilot lamp, or a red-green LED (24 V/230 V) indicates the switching status of the pressure switch, see page 26 (Accessories).

## 2 Certification

Certificates – see Docuthek

### EU certified pursuant to



Directives:

- Gas Appliances Directive 2009/142/EC (valid until 20 April 2018) in conjunction with EN 1854

### Meets the requirements of the

- Low Voltage Directive (2014/35/EU)

Regulation:

- Gas Appliances Regulation (EU) 2016/426 (valid from 21 April 2018)

### FM approved



Factory Mutual Research Class: 3510 Flow and pressure safety switches. Designed for applications pursuant to NFPA 85 and NFPA 86. [www.approvalguide.com](http://www.approvalguide.com)

### UR recognized

USA and Canada



UL 353 Limit control.

DL...: AMP plug connection, see page 12 (Overview).

Underwriters Laboratories – [www.ul.com](http://www.ul.com) → Tools (at the bottom of the page) → Online Certifications Directory

### UL listed

USA and Canada



UL 353 Limit control.

DL...: electrical connection via screw terminals, see page 12 (Overview).

Underwriters Laboratories – [www.ul.com](http://www.ul.com) → Tools (at the bottom of the page) → Online Certifications Directory

### AGA approved









Australian Gas Association, Approval No.: 5484 – [http://www.aga.asn.au/product\\_directory](http://www.aga.asn.au/product_directory)

### Eurasian Customs Union



The product DL meets the technical specifications of the Eurasian Customs Union.

## 2.1 Overview

	Type
 2014/35/EU	DL 1 - 3E, DL 5 - 50E, DL 2 - 35E, DL 3,3 - 40K, DL 3K, DL 5 - 150K, DL 1,5 - 3A, DL 5 - 150A
 2009/142/EC EN 1854	DL 1 - 3E, DL 5 - 50E, DL 2 - 35E, DL 3,3 - 40K, DL 3K, DL 5 - 150K, DL 1,5 - 3A, DL 5 - 150A
	DL 1 - 3E, DL 5 - 50E, DL 3A, DL 5 - 150A, DL 3K, DL 5 - 150K
	DL 1 - 3E, DL 5 - 50E, DL 2 - 35E, DL 3,3 - 40K, DL 3K, DL 5 - 150K, DL 1,5 - 3A, DL 5 - 150A
	DL 1 - 3ET, DL 5 - 50ET, DL 2 - 35ET, DL 3,5 - 40KT-3, DL 3AT, DL 3KT, DL 5 - 50AT, DL 5 - 50KT
	DL 3AT, DL 5 - 50AT, DL 3,5 - 40KT-3 (except DL 3,3KT-3/DL 5,1KT-3), DL 3KT, DL 5 - 50KT
	DL 2 - 35ET, DL 3,5 - 40KT-1 (except DL 3,3KT-1/DL 5,1KT-1), DL 1 - 3ET, DL 5 - 50ET

\* DL...-3 with screw terminals: UL listed.

\*\* DL...-1 with AMP plugs: UR recognized.

### 3 Function

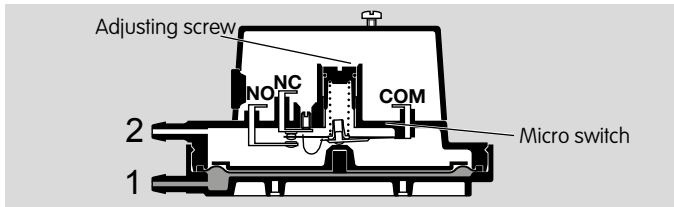
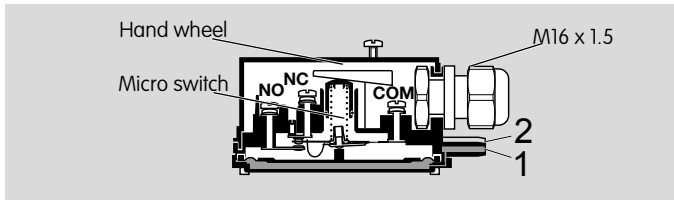

The air pressure switch DL switches in the event of increasing or decreasing pressure. Once the set switching point is reached, a micro switch is activated in the DL.

The switching pressure is adjusted against a spring force using a hand wheel or an adjusting screw.

#### 3.1 Positive pressure measurement

Positive pressure measurement is designed, for example, for checking the fan function or measuring the min./max. pressure.

The positive pressure is measured in the lower diaphragm chamber, port 1. The upper diaphragm chamber is ventilated via port 2.

#### 3.1.1 DL 1,5 A: hand wheel setting in the negative range

The positive pressure is measured in the upper diaphragm chamber, port 2. The lower diaphragm chamber is ventilated via port 1.

#### 3.2 Negative pressure measurement

Negative pressure measurement is designed, for example, for checking air locks or the fan function.

The negative pressure is measured in the upper diaphragm chamber, port 2. The lower diaphragm chamber is ventilated via port 1.

#### 3.2.1 DL 1,5 A: hand wheel setting in the negative range

The negative pressure is measured in the lower diaphragm chamber, port 1. The upper diaphragm chamber is ventilated via port 2.

#### 3.3 Differential pressure measurement

Differential pressure measurement is designed for safeguarding an air flow rate or for monitoring filters and fans, for instance.

The higher absolute pressure is connected to port 1 and the lower absolute pressure to port 2. The remaining ports must be tightly plugged.

### 3.3.1 DL 1,5 A: hand wheel setting in the negative range

The higher absolute pressure is connected to port 2 and the lower absolute pressure to port 1. The remaining ports must be tightly plugged.

### 3.4 Overview: measuring the pressure in the positive and negative ranges

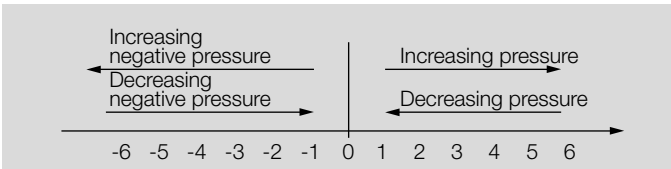

### 3.5 Wiring

When using silicone tubes, only use silicone tubes which have been sufficiently cured. Vapours containing silicone can adversely affect the functioning of electrical contacts. In the case of low switching capacities, such as 24 V, 8 mA, for example, we recommend using an RC module ( $22\ \Omega$ ,  $1\ \mu\text{F}$ ) in air containing silicone or oil.

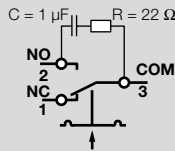

In the case of high humidity or aggressive gas components, we recommend using a pressure switch with gold contact due to its higher resistance to corrosion. Closed-circuit current monitoring is recommended under difficult operating conditions.

#### 3.5.1 Increasing pressure control

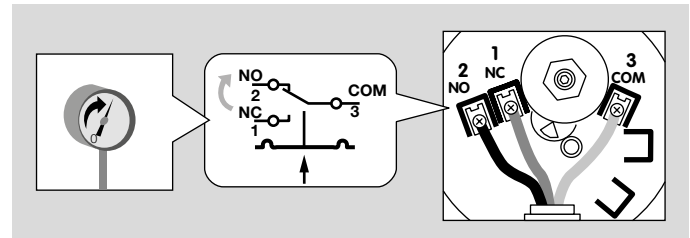

When the set switching point is reached, the contact closes from COM 3 to NO 2. Contact COM 3 to NC 1 is opened. With the NO contact, the NC contact is omitted.

#### 3.5.2 Decreasing pressure control

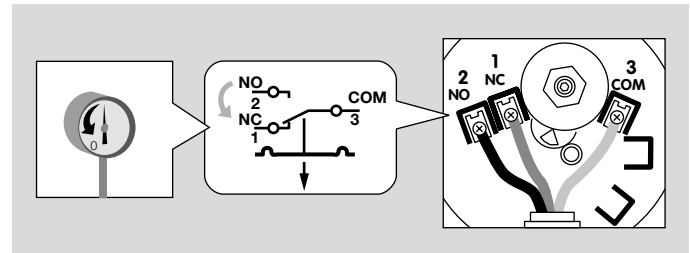

When the set switching point is reached, the contact closes from COM 3 to NC 1. Contact COM 3 to NO 2 is opened. With the NO contact, the NC contact is omitted.

### 3.5.3 DL 1,5A

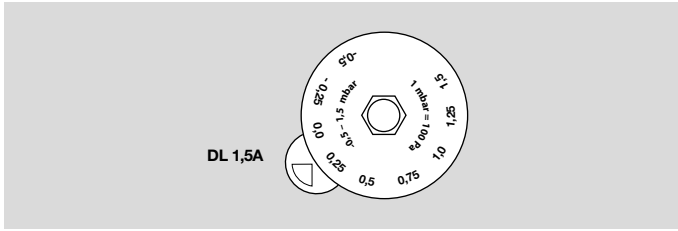

The connection of DL 1,5A depends on the positive or negative adjusting range.

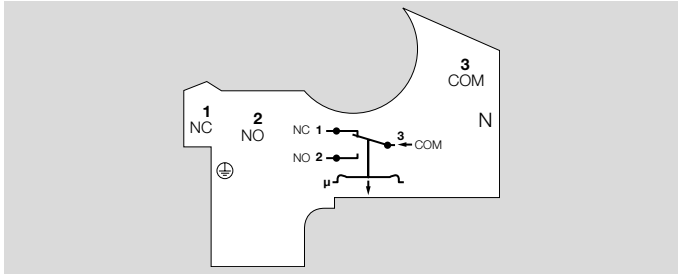

In the negative adjusting range, the template which can be found in the unit displays the connection diagram.

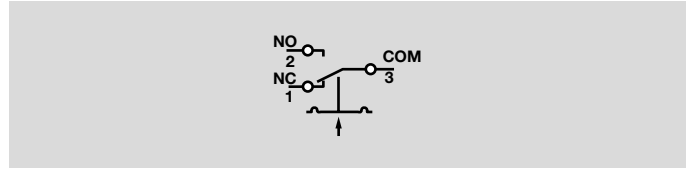

In the positive adjusting range, remove the template and wire the unit as shown in the engraved connection diagram.



### 3.6 DL..A, DL..K, DL..T, DL..KT, DL..AT in Zone 1 (21) and 2 (22) hazardous areas

Pressure switch DL can be used in Zone 1 (21) and 2 (22) hazardous areas if an isolating amplifier is installed upstream in the safe area as “Ex-i” equipment pursuant to EN 60079-11 (VDE 0170-7).

DL as “simple electrical equipment” pursuant to EN 60079-11, Section 5.7, corresponds to the Temperature class T6, Group II. The internal inductance/capacitance is  $L_i = 0.2 \mu\text{H}/C_i = 8 \text{ pF}$ .

The isolating amplifier transfers the DL's signals from the explosion-hazard area to the safe area. Depending on the design of the intrinsically safe circuit, the explosion-hazard area can be monitored for cable faults, cable discontinuities or short-circuits.

Ensure that standard-compliant wiring pursuant to EN 60079 is used.

When operating in Zones 21 and 22, the  $\frac{1}{8}$ " connecting thread or the tube connection for the surrounding air or medium connection must be protected from dirt particles by a separate filter.

#### Intrinsically safe circuit without monitoring for cable faults

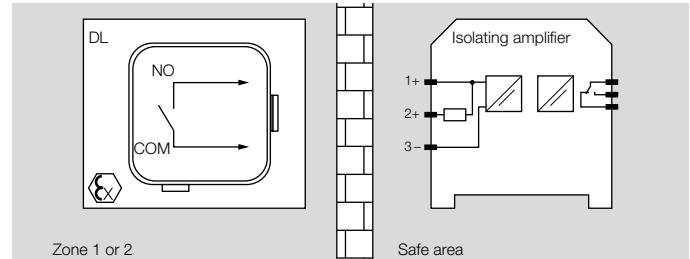

#### Intrinsically safe circuit with monitoring for cable discontinuities

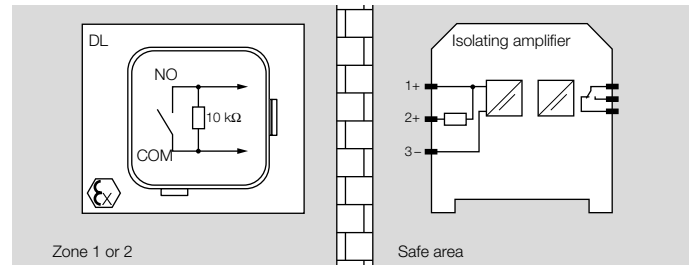

#### Intrinsically safe circuit with monitoring for cable faults and short-circuits

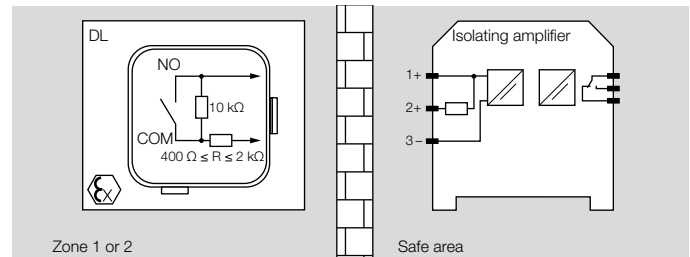

## 3.7 Animation

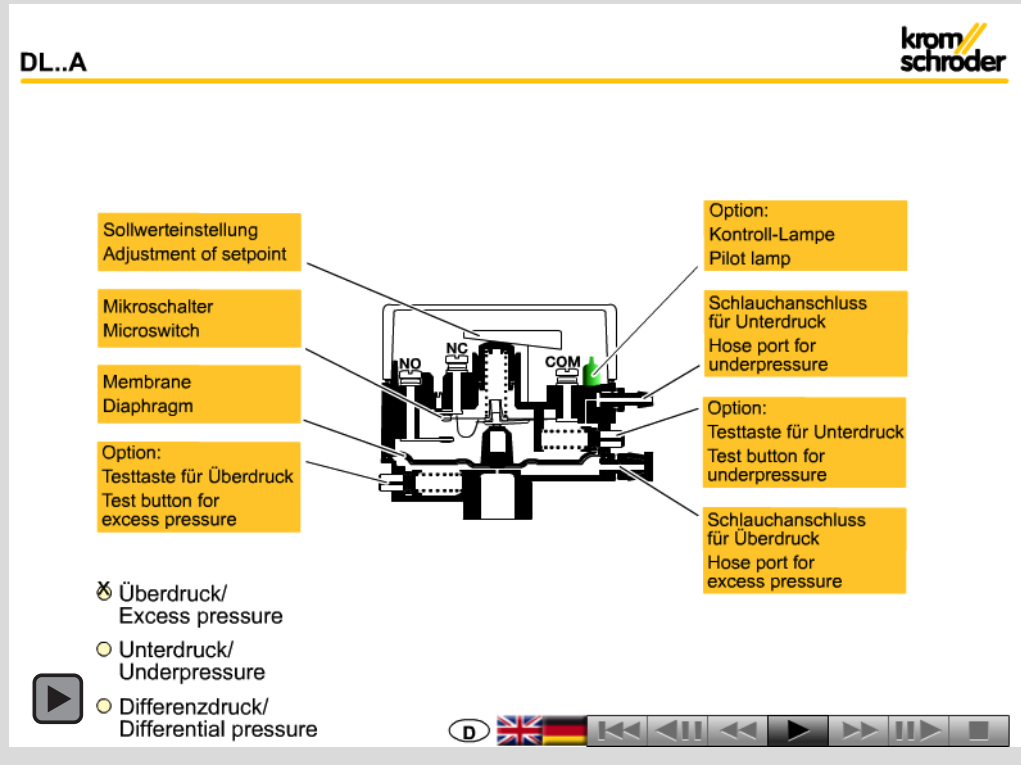

The interactive animation shows the function of the air pressure switch DL..A.

**Click on the picture.** The animation can be controlled using the control bar at the bottom of the window (as on a DVD player).

To play the animation, you will need Adobe Reader 7 or a newer version. If you do not have Adobe Reader on your system, you can download it from the Internet. If the animation does not start to play, you can download it from the document library (Docuthek) as an independent application.

## 4 Selection

Type	Frequent application			Version											Mounting			Accessories		Enclosure [IP]						
	Air-conditioning systems and kitchens	Condensing boilers	Laboratories, industrial firing systems, butterfly valves for air and fire dampers	Adjusting range in Pascal	Adjusting range in mbar	Hand wheel	Adjusting screw	Screw terminals	AMP plugs	Tube connection	Threaded connection	Pilot lamp/Pilot LED	Standard socket set	Test key in lower chamber	Test key in upper chamber	Measuring instrument/pressure signal connection	Securing clip S	Securing clip D	L-angle bracket	Z-angle bracket	U-angle bracket	External adjustment	Tube set	Motor flange adapter	Standard	Maximum*
DL 3,3 - 40K	●			●		●		●	○	●		○	○				○	○	○	○			○	○	54	54
DL 2 - 35E		●		●			●		●	●							○	○	○	○			○	○	10/21	44
DL 1,5 - 3A			●	○	●	●		●		●	●	○	○						○	○	○	○	○	○	54	65
DL 5 - 150A			●	○	●	●		●		●	●	○	○	●	○				○	○	○	○	○	○	54	65
DL 10 - 150AH/..AN		●	●	○	●	●		●		●	●	○	○		○				○	○	○	○	○	○	54	65
DL 3K	●		●	○	●	●		●		●		○	○						●	○	○	○	○	○	54	65
DL 5 - 150K	●		●	○	●	●		●		●		○	○						●	○	○	○	○	○	54	65
DL 10 - 150KH/..KN		●	●	○	●	●		●		●		○	○						●	○	○	○	○	○	54	65
DL 1 - 3E		●		○	●		●		●	●									○	○			○	○	10/21	44
DL 5 - 50E		●		○	●		●		●	●						○			○	○			○	○	10/21	44

● = standard, ○ = available

\* The enclosure depends on the version, installation position and whether a cable grommet is being used.

## 4.1 DL 3,3 – 40K selection table

Type	3,3 <sup>1)</sup>	3,5	4,5	5,1 <sup>1)</sup>	8	11	16	24	40	K	T	G	-1 <sup>2)</sup>	-3 <sup>3)</sup>	K2	N	T	T2	W
DL	●	●	●	●	●	●	●	●	●	●	●	●	○	●	○	○	○	○	○

Order example

DL 8KG-3

<sup>1)</sup> Not available as a T-product.

<sup>2)</sup> DL..KT-1 with AMP plugs: UR recognized.

<sup>3)</sup> DL..KT-3 with screw terminals: UL listed.

● = standard, ○ = available

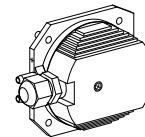

### 4.1.1 Type code

Code	Description
DL	Pressure switch for air
	Adjusting range
3,3	20 – 330 Pa
3,5	30 – 350 Pa
4,5	30 – 500 Pa
5,1	100 – 510 Pa
8	50 – 800 Pa
11	100 – 1100 Pa
16	400 – 1600 Pa
24	200 – 2400 Pa
40	500 – 4000 Pa
K	Tube connection and hand wheel for adjustment
T	T-product
G	Gold contacts
-1	AMP plug connection
-3	Electrical connection via screw terminals
K2	Red/green pilot LED, 24 V DC/AC
N	Blue pilot lamp, 120 V AC
T	Blue pilot lamp, 230 V AC
T2	Red/green pilot LED, 230 V AC
W	Z-angle bracket

### 4.1.2 Electrical connection

DL..K-1 for wiring with AMP plugs

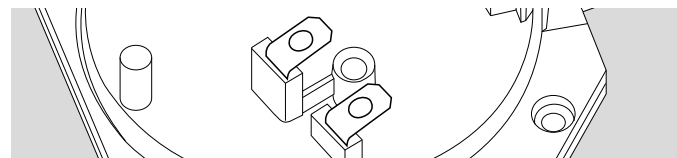

DL..K-3 for wiring via screw terminals

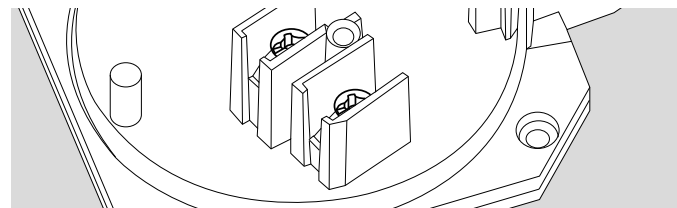

Switching point and switching differential, see page 33 (Adjusting range, switching differential).

## 4.2 DL 2 – 35E selection table

Type	2 <sup>1)</sup>	4	14	35	EH	E	T	G	-1	W
DL	●	●	●	●	○	●		●	●	○

1) Switching point 20 – 30 Pa when installed upside down.

● = standard, ○ = available

Order example

DL 4EHG-1

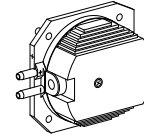

### 4.2.1 Type code

Code	Description
DL	Pressure switch for air
	Adjusting range
2 <sup>1)</sup>	20 – 200 Pa
4 <sup>1)</sup>	50 – 400 Pa
14	300 – 1400 Pa
35	1200 – 3500 Pa
EH	With flat plugs, tube connection, adjusting screw, -40 to +110°C
E	-20 to +85°C
T	T-product
G	Gold contacts
-1	AMP plug connection
W	Z-angle bracket

1) Adjusting range: DL..2EH: 45 – 200 Pa, DL..4EH: 70 – 400 Pa.

Switching point and switching differential, see page 40 (Adjusting range, switching differential).

### 4.2.2 Electrical connection

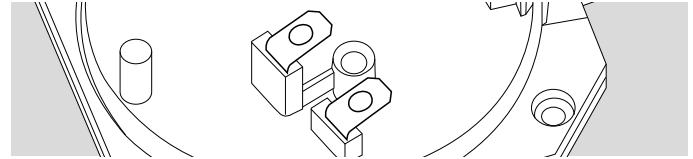

Wiring with AMP plugs

### 4.2.3 Switching differential/switching point depends on installation position

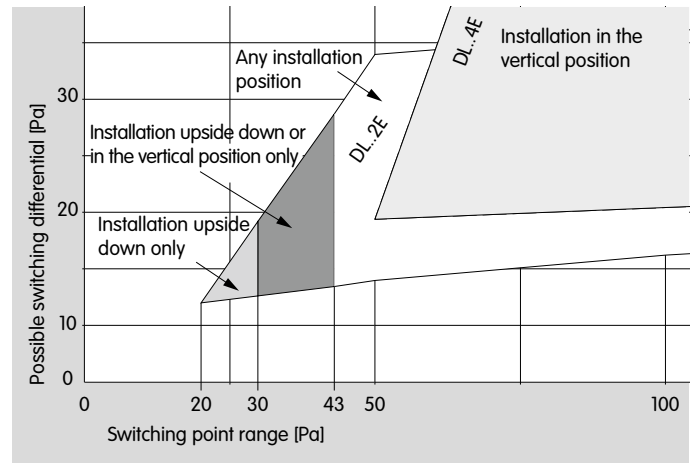

### 4.3 DL 1,5 – 150A, DL 3 – 150K, DL 10 – 150AH/..AN, DL 10 – 150KH/..KN selection table

Type	1,5 <sup>1)2)</sup>	3	5	10	30	50	150 <sup>2)</sup>	K	A	T	H <sup>6)</sup>	N <sup>6)</sup>	G	-3 <sup>3)</sup>	-4 <sup>3)</sup>	-5 <sup>3)</sup>	-6 <sup>3)</sup>	-9 <sup>3)</sup>	K2	T	T2	N	P <sup>4)</sup>	1 <sup>5)</sup>	2 <sup>5)</sup>	A	W	
DL	●	●	●	●	●	●	●	●	●	●	●	●	●	●	○	○	○	○	○	○	○	○	○	○	○	○	○	○

<sup>1)</sup> Only available as DL..A.    <sup>2)</sup> Not available as a T-product.

<sup>3)</sup> DL..KT-3 with screw terminals: UL listed.

<sup>4)</sup> Only for DL 5 – 150K.

<sup>5)</sup> Only for DL 5 – 150A.

<sup>6)</sup> Only for DL..10, ..50, ..150.

● = standard, ○ = available

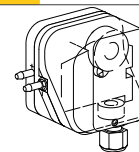

Order example

DL 150K-3T

#### 4.3.1 Type code

Code	Description
DL	Pressure switch for air
	Adjusting range
1,5	-0.5 – 1.5 mbar
3 <sup>1)</sup>	0.2 – 3 mbar
5 <sup>1)</sup>	0.4 – 5 mbar
10	1 – 10 mbar
30	2.5 – 30 mbar
50	2.5 – 50 mbar
150	30 – 150 mbar
K	With tube connection and hand wheel
A	Additionally with Rp 1/4 (NPT 1/4) connection (optional: Rp 1 1/8 (NPT 1 1/8))
T	T-product
H	Locks off with rising pressure
N	Locks off with falling pressure
G	Gold contacts
	Electrical connection
-3	via screw terminals
-4	via screw terminals, IP 65
-5	with 4-pin plug, without socket
-6	with 4-pin plug, with socket
-9	with 4-pin plug, with socket, IP 65
K2	Red/green pilot LED, 24 V DC/AC
T	Blue pilot lamp, 230 V AC
T2	Red/green pilot LED, 230 V AC
N	Blue pilot lamp, 120 V AC
P	With test tapping point
1	With 1 test key (lower chamber +)
2	With 2 test keys (upper chamber -, lower chamber +)
A	External adjustment
W	Z-angle bracket

<sup>1)</sup> Adjusting range: DL..3AT: 0.3 – 3 mbar, DL 5AT and DL 5KT: 0.5 – 5 mbar.

Switching point and switching differential, see page 36 (Adjusting range, switching differential).

#### 4.3.2 Electrical connection

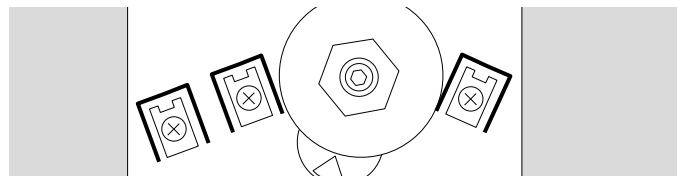

Wiring via screw terminals

#### 4.3.3 Test key

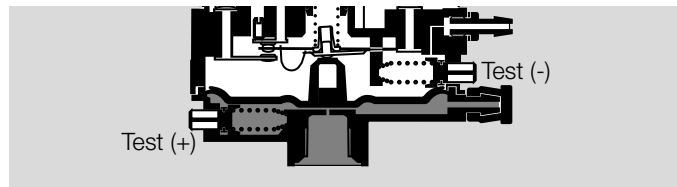

DL 5 – 150A..1: test key in lower chamber (+) or  
DL 5 – 150A..2: test key in lower chamber (+) and upper chamber (-).

## 4.4 DL 1 – 50E selection table

Type	1	3	5	10	50	E	T	G	-1 <sup>1)</sup>	P	W
DL	●	●	●	●	●	●	●	●	●	●	○

<sup>1)</sup> DL...ET with AMP plugs: UR recognized.

● = standard, ○ = available

### 4.4.1 Type code

Code	Description
DL	Pressure switch for air
	Adjusting range
1	0.2 – 1 mbar
3	0.3 – 3 mbar
5 <sup>1)</sup>	0.4 – 5 mbar
10	1.0 – 10 mbar
50	2.5 – 50 mbar
E	With flat plugs, tube connection, adjusting screw
T	T-product
G	Gold contacts
-1	AMP plug connection
P	With test tapping point
W	Z-angle bracket

<sup>1)</sup> DL...5ET: adjusting range 0.5 – 5 mbar.

Switching point and switching differential, see page 38 (Adjusting range, switching differential).

### Order example

DL 50EG-1

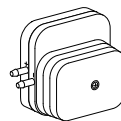

### 4.4.2 Electrical connection

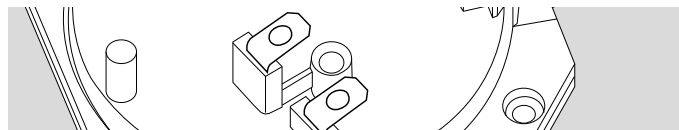

DL...E-1 for wiring with AMP plugs

### 4.4.3 Test tapping point

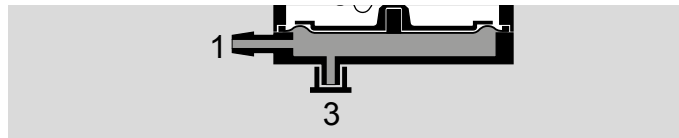

DL 5 – 50E-1P: a measuring instrument can be connected to port **3** or the boiler pressure can be queried. If port **3** is used for pressure measurement, the sealing cap must be transferred from port **3** to **1**.

## 5 Project planning information

### 5.1 Pressure switch with NBR diaphragm

Continuous operation at high temperatures (e.g. maximum ambient temperature) accelerates the ageing of elastomer materials and reduces the service life (please contact manufacturer). Ozone concentrations exceeding  $200 \mu\text{g}/\text{m}^3$  accelerate the ageing of elastomer materials and reduce the service life.

### 5.2 Installation

Protect the connections against dirt or moisture in the medium to be measured or the surrounding air. If necessary, install a filter.

When installing outdoors, place the DL in a roofed area and protect from direct sunlight (even IP 65 version). To avoid condensation, the cover with pressure equalization element can be used on some types, see page 29 (Pressure equalization element).

In case of highly fluctuating pressures, install a damping nozzle or restrictor orifice, see pages 28 (Damping nozzle) and 29 (Restrictor orifice).

In the case of an uneven mounting surface, secure the pressure switch to the mounting plate or air duct with only two screws on the same side in order to avoid subjecting the pressure switch to mechanical stress.

### Installation position

Condensation must not be allowed to get into the housing (if possible, install pipework with an ascending gradient). Otherwise, there is a risk of icing of condensation at subzero temperatures, the switching point shifting or corrosion in the device which can lead to malfunctions.





Installation in the vertical or horizontal position, or upside down, preferably with vertical diaphragm.





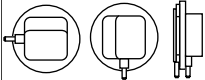

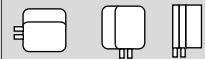
If installed in a vertical position, the switching point  $p_S$  will correspond to the scale value SK. If installed in another position, the switching point  $p_S$  will change and no longer correspond to the set scale value SK. Switching point  $p_S$  must be checked.

	$p_S = SK$			SK + 13 Pa [+ 0.052 "WC]	SK - 13 Pa [- 0.052 "WC]	
DL 3,3 - 40K						LSR
DL 2 - 35E						

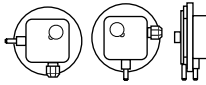

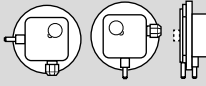
## Project planning information

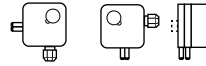
	$p_s = SK$	SK + 18 Pa [+ 0.071 "WC]	SK - 18 Pa [- 0.071 "WC]	
DL 1E, DL 3E				NBR
DL 5E, DL 10E, DL 50E				

	$p_s = SK$	SK + 0,18 mbar [+ 0.071 "WC]	SK - 0,18 mbar [- 0.071 "WC]	
DL 1,5A		 e.g. SK = -0.5: $p_s = -0.5 + 0.18$ $p_s = -0.32$ mbar		NBR
DL 3K, DL 3A				
DL 5-150A, DL 5-150K				

## 6 Accessories

### 6.1 Securing clip S

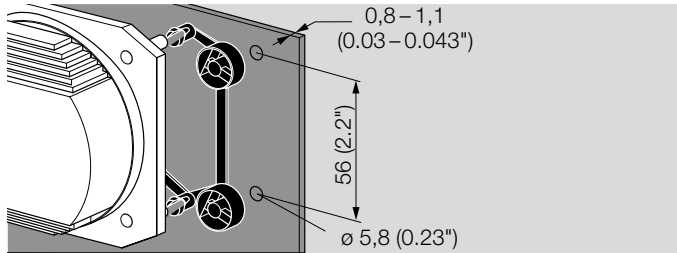

For DL 2 – 35E and DL 3,3 – 40K:

Only two holes in the mounting plate or air duct are required for secure mounting. Order No.: 34335764.

### 6.2 Securing clip D

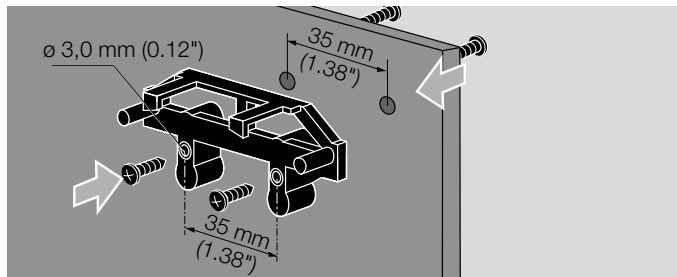

For pressure-resistant mounting, the D clip is fitted to the mounting plate from the front or from the back. Simply push the pressure switch onto the clip.

For DL 2 – 35E, DL 3,3 – 40K:

For attachment to the side of the pressure port, white clip, Order No.: 74921513.

For attachment to the three other sides, blue clip, Order No.: 74921512.

### 6.3 L-angle bracket

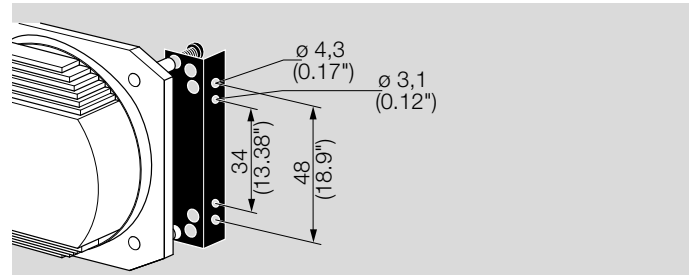

For DL 2 – 35E and DL 3,3 – 40K: shape A, Order No.: 74919825.

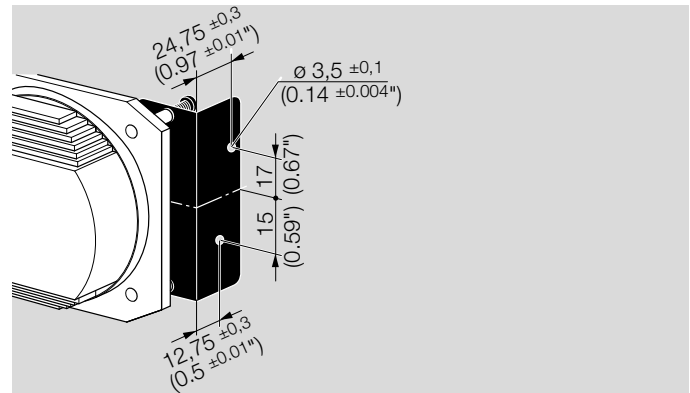

For DL 2 – 35E and DL 3,3 – 40K: shape B, Order No.: 74921466.

## 6.4 Z-angle bracket

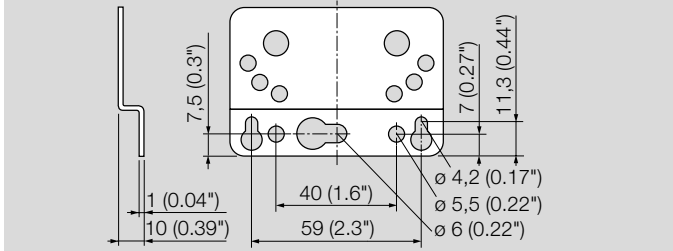

For DL 2 – 35E and DL 3,3 – 40K: Order No.: 74919824,  
 DL 5 – 50E and DL 5 – 150K: Order No.: 74916158,  
 DL 3 – 150A, DL 3K and DL 1 – 3E: Order No.: 74913661.

## 6.5 U-angle bracket

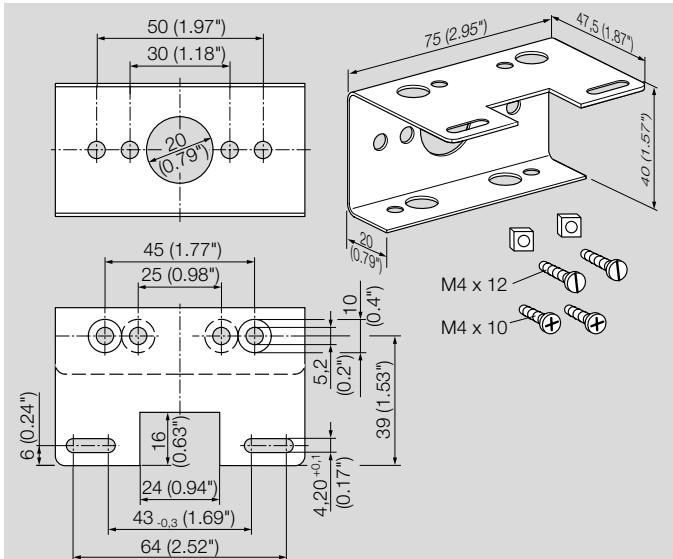

For DL 1,5 – 150A, DL 3 – 150K, DL 1 – 50E:  
 Order No.: 74916185.

## 6.6 Tube set

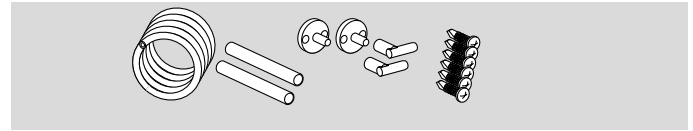

Tube set, including angle connectors and extension:  
 Order No.: 74919272.

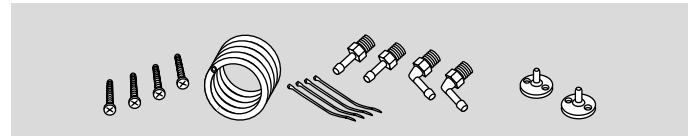

Tube set with 2 m PVC tube, 2 duct connection flanges  
 with screws, R ¼ and R ⅓ connecting nipples:  
 Order No.: 74912952.

## 6.7 Pilot lamp set, red or blue

For DL..K and DL..A

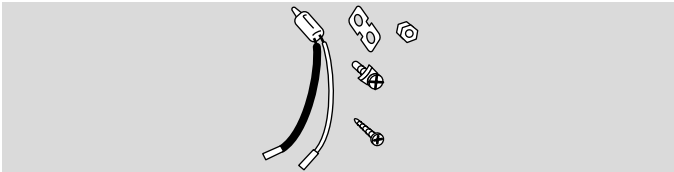

Pilot lamp, red:

110/120 V AC, I = 1.2 mA, Order No.: 74920430,  
220/250 V AC, I = 0.6 mA, Order No.: 74920429.

Pilot lamp, blue:

110/120 V AC, I = 1.2 mA, Order No.: 74916121,  
220/250 V AC, I = 0.6 mA, Order No.: 74916122.

## 6.8 LED set, red/green

For DL..K and DL..A

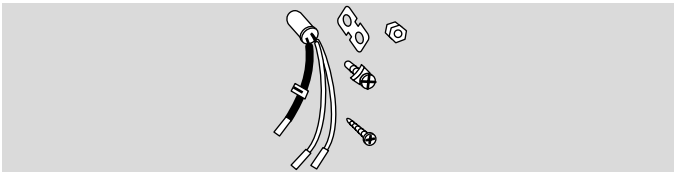

24 V DC, I = 16 mA; 24 V AC, I = 8 mA, Order No.:  
74921089,

230 V AC, I = 0.6 mA, Order No.: 74923275.

## 6.9 Standard socket set

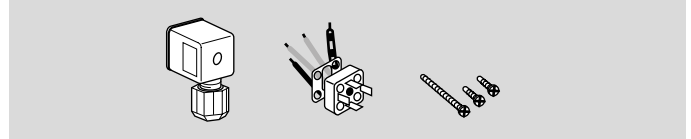

DL..A, DL..K: Order No.: 74916159.

## 6.10 Motor flange adapter

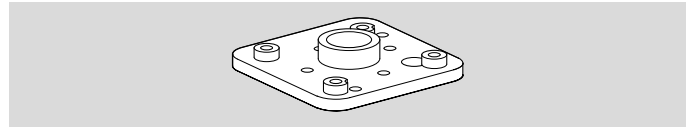

DL 5 – 50E, Order No.: 74916149,

DL 1 – 3E, DL 3 – 150A, DL 3 – 5K, Order No.: 74916157,

DL 5 – 150K, Order No.: 74916156,

DL 2/4/14/35E, DL 3,5/4,5/8/16/24/40K,  
Order No.: 74920415.

## 6.11 Damping nozzle

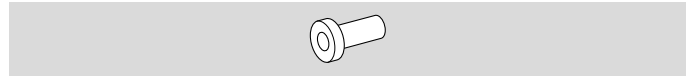

In the case of high pressure fluctuations, we recommend using a damping nozzle for tube connections:  $\varnothing = 0.8 \text{ mm (0.03")}$ , Order No.: 35451346.

## 6.12 Restrictor orifice

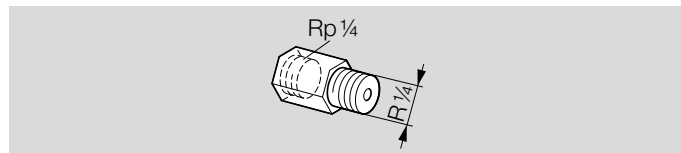

In the case of high pressure fluctuations, we recommend using a restrictor orifice (contains non-ferrous metals) for Rp 1/4 threaded connections:

Hole diameter 0.2 mm, Order No.: 75456321,

hole diameter 0.3 mm, Order No.: 75441317.

## 6.13 Colour coordination set

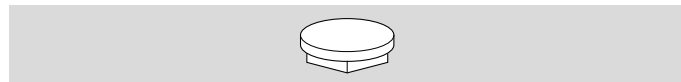

The scale mark is available in each case as a 5-piece set.

Colour coordination set, blue, Order No.: 74921726,

Colour coordination set, yellow, Order No.: 74921727.

## 6.14 External adjustment



In order to set the switching pressure from the outside, the cover for external adjustment (6 mm Allen key) for DL 1,5 – 150A, DL 3 – 150K can be retrofitted.

Order No.: 74916155.

## 6.15 Pressure equalization element

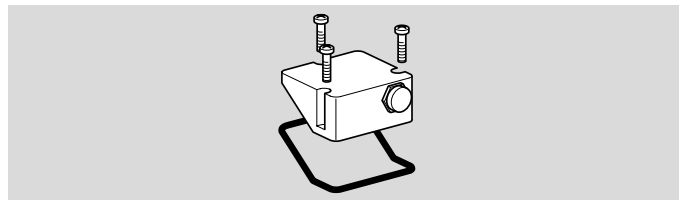

To avoid the formation of condensation, the cover with pressure equalization element can be used. The diaphragm in the screw connector is designed to ventilate the cover, without allowing water to enter.

Order No.: 74923391.

## 6.16 Grommet

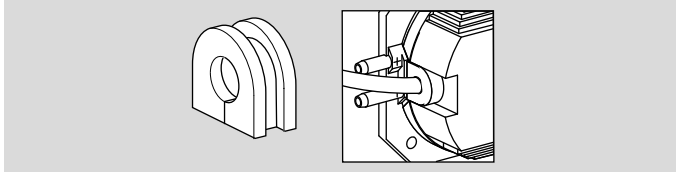

Grommet for enclosure IP 44.

DL 2/4/14/35E: Order No.: 34919801.

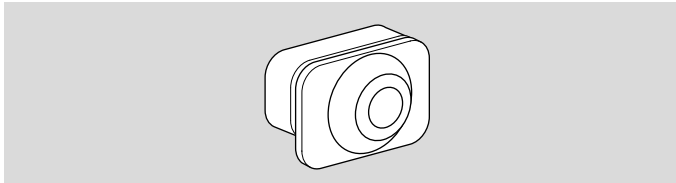

Grommet for enclosure IP 42.

DL 1/3/5/10/50E: Order No.: 34328197.

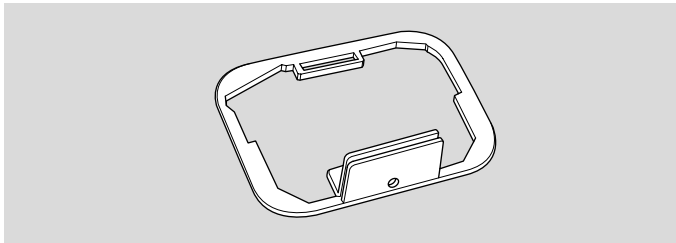

Grommet for enclosure IP 44.

DL 1/3/5/10/50E: Order No.: 34330703.

## 7 Technical data

Gas types: air or flue gas, no flammable gases, no aggressive gases.

Micro switch to EN 61058-1,  
switching capacity:

DL..: 24 V (min. 0.05 A) to 250 V AC  
(max. 5 A, with  $\cos \varphi = 0.6$  = 1 A),

DL..G: 5 V (min. 0.01 A) to 250 V AC  
(max. 5 A, with  $\cos \varphi = 0.6$  = 1 A),  
5 V (min. 0.01 A)  
to 48 V DC (max. 1 A),

DL..T: 30 – 240 V AC, 50/60 Hz,  
5 A resistive or  
0.5 A inductive ( $\cos \varphi = 0.6$ ),

DL..TG: < 30 V AC/DC,  
0.1 A resistive or  
0.05 A inductive ( $\cos \varphi = 0.6$ ).

If the DL..G (DL..TG) has switched a voltage > 24 V (> 30 V) and a current > 0.1 A at  $\cos \varphi = 1$  or > 0.05 A at  $\cos \varphi = 0.6$  once, the gold plating on the contacts will have been burnt through. It can then only be operated at this power rating or higher power rating.

Contact gap < 3 mm ( $\mu$ ).

Safety class II to VDE 0106-1.

### 7.1 DL..K

Enclosure to IEC 60529: IP 54.

Diaphragm pressure switch, tempered LSR diaphragm system.

Housing: glass fibre reinforced PBT plastic with low gas release.

Max. inlet pressure  $p_{max.}$  = withstand pressure: 5 kPa,  
differential pressure: 5 kPa.

Permitted ambient temperature in operation:

DL..K: -20 to +85°C (-4 to +185°F),

DL..KT: -40 to +60°C (-40 to +140°F).

Storage and transport temperature:

-20 to +40°C (-4 to +104°F).

Line diameter: 0.5 to 1.8 mm (AWG 24 to AWG 13).

Line entrance: M16 x 1.5, clamping range:  
diameters of 4 to 10 mm.

Electrical connection type: screw terminals.

Recommended tightening torque:

Component	Tightening torque [Ncm]
Cover screw	60
M16 x 1.5 cable gland	50
Clamping terminal screws	80

Weight: 125 g (4.4 oz).



### 7.1.1 Dimensions

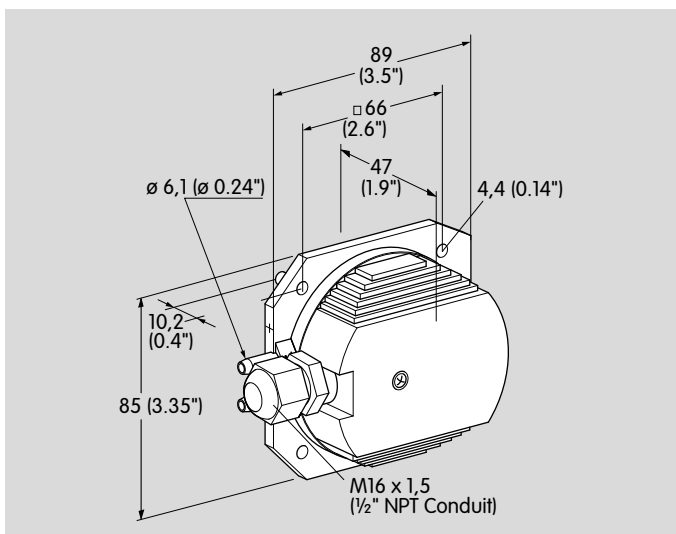

### 7.1.2 Adjusting range, switching differential

Type	Adjusting range				Mean switching differential at min. and max. setting				Deviation from the switching point during testing pursuant to EN 1854 or by agreement	
	Pa		"WC		Pa		"WC			
	min.	max.	min.	max.	min.	max.	min.	max.		
DL 3,3K	20	330			8	20			± 7 Pa/± 15%	
DL 3,5K, DL 3,5KT	30	350	0.12	1.4	10	20	0.04	0.08	± 5 Pa/± 15%	± 0.02 "WC/± 15%
DL 4,5K, DL 4,5KT	30	500	0.12	2	12	25	0.05	0.10	± 5 Pa/± 15%	± 0.02 "WC/± 15%
DL 5,1 K	100	510			15	30			± 15%	
DL 8K, DL 8KT	50	800	0.20	3.2	17	30	0.07	0.12	± 14 Pa/± 15%	± 0.06 "WC/± 15%
DL 11K, DL 11KT	100	1100	0.4	4.4	20	35	0.08	0.14	± 20 Pa/± 15%	± 0.08 "WC/± 15%
DL 16K, DL 16KT	400	1600	1.6	6.4	30	40	0.12	0.16	± 15%	± 15%
DL 24K, DL 24KT	200	2400	0.8	9.6	45	55	0.18	0.22	± 40 Pa/± 15%	± 0.16 "WC/± 15%
DL 40K, DL 40KT	500	4000	2.0	16.0	70	90	0.28	0.36	± 15%	± 15%

## 7.2 DL..A, DL..K, DL..AH/..AN, DL..KH/..KN

Diaphragm pressure switch, silicone-free.

Enclosure to IEC 60529: IP 54, IP 65.

Diaphragm: NBR.

Max. inlet pressure  $p_{max}$  = withstand pressure, differential pressure: see table.

Permitted ambient temperature in operation:

DL..A, DL..K:

-20 to +80°C (-4 to +176°F),

DL..AH/..AN, DL..KH/..KN:

-15 to +60 °C (+5 to + 140 °F)

DL..T:

-40 to +60°C (-40 to +140°F).

Long-term use in the upper ambient temperature range accelerates the ageing of the elastomer materials and reduces the service life (please contact manufacturer).

Storage and transport temperature:

-20 to +40°C (-4 to +104°F).

Line diameter: 0.5 to 1.8 mm (AWG 24 to AWG 13).

Line entrance: M16 x 1.5, clamping range: diameters of 4 to 10 mm.

Weight:

approx. 200 g (7 oz).

Electrical connection type: screw terminals.

Recommended tightening torque:

Component	Tightening torque [Ncm]
Cover screws	65
M16 x 1.5 cable gland	50
Rp ¼ air connection	600
Rp ⅛ air connection, switch housing	250
Clamping terminal screws	80

7.2.1 Dimensions

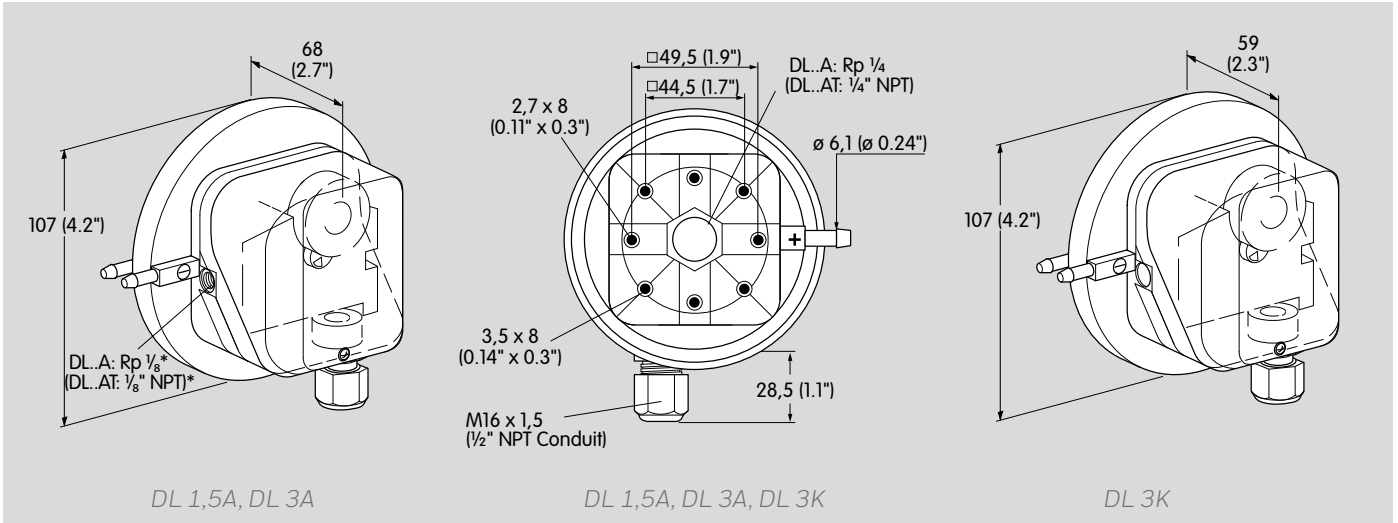

\* optional

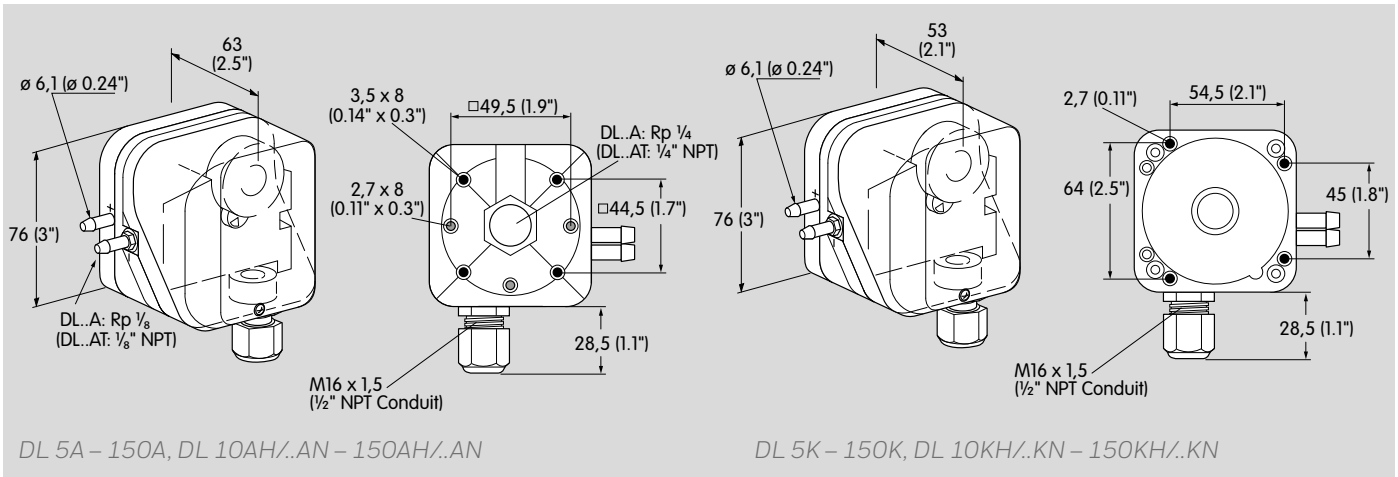

## 7.2.2 Adjusting range, switching differential

Type	Adjusting range (adjusting tolerance $\pm 15\%$ of the scale value, but min. $\pm 8$ Pa)				Max. inlet pressure = withstand pressure		Mean switching differential at min. and max. setting				Deviation from the switching point during testing pursuant to EN 1854 Air pressure switches
	mbar		"WC		mbar	"WC	mbar		"WC		
	min.	max.	min.	max.			min.	max.	min.	max.	
DL 1,5A	-0.5	1.5			50		0.1	0.16			$\pm 15\%$ or $\pm 6$ Pa
DL 3A, DL 3K	0.2	3	0.08	1.2	50	20	0.1	0.16	0.04	0.06	$\pm 15\%$ or $\pm 6$ Pa [ $\pm 0.02$ "WC]
DL 3AT, DL 3KT	0.3	3	0.12	1.2	150	58.5	0.1	0.16	0.04	0.06	$\pm 15\%$ or $\pm 6$ Pa [ $\pm 0.02$ "WC]
DL 5A, DL 5K	0.4	5			300		0.2	0.3			$\pm 15\%$ oder $\pm 4$ Pa
DL 5AT, DL 5KT	0.5	5	0.2	2	300	117	0.2	0.3	0.08	0.12	$\pm 15\%$ or $\pm 4$ Pa [ $\pm 0.016$ "WC]
DL 10A, DL 10KT, DL 10A, DL 10KT	1	10	0.4	4	300	117	0.25	0.4	0.1	0.16	$\pm 15\%$ or $\pm 4$ Pa [ $\pm 0.016$ "WC]
DL 30A, DL 30K	2.5	30			300		0.35	0.9			$\pm 15\%$ or $\pm 4$ Pa
DL 50A, DL 50K, DL 50AT, DL 50KT	2.5	50	1	20	300	117	0.8	1.5	0.3	0.6	$\pm 15\%$ or $\pm 4$ Pa [ $\pm 0.016$ "WC]
DL 150A, DL 150K	30	150			300		3	5			$\pm 15\%$ or $\pm 4$ Pa

Type	Adjusting range*		Mean switching differential at min. and max. setting		Max. inlet pressure $p_{max.}$ = withstand pressure		Difference between switching pressure and possible reset		Deviation from the switching point during testing pursuant to EN 1854	
	mbar	"WC	mbar	"WC	mbar	"WC	mbar	"WC	Gas pressure switch	Air pressure switch
									$\pm 15\%$	$\pm 15\%$
DL 10A, DL 10K	1 - 10	0.4 - 4	-	-	300	117	0.4 - 1	0.16 - 0.4	$\pm 15\%$	$\pm 15\%$
DL 50A, DL 50K	2.5 - 50	1 - 20	-	-	300	117	1 - 2	0.4 - 0.8	$\pm 15\%$	$\pm 15\%$
DL 150A, DL 150K	30 - 150	12 - 60	-	-	300	117	2 - 5	0.8 - 2	$\pm 15\%$	$\pm 15\%$

\* Adjusting tolerance =  $\pm 15\%$  of the scale value.

### 7.3 DL 1E – DL 50E

Enclosure to IEC 60529:

IP 10 = any installation position,

IP 21 = electrical connection from below,

IP 42/44 = with cable grommet, see page 26 (Accessories).

Diaphragm: NBR.

Max. inlet pressure  $p_{max.}$  = withstand pressure, differential pressure: see table.

Permitted ambient temperature in operation:

-20 to +80°C (-4 to +176°F),

DL..T: -40 to +60°C (-40 to +140°F).

Long-term use in the upper ambient temperature range accelerates the ageing of the elastomer materials and reduces the service life (please contact manufacturer).

Storage and transport temperature:

-20 to +40°C (-4 to +104°F).

Weight:

approx. 130 g (4.5 oz).

Recommended tightening torque:

Component	Tightening torque [Ncm]
Cover screw	50
Strain relief facility	60

### 7.3.1 Dimensions

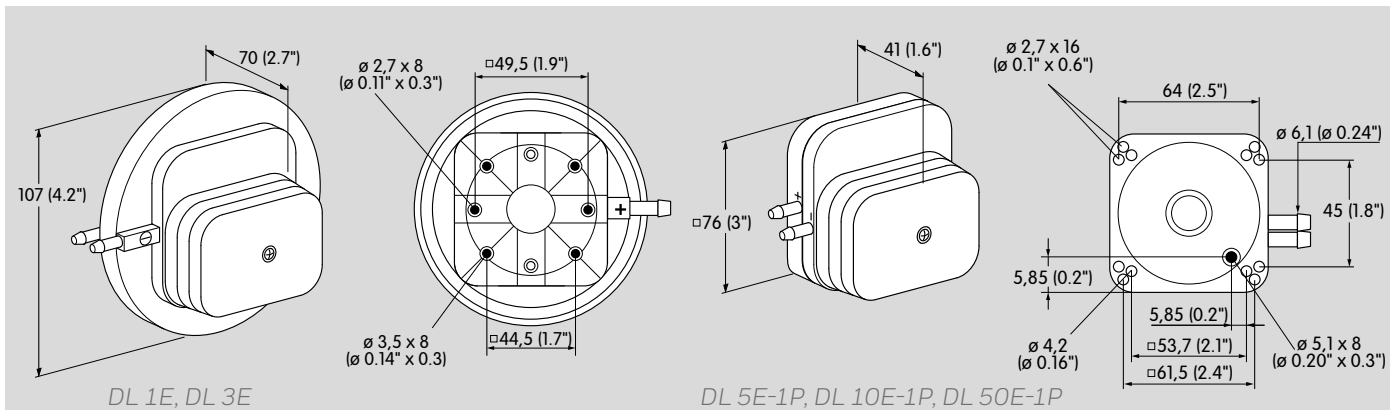

### 7.3.2 Adjusting range, switching differential

Type	Adjusting range (adjusting tolerance $\pm 15\%$ of the scale value)				Max. inlet pressure = withstand pressure		Mean switching differential at min. and max. setting or by agreement				Deviation from the switching point during testing pursuant to EN 1854 Air pressure switches
	mbar		"WC		mbar	"WC	mbar		"WC		
	min.	max.	min.	max.			min.	max.	min.	max.	
DL 1E, DL 1ET	0.2	1	0.08	0.4	50	20	0.1	0.15	0.04	0.06	$\pm 15\%$ or $\pm 5$ Pa [ $\pm 0.02$ "WC]
DL 3E, DL 3ET	0.3	3	0.12	1.2	50	20	0.2	0.3	0.08	0.12	$\pm 15\%$ or $\pm 6$ Pa [ $\pm 0.02$ "WC]
DL 5E	0.4	5			300		0.25	0.4			$\pm 15\%$
DL 5ET	0.5	5	0.2	2	300	117	0.25	0.4	0.01	0.16	$\pm 15\%$
DL 10E, DL 10ET	1	10	0.4	4	300	117	0.3	0.4	0.12	0.16	$\pm 15\%$
DL 50E, DL 50ET	2.5	50	1	20	300	117	0.5	1.3	0.2	0.5	$\pm 15\%$

## 7.4 DL 2E – DL 35E

Enclosure to IEC 60529:

IP 00 = without cover,

IP 10 = any installation position with cover,

IP 21 = opening in cover points downwards,

IP 42/44 = cover with cable grommet.

Diaphragm pressure switch, tempered LSR diaphragm system.

Housing: glass fibre reinforced PBT plastic with low gas release.

Max. inlet pressure  $p_{\max.}$  = withstand pressure, differential pressure: see table.

Permitted ambient temperature in operation:

DL..E: -20 to +80°C (-4 to +176°F),

DL..EH: -40 to +110°C (-40 to +230°F),

DL..T: -40 to +60°C (-40 to +140°F).

Storage and transport temperature:

DL..E, DL..T: -20 to +40°C (-4 to +104°F),

DL..EH: -20 to +60°C (-4 to +140°F).

Weight: approx. 80 g (2.3 oz).

Recommended tightening torque:

Component	Tightening torque [Ncm]
Cover screw	65
Strain relief facility	65

## 7.4.1 Dimensions

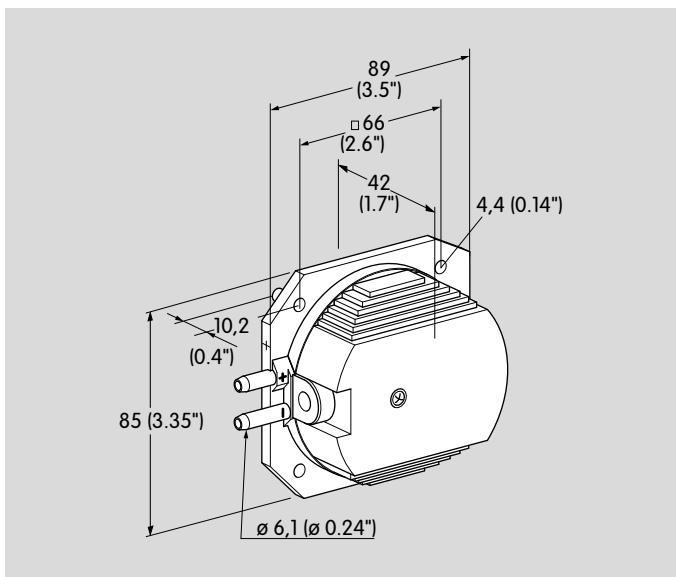

## 7.4.2 Adjusting range, switching differential

Type	Adjusting range (adjusting tolerance $\pm 15\%$ of the scale value, but min. $\pm 10$ Pa [ $\pm 0.04$ "WC])				Max. inlet pressure = withstand pressure		Mean switching differential at min. and max. setting or by agreement				Deviation from the switching point during testing pursuant to EN 1854 Air pressure switches
	Pa		"WC		Pa	psig	Pa		"WC		
	min.	max.	min.	max.			min.	max.	min.	max.	
DL 2E, DL 2ET	20	200	0.12	0.8	5000	0.7	15	25	0.05	0.10	$\pm 15\%$ /min. $\pm 6$ Pa [ $\pm 0.02$ "WC]
DL 2EH	45	200			1500		15	25			$\pm 15\%$ /min. $\pm 8$ Pa
DL 4E, DL 4ET	50	400	0.2	1.6	5000	0.7	20	50	0.08	0.20	$\pm 15\%$ /min. $\pm 8$ Pa [ $\pm 0.03$ "WC]
DL 4EH	70	400			1500		20	50			$\pm 15\%$ /min. $\pm 12$ Pa
DL 14E, DL 14ET	300	1400	1.20	5.6	5000	0.7	30	60	0.12	0.24	$\pm 15\%$ /min. $\pm 40$ Pa [ $\pm 0.16$ "WC]
DL 35E, DL 35ET	1200	3500	4.8	14.1	5000	0.7	60	100	0.24	0.40	$\pm 15\%$ /min. $\pm 90$ Pa [ $\pm 0.36$ "WC]



## **8 Maintenance cycles**

We recommend a function check once a year.

## Feedback

Finally, we are offering you the opportunity to assess this “Technical Information (TI)” and to give us your opinion, so that we can improve our documents further and suit them to your needs.

### Clarity

- Found information quickly
- Searched for a long time
- Didn't find information
- What is missing?
- No answer

### Comprehension

- Coherent
- Too complicated
- No answer

### Scope

- Too little
- Sufficient
- Too wide
- No answer



### Use

- To get to know the product
- To choose a product
- Planning
- To look for information

### Navigation

- I can find my way around
- I got “lost”
- No answer

### My scope of functions

- Technical department
- Sales
- No answer

### Remarks

## Contact

Elster GmbH  
Postfach 2809 · 49018 Osnabrück  
Strothweg 1 · 49504 Lotte (Büren)  
Germany

Tel. +49 541 1214-0  
Fax +49 541 1214-370  
info@kromschroeder.com  
www.kromschroeder.com

The current addresses of our international agents are available on the Internet:  
[www.kromschroeder.de/Weltweit.20.0.html?&L=1](http://www.kromschroeder.de/Weltweit.20.0.html?&L=1)

We reserve the right to make technical modifications in the interests of progress.  
Copyright © 2017 Elster GmbH  
All rights reserved.

