



---

**Instruction Manual**

---

**TIME DELTA-C  
ULTRASONIC FLOWMETER  
FLOW TRANSMITTER**

TYPE: FSV-2

# Introduction

We thank you very much for purchasing Fuji Electric's ultrasonic flow meter. The instruction manual concerns the installation, operation, checkup and maintenance of the Flow transmitter (FSV) of ultrasonic flow meter. Read it carefully before operation.

- First read this instruction manual carefully until an adequate understanding is acquired, and then proceed to installation, operation and maintenance of the flow meter. Improper handling may result in an accident or a failure.
- The specifications of this flow meter are subject to change without prior notice for improvement of the product.
- Do not attempt to modify the flow meter without permission. Fuji will not bear any responsibility for a trouble caused by such a modification. If it becomes necessary to modify the flow meter, contact our office in advance.
- This instruction manual should always be kept on hand by the operator.
- After reading the manual, be sure to store it at a place easier to access.
- This instruction manual should be delivered to the end user.
- If the instruction manual has been lost, request another one (with charge) to our local business office.

Manufacturer: Fuji Electric Co., Ltd.  
Type: Described in the nameplate put on the main body  
Date of manufacture: Described in the nameplate put on the main body  
Product nationality: Japan

## Note

- Reproduction of any part or the whole of this manual without permission is strictly prohibited by laws.
- Contents of the manual are subject to change without prior notice.



©Fuji Electric Co., Ltd. 2012

Issued in Dec., 2012



# SAFETY PRECAUTIONS

**Before using this product, read the following safety precautions and use the product correctly.**

The following items are important for safe operation and must be fully observed. These safety precautions are ranked in 2 levels; "DANGER" and "CAUTION".

Warning/Symbol	Meaning
 <b>DANGER</b>	Incorrect handling of the device may result in death or serious injury.
 <b>CAUTION</b>	Incorrect handling may lead to a risk of medium or light injury, or to a risk of physical damage.

The items noted under "  CAUTION " may also result in serious trouble depending on circumstances. All the items must be fully observed.

Caution on mounting and piping	
 <b>DANGER</b>	<ul style="list-style-type: none"> <li>● This unit is not explosion-proof type. Do not use it in a place with explosive gases. Otherwise, it may result in serious accidents such as explosion, fire, etc.</li> </ul>
 <b>CAUTION</b>	<ul style="list-style-type: none"> <li>● The unit should be installed in a place conforming to the installation requirements noted in this instruction manual. Otherwise, it may cause electric shocks, fire or malfunction of the unit.</li> <li>● Install the flow meter according to the following steps to prevent it from damage, and to avoid error or malfunction.</li> <li>● During installation, make sure that the inside of the unit is free from cable chips and other foreign objects. Otherwise, it may cause fire, failure or malfunction.</li> <li>● The items under "Caution on Installation" noted in the manual must be fully observed. Careless installation may result in trouble or malfunction of the unit.</li> </ul>

Cautions in wiring	
 <b>CAUTION</b>	<ul style="list-style-type: none"> <li>● When performing wiring termination to prevent output trouble caused by moisture, dew condensation or water leak, follow "Section 3.3. Flow transmitter wiring" described in this manual.</li> <li>● Before performing the wiring work, be sure to turn OFF the main power. Otherwise, it may cause electric shock.</li> <li>● Do not perform wiring work outdoors in rainy days to prevent insulation deterioration and dew condensation. Otherwise, it may result in trouble, malfunction, etc.</li> <li>● Be sure to connect a power source of correct rating. Use of power source out of rating may cause fire.</li> <li>● The unit must be grounded as specified. Otherwise, it may cause electric shocks, malfunction, etc.</li> <li>● The signal cable and analog output signal cable should be wired as far away as possible from high-voltage lines to prevent entry of noise signals as it will cause malfunction of the unit.</li> <li>● To prevent malfunction of the unit, the analog output signal cable and power cable should be wired using separate conduits.</li> </ul>

## Caution on maintenance and inspection



### **CAUTION**

- The unit should be inspected every day to always obtain good results of measurements.
- When measuring the insulation resistance between the power/output terminal and the case, follow “Section 6.2.3. How to measure the insulation resistance” described in this manual.
- If the fuse is blown, detect and eliminate the cause, and then replace the fuse with a spare. If there are no spares, replace the fuse with the one specified in this manual “Section 6.3. How to replace the fuse ” (that must be aquired separately). Use of a fuse other than specified or its short-circuit may cause an electric shock or fire. The fuse should be replaced according to “Section 6.3. How to replace the fuse” described in this manual.

## CAUTION ON INSTALLATION LOCATION



### CAUTION

- (1) A place that provides enough space for periodic inspection and wiring work.
- (2) A place not exposed to direct sunshine nor inclement weather.
- (3) A place free from excessive vibration, dust, dirt and moisture.
- (4) A place not subjected to radiated heat from a heating furnace, etc.
- (5) A place not subjected to corrosive atmosphere.
- (6) A place not to be submerged.
- (7) A place remote from electrical devices (motor, transformer, etc.) which generate electromagnetic induction noise, electrostatic noise, etc.
- (8) A place not subjected to excessive fluid pulsation such as pump discharge side.
- (9) A place that provides enough place for the length of the straight pipe.
- (10) A place where ambient temperature and humidity are -20 to +55°C and 95% RH or less for flow transmitter (FSV).

# Contents

Introduction	i	Specifications/Detector	25
SAFETY PRECAUTIONS	ii	4.6.1. Checking piping parameter	25
CAUTION ON INSTALLATION LOCATION	iv	4.6.2. Piping parameter setting method	26
1. PRODUCT OUTLINE	1	4.7. Zero Adjustment	29
1.1. Checking delivered items	1	4.8. Setting of unit	30
1.2. Check on type and specifications	2	4.8.1. How to set the unit system	30
1.3. NAME AND FUNCTION OF EACH PART	3	4.8.2. How to set the flow rate unit	31
1.3.1. Flow transmitter : FSV··S (IP66)	3	4.8.3. How to set the total unit	32
1.3.2. Flow transmitter : FSV··H (IP67)	4	4.9. Output Setting	33
2. INSTALLATION AND BEFORE START OF OPERATION OF THE FLOW TRANSMITTER	5	4.9.1. Setting of flow rate range	33
2.1. Outline of installation procedure	5	4.9.1.1. Setting of flow rate range (single range)	33
3. INSTALLATION	6	4.9.1.2. Setting of analog output at error (Burnout)	35
3.1. Installation location of flow transmitter	6	4.9.1.3. Output limit	36
3.2. Installation of flow transmitter	7	4.9.2. Setting the total(actual)	37
3.2.1. Wall mounting (Flow transmitter : FSV··S (IP66))	7	4.9.2.1. Setting the total pulse (total rate, pulse width)	37
3.2.2. 2B pipe stand mounting (Flow transmitter : FSV··S (IP66))	7	4.9.2.2. Setting the preset value	39
3.2.3. Wall mounting (Flow transmitter : FSV··H (IP67))	8	4.9.2.3. TOTAL mode	40
3.2.4. 2B pipe stand mounting (Flow transmitter : FSV··H (IP67))	8	4.9.2.4. Determining how to dispose of total at error (BURNOUT)	41
3.3. Flow transmitter wiring	9	4.9.3. Setting the DO output	42
3.3.1. Cautions in wiring	9	4.9.3.1. How to validate the total pulse output	42
3.3.2. Applicable wires	9	4.9.4. Setting the LCD indication	44
3.3.3. Treatment of wiring port	9	4.9.5. Setting the damping	45
3.3.4. Wiring to each terminal	10	4.9.6. Setting the low flow rate cutting	46
3.3.4.1. Flow transmitter : FSV··S (IP66)	10	4.10. Application operation of parameter	47
3.3.4.2. Flow transmitter : FSV··H (IP67)	11	4.10.1. Setting automatic 2 ranges	47
3.3.5. How to connect to terminal block.	12	4.10.2. Setting the Bi-directional range	49
3.3.5.1. Cable treatment	12	4.10.3. Setting the Bi-directional auto 2 range	51
3.3.5.2. How to connect to power supply/terminal block for signal.	12	4.10.4. Rate limit	53
3.3.5.3. How to connect to communication terminal block.	13	4.10.5. Setting the DO output	55
4. Parameter	14	4.10.5.1. How to validate outputting the FULL SCALE 2	55
4.1. Description of display/setting unit	14	4.10.5.2. How to validate the alarm output	56
4.1.1. Flow transmitter : FSV··S (IP66) display/setting unit	14	4.10.5.3. Setting the flow switch	57
4.1.2. Flow transmitter : FSV··H (IP67) display/setting unit	14	4.10.5.4. How to validate the total switch	59
4.1.3. Description of display/setting unit	15	4.10.5.5. How to validate the range over output and pulse range over output	60
4.2. Composition of key operation	16	4.10.5.6. How to validate the output at the minus direction action	61
4.3. Parameter initial value list	21	4.10.6. How to compensate the measurement value	62
4.4. Parameter protection	23	4.10.7. Setting of the operation mode	63
4.4.1. Protection ON/OFF	23	4.11. MAINTENANCE MODE	64
4.5. Display language	24	4.11.1. How to calibrate the analog output	64
4.5.1. How to select the language	24	4.11.2. How to set the constant current output	65
4.6. Checking and Setting of Piping		4.11.3. How to check the action of total pulses	66
		4.11.4. How to check the status output	67
		4.11.5. How to validate the test mode (simulated flow rate output)	68
		4.11.6. How to validate a serial transmission (RS-485)	70
		4.11.7. How to set the ID No.	72
		4.11.8. How to confirm the software version	72
		4.11.9. Initializing setting parameters	73
		4.11.10. LCD backlight setting	74

4.11.11. How to set the detailed setting	75
5. Mounting of detector	77
5.1. Detector mounting procedure	77
5.1.1. Mounting of detector	78
5.1.2. Image figure of mounting dimension	78
5.2. Selection of mounting method	79
5.3. Mounting method on the pipe	79
6. CHECK AND MAINTENANCE	80
6.1. Daily Check	80
6.2. Periodic Inspection	80
6.2.1. Checking zero point	80
6.2.2. Reapplying grease	80
6.2.3. How to measure the insulation resistance	81
6.2.3.1. Flow transmitter : FSV··S (IP66)	81
6.2.3.2. Flow transmitter : FSV··H (IP67)	82
6.3. How to replace the fuse	83
6.3.1. Flow transmitter : FSV··S (IP66)	83
6.3.2. Flow transmitter : FSV··H (IP67)	84
6.4. How to replace the LCD	85
6.4.1. Flow transmitter : FSV··S (IP66)	85
6.4.2. Flow transmitter : FSV··H (IP67)	86
6.5. ERROR AND REMEDY	87
6.5.1. Display error	87
6.5.1.1. Checking the LCD/LED	87
6.5.1.2. Checking the LED lit in red	88
6.5.1.3. Checking the RAS information	89
6.5.2. Displaying the data in maintenance mode	90
6.5.3. Keying is abnormal	91
6.5.4. Error in measured value	92
6.5.5. Error in analog output	94
6.5.6. Checking received waveforms	95
6.5.6.1. How to connect the oscilloscope	95
6.5.6.2. Checking sending/receiving	96
6.5.7. Remediating a hardware fault	98
7. Appendix	99
7.1. Specifications	99
7.2. OUTLINE DIAGRAM	101
7.3. ORDERING INFORMATION	102
7.4. Piping data	103

# 1. PRODUCT OUTLINE

## 1.1. Checking delivered items

After opening the package, check if all following parts are present.

Note that the delivered parts vary according to the model type.

### Flow transmitter (FSV)

- Flow transmitter main unit ..... 1 set
- Waterproof gland (Built into the main unit) ..... 1 set
- Wall mount frame (Built into the main unit)..... 1 set
- Panel mounting bracket (option)  
(U bolt, support fixture, butterfly nut 2 pieces,  
spring washer 2 pieces, plain washer 2 pieces)..... 1 set

CD-ROM (Instruction manual and loader software) ...1 piece

Out of delivery

Power cable

Output signal cable

RS-485 communication cable

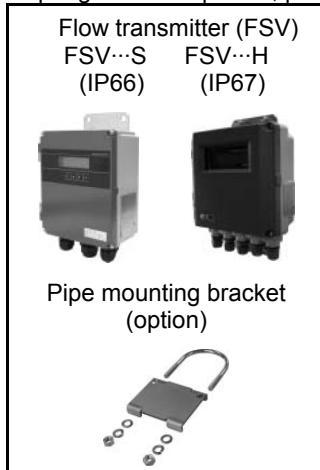



## 1.2. Check on type and specifications

The type and specifications of product are indicated on the specifications plate mounted on the flow transmitter and detector frame.

Check that they represent the type you ordered, referring to the following code symbols.

### <Flow transmitter (FSV)>

1	2	3	4	5	6	7	8	9	10	11	12	13	Description
F	S	V		Y	2			Y					(Destination) (4th digit) Standard (English)
				E									(Communication) (5th digit) None RS485
				Y									(Use) (6th digit) Single measuring path
						1							(Power supply) (7th digit) AC100 to 240V 50/60Hz DC20 to 30V
						4							(Case structure) (9th digit) IP66 IP67
								S					(Wire connection port) (10th digit) Weatherproof gland provided [G1/2 and G3/8 (internal threads)] Union (for pilica) with gland [G1/2 female screw] (when "H" is specified 9th digit)
								H					(Combination with explosion-proof detector) (11th digit) None
									Y				(Parameter setting) (12th digit) None Setting provided Setting provided + tag Tag
									A				(Mounting method) (13th digit) Pipe mount (if the 9th digit is S) Wall mount Pipe mount (if the 9th digit is H)

Flow transmitter : FSV...S (IP66)



FE	
CE	CE
Ultrasonic Flow Meter	
Type	_____
Output	DC4-20mA
Power Supply	<input type="checkbox"/> AC100-240V 50/60Hz <input type="checkbox"/> DC20-30V
Ser.No.	_____ Mfd. _____
Fuji Electric Co.,Ltd. Made in Japan	

Flow transmitter : FSV...H (IP67)



FE	
CE	CE
Ultrasonic Flow Meter	
Type	_____
Output	DC4-20mA
Power Supply	<input type="checkbox"/> AC100-240V 50/60Hz <input type="checkbox"/> DC20-30V
Ser.No.	_____ Mfd. _____
Fuji Electric Co.,Ltd. Made in Japan	

## 1.3. NAME AND FUNCTION OF EACH PART



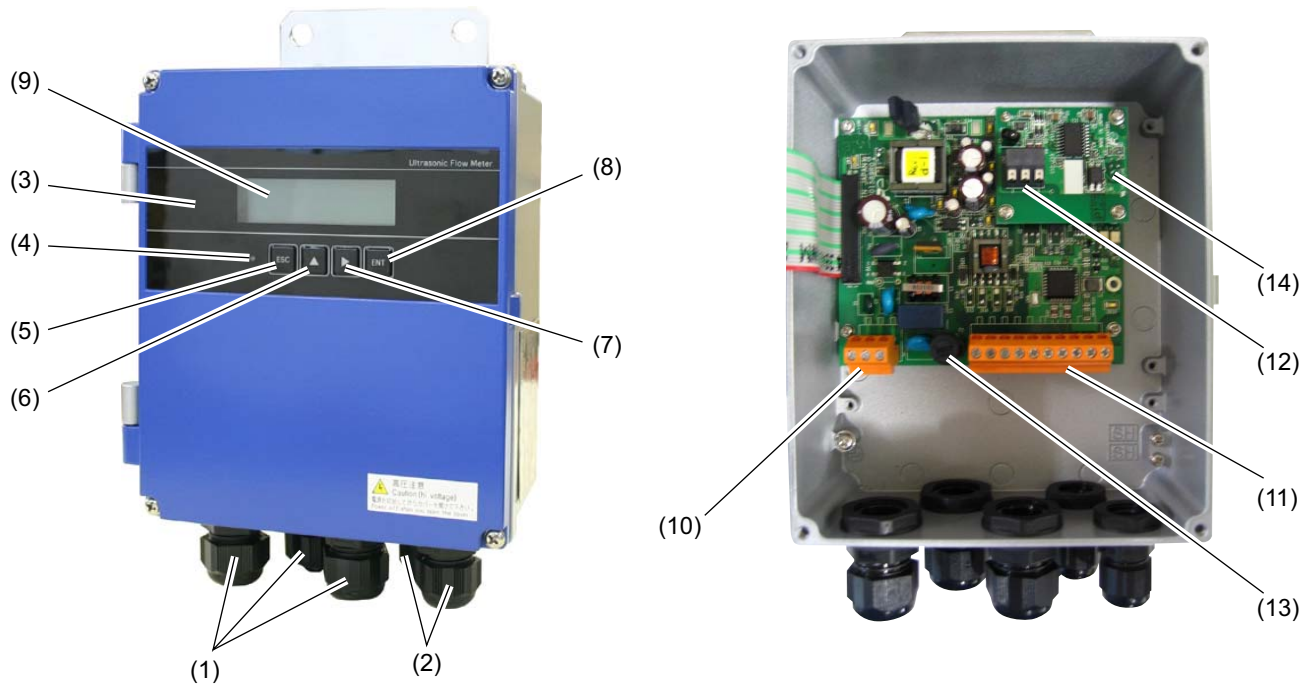

### 1.3.1. Flow transmitter : FSV...S (IP66)

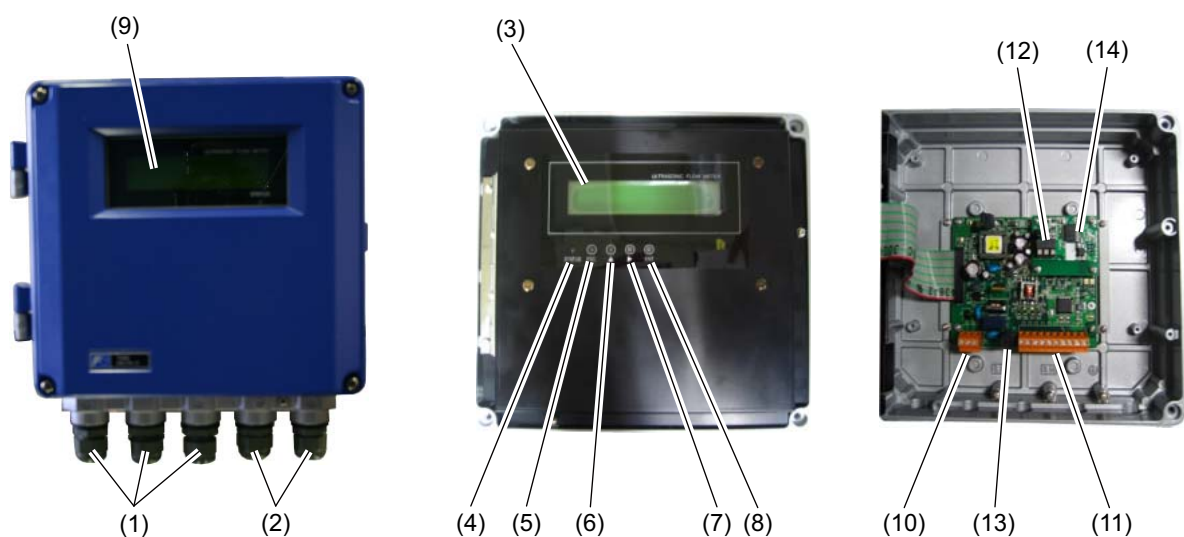

No.	Name	Key	Description
(1)	Wiring connection port, large		Wiring connection port for power cable and output cable.
(2)	Wiring connection port, small		Wiring connection port for signal cable only.
(3)	Indication and setting unit		Indicates and sets the flow rate, etc.
(4)	Received wave diagnostic indication (LED)		Indicates whether received wave is normal (green) or abnormal (red).
(5)	Escape key	ESC	Returns to the next-higher menu level or cancels the set status.
(6)	UP key	▲	Selects items, numeric values and symbols.
(7)	Shift key	▶	Moves the cursor and selects decimal place.
(8)	Entry key	ENT	Enters a selection or registers a setting.
(9)	LCD display		Indicates the flow rate or setting.
(10)	Power terminal		Connects the power cable.
(11)	Input/output terminal		Connects signal cable, analog output or DO output cable.
(12)	Communication board terminal		Connects communication cable. (A communication board is optional)
(13)	Fuse holder		Fuse holder
(14)	Communication board		Mounted if communication is optionally designated.

### 1.3.2. Flow transmitter : FSV...H (IP67)



No.	Name	Key	Description
(1)	Wiring connection port		Wiring connection port for power cable and output cable.
(2)	Wiring connection port		Wiring connection port for signal cable only.
(3)	Indication and setting unit		Indicates and sets the flow rate, etc.
(4)	Received wave diagnostic indication (LED)		Indicates whether received wave is normal (green) or abnormal (red).
(5)	Escape key		Returns to the next-higher menu level or cancels the set status.
(6)	UP key		Selects items, numeric values and symbols.
(7)	Shift key		Moves the cursor and selects decimal place.
(8)	Entry key		Enters a selection or registers a setting.
(9)	LCD display		Indicates the flow rate or setting.
(10)	Power terminal		Connects the power cable.
(11)	Input/output terminal		Connects signal cable, analog output or DO output cable.
(12)	Communication board terminal		Connects communication cable. (A communication board is optional)
(13)	Fuse holder		Fuse holder
(14)	Communication board		Mounted if communication is optionally designated.

# 2. INSTALLATION AND BEFORE START OF OPERATION OF THE FLOW TRANSMITTER

## 2.1. Outline of installation procedure

Install the flowmeter according to the following procedure.

Section 3.2 Installation of flow transmitter  
Section 3.3 Flow transmitter wiring

Power ON

Section 4.4 Parameter protection

Section 4.6 Checking and Setting of Piping Specifications/Detector

NG

- \* Check the power supply specifications and wiring before turning on the power. (Refer to "1.2.Check on type and specifications".)
  - \* Metric system is selected for unit.
  - \* The initial display language is English. Switch the languages as required.
- When Y or C is selected for the 12th digit

Section 4.6.2 Piping parameter setting method

OK  
When A or B is selected for the 12th digit

Section 5 Mounting of detector

- \* Be careful not to mount the sensor units with wrong mounting dimension. Mount it with the dimension displayed at the process setting of the piping parameter. (Refer to "5. Mounting of detector".)

Section 6.5.1.3 Checking the RAS information

NG (LED display is red)

Section 6.5.2 Displaying the data in maintenance mode

OK (LED display is green)

Section 6.5.2 Displaying the data in maintenance mode

Check the data display

Check the data display

AGC U AGC D	45% or more
----------------	-------------

P/H U P/H D	5528 to 6758
----------------	--------------

P/H U P/H D	Outside the range of 5528 to 6758
----------------	-----------------------------------

Section 4.7 Zero Adjustment

Section 6.5.6 Checking received waveforms

Contact Fuji Electric's service representative.

- \* Before performing zero point adjustment, check that the pipe is filled with fluid, the fluid is in still state, and that the measurement status is normal.

Section 4.8 Basic operation  
Section 4.9.1.1 Setting of unit  
Section 4.9.1.2 Setting of flow rate range (single range)  
Section 4.9.1.2 Setting of analog output at error (Burnout)

Section 4.9.1.3 Output limit  
Section 4.9.2 Setting thee  
Section 4.9.3 Setting the DO output  
Section 4.9.3.1 How to validate the total pulse output  
Section 4.9.4 Setting the LCD indication

- \* Check A, B for the 12th digit of code symbol only.

Section 4.9.1 Application operation  
Section 4.10.1 Setting of flow rate range  
Section 4.10.2 Setting automatic 2 ranges  
Section 4.10.3 Setting the Bi-directional range  
Section 4.10.3 Setting the Bi-directional auto 2 range

Section 4.10.5.2 How to validate the alarm output  
Section 4.10.5.3 Setting the flow switch  
Section 4.10.5.4 How to validate the total switch

Section 7.3 ORDERING INFORMATION

Run (Measurement)

Section 6 CHECK AND MAINTENANCE

Note) Set the parameter protection to OFF before you change settings or perform zero adjustment.

### 3. INSTALLATION

Select an installation location that satisfies the following conditions for ease of maintenance and inspection, service life of the instrument, and assurance of reliability all considered.

#### CAUTION

- (1) A place where ambient temperature and humidity are -20 to +55°C and 95% RH or less for flow transmitter (FSV)
- (2) A place not exposed to direct sunshine nor inclement weather.
- (3) Space for periodic inspection and wiring work is available.
- (4) A place not subjected to radiated heat from a heating furnace, etc.
- (5) A place not subjected to corrosive atmosphere.
- (6) A place not to be submerged.
- (7) A place free from excessive vibration, dust, dirt and moisture.

### 3.1. Installation location of flow transmitter

Secure at least 100 mm of space between the flow transmitter and nearby wall. Also secure a space of opening the front cover in case of maintenance.  
Allow space for cable wiring under the case.

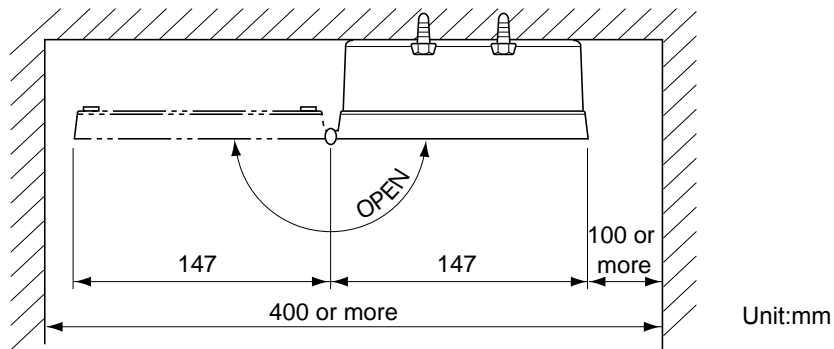

Fig. 3.1 Top view of mounting (Flow transmitter : FSV...S (IP66))

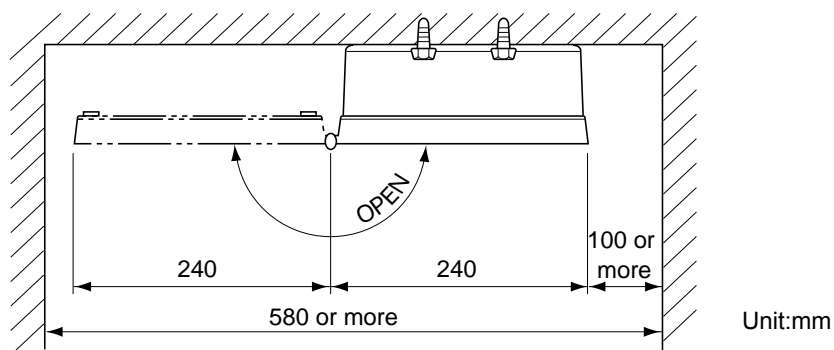

Fig. 3.2 Top view of mounting (Flow transmitter : FSV...H (IP67))

## 3.2. Installation of flow transmitter

The flow transmitter may be mounted on a wall or 2B pipe stand (option).

### 3.2.1. Wall mounting (Flow transmitter : FSV...S (IP66))

For wall mounting, use two M8 bolts.

Drill holes according to the mounting hole dimensions shown below, and fasten the flow transmitter using the M8 bolts.

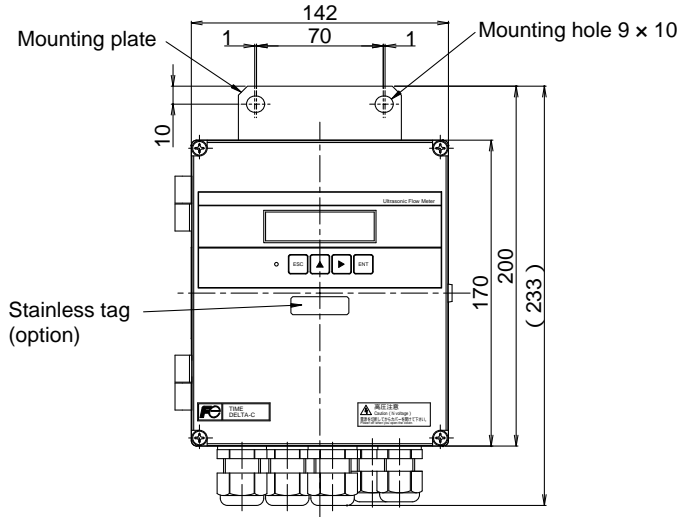

Normal	Standard tightening torque
M8	12.5 [N·m]

### 3.2.2. 2B pipe stand mounting (Flow transmitter : FSV...S (IP66))

#### CAUTION

When mounting on 2B pipe, be sure to use a complete set of fixtures (U bolt, support fixture, plain washer, spring washer, nut) furnished if optionally designated. Tighten the nut by hand. If any support fixture is not used or if the assembly is excessively tightened by tool, the wall mounting fixture may be deformed.

Mount the instrument on 2B pipe stand as illustrated below.

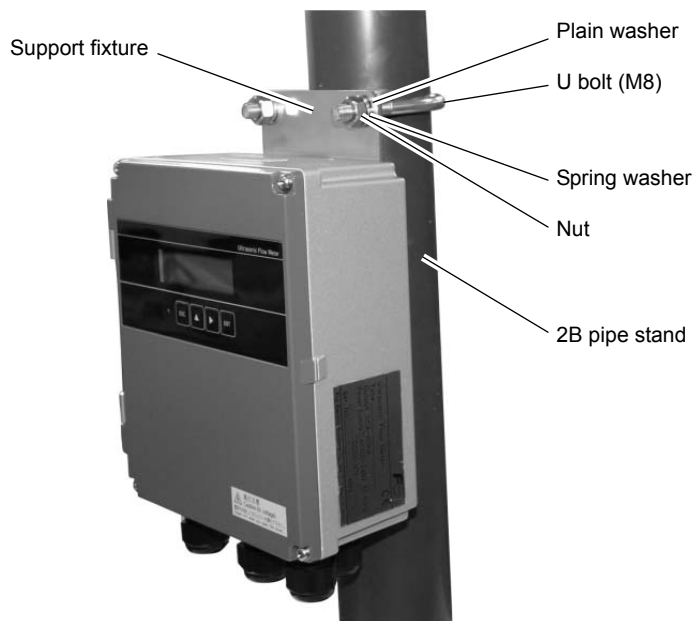

### 3.2.3. Wall mounting (Flow transmitter : FSV...H (IP67))

For wall mounting, use four M8 bolts.

Drill holes according to the mounting hole dimensions shown below, and fasten the flow transmitter using the M8 bolts.

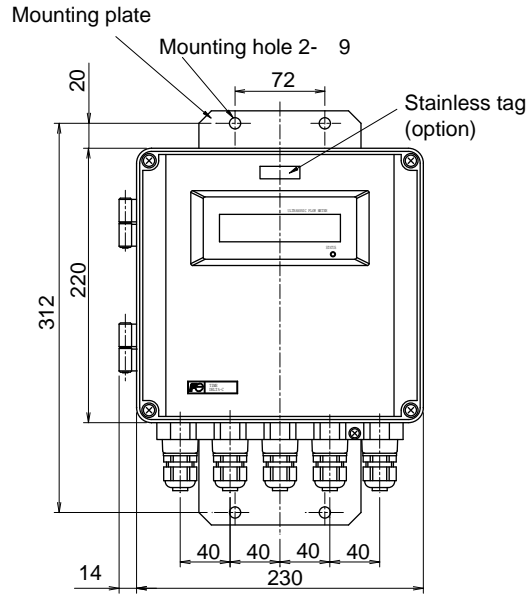

Normal	Standard tightening torque
M8	12.5 [N.m]

### 3.2.4. 2B pipe stand mounting (Flow transmitter : FSV...H (IP67))

## ⚠ CAUTION

When mounting on 2B pipe, be sure to use a complete set of fixtures (U bolt, support fixture, plain washer, spring washer, nut) furnished if optionally designated. Tighten the nut by hand. If any support fixture is not used or if the assembly is excessively tightened by tool, the wall mounting fixture may be deformed.

Mount the instrument on 2B pipe stand as illustrated below.

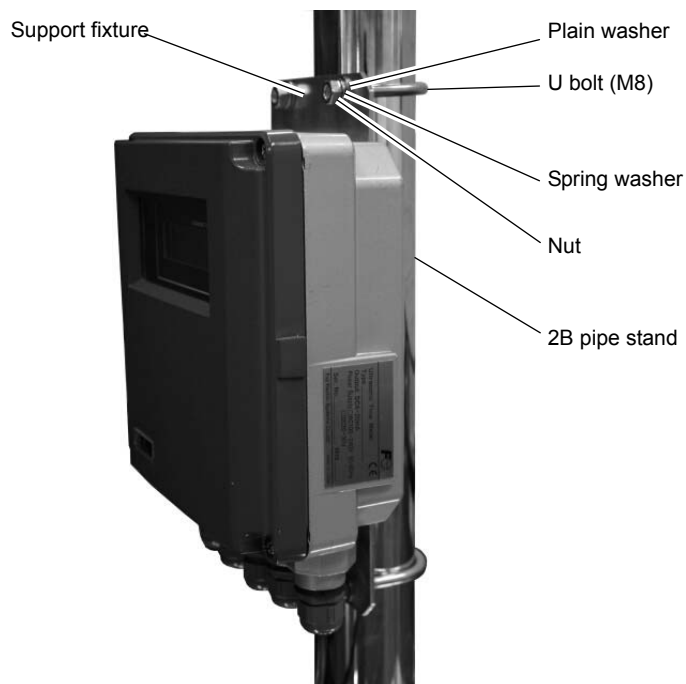

---

## 3.3. Flow transmitter wiring

---

### 3.3.1. Cautions in wiring



#### CAUTION

- (1) Use a special coaxial cable (FLYC) as a signal cable between the detector and flow transmitter (FSV). Do not provide a junction or splice of the signal cable midway.
- (2) The signal cable between the detector or flow transmitter should be run in metallic conduits. Upstream and downstream signal cables may be put in the same conduit but, to avoid interference, do not put the power cable together.
- (3) For output signal, use a shielded cable, where possible.
- (4) To avoid noise interference, do not put the cables together with heavy duty line or the like into the same duct.
- (5) If a ground wire is included in the power cable, connect it to ground as it is.
- (6) A power switch is not provided on the instrument and must be mounted separately.
- (7) Seal unused wiring ports by furnished caps.

### 3.3.2. Applicable wires

Use the following cables.

- Power cable : 3-wire or 2-wire cabtyre cable  
Nominal sectional area 0.75mm<sup>2</sup> or more  
Outside diameter Φ11mm
- Output signal cable : 2-wire or multi-wire cabtyre cable as required  
Outside diameter Φ11mm
- Detector-flow transmitter cable : Signal cable by type designation
  - In case of detector FSSA : High-frequency coaxial double shield cable with characteristic impedance of 50Ω
  - FSSC With one-side waterproof BNC connector
  - FSSD Outside diameter Φ7.3mm
  - FSSH
  - In case of detector FSSE High-frequency coaxial double shield cable with characteristic impedance of 50Ω
  - Outside diameter Φ7.3mm

### 3.3.3. Treatment of wiring port

The casing of the flow transmitter is IP66 and IP67. However, if installed in a humid place, the wiring ports must be made airtight to avoid ingress of moisture, condensation, etc. Be sure to use the waterproof glands furnished with the instrument in order to ensure the waterproof means. A gland, which is not ready to be used, should be sealed by supplied cover.



#### CAUTION

Do not install the instrument where there is a risk of flooding.



### 3.3.4. Wiring to each terminal

#### 3.3.4.1. Flow transmitter : FSV...S (IP66)

Carry out wiring to each terminal according to the following figure.

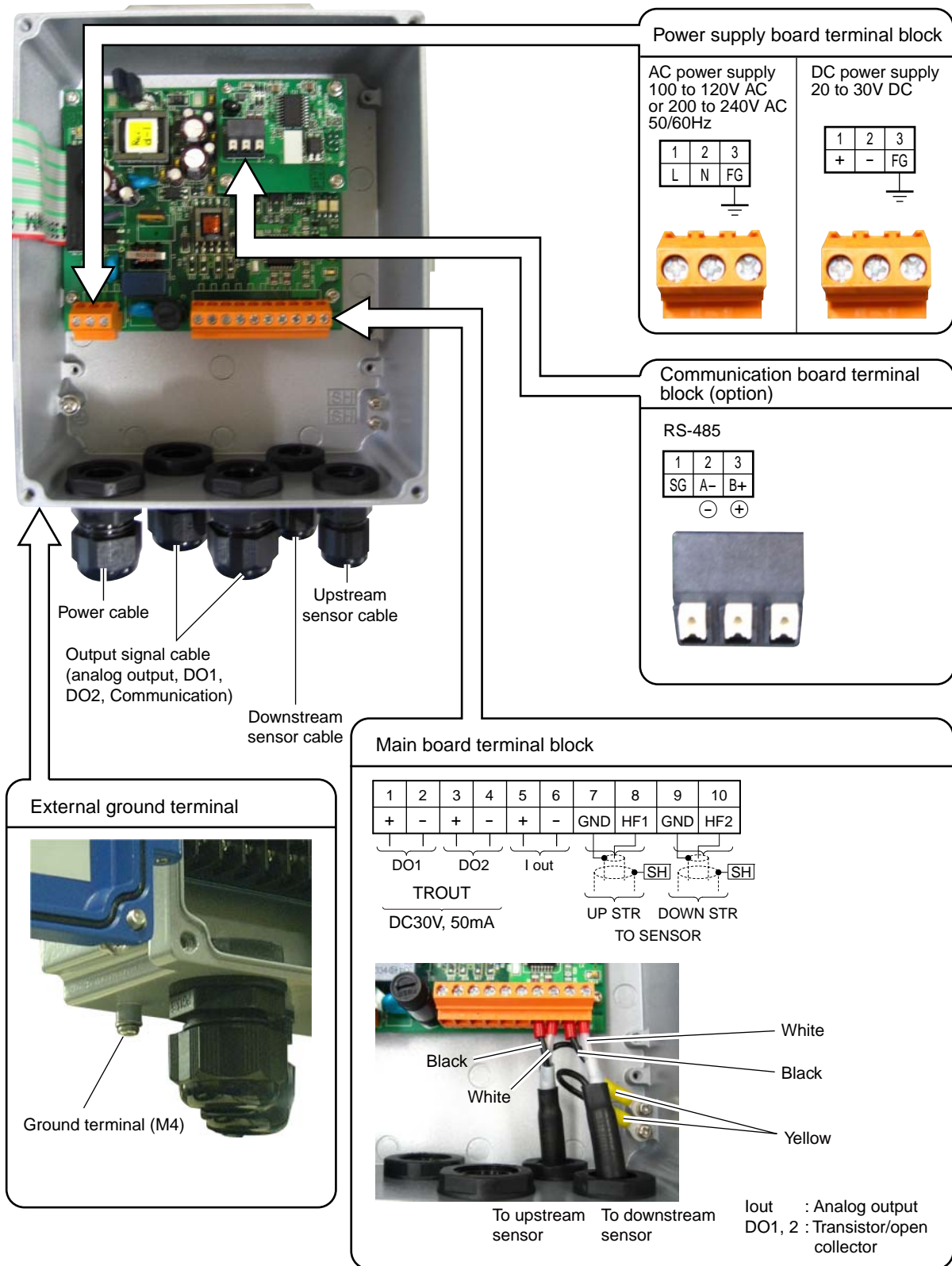

Note 1) Terminal block is insertion type to connect a cable. Use bar terminal as crimp-style terminals.

Note 2) Be sure to connect ground terminal to external ground terminal. (Class D grounding)

Note 3) For output signal, use multiple core cable as required.

Note 4) Differential signal line of RS-485 consists of two pins.

⊕ means B+, and ⊖ means A-.

### 3.3.4.2. Flow transmitter : FSV...H (IP67)

Carry out wiring to each terminal according to the following figure.

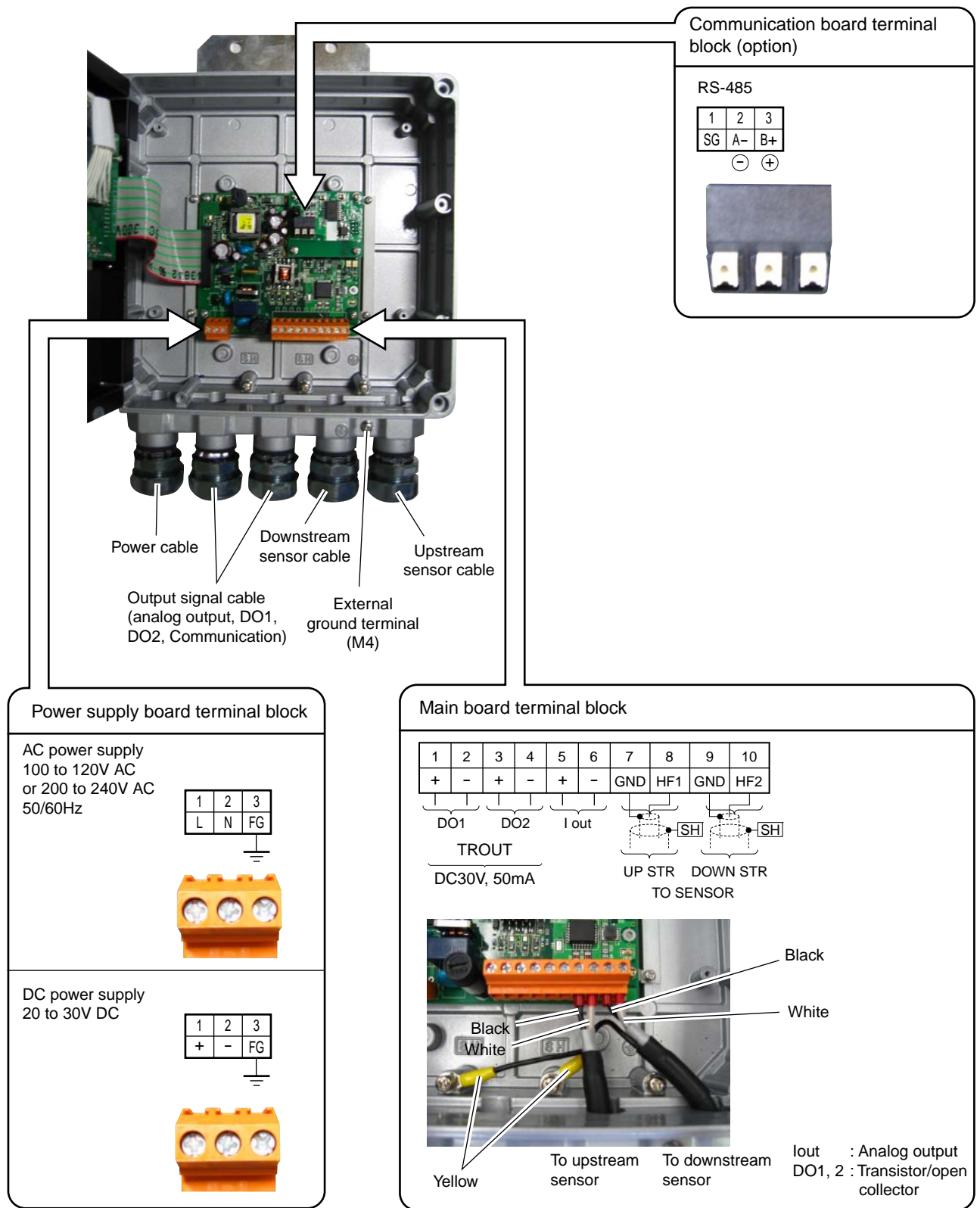

Note 1) Terminal block is insertion type to connect a cable. Use bar terminal as crimp-style terminals.

Note 2) Be sure to connect ground terminal to external ground terminal. (Class D grounding)

Note 3) For output signal, use multiple core cable as required.

Note 4) Differential signal line of RS-485 consists of two pins.

⊕ means B+, and ⊖ means A-.

### 3.3.5. How to connect to terminal block.

#### 3.3.5.1. Cable treatment

The cable connecting to the terminal block is available to connect with bare wire but for safety's sake please crimp the bar terminal to connect.

When you cut and use the signal cable, make sure to cut the cable in same length of upstream and downstream.

Note) if cable lengths are different, it may adversely affect the output.

#### Usable wiring materials

- Wire

Gauge: AWG20 (0.5mm<sup>2</sup>) to AWG16 (1.5mm<sup>2</sup>)  
Strip-off length: 8 to 10mm

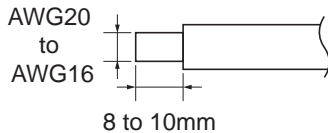

- Bar terminal

Weidmuller  
www.weidmuller.com

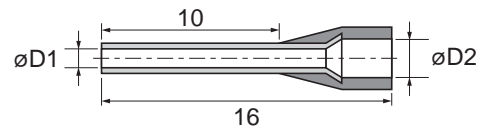

Wire size (mm <sup>2</sup> )	AWG	øD1 (mm)	øD2 (mm)	Type
0.5	20	1	2.6	H0.5/16
0.75	18	1.2	2.8	H0.75/16
1	17	1.4	3	H1/16
1.5	16	1.7	3.5	H1.5/16

Note1) Make sure to use PZ6/5(H0.25 to H6 for sleeve) as a crimp tool for caulking.

Note2) Applicable sleeve is required for electric wire.

Note3) Insert the electric wire to the end of H sleeve so as to crimp.

Note4) Length of stripped wire is 12mm.

#### 3.3.5.2. How to connect to power supply/terminal block for signal.

Please prepare the flathead screwdriver (head size: 0.6 x 3.5mm) so as to tighten the cable.

- (1) Pull off the cable socket side from the plug on the substrate with holding the right side of the socket by hand.
- (2) If cable connector is closed, turn the screw to the left on the top to open.
- (3) Insert the cable and turn the screw to the right on the top to fix.
- (4) Install the cable socket side to the plug on the substrate.

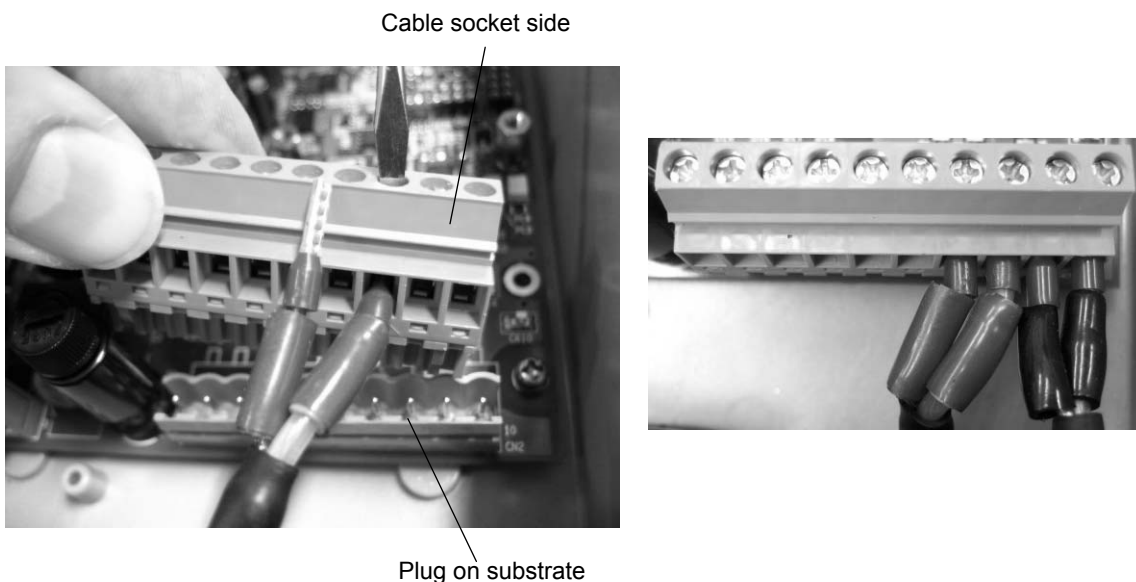

Note) Make sure to conduct the procedure not to damage the printed-circuit board when you remove and install the cable socket side.

### 3.3.5.3. How to connect to communication terminal block.

Please prepare the flathead screwdriver (head size: 0.6 x 3.5mm) so as to connect the cable.

1. Push the clamp so as to open the connector.
2. Insert the cable to the connector and release the clamp to fix the cable.

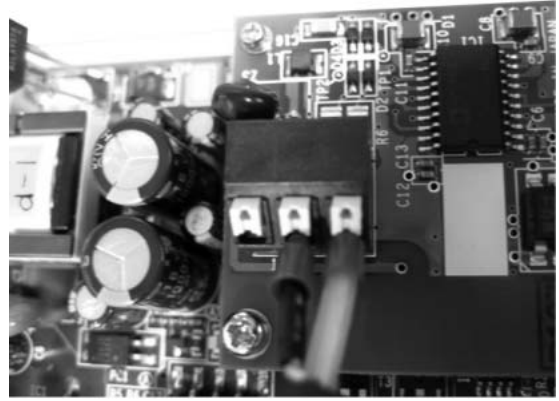
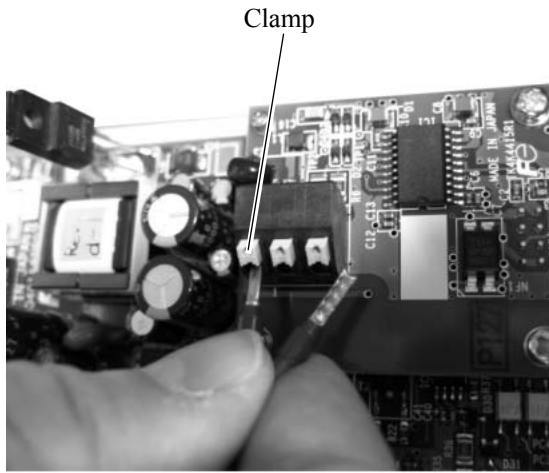

## 4. Parameter

---

### 4.1. Description of display/setting unit

---

Display unit and setting unit are as shown below.

#### 4.1.1. Flow transmitter : FSV...S (IP66) display/setting unit



#### 4.1.2. Flow transmitter : FSV...H (IP67) display/setting unit



### 4.1.3. Description of display/setting unit

- LCD display: Displays the measurement and setting (indication in 16 digits, 2 line).  
“Measurement display”

Up to 8 digits including the decimal point are displayed in the data field. When the displayed digits exceed, “<” is displayed at the first digit. When the range exceeds maximum or is below minimum setting, “OVERFLOW” or “UNDERFLOW” is displayed blinking on the Display 2.

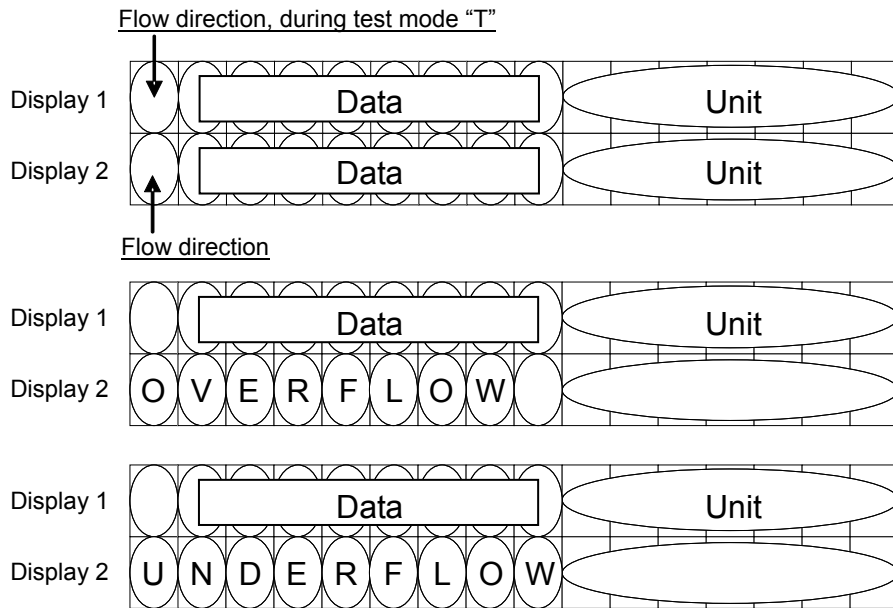

- LED display: Indicates whether the received wave is normal or not.  
(Green): Received wave is normal.  
(Red) : Received wave is abnormal.

Set the parameter by setting switches.

ESCAPE key : Return to the next-higher menu level or cancels the set status.

UP key : Selects items, numeric values and symbols.

SHIFT key : Moves the cursor and selects decimal place.

ENTRY key : Enters a selection or registers a setting.

Note) For changing the parameter, enter the changed value, and press this key to confirm that it is registered.

+ DOWN key : DOWN key function is conducted by holding down SHIFT key and press DOWN key.  
Uses DOWN key for selecting the items, values and codes.

## 4.2. Composition of key operation

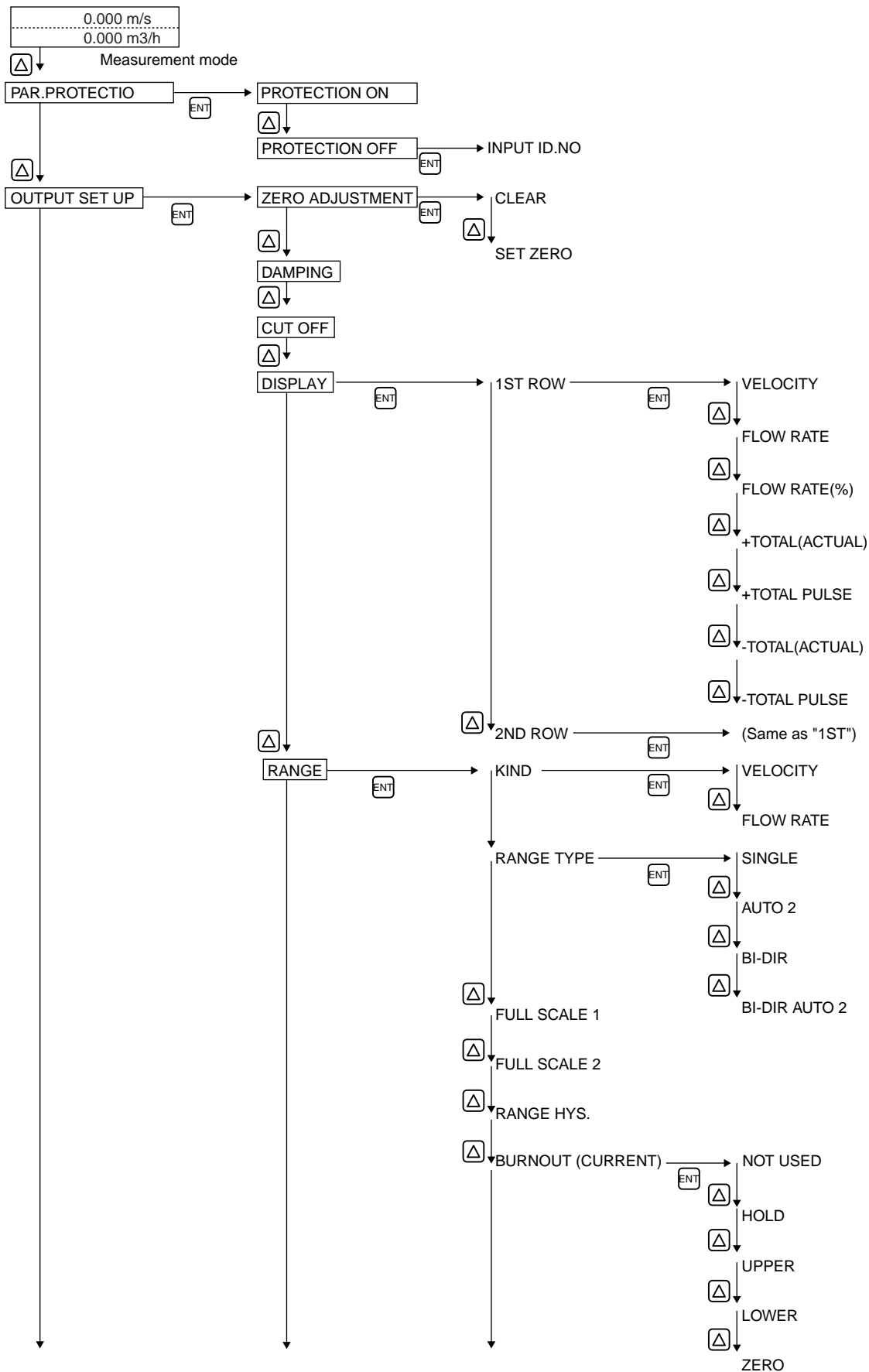

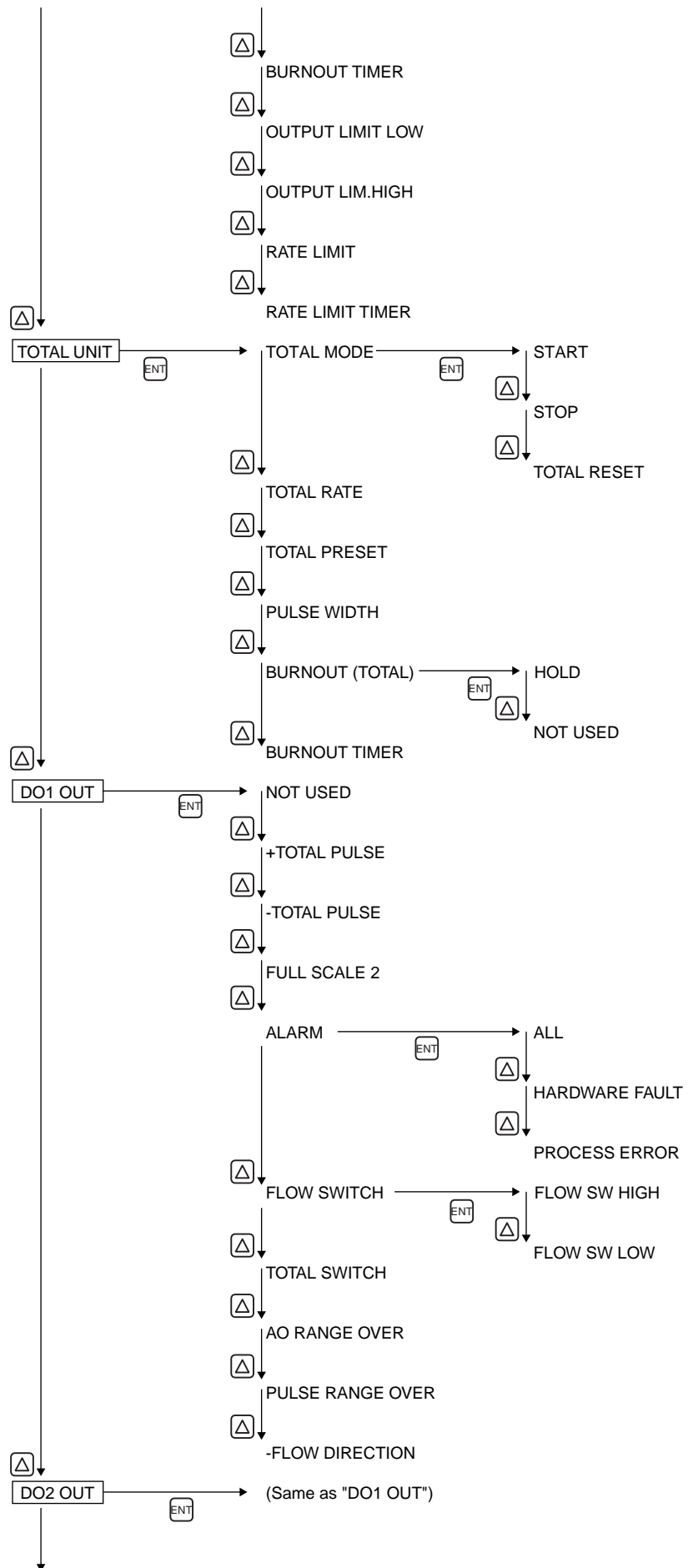



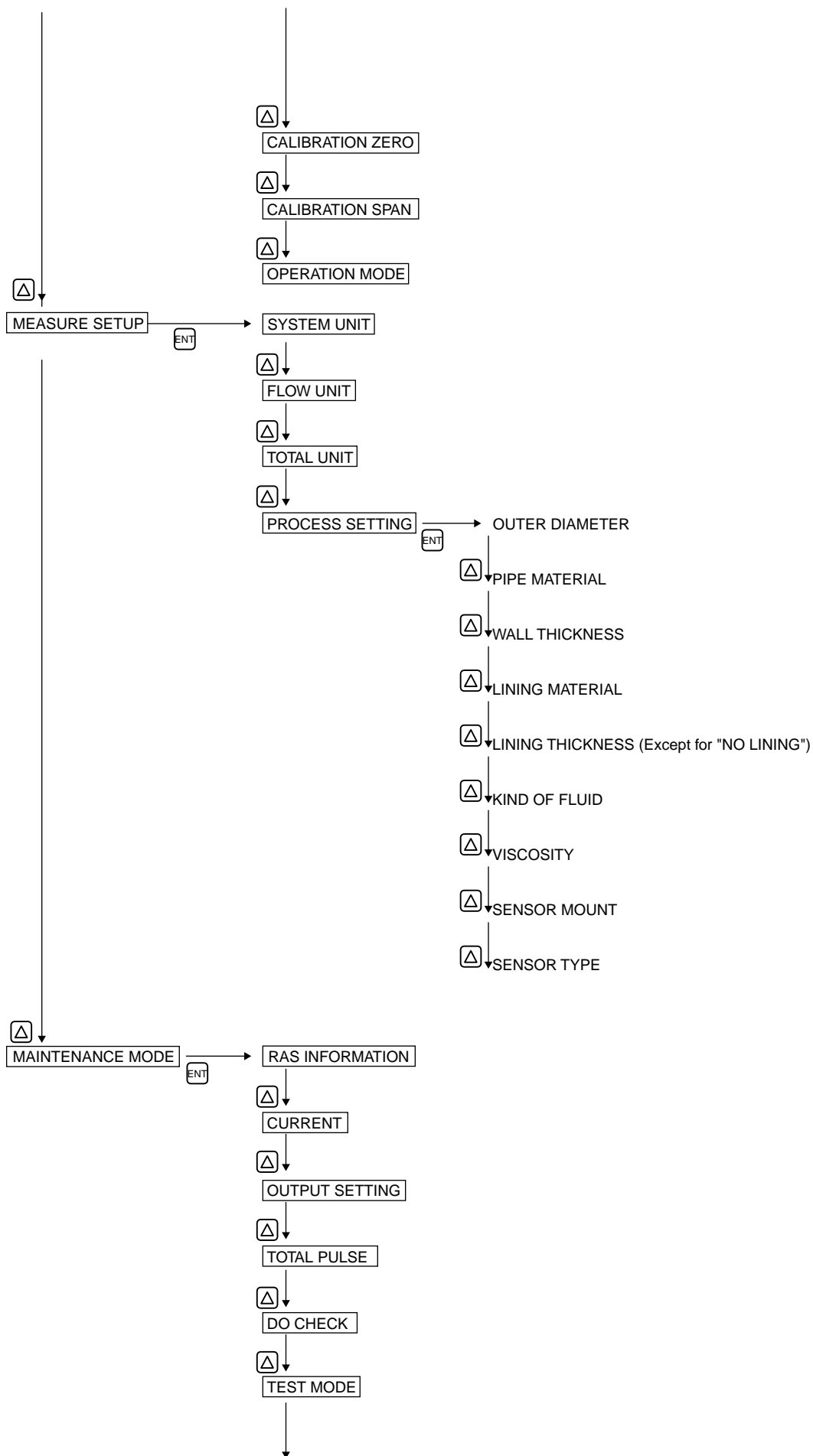

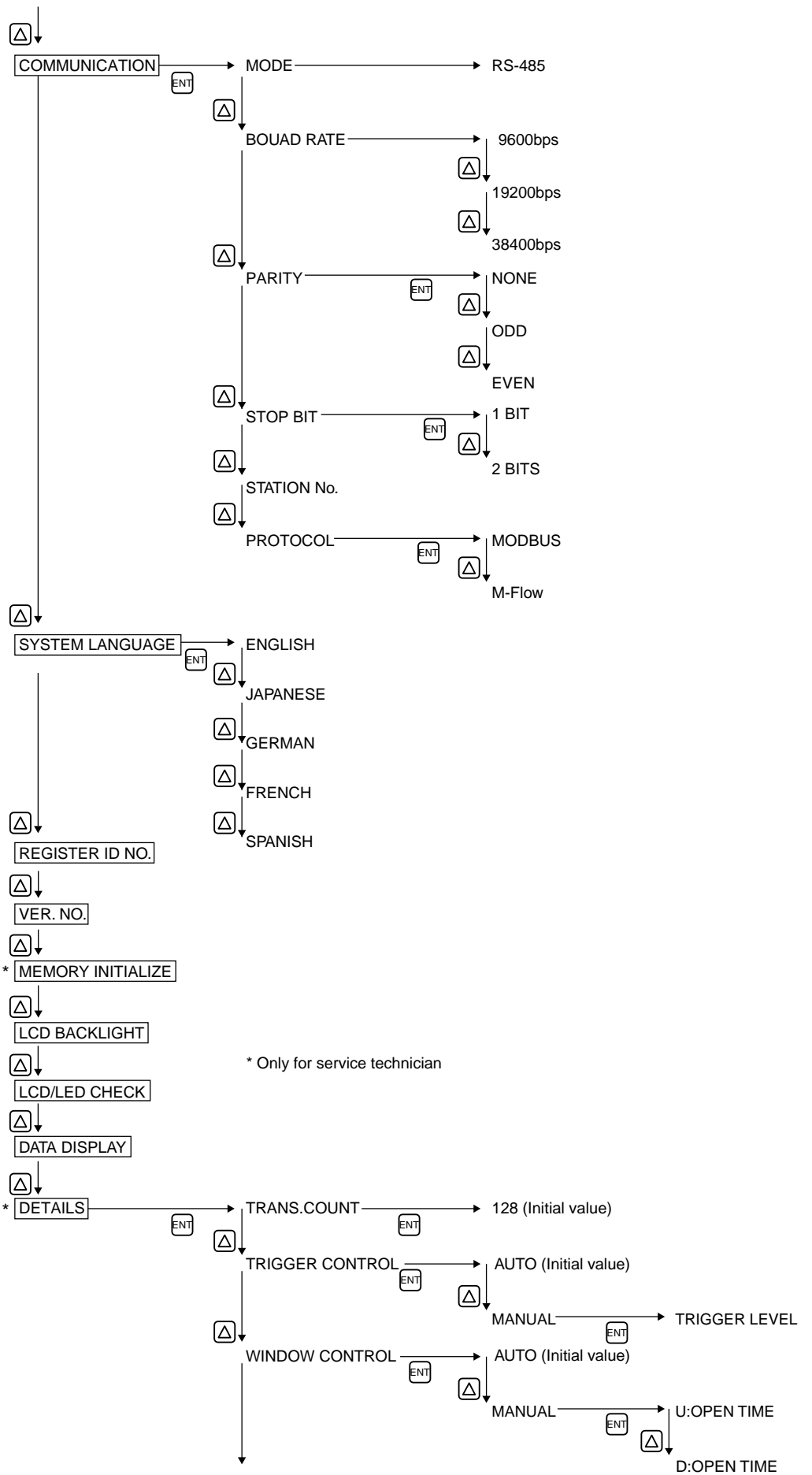

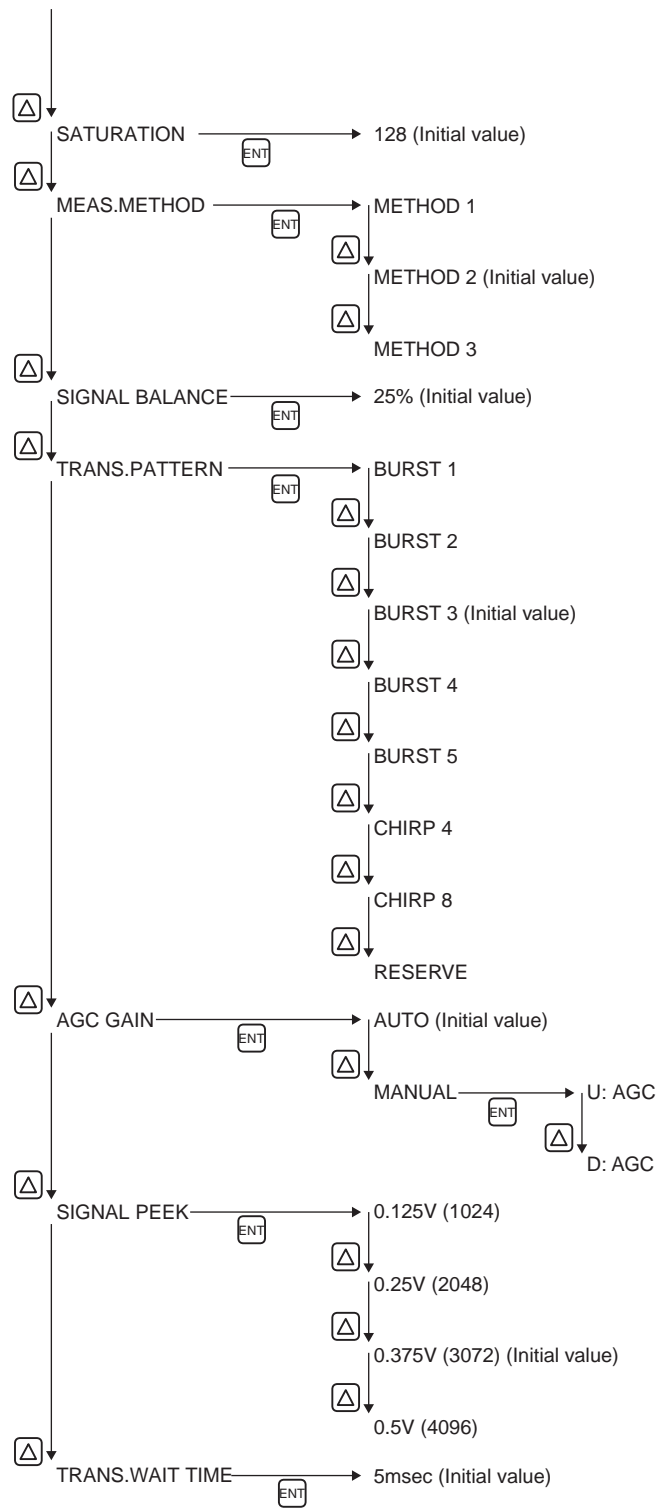



## 4.3. Parameter initial value list

Factory-set value is shown below. (When parameter setting is not provided.)

	Setting unit	Setting range	Initial value	Setting value		
1	Parameter protection	No. of menu: 2	PROTECTION ON	PROTECTION ON, PROTECTION OFF		
2	ID No	0000 to 9999	0000	ID No. is invalid when 0000 is selected.		
3	Language	No. of menu: 5	English *1	English, Japanese, German, French and Spanish		
4	Measuring condition	System unit	No. of menu: 2	Metric	Metric or inch	
5		Flow unit	No. of menu: 18	m <sup>3</sup> /h	L/s, L/min, L/h, L/d, kL/d, ML/d, m <sup>3</sup> /s, m <sup>3</sup> /min, m <sup>3</sup> /h, m <sup>3</sup> /d, km <sup>3</sup> /d, Mm <sup>3</sup> /d, BBL/s, BBL/min, BBL/h, BBL/d, kBBL/d, MBBL/d	
6		Total unit	No. of menu: 8	m <sup>3</sup>	mL, L, m <sup>3</sup> , km <sup>3</sup> , Mm <sup>3</sup> , mBBL, BBL, kBBL	
7		Outer diameter	6.00 to 6200.00mm	60.00mm	[mm, in]	
8		Pipe material	No. of menu: 13 Sound velocity: 1000 to 3700m/s	PVC	Carbon steel, Stainless, PVC, Copper, Cast iron, Aluminum, FRP, Ductile iron, PEEK, PVDF, Acrylic and PP Pipe sound velocity (Sound velocity: [m/s, ft/s])	
9		Wall thickness	0.10 to 100.00mm	4.00mm	[mm, in]	
10		Lining material	No. of menu: 8 Sound velocity: 1000 to 3700m/s	No lining	No lining, Tar epoxy, Mortar, Rubber, Teflon, Pyrex glass, PVC Lining S.V. (Sound velocity: [m/s, ft/s])	
11		Lining thickness	0.01 to 100.00mm	—	[mm, in]	
12		Kind of fluid	No. of menu: 18 Sound velocity: 300 to 2500m/s	Water	Seawater, dist. water, ammonia, alcohol, benzene, bromide, ethanol, glycol, kerosene, milk, methanol, toluol, lube oil, fuel oil, petrol and refrigerant R410 Fluid S.V. (Sound velocity: [m/s, ft/s])	
13		Dynamic viscosity coefficient	0.001 to 999.999 ×10 <sup>-6</sup> m <sup>2</sup> /s	1.0038 ×10 <sup>-6</sup> m <sup>2</sup> /s	[×10 <sup>-6</sup> m <sup>2</sup> /s, ft <sup>2</sup> /s]	
14		Sensor mounting method	No. of menu: 2	V method	V method, Z method	
15		Sensor type	No. of menu: 10	FSSA/FSSG	FSSA/FSSG, FLS_12_/FLS_22_, FSSC, FSG_32, FSG_31/FSG_41, FSSE/FSG_50, FSSF/FSG_51, FSD12, FSSD/FSD22, FSSH/FSD32	
16		Output condition	Zero adjustment	No. of menu: 2	Clear (unadjusted)	Clear, adjustment (Clear has been factory-set.)
17			Damping	0.0 to 100.0sec	5.0sec	sec
18			Low flow cut	0 to 5m/s in terms of flow velocity	0.150m <sup>3</sup> /h	[(5) unit]
19	Display		Content of display 1st line	No. of menu: 7	Flow velocity (m/s)	Flow velocity, Flow rate, Flow rate (%), +Total (Actual), +Total pulse, -Total (Actual) and -Total pulse
20			Decimal point position of display 1st line		****.***	□□□□□□□□ (Fill in the specified digit)
21			Content of display 2nd line	No. of menu: 7	Flow rate (m/s)	Flow velocity, Flow rate, Flow rate (%), +Total (Actual), +Total pulse, -Total (Actual) and -Total pulse
22			Decimal point position of display 2nd line		****.***	□□□□□□□□ (Fill in the specified digit)
23	Analog output		Kind	No. of menu: 2	Flow rate	Flow velocity, Flow rate
24			Range type	No. of menu: 4	Single range	Single range, Auto 2 range, Bi-dir range and Bi-dir Auto 2 range
25			Full scale 1	0, ±0.3 to ±32m/s in terms of flow velocity	15.000m <sup>3</sup> /h	[(5) unit]
26			Full scale 2	0, ±0.3 to ±32m/s in terms of flow velocity	0.000m <sup>3</sup> /h	[(5) unit]
27			Hysteresis	0.00 to 20.00	10.00%	%
28			Burnout (current)	No. of menu: 5	Hold	Not used, Hold, Lower, Upper and Zero
29			Burnout timer	10 to 900sec	10sec	sec
30			Output limit low	-20 to 0%	-20%	%
31		Output limit high	100 to 120%	120%	%	
32		Rate limit	0 to 5m/s in terms of flow velocity	0.000m <sup>3</sup> /h	[(5) unit]	
33		Rate limit timer	0 to 900sec	0sec	sec	
34	Total output	Total mode	No. of menu: 3	Stop	Start, Stop and Reset	
35		Total rate	0.000000 to 99999999	0m <sup>3</sup>	[(6) unit]	
36		Total preset	0.000000 to 99999999	0m <sup>3</sup>	[(6) unit]	
37		Pulse width	No. of menu: 7	50.0msec	5.0msec, 10.0msec, 50.0msec, 100.0msec, 200.0msec, 500.0sec, 1000msec.	
38		Burnout (total)	No. of menu: 2	Hold	Not used, hold	
39	Burnout timer	10 to 900sec	10sec	sec		

	Setting unit	Setting range	Initial value	Setting value	
40	Output condition	DO1 output type	No. of output content menu: 10 No. of alarm menu: 3 Flow switch range 0 to 32m/s in terms of flow velocity Total switch range 0.000000 to 99999999	Not used  <input type="checkbox"/> Not used <input type="checkbox"/> +Total pulse <input type="checkbox"/> -Total pulse <input type="checkbox"/> Range full scale 2 <input type="checkbox"/> Alarm [All, Device error, Process error] <input type="checkbox"/> Flow rate switch <input type="checkbox"/> Flow SW high [ [(5) unit]] <input type="checkbox"/> Flow SW low [ [(5) unit]] <input type="checkbox"/> Total switch [ [(6) unit]] <input type="checkbox"/> Range over <input type="checkbox"/> Pulse range over <input type="checkbox"/> -Flow direction	
41		DO1 Output operation	No. of menu: 2	Active ON	Active ON, Active OFF
42		DO2 Output type	No. of output content menu: 10 No. of alarm menu: 3 Flow switch range 0 to 32m/s in terms of flow velocity Total switch range 0.000000 to 99999999	Not used  <input type="checkbox"/> Not used <input type="checkbox"/> +Total pulse <input type="checkbox"/> -Total pulse <input type="checkbox"/> Range full scale 2 <input type="checkbox"/> Alarm [All, Device error, Process error] <input type="checkbox"/> Flow rate switch <input type="checkbox"/> Flow SW high [ [(5) unit]] <input type="checkbox"/> Flow SW low [ [(5) unit]] <input type="checkbox"/> Total switch [ [(6) unit]] <input type="checkbox"/> Range over <input type="checkbox"/> Pulse range over <input type="checkbox"/> -Flow direction	
43		DO2 Output operation	No. of menu: 2	Active ON	Active ON, Active OFF
44	Communication	Zero calibration	-5 to 5m/s in terms of flow velocity	0.000m <sup>3</sup> /h	[(5) unit]
45		Span calibration	-200.00 to 200.00%	100.00%	%
46		Operation mode	No. of menu: 2	Standard	Standard, High speed
47		Communication mode	No. of menu: 1	RS-485	RS-485
48	LCD	Baud rate	No. of menu: 3	9600bps	9600bps, 19200bps, 38400bps
49		Parity	No. of menu: 3	Odd	None, Odd, Even
50		Stop bit	No. of menu: 2	1 bit	1 bit, 2 bits
51		Station No.	1 to 31	1	(In case of RS-485)
52		Communication protocol	No. of menu: 2	MODBUS	MODBUS, M-Flow
53		LCD BACKLIGHT	No. of menu: 2	ON	ON, OFF
54	LIGHTS OUT TIME	0 to 99 min	5 min	min	

\*1) English is set when 4th digit of the type is "E".

FSV  : Japanese

FSV  : English

## 4.4. Parameter protection

### 4.4.1. Protection ON/OFF

**Description**

- Parameters can be protected so that the flow meter settings will not carelessly be changed.
- Parameters can be protected by setting the "ID No." (Note) in the maintenance mode.  
Note) 4 digits are factory set at "0000". (Refer to Section 4.11.7.)

Setting range: PROTECTION ON : Parameter cannot be changed.

PROTECTION OFF: Parameter can be changed.

\* 1 hour after "PROTECTION OFF" is set, "PROTECTION ON" is automatically set.

\* Protection is set after turning power on.

For actual keying, refer to the typical operation indicated below.

Operation (example)	Change the protection from ON to OFF (suppose ID No. is "2234").	
Key operation	Description	Display
	Press the  key in the measurement mode once to indicate "PAR. PROTECTION".	PAR.PROTECT ----- PROTECTION ON
	Press the  key once to blink the 2nd line.	PAR.PROTECT ----- PROTECTION ON
	Press the  key once to display "PROTECTION OFF".	PAR.PROTECT ----- PROTECTION OFF
	Press the  key once to display "PAR.PROTECTION".	PAR.PROTECT ----- ** COMPLETE **
		↓
		INPUT ID NO. ----- ****
	Press the  key once to indicate "0000" and blink the cursor.	INPUT ID NO. ----- 0000
	Note) If ID No. is "0000" (as factory set), press the  key to release the protection.	
	Enter ID No. "2234" by the  key or the  key.	INPUT ID NO. ----- 2234
	Press the  key once.	INPUT ID NO. ----- ** COMPLETE **
	* If ID No. does not coincide, "INPUT ERROR!" appears, and the input screen is resumed.	↓
	----- Protection canceled. -----	PAR.PROTECT ----- PROTECTION OFF



## CAUTION

**About the change of parameter setting**

When you change parameters of converter in current use which analog output or alarm has been set, if you change items which affect to the output or alarm, the output may change suddenly after display of "\*\*\*COMPLETE\*\*" and may generate alarm. If, especially, the output signal is being used for control, perform the signal lock on the system side prior to changing parameters.

**Caution on change of parameter setting**

When you change parameter settings, parameters will be saved in non-volatile memory on return to measuring display. Saved parameters have been maintained even power is off. However, when you change the parameter and turn off the power before returning to the measuring display, parameters will not be saved. Thus you should set the parameter again.

## 4.5. Display language

### 4.5.1. How to select the language

#### Description

- Indication language (English, Japanese, German, French, Spanish) is selectable.

#### Setting contents

English (default setting), Japanese, German, French, Spanish



























For actual keying, refer to the typical operation indicated below. Set the protection to OFF beforehand. (See Section 4.4.1.)

Operation (example)	Select English for the display language.	
Key operation	Description	Display
	Press the  key for 4 times to display "MAINTENANCE MODE".	MAINTENANCE MODE
	Press the  key once to display "RAS INFORMATION".	RAS INFORMATION 0000000000000000
	Press the  key for 8 times to display "SYSTEM LANGUAGE".	SYSTEM LANGUAGE JAPANESE
	Press the  key once to blink on the 2nd line.	SYSTEM LANGUAGE JAPANESE
	Press the  key for 4 times to display "ENGLISH".	SYSTEM LANGUAGE ENGLISH
	Press the  key once to register.	SYSTEM LANGUAGE ** COMPLETE **
		↓
	----- English has been registered. -----	SYSTEM LANGUAGE ENGLISH
	Press the  key or the  key to display the measurement mode.	0.000 m/s 0.000 m3/h

Operation (example)	Select Japanese for the display language.	
Key operation	Description	Display
	Press the  key for 4 times to display "MAINTENANCE MODE".	MAINTENANCE MODE
	Press the  key once to display "RAS INFORMATION".	RAS INFORMATION 0000000000000000
	Press the  key for 8 times to display "SYSTEM LANGUAGE".	SYSTEM LANGUAGE ENGLISH
	Press the  key once to blink on the 2nd line.	SYSTEM LANGUAGE ENGLISH
	Press the  key for 4 times to display "JAPANESE".	SYSTEM LANGUAGE JAPANESE
	Press the  key once to register.	SYSTEM LANGUAGE ** トウゴク **
		↓
	----- Japanese has been registered. -----	トウゴク (LANGUAGE) ニホンゴ (JAPANESE)
	Press the  key or the  key to display the measurement mode.	0.000 m/s 0.000 m3/h

## 4.6. Checking and Setting of Piping Specifications/Detector

### 4.6.1. Checking piping parameter

Key operation	Description	Display				
		<table border="1"> <tr> <td>0.000</td> <td>m/s</td> </tr> <tr> <td>0.000</td> <td>m3/h</td> </tr> </table>	0.000	m/s	0.000	m3/h
0.000	m/s					
0.000	m3/h					
	Press the  key for 3 times to display "MEASURE SETUP".	MEASURE SETUP				
	Press the  key once to display "SYSTEM UNIT".	SYSTEM UNIT ENGLISH				
	Press the  key for 3 times to display "PROCESS SETTING".	PROCESS SETTING S= 31( 93mm)				
	Press the  key once to display "OUTER DIAMETER".	OUTER DIAMETER 60.00 mm				
	Press the  key once to display "PIPE MATERIAL".	PIPE MATERIAL PVC				
	Press the  key once to display "WALL THICKNESS".	WALL THICKNESS 4.00 mm				
	Press the  key once to display "LINING MATERIAL".	LINING MATERIAL NO LINING				
	Press the  key once to display "KIND OF FLUID".	KIND OF FLUID WATER				
	Press the  key once to display "VISCOSITY".	VISCOSITY 1.003800 E-6m2/s				
	Press the  key once to display "SENSOR MOUNT".	SENSOR MOUNT V METHOD				
	Press the  key once to display "SENSOR TYPE".	SENSOR TYPE FSSA/FSSG				
 	Press the  key twice, and press the  key twice to return to the measurement mode.	<table border="1"> <tr> <td>0.000</td> <td>m/s</td> </tr> <tr> <td>0.000</td> <td>m3/h</td> </tr> </table>	0.000	m/s	0.000	m3/h
0.000	m/s					
0.000	m3/h					



## 4.6.2. Piping parameter setting method

### Description

- Set the parameters of piping and fluid to be measured to determine the sensor mounting spacing.
- The mounting dimension of the sensor is automatically calculated. Refer to "5.1.1 PRODUCT OUTLINE".



Be sure to set the following parameters before mounting the sensor on the pipe. Mount the sensor to match the sensor mounting length.

- Unless the sensor units are spaced accurately, the measurement error will be excessive.
- Also, the received wave may be abnormal.

### Setting items

1. Pipe outer diameter : 6.00 to 6200.00 [mm] (factory set at 60.00 [mm]).
2. Piping material : CARBON STEEL, STAINLESS STEEL, PVC (factory set), COPPER, CAST IRON, ALUMINIUM, FRP, DUCTILE IRON, PEEK, PVDF, ACRYLIC, PP, Others (Sound velocity: 1000 to 3700[m/s])
3. Wall thickness : 0.10 to 100.00 [mm] (factory set at 4.00 [mm]).
4. Lining material : NO LINING (factory set), TAR EPOXY, MORTAR, RUBBER, TEFLON, PYREX GLASS, PVC, Others (Sound velocity: 1000 to 3700[m/s])
5. Lining thickness : 0.10 to 100.00 [mm]
6. Measuring fluid : WATER, SEAWATER, DIST.WATER, AMMONIA, ALCOHOL, BENZENE, ETHANOL, GLYCOL, KEROSENE, MILK, METHANOL, TOLUOL, LUBE OIL, FUEL OIL, PETROL, REFRIGERANT R410, Others (Sound velocity: 300 to 2500[m/s])
7. Dynamic viscosity coefficient : 0.0010 to 999.999 × 10<sup>-6</sup> [m<sup>2</sup>/s] (factory set at 1.0038 × 10<sup>-6</sup> [m<sup>2</sup>/s])
8. Detector mounting method : V method (factory set), Z method Refer to "5.2.Selection of mounting method"
9. Detector type : FSSA/FSSG (factory set), FLS\_12/FLS\_22, FSSC,FSG\_32, FSG\_31/FSG-41, FSSE/FSG\_50, FSSF/FSG\_51, FSD12, FSSD/FSD22,FSSH/FSD32

**Note) If the sensor type is previous type, make a setting change for current type.**

Previous type	Current type	Previous type	Current type
FLD22	FSD22	FLW41	FSG_41
FLD32	FSD32	FLW50	FSG_50
FLW11	FSG_31	FLW51	FSG_51
FLW12	FSG_32		













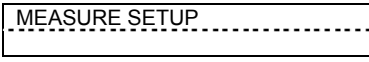



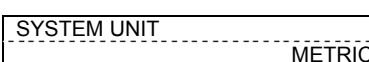



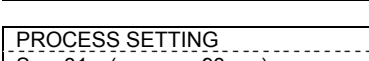



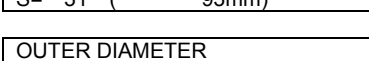



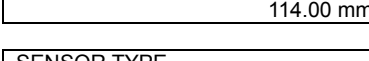



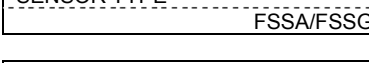



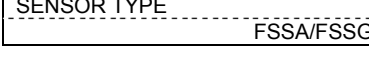



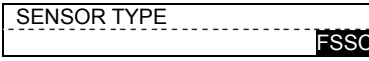



For concrete keying, refer to the typical operation indicated below. Set the protection to OFF beforehand. (See Section 4.4.1.)

### (1) Setting method when sensor type is "FSSA".

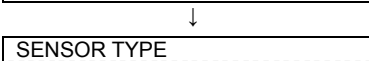
Operation (example)	Carry out setting for measuring the flow rate of water flowing through PVC pipe (for tap water) using FSSA detector.	
Key operation	Description	Display
		<div style="border: 1px solid black; padding: 2px; text-align: center;">                     0.000 m/s                      -----                      0.000 m3/h                 </div>
△	Press the △ key for 3 times to display "MEASURE SETUP".	<div style="border: 1px solid black; padding: 2px; text-align: center;">                     MEASURE SETUP                      -----                 </div>
▼		
ENT	Press the ENT key once to display "SYSTEM UNIT".	<div style="border: 1px solid black; padding: 2px; text-align: center;">                     SYSTEM UNIT                      -----                      METRIC                 </div>
▼		
△	Press the △ key for 3 times to display "PROCESS SETTING".	<div style="border: 1px solid black; padding: 2px; text-align: center;">                     PROCESS SETTING                      -----                      S= 16 ( 48mm)                 </div>
▼		
ENT	Press the ENT key once to display "OUTER DIAMETER".	<div style="border: 1px solid black; padding: 2px; text-align: center;">                     OUTER DIAMETER                      -----                      60.00 mm                 </div>
▼		
ENT	Press the ENT key once to blink the cursor.	<div style="border: 1px solid black; padding: 2px; text-align: center;">                     OUTER DIAMETER                      -----                      0160.00 mm                 </div>
▼		
△		<div style="border: 1px solid black; padding: 2px; text-align: center;">                     0160.00 mm                   </div>
▼		
△		<div style="border: 1px solid black; padding: 2px; text-align: center;">                     0160.00 mm                   </div>
▼		
△		<div style="border: 1px solid black; padding: 2px; text-align: center;">                     0110.00 mm                   </div>
▼		
△		<div style="border: 1px solid black; padding: 2px; text-align: center;">                     0110.00 mm                   </div>
▼		
△	Move the cursor by the ▢ key, and change the numeric value by	<div style="border: 1px solid black; padding: 2px; text-align: center;">                     OUTER DIAMETER                      -----                      0114.00 mm                 </div>
▼		
△	△ the key. Operated to compose "114" because, from Piping data in Section 7.4., the outer diameter of polyvinyl chloride pipe (tap water size) is 114 mm.	

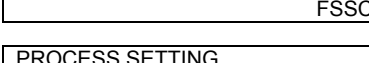
<p>ENT</p> <p>▼</p> <p>▼</p> <p>▼</p> <p>▼</p> <p>△</p> <p>▼</p> <p>△</p> <p>▼</p> <p>ENT</p> <p>▼</p> <p>△</p> <p>▶</p> <p>▼</p> <p>ENT</p> <p>▼</p> <p>▼</p> <p>▼</p> <p>▼</p> <p>△</p> <p>▼</p> <p>△</p> <p>▼</p> <p>△</p> <p>▼</p> <p>△</p> <p>▼</p> <p>ESC</p> <p>▼</p> <p>ESC △</p>	<p>Press the <b>ENT</b> key once to register the outer diameter.</p> <p style="text-align: center;">----- Outer diameter has been registered. -----</p> <p>Press the <b>△</b> key once to display "PIPE MATERIAL". Because PVC (factory set) is already registered, go to the next step. Note) If the pipe is made of another material, press <b>ENT</b> key, and select a corresponding menu by the <b>△</b> key.</p> <p>Press the <b>△</b> key once to display "WALL THICKNESS".</p> <p>Press the <b>ENT</b> key once to blink the cursor.</p> <p>Move the cursor by the <b>▶</b> key, and change the numeric value by the <b>△</b> key. Operated to compose "7" because, from Piping data in Section 7.4., the wall thickness of polyvinyl chloride pipe (tap water size) is 7.0mm.</p> <p>Press the <b>ENT</b> key once to register the wall thickness.</p> <p style="text-align: center;">----- Wall thickness has been registered. -----</p> <p>Press the <b>△</b> key once to display "LINING MATERIAL". "NO LINING" (factory set) is already registered. Because there is no lining, go to the next step. Note) If lining is provided, press the <b>ENT</b> key and <b>△</b> key to select the material or enter the sound velocity. Further, go to "LINING THICKNESS", and input a lining thickness. Nothing is indicated in case of "NO LINING".</p> <p>Press the <b>△</b> key once to display "KIND OF FLUID". Because, also, "WATER" (factory set) is already registered, go to the next step. Note) If fluid to be measured is other than water, press the <b>ENT</b> key, and select the menu or enter the sound velocity.</p> <p>Press the <b>△</b> key once to display "VISCOSITY". Input the kinematic viscosity of the fluid to be measured. Because the kinematic viscosity <math>1.0038E^{-6}</math> [m<sup>2</sup>/s] of water at 20°C is already registered, go to the next step. In case of fluid other than water, input the kinematic viscosity at a measurement status of fluid to be measured referring to data in Section 7.4., etc.</p> <p>Press the <b>ESC</b> key once to display "PROCESS SETTING". "S=31" is indicated on the 2nd line. After mounting the frames on piping, insert into it 2 sensor units spaced at 31 divisions.</p> <p>Press the <b>ESC</b> key once and the <b>△</b> key twice to return to the measurement mode.</p>	<table border="1" style="width: 100%; border-collapse: collapse;"> <tr> <td style="text-align: center;">OUTER DIAMETER</td> </tr> <tr> <td style="text-align: center;">** COMPLETE **</td> </tr> <tr> <td style="text-align: center;">↓</td> </tr> <tr> <td style="text-align: center;">OUTER DIAMETER</td> </tr> <tr> <td style="text-align: right;">114.00 mm</td> </tr> <tr> <td style="text-align: center;">PIPE MATERIAL</td> </tr> <tr> <td style="text-align: right;">PVC</td> </tr> <tr> <td style="text-align: center;">WALL THICKNESS</td> </tr> <tr> <td style="text-align: right;">4.00 mm</td> </tr> <tr> <td style="text-align: center;">WALL THICKNESS</td> </tr> <tr> <td style="text-align: right;">004.00 mm</td> </tr> <tr> <td style="text-align: center;"> </td> </tr> <tr> <td style="text-align: right;">004.00 mm</td> </tr> <tr> <td style="text-align: center;">WALL THICKNESS</td> </tr> <tr> <td style="text-align: right;">007.00 mm</td> </tr> <tr> <td style="text-align: center;">WALL THICKNESS</td> </tr> <tr> <td style="text-align: center;">** COMPLETE **</td> </tr> <tr> <td style="text-align: center;">↓</td> </tr> <tr> <td style="text-align: center;">WALL THICKNESS</td> </tr> <tr> <td style="text-align: right;">7.00 mm</td> </tr> <tr> <td style="text-align: center;">LINING MATERIAL</td> </tr> <tr> <td style="text-align: right;">NO LINING</td> </tr> <tr> <td style="text-align: center;">KIND OF FLUID</td> </tr> <tr> <td style="text-align: right;">WATER</td> </tr> <tr> <td style="text-align: center;">VISCOSITY</td> </tr> <tr> <td style="text-align: right;">1.0038 E-6m2/s</td> </tr> <tr> <td style="text-align: center;">PROCESS SETTING</td> </tr> <tr> <td style="text-align: right;">S= 31 ( 93mm)</td> </tr> <tr> <td style="text-align: center;">0.000 m/s</td> </tr> <tr> <td style="text-align: center;">0.000 m3/h</td> </tr> </table>	OUTER DIAMETER	** COMPLETE **	↓	OUTER DIAMETER	114.00 mm	PIPE MATERIAL	PVC	WALL THICKNESS	4.00 mm	WALL THICKNESS	004.00 mm		004.00 mm	WALL THICKNESS	007.00 mm	WALL THICKNESS	** COMPLETE **	↓	WALL THICKNESS	7.00 mm	LINING MATERIAL	NO LINING	KIND OF FLUID	WATER	VISCOSITY	1.0038 E-6m2/s	PROCESS SETTING	S= 31 ( 93mm)	0.000 m/s	0.000 m3/h
OUTER DIAMETER																																
** COMPLETE **																																
↓																																
OUTER DIAMETER																																
114.00 mm																																
PIPE MATERIAL																																
PVC																																
WALL THICKNESS																																
4.00 mm																																
WALL THICKNESS																																
004.00 mm																																
004.00 mm																																
WALL THICKNESS																																
007.00 mm																																
WALL THICKNESS																																
** COMPLETE **																																
↓																																
WALL THICKNESS																																
7.00 mm																																
LINING MATERIAL																																
NO LINING																																
KIND OF FLUID																																
WATER																																
VISCOSITY																																
1.0038 E-6m2/s																																
PROCESS SETTING																																
S= 31 ( 93mm)																																
0.000 m/s																																
0.000 m3/h																																

## (2) Setting method when sensor type is not “FSSA”

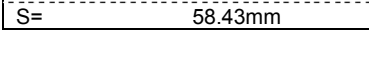
Operation (example)	Carry out setting for measuring the flow rate of water flowing through PVC pipe (for tap water) having 100 mm of nominal diameter, using FSSC detector. * Settings of piping and fluid to be measured are omitted, since it is same as “(1) Setting method when sensor type is “FSSA”	
Key operation	Description	Display
	Press the  key for 3 times to display “MEASURE SETUP”.	
 	Press the  key once to display “SYSTEM UNIT”.	
 	Press the  key for 3 times to display “PROCESS SETTING”.	
 	Press the  key once to display “OUTER DIAMETER”.	
 	Press the  key for 7 times to blink the cursor.	
 	Press the  key once to blink the cursor.	
 	Press the  key for 2 times to display “FSSC” on the 2nd line.	
 	Press the  key once to register “FSSC”.	
  	<p style="text-align: center;">----- “FSSC” has been registered. -----</p>	
 	Press the  key once to display “PROCESS SETTING”.	
	“S=58.43mm” is displayed on the 2nd line. Align the sensor mounting spacing to 58.43mm, and attach the sensor to the pipe.	
 	Press the  key once and the  key twice to return to the measurement mode.	

## 4.7. Zero Adjustment

**Description**

- Zero point is calibrated.

**Settable range:**

**CLEAR** : Clears the zero point calibration value to "0".

Used in case the flow cannot be stopped when calibrating the zero point.

Note 1) Where possible, stop the flow and carry out "SET ZERO" stated below.

Otherwise, an error may occur in the zero point.

**SET ZERO**: A point where "SET ZERO" is carried out is regarded as zero, how condition used in case the flow cannot be stopped when calibrating the zero point.

Note 2) The flow must completely be stopped.

Otherwise, the flowing status is regarded as zero, thereby causing an error.

It takes ten seconds to several tens of seconds to complete adjustment, depending on pipe diameter.

For actual keying, refer to the typical operation indicated below. Set the protection to OFF beforehand. (See Section 4.4.1.)

Operation (example)	Completely fill the piping, close the upstream and downstream valves, and proceed to zero point calibration.	
Key operation	Description	Display
△	Press the △ key twice to display "OUTPUT SETUP".	<div style="border: 1px solid black; padding: 2px;">OUTPUT SETUP</div>
▼		
ENT	Press the ENT key twice to display "ZERO ADJUSTMENT" and blink the cursor.	<div style="border: 1px solid black; padding: 2px;">ZERO ADJUSTMENT</div>
▼		
△	Press the △ key once, and select "SET ZERO".	<div style="border: 1px solid black; padding: 2px;">ZERO ADJUSTMENT <span style="float: right;">CLEAR</span></div>
▼		
ENT	Press the ENT key once to carry out "SET ZERO".	<div style="border: 1px solid black; padding: 2px;">ZERO ADJUSTMENT <span style="float: right;">SET ZERO</span></div>
▼		
▼		
▼		
▼		
▼		
▼		
▼		
ESC △	Press the ESC key once, and the △ key for 3 times to enter the measurement mode.	<div style="border: 1px solid black; padding: 2px;">ZERO ADJUSTMENT <span style="float: right;">** COMPLETE **</span></div> <div style="text-align: center;">↓</div> <div style="border: 1px solid black; padding: 2px;">ZERO ADJUSTMENT <span style="float: right;">SET ZERO</span></div>
		<div style="border: 1px solid black; padding: 2px;">0.000 m/s</div> <div style="border: 1px solid black; padding: 2px;">0.000 m3/h</div>

## 4.8. Setting of unit

### 4.8.1. How to set the unit system

**Description**

- Measurement unit can be selected from metric or inch system.

- Metric system (factory set)

Length..... mm

Flow velocity..... m/s

Flow rate..... L/s, L/min, L/h, L/d, kL/d, ML/d, m<sup>3</sup>/s, m<sup>3</sup>/min, m<sup>3</sup>/h, m<sup>3</sup>/d, km<sup>3</sup>/d, Mm<sup>3</sup>/d, BBL/s, BBL/min, BBL/h, BBL/d, kBBL/d, MBBL/d

Total unit..... mL, L, m<sup>3</sup>, km<sup>3</sup>, Mm<sup>3</sup>, mBBL, BBL, kBBL

Kinematic viscosity coefficient..... E<sup>-6</sup>m<sup>2</sup>/s

<Note> When setting, stop status should be set at total mode. (See Section 4.9.2.)

For actual keying, refer to the typical operation indicated below. Set the protection to OFF beforehand. (See Section 4.4.1.)

Operation (example)	Change the unit system from inch system to metric system.	
Key operation	Description	Display
△	Press the △ key for 3 times to display "MEASURE SETUP".	MEASURE SETUP
▼		
ENT	Press the ENT key once to display "SYSTEM UNIT".	SYSTEM UNIT INCH
▼		
ENT	Press the ENT key once to blink the cursor.	SYSTEM UNIT INCH
▼		
△	Press the △ key once to display "METRIC".	SYSTEM UNIT METRIC
▼		
ENT	Press the ENT key once to register.	SYSTEM UNIT ** COMPLETE **
▼		↓
▼	----- METRIC has been registered. -----	SYSTEM UNIT METRIC
▼		
ESC △	Press the ESC key once and △ key twice to return to the measurement mode.	0.000 m/s 0.000 m3/h

## 4.8.2. How to set the flow rate unit

**Description**

- Select the unit of flow rate.
- Metric system

Flow rate ..... L/s, L/min, L/h, L/d, kL/d, ML/d, m<sup>3</sup>/s, m<sup>3</sup>/min, m<sup>3</sup>/h (factory set), m<sup>3</sup>/d, km<sup>3</sup>/d, Mm<sup>3</sup>/d, BBL/s, BBL/min, BBL/h, BBL/d, kBBL/d, MBBL/d

<Note> First, set the unit system (metric) according to Section 4.8.1.

For actual keying, refer to the typical operation indicated below. Set the protection to OFF beforehand. (See Section 4.4.1.)

Operation (example)	Set a flow rate unit to "L/min".	
Key operation	Description	Display
	Press the  key for 3 times to display "MEASURE SETUP".	MEASURE SETUP
	Press the  key once to display "SYSTEM UNIT".	SYSTEM UNIT METRIC
	Press the  key once to display "FLOW UNIT".	FLOW UNIT m <sup>3</sup> /h
	Press the  key once to blink the cursor.	FLOW UNIT m <sup>3</sup> /h
	Press the  key several times to display "L/min".	FLOW UNIT L/min
	Press the  key once to register.	FLOW UNIT ** COMPLETE **
	Press the  key once and the  key twice to return to the measurement mode.	0.000 m/s 0.000 L/min

### 4.8.3. How to set the total unit

**Description**

- Select the unit of total volume.
- Metric system  
 Total unit ..... mL, L, m<sup>3</sup> (factory set), km<sup>3</sup>, Mm<sup>3</sup>, mBBL, BBL, kBBL

<Note> First, set the unit system (metric) according to Section 4.8.1.  
 When setting, stop status should be set at total mode. (See Section 4.9.2.)

For actual keying, refer to the typical operation indicated below. Set the protection to OFF beforehand. (See Section 4.4.1.)

Operation (example)	Set a flow total unit to "L".	
Key operation	Description	Display
△	Press the △ key for 3 times to display "MEASURE SETUP".	MEASURE SETUP
▼		
ENT	Press the ENT key once to display "SYSTEM UNIT".	SYSTEM UNIT METRIC
▼		
△	Press the △ key once to display "TOTAL UNIT".	TOTAL UNIT m3
▼		
ENT	Press the ENT key once to blink the cursor.	TOTAL UNIT m3
▼		
△	Press the △ key twice to display "L".	TOTAL UNIT L
▼		
ENT	Press the ENT key once to register.	TOTAL UNIT ** COMPLETE **
▼		↓
▼	----- "L" has been registered. -----	TOTAL UNIT L
▼		
ESC △	Press the ESC key once and the △ key twice to return to the measurement mode.	0.000 L 0.000 L/min

## 4.9. Output Setting

### 4.9.1. Setting of flow rate range

#### 4.9.1.1. Setting of flow rate range (single range)

**Description**

- The range (full scale) of flow rate to be measured is set.
  - \* The analog output (4-20mA) corresponds to the range setting.
- Settable range: 0.3 to 32 [m/s] in terms of flow velocity in piping
  - \* The piping parameters and FLOW UNIT must be set beforehand.
  - \* If a value beyond the settable range is inputted, "INPUT ERROR" appears and then last setting is resumed.
  - \* If "piping parameters" or "FLOW UNIT" has been changed after setting the range, recommence the range setting.

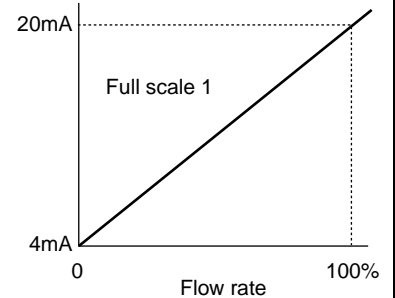

<Note> The flow rate unit is as selected by "FLOW UNIT" in the "MEASURE SETUP" mode.  
(Refer to Section 4.8.2.)

• **Setting range of the full scale flow rate**

- <Note>
- Converted flow rate in the Table 1 is the calculation results obtained by using the internal diameters of pipes in the left columns. Perform calculation using the actual internal diameters for accuracy.
  - Simple formula for calculation of flow velocity

Flow velocity range: 0.3 ~ 32 [m/s] <Table1>



Int. dia. of pipes [mm]	Flow rate unit	
	[m <sup>3</sup> /h]	[L/min]
25	0.530 to 56.5	8.84 to 942
50	2.12 to 226	35.3 to 3770
80	5.43 to 579	90.5 to 9651
100	8.48 to 905	141 to 15080
150	19.1 to 2036	318 to 33929
200	33.9 to 3619	565 to 60319
300	76.3 to 8143	1272 to 135717

For actual keying, refer to the typical operation indicated below. Set the protection to OFF beforehand. (See Section 4.4.1.)

Operation (example)	Description	Display
	Set the range type to single range and "FULL SCALE1" to flow rate 60m <sup>3</sup> /h. * Set the piping parameters and "FLOW UNIT" beforehand.	
Key operation	Description	Display
	Press the  key twice to display "OUTPUT SETUP".	OUTPUT SETUP
	Press the  key to enter the "ZERO ADJUSTMENT" mode.	ZERO ADJUSTMENT SET ZERO
	Press the  key for 4 times to display "RANGE".	RANGE
	Press the  key once to display "KIND".	KIND
	Because flow rate (factory set) is already registered, go to the next step	FLOW RATE
	Press the  key to display "RANGE TYPE"	RANGE TYPE
	Because single range (factory set) is already registered, go to the next step.	SINGLE
	Press the  key once to display "FULL SCALE1".	FULL SCALE1
		15.000 m <sup>3</sup> /h
	Press the  key once to blink the cursor.	FULL SCALE1 00015.000 m <sup>3</sup> /h
		00015.000 m <sup>3</sup> /h
	Move the cursor by the  key, and change the numeric value by the  key.	00015.000 m <sup>3</sup> /h
		00065.000 m <sup>3</sup> /h
		00065.000 m <sup>3</sup> /h
	Change the full scale1 to "60".	FULL SCALE1
	Note) To change the decimal point position, align the cursor with a place to change to and press the  key likewise.	000060.0 m <sup>3</sup> /h
		FULL SCALE1
	Press the  key once to register.	** COMPLETE **
		↓
	----- FULL SCALE1 has been registered. -----	FULL SCALE1
		60.000 m <sup>3</sup> /h





Press the  key for 2 times and then press the  key for 3 times to enter the measurement mode.

----- 0.000 ----- m/s
0.000 m3/h

### 4.9.1.2. Setting of analog output at error (Burnout)

**Description**

- Determine how to set the analog output when received wave error, etc. due to device error, accidental drain of piping or entry of bubbles.

- **Settable range**

(1) Analog output (4-20mA) at error

HOLD (factory set): Outputs a current value preceding the error.

UPPER : Sets analog output to upper of the output limit (over scale).

LOWER : Sets analog output to lower of the output limit (under scale).

ZERO : Outputs 4mA.

(2) BURNOUT TIMER (time from error detection to BURNOUT processing) 10 to 900 seconds (factory set at 10 sec). Please set 10 seconds or more.

\* Perform BURNOUT processing as shown below.

1. LCD display ..... Measured value operates with analog output.

For actual keying, refer to the typical operation indicated below. Set the protection to OFF beforehand. (See Section 4.4.1.)

Operation (example)	Set "UPPER" to BURNOUT. Set "20sec" to BURNOUT TIMER. * Set the piping parameters and "FLOW UNIT" beforehand.	
Key operation	Description	Display
	Press the  key twice to display "OUTPUT SETUP".	OUTPUT SETUP
	Press the  key once to display "ZERO ADJUSTMENT".	ZERO ADJUSTMENT SET ZERO
	Press the  key for 4 times to display "RANGE".	RANGE
	Press the  key once to display "KIND".	KIND FLOW RATE
	Press the  key for 5 times to display "BURNOUT" (CURRENT).	BURNOUT (CURRENT) HOLD
	Press the  key once to blink on the 2nd line.	BURNOUT (CURRENT) HOLD
	Press the  key once to display "UPPER".	BURNOUT (CURRENT) UPPER
	Press the  key once to register.	BURNOUT (CURRENT) ** COMPLETE **
	----- UPPER has been registered. -----	BURNOUT (CURRENT) UPPER
	Press the  key once to display "BURNOUT TIMER".	BURNOUT TIMER 10 sec
	Press the  key once to blink the cursor.	BURNOUT TIMER 010 sec
	Press the  key once to align the cursor to "1".	BURNOUT TIMER 010 sec
	Press the  key once to set "2".	BURNOUT TIMER 020 sec
	Press the  key once to register.	BURNOUT TIMER ** COMPLETE **
	----- BURNOUT TIMER has been registered. -----	BURNOUT TIMER 20 sec
	Press the  key twice and then press the  key for 3 times to enter the measurement mode.	0.000 m/s 0.000 m3/h

### 4.9.1.3. Output limit

**Description**

- Upper and lower limits can be set within the range of analog output 0.8mA to 23.2mA (-20% to 120%).
- Settable range
  - (1) Output lower limit: -20% to 0% (0.8mA to 4mA)
  - (2) Output upper limit: 100% to 120% (20mA to 23.2mA)

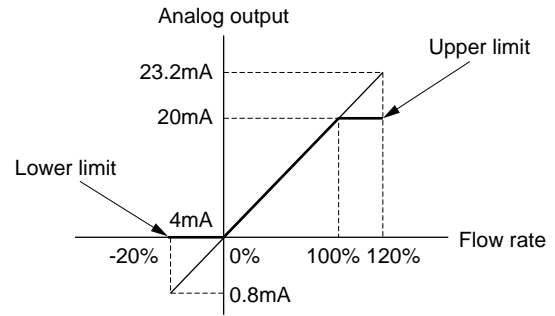

For actual keying, refer to the typical operation indicated below. Set the protection to OFF beforehand. (See Section 4.4.1.)

Operation (example)	Description	Display
Key operation	Set "-10% (2.4mA)" to lower limit, and "110% (21.6mA)" to upper limit. * Set the piping parameters and "FLOW UNIT" beforehand.	
	Press the  key twice to display "OUTPUT SETUP".	OUTPUT SETUP
	Press the  key once to display "ZERO ADJUSTMENT".	ZERO ADJUSTMENT SET ZERO
	Press the  key for 4 times to display "RANGE".	RANGE
	Press the  key once to display "KIND".	KIND FLOW RATE
	Press the  key for 7 times to display "OUTPUT LIMIT LOW".	OUTPUT LIMIT LOW -20 %
	Press the  key once to blink the cursor.	OUTPUT LIMIT LOW 20 %
	Press the  key once to align the cursor to "2".	OUTPUT LIMIT LOW 20 %
	Press the  key several times to set "1".	OUTPUT LIMIT LOW 10 %
	Press the  key once to register.	OUTPUT LIMIT LOW ** COMPLETE **
	----- OUTPUT LIMIT LOW has been registered. -----	OUTPUT LIMIT LOW -10 %
	Press the  key once to display "OUTPUT LIM. HIGH".	OUTPUT LIM. HIGH 120 %
	Press the  key once to blink the cursor.	OUTPUT LIM. HIGH 120 %
	Press the  key once to align the cursor to "2".	OUTPUT LIM. HIGH 120 %
	Press the  key several times to set "1".	OUTPUT LIM. HIGH 110 %
	Press the  key once to register.	OUTPUT LIM. HIGH ** COMPLETE **
	----- OUTPUT LIM. HIGH has been registered. -----	OUTPUT LIM. HIGH 110 %
	Press the  key twice and then press the  key for 3 times to enter the measurement mode.	0.000 m/s 0.000 m3/h

## 4.9.2. Setting the total(actual)

### 4.9.2.1. Setting the total pulse (total rate, pulse width)

#### Description

- Set to totalize a process variable (flow rate) by total meter, etc. according to total pulse output.
- Total rate : Total amount (volume) per pulse.  
A pulse is outputted when the total volume has attained an amount set by the pulse value, and adds to the total pulse count (in case of total pulse indication). Settable range: 0.000001 to 99999999  
\* Set the total unit before setting the pulse value. (See Section 4.8.3.)
- Pulse width: Width of total pulse output.  
Select a pulse width according to a corresponding total meter out of menus. Settable range: 5ms, 10ms, 50ms, 100ms, 200ms, 500ms, 1000ms.
- Restrictions in the setup  
Output of total pulses involves the following restrictions depending on the DO output port (DO1 and DO2).

DO output port	Frequency range of pulse output (at full scale flow rate)	Pulse width
DO1, DO2: Transistor, open collector	100 pulse/sec	5ms, 10ms, 50ms, 100ms, 200ms

The maximum output frequency is also restricted by the setup of the pulse width. Therefore, set the pulse width and pulse value so that both of condition 1 and condition 2 indicated below are satisfied. Correct results may not occur, if any setup that does not satisfy both of condition 1 and condition 2 is made.

#### Condition 1:

$$\frac{\text{FULL SCALE}^{(\text{Note1})} [\text{m}^3/\text{s}]}{\text{TOTAL RATE} [\text{m}^3]} \leq 100[\text{Hz}]$$

#### Condition 2:

$$\frac{\text{FULL SCALE}^{(\text{Note1})} [\text{m}^3/\text{s}]}{\text{TOTAL RATE} [\text{m}^3]} \leq \frac{1000}{2 \times \text{PULSE WIDTH} [\text{ms}]}$$

Note 1) The range of FULL SCALE1 or FULL SCALE2, whichever is larger, is the object in the case of automatic 2-range setup, forward and reverse range setup or forward and reverse automatic 2-range setup.

Note 2) The output frequency on the output ports is limited when the flow rate exceeds the set range. Therefore, if such a setup that the maximum frequency per range occurs at the time of 100% flow rate, there is possibility that the total pulse output will be incapable of following when the flow rate exceeds 100%, and accurate total value cannot be obtained if over-range continues for a long time. If there are cases where the flow rate exceeds 100%, modify the set range and pulse value so that the maximum frequency will not exceed the restricted level.

#### Example of calculation

Calculate the range that permits setup of the total value under the range and pulse width indicated below.

When the range and the pulse width are as follows.

FLOW SPAN -1: 36[m<sup>3</sup>/h] (=0.01[m<sup>3</sup>/s]), Pulse width:50[ms]

#### Condition 1

$$\begin{aligned} \text{TOTAL RATE} &\geq \frac{\text{FULL SCALE} [\text{m}^3/\text{s}]}{100[\text{Hz}]} = \frac{0.01 [\text{m}^3/\text{s}]}{100 [\text{Hz}]} \\ &= 0.0001 [\text{m}^3] = 0.1 [\text{L}] \end{aligned}$$

As above:

$$0.1 [\text{L}] \leq \text{TOTAL RATE} \dots\dots\dots \text{A}$$

#### Condition 2

$$\begin{aligned} \text{TOTAL RATE} &\geq \text{FULL SCALE} [\text{m}^3/\text{s}] \times \frac{2 \times \text{PULSE WIDTH} [\text{ms}]}{1000} = 0.01 [\text{m}^3/\text{s}] \times \frac{2 \times 50 [\text{ms}]}{1000} \\ &= 0.001 [\text{m}^3] = 1 [\text{L}] \dots\dots\dots \text{B} \end{aligned}$$

The settable range of the total value that satisfies both of condition 1 and condition 2 is as follows from results of calculation A and B.

$$1 [\text{L}] \leq \text{TOTAL RATE}$$

Note) When the total setting value is "0", total pulse is not output.

Note) When setting, stop status is set at the total mode.

For actual keying, refer to the typical operation indicated below. Set the protection to OFF beforehand. (See Section 4.4.1.)

Operation (example)	Set total value to 0.1m <sup>3</sup> /pulse, and pulse width to 100ms. * Set the total value beforehand.	
Key operation	Description	Display
	Press the  key twice to display "OUTPUT SETUP".	OUTPUT SETUP
	Press the  key once to display "ZERO ADJUSTMENT".	ZERO ADJUSTMENT SET ZERO
	Press the  key for 5 times to display "TOTAL".	TOTAL
	Press the  key once to display "TOTAL MODE".	TOTAL MODE STOP
	Press the  key once to display "TOTAL RATE"	TOTAL RATE 0 m3
	Press the  key once to display the cursor.	TOTAL RATE 00000000 m3
	Press the  key for 7 times to move the cursor.	TOTAL RATE 00000000 m3
	Press the  key several times to display decimal point.	TOTAL RATE 000000.0 m3
	Press the  key once to move the cursor.	TOTAL RATE 000000.0 m3
	Press the  key once to display "1".	TOTAL RATE 000000.1 m3
	Press the  key once to register.	TOTAL RATE ** COMPLETE **
	----- "TOTAL RATE" has been registered. -----	TOTAL RATE 0.1 m3
	Press the  key twice to display "PULSE WIDTH".	PULSE WIDTH 50.0 msec
	Press the  key once to blink the cursor.	PULSE WIDTH 50.0 msec
	Press the  key twice, and select "100.0msec".	PULSE WIDTH 100.0 msec
	Press the  key once to register.	PULSE WIDTH ** COMPLETE **
	----- PULSE WIDTH has been registered. -----	PULSE WIDTH 100.0 msec
	Press the  key for 3 times to display "TOTAL MODE".	TOTAL MODE STOP
	Press the  key once to blink the cursor.	TOTAL MODE STOP
	Press the  key once, and select "TOTAL PRESET".	TOTAL MODE TOTAL RESET
	Press the  key once to register.	TOTAL MODE ** COMPLETE **
	----- TOTAL MODE has been registered. -----	TOTAL MODE TOTAL RESET
	Press the  key twice and then press the  key for 3 times to enter the measurement mode.	0.000 m/s 0.000 m3/h

### 4.9.2.2. Setting the preset value

**Description**

- **Preset value:** Value which appears on the total counter when the total value has been reset.
- **Settable range:** 0 to 99999999
- <Note> A resetting action simultaneously resets both forward total memory and reverse total memory.
- Set the total unit beforehand in the MEASURE SETUP mode. (Refer to 4.8.3.)
- When setting, stop status is set at the total mode.

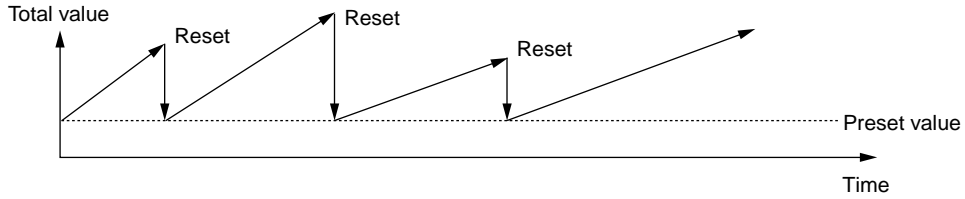

For actual keying, refer to the typical operation indicated below. Set the protection to OFF beforehand. (See Section 4.4.1.)

Operation (example)	Description	Display
Key operation	Set the preset value to 100m <sup>3</sup> . * Set the total unit beforehand.	
△	Press the △ key twice to display "OUTPUT SETUP".	OUTPUT SETUP
▼		
ENT	Press the ENT key once to display "ZERO ADJUSTMENT".	ZERO ADJUSTMENT SET ZERO
▼		
△	Press the △ key for 5 times to display "TOTAL".	TOTAL
▼		
ENT	Press the ENT key once to display "TOTAL MODE".	TOTAL MODE STOP
▼		
△	Press the △ key twice to display "TOTAL PRESET"	TOTAL PRESET 0 m3
▼		
ENT	Press the ENT key once to display the cursor.	TOTAL PRESET 0000000
▼		
▶	Press the ▶ key for 6 times to move the cursor. * Note that, it cannot be entered on the first digit (leftmost).	TOTAL PRESET 0000000 m3
▼		
△	Press the △ key once to display "1".	TOTAL PRESET 00000100 m3
▼		
ENT	Press the ENT key once to register.	TOTAL PRESET ** COMPLETE **
▼		
▼	----- "TOTAL PRESET" has been registered. -----	TOTAL PRESET 100 m3
▼		
△	Press the △ key for 4 times to display "TOTAL MODE".	TOTAL MODE STOP
▼		
ENT	Press the ENT key once to blink the cursor.	TOTAL MODE STOP
▼		
△	Press the △ key once, and select "TOTAL PRESET".	TOTAL MODE TOTAL RESET
▼		
ENT	Press the ENT key once to register.	TOTAL MODE ** COMPLETE **
▼		
▼	----- "TOTAL MODE" has been registered. -----	TOTAL MODE TOTAL RESET
▼		
ESC △	Press the ESC key twice and then press the △ key for 3 times to enter the measurement mode.	0.000 m/s 0.000 m3/h

### 4.9.2.3. TOTAL mode (total reset, start, stop)

**Description**

- The total is started, stopped or reset.
- Settable range: START, STOP, TOTAL RESET
- START : Starts totalizing. Totalizes continuously from the stopped status.
- STOP : Stops totalizing. Setting cannot be changed when it is not stopped.
- RESET: Resets the total memory to the reset value, and starts totalizing.
- <Note> A resetting action simultaneously resets both forward total memory and reverse total memory.

For actual keying, refer to the typical operation indicated below. Set the protection to OFF beforehand. (See Section 4.4.1.)

Operation (example)	Reset the total value (reset value 0m <sup>3</sup> ), and restart a total. *Set the "TOTAL UNIT" beforehand. Refer to "4.9.4 Setting the LCD indication"	
Key operation	Description	Display
		<div style="border: 1px solid black; padding: 2px; text-align: center;">           0.00      m3/h            -----            + 127.26      m3         </div>
△	Press the △ key twice to display "OUTPUT SETUP".	<div style="border: 1px solid black; padding: 2px; text-align: center;">           OUTPUT SETUP            -----         </div>
▼		
ENT	Press the ENT key once to display "ZERO ADJUSTMENT".	<div style="border: 1px solid black; padding: 2px; text-align: center;">           ZERO ADJUSTMENT      SET ZERO            -----         </div>
▼		
△	Press the △ key for 5 times to display "TOTAL".	<div style="border: 1px solid black; padding: 2px; text-align: center;">           TOTAL            -----         </div>
▼		
ENT	Press the ENT key once to display "TOTAL MODE".	<div style="border: 1px solid black; padding: 2px; text-align: center;">           TOTAL MODE      START            -----         </div>
▼		
ENT	Press the ENT key once to blink the cursor.	<div style="border: 1px solid black; padding: 2px; text-align: center;">           TOTAL MODE      <b>START</b>            -----         </div>
▼		
△	Press the △ key twice to display "TOTAL RESET".	<div style="border: 1px solid black; padding: 2px; text-align: center;">           TOTAL MODE      <b>TOTAL RESET</b>            -----         </div>
▼		
ENT	Press the ENT key twice to execute "TOTAL RESET".	<div style="border: 1px solid black; padding: 2px; text-align: center;">           TOTAL MODE      ** COMPLETE **            -----         </div>
▼		
▼	----- The total operation is started. -----	<div style="border: 1px solid black; padding: 2px; text-align: center;">           TOTAL MODE      TOTAL RESET            -----         </div>
▼		
▼		
▼		
ESC   △	Press the ESC key twice and then press the △ key for 3 times to enter the measurement mode.	<div style="border: 1px solid black; padding: 2px; text-align: center;">           0.00      m3/h            -----            0.00      m3         </div>

#### 4.9.2.4. Determining how to dispose of total at error (BURNOUT)

Description

**BURNOUT (TOTAL)**

- Determines how to dispose of the total when the measurement status is abnormal on account of an empty pipe interior or bubbles mixed in fluid (common to total indication and total pulse output).
- Settable range:  
 HOLD : Stops the total (as factory set).  
 NOT USED: Continues the total according to a flow rate marked immediately before the error occurrence.

**BURNOUT TIMER**

- Sets the time from error occurrence to error processing.
- Settable range: 10 to 900sec (factory set: 10sec) Please set 10 seconds or more.  
 The total continues until the burnout timer is actuated.

For actual keying, refer to the typical operation indicated below. Set the protection to OFF beforehand. (See Section 4.4.1.)

Operation (example)	Change the processing from "BURNOUT" to "HOLD", and change the burnout timer setting from 10 seconds to 15 seconds.	
Key operation	Description	Display
	Press the  key twice to display "OUTPUT SETUP".	OUTPUT SETUP
	Press the  key once to display "ZERO ADJUSTMENT".	ZERO ADJUSTMENT SET ZERO
	Press the  key for 5 times to display "TOTAL".	TOTAL
	Press the  key once to display "TOTAL MODE".	TOTAL MODE START
	Press the  key for 4 times to display "BURNOUT(TOTAL)".	BURNOUT(TOTAL)
	Because HOLD (factory set) is already registered, go to the next step.	HOLD
	Note) For setting "NOT USED", press the //ENT key, and the /// key to select "NOT USED".	
	Press the  key once to display "BURNOUT TIMER".	BURNOUT TIMER 10sec
	Press the  key once to blink the cursor.	BURNOUT TIMER 010sec
	Press the  key twice to move the cursor.	BURNOUT TIMER 010sec
	Press the  key for 5 times to set "5".	BURNOUT TIMER 015sec
	Press the  key once to register.	BURNOUT TIMER ** COMPLETE **
	----- BURNOUT TIMER has been registered. -----	BURNOUT TIMER 15sec
	Press the  key twice and then press the  key for 3 times to enter the measurement mode.	0.00 m3/h + 0.00 m3



### 4.9.3. Setting the DO output

**Description**

- Selects the output of total pulses and statuses (of alarm, flow switch, total switch, etc.).
- Settable range (common to DO1, DO2 )
  - NOT USED : Does not use the contact output.
  - +TOTAL PULSE : Outputs the forward total pulses.
  - TOTAL PULSE : Outputs total pulse in reverse direction.
  - FULL SCALE 2 : Selects a contact output as FULL SCALE 2 measurement status.  
(forward automatic 2 ranges, forward and reverse range, forward/reverse automatic 2 ranges)
- ALARM
  - ALL : Selects a contact output at HARDWARE FAULT or PROCESS ERROR status.
  - HARDWARE FAULT : Selects a contact output when circuit error such as memory occurred.
  - PROCESS ERROR : Selects a contact output when no waves are received, or waves are unstable.
- FLOW SWITCH
  - FLOW SW HIGH : Selects a contact output when flow rate is above the setting.
  - FLOW SW LOW : Selects a contact output when flow rate is below the setting.
- TOTAL SWITCH : Selects a contact output when total value exceeds the setting.
- AO RANGE OVER : Selects a contact output when the lower and upper limits of range are above the setting.
- PULSE RANGE OVER : Selects a contact output when the total pulse output exceeds the maximum output frequency.
- FLOW DIRECTION : Selects a contact output when the flow is in reverse direction.
- CONTACT ACTION
  - ACTIVE ON : Normally off
  - ACTIVE OFF : Normally on

## ! CAUTION

- If the contact action is set to "ACTIVE OFF", DO output is provided when the power is turned on.
- Check if DO output can be modified before setting.

<Note> DO output specifications

DO1/DO2 : Open collector, Contact capacity 30V DC, 50mA

When total pulse output is selected (Note: See 4.9.2.1)

100 pulses/s or less (at full scale flow rate)

Pulse width: 5, 10, 50, 100, 200,500 and 1000ms.

For actual keying, refer to the typical operation indicated below. Set the protection to OFF beforehand. (See Section 4.4.1.)

#### 4.9.3.1. How to validate the total pulse output

**Description**

- Validates the total pulse output for DO1 OUT and/or DO2 OUT.
  - + TOTAL PULSE : Outputs flow rate total pulse in forward direction.
  - TOTAL PULSE: Reverse flow rate total pulse output.
- Note) Referring to Section 4.9.2.1., set the pulse value, pulse width, etc.

For concrete keying, refer to the typical operation indicated below. Set the protection to OFF beforehand. (See Section 4.4.1.)

Operation (example)	Set the DO1 output to "+ TOTAL PULSE". Also, set the contact to "ACTIVE ON".	
Key operation	Description	Display
△	Press the △ key twice to display "OUTPUT SETUP".	OUTPUT SETUP
▼		
ENT	Press the ENT key once to display "ZERO ADJUSTMENT".	ZERO ADJUSTMENT SET ZERO
▼		
△	Press the △ key for 6 times to display "DO1 OUT".	DO1 OUT NOT USED
▼	* Press the △ key again to display "DO2 OUT".	
ENT	Press the ENT key once to blink the cursor.	DO1 OUT NOT USED
▼		
△	Press the △ key once to display "+ TOTAL PULSE" on the 2nd line.	DO1 OUT +TOTAL PULSE
▼	Press the △ key again to select "- TOTAL PULSE".	
ENT	Press the ENT key once to register "+TOTAL PULSE".	DO1 OUT ** COMPLETE **
▼		↓

▼ ▼ ▼ ENT ▼ ENT ▼ ▼ ▼ ▼ ▼ ESC    △	----- "+TOTAL PULSE" has been registered. -----  Press the <b>ENT</b> key once to display "CONTACT ACTION".  Press the <b>ENT</b> key once to register "ACTIVE ON" (normally off).  * To select normally on, press the <b>△</b> key.  ----- "ACTIVE ON" has been registered. -----  Press the <b>ESC</b> key twice and then press the <b>△</b> key for 3 times to enter the measurement mode.	<table border="1"> <tr><td>STATUS OUT</td><td><b>CONTACT ACTION</b></td></tr> <tr><td>CONTACT ACTION</td><td><b>ACTIVE ON</b></td></tr> <tr><td>CONTACT ACTION</td><td>** COMPLETE **</td></tr> <tr><td colspan="2" style="text-align: center;">↓</td></tr> <tr><td>STATUS OUT</td><td><b>CONTACT ACTION</b></td></tr> <tr><td>0.000</td><td>m3/h</td></tr> <tr><td>0.000</td><td>m3</td></tr> </table>	STATUS OUT	<b>CONTACT ACTION</b>	CONTACT ACTION	<b>ACTIVE ON</b>	CONTACT ACTION	** COMPLETE **	↓		STATUS OUT	<b>CONTACT ACTION</b>	0.000	m3/h	0.000	m3
STATUS OUT	<b>CONTACT ACTION</b>															
CONTACT ACTION	<b>ACTIVE ON</b>															
CONTACT ACTION	** COMPLETE **															
↓																
STATUS OUT	<b>CONTACT ACTION</b>															
0.000	m3/h															
0.000	m3															

## 4.9.4. Setting the LCD indication

### Description

- Flow velocity indication  
 Selectable flow velocity units: m/s (if SYSTEM UNIT was set to METRIC) (See 4.8.1)  
 <Note> The decimal point position is fixed. (Decimal point 3 digits)
- Flow rate indication  
 Selectable flow rate indications: Actual value reading, % reading.  
 <Note> The indication unit is as selected by FLOW UNIT. (See 4.8.2.)
- Total indication  
 Selectable total indications: Actual total value reading (forward/reverse flow), total pulse count (forward/reverse flow).  
 <Note> The indication unit is as selected by TOTAL UNIT. (See 4.8.3.)
- How to validate the indication  
 Set the DISPLAY setting mode to 1st ROW (for indication on 1st line) or 2nd ROW (for indication on 2nd line), and further select indication contents.

For actual keying, refer to the typical operation indicated below. Set the protection to OFF beforehand. (See Section 4.4.1.)

Operation (example)	Display the 1st line of LCD indication in percentages (%).	
Key operation	Description	Display
	Press the  key twice to display "OUTPUT SETUP".	
	Press the  key once to display "ZERO ADJUSTMENT".	
	Press the  key for 3 times to display "DISPLAY".	
	Press the  key once to blink the cursor.	
	Press the  key again, and select "1ST LOW".	
	Press the  key twice to display "FLOW RATE(%)".	
	Press the  key once, and select and fix "FLOW RATE(%)" to display "1:DECIMAL POINT".	
	Press the  key once to shift the decimal point position to next place.	
	Press the  key once to register.	
	——— FLOW RATE(%) indication has been set. ———	
	Press the  key twice and then press the  key for 3 times to enter the measurement mode.	

## 4.9.5. Setting the damping

### Description

- Used for attenuating the variation of measured value.  
A time constant is set (response time of about 63%).

Settable range: 0.0 to 100.0sec in 0.1 sec steps

Note) In case you set to 0 sec, response time become as below.

- System cycle 0.2sec
- Dead time 0.2sec or less, time constant 0.1sec

For actual keying, refer to the typical operation indicated below. Set the protection to OFF beforehand. (See Section 4.4.1.)

Operation (example)	Change the damping from 5 to 20 sec.	
Key operation	Description	Display
△	Press the △ key twice to display "OUTPUT SETUP".	OUTPUT SETUP
▼		
ENT	Press the ENT key once to display "ZERO ADJUSTMENT".	ZERO ADJUSTMENT SET ZERO
▼		
△	Press the △ key once to display "DAMPING".	DAMPING 5.0 sec
▼		
ENT	Press the ENT key once to blink the cursor.	DAMPING 005.0 sec
▼		
		005.0 sec
		025.0 sec
		025.0 sec
△ ▶	Set "20" by the △ key and the ▶ key.	DAMPING 020.0 sec
▼		
ENT	Press the ENT key once to register.	DAMPING ** COMPLETE **
▼		
▼		
▼		
	----- DAMPING has been registered. -----	DAMPING 20 sec
ESC △	Press the ESC key once and then press the △ key for 3 times to enter the measurement mode.	0.000 % 0.000 m3

## 4.9.6. Setting the low flow rate cutting

**Description**

- The output can be cut when the flow rate is too small.
- Effective for indication, analog output (4-20mA) and total operation.

Settable range: 0 to 5 [m/s] in terms of flow velocity.  
(Factory set: 0.150 [m<sup>3</sup>/h])

Note 1) As required, set the low flow rate cut because the flow meter may read a flow rate when the fluid in the piping is moving on account of convection, etc. even if the valves are closed.

Note 2) The flow rate unit is as selected by "FLOW UNIT" in "MEASURE SETUP".  
(See 4.8.2.)

For actual keying, refer to the typical operation indicated below. Set the protection to OFF beforehand. (See Section 4.4.1.)

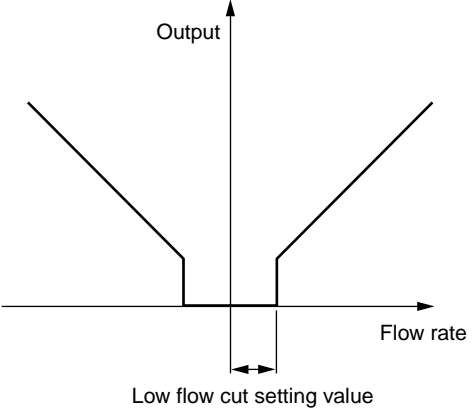

Operation (example)	Set the low flow rate cut point to 0.5 [m <sup>3</sup> /h].	
Key operation	Description	Display
△	Press the △ key twice to display "OUTPUT SETUP".	OUTPUT SETUP
▼		
ENT	Press the ENT key once to display "ZERO ADJUSTMENT".	ZERO ADJUSTMENT SET ZERO
▼		
△	Press the △ key twice to display "CUT OFF".	CUT OFF 0.150 m3/h
▼		
ENT	Press the ENT key once to blink the cursor.	CUT OFF 0000.150 m3/h
▼		
		0000.150 m3/h
		0000.550 m3/h
		0000.550 m3/h
△ ▶	Set "0.5" by the △ key and the ▶ key.	CUT OFF 0000.500 m3/h
▼		
ENT	Press the ENT key once to register.	CUT OFF ** COMPLETE **
▼		
▼		
▼		
ESC △	Press the ESC key once and then press the △ key for 3 times to enter the measurement mode.	CUT OFF 0.500 m3/h
		0.000 % 0.000 m3

## 4.10. Application operation of parameter

### 4.10.1. Setting automatic 2 ranges

#### Description

- The function carries out a measurement while changing over the range according to the flow rate.
- The current output changes with the action range as illustrated on the right.
- The hysteresis can be set to between 0 and 20% of the smaller range.
- Upon setting DO1 and/or DO2 to "FULL SCALE 2", a contact outputs "FULL SCALE 2" action. Select "ACTIVE ON" or "ACTIVE OFF" separately. (See 4.10.5.)
- Settable range: 0.3 to 32 [m/s] in terms of flow velocity in piping for any of FULL SCALE1 and FULL SCALE2.
  - \* Preset PIPE PARAMETER and FLOW UNIT.
  - \* If a value beyond the settable range is inputted, "INPUT ERROR" appears and then last setting is resumed.
  - \* If "FLOW UNIT" has been changed after setting the range, redo the range setting.
  - \* When FULL SCALE2 is not used (in the case of single range), set "0" to FULL SCALE2.

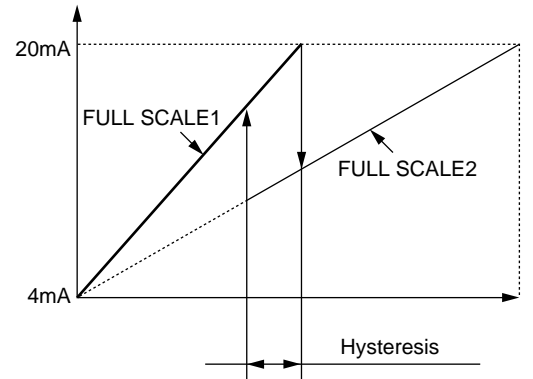

<Note> The flow rate unit is as selected by "FLOW UNIT". Before setting range, set the "FLOW UNIT". (See 4.8.2.)

For actual keying, refer to the typical operation indicated below. Set the protection to OFF beforehand. (See Section 4.4.1.)

Operation (example)	Set "AUTO 2" to "RANGE TYPE", 10[m <sup>3</sup> /h] to "FULL SCALE1", and 60[m <sup>3</sup> /h] to "FULL SCALE2". Set "RANGE HYS." to 7%. * Preset "PIPE PARAMETER" and "FLOW UNIT".	
Key operation	Description	Display
△	Press the △ key twice to display "OUTPUT SETUP".	OUTPUT SETUP
ENT	Press the ENT key once to display "ZERO ADJUSTMENT".	ZERO ADJUSTMENT SET ZERO
△	Press the △ key for 4 times to display "RANGE".	RANGE
ENT	Press the ENT key once to display "KIND"	KIND FLOW RATE
△	Press the △ key once to display "RANGE TYPE"	RANGE TYPE SINGLE RANGE
ENT	Press the ENT key twice to blink the cursor.	RANGE TYPE SINGLE
△	Press the △ key once, and select "AUTO 2".	RANGE TYPE AUTO 2
ENT	Press the ENT key once to display "RANGE TYPE".	RANGE TYPE AUTO 2
△	Press the △ key once to display "FULL SCALE1".	FULL SCALE1 20.0000 m3/h
ENT	Press the ENT key once to blink the cursor on the 2nd line.	FULL SCALE1 0020.0000 m3/h
▶	Press the ▶ key several times to align the cursor to "2".	FULL SCALE1 0020.0000 m3/h
△	Press the △ key several times to change to "1".	FULL SCALE1 0010.0000 m3/h
ENT	Note) To change the decimal point position, align the cursor with a place to change to, and press the △ key. Press the ENT key once to register.	FULL SCALE1 ** COMPLETE **
	----- FULL SCALE1 has been registered. -----	FULL SCALE1 10.0000 m3/h

▲	Press the ▲ key once to display "FULL SCALE2".	FULL SCALE2 ----- 0.0000 m3/h
▼		
ENT	Press the ENT key once to blink the cursor.	FULL SCALE2 0000.0000 m3/h
▼		
▶	Press the ▶ key twice to move the cursor.	FULL SCALE2 0000.0000 m3/h
▼		
▲	Press the ▲ key for 6 times to set "6".	FULL SCALE2 0060.0000 m3/h
▼		
ENT	Press the ENT key once to register.	FULL SCALE2 ** COMPLETE **
▼		↓
▼		FULL SCALE2 60.0000 m3/h
▲	Press the ▲ key once to display "RANGE HYS.".	RANGE HYS. ----- 5.00 %
▼		
ENT	Press the ENT key once to blink the cursor.	RANGE HYS. 05.00 %
▼		
▶	Press the ▶ key once to move the cursor.	RANGE HYS. 05.00 %
▼		
▲	Press the ▲ key twice to set "7".	RANGE HYS. 07.00 %
▼		
ENT	Press the ENT key once to register.	RANGE HYS. ** COMPLETE **
▼		↓
▼		RANGE HYS. 7.00 %
ESC ▲	Press the ESC key twice and then press the ▲ key for 3 times to enter the measurement mode.	0.000 % 0.000 m3

## 4.10.2. Setting the Bi-directional range

### Description

- The function measures the flow rate of either forward or reverse flow while changing over the range corresponding to the flow direction.
- The current output changes with the action range as illustrated on the right.
- The hysteresis can be set to between 0 and 20% of the action range.
- Upon setting DO1 and/or DO2 to "FULL SCALE2", a contact outputs "FULL SCALE2" action.  
Select "ACTIVE ON" or "ACTIVE OFF" separately. (See 4.10.5.)
- Settable range:  $\pm 0.3$  to  $32$  [m/s] in terms of flow velocity in piping for any of FULL SCALE1 and FULL SCALE2.  
\* Preset PIPE PARAMETER and FLOW UNIT.  
\* If a value beyond the settable range is inputted, "INPUT ERROR" appears and then last setting is resumed.  
\* If "FLOW UNIT" has been changed after setting the range, redo the range setting.  
\* When FULL SCALE2 is not used (in the case of single range), set "0" to FULL SCALE2.

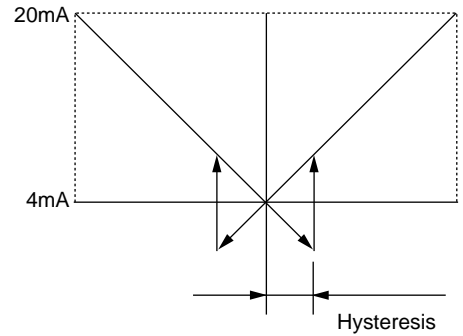

<Note> The flow rate unit is as selected by "FLOW UNIT" in "MEASURE SETUP" mode. Before setting range, set the "FLOW UNIT". (See 4.8.2.)

For actual keying, refer to the typical operation indicated below. Set the protection to OFF beforehand. (See Section 4.4.1.)

Operation (example)	Set "BI-DIR" to "RANGE TYPE", 20[m <sup>3</sup> /h] to "FULL SCALE1", and -10[m <sup>3</sup> /h] to "FULL SCALE2". Set "RANGE HYS." to 7%. * Preset "PIPE PARAMETER" and "FLOW UNIT".	
Key operation	Description	Display
	Press the  key twice to display "OUTPUT SETUP".	OUTPUT SETUP
	Press the  key once to display "ZERO ADJUSTMENT".	ZERO ADJUSTMENT SET ZERO
	Press the  key for 4 times to display "RANGE".	RANGE
	Press the  key once to display "KIND"	KIND FLOW RATE
	Press the  key once to display "RANGE TYPE"	RANGE TYPE SINGLE RANGE
	Press the  key twice to blink the cursor.	RANGE SINGLE
	Press the  key twice, and select "BI-DIR".	RANGE TYPE BI-DIR
	Press the  key for 4 times to display "RANGE TYPE".	RANGE TYPE BI-DIR
	Press the  key once to display "FULL SCALE1".	FULL SCALE1 50.0000 m <sup>3</sup> /h
	Press the  key once to blink the cursor.	FULL SCALE1 0050.0000 m <sup>3</sup> /h
	Press the  key several times to align the cursor to "5".	FULL SCALE1 0050.0000 m <sup>3</sup> /h
	Press the  key several times to set "2".	FULL SCALE1 0020.0000 m <sup>3</sup> /h
	Note) To change the decimal point position, align the cursor with a place to change to, and press the  key.	
	Press the  key once to register.	FULL SCALE1 ** COMPLETE **
	----- FULL SCALE1 has been registered. -----	FULL SCALE1 20.0000 m <sup>3</sup> /h
	Press the  key once to display "FULL SCALE2".	FULL SCALE2 0.0000 m <sup>3</sup> /h



ENT

Press the ENT key once to register.

△

Press the △ key several times to display “-” on the 1st line.

▶

Press the ▶ key twice to move the cursor.

△

Press the △ key once to set “1”.

ENT

Press the ENT key once to register.

▼

▼

▼

△

Press the △ key once to display “RANGE HYS.”.

ENT

Press the ENT key once to blink the cursor.

▶

Press the ▶ key once to move the cursor.

△

Press the △ key twice to set “7”.

ENT

Press the ENT key once to register.

▼

▼

▼

ESC △

Press the ESC key twice and then press the △ key for 3 times to enter the measurement mode.

FULL SCALE2  
0000.0000 m3/h

FULL SCALE2  
-000.0000 m3/h

FULL SCALE2  
-000.0000 m3/h

FULL SCALE2  
-001.0000 m3/h

FULL SCALE2  
\*\* COMPLETE \*\*

↓

FULL SCALE2  
-10.0000 m3/h

RANGE HYS.  
5.00 %

RANGE HYS.  
05.00 %

RANGE HYS.  
05.00 %

RANGE HYS.  
07.00 %

RANGE HYS.  
\*\* COMPLETE \*\*

↓

RANGE HYS.  
7.00 %

0.000 %  
0.000 m3

### 4.10.3. Setting the Bi-directional auto 2 range

**Description**



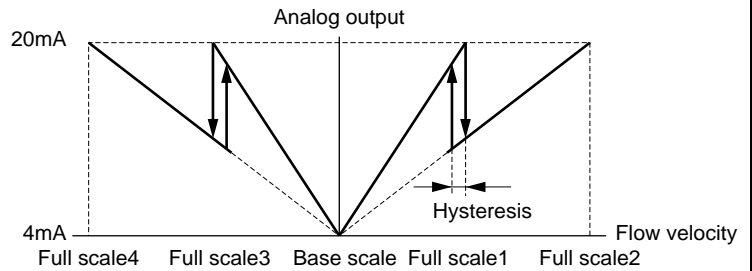









- The function measures the flow rate of either forward or reverse flow while changing over the range corresponding to the flow direction.
- The current output changes with the action range as illustrated on the right.
- The hysteresis can be set to between 0 and 20% of either range of FULL SCALE1 or FULL SCALE2 and FULL SCALE3 or FULL SCALE4 whichever the span is smaller.
- Upon setting DO1 and/or DO2 to "FULL SCALE2", a contact outputs "FULL SCALE2" action. Select "ACTIVE ON" or "ACTIVE OFF" separately. (See 4.10.5.)
- Settable range:  $\pm 0.3$  to 32[m/s] in terms of flow velocity in piping for any of FULL SCALE1 and FULL SCALE2. When FULL SCALE1 and FULL SCALE2 are set, FULL SCALE3 and FULL SCALE4 are automatically set. FULL SCALE1 and FULL SCALE3, FULL SCALE2 and FULL SCALE4 are related as follows.  
 $|FULL\ SCALE1| = |FULL\ SCALE3|$   
 $|FULL\ SCALE2| = |FULL\ SCALE4|$   
 \* Preset PIPE PARAMETER and FLOW UNIT.  
 \* If a value beyond the settable range is inputted, "INPUT ERROR" appears and then last setting is resumed.  
 \* If "FLOW UNIT" has been changed after setting the range, redo the range setting.  
 \* When FULL SCALE2 is not used (in the case of single range), set "0" to FULL SCALE2.



<Note> The flow rate unit is as selected by "FLOW UNIT" in "MEASURE SETUP" mode. Before setting range, set the "FLOW UNIT". (See 4.8.2.)

For actual keying, refer to the typical operation indicated below. Set the protection to OFF beforehand. (See Section 4.4.1.)

Operation (example)	Set "BI-DIR AUTO 2" to "RANGE TYPE", 10[m <sup>3</sup> /h] to "FULL SCALE1", and 60[m <sup>3</sup> /h] to "FULL SCALE2". Set "RANGE HYS." to 7%. * Preset "PIPE PARAMETER" and "FLOW UNIT".	
Key operation	Description	Display
	Press the  key twice to display "OUTPUT SETUP".	OUTPUT SETUP
	Press the  key once to display "ZERO ADJUSTMENT".	ZERO ADJUSTMENT SET ZERO
	Press the  key for 4 times to display "RANGE".	RANGE
	Press the  key once to display "KIND"	KIND FLOW RATE
	Press the  key once to display "RANGE TYPE"	RANGE TYPE SINGLE RANGE
	Press the  key twice to blink the cursor.	RANGE TYPE SINGLE
	Press the  key for 3 times, and select "BI-DIR AUTO 2".	RANGE TYPE BI-DIR AUTO 2
	Press the  key once to display "RANGE TYPE".	RANGE TYPE BI-DIR AUTO 2
	Press the  key once to display "FULL SCALE1".	FULL SCALE1 20.0000 m3/h
	Press the  key once to blink the cursor on the 2nd line.	FULL SCALE1 0020.0000 m3/h
	Press the  key several times to align the cursor to "2".	FULL SCALE1 0020.0000 m3/h
	Press the  key several times to set "1".	FULL SCALE1 0010.0000 m3/h
	Note) To change the decimal point position, align the cursor with a place to change to, and press the  key.	
	Press the  key once to register.	FULL SCALE1 ** COMPLETE **

▼	----- FULL SCALE1 has been registered. -----	FULL SCALE1 ----- 10.0000 m3/h
▼	Press the  key once to display "FULL SCALE2".	FULL SCALE2 ----- 0.0000 m3/h
▼	Press the  key once to blink the cursor.	FULL SCALE2 ----- 0000.0000 m3/h
▼	Press the  key twice to move the cursor.	FULL SCALE2 ----- 0000.0000 m3/h
▼	Press the  key for 6 times to set "6".	FULL SCALE2 ----- 0060.0000 m3/h
▼	Press the  key once to register.	FULL SCALE2 ----- ** COMPLETE **
▼	----- FLOW SPAN2 has been registered. -----	↓
▼	Press the  key once to display "RANGE HYS.". .	FULL SCALE2 ----- 60.0000 m3/h
▼	Press the  key once to blink the cursor.	RANGE HYS. ----- 5.00 %
▼	Press the  key once to move the cursor.	RANGE HYS. ----- 05.00 %
▼	Press the  key twice to set "7".	RANGE HYS. ----- 07.00 %
▼	Press the  key once to register.	RANGE HYS. ----- ** COMPLETE **
▼	----- RANGE HYS. has been registered. -----	↓
▼	Press the  key twice and then press the  key for 3 times to enter the measurement mode.	RANGE HYS. ----- 7.00 %
▼		0.000 % 0.000 m <sup>3</sup>

## 4.10.4. Rate limit

### Description

- Spike noise input such as slurry fluid can be cut and output.
- Settable range
  - (1) RATE LIMIT 0 to 5 [m/s] in terms of flow velocity. Absolute value is input (Factory set: 0[m<sup>3</sup>/h])
  - (2) RATE TIMER Enter in the range of 0 to 900 sec. (Factory set: 0sec)

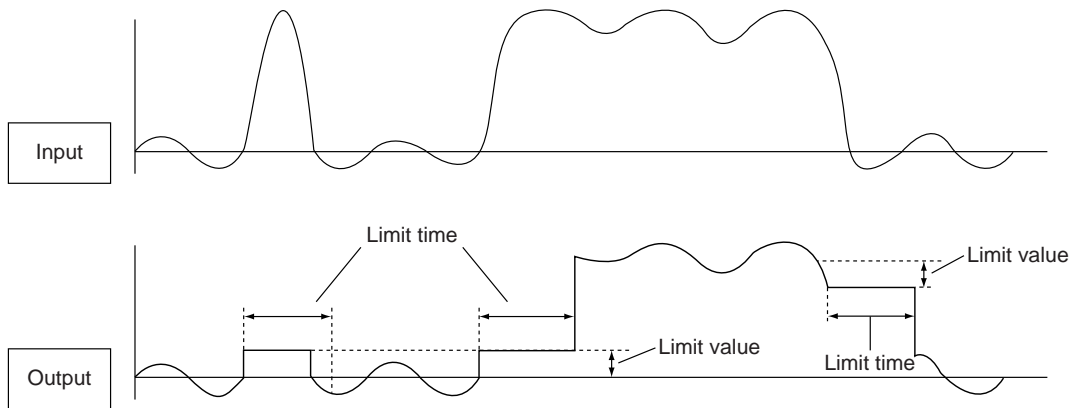

(Note 1) When input exceeding a limit value continues more than limit time, it is output as a true signal.

(Note 2) When the limit time is set to 0sec, this function does not operate.

For actual keying, refer to the typical operation indicated below. Set the protection to OFF beforehand. (See Section 4.4.1.)

Operation (example)	Set 5m <sup>3</sup> /h to RATE LIMIT, and 10sec to RATE LIMIT TIMER. * Preset "PIPE PARAMETER" and "FLOW UNIT".	Display
Key operation	Description	
	Press the  key twice to display "OUTPUT SETUP".	OUTPUT SETUP
	Press the  key once to display "ZERO ADJUSTMENT".	ZERO ADJUSTMENT SET ZERO
	Press the  key for 4 times to display "RANGE".	RANGE
	Press the  key once to display "KIND".	KIND FLOW RATE
	Press the  key for 9 times to display "RATE LIMIT".	RATE LIMIT 0.000 m3/h
	Press the  key once to blink the cursor.	RATE LIMIT 00000.000 m3/h
	Press the  key for 4 times to align the cursor.	RATE LIMIT 00000.000 m3/h
	Press the  key several times to set "5".	RATE LIMIT 00005.000 m3/h
	Press the  key once to register.	RATE LIMIT ** COMPLETE **
	——— RATE LIMIT has been registered. ———	
	Press the  key once to display "RATE LIMIT TIMER".	RATE LIMIT TIMER 0 sec
	Press the  key once to blink the cursor.	RATE LIMIT TIMER 000 sec
	Press the  key once to align the cursor.	RATE LIMIT TIMER 000 sec
	Press the  key several times to set "1".	RATE LIMIT TIMER 010 sec

ENT



ESC 

Press the ENT key once to register.

----- RATE LIMIT TIMER has been registered. -----

Press the ESC key twice and then press the  key for 3 times to enter the measurement mode.

RATE LIMIT TIMER	
** COMPLETE **	
↓	
RATE LIMIT TIMER	
10 sec	
0.000	%
0.000	m3

## 4.10.5. Setting the DO output

### 4.10.5.1. How to validate outputting the FULL SCALE 2

**Description**

- Select a contact output as DO1 and/or DO2 at FULL SCALE2 measurement status.

For actual keying, refer to the typical operation indicated below. Set the protection to OFF beforehand. (See Section 4.4.1.)

Operation (example)	Description	Display
Key operation		
	Press the  key twice to display "OUTPUT SETUP".	OUTPUT SETUP
	Press the  key once to display "ZERO ADJUSTMENT".	ZERO ADJUSTMENT SET ZERO
	Press the  key for 6 times to display "DO1 OUT".	DO1 OUT NOT USED
	* Press the  key again to display "DO2 OUT".	
	Press the  key once to blink the cursor.	DO1 OUT NOT USED
	Press the  key for 3 times to display "FULL SCALE2" on the 2nd line.	DO1 OUT FULL SCALE2
	Press the  key once to register "FULL SCALE2".	DO1 OUT ** COMPLETE **
	----- "FULL SCALE2" has been registered. -----	STATUS OUT CONTACT ACTION
	Press the  key once to display "CONTACT ACTION".	CONTACT ACTION ACTIVE ON
	Press the  key once to register "ACTIVE ON"(normally off).	CONTACT ACTION ** COMPLETE **
	* To select normally on, press the  key.	
	----- ACTIVE ON has been registered. -----	STATUS OUT CONTACT ACTION
	Press the  key twice and then press the  key for 3 times to enter the measurement mode.	0.000 % 0.000 m3

## 4.10.5.2. How to validate the alarm output

### Description

- Select a contact output as DO1 and/or DO2 when received wave or E<sup>2</sup>PROM is abnormal.
- Settable range  
 ALL : Select a contact output when hardware and received wave (nothing, unstable) are abnormal.  
 HARDWARE FAULT: Select a contact output when circuit is abnormal.  
 PROCESS ERROR : Select a contact output when received wave is abnormal.

For actual keying, refer to the typical operation indicated below. Set the protection to OFF beforehand. (See Section 4.4.1.)

Operation (example)	Description	Display
Key operation	Set the DO1 output to "PROCESS ERROR". Also, set the contact to "ACTIVE ON".	
	Press the  key twice to display "OUTPUT SETUP".	OUTPUT SETUP
	Press the  key once to display "ZERO ADJUSTMENT".	ZERO ADJUSTMENT SET ZERO
	Press the  key for 6 times to display "DO1 OUT".	DO1 OUT NOT USED
	* Press the  key again to display "DO2 OUT".	
	Press the  key once to blink the cursor.	DO1 OUT NOT USED
	Press the  key for 4 times to display "ALARM" on the 2nd line.	DO1 OUT ALARM
	Press the  key once to display the ALARM select panel.	ALARM ALL
	Press the  key twice to display "PROCESS ERROR".	ALARM PROCESS ERROR
	Press the  key once to register.	ALARM ** COMPLETE **
	----- "PROCESS ERROR" has been registered. -----	STATUS OUT CONTACT ACTION
	Press the  key once to display "CONTACT ACTION".	CONTACT ACTION ACTIVE ON
	Press the  key once to register "ACTIVE ON"(normally off).	CONTACT ACTION ** COMPLETE **
	* To select normally on, press the  key.	
	----- "ACTIVE ON" has been registered. -----	STATUS OUT CONTACT ACTION
	Press the  key twice and then press the  key for 3 times to enter the measurement mode.	0.000 % 0.000 m3

### Burnout timer

The time between error occurrence and contact output can be changed by a setting of the burnout timer. Make a setting according to the section "4.9.1.2 Setting of analog output at error (Burnout)".

Note) If "Process error" or "All" is issued, the burnout timer is enabled. If "Device error" is issued, the burnout timer is disabled.

### 4.10.5.3. Setting the flow switch

**Description**

- Select a contact output as DO1 and/or DO2 when the flow rate has exceeded a setting.

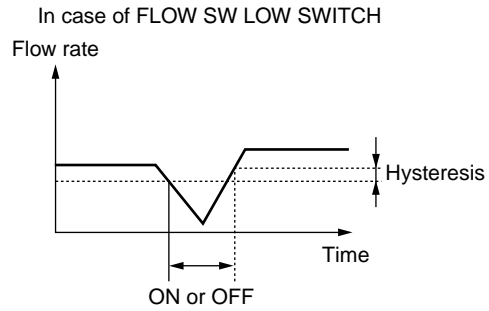
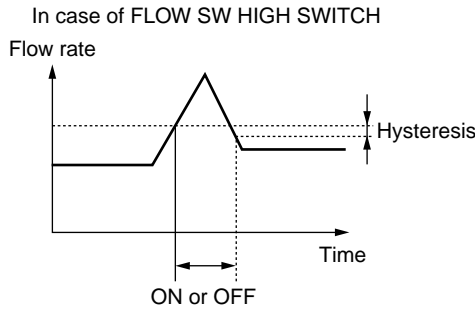

**● Settable range**

Flow rate : 0 to 32m/s in terms of flow velocity.

Action : FLOW SW HIGH or FLOW SW LOW

Contact action: ACTIVE ON : DO1/DO2: Normally off

ACTIVE OFF: DO1/DO2: Normally on

Note) The hysteresis value set in Section 4.9.1 "Setting of flow rate range" is applied to the action range.

For actual keying, refer to the typical operation indicated below. Set the protection to OFF beforehand. (See Section 4.4.1.)

Operation (example)	Description	Display
	Set the DO1 output to "FLOW SW HIGH", and upper limit flow rate to 12 [m <sup>3</sup> /h]. Also, set the contact to "ACTIVE ON".	
Key operation	Description	Display
	Press the  key twice to display "OUTPUT SETUP".	OUTPUT SETUP
	Press the  key once to display "ZERO ADJUSTMENT".	ZERO ADJUSTMENT SET ZERO
	Press the  key for 6 times to display "DO1 OUT".	DO1 OUT NOT USED
	* Press the  key again to display "DO2 OUT".	
	Press the  key once to blink the cursor.	DO1 OUT NOT USED
	Press the  key for 5 times to display "FLOW SWITCH" on the 2nd line.	DO1 OUT FLOW SWITCH
	Press the  key once to display the flow rate setting screen of "FLOW SW HIGH".	FLOW SW HIGH 10.0000 m3/h
	* Press the  key once to display the flow rate setting screen of "FLOW SW LOW".	
	Press the  key once to blink the cursor.	FLOW SW HIGH 010.0000 m3/h
	Press the  key for 3 times to move the cursor.	FLOW SW HIGH 0010.0000 m3/h
	Press the  key twice to set "2".	FLOW SW HIGH 0012.0000 m3/h
	Press the  key once to register.	FLOW SW HIGH ** COMPLETE **
	----- "FLOW SW HIGH" has been registered. -----	STATUS OUT CONTACT ACTION
	Press the  key once to display "CONTACT ACTION".	CONTACT ACTION ACTIVE ON
	Press the  key once to register "ACTIVE ON"(normally off).	CONTACT ACTION ** COMPLETE **
	* To select normally on, press the  key.	





----- "ACTIVE ON" has been registered. -----

STATUS OUT  
CONTACT ACTION



Press the ESC key twice and then press the  key for 3 times to enter the measurement mode.

0.000 %  
0.000 m3

#### 4.10.5.4. How to validate the total switch

**Description**

- Select a contact output as DO1 and/or DO2 when the total value exceeds a setting.

Settable range: 0.000001 to 99999999

Contact action:

ACTIVE ON : DO1/DO2: Normally off

ACTIVE OFF: DO1/DO2: Normally on

Note) Different values can be assigned to DO1 and DO2.

For actual keying, refer to the typical operation indicated below. Set the protection to OFF beforehand. (See Section 4.4.1.)

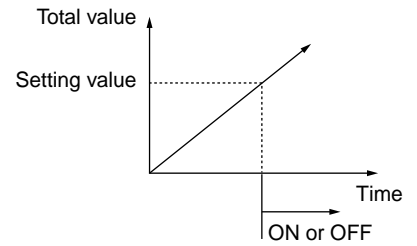



































Operation (example)	Set the DO1 output to "TOTAL SWITCH", and change the setting value from 10000[m <sup>3</sup> ] to 100[m <sup>3</sup> ]. Also, set the contact to "ACTIVE ON".	
Key operation	Description	Display
	Press the  key twice to display "OUTPUT SETUP".	OUTPUT SETUP
	Press the  key once to display "ZERO ADJUSTMENT".	ZERO ADJUSTMENT SET ZERO
	Press the  key for 6 times to display "DO1 OUT".	DO1 OUT NOT USED
	* Press the  key again to display "DO2 OUT".	
	Press the  key once to blink the cursor.	DO1 OUT NOT USED
	Press the  key for 6 times to display "TOTAL SWITCH" on the 2nd line.	DO1 OUT TOTAL SWITCH
	Press the  key once to display the setting screen of "TOTAL SWITCH".	TOTAL SWITCH 10000 m <sup>3</sup>
	Press the  key once to blink the cursor.	TOTAL SWITCH 00010000 m <sup>3</sup>
	Press the  key for 3 times to move the cursor.	TOTAL SWITCH 00010000 m <sup>3</sup>
	Press the  key for 10 times to set "0".	TOTAL SWITCH 00000000 m <sup>3</sup>
	Press the  key twice to move the cursor.	TOTAL SWITCH 00000000 m <sup>3</sup>
	Press the  key once to set "1".	TOTAL SWITCH 00000100 m <sup>3</sup>
	Press the  key once to register.	TOTAL SWITCH ** COMPLETE **
	----- "TOTAL SWITCH" has been registered. -----	STATUS OUT CONTACT ACTION
	Press the  key once to display "CONTACT ACTION".	CONTACT ACTION ACTIVE ON
	Press the  key once to register "ACTIVE ON"(normally off).	CONTACT ACTION ** COMPLETE **
	* To select normally on, press the  key.	
	----- "ACTIVE ON" has been registered. -----	STATUS OUT CONTACT ACTION
	Press the  key twice and then press the  key for 3 times to enter the measurement mode.	0.000 % 0.000 m <sup>3</sup>

#### 4.10.5.5. How to validate the range over output and pulse range over output

**Description**

- **AO RANGE OVER** : Select a contact output as DO1 and/or DO2 when the upper limit and lower limit output are above the setting.
- **PULSE RANGE OVER**: Select a contact output as DO1 and/or DO2 when the total pulse output exceeds the maximum output frequency value.

For actual keying, refer to the typical operation indicated below. Set the protection to OFF beforehand. (See Section 4.4.1.)

Operation (example)	Description	Display
Key operation	Set the DO1 output to "AO RANGE OVER". Also, set the contact to "ACTIVE ON".	
	Press the  key twice to display "OUTPUT SETUP".	OUTPUT SETUP -----
		
	Press the  key once to display "ZERO ADJUSTMENT".	ZERO ADJUSTMENT ----- SET ZERO
		
	Press the  key for 6 times to display "DO1 OUT".	DO1 OUT ----- NOT USED
	* Press the  key again to display "DO2 OUT".	
	Press the  key once to blink the cursor.	DO1 OUT ----- NOT USED
		
	Press the  key for 7 times to display "AO RANGE OVER" on the 2nd line.	DO1 OUT ----- AO RANGE OVER
	* Press the  key again to display "PULSE RANGE OVER".	
	Press the  key once to register "RANGE OVER".	DO1 OUT ----- ** COMPLETE **
		
	----- "RANGE OVER" has been registered. -----	STATUS OUT ----- CONTACT ACTION
		
	Press the  key once to display "CONTACT ACTION".	CONTACT ACTION ----- ACTIVE ON
		
	Press the  key once to register "ACTIVE ON"(normally off).	CONTACT ACTION ----- ** COMPLETE **
		
	* To select normally on, press the  key.	
	----- "ACTIVE ON" has been registered. -----	STATUS OUT ----- CONTACT ACTION
 	Press the  key twice and then press the  key for 3 times to enter the measurement mode.	0.000 % ----- 0.000 m3

#### 4.10.5.6. How to validate the output at the minus direction action

**Description**

- Select a contact output as DO1 and/or DO2 when the flow is in reverse direction.

For actual keying, refer to the typical operation indicated below. Set the protection to OFF beforehand. (See Section 4.4.1.)

Operation (example)	Description	Display
Key operation		
△	Press the △ key twice to display "OUTPUT SETUP".	OUTPUT SETUP
▼		
ENT	Press the ENT key once to display "ZERO ADJUSTMENT".	ZERO ADJUSTMENT SET ZERO
▼		
△	Press the △ key for 6 times to display "DO1 OUT".	DO1 OUT NOT USED
▼		
	* Press the △ key again to display "DO2 OUT".	
ENT	Press the ENT key once to blink the cursor.	DO1 OUT NOT USED
▼		
△	Press the △ key for 9 times to display "-:FLOW DIRECTION" on the 2nd line.	DO1 OUT -:FLOW DIRECTION
▼		
ENT	Press the ENT key once to register "-:FLOW DIRECTION".	DO1 OUT ** COMPLETE **
▼		
▼		
▼		
▼	----- "-:FLOW DIRECTION" has been registered. -----	STATUS OUT CONTACT ACTION
ENT	Press the ENT key once to display "CONTACT ACTION".	CONTACT ACTION ACTIVE ON
▼		
ENT	Press the ENT key once to register "ACTIVE ON"(normally off).	CONTACT ACTION ** COMPLETE **
▼		
▼		
▼		
▼	* To select normally on, press the △ key.	
▼		
▼	----- "ACTIVE ON" has been registered. -----	STATUS OUT CONTACT ACTION
ESC △	Press the ESC key twice and then press the △ key for 3 times to enter the measurement mode.	0.000 % 0.000 m3

## 4.10.6. How to compensate the measurement value

**Description**

- Measurement value can be calibrated arbitrarily.
- Zero point and span adjustment can be made.
- Settable range
- (1) Zero point: -5 to +5 [m/s] in terms of flow velocity in piping.
- (2) Span : ±200%

The output value (reading, analog output and total output) is computed by the following expression.

$$\text{Output} = \frac{\text{Measurement value} \times [\text{Span set value \%}]}{100} + \text{Zero point}$$

For actual keying, refer to the typical operation indicated below. Set the protection to OFF beforehand. (See Section 4.4.1.)

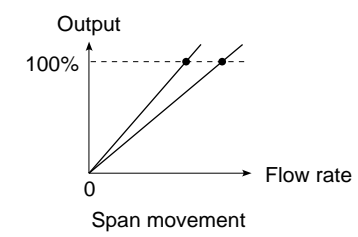
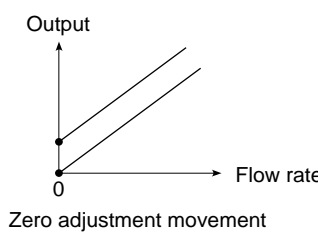

Operation (example)	Compensate the zero point to 0.5m³/h, and the span by +1%.	
Key operation	Description	Display
	Press the  key twice to display "OUTPUT SETUP".	OUTPUT SETUP
	Press the  key once to display "ZERO ADJUSTMENT".	ZERO ADJUSTMENT SET ZERO
	Press the  key for 8 times to display "CALIBRATION ZERO".	CALIBRATION ZERO 0.000 m3/h
	Press the  key once to blink the cursor.	CALIBRATION ZERO 00000.000 m3/h
	Press the  key for 6 times to move the cursor.	CALIBRATION ZERO 00000.000 m3/h
	Press the  key for 5 times to set "5".	CALIBRATION ZERO 00000.500 m3/h
	Press the  key once to register.	CALIBRATION ZERO ** COMPLETE **
	----- "CALIBRATION ZERO" has been registered. -----	CALIBRATION ZERO 0.500 m3/h
	Press the  key once to display "CALIBRATION SPAN".	CALIBRATION SPAN 100.0 %
	Press the  key once to blink the cursor.	CALIBRATION SPAN 100.0 %
	Press the  key twice to move the cursor.	CALIBRATION SPAN 100.0 %
	Press the  key once to set "1".	CALIBRATION SPAN 101.0 %
	Press the  key once to register.	CALIBRATION SPAN ** COMPLETE **
	----- "CALIBRATION SPAN" has been registered. -----	CALIBRATION SPAN 101.0 %
	Press the  key once and then press the  key for 3 times to enter the measurement mode.	0.000 % 0.000 m3

## 4.10.7. Setting of the operation mode

### Description

- Used to switch computation cycle and output cycle.

- Settable range

NORMAL : Standard mode (factory-set value), computation/output cycle is approximately 0.5 seconds.

HIGH SPEED: High speed response mode, computation/output cycle is approximately 0.2 seconds.

For actual keying, refer to the typical operation indicated below. Set the protection to OFF beforehand. (See Section 4.4.1.)

Operation (example)	Switch the operation mode to the high speed response mode.	
Key operation	Description	Display
	Press the  key twice to display "OUTPUT SETUP".	OUTPUT SETUP
	Press the  key once to display "ZERO ADJUSTMENT".	ZERO ADJUSTMENT SET ZERO
	Press the  key for 10 times to display "OPERATION MODE".	OPERATION MODE NORMAL
	Press the  key once to blink the cursor.	OPERATION MODE <b>NORMAL</b>
	Press the  key for 6 times to move the cursor.	OPERATION MODE <b>HIGH SPEED</b>
	Press the  key once to register.	OPERATION MODE ** COMPLETE **
	----- "OPERATION MODE" has been registered. -----	OPERATION MODE HIGH SPEED
	Press the  key once and then press the  key for 3 times to enter the measurement mode.	0.000 % 0.000 m3

### Reference

The difference between standard mode and high speed mode



High speed mode is unfit for the measurement when foreign objects or air bubbles are contained.

Standard mode is about 10 times more resistant to entry of foreign objects or air bubbles than high speed mode.

# 4.11. MAINTENANCE MODE







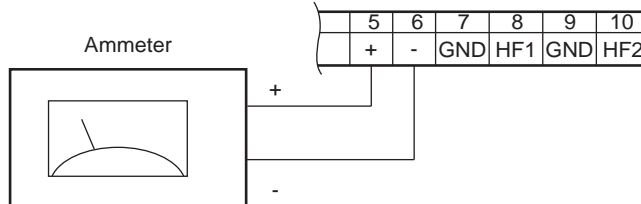





























## 4.11.1. How to calibrate the analog output

**Description**

- The calibration is performed so as to obtain 4mA and 20mA when the analog signal (4-20mA DC) output is 0% and 100%, respectively.
- Connect an ammeter to lout terminals as shown below. In the CURRENT CALIBRATION mode, select 4mA or 20mA, and operate the  key (UP) or the  key (Down) .



For actual keying, refer to the typical operation indicated below. Set the protection to OFF beforehand. (See Section 4.4.1.)

Operation (example)	Adjust the 4mA and 20mA analog outputs.	
Key operation	Description	Display
	Press the  key for 4 times to display "MAINTENANCE MODE".	MAINTENANCE MODE
		
	Press the  key once to display "RAS INFORMATION".	RAS INFORMATION 0000000000000000
		
	Press the  key once to display "CURRENT".	CURRENT CARIBRATION
		
	Press the  key twice to enter the calibration mode of 4mA output.	CARIBRATION 4 mA
		
	Adjust the output to 4mA by the  (UP) and the  (down) key, while observing the output of calibration devices such as an ammeter.	
	Press the  key once to register the adjustment result.	CARIBRATION ** COMPLETE **
		
		
		
	Press the  key once, and select 20mA.	CARIBRATION 20mA
		
	Press the  key twice to enter the calibration mode of 20mA output.	CARIBRATION 20mA
		
	Adjust the output to 20mA by the  (UP) and the  (down) key.	
	Press the  key once to register the adjustment result.	CARIBRATION ** COMPLETE **
		
		
		
 	Press the  key twice and then press the  key once to enter the measurement mode.	0.000 % 0.000 m3

## 4.11.2. How to set the constant current output

### Description

- Generates a fixed value output of analog signal.  
Application example: The operation of a connected receiver is checked by generating a fixed value output of analog signal.
- In the constant current setting mode (OUTPUT SETTING), set the constant current output value.  
Settable range: -20%(0.8mA) to +120%(23.2mA)

For actual keying, refer to the typical operation indicated below. Set the protection to OFF beforehand. (See Section 4.4.1.)

Operation (example)	Set the constant current output of 50% (12mA).	
Key operation	Description	Display
	Press the  key for 4 times to display "MAINTENANCE MODE".	MAINTENANCE MODE
	Press the  key once to display "RAS INFORMATION".	RAS INFORMATION 0000000000000000
	Press the  key twice to display "OUTPUT SETTING".	CURRENT OUTPUT SETTING
	Press the  key once to display the setting screen.	OUTPUT SETTING 0 %
	Press the  key once to blink the cursor.	OUTPUT SETTING 0.000 %
	Note) Start constant current output.	
	Enter "5" by the  and the  key.	OUTPUT SETTING +050 %
	Press the  key once to output 12mA.	OUTPUT SETTING ** COMPLETE **
		↓
	----- Outputting 12mA. -----	OUTPUT SETTING 50 %
	Press the  key once to stop constant current output.	CURRENT OUTPUT SETTING
	Note) Current output is in the measurement status.	
	Press the  key once and then press the  key once to enter the measurement mode.	0.000 % 0.000 m3



### 4.11.3. How to check the action of total pulses

**Description**

- Checks the action of total pulse output.

The output action can be checked upon designating the number of pulses to be outputted per second.

Settable range: 1 to 100 pulses/s (when pulse width is 5ms, 10ms, 50ms, 100ms or 200ms)

Note 1) The output pulse width is as selected currently. (See 4.9.2.1.)

Set the frequency taking the pulse width into account referring to the following expression.

The number of setting pulses  $\leq 1000 / (\text{Pulse width}[\text{ms}] \times 2)$

Example: If the pulse width is set to 50ms, select 10 pulses/s or less.

Note 2) When pulse width is 500ms and 1000ms, output action is performed at the rate of 1pulse/4seconds regardless of setting.

Note 3) Before checking the action, confirm whether proceeding to an action is permitted.

For actual keying, refer to the typical operation indicated below. Set the protection to OFF beforehand. (See Section 4.4.1.)

Operation (example)	Perform pulse output of 5 pulses/s.	
Key operation	Description	Display
	Press the  key for 4 times to display "MAINTENANCE MODE".	MAINTENANCE MODE
	Press the  key once to display "RAS INFORMATION".	RAS INFORMATION 0000000000000000
	Press the  key for 3 times to display "TOTAL PULSE".	TOTAL PULSE 1 PULSE/s
	Press the  key once to blink the cursor.	TOTAL PULSE 001 PULSE/s
	Note) Start simulated pulse output.	
	Press the  key twice to move the cursor.	TOTAL PULSE 001 PULSE/s
	Press the  key for 4 times to set "5".	TOTAL PULSE 005 PULSE/s
	Press the  key once to register.	TOTAL PULSE ** COMPLETE **
		↓
	----- 5 PULSE/s has been registered. -----	TOTAL PULSE 005 PULSE/s
	5 PULSE/s simulated pulse is output.	
	After checking the output, press the  key once to stop simulated pulse output.	TOTAL PULSE 005 PULSE/s
	Press the  key once and then press the  key once to enter the measurement mode.	0.000 % 0.000 m3

## 4.11.4. How to check the status output

### Description

- Check the status output.  
Setting content ON: Close the contact.  
OFF: Open the contact.



## CAUTION

- This operation sets DO1 and DO2 the same contact action.
- Before operation, check whether DO output testing is permitted.

For actual keying, refer to the typical operation indicated below. Set the protection to OFF beforehand. (See Section 4.4.1.)

Operation (example)	Check the contact action.	
Key operation	Description	Display
	Press the  key for 4 times to display "MAINTENANCE MODE".	MAINTENANCE MODE
	Press the  key once to display "RAS INFORMATION".	RAS INFORMATION 0000000000000000
	Press the  key for 4 times to display "STATUS".	DO CHECK OFF
	Press the  key once to blink the cursor. Note) Contact output is displayed at this time. "OFF" is given at right.	DO CHECK OFF
	Press the  key once, and select "ON".	DO CHECK ON
	Press the  key once to register "ON".	DO CHECK ** COMPLETE **
		↓
	----- "ON" has been registered. -----	DO CHECK ON
	* Check the contact output "ON".	DO CHECK OFF
	Press the  key once to register "OFF".	DO CHECK ** COMPLETE **
		↓
	----- "OFF" has been registered. -----	DO CHECK OFF
	Press the  key once to stop the cursor from blinking.	DO CHECK OFF
	* It returns to contact output at the normal measurement status.	
	Press the  key once and then press the  key once to enter the measurement mode.	0.000 % 0.000 m3

## 4.11.5. How to validate the test mode (simulated flow rate output)

### Description

- Checks different outputs (LCD indication, analog output, DO output) upon simulating flow rate outputs.  
With the output at the actuated time as an initial value, the output changes up to the input value (simulated flow rate target value) in a selected TRACKING TIME, and at the input value, the output value becomes constant.  
During the test mode, "T" blinks on the left end of the 1st line of LCD.

### Setting content

- TEST MODE : Enables or disables the test mode.  
 INPUT DATA : Simulated flow rate target (percentage of MV full scale).  
 TRACKING TIME : Time required to attain the simulated flow rate target (above input value).

### Settable range

- TEST MODE validation: SETTING (valid), NOT USED (invalid)  
 INPUT DATA :  $\pm 120\%$   
 TRACKING TIME : 0 to 999 seconds  
 \* For setting TRACKING TIME, 0sec is set to the damping (See 4.9.5).

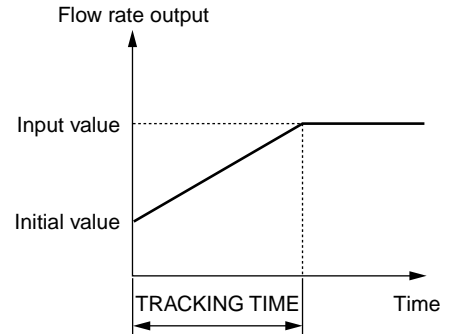

## ⚠ CAUTION

- By performing the operation, the output of analog outputs DO1 and DO2 will be changed depending on the setting. Check beforehand whether each output can be changed or not.
- Be sure to resume "NOT USED" after the end of test. Otherwise, the input value output status will be held until power is turned off.
- If "START/RESET" is selected as TOTAL MODE, the total value also changes. Select "STOP" to prevent the total value change.

For actual keying, refer to the typical operation indicated below. Set the protection to OFF beforehand. (See Section 4.4.1.)

Operation (example)	Set the simulated flow rate target to 100%, and the tracking time to 100 [s]. *Set the "FLOW RATE (%)" before hand. Refer of "4.9.4 Setting the LCD indication"	
Key operation	Description	Display
△	Press the △ key for 4 times to display "MAINTENANCE MODE".	MAINTENANCE MODE
▼		
ENT	Press the ENT key once to display "RAS INFORMATION".	RAS INFORMATION 0000000000000000
▼		
△	Press the △ key for 5 times to display "TEST MODE".	TEST MODE NOT USED
▼		
ENT	Press the ENT key once to blink the cursor.	TEST MODE NOT USED
▼		
△	Press the △ key once, and select "SETTING".	TEST MODE SETTING
▼		
ENT	Press the ENT key once to register "SETTING".	INPUT DATA 0 %
▼		
ENT	Press the ENT key once to blink the cursor on the 2nd line.	INPUT DATA +000 %
▼		
▶ △	Enter "100" by the ▶ and the △ key.	INPUT DATA +100 %
▼		
ENT	Press the ENT key once to register.	INPUT DATA ** COMPLETE **
▼		↓
▼	----- "INPUT DATA" has been registered. -----	INPUT DATA 100 %
▼		
△	Press the △ key once to display "TRACKING TIME".	TRACKING TIME 0 sec
▼		
ENT	Press the ENT key once to blink the cursor on the 2nd line.	TRACKING TIME 000 sec
▼		
△	Press the △ key once to set "100".	TRACKING TIME 100 sec
▼		

ENT



ESC  $\Delta$

Press the ENT key once to register.

----- "TRACKING TIME" has been registered. -----

\* Simulating flow rate output is started.

Display the measurement mode by the ESC key and the  $\Delta$  key.

"T" blinks on the left end of 1st line of LCD, and the output changes. In 100 seconds (at which tracking time is set), the output becomes stable at 10 [m<sup>3</sup>/h] (simulated flow rate target). (In case of full scale 10 [m<sup>3</sup>/h])

Note) Be sure to return the TEST MODE to "NOT USED" after checking the output.

TRACKING TIME  
-----  
\*\* COMPLETE \*\*



TRACKING TIME  
-----  
100 s

T 0.00 %  
-----  
0.000 m3/h



T 100.00 %  
-----  
10.000 m3/h

## 4.11.6. How to validate a serial transmission (RS-485)

### Description

- Validates a transmission before using the transmission function.

### Setting content

Transmission type, transmission rate, parity, stop bits and slave No.

### Settable range

Transmission type : RS-485.  
 Transmission rate (BAUD RATE) : 9600 BPS (factory set) or 19200 BPS, 38400BPS.  
 Parity : NONE, EVEN (factory set), ODD  
 Stop bits : 1 BIT (factory set), 2 BITS  
 Station No. : 1 to 31 (factory set: 1)  
 Communication protocol : MODBUS RTU mode (factory set) or M-Flow (Fuji Electric's M-Flow [Type: FLR] protocol)

Note) For the transmission specifications, refer to the separate instruction manual "Ultrasonic Flowmeter Communication functions" (INF-TN5A1564-E).

For actual keying, refer to the typical operation indicated below. Set the protection to OFF beforehand. (See Section 4.4.1.)

Operation (example)	Set the baud rate to 9600 BPS, the parity to "NONE", the stop bits to "1 BIT", and the slave No. to "5".	
Key operation	Description	Display
	Press the  key for 4 times to display "MAINTENANCE MODE".	MAINTENANCE MODE
	Press the  key once to display "RAS INFORMATION".	RAS INFORMATION 0000000000000000
	Press the  key for 6 times to display "COMMUNICATION".	COMMUNICATION
	Press the  key once to display " RS-485 "	MODE RS-485
	Press the  key once to display "BAUD RATE".	BAUD RATE 9600BPS
	Because "9600 BPS" is set, go to the next step. To select other baud rate, press the  key, and select by the  key, and register by the  key.	
	Press the  key once to display "PARITY".	PARITY ODD
	Press the  key once to blink on the 2nd line.	PARITY ODD
	Press the  key once to display "NONE".	PARITY NONE
	Press the  key once to register.	PARITY ** COMPLETE **
	----- "NONE" has been registered. -----	PARITY NONE
	Press the  key once to display "STOP BIT".	STOP BIT 1 BIT
	Because "1 BIT" is set, go to the next step. To select "2 BITS", press the  key, and select by the  key, and register by the  key.	
	Press the  key once to display "STATION No.".	STATION No. 01
	Press the  key once to blink the cursor.	STATION No. 01
	Set "5" by the  and the  key.	STATION No. 05
	Press the  key once to register.	STATION No. ** COMPLETE **

▼ ▼ ▼ ▲ ▼  ESC   ▲	<p style="text-align: center;">----- STATION No. has been registered. -----</p> <p>Press the ▲ key once to display "PROTOCOL".          Because "MODBUS" is set, setting is completed.          To select other protocol, press the ENT key, and select a protocol by the ▲ key, and register it by the ENT key.</p> <p>Display the measurement mode by the ESC key and the ▲ key.</p>	<table border="1" style="width: 100%; border-collapse: collapse;"> <tr> <td style="padding: 2px;">STATION No.-----</td> <td style="text-align: right; padding: 2px;">05</td> </tr> <tr> <td style="padding: 2px;">PROTOCOL-----</td> <td style="text-align: right; padding: 2px;">MODBUS</td> </tr> <tr> <td colspan="2" style="padding: 2px;"> </td> </tr> <tr> <td style="padding: 2px;">----- 0.000    %</td> <td style="padding: 2px;">-----</td> </tr> <tr> <td style="padding: 2px;">0.000    m3/h</td> <td style="padding: 2px;">-----</td> </tr> </table>	STATION No.-----	05	PROTOCOL-----	MODBUS			----- 0.000    %	-----	0.000    m3/h	-----
STATION No.-----	05											
PROTOCOL-----	MODBUS											
----- 0.000    %	-----											
0.000    m3/h	-----											

## 4.11.7. How to set the ID No.

<p>Description</p> <ul style="list-style-type: none"> <li>● Set the ID No. for parameters (Section 4.4.1). If ID No. is set, the number must be inputted before canceling the protection.</li> <li>● To validate the protection, set the protection to "ON". (See Section 4.4.1.)</li> </ul> <p>ID No. settable range: 0000 to 9999 (4-digit number)</p> <p>For actual keying, refer to the typical operation indicated below. Set the protection to OFF beforehand. (See Section 4.4.1.) If you forget the ID number you set, contact us.</p>
--------------------------------------------------------------------------------------------------------------------------------------------------------------------------------------------------------------------------------------------------------------------------------------------------------------------------------------------------------------------------------------------------------------------------------------------------------------------------------------------------------------------------------------------------------

Operation (example)	Set "1106" as the ID No.	
Key operation	Description	Display
	Press the  key for 4 times to display "MAINTENANCE MODE".	MAINTENANCE MODE
	Press the  key once to display "RAS INFORMATION".	RAS INFORMATION 0000000000000000
	Press the  key for 8 times to display "REGISTER ID NO.".	REGISTER ID NO.
	Press the  key twice to blink on the 2nd line.	REGISTER ID NO. 0000
	Set "1106" by the  and the  key.	REGISTER ID NO. 1106
	Press the  key once to register.	REGISTER ID NO. ** COMPLETE **
	Display the measurement mode by the  key and the  key. Note) To validate the protection, set the protection to "PROTECT ON". (See Section 4.4.1.)	REGISTER ID NO. **** ↓ 0.000 % 0.000 m3/h

## 4.11.8. How to confirm the software version

<p>Description</p> <ul style="list-style-type: none"> <li>● Indicates the software version.</li> </ul> <p>For actual keying, refer to the typical operation indicated below.</p>
----------------------------------------------------------------------------------------------------------------------------------------------------------------------------------

Operation (example)	Check the software version.	
Key operation	Description	Display
	Press the  key for 4 times to display "MAINTENANCE MODE".	MAINTENANCE MODE
	Press the  key once to display "RAS INFORMATION".	RAS INFORMATION 0000000000000000
	Press the  key for 9 times to display "VER. NO.".	* FSV****2 Ver.00A
	After checking, display the measurement mode by the  key or the  key.	0.000 % 0.000 m3/h

\* The indicated version number is display example.

## 4.11.9. Initializing setting parameters

**Description**

- Initializes the setting parameters saved in the memory.
- Initializes those other than the zero adjusted values or analog output calibration value.

Initialize code: 0100 (4-digit number)



### CAUTION

- This parameter is intended for our service personnel.
- Do not attempt to initialize the setting parameters. Otherwise measurement is disabled. When the parameter is initialized, display language is set to English. To switch the display language, refer to “4.5. Display language”.

For actual keying, refer to the typical operation indicated below. Set the protection to OFF beforehand. (See Section 4.4.1.)

Operation (example)	Initializes the setting parameters.	
Key operation	Description	Display
△	Press the △ key for 4 times to display “MAINTENANCE MODE”.	MAINTENANCE MODE
▼		
ENT	Press the ENT key once to display “RAS INFORMATION”.	RAS INFORMATION 0000000000000000
▼		
△	Press the △ key for 10 times to display “MEMORY INITIAL”.	MEMORY INITIAL
▼		
ENT	Press the ENT key twice to blink on the 2nd line.	MEMORY INITIAL 0000
▼		
▶ △	Set “0100” by the ▶ and the △ key.	MEMORY INITIAL 0100
▼		
ENT	Press the ENT key once to register.	MEMORY INITIAL ** COMPLETE **
▼		↓
▼	— Flow transmitter is reset, and the measurement mode is displayed. —	0.000 m/s 0.000 m3/h



## 4.11.10. LCD backlight setting

### Description

- Sets the operation of the LCD backlight.

You can set that light is ON all the time/ light is OFF all the time/ light is ON only when key operation and light is OFF at setting time.

### Setting content

ON: LCD backlight is ON all the time.

OFF: LCD backlight is OFF all the time

Lights-out time: sets the time for backlight to put out.

When OFF is set, this function is enabled. [setting range: 0 to 99min]

When you set the setting time to 0 min, backlight is OFF all the time.

For actual keying, refer to the typical operation indicated below. Set the protection to OFF beforehand. (See Section 4.4.1.)

Operation (example)	Set the backlight ON time to 10minuites after key operation is completed.	
Key operation	Description	Display
	Press the  key for 4 times to display "MAINTENANCE MODE".	MAINTENANCE MODE .....
	Press the  key once to display "RAS INFORMATION".	RAS INFORMATION .....
		0000000000000000
	Press the  key for 11 times to display "LCD BACKLIGHT"	LCD BACKLIGHT .....
		ON
	Press the  key once to blink the cursor.	LCD BACKLIGHT .....
		ON
	Press the  key once to select "OFF"	LCD BACKLIGHT .....
		OFF
	Press the  key once to register "OFF"	LCD BACKLIGHT .....
		OFF
	Press the  key once to blink the cursor on line2.	LIGHT-OFF TIME .....
		05min
	Set "10" by the  and the  key.	LIGHT-OFF TIME .....
		10min
	Press the  key once to register.	LIGHT-OFF TIME .....
		10min
	Display the measurement mode by the  key and the  key.	0.000 m/s .....
		0.000 m3/h

## 4.11.11. How to set the detailed setting

### Description

- The data required for time difference measurement can be set as follows.



## CAUTION

- This parameter is intended for our service personnel.
- Do not change the setting by yourself. Otherwise measurement may be disabled.
- Make the detailed setting only when a problem should arise in flow rate measurement with factory default settings, and instructed to do so by a trained factory representative. Setting need not be made in other cases.

### ● Setting items

Item	Input method	Function, range or menu
Transmission count	Select	The number of transmission of ultrasonic signals per flow rate signal output <sup>*1</sup> . (Factory-set value: 128) When standard mode is selected for the operation mode: <ul style="list-style-type: none"> <li>● 8, 16, 32, 64, 128, 256</li> </ul> When high speed response mode is selected for the operation mode: <ul style="list-style-type: none"> <li>● 4, 8, 16, 32, 64, 128</li> </ul>
Trigger control	Select Numeric value	Control method setting of the trigger level (detection point) of ultrasonic signals. (Factory-set value: AUTO) <ul style="list-style-type: none"> <li>● AUTO</li> <li>● MANUAL</li> </ul> Select the detection point according to the rate against the peak of receiving wave regarded as 100%. <ul style="list-style-type: none"> <li>● Trigger level: 10% to 90%.</li> </ul>
Window control	Select Numeric value Numeric value	Setting of control method of measurement window that takes in signals (Factory-set value: AUTO) <ul style="list-style-type: none"> <li>● AUTO</li> <li>● MANUAL</li> </ul> Set the time of starting taking in signals (period from the start of transmission until the startup of window signals) <ul style="list-style-type: none"> <li>● U: open time: 1μs to 16383μs</li> <li>● D: open time: 1μs to 16383μs</li> </ul> Note) U: forward direction, D: reverse direction In case of MANUAL, set U and D.
Saturation (level)	Numeric value	The number of times that the amplitude of received signals fluctuates and exceeds ±1.0V (saturation) per 1 flow rate signal output. Used as the threshold value for judging the error status of signals. A signal error occurs if the specified number of times is exceeded. (Factory-set value: 128) Refer to diagram *1) in the next page. <ul style="list-style-type: none"> <li>● 0 to 256</li> </ul>
Measurement method	Select	Setting of measurement method for measuring transit time. (Factory-set value: method 2) <ul style="list-style-type: none"> <li>● Method 1: Strong against interference</li> <li>● Method 2: Controls triggers on the plus side of the direction of voltage of received signals.</li> <li>● Method 3: Controls triggers on the minus side of the direction of voltage of received signals.</li> </ul>
Signal balance	Numeric value	Setting of threshold value used for judging the existence of transit time. A signal error occurs if the specified value is exceeded. (Factory-set value: 25%) <ul style="list-style-type: none"> <li>● 0% to 100%</li> </ul> Note) Set to 50% or higher for Method 1.
Transmission pattern	Select	Setting of transmission pattern of ultrasonic signals (Factory-set value: Burst 3) <ul style="list-style-type: none"> <li>● Select from BURST 1, BURST 2, BURST 3, BURST 4, BURST 5, CHIRP 4 and CHIRP 8.</li> </ul>
AGC gain	Select Numeric value Numeric value	Setting of control method of signal AGC gain (Factory-set value: AUTO) Signal peak is controlled to be kept at 1.5V <sub>PP</sub> . <ul style="list-style-type: none"> <li>● AUTO</li> <li>● MANUAL</li> </ul> Make the setting so that the signal peak in both forward and reverse directions is kept at 1.5V <sub>PP</sub> . <ul style="list-style-type: none"> <li>● Forward gain: 1.00% to 99.00%</li> <li>● Reverse gain: 1.00% to 99.00%</li> </ul>
Signal peak	Select	Setting of signal peak threshold value per 1 flow rate signal output *1). Used as the threshold value for judging the error status of signals. A signal error occurs if the value becomes lower than the specified value. (Factory-set value: 3072) <ul style="list-style-type: none"> <li>● 0.5V(4096) : Equivalent to 0.5V<sub>OP</sub></li> <li>● 0.375V(3072) : Equivalent to 0.375V<sub>OP</sub></li> <li>● 0.25V(2048) : Equivalent to 0.25V<sub>OP</sub></li> <li>● 0.125V(1024) : Equivalent to 0.125V<sub>OP</sub></li> </ul>
Transmission wait time	Numeric value	Transmission interval of ultrasonic signals. (Factory-set value: 5msec) <ul style="list-style-type: none"> <li>● 5msec to 30msec</li> </ul>

For actual keying, refer to the typical operation indicated below. Set the protection to OFF beforehand. (See Section 4.4.1.)

\*1) Forward-direction signals are taken in with forward total time measurement, while reverse-direction signals are taken in with reverse total time measurement. They are conducted alternately for the transmission count. Forward and reverse signal data is added for the transmission count and averaged. The result is 1 output of signal in forward/reverse direction.

[Outline drawing of signal processing]

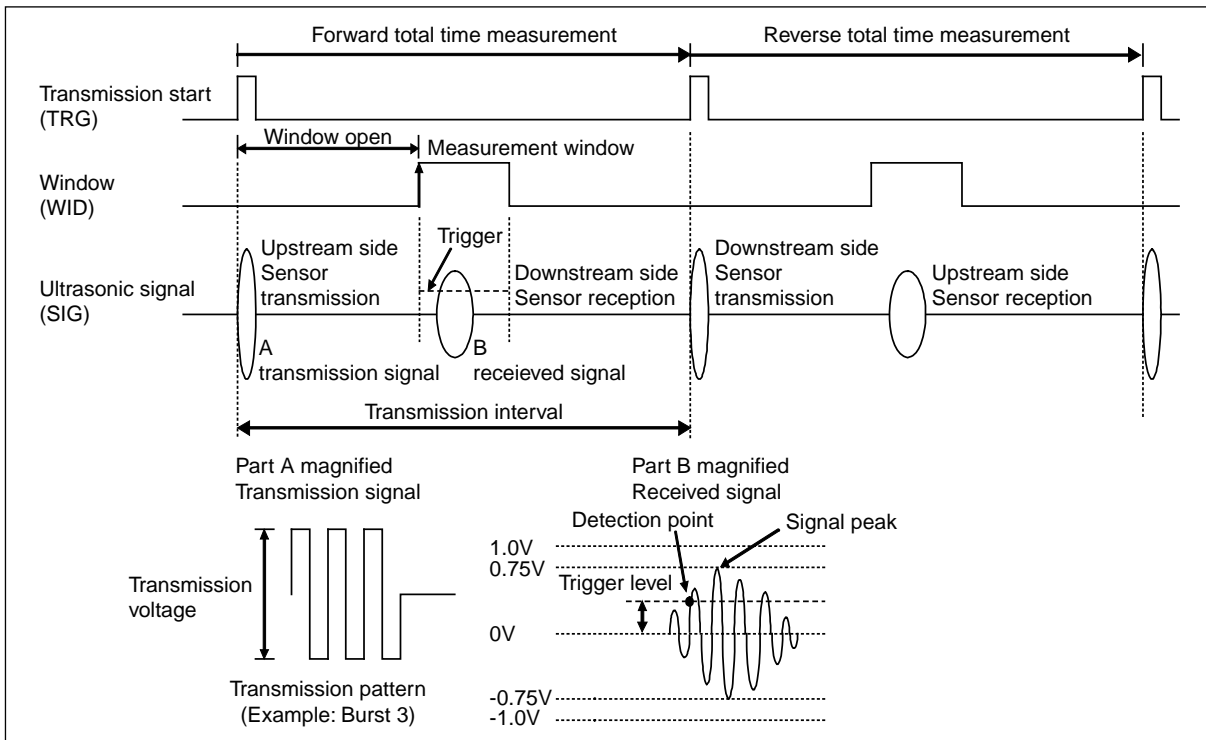

Note) Make the setting, following the description in "6.5.6. Checking received waveforms".

Operation (example)	Set measurement method to "METHOD 1".	
Key operation	Description	Display
△	Press the △ key for 4 times to display "MAINTENANCE MODE".	MAINTENANCE MODE
▼		
ENT	Press the ENT key once to display "RAS INFORMATION".	RAS INFORMATION 0000000000000000
▼		
△	Press the △ key for 14 times to display "DETAILS".	DETAILS
▼		
ENT	Press the ENT key once to display "TRANS.COUNT".	TRANS.COUNT 128
▼		
△	Press the △ key for 4 times to display "MEAS.METHOD".	MEAS.METHOD METHOD:2
▼		
ENT	Press the ENT key once to select, and press it once again to blink on the 2nd line.	MEAS.METHOD METHOD:2
▼		
△	Press the △ key twice to display "METHOD 1".	MEAS.METHOD METHOD:1
▼		
ENT	Press the ENT key once to register.	MEAS.METHOD ** COMPLETE **
▼		
▼		
▼	----- "METHOD 1" has been registered. -----	MEAS.METHOD METHOD:1
▼		
ESC △	Press the ESC key twice and then press the △ key once to enter the measurement mode.	0.000 m/s 0.000 m3/h

# 5. Mounting of detector

---

## 5.1. Detector mounting procedure

---

Mount the sensor on the pipe, and perform the following steps in order before making measurement.

Reference section	Work item	: Outline steps
5.2	Selection of mounting method	: Check the V/Z method, pipe size, and detector.
		↓
5.3	Mounting method on the pipe	: Apply acoustic couplant to the detector oscillation surface, and connect the sensor cable.

For the “5.3.Mounting method on the pipe”, refer to the separate instruction manual “ULTRA SONIC FLOW METER DETECTOR”

### 5.1.1. Mounting of detector

For sensor spacing, select either method in advance.

- Calculate from flow transmitter

Turn ON the flow transmitter.

Enter the piping information, etc described in Section 4.6.2, and display it.

Display example: PROCESS SETTING S=16 ( 48mm)

During wiring work, be sure to turn the power off.

Calculate from our website.

Address <http://www.fujielectric.com/products/instruments/products/flowmeter/top.html>

- Calculate from the CD attached to the equipment.

### 5.1.2. Image figure of mounting dimension

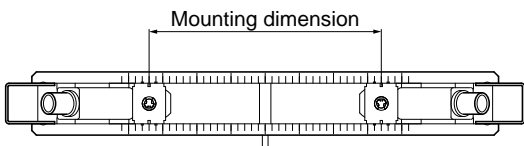
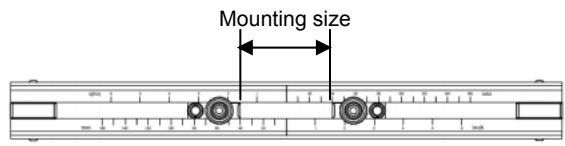
Type	FSS, FLS_12, FLS_22	FSSC
Mounting method	V method	V method
Mounting dimension		

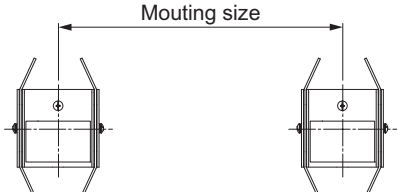
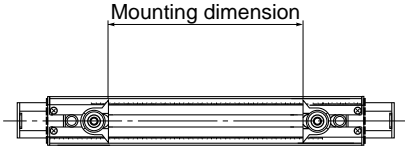
Type	FSSE, FSG_50, FSG_51	FSSD, FSD22, FSD32
Mounting method	V method	V method
Mounting dimension		

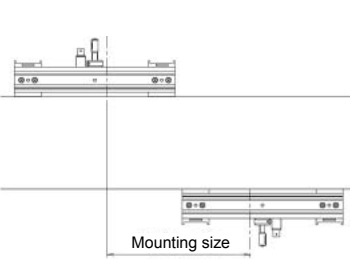
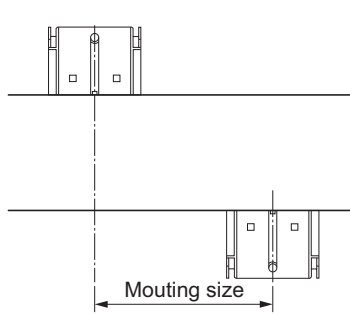
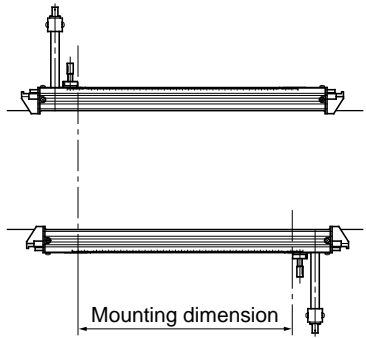
Type	FSSC	FSSE, FSG_50, FSG_51	FSSH, FSD32
Mounting method	V method	V method	V method
Mounting dimension			

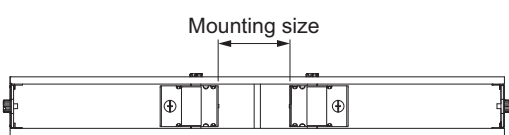
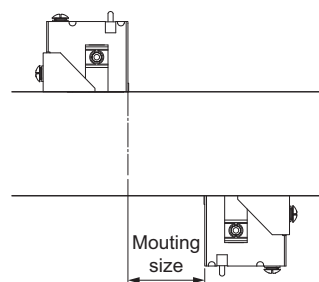
Type	FSG_31, FSG_32	FSG_41
Mounting method	V method	Z method
Mounting dimension		

## 5.2. Selection of mounting method

There are 2 methods for mounting the detector; V method and Z method. (See Fig. 5-1.)

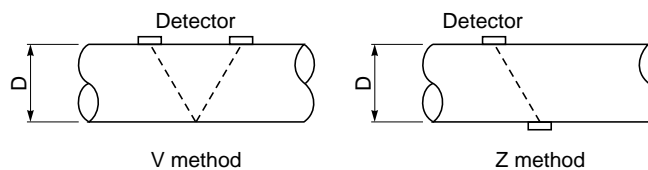

Fig. 5-1 Mounting method

The Z method should be used in the following cases.

- Where a V mounting space is not available.
- When measuring fluid of high turbidity such as sewage.
- When the pipe has a mortar lining.
- Piping is old and presumed to have a deposit of a thick layer of scales inside the piping.

Selection standard

The Z method for large size sensor is recommended for outer diameter 300mm or more.

Type	Fluid temperature [°C]	Mounting method	Inner diameter of piping $\phi$ (mm)									
			13	25	50	100	200	250	300	400	1000	3000
FSSA	-20 to 100	V	25 [ P, M ] 225									
FSSC	-40 to 120	V	50 [ Px, P, M ] 300									
		Z	200 [ Px, P, M ] 1200									
FSSE	-40 to 80	V	200 [ Px, P, M ] 3000									
		Z	200 [ Px, P, M ] 6000									
FSSD	-40 to 100	V	13 [ Px, P, M ] 100									
FSSH	-40 to 200	V	50 [ Px, P, M ] 250									
		Z	150 [ Px, P, M ] 400									

Classification of piping materials {  
Px : PP, PVDF  
P : Plastic (PVC, etc.)  
M : Metallic piping (steel pipe, copper pipe, aluminum, etc.)

Note: If ultrasonic waves cannot pass through the piping because the piping material category is Px or the turbidity of the fluid is high, it is recommended to use FSSC, FSSE types.

## 5.3. Mounting method on the pipe

Refer to the separate instruction manual "ULTRASONIC FLOWMETER DETECTOR"

# 6. CHECK AND MAINTENANCE

---

## 6.1. Daily Check

---

Visually check the following items.

- Whether flow transmitter cover screws are loose. ⇒ Tighten.
- Whether cable glands are loose. ⇒ Tighten.
- Whether detector mounting band is loose. ⇒ Stretch.
- Whether received wave is abnormal (LED lit red). ⇒ Check whether piping is filled or not. Remove bubbles or foreign matters, if mixed in measurement pipe. Also check if detector mounting and wiring are set up properly.

---

## 6.2. Periodic Inspection

---

### 6.2.1. Checking zero point

Stop the fluid flow, fill the measurement pipe fully, and check the zero point.

### 6.2.2. Reapplying grease

When using grease for the acoustic couplant, reapply it on the transmission surface of the sensor unit approximately once every 6 months.

Note) Silicone rubber need not be reapplied.

Refer to the separate instruction manual "ULTRA SONIC FLOWMETER DETECTOR"

## 6.2.3. How to measure the insulation resistance

### 6.2.3.1. Flow transmitter : FSV...S (IP66)

#### CAUTION

Turn off power before opening the flow transmitter cover.

The power terminals are provided with an arrester as standard.

Measurement point: measure between power terminal and ground terminal, each outputs and ground terminal.

The insulation resistance performance of the equipment is 100 M $\Omega$ /500 V DC.

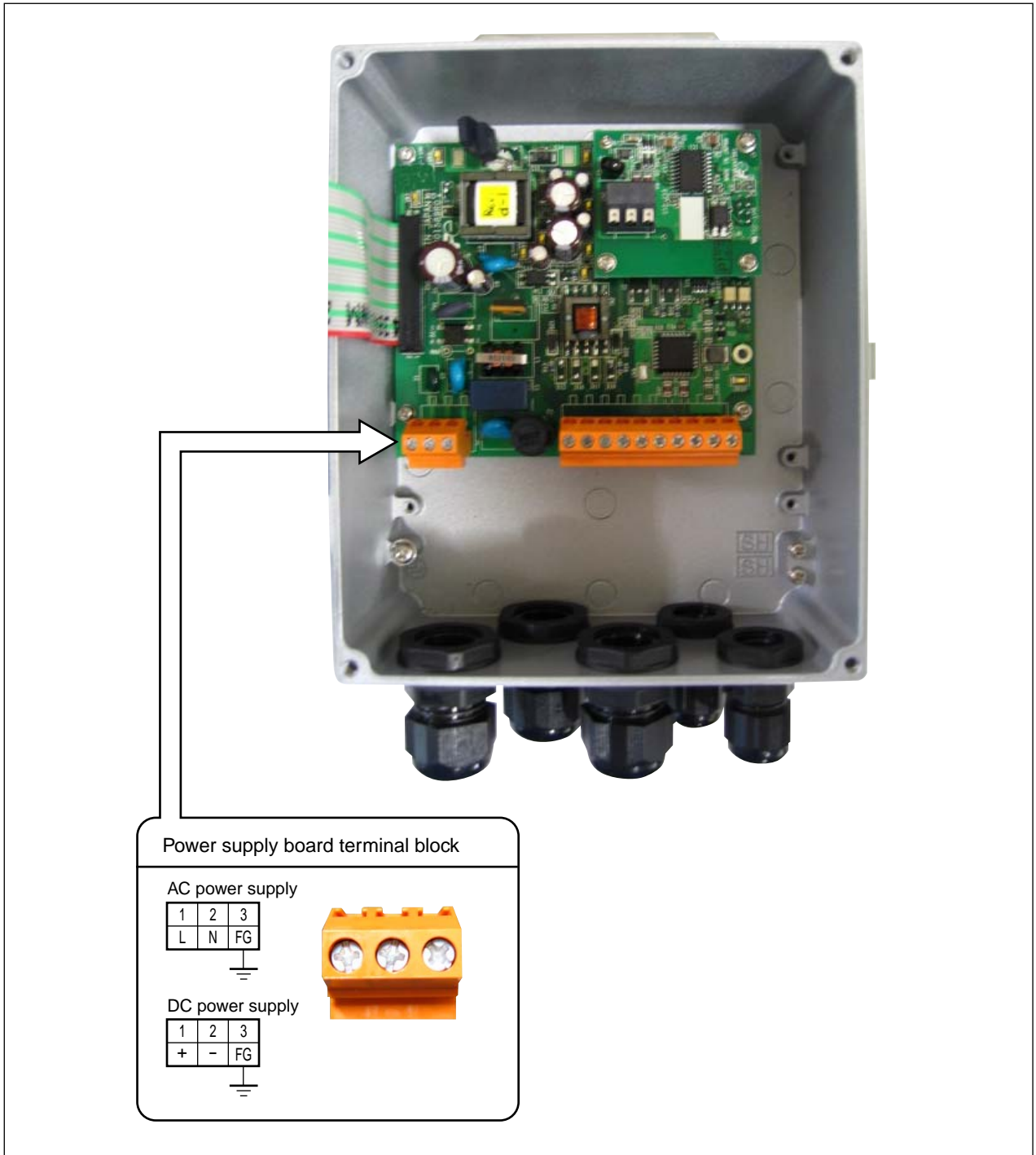



### 6.2.3.2. Flow transmitter : FSV...H (IP67)

## CAUTION

Turn off power before opening the flow transmitter cover.  
The power terminals are provided with an arrester as standard.  
Measurement point: measure between power terminal and ground terminal, each outputs and ground terminal.  
The insulation resistance performance of the equipment is 100 M $\Omega$ /500 V DC.

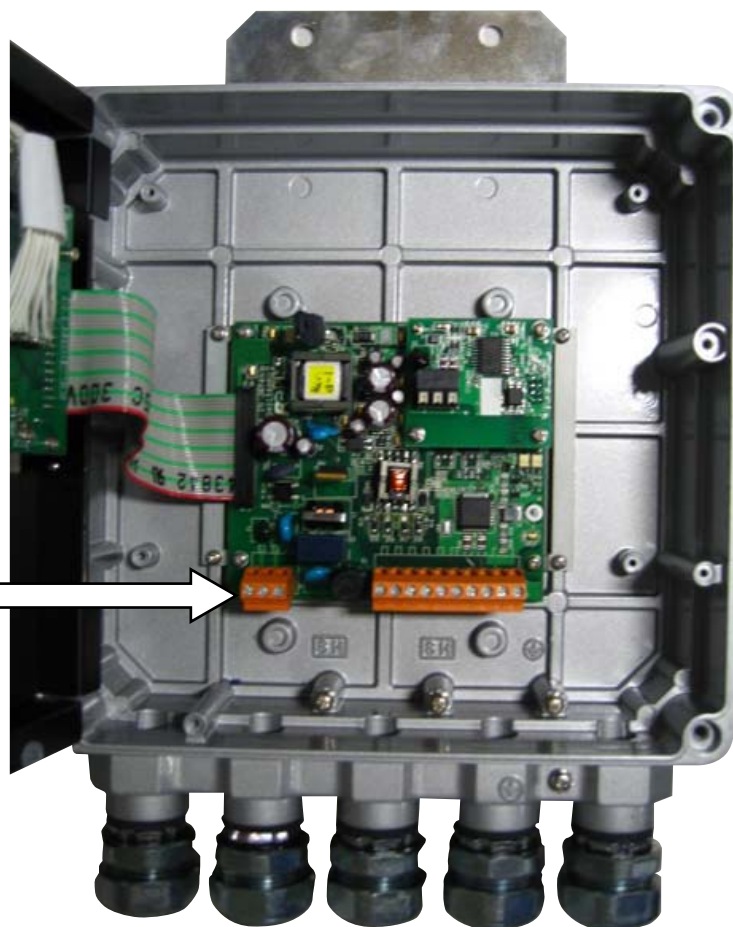

Power supply board terminal block

AC power supply

1	2	3
L	N	FG



DC power supply

1	2	3
+	-	FG



## 6.3. How to replace the fuse

### CAUTION

- Be sure to turn off the power before replacing the fuse.  
Fuse specifications  
(1) AC power supply (100V and 200V): 5.0m (diameter) × 20mm (long), 250V, 0.5A.  
Example: 218,500M x P 250V, 0.5A manufactured by littelfuse.  
(2) DC power supply: 5.2mm (diameter) × 20mm (long), 250V, 1A.  
As represented by Fuji Terminal Industry Co., Ltd. FGMB: 250V, 1A.

### 6.3.1. Flow transmitter : FSV...S (IP66)

- (1) Opening the cover after turning off power.  
Loosen 4 screws from the flow transmitter front, and open the cover.
- (2) Replace the fuse.  
Detach the fuse holder from the power supply board, and replace the fuse. Then, return the fuse holder in place.
- (3) Closing the cover.  
Close the cover, and tighten 4 screws.

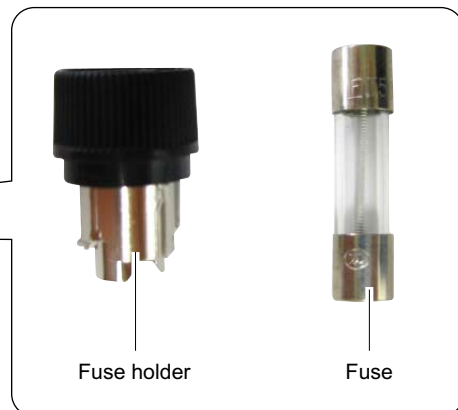
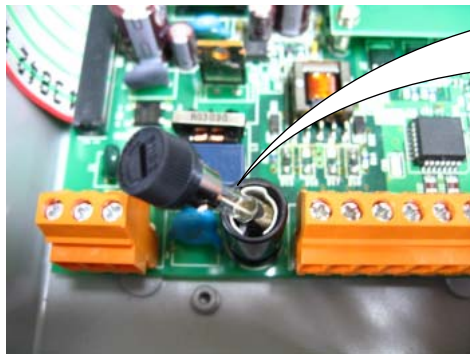

### CAUTION

- Turn on power only after closing the cover.

## 6.3.2. Flow transmitter : FSV...H (IP67)

- (1) Opening the cover after turning off power.  
Loosen 4 screws from the flow transmitter front, and open the cover.
- (2) Loosen 2 screws from the setting section of the display unit, and open the cover.
- (3) Replace the fuse.  
Detach the fuse holder from the power supply board, and replace the fuse. Then, return the fuse holder in place.
- (4) Close the setting section of the display unit, and tighten 2 screws.
- (5) Closing the cover.  
Close the cover, and tighten 4 screws.

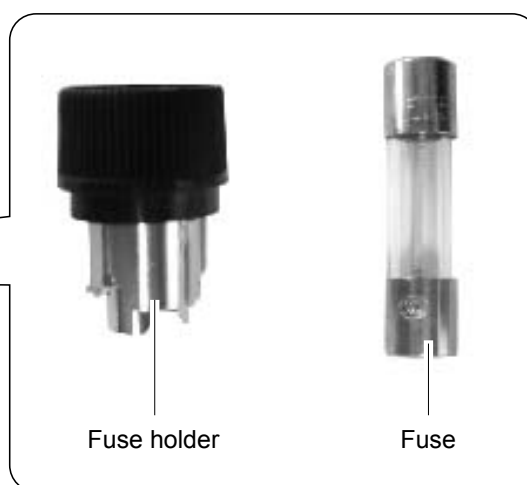
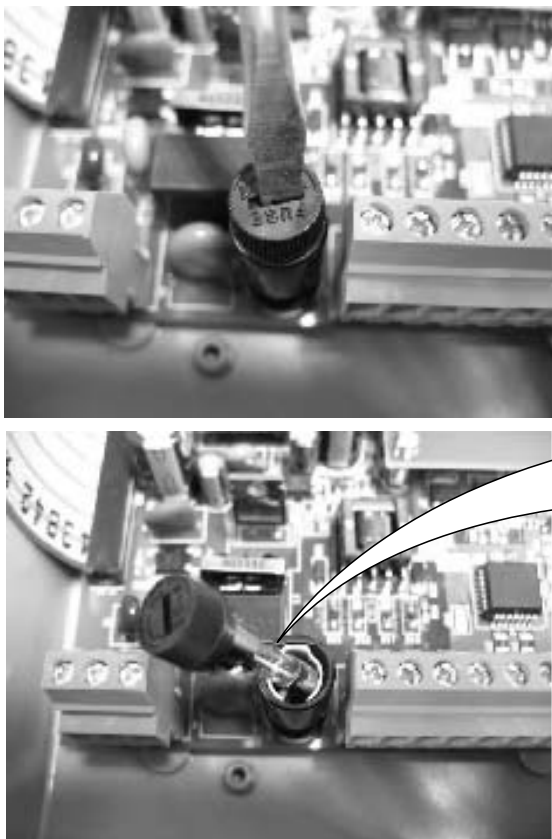

### CAUTION

- Turn on power only after closing the cover.

## 6.4. How to replace the LCD

The nominal service life of the LCD is 7 years. The contrast gradually deteriorates with time. Replace it about 5 years after starting its use.

### 6.4.1. Flow transmitter : FSV...S (IP66)

[How to replace]

- (1) Open the cover after turning OFF power.
- (2) Remove the flat cable connector.
- (3) Loosen 4 screws from the mainboard and then pull out the main board.
- (4) Loosen 4 screws from the LCD unit.
- (5) Put the insulation sheet on the New LCD unit (see parts list) which was attached to previous LCD unit around the screw and fix it to the New LCD with screws.  
Be sure not to tighten the screws too much since screws are made of plastic.
- (6) When you mount the main board, insert mainboard to the connector of LCD unit properly.
- (7) Connect the flat cable connector. (Insert it securely all the way.)
- (8) Close the cover and turn on the power.
- (9) Check that the LCD display and key operation are functioning correctly.
- (10) Be sure to conduct the contrast adjustment for brightness of the display.



### CAUTION

- Be sure to turn off the power before opening the cover. The unit contains high voltage.
- Do not conduct the replacement when your body holds the static electricity. It causes the failure.
- Do not conduct the replacement with wet hands. It causes failure.

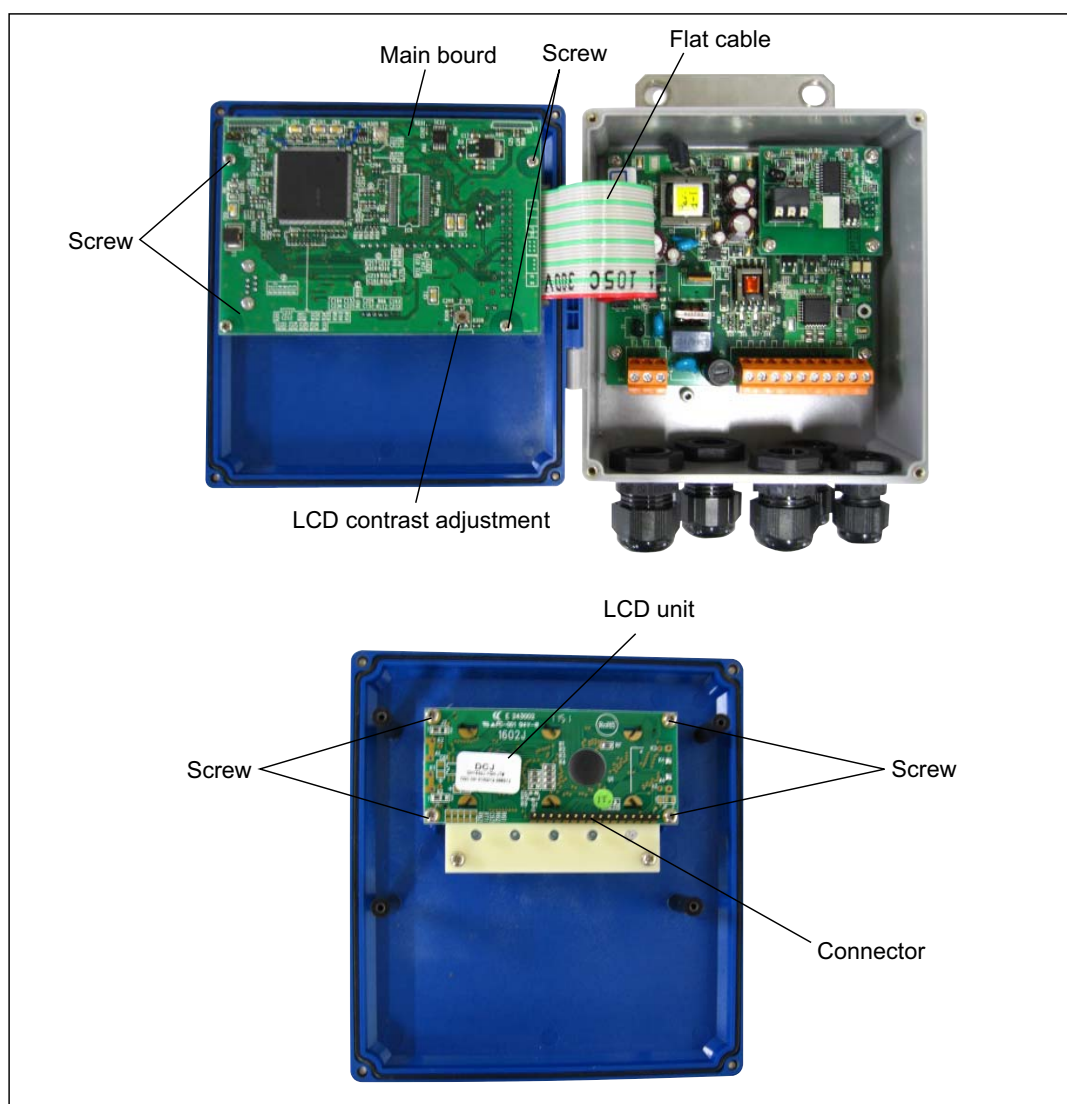

## 6.4.2. Flow transmitter : FSV...H (IP67)

[How to replace]

- (1) Open the cover after turning OFF power.
- (2) Loosen 2 screws from the setting section of the display unit, and open the cover.
- (3) Remove the flat cable connector.
- (4) Remove the LCD cable connector.
- (5) Loosen 3 screws from mainboard.
- (6) Loosen 4 screws from the LCD unit.
- (7) Mount a new LCD unit (see parts list).
- (8) Mount the mainboard.
- (9) Connect the LCD cable connector.
- (10) Connect the flat cable connector. (Insert it securely all the way.)
- (11) Close the setting section of the display unit, and tighten 2 screws.
- (12) Close the cover and turn on the power.
- (13) Check that the LCD display and key operation are functioning correctly.
- (14) Be sure to conduct the contrast adjustment for brightness of the display.



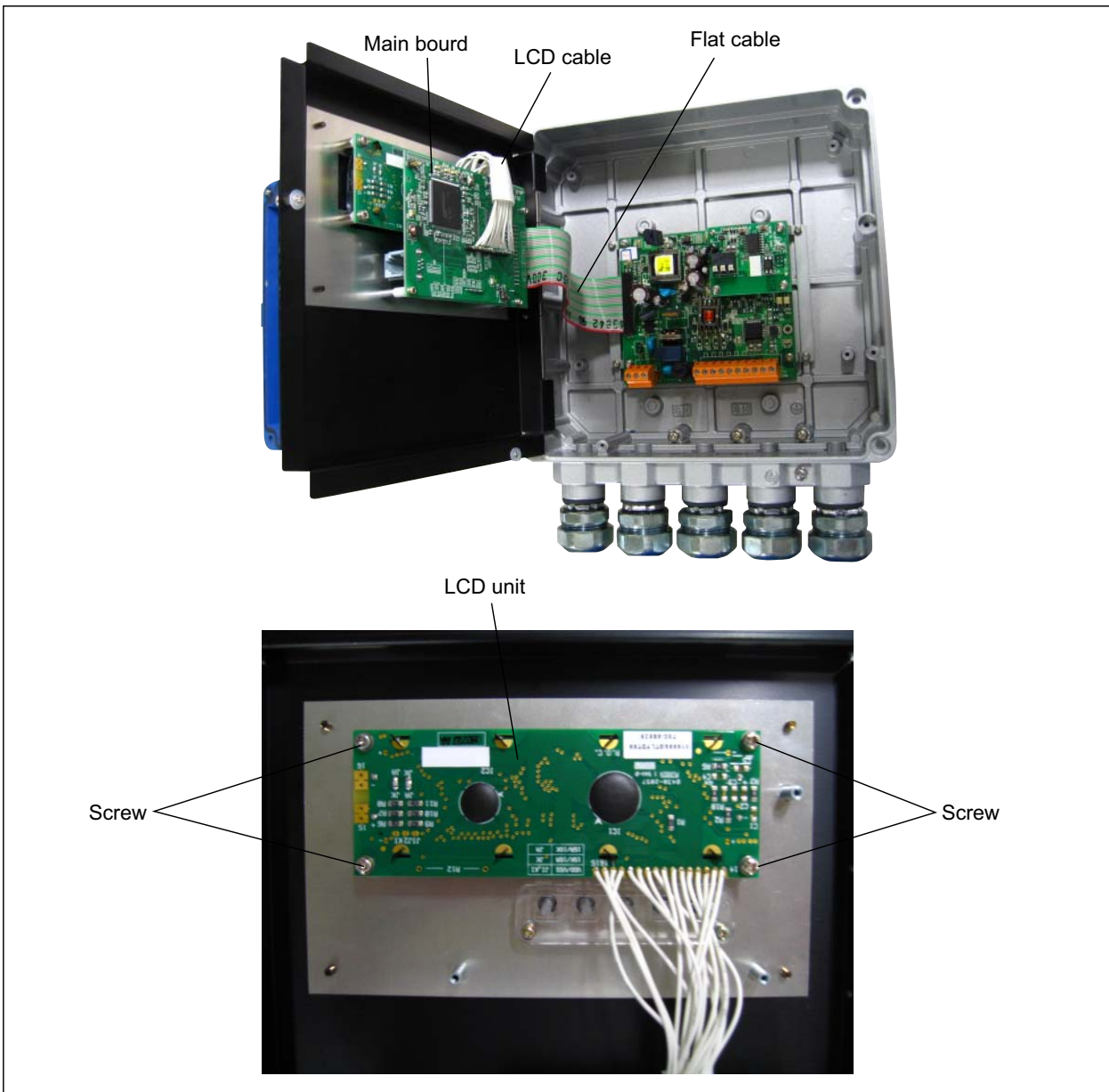

### CAUTION

- Be sure to turn off the power before opening the cover. The unit contains high voltage.
- Do not conduct the replacement when your body holds the static electricity. It causes the failure.
- Do not conduct the replacement with wet hands. It causes failure.



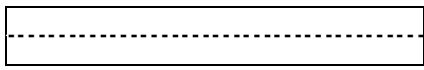

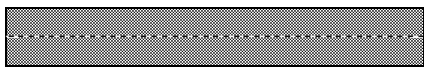









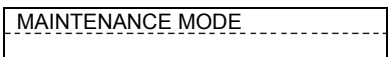



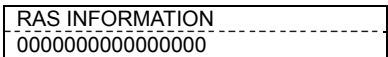



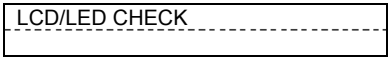



## 6.5. ERROR AND REMEDY

### 6.5.1. Display error

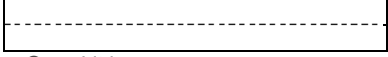
State	Probable cause
 Nothing is displayed.	<ul style="list-style-type: none"> <li>● Power supply is not turned on.</li> <li>● Low power supply voltage</li> <li>● Fuse is blown out.</li> <li>● LCD error ⇒ Refer to "6.5.7. Remediating a hardware fault".</li> <li>● Reverse polarity of DC power supply</li> </ul>
 Upper side appears black.	<ul style="list-style-type: none"> <li>● Low power supply voltage</li> <li>● Reverse polarity of DC power supply</li> <li>● LCD error ⇒ Refer to "6.5.7. Remediating a hardware fault".</li> </ul>
 Irrational display	<ul style="list-style-type: none"> <li>● Hardware error ⇒ Refer to "6.5.7. Remediating a hardware fault".</li> </ul>
 Pale display	<ul style="list-style-type: none"> <li>● Ambient temperature is low (-20°C or lower) ⇒ Increase temperature.</li> <li>● LCD has reached the end of its service life. ⇒ Replace the LCD.</li> </ul>
 Entire display is blackish.	<ul style="list-style-type: none"> <li>● Ambient temperature is high (50°C or higher) ⇒ Decrease temperature.</li> </ul>
LCD characters are skipped. LED does not come on	<ul style="list-style-type: none"> <li>● Refer to "6.5.1.1. Checking the LCD/LED" for LCD/LED.                      The dots on the LCD are missing or the LED does not come on.                      ⇒ Refer to "6.5.7. Remediating a hardware fault".</li> </ul>
LED is displayed in red.	<ul style="list-style-type: none"> <li>● Received wave is abnormal.                      ⇒ Refer to "6.5.1.2. Checking the LED lit in red".</li> </ul>

#### 6.5.1.1. Checking the LCD/LED

Follow the procedure shown below to check possible display errors.

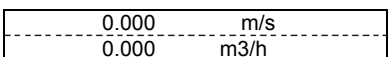
Key operation	Description	Display
	Press the  key for 4 times to display "MAINTENANCE MODE".	
		
	Press the  key once to display "RAS INFORMATION".	
		
	Press the  key for 12 times to display "LCD/LED CHECK".	
		
	Press the  key once.	
		
	Every time the  key is pressed, the display is switched in the order shown below.	
		
	LCD: OFF completely    LED: Lit in green LCD: Darkened         LED: Lit in red If dots on the LCD are missing or the LED does not come on, the LCD/LED may have failed.	
 	Obtain a measurement-mode display using the  and the  keys.	

### 6.5.1.2. Checking the LED lit in red

Check the LED lit in red, following the procedure shown below.

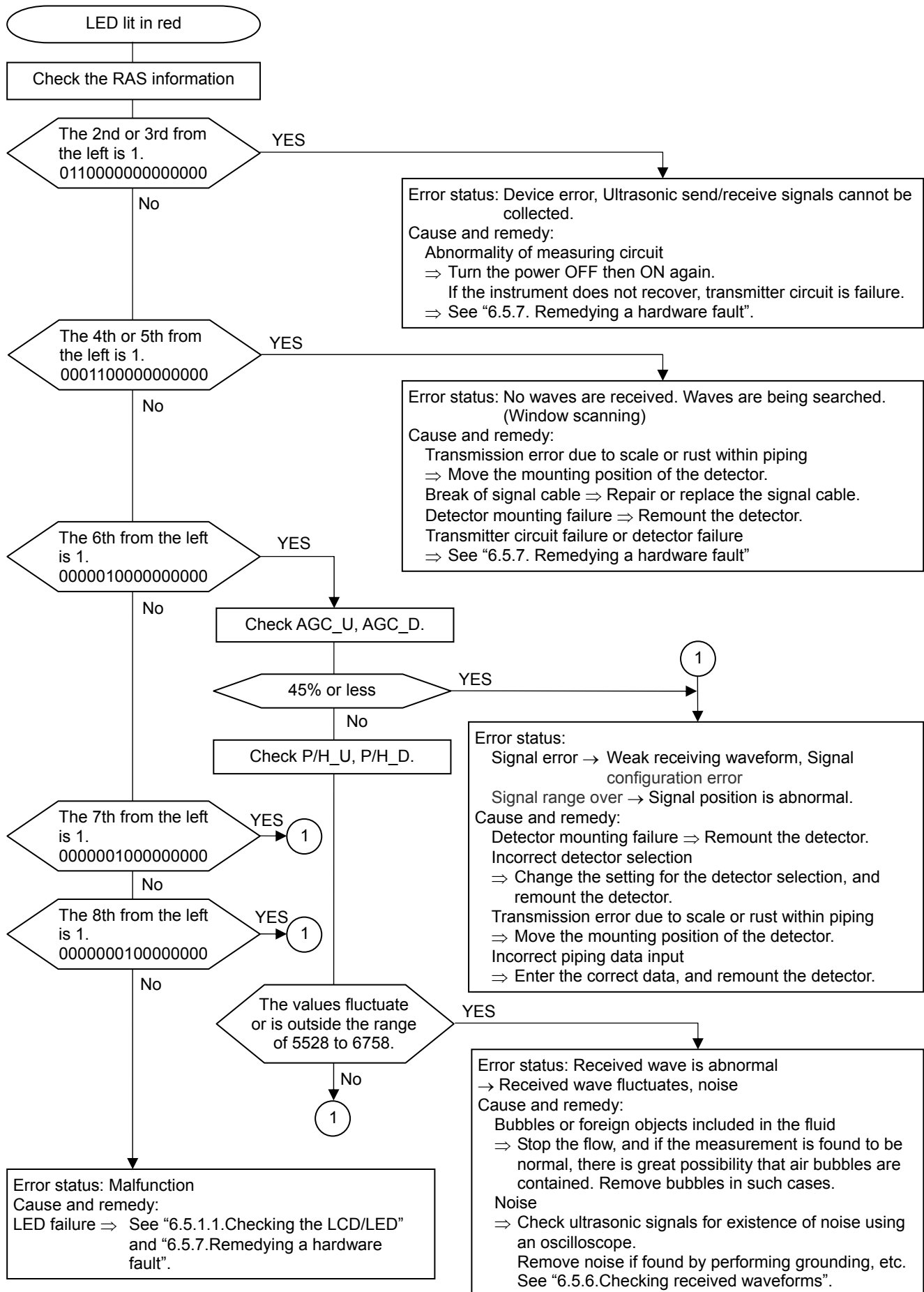



### 6.5.1.3. Checking the RAS information

When the red LED lights up, check the error contents according to the RAS information.

Key operation	Description	Display
	Press the key for 4 times to display "MAINTENANCE MODE".	
 	Press the key once to display "RAS INFORMATION".	

If the display is abnormal, 1 is set.  
Move the cursor to 1 by the key,  
and press the key to display the  
status contents. Pressing the   
key again displays the troubleshooting.

#### Configuration of the RAS information

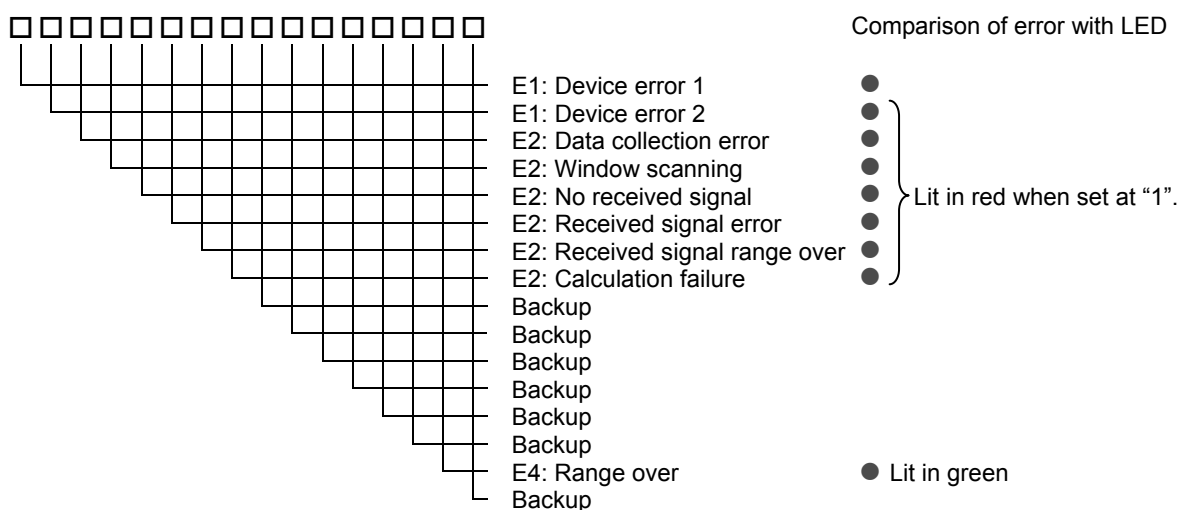

RAS information	Status	Troubleshooting
E1: Device error 1	Backup memory failure	See "6.5.7. Remediating a hardware fault".
E1: Device error 2	Abnormality of measuring circuit	Turn the power off then on again. If the instrument does not recover properly, refer to "6.5.7. Remediating a hardware fault".
E2: Data collection error	Ultrasonic send/receive signals cannot be collected.	
E2: Window scanning	The ultrasonic receiving signal waveform is being detected.	Move the mounting position of the detector, and remount the detector.
E2: No received signal	No ultrasonic receiving signal waveform	Repair or replace the signal cable. Transmitter circuit failure or detector failure ⇒ See "6.5.7. Remediating a hardware fault".
E2: Received signal error	The status of received waveform is poor.	Check the air bubbles or foreign objects. Check the receive sensitivity. ⇒ Move the mounting position of the detector, and remount the detector.
E2: Received signal range over	Receiving signal waveform is outside the appropriate range.	Check the piping data. Check the detector mounting dimensions.
E2: Calculation failure	The value of detected measurement data is abnormal.	Check the piping data. Check the receive sensitivity. ⇒ Move the mounting position of the detector, and remount the detector.
E4: Range over	Analog output and total output exceed the range.	Check the range data and the totalize setting.

#### Correspondence between DO output and Alarm

- "All" : Alarm is issued at occurrence of E1 or E2. [Burnout timer is enabled]
- "Device error" : Alarm is issued at occurrence of E1. [Burnout timer is disabled]
- "Process error" : Alarm is issued at occurrence of E2. [Burnout timer is enabled]

Burnout timer is to set a time between error occurrence and contact output.



## 6.5.2. Displaying the data in maintenance mode

Follow the procedure shown below to check possible display errors.

Key operation	Description	Display
	Press the  key for 4 times to display "MAINTENANCE MODE".	MAINTENANCE MODE
	Press the  key once to display "RAS INFORMATION".	RAS INFORMATION 0000000000000000
	Press the  key for 13 times to display "DATA DISPLAY".	DATA DISPLAY
	Press the  key. ● Displays the transit time and the window value calculated from the piping setting.	T0 C: 89 usec WinC: 80 usec
	Press the  key once. ● Displays the measurement value of transit time, T1 (forward time), and T2 (reverse time) from the piping setting.	T1: 0.000 usec T2: 0.000 usec
	Press the  key once. ● Displays the measurement value of average transit time, T0, and transit time difference, DT.	T0: 0.000 usec DT: 0.00 nsec
	Press the  key once. ● Displays the calculated value of pass time of the substances other than fluid, Ta, and angle of incidence of the fluid, $\theta$ .	Ta: 0.0000 usec $\theta$ f: 0.000°
	Press the  key once. ● Displays the calculation value of sound velocity in fluid, Cf, and Reynolds number, Re.	Cf: 0.0 m/s Re: 0
	Press the  key once. ● Displays correction coefficient of flow velocity distribution, K, and flow velocity, V.	K: 1.3333 V: 0.000 m/s
	Press the  key once. ● Displays the intensity of received signals. The larger the value, the larger the intensity of received signals. Normal measurement values fall in 45% or more. If the display appears as 0%, no signals are being received. Ultrasonic waves may not be transmitted because of insufficient water volume or rust of piping.	AGC U: 0.00 % AGC D: 0.00 %
	Press the  key once. ● Displays the peak value of received signal waveform. Normal values stably fall within the range from 5528 to 6758. If the value fluctuates significantly, objects that constitute barriers against ultrasonic wave transmission such as air bubbles or foreign matter may be contained in the fluid. Stop the flow and check if normal value is resumed. If so, there is a possibility that air bubbles are contained.	P/H U: 6143 P/H D: 6143
	Press the  key once. ● Displays the detection level value of received signal waveform.	TRG U: 25.00% TRG D: 25.00%
	Press the  key or the  key to display the measurement mode.	

### 6.5.3. Keying is abnormal

Status	Probable cause
No response is made to key input.	● Hard failure ⇒ <a href="#">Refer to "6.5.7. Remediating a hardware fault"</a> .
Certain key is not responded. Action is not as defined.	

## 6.5.4. Error in measured value

Status	Probable cause	Troubleshooting
The reading appears with “-” (minus).	<ul style="list-style-type: none"> <li>● Connection between main unit and sensor units (upstream, downstream) are inverted.</li> </ul>	<p>→ Connect properly.</p>
Measured value fluctuates though flow rate is constant.	<ul style="list-style-type: none"> <li>● Straight pipe length is inadequate.</li> <li>● Pump, valve or others which disturb the flow are located nearby.</li> <li>● Pulsation exists in flow.</li> </ul>	<p>→ Move the sensor to the place where the length of 10D can be assured on upstream side and 5D on downstream side.</p> <p>→ Mount the instrument with a clearance of 30D or more.</p> <p>→ Set the damping to increase the response time.</p>
Measured value remains the same though flow rate is changing. (LED lit in red)	<p>Measured value is held because ultrasonic wave cannot be propagated into a pipe.</p> <p>1. Incomplete installation</p> <div data-bbox="464 808 836 1088" style="border: 1px solid black; padding: 5px;"> <ul style="list-style-type: none"> <li>● Error in piping specifications</li> <li>● Sensor is mounted on welding.</li> <li>● Error in sensor mounting dimensions</li> <li>● Error in acoustic coupler at the time of mounting the sensor</li> <li>● Error in connection of the sensor cable.</li> </ul> </div> <p>→</p> <div data-bbox="464 1111 836 1223" style="border: 1px solid black; padding: 5px;"> <p>Sensor mounting is poor</p> <ul style="list-style-type: none"> <li>● Mounting dimension</li> <li>● The sensor is coming off the pipe.</li> </ul> </div> <p>→</p> <p>2. Problem on pipe or fluid</p> <p>○ <span data-bbox="464 1323 836 1357" style="border: 1px solid black; padding: 2px;">Pipe not filled with fluid</span></p> <p>→</p> <p>○ <span data-bbox="464 1491 836 1525" style="border: 1px solid black; padding: 2px;">Bubbles present in the fluid</span></p> <div data-bbox="464 1536 836 1603" style="border: 1px solid black; padding: 2px;"> <p>[Bubbles are introduced if reading is normal when flow is stopped.]</p> </div> <p>→</p> <div data-bbox="464 1626 836 1738" style="border: 1px solid black; padding: 2px;"> <p>[If mounted immediately downstream a valve, a cavitation causes the same phenomenon as when bubbles are introduced.]</p> </div>	<div data-bbox="943 808 1394 898" style="border: 1px solid black; padding: 5px;"> <p>Upon checking, remove the sensor, apply acoustic coupler, and slightly off position the sensor.</p> </div> <div data-bbox="943 1111 1394 1245" style="border: 1px solid black; padding: 5px;"> <ul style="list-style-type: none"> <li>● Mount the sensor in parallel with pipe, allowing correct sensor unit spacing.</li> <li>● Mount the sensor properly so that it is kept in close contact with the pipe.</li> </ul> </div> <div data-bbox="943 1323 1394 1458" style="border: 1px solid black; padding: 5px;"> <p>Locate a place which is completely filled on the same piping line, and shift the sensor there.</p> <ul style="list-style-type: none"> <li>● Attach the sensor to the lowest place on the pipeline.</li> </ul> </div> <div data-bbox="943 1536 1394 1850" style="border: 1px solid black; padding: 5px;"> <p>Eliminate ingress of bubbles.</p> <ul style="list-style-type: none"> <li>● Raise the level of the pump well.</li> <li>● Check the shaft seal of the pump.</li> <li>● Retighten the flange of negative pressure pipe.</li> <li>● Arrange so that fluid doesn't fall into the pump well.</li> </ul> <p>-----</p> <p>Move the sensor to the location where air bubbles have not entered.</p> <ul style="list-style-type: none"> <li>● Inlet side of the pump</li> <li>● Upstream side of the valve</li> </ul> </div>

(Continued on next page.)

Status	Probable cause	Troubleshooting
(Continued from the previous page.)	<ul style="list-style-type: none"> <li>○ High turbidity [Turbidity is higher than those of sewage and return sludge.] →</li> <li>○ Pipe is old and scale is attached on inside. →</li> <li>○ Lining is thick. [Because of mortar lining or the like, thickness is tens mm or more.] →</li> <li>○ Lining is peeled. [There is a gap between the lining and the pipe.] →</li> <li>○ Sensor is mounted on bend pipe or tapered pipe. →</li> <li>3. Effect of external noise → <ul style="list-style-type: none"> <li>● There is a radio broadcasting station nearby.</li> <li>● Measurement conducted near a passage of vehicles or electric cars.</li> </ul> </li> <li>4. Hard failure →</li> </ul>	<div style="border: 1px solid black; padding: 5px; margin-bottom: 10px;"> <ul style="list-style-type: none"> <li>● Move sensor to a place of smaller diameter on the same pipeline.</li> <li>● Move the sensor to other places or to different piping.</li> </ul> </div> <div style="border: 1px solid black; padding: 5px; margin-bottom: 10px;"> <p>Mount the sensor on straight pipe.</p> </div> <div style="border: 1px solid black; padding: 5px; margin-bottom: 10px;"> <ul style="list-style-type: none"> <li>● Reduce the length of main unit sensor cable to a minimum.</li> <li>● Ground the main unit and piping.</li> </ul> </div> <div style="border: 1px solid black; padding: 5px;"> <p>Refer to "6.5.7. Remediating a hardware fault".</p> </div>
Measured value not zero when fluid stops flowing.	<ul style="list-style-type: none"> <li>● Fluid forms a convection inside the pipe. →</li> <li>● Zero point adjustment →</li> <li>● Pipe is not completely filled or is empty when water is at a standstill (LED lit red). →</li> </ul>	<div style="border: 1px solid black; padding: 5px; margin-bottom: 10px;"> <p>Normal</p> </div> <div style="border: 1px solid black; padding: 5px; margin-bottom: 10px;"> <ul style="list-style-type: none"> <li>● Readjust the zero point after fluid has completely stopped flowing.</li> </ul> </div> <div style="border: 1px solid black; padding: 5px;"> <p>Normal</p> </div>
Error in measured value	<ul style="list-style-type: none"> <li>● Input piping specifications differ from the actual ones. →</li> <li>● Scales exist on wall of old pipe. →</li> <li>● Insufficient linear pipe length (10D or more for upstream and 50D or more for downstream) →</li> <li>● Pipe is not filled with fluid or sludge is deposited in the pipe. →</li> </ul>	<div style="border: 1px solid black; padding: 5px; margin-bottom: 10px;"> <p>A difference of 1% in inner diameter causes an error of about 3%.  <ul style="list-style-type: none"> <li>● Input the correct specifications.</li> <li>● Input scale as lining.</li> </ul> </p> </div> <div style="border: 1px solid black; padding: 5px; margin-bottom: 10px;"> <p>Find another mounting place (upstream of disturbing objects).  [No disturbing objects in flow within 30D upstream without pump, valve, combined pipe, etc.]</p> </div> <div style="border: 1px solid black; padding: 5px; margin-bottom: 10px;"> <ul style="list-style-type: none"> <li>● Mount the sensor at different angles with respect to the cross section of pipe to fine the location where mean value is obtainable. The mount the sensor at that location.</li> </ul> </div> <div style="border: 1px solid black; padding: 5px;"> <p>Occurs particularly where sectional area is small.  <ul style="list-style-type: none"> <li>● Move sensor to a vertical pipe.</li> </ul> </p> </div>

## 6.5.5. Error in analog output

Status	Probable cause	Troubleshooting
Current output is not matched.	Range setting is wrong.	→ ● Set the range correctly.
Not 4mA when measurement value is 0.	Analog output is misadjusted.	→ ● Perform analog output calibration.
Output is 0mA.	Break of wiring	
Output rises beyond 20mA.	“OVER FLOW” appears on the LCD.	→ Range over ● Recommence setting of range data of analog output.
The output becomes lower than 4mA.	“UNDER FLOW” appears on the LCD.	→ Back flow ● Set upper/lower stream properly.
Indication is changed but analog output remains the same.	The output load is 600 Ω or more.	→ ● It must be less than 600 Ω.
Indication does not agree with analog output.	Analog output is misadjusted.	→ ● Perform analog output calibration.
Analog output doesn't change even after it has been adjusted.	Hard failure	→ ● Contact manufacture or service.

## 6.5.6. Checking received waveforms

The unit has high-voltage part. Be sure to ask our service personnel for the steps described below.

### 6.5.6.1. How to connect the oscilloscope

Open the cover, and connect an oscilloscope to the check pin on the printed board according to the following figure. The unit has high-voltage components. Do not touch the parts other than those specified below.

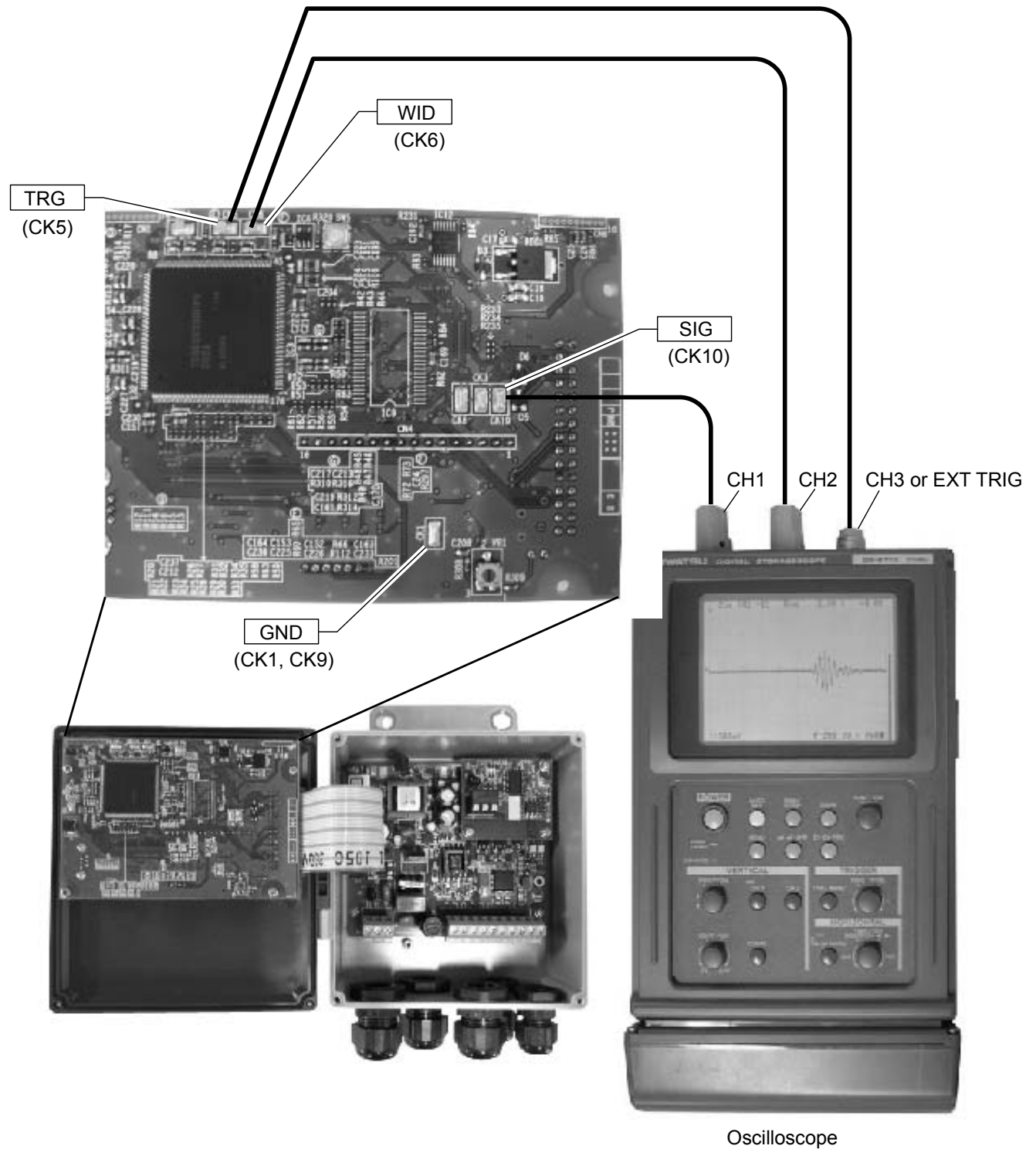

### 6.5.6.2. Checking sending/receiving

Monitor the waveform, and check the status of received waveform.

a) Normal status

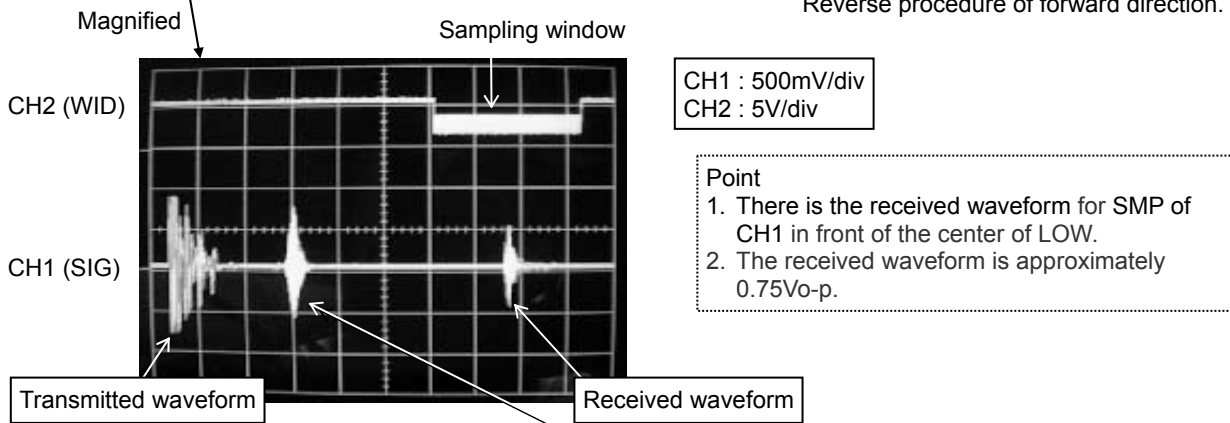
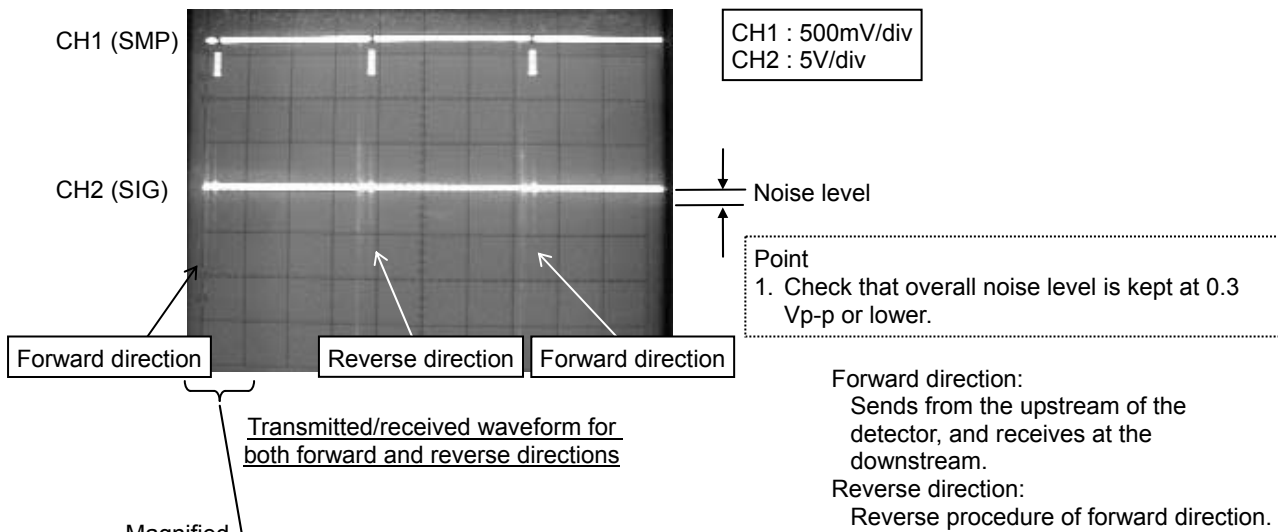

Relationship between the received waveform and the sampling window

Pipe inside echoic wave (generated only in case of V method mounting).  
In mounting by the Z method, there is no echoic wave.

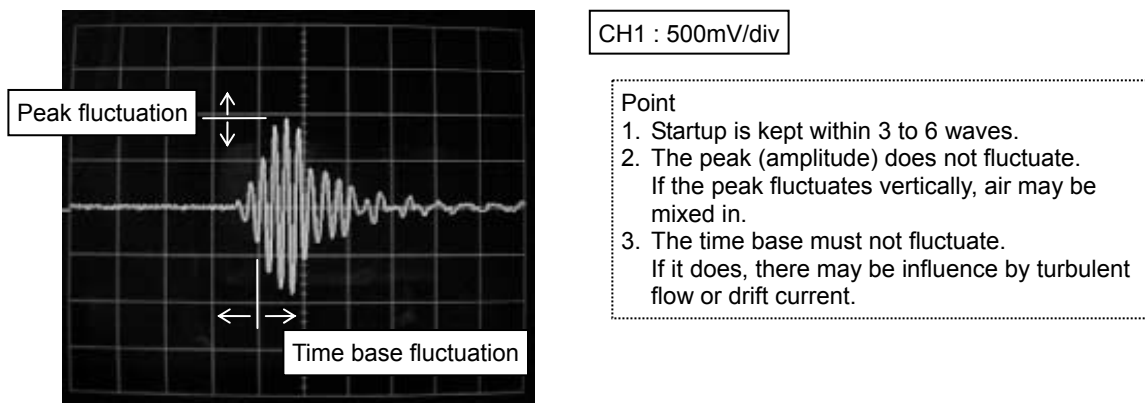

Magnified view of signals

The received waveform controls the peak to be approximately 1.5Vp-p.

Startup of signals is not good

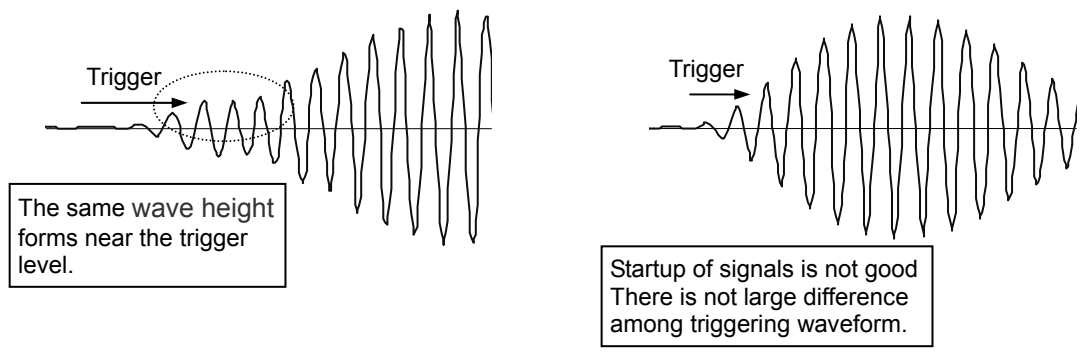

Cause of the poor startup signals

- (1) Incorrect detector mounting, dimensions (sensor mounting dimension, outer diameter, etc) and detector mounting angle

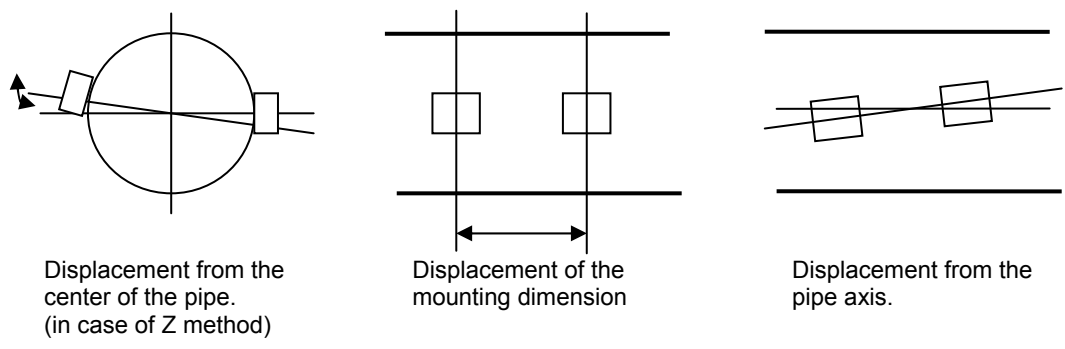

⇒ Mount the detector properly.

- (2) Interference from acoustic wave (It is likely to happen when the outer diameter is set longer than the actual length.)  
 ⇒ Make a setting of the acoustic wave of the fluid type to be 20 to 50m/s lower, and remount the detector again.  
 Note) 1400m/s is set for water.

b) Noise on the one side

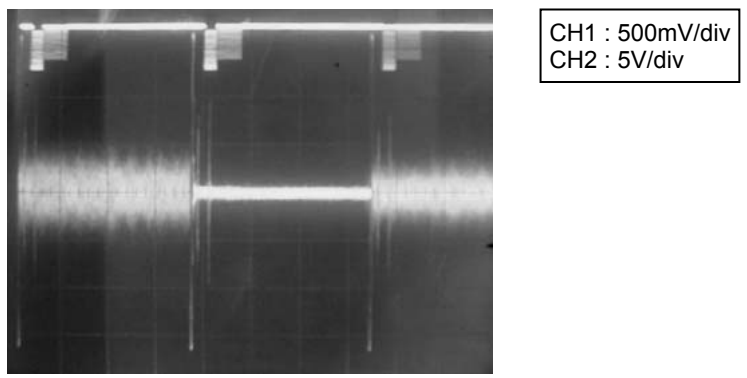

Waveform with noise on the one side

<Cause>	<Check>
Dedicated cable on the one side is abnormal.	Measure the insulation resistance.
Polarity of connected terminals is inverted.	Check the connection
Sensor on the one side is abnormal.	Peel off the detector and check the sensitivity
Detector bonding surface is peeling.	Peel off the detector and temporarily place it by grease, etc.
Dedicated cable is disconnecting.	Check the continuity.
Poor contact.	Check the connection



c) There is white noise all around.

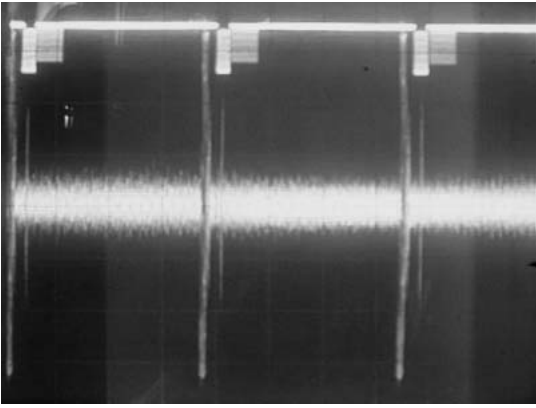

Waveform with the overall noise

d) Pulsed noise is observed.

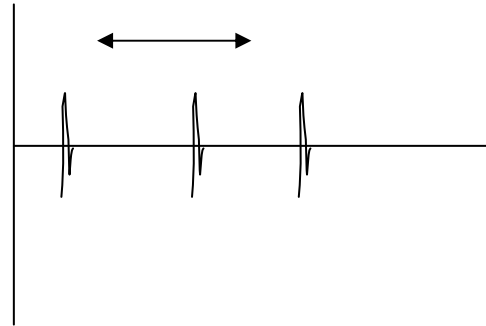

Waveform with pulsed noise on the signal line

Measurement can be performed if the noise level is smaller than the received waveform level ( $0.75V_{0-p}$ ).

<Cause>	<Check>
Noise is placed on the power line.	Check the power line using an oscilloscope, and install a noise-suppression transformer.
Noise is placed on the grounding line (panel earth, etc).	Check the power line using an oscilloscope, and remove the ground wire.
Dedicated cable is picking the inductive noise.	Move the flow transmitter near the detector and perform confirmation. Keep the dedicated cable apart from the power cable.
The distance between the detector and the flow transmitter is long, and dedicated cable length is long.	Perform grounding according to the figure below.
Insufficient sensitivity Signal power (AGC_U, AGC_D) 45% or less	Change the detector. FSSA→FSSC FSSC→FSSE

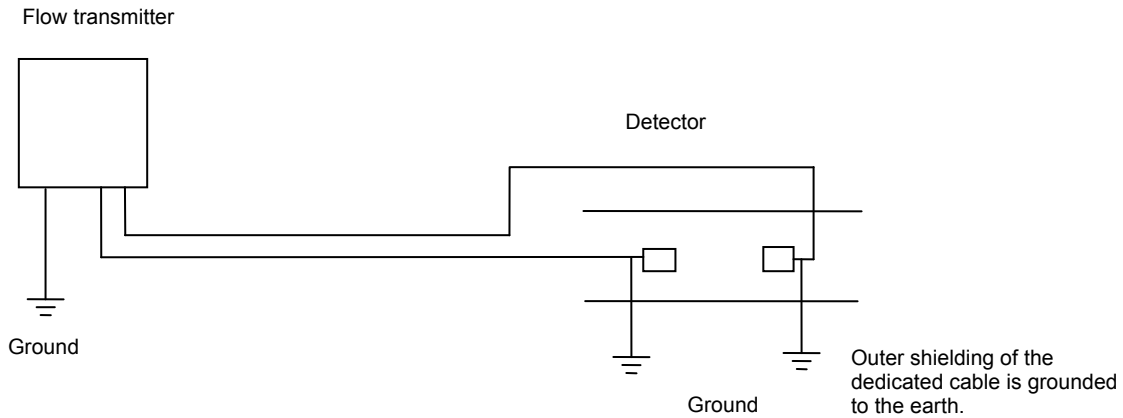

### 6.5.7. Remediating a hardware fault

If the hardware is found faulty as a result of Section 6.5.1 to Section 6.5.6 above, provide specific details to Fuji Electric.

# 7. Appendix

## 7.1. Specifications

### SPECIFICATIONS

#### Operational specifications

##### System configuration:

Single-path system of a flow transmitter (Model FSV) and a detector (Model FSS)

##### Applicable fluid:

Homogenous liquid where the ultrasonic signal can be transmitted  
Bubble quantity: 0 to 12vol% (for pipe size 50A, water, velocity 1m/s)  
Fluid turbidity: 10000mg/L max.  
Type of flow: Fully-developed turbulent or laminar flow in a full-filled pipe

##### Flow velocity range:

0 to  $\pm 0.3 \dots \pm 32$ m/s

##### Power supply:

100 to 240V AC +10%/-15%, 50/60Hz;

or 20 to 30V DC

##### Signal cable (between detector and converter):

Coaxial cable (150m max.) applicable up to 300m depending on the condition.  
Heat resistance: 80°C

##### Installation environment:

Non-explosive area without direct sunlight, corrosive gas and heat radiation.

##### Ambient temperature:

Flow transmitter: -20 to +55°C

##### Ambient humidity:

Flow transmitter: 95%RH max.

##### Grounding:

Class D (100  $\Omega$ )

##### Arrester:

Provided as standard at power supply

#### Performance specifications

##### Rated accuracy:

<table 1>

Detector Type	Pipe size (diameter) mm	Flow velocity (m/s)	Accuracy		
			Plastic pipe	Metal pipe	
FSSA	ø25 to ø50	2 to 32m/s	±2.0% of rate		
		0 to 2m/s	±0.04m/s		
	ø50 to ø225	2 to 32m/s	±1.0% of rate	±2.0% of rate	
		0 to 2m/s	±0.02m/s	±0.04m/s	
FSSC	ø50 to ø200	2 to 32m/s	±1.5% of rate		
		0 to 2m/s	±0.03m/s		
	ø200 to ø1200	2 to 32m/s	±1.0% of rate		
		0 to 2m/s	±0.02m/s		
FSSD	ø13 to ø50	2 to 32m/s	±1.5% to ±2.5% of rate		
		0 to 2m/s	±0.03m/s to ±0.05m/s		
	ø50 to ø100	2 to 32m/s	±1.0% of rate		
		0 to 2m/s	±0.02m/s		
FSSH	ø50 to ø300	2 to 32m/s	±1.0% of rate		
		0 to 2m/s	±0.02m/s		
	ø300 to ø400	0.75 to 32m/s	±1.0% of rate		
		0 to 0.75m/s	±0.0075m/s		
FSSE	ø20 to ø300	2 to 32m/s	±1.5% of rate		
		0 to 2m/s	±0.03m/s		
	ø300 to ø1200	0.75 to 32m/s	±1.5% of rate		
		0 to 0.75m/s	±0.0113m/s		
	ø1000 to ø6000	1 to 32m/s	±1.0% of rate		
		0 to 1m/s	±0.02m/s		

##### Response time: 0.5s (standard mode)

0.2s as selected (quick response mode)

##### Power consumption:

15VA max. (AC power supply)

6W max. (DC power supply)

#### Functional specifications

##### Analog signal: 4 to 20mA DC (1 point)

Load resistance: 600 $\Omega$  max.

##### Digital output:

Forward total, reverse total, alarm, acting range, flow switch, total switch assignable arbitrarily  
Transistor contact (isolated, open collector)  
• Outputs: 2 points  
• Normal: ON/OFF selectable  
• Contact capacity: 30V DC, 50mA  
• Output frequency: 1000P/s max. (pulse width: 5, 10, 50, 100, 200, 500, 1000ms)

##### Serial communication (option):

RS-485 (MODBUS), isolated, arrester incorporated  
Connectable quantity: 31 units  
Baud rate: 9600, 19200, 38400bps  
Parity: None/Odd/Even selectable  
Stop bits: 1 or 2 bits selectable  
Cable length: 1km max.  
Data: Flow velocity, flow rate, forward total, reverse total, status, etc.

##### Display device:

2-color LED (Normal: green, Extraordinary: red)  
LCD with 2 lines of 16 characters and back light

##### Indication language:

Japanese (Katakana)/English/French/  
German/Spanish (changeable)

##### Flow velocity/flow rate indication:

Instantaneous flow velocity, instantaneous flow rate indication (minus indication for reverse flow)  
Numerals: 8 digits (decimal point is counted as 1 digit)

Unit: Metric/Inch system selectable

	Metric system	Inch system
Velocity	m/s	ft/s
Flow rate	L/s, L/min, L/h, L/d, kL/d, ML/d, m <sup>3</sup> /s, m <sup>3</sup> /min, m <sup>3</sup> /d, km <sup>3</sup> /d, Mm <sup>3</sup> /d, BBL/s, BBL/min, BBL/h, BBL/d, kBBL/d, MBBL/d	gal/s, gal/min, gal/h, gal/d, kgal/d, Mgal/d, ft <sup>3</sup> /s, ft <sup>3</sup> /min, ft <sup>3</sup> /d, Kft <sup>3</sup> /d, Mft <sup>3</sup> /d, BBL/s, BBL/min, BBL/h, BBL/d, kBBL/d, MBBL/d

Note: The "gal" means USgal.

##### Total indication: Forward or reverse total value indication (negative indication for reverse direction)

Numerals: 8 digits (decimal point is counted as 1 digit)

Unit: Metric/Inch system selectable

	Metric system	Inch system
Total	mL, L, m <sup>3</sup> , km <sup>3</sup> , Mm <sup>3</sup> , mBBL, BBL, KBBL	gal, kgal, ft <sup>3</sup> , kft <sup>3</sup> , Mft <sup>3</sup> , mBBL, BBL, kBBL, ACRE-ft

**Configuration:** Fully configurable from the 4-key pad (ESC, △, ▽, ENT)

**Zero adjustment:** Set zero/Clear available

**Damping:** 0 to 100s (every 0.1s) for analog output and flow velocity/flow rate indication

**Low flow rate cutoff:** 0 to 5m/s in terms of flow velocity

**Alarm:** Digital output available for Hardware fault or Process fault

**Burnout:** Analog output: Hold/Overscale/Under-scale/Zero selectable  
Flow rate total: Hold/Count selectable  
Burnout timer: 10 to 900s (every 1s)

**Bi-directional range:** Forward and reverse ranges configurable independently.  
Hysteresis: 0 to 10% of working range  
Working range applicable to digital output

**Auto-2 range:** 2 forward ranges configurable independently  
Hysteresis: 0 to 10% of working range  
Working range applicable to digital output

**Flow switch:** Lower limit, upper limit configurable independently  
Digital output available for status at actuated point

**Total switch:** Forward total switching point configurable  
Digital output available when actuated

**External total preset:** Preset total settable upon contact input setting

**Backup of power failure:** backup by non-volatile memory

### Physical specifications

**Type of enclosure:**  
Flow transmitter: FSV...S: IP66  
FSV...H: IP67 (With large LCD)

**Mounting method:**  
Flow transmitter: Mounted on wall or by 2B pipe  
Detector: Clamped on pipe surface

**External terminal of flow transmitter:**  
plug terminal

### ■ PC Loader software

Provided as standard

- Compatible model is PC/AT compatible instrument.
- Operation is undefined for PC98 series (NEC).
- Main functions: Software for Main unit parameter setting/change on PC
- OS: Windows 2000/XP or Windows 7 (Home Premium, Professional)
- Memory requirement: 125MB min.
- Disk unit: CD-ROM drive compatible with Windows 2000/XP or Windows 7 (Home Premium, Professional)
- Hard disk capacity: Minimum vacant capacity of 52MB or more

Note: Optional communication board (specified at the 5<sup>th</sup> digit of code symbols).

Note: Communication converter

For the PC that supports RS-232C serial interface, RS-232C - RS-485 converter is needed for connecting the PC and main unit.

For the PC that does not support RS-232C serial interface, additionally, USB - RS232C converter is also needed.

<Recommendation>  
[RS-232C - RS-485 converter]  
RC-770X(manufactured by SYSMEX RA)

[USB - RS-232C converter]  
USB-CVRS9 (manufactured by SANWA SUPPLY)

## 7.2. OUTLINE DIAGRAM

Flow transmitter (Type: FSV□□Y□2-S)

Unit : mm

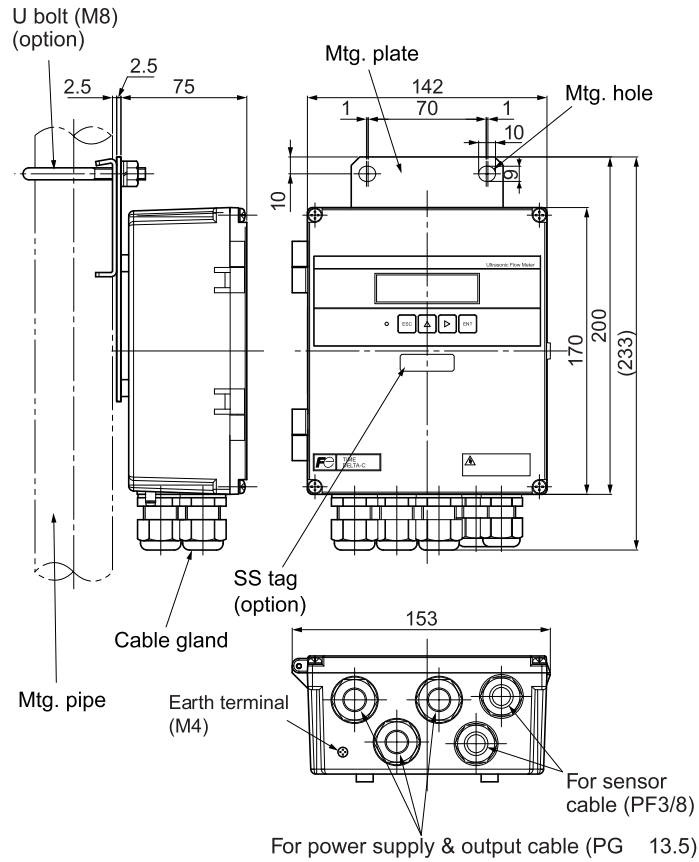

Flow transmitter (Type: FSV□□Y□2-H)

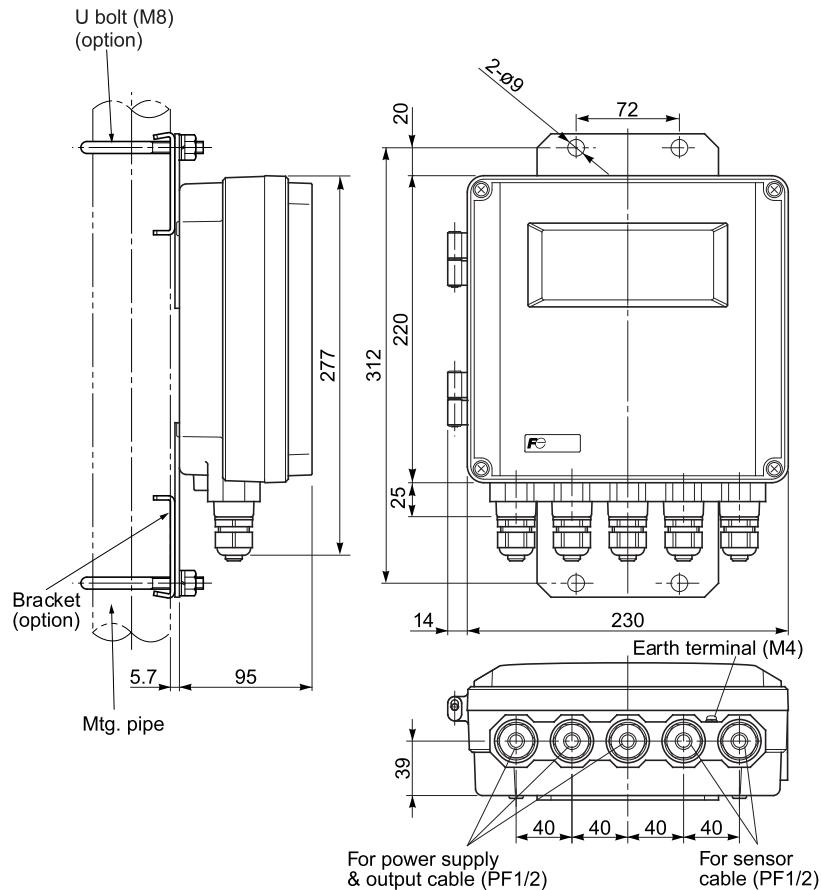

## 7.3. ORDERING INFORMATION

1. Type of detector
2. Type of flow transmitter
3. Type of signal cable
4. Tag No. (When tag plate is specified)
5. Parameter setting list (When parameter setting is specified)

Company name: \_\_\_\_\_ Branch: \_\_\_\_\_  
 Name of the contact person: \_\_\_\_\_ TEL: \_\_\_\_\_  
 Measuring fluid: \_\_\_\_\_

Parameter setting list

Setting items		Initial value	Setting value	Setting items		Initial value	Setting value
ID No		0000		Total mode		Stop	
Language		English		Pulse value		0m <sup>3</sup>	
Measurement condition	System unit	Metric		Total output	Total preset	0m <sup>3</sup>	
	Flow unit	m <sup>3</sup> /h			Pulse width	50.0msec	
	Total unit	m <sup>3</sup>			Burnout (total)	Hold	
	Outer diameter	60.00mm			Burnout timer	10sec	
	Pipe material	PVC			DO1 Output type (Note1)	Not used	
	Wall thickness	4.00mm			DO1 Output operation	Active ON	
	Lining material	No lining		DO2 Output type	Not used		
	Lining thickness	-		DO2 Output operation	Active ON		
	Kind of fluid	Water		Operation mode	Standard		
	Viscosity	1.0038×10 <sup>-6</sup> m <sup>2</sup> /s		Communication mode	RS-485		
Sensor mount	V method		Baud rate	9600bps			
Sensor type	FSSA		Parity	Odd			
Damping	5.0sec		Stop bit	1 bit			
Cut off	0.150m <sup>3</sup> /h		Station No.	1			
Output condition	Display	Content of 1st line	Velocity (m/s)				
		Decimal point position of 1st line	****.***				
		Content of 2nd line	Flow Rate (m <sup>3</sup> /h)				
		Decimal point position of 2nd line	****.***				
	Analog output	KIND	FLOW RATE				
		Range type	SINGLE				
		Full scale 1	15.000m <sup>3</sup> /h				
		Full scale 2	0.000m <sup>3</sup> /h				
		Hysteresis	10.00%				
		Burnout (current)	HOLD				
		Burnout timer	10sec				
		Output limit low	-20%				
		Output limit high	120%				
		Rate limit	0.000m <sup>3</sup> /h				
Rate limit timer	0sec						

Note 1) When total pulse output has been selected for DO1 and/or DO2 specify total pulse value and total pulse width so that conditions 1 and 2 shown below are satisfied.

Condition 1:

$$\frac{\text{Full scale} \times 1 \text{ [m}^3/\text{s]}}{\text{Pulse value [m}^3]} \leq 100[\text{Hz}]$$

Condition 2:

$$\frac{\text{Full scale} \times 1 \text{ [m}^3/\text{s]}}{\text{Pulse value [m}^3]} \leq \frac{1000}{2 \times \text{Pulse width [ms]}}$$

\*1) The range of FULL SCALE 1 or FULL SCALE 2, whichever is larger, is the object in case of automatic 2-range, forward and reverse range, forward and reverse automatic 2-range.

## 7.4. Piping data

Stainless steel pipe for pipe arrangement (JIS G3459-2012)

Nominal diameter		Outer diameter mm	Thickness						
			Schedule 5S	Schedule 10S	Schedule 20S	Schedule 40	Schedule 80	Schedule 120	Schedule 160
A	B		Thickness mm	Thickness mm	Thickness mm	Thickness mm	Thickness mm	Thickness mm	Thickness mm
15	1/2	21.7	1.65	2.1	2.5	2.8	3.7	-	4.7
20	3/4	27.2	1.65	2.1	2.5	2.9	3.9	-	5.5
25	1	34.0	1.65	2.8	3.0	3.4	4.5	-	6.4
32	1 1/4	42.7	1.65	2.8	3.0	3.6	4.9	-	6.4
40	1 1/2	48.6	1.65	2.8	3.0	3.7	5.1	-	7.1
50	2	60.5	1.65	2.8	3.5	3.9	5.5	-	8.7
65	2 1/2	76.3	2.1	3.0	3.5	5.2	7.0	-	9.5
80	3	89.1	2.1	3.0	4.0	5.5	7.6	-	11.1
90	3 1/2	101.6	2.1	3.0	4.0	5.7	8.1	-	12.7
100	4	114.3	2.1	3.0	4.0	6.0	8.6	11.1	13.5
125	5	139.8	2.8	3.4	5.0	6.6	9.5	12.7	15.9
150	6	165.2	2.8	3.4	5.0	7.1	11.0	14.3	18.2
200	8	216.3	2.8	4.0	6.5	8.2	12.7	18.2	23.0
250	10	267.4	3.4	4.0	6.5	9.3	15.1	21.4	28.6
300	12	318.5	4.0	4.5	6.5	10.3	17.4	25.4	33.3
350	14	355.6	-	-	-	11.1	19.0	27.8	35.7
400	16	406.4	-	-	-	12.7	21.4	30.9	40.5
450	18	457.2	-	-	-	14.3	23.8	34.9	45.2
500	20	508.0	-	-	-	15.1	26.2	38.1	50.0
550	22	558.8	-	-	-	15.9	28.6	41.3	54.0
600	24	609.6	-	-	-	17.5	31.0	46.0	59.5
650	26	660.4	-	-	-	18.9	34.0	49.1	64.2

Polyethylene pipe for city water (JIS K6762-2004)

Nominal diameter (mm)	Outer diameter (mm)	1st type (Soft pipe)		2nd type (Hard pipe)	
		Thickness (mm)	Weight (kg/m)	Thickness (mm)	Weight (kg/m)
13	21.5	3.5	0.184	2.5	0.143
20	27.0	4.0	0.269	3.0	0.217
25	34.0	5.0	0.423	3.5	0.322
30	42.0	5.6	0.595	4.0	0.458
40	48.0	6.5	0.788	4.5	0.590
50	60.0	8.0	1.216	5.0	0.829

Galvanized steel pipe for city water SGPW (JIS G3442-2010)

How to call pipe		Outer diameter (mm)	Thickness (mm)
(A)	(B)		
15	1/2	21.7	2.8
20	3/4	27.2	2.8
25	1	34.0	3.2
32	1 1/4	42.7	3.5
40	1 1/2	48.6	3.5
50	2	60.5	3.8
65	2 1/2	76.3	4.2
80	3	89.1	4.2
90	3 1/2	101.6	4.2
100	4	114.3	4.5
125	5	139.8	4.5
150	6	165.2	5.0
200	8	216.3	5.8
250	10	267.4	6.6
300	12	318.5	6.9
350	14	355.6	7.9
400	16	406.4	7.9
450	18	457.2	7.9
500	20	508.0	7.9

Polyethylene pipe for general use (JIS K6761-2004)

Nominal diameter	Outer diameter (mm)	1st type (Soft pipe)	2nd type (Hard pipe)
		Thickness (mm)	Thickness (mm)
13	21.5	2.7	2.4
20	27.0	3.0	2.4
25	34.0	3.0	2.6
30	42.0	3.5	2.8
40	48.0	3.5	3.0
50	60.0	4.0	3.5
65	76.0	5.0	4.0
75	89.0	5.5	5.0
100	114	6.0	5.5
125	140	6.5	6.5
150	165	7.0	7.0
200	216	-	8.0
250	267	-	9.0
300	318	-	10.0

PVC pipe for city water (JIS K6742-2007)

VP: PVC pipe

HIVP: anti-shock PVC pipe etc..

Nominal diameter	Outer diameter	Pipe thickness
13	18.0	2.5
16	22.0	3.0
20	26.0	3.0
25	32.0	3.5
30	38.0	3.5
40	48.0	4.0
50	60.0	4.5
75	89.0	5.9
100	114.0	7.1
150	165.0	9.6

PVC pipe PVC-u (JIS K6741-2007)

Type \ Nominal (mm)	VP		VU	
	Outer diameter	Thickness	Outer diameter	Thickness
13	18	2.2	-	-
16	22	2.7	-	-
20	26	2.7	-	-
25	32	3.1	-	-
30	38	3.1	-	-
40	48	3.6	48	1.8
50	60	4.1	60	1.8
65	76	4.1	76	2.2
75	89	5.5	89	2.7
100	114	6.6	114	3.1
125	140	7.0	140	4.1
150	165	8.9	165	5.1
200	216	10.3	216	6.5
250	267	12.7	267	7.8
300	318	15.1	318	9.2
350	-	-	370	10.5
400	-	-	420	11.8
450	-	-	470	13.2
500	-	-	520	14.6
600	-	-	630	17.8
700	-	-	732	21.0

IWVP : PVC pipe (ISO 4422-2)

Nominal diameter of pipe	Outer diameter	Pipe thickness
ND32	32	1.6
ND40	40	1.9
ND50	50	2.4
ND63	63	3.0
ND75	75	3.6
ND90	90	4.3
ND110	110	4.2
ND125	125	4.8
ND140	140	5.4
ND160	160	6.2

Vertical type cast iron pipe (JIS G5521)

Nominal diameter D	Pipe thickness T		Actual outer diameter D1
	Normal pressure pipe	Low pressure pipe	
75	9.0	-	93.0
100	9.0	-	118.0
150	9.5	9.0	169.0
200	10.0	9.4	220.0
250	10.8	9.8	271.6
300	11.4	10.2	322.8
350	12.0	10.6	374.0
400	12.8	11.0	425.6
450	13.4	11.5	476.8
500	14.0	12.0	528.0
600	15.4	13.0	630.8
700	16.5	13.8	733.0
800	18.0	14.8	836.0
900	19.5	15.5	939.0
1000	22.0	-	1041.0
1100	23.5	-	1144.0
1200	25.0	-	1246.0
1350	27.5	-	1400.0
1500	30.0	-	1554.0

Carbon steel pipe for pipe arrangement SGP (JIS G3452-2010)

How to call pipe		Outer diameter (mm)	Thickness (mm)
(A)	(B)		
15	1/2	21.7	2.8
20	3/4	27.2	2.8
25	1	34.0	3.2
32	1 1/4	42.7	3.5
40	1 1/2	48.6	3.5
50	2	60.5	3.8
65	2 1/2	76.3	4.2
80	3	89.1	4.2
90	3 1/2	101.6	4.2
100	4	114.3	4.5
125	5	139.8	4.5
150	6	165.2	5.0
175	7	190.7	5.3
200	8	216.3	5.8
225	9	241.8	6.2
250	10	267.4	6.6
300	12	318.5	6.9
350	14	355.6	7.9
400	16	406.4	7.9
450	18	457.2	7.9
500	20	508.0	7.9

Coated steel pipe for city water STW (JIS G3443-1 2007)

Nominal diameter (A)	Outer diameter (mm)	Symbol for type			
		STW 290	STW 370	STW 400	
				Nominal thickness	
		Thickness (mm)	Thickness (mm)	A	B
80	89.1	4.2	4.5	-	-
100	114.3	4.5	4.9	-	-
125	139.8	4.5	5.1	-	-
150	165.2	5.0	5.5	-	-
200	216.3	5.8	6.4	-	-
250	267.4	6.6	6.4	-	-
300	318.5	6.9	6.4	-	-
350	355.6	-	-	6.0	-
400	406.4	-	-	6.0	-
450	457.2	-	-	6.0	-
500	508.0	-	-	6.0	-
600	609.6	-	-	6.0	-
700	711.2	-	-	7.0	6.0
800	812.8	-	-	8.0	7.0
900	914.4	-	-	8.0	7.0
1000	1016.0	-	-	9.0	8.0
1100	1117.6	-	-	10.0	8.0
1200	1219.2	-	-	11.0	9.0
1350	1371.6	-	-	12.0	10.0
1500	1524.0	-	-	14.0	11.0
1600	1625.6	-	-	15.0	12.0
1650	1676.4	-	-	15.0	12.0
1800	1828.8	-	-	16.0	13.0
1900	1930.4	-	-	17.0	14.0
2000	2032.0	-	-	18.0	15.0
2100	2133.6	-	-	19.0	16.0
2200	2235.2	-	-	20.0	16.0
2300	2336.8	-	-	21.0	17.0
2400	2438.4	-	-	22.0	18.0
2500	2540.0	-	-	23.0	18.0
2600	2641.6	-	-	24.0	19.0
2700	2743.2	-	-	25.0	20.0
2800	2844.8	-	-	26.0	21.0
2900	2946.4	-	-	27.0	21.0
3000	3048.0	-	-	29.0	22.0

Centrifugal nodular graphite cast iron pipe for city water (A type) (JWWA G-105 1971)

Nominal diameter	Pipe thickness			Actual outer diameter
	T			
D	1st type pipe	2nd type pipe	3rd type pipe	D <sub>1</sub>
75	7.5	-	6.0	93.0
100	7.5	-	6.0	118.0
150	7.5	-	6.0	169.0
200	7.5	-	6.0	220.0
250	7.5	-	6.0	271.6
300	7.5	-	6.5	332.8
350	7.5	-	6.5	374.0
400	8.5	7.5	7.0	425.6
450	9.0	8.0	7.5	476.8
500	9.5	8.5	7.0	528.0

Centrifugal nodular graphite cast iron pipe for city water (K type) (JWWA G-105 1971)

Nominal diameter	Pipe thickness			Actual outer diameter
	1st type pipe	2nd type pipe	3rd type pipe	
D	1st type pipe	2nd type pipe	3rd type pipe	D <sub>1</sub>
400	8.5	7.5	7.0	425.6
450	9.0	8.0	7.5	476.8
500	9.5	8.5	8.0	528.0
600	11.0	10.0	9.0	630.8
700	12.0	11.0	10.0	733.0
800	13.5	12.0	11.0	836.0
900	15.0	13.0	12.0	939.0
1000	16.5	14.5	13.0	1041.0
1100	18.0	15.5	14.0	1144.0
1200	19.5	17.0	15.0	1246.0
1350	21.5	18.5	16.5	1400.0
1500	23.5	20.5	18.0	1554.0



Arc welded large-diameter stainless steel pipe for pipe arrangement SUS (JIS G3468-2011)

Nominal diameter		Outer diameter (mm)	Nominal thickness			
			Schedule 5S	Schedule 10S	Schedule 20S	Schedule 40S
A	B		Thickness mm	Thickness mm	Thickness mm	Thickness mm
150	6	165.2	2.8	3.4	5.0	7.1
200	8	216.3	2.8	4.0	6.5	8.2
250	10	267.4	3.4	4.0	6.5	9.3
300	12	318.5	4.0	4.5	6.5	10.3
350	14	355.6	4.0	5.0	8.0	11.1
400	16	406.4	4.5	5.0	8.0	12.7
450	18	457.2	4.5	5.0	8.0	14.3
500	20	508.0	5.0	5.5	9.5	15.1
550	22	558.8	5.0	5.5	9.5	15.9
600	24	609.6	5.5	6.5	9.5	17.5
650	26	660.4	5.5	8.0	12.7	-
700	28	711.2	5.5	8.0	12.7	-
750	30	762.0	6.5	8.0	12.7	-
800	32	812.8	-	8.0	12.7	-
850	34	863.6	-	8.0	12.7	-
900	36	914.4	-	8.0	12.7	-
1000	40	1016.0	-	9.5	14.3	-

Ductile iron specials (JIS G5527-1998)

Nominal diameter (mm)	Pipe thickness (mm)
75	8.5
100	8.5
150	9.0
200	11.0
250	12.0
300	12.5
350	13.0
400	14.0
450	14.5
500	15.0
600	16.0
700	17.0
800	18.0
900	19.0
1000	20.0
1100	21.0
1200	22.0
1350	24.0
1500	26.0
1600	27.5
1650	28.0
1800	30.0
2000	32.0
2100	33.0
2200	34.0
2400	36.0

Dimensions of centrifugal sand mold cast iron pipe (JIS G5522). For reference, following items are discontinued.

Nominal diameter D	Pipe thickness (T)			Actual outer diameter D <sub>1</sub>
	High pressure pipe	Normal pressure pipe	Low pressure pipe	
75	9.0	7.5	-	93.0
100	9.0	7.5	-	118.0
125	9.0	7.8	-	143.0
150	9.5	8.0	7.5	169.0
200	10.0	8.8	8.0	220.0
250	10.8	9.5	8.4	271.6
300	11.4	10.0	9.0	322.8
350	12.0	10.8	9.4	374.0
400	12.8	11.5	10.0	425.6
450	13.4	12.0	10.4	476.8
500	14.0	12.8	11.0	528.0
600	-	14.2	11.8	630.8
700	-	15.5	12.8	733.0
800	-	16.8	13.8	836.0
900	-	18.2	14.8	939.0

Dimensions of centrifugal sand mold cast iron pipe (JIS G5523 1977). For reference, following items are discontinued.

Nominal diameter (mm)	Pipe thickness (T)		Actual outer diameter D <sub>1</sub>
	High pressure pipe	Normal pressure pipe	
75	9.0	7.5	93.0
100	9.0	7.5	118.0
125	9.0	7.8	143.0
150	9.5	8.0	169.0
200	10.0	8.8	220.0
250	10.8	9.5	271.6
300	11.4	10.0	322.8

Cast iron pipe for waste water FC150 (JIS G5525:2000)

Nominal diameter	Mechanical type								Insertion type	
	1st type pipe				2nd type pipe				RJ pipe	
	Straight pipe		Deformed pipe		Straight pipe		Deformed pipe		Straight/deformed pipe	
	Outer diameter	Pipe thickness	Outer diameter	Pipe thickness	Outer diameter	Pipe thickness	Outer diameter	Pipe thickness	Outer diameter	Pipe thickness
50	58	4	60	5	—	—	58	4	—	—
75	83	4	85	5	83	4	83	4	89	4.5
100	108	4	110	5	108	4	108	4	114	4.5
125	134	4.5	136	5.5	134	4.5	134	4.5	140	4.5
150	159	4.5	161	5.5	—	—	—	—	—	—
200	211	5.5	213	6.5	—	—	—	—	—	—

Arc welded carbon steel pipe STPY 400 (JIS G3457-2012)

Unit: kg/m

Nominal diameter		Thickness (mm)	Unit: kg/m													
(A)	(B)		Outer diameter (mm)	6.0	6.4	7.1	7.9	8.7	9.5	10.3	11.1	11.9	12.7	13.1	15.1	15.9
350	14	355.6	51.7	55.1	61.0	67.7										
400	16	406.4	59.2	63.1	69.9	77.6										
450	18	457.2	66.8	71.1	78.8	87.5										
500	20	508.0	74.3	79.2	87.7	97.4	107	117								
550	22	558.8	81.8	87.2	96.6	107	118	129	139	150	160	171				
600	24	609.6	89.3	95.2	105	117	129	141	152	164	175	187				
650	26	660.4	96.8	103	114	127	140	152	165	178	190	203				
700	28	711.2	104	111	123	137	151	164	178	192	205	219				
750	30	762.0		119	132	147	162	176	191	206	220	235				
800	32	812.8		127	141	157	173	188	204	219	235	251	258	297	312	
850	34	863.6				167	183	200	217	233	250	266	275	316	332	
900	36	914.4				177	194	212	230	247	265	282	291	335	352	
1000	40	1016.0				196	216	236	255	275	295	314	324	373	392	
1100	44	1117.6						260	281	303	324	346	357	411	432	
1200	48	1219.2						283	307	331	354	378	390	448	472	
1350	54	1371.6									399	426	439	505	532	
1500	60	1524.0									444	473	488	562	591	
1600	64	1625.6											521	600	631	
1800	72	1828.8											587	675	711	
2000	80	2032.0												751	791	

Stainless steel sanitary pipe SUS (JIS G3447-2009)

	Outer diameter (mm)	Thickness (mm)	Internal diameter (mm)
	25.4	1.2	23.0
	31.8	1.2	29.4
	38.1	1.2	35.7
	50.8	1.5	47.8
	63.5	2.0	59.5
	76.3	2.0	72.3
	89.1	2.0	85.1
	101.6	2.0	97.6
	114.3	3.0	108.3
	139.8	3.0	133.8
	165.2	3.0	159.2

PVDF-HP

	SDR33 S16 PN10	SDR21 S10 PN16	SDR17 S8 PN20
Outer diameter (mm)	Thickness (mm)	Thickness (mm)	Thickness (mm)
16		1.5	1.5
20		1.9	1.9
25		1.9	1.9
32		2.4	2.4
40		2.4	2.4
50		3.0	3.0
63	2.5	3.0	
75	2.5	3.6	
90	2.8	4.3	
110	3.4	5.3	
125	3.9	6.0	
140	4.3	6.7	
160	4.9	7.7	
180	5.5	8.6	
200	6.2	9.6	
225	6.9	10.8	
250	7.7	11.9	
280	8.6	13.4	
315	9.7	15.0	
355	10.8		
400	12.2		
450	13.7		

Heat-resistant hard vinyl chloride pipe PVC-C  
(JIS K6776:2007)

Nominal diameter	Outer diameter (mm)	Thickness (mm)	Weight (kg/m)
13	18.0	2.5	0.180
16	22.0	3.0	0.265
20	26.0	3.0	0.321
25	32.0	3.5	0.464
30	38.0	3.5	0.561
40	48.0	4.0	0.818
50	60.0	4.5	1.161

Polyethylene pipe for city water service

(Japan Polyethylene Pipes Association for Water Service standard PTC K 03:2006)

Nominal diameter	Outer diameter (mm)	Thickness (mm)	Inner diameter (mm)	Weight (kg/m)
50	63.0	5.8	50.7	1.074
75	90.0	8.2	72.6	2.174
100	125.0	11.4	100.8	4.196
150	180.0	16.4	145.3	8.671
200	250.0	22.7	201.9	16.688

(a) Velocity of sound subject to change f temperature of water (0 to 100°C)

T °C	V m/s	T °C	V m/s	T °C	V m/s	T °C	V m/s
0	1402.74						
1	1407.71	26	1499.64	51	1543.93	76	1555.40
2	1412.57	27	1502.20	52	1544.95	77	1555.31
3	1417.32	28	1504.68	53	1545.92	78	1555.18
4	1421.98	29	1507.10	54	1546.83	79	1555.02
5	1426.50	30	1509.44	55	1547.70	80	1554.81
6	1430.92	31	1511.71	56	1548.51	81	1554.57
7	1435.24	32	1513.91	57	1549.28	82	1554.30
8	1439.46	33	1516.05	58	1550.00	83	1553.98
9	1443.58	34	1518.12	59	1550.68	84	1553.63
10	1447.59	35	1520.12	60	1551.30	85	1553.25
11	1451.51	36	1522.06	61	1551.88	86	1552.82
12	1455.34	37	1523.93	62	1552.42	87	1552.37
13	1459.07	38	1525.74	63	1552.91	88	1551.88
14	1462.70	39	1527.49	64	1553.35	89	1551.35
15	1466.25	40	1529.18	65	1553.76	90	1550.79
16	1469.70	41	1530.80	66	1554.11	91	1550.20
17	1473.07	42	1532.37	67	1554.43	92	1549.58
18	1476.35	43	1533.88	68	1554.70	93	1548.92
19	1479.55	44	1535.33	69	1554.93	94	1548.23
20	1482.66	45	1536.72	70	1555.12	95	1547.50
21	1485.69	46	1538.06	71	1555.27	96	1546.75
22	1488.63	47	1539.34	72	1555.37	97	1545.96
23	1491.50	48	1540.57	73	1555.44	98	1545.14
24	1494.29	49	1541.74	74	1555.47	99	1544.29
25	1497.00	50	1542.87	75	1555.45	100	1543.41

Note) T: Temperature, V: Velocity

(b) Sound velocity and density of various liquids

Name of liquid	T °C	$\rho$ g/cm <sup>3</sup>	V m/s
Acetone	20	0.7905	1190
Aniline	20	1.0216	1659
Alcohol	20	0.7893	1168
Ether	20	0.7135	1006
Ethylene glycol	20	1.1131	1666
n-octane	20	0.7021	1192
o-xylol	20	0.871	1360
Chloroform	20	1.4870	1001
Chlorobenzene	20	1.1042	1289
Glycerin	20	1.2613	1923
Acetic acid	20	1.0495	1159
Methyl acetate	20	0.928	1181
Ethyl acetate	20	0.900	1164
Cyclohexane	20	0.779	1284
Dioxane	20	1.033	1389
Heavy water	20	1.1053	1388
Carbon tetrachloride	20	1.5942	938
Mercury	20	13.5955	1451
Nitrobenzene	20	1.207	1473
Carbon bisulfide	20	1.2634	1158
Chloroform	20	2.8904	931
n-propyl alcohol	20	0.8045	1225
n-pentane	20	0.6260	1032
n-hexane	20	0.654	1083
Light oil	25	0.81	1324
Transformer oil	32.5	0.859	1425
Spindle oil	32	0.905	1342
Petroleum	34	0.825	1295
Gasoline	34	0.803	1250
Water	13.5	1.	1460
Sea water (salinity: 3.5%)	16	1.	1510

Note) T: Temperature,  $\rho$ : Density, V: Velocity

(c) Sound velocity of pipe material

Material	V m/s
Steel	3000
Ductile cast iron	3000
Cast iron	2604
Stainless steel	3141
Copper	2260
Lead	2170
Aluminium	3080
Brass	2050
PVC	2307
Acrylic	2644
FRP	2505
Mortar	3000
Tar epoxy	2505
Polyethylene	1900
Teflon	1240
Rubber	1510
Pyrex glass	3280

Note) V: Velocity

(d) Kinematic viscosity coefficient of various liquids

Name of liquid	T °C	$\rho$ g/cm <sup>3</sup>	V m/s	$v$ ( $\times 10^{-6}$ m <sup>2</sup> /s)
Acetone	20	0.7905	1190	0.407
Aniline	20	1.0216	1659	1.762
Ether	20	0.7135	1006	0.336
Ethylene glycol	20	1.1131	1666	21.112
Chloroform	20	1.4870	1001	0.383
Glycerin	20	1.2613	1923	11.885
Acetic acid	20	1.0495	1159	1.162
Methyl acetate	20	0.928	1181	0.411
Ethyl acetate	20	0.900	1164	0.499
Heavy water	20	1.1053	1388	1.129
Carbon tetrachloride	20	1.5942	938	0.608
Mercury	20	13.5955	1451	0.114
Nitrobenzene	20	1.207	1473	1.665
Carbon bisulfide	20	1.2634	1158	0.290
n-pentane	20	0.6260	1032	0.366
n-hexane	20	0.654	1083	0.489
Spindle oil	32	0.905	1324	15.7
Gasoline	34	0.803	1250	0.4 to 0.5
Water	13.5	1.	1460	1.004 (20°C)

Note) T: Temperature,  $\rho$ : Density, V: Velocity, v: Kinematic viscosity coefficient

---

** Fuji Electric Co., Ltd.**

**International Sales Div  
Sales Group**

Gate City Ohsaki, East Tower, 11-2, Osaki 1-chome,  
Shinagawa-ku, Tokyo 141-0032, Japan  
<http://www.fujielectric.com>  
Phone: 81-3-5435-7280, 7281 Fax: 81-3-5435-7425  
<http://www.fujielectric.com/products/instruments/>

---