



Instruction Manual

PORTABLE TYPE ULTRASONIC FLOWMETER (PORTAFLOW C)

TYPE:

FLOW TRANSMITTER FSC-2

DETECTOR FSS-1, FSD-1

PREFACE

You are now a proud owner of Fuji's ultrasonic flowmeter (Portaflow C).

This manual explains cautions in use, wiring, operation, installation, troubleshooting and maintenance, and options of the portable type ultrasonic flowmeter (Portaflow C). Please read through the manual before using the instrument.

Keep this manual available for reference by appropriate operation and maintenance personnel.

Option

The following options are available.

- Flow velocity profile measurement

Manufacturer : Fuji Electric Co., Ltd.
Type : Described in nameplate on main frame
Date of manufacture : Described in nameplate on main frame
Product nationality : Japan

Note) Windows 2000/XP/Vista/7, Excel, Bitmap are registered trade marks of Microsoft Corporation.
SD logo is a registered trademark.

Notice

- It is prohibited to transfer a part or the whole of contents of the manual without permission.
- Contents of the manual are subject to change without prior notice.

© Fuji Electric Co., Ltd. 2013

Issued in Mar., 2013

CONTENTS

1. OVERVIEW.....	1
2. CHECK OF DELIVERED ITEMS.....	2
2.1 On purchase of flow transmitter (type: FSC).....	2
2.2 On purchase of transit time detector (type: FSS).....	3
2.3 On purchase of flow velocity distribution measurement detector (type: FSD).....	4
3. CHECK MODEL AND SPECIFICATION.....	5
4. NAME AND EXPLANATION OF EACH PART.....	8
4.1 Name and explanation of main unit and detector.....	8
4.2 Explanation of keys.....	10
4.3 Handling of SD memory card.....	11
4.3.1 Precautions for handling of SD memory card.....	11
4.3.2 Formatting forms.....	11
4.3.3 Insertion and removal.....	12
4.3.4 Data recording to SD memory card.....	13
5. CHARGE METHOD AND OPERATION POWER SOPPLY.....	16
5.1 Operating power supply.....	16
5.2 Turning on the power and language preference.....	18
5.3 Power OFF.....	19
6. WIRING.....	20
6.1 Diagram.....	20
6.2 Connection of dedicated cables.....	20
6.3 Connection of analog input/output cable(4 to 20 mA DC).....	21
6.4 Connection of USB cable.....	21
7. INPUT OF PIPING SPECIFICATIONS.....	22
7.1 Display of pipe setup screen.....	22
7.2 Entry of site name (not required measurement).....	25
7.3 Outer diameter of piping (unit: mm).....	28
7.4 Piping material.....	29
7.5 Wall thickness (unit: mm) (range: 0.1 to 100.00mm).....	30
7.6 Lining material.....	31
7.7 Lining thickness (unit: mm) (range: 0.01 to 100.00 mm).....	32
7.8 Kind of fluid.....	33
7.9 Viscosity.....	34
7.10 Selection of sensor mounting method.....	35
7.11 Kind of sensor.....	36
7.12 Transmission voltage (used when an indicator is 1 or less during measurement).....	37
7.13 Completion of PROCESS SETTING.....	38
8. MOUNTING OF DETECTOR.....	39
8.1 Selection of mounting location.....	39
8.2 Selection of detector.....	42

8.3	Use of surface-treated accessories.....	44
8.4	How to mount FSSC to pipe.....	45
8.4.1	How to mount a detector (V method).....	45
8.4.2	How to mount a detector (Z method).....	48
8.4.3	Method of mounting bely.....	50
8.5	How to mount FSSD to pipe.....	53
8.5.1	How to mount a detector (Z method).....	53
8.5.2	How to mount a type (V method).....	54
8.6	How to attach the medium size detector.....	56
8.7	How to attach the type FSSE.....	57
8.7.1	How to connect the signal cable.....	57
8.7.2	How to mount large size sensor to pipe.....	58
8.8	How to mount FSSH to pipe.....	60
8.8.1	How to mount a sensor (V method).....	60
8.8.2	How to mount a sensor (Z method).....	61
8.9	How to fold gage paper (used for determining mounting position).....	63
9.	START MEASURING.....	64
10.	SETTING OPERATION (APPLICATION).....	69
10.1	How to use SITE SETUP function (SITE SETUP page).....	70
10.1.1	SITE MEMORY: when registering data which are set and calibrated on the page.....	70
10.1.2	ZERO ADJUSTMENT: when performing zero adjustment.....	72
10.1.3	UNIT OF OUTPUT: when changing unit of each output.....	73
10.1.4	OUTPUT CONTROL: when controlling measured value (output control function).....	75
10.1.5	TOTALIZER: when performing the total process of measured data (totalize).....	79
10.2	Setting of data logger function.....	82
10.2.1	“Logger Operation” mode.....	83
10.2.2	Logger data file format.....	85
10.2.3	LOGGING: when logging (recording) measured data.....	86
10.2.4	“LOGGER DATA”: when checking or printing logged data.....	89
10.3	Setting of system (SYSTEM SETUP screen).....	94
10.3.1	BASIC SETUP: when setting the system.....	94
10.3.2	“ANALOG INPUT/OUTPUT”: when performing analog input/output and calibration.....	101
10.3.3	“ENERGY MODE”: when measuring consumed heat quantity.....	109
10.4	Setting of range (setting screen for input/output range).....	112
10.4.1	Setting the input range: When setting the range for the input current or input voltage. Setting range: 0.000 to ±9999999999.....	112
10.4.2	Setting the output range.....	114
10.5	Use of printer function (PRINTER screen).....	118
10.5.1	Selection of printing mode.....	118
10.5.2	Example of printing.....	119
10.5.3	PRINT OF TEXT.....	120
10.5.4	PRINTING OF GRAPH.....	121
10.5.5	LIST PRINT-OUT.....	122
10.5.6	STATUS DISPLAY.....	122

10.6 Maintenance function (MAINTENANCE screen).....	123
10.6.1 Checking receiving status for transit time.....	123
10.6.2 Check for analog input/output.....	128
10.6.3 SD memory card.....	130
10.6.4 LCD check.....	133
10.6.5 Software.....	134
10.7 Flow velocity distribution display function (optional).....	136
10.7.1 Installing Detector.....	136
10.7.2 Operation.....	141
10.8 Contents of errors in status display.....	146
10.8.1 How to check status display.....	146
10.8.2 Action on error.....	147
11. MAINTENANCE AND CHECKUP.....	150
12. ERROR AND REMEDY.....	152
12.1 Error in LCD Display.....	152
12.2 Error of key.....	152
12.3 Error in measured value.....	153
12.4 Error in analog output.....	156
13. EXTERNAL COMMUNICATION SPECIFICATION.....	157
14. HOW TO USE PRINTER.....	158
14.1 How to connect printer.....	158
14.2 How to load printer roll sheet.....	160
15. REPLACEMENT OF BUILT-IN BATTERY.....	161
16. APPENDIX.....	162
16.1 Piping data.....	162
16.2 Command tree.....	169
16.3 Specifications.....	171
16.4 Q & A.....	176
16.5 File contents of SD memory card.....	181
16.5.1 Types of measured data to be logged.....	181
16.5.2 Measured data file.....	182
16.5.3 Flow velocity profile data file.....	184
16.5.4 Regarding RAS.....	184







WARNING SYMBOLS AND THEIR MEANINGS

Be sure to observe the following precautions. They offer important information on safety.

- The degree of injuries or damages resulting from improper handling of this device is indicated by different symbols.

	CAUTION	Improper handling of this device may cause dangerous situations that result in personal injury or property damage.
---	----------------	--

- The following symbols describe items to be observed.

	The symbol indicates "prohibition".		Do not modify this device.
	The symbol indicates "mandatory" action to be taken.		Be sure to pull out the plug.
	The symbol provokes "cautions".		Be careful. It may result in fire.

SAFETY PRECAUTIONS

Be sure to read this "Safety Precautions" carefully beforehand for the correct and safe use of this device.



Do not touch the switch with a wet hand.



Prohibition

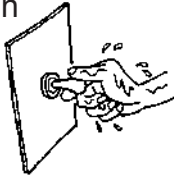

Do not touch the switch with a wet hand. Otherwise it may result in electric shock.

Do not break or pull the power cord.



Prohibition



Do not put heavy items on the power cord. Do not modify or pull the power cord. Otherwise it may break and result in electric shock and fire.

Do not disassemble.



Disassemble is prohibited.

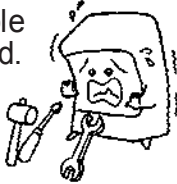

Do not disassemble this device. Otherwise it may result in an accident.

Do not use electric parts soaked in water



Prohibition

Replace electric parts or wires soaked in water due to floods or some other reasons with new ones. Otherwise it may result in electric shock or fire.

Do not repair.



Do not use the flammable gases or volatile agents such as paint thinner near the device. Otherwise it may result in explosion or fire.

Pull out the plug immediately in case of an emergency



Pull out the plug



In case of abnormal odor, smoke or fire is perceived, pull the power plug immediately.

Ask an authorized serviceperson or your dealer for repair. Otherwise it may result in electric shock or fire.



CAUTION

Keep warning labels clean.



Clean or replace the warning labels so that they can always be read correctly. Otherwise it may result in an accident.

Inspect the power plug periodically.



Inspect the power plug once every 6 months. Wipe the dust off the plug and insert it securely. Otherwise it may result in electric shock or fire.

Ask an authorized waste disposal specialist for disposal.



Do not dispose the device without proper authorization. Otherwise it may cause environmental pollution or result in an accident.

Match power capacity with the device ratings.



Fire hazard

Be sure to connect the device to the power source of proper voltage and current rating. Otherwise it may result in fire.

Do not splash water.



Prohibition

Do not wash or splash water on the electrical parts inside the device. Otherwise it may result in electric shock.

Use an exclusive power adapter and built-in battery.



Prohibition

Do not use a power adapter or built-in Lithium ion battery that is not exclusive to the main unit. Otherwise it may break and cause failure.

- Ambient temperature:
Charge time; 0 to +40°C
In use; -20 to +60°C
Storage time; -20 to +50°C

Be careful when carrying the device.



When carrying the device, exercise care to avoid physical shock or vibration. Otherwise it may cause failure.

Use the device in favorable environment.



Do not use the device in an environment subjected to dust or corrosive gases. Otherwise it may cause failure.

Flow transmitter

- Ambient temperature:
-10 to +55°C (Without printer)
-10 to +45°C (Witt printer)
- Ambient humidity: 90% RH or less

Detector:

- Ambient temperature: -20 to +60°C
- Ambient humidity:
Large/middle size detector; 100% RH or less
Others; 90% RH or less

For connecting the cable, turn the power off.



Prohibition

For connecting cable to terminal of the large size detector (Type: FSSE), turn the power off.



CAUTION

Cause of machine malfunction.



Prohibition

Use in a place which is remote from electrical devices (motor, transformer, etc.) which generate electromagnetic induction noise, electrostatic noise, etc.

Cause of machine malfunction.



Prohibition

Do not use in a place which is near cell phones, wireless devices, etc., which may cause the machine blunder.

Fire or damage may result.



Except the main unit (printer, power adapters, etc.), it is not protected for dust or waterproof.

Avoid using the product in a place where it will be exposed to water or humidity.

1. OVERVIEW

This PORTAFLOW-C is a portable type ultrasonic flowmeter that allows easy measurement of flow rates in pipes by installing a sensors on the outside of pipes.

A combination of the latest electronics and digital signal processing technologies enables the instrument to provide a compact and convenient solution to accurately measure system flow rates without breaking or opening the serial transmission and removable memory card functionality allow easy data acquisition and analysis.

2. CHECK OF DELIVERED ITEMS

2.1 On purchase of flow transmitter (type: FSC)

Conversion unit	Without printer (FSC□1)	Carrying case	
	With printer (FSC□2)		Strap
AC power supply adapter Power connector conversion cord		Signal cable (5m×2 pcs)	
Power cord		CD-ROM Instruction manual (INF-TN2FSC-E) Loader Instruction manual (INF-TN5A1784-E)	
Analog input/output cord (1.5m)		Roll paper (When "2" is selected for the 5th digit.)	
USB cable (1m)		SD memory card (256MB) (When "1" is selected for the 9th digit.)	

2.2 On purchase of transit time detector (type: FSS)

Be sure to check whether following parts are obtained or not after opening the package.

Note that delivered items vary depending on the type.

<Detector> 4th digit of code symbol

FSSC: Rail1 set
Sensor unit2 pieces
Rail-end as standard2 pieces
FSSD: Flame1 set
Sensor unit2 pieces
FSSE: Sensor unit2 pieces
Detector mounting set1 set
FSSH: Rail1 piece
Sensor unit2 pieces

<Mounting belt> 6th digit of code symbol FSS**□

A: Stainless steel belt2 pieces
B: Velcro band (3m)1 piece
C: SUS belt fasten with screw4 pieces
D: Wire rope (5m x 2pieces, Mounting spring x 2pieces)2sets
E: Wire rope (20m x 2pieces, Mounting spring x 2pieces)2sets

<Acoustic coupler> 7th digit of code symbol FSS***□

B: Silicone-free grease1 piece
C: Silicone grease1 piece
D: Silicone grease for high temperature1 piece

* Silicone rubber: Attached to FSSE For terminal area molds.

Detector

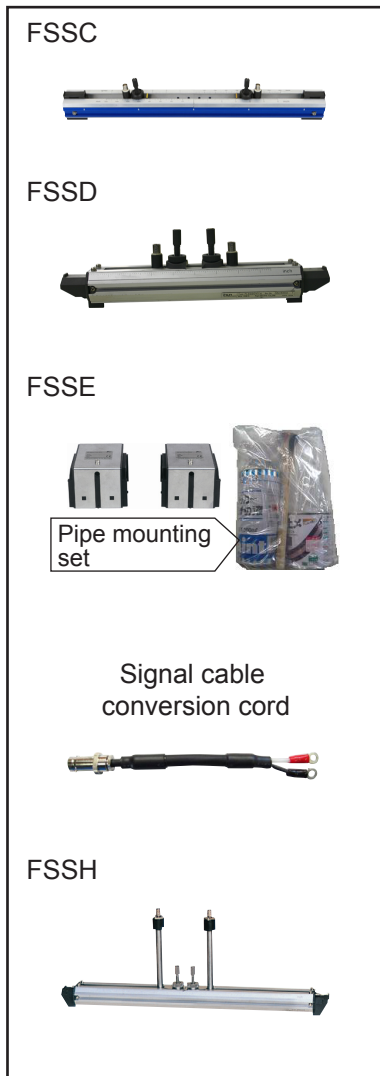

Mounting belt



Acoustic coupler



2.3 On purchase of flow velocity distribution measurement detector (type: FSD)

The following parts are included.

(1) Main unit







Small type (Type: FSDP2)
Middle type (Type: FSDP1)



Large type (Type: FSDP0)

(2) Accessories

Kind of detector	Small type	Medium type	Large type	Quantity	Remarks
• Plastic cloth belt 	○	○	—	1 pc	
• Fastening springs 	—	—	○	2 pcs	
• φ 2mm wire rope 	—	—	○	2 pcs	
• Silicone grease 	○	○	○	1 pc	Mfg: Shinetsu Chemical Industry Type: G40M (100g)

3. CHECK MODEL AND SPECIFICATION

The specification plates attached to the frame of flow transmitter and the detector list the type and specifications of the product.

Check that they represent the type ordered, referring to the following code symbols.

<Flow transmitter: FSC>

1	2	3	4	5	6	7	8	9	10	11	Description
F	S	C					2	-		0	<Specification> Standard
	S										<Converter> Basic system Basic system + Printer
											<Flow velocity profile measurement> None Provided (detector to measure flow velocity profile is separately required.)
											<Power adapter> AC power + power cord (125V AC) for Japanese and North American use AC power + power cord (250V AC) for European and Korean use AC power + power cord (250V AC) for Chinese use
										2	Modification No.
											<SD memory card> None Provided (256MB)
											<Bound instruction manual/Language> None (Factory-set language: English) Provided/Japanese (Factory-set language: Japanese) Provided/English (Factory-set language: English) Provided/Chinese (Factory-set language: Chinese) (Note1) Instruction manual contained in CD is the standard attached article. (Note2) You can change the language by key operation.



<Transit time Detector>

1	2	3	4	5	6	7	8	9	10	Description
F	S	S	C	1				1		<Sensor type> (4th digits) ø50 to ø1200mm
			C							<Guide rail> (5th digits) Provided (Extendable rail type)
			1							<Mounting belt> (6th digits) *2 None Stainless belt (1.5m×2) Plastic cloth belt (3.0m×1) SS belt fasten with screws (1.0m×4) Wire ≤ ø1500mm
			Y							<Acoustic coupler> (7th digit) None Silicon rubber (KE348) Silicone-free grease (HIGH-Z) Silicone grease (G40M)
			A							
			B							
			C							
			D							
			Y							<Water-proof treatment> (9th digit) None Provided (with signal cable 10m)
			B							
			Y							<Tag plate> (10th digit) None Provided
			A							

*2) Please refer to the table 8 to select the mounting belt at 6th digits.



1	2	3	4	5	6	7	8	9	10	Description
F	S	S	D	1				1		<Sensor type> (4th digits) ø13 to ø100mm
			D							<Guide rail> (5th digits) Provided
			1							<Mounting belt> (6th digits) None Stainless belt (1.5m × 2) Plastic cloth belt (3.0m×1) SS belt fasten with screws (1.0m × 4)
			Y							<Acoustic coupler> (7th digit) None Silicon rubber (KE348) Silicone-free grease (HIGH-Z) Silicone grease (G40M)
			A							
			B							
			C							
			Y							<Water-proof treatment> (9th digit) None
			A							<Tag plate> (10th digit) None Provided

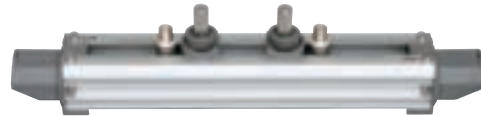

FE	Type. _____	Ser.No. _____
	Mfd. Fuji Electric Co., Ltd.	CE Made in Japan

1	2	3	4	5	6	7	8	9	10	Description
F	S	S	E	1				1		<Sensor type> (4th digits) ø200 to ø6000mm
			E							<Guide rail> (5th digits) Provided
			1							<Mounting belt> (6th digits) None Wire ≤ ø1500mm Wire ≤ ø6000mm
			Y							<Acoustic coupler> (7th digit) None Silicone-free grease (HIGH-Z) Silicone grease (G40M)
			D							
			E							
			Y							<Water-proof treatment> (9th digit) None Provided (with signal cable 10m)
			B							
			Y							<Tag plate> (10th digit) None Provided
			A							



Ultrasonic Flow Meter	FE
Type _____	
Ser.No. _____	
Mfd. _____	CE
Fuji Electric Co., Ltd.	Made in Japan

1	2	3	4	5	6	7	8	9	10	Description
F	S	S	H	1				1		<Sensor type> (4th digits) ø50 to ø400mm (-40 to 200°C)
			H							<Guide rail> (5th digits) Provided
			1							<Mounting belt> (6th digits) None Stainless belt (1.5m × 2) SS belt fasten with screws (1.0m × 4)
			Y							<Acoustic coupler> (7th digit) None High-temperature grease (KS62M)
			A							
			C							
			Y							<Water-proof treatment> (9th digit) None
			D							<Tag plate> (10th digit) None Provided
			A							



FE	Type. _____	Ser.No. _____
	Mfd. Fuji Electric Co., Ltd.	CE Made in Japan

<Flow velocity detector: FSDP>

1 2 3 4 5 6 7 8								
F	S	D			0	Y	1	Description
					P 2			
					P 1			Middle type (φ100 to φ400mm)
					P 0			Large type (φ200 to φ1000mm)
					0			<Application> None
					Y			<Structure> General use
					1			Modification No.



Small type (Type: FSDP2)
Middle type (Type: FSDP1)



Large type (Type: FSDP0)

4. NAME AND EXPLANATION OF EACH PART

4.1 Name and explanation of main unit and detector



- **Keyboard** : Used for turning on/off power supply of the main unit, controlling the printer, inputting fluid specifications and setting the function of Portaflow.
- **Display window** : Displays measured value. Also used for display during programming and data input.
Because this is a large-size graphic LCD, indications are easy to read. Even at a dark place, indications can be read by using the backlight.
- **Printer (option)** : Capable of printing all information of the Portaflow including print of display screen capture and printout of measured value.
Portaflow includes a logger function (for storing measured values in memory). After storing a few day's data in memory by the logger function, it may be printed.
Note) Chinese language selection will print Japanese.
- **Detector** : Attached to a pipe and receives/transmits ultrasonic waves.
- **Signal cable** : Used for transmitting and receiving signals between transmitter and detectors for flow measurement.
- **Rubber** : Protects the main unit from drop impact etc.

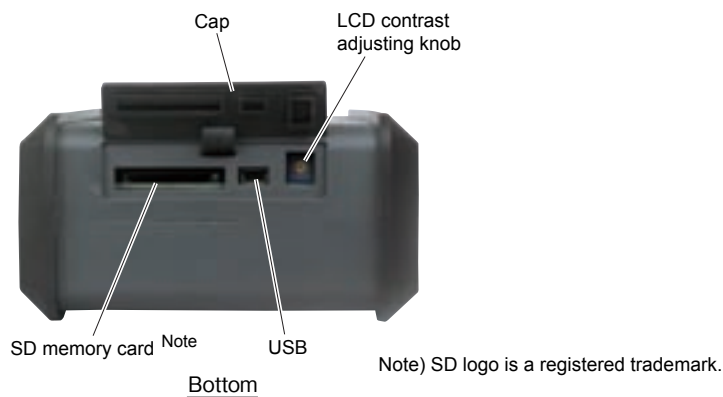
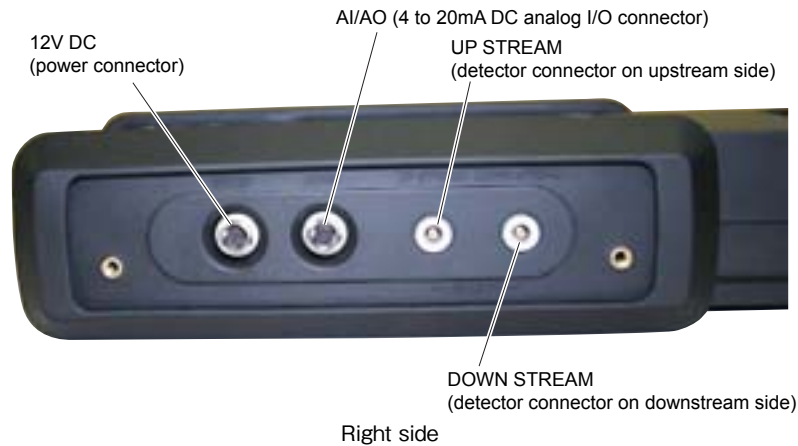

- **Connectors** : 12V DC
Connector of main unit power supply. Inputs 12V DC.
Insert the plug of the power adapter specified for this instrument.
- : UP STREAM (upstream side), DOWN STREAM (downstream side)
Receptacles to connect detector cables.
Connect matching the upstream and downstream sides.
- : ANALOG IN/OUT
Connect analog input/output signals (4 to 20mA DC).
Analog input signal: 2 points
 CH1: 4 to 20mA DC or 1 to 5V DC
 CH2: 4 to 20mA DC
Analog output signal: 1 point
 4 to 20mA DC
- : USB
USB port. Connect to an external system such as personal computer.
- : SD memory card
SD card slot. The measurement data and the screen data can be saved.
- : Contrast adjusting knob
Adjust the LCD contrast.

Note) Be careful not to lose the protective cap attached to power connector and analog input/output connector.

4.2 Explanation of keys

Fig. 3-1 shows the layout of keys and Table 3-1 explains each key.



Fig. 4-1 Layout of keys

Table 4-1 Explanation of keys

Key indication or lamp	Description
ENT	The keyed-in data, selected item, etc. will be set by pressing this key.
ESC	Cancels any setting.
▲	Moves the cursor upward, increments set value, etc. (repeats if held down)
▼	Moves the cursor downward, decrements set value, etc. (repeats if held down)
◀	Moves the cursor leftward, change scale, etc. (repeats if held down)
▶	Moves the cursor rightward, change scale, etc. (repeats if held down)
ON/OFF	Turns on/off power supply.
PRINT	Print of the display screen or save the data to SD memory card. (outputs a hard copy).
☀ (LIGHT)	Turns on/off the backlight of display screen.
FAST CHARGE	Turns ON in charge. Turns OFF in fully charged condition.
DC IN	Turns ON with power cable connected.
MENU	Displays MENU screen.

4.3 Handling of SD memory card

Use an SD memory card for recording measured data, flow velocity profile data and screen data. The equipment is capable of accommodating an SD memory card of capacity up to 8GB. An SD memory card of capacity 256MB is provided as an option.

Compatible media

- SD memory card
Speed class: Class2, 4, 6
- SDHC memory card
Speed class: Class4, 6

4.3.1 Precautions for handling of SD memory card

- (1) Use an SD memory card or SDHC memory card that has been formatted based on a standard.
- (2) Make sure to format the SD memory card or SDHC memory card based on its standard.
- (3) Firmly insert the SD memory card (or SDHC memory card; hereinafter the same) in the appropriate direction, and assure that it has been properly mounted.
- (4) Do not remove the card during data read/write operation. Data may be broken or erased. It is recommended that data stored on the card is periodically backed up. Important data is lost if the SD memory card is broken. Make sure to back up the data on the SD memory card.

4.3.2 Formatting forms

For formatting an SD memory card, use dedicated formatting software the memory card manufacturer provides. Data read/write is not permitted if the card is not property formatted.

Formatting forms

- FAT16: 64MB, 128MB, 256MB, 512MB, 1GB, 2GB
- FAT32: 4GB, 8GB

4.3.3 Insertion and removal

Methods for insertion and removal of an SD memory card are described below.

(1) Insertion

Step 1) Open the cap from the main unit bottom face.

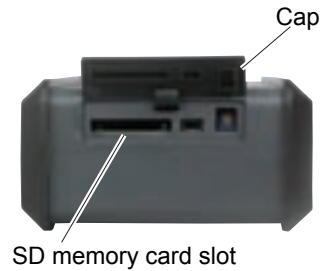

Step 2) Insert a memory card into the memory card slot in the main unit bottom face in the direction shown on the right. Card push-in system is adopted for card mounting. Positively push in the memory card to the lock-up position.



CAUTION

When inserting, align the memory card body to match the slot. Do not insert the card at an angle. Card should slide into slot freely without force. If the memory card is pushed with force in the state where the card is inserted as tilted, the connector in the main unit will be broken. Be careful.

(2) Removal

Card push-in system is adopted for card mounting. Push the card in straight. The card is unlocked and can be removed.

The data stored on a memory card can be directly read with a PC.

CAUTION

- Do not remove the memory card during data write operation.
- Do not remove the memory card before the main unit identifies the inserted memory card after its insertion.
- Be careful with static electricity at the time of removal of the memory card.
- Be sure to check the numeric value of the free space on Logger data screen. When numeric value is not shown, it means that data can not be saved since card has not been read properly. In case of this, be sure to insert the card once again.

4.3.4 Data recording to SD memory card

(1) Types of recorded data

Recorded data is of three different types indicated below.

- (1) Measured data: One logger file is composed of a configuration file and a data file.

Configuration file: Records logger start-up time and relevant logger data files.

Data file: Records logging data in a specific period produced by logger and quick logger.

The data file is stored as divided by 65,500 lines for permitting high-speed access and due to restrictions in the maximum number of lines of CSV display of Microsoft Excel.

- (2) Flow velocity profile: Records flow velocity profile data for an hour.

- (3) Screen copy: Records screen display copy data

See “10.3.1.(4) DEFINITION OF PRINT KEY”.

(2) File configuration

Recorded data is stored as files on an SD memory card.

The file configuration is such that a folder of site name is located just beneath the root folder and the following data manipulated by the subject site name is stored beneath said folder.

A folder of site name is created at the time of registration of a site name described in “10.1.1 SITE MEMORY”.

The recorded data is stored in the folder of the site name selected by site selection described in “10.1.1 SITE MEMORY”.

- (1) Measured data ... Just beneath the folder of site name

Case of logger

- Configuration data file name of created logger: logging_name_date_hour.ini
- Data file name of created logger: logging_name_date_hour.csv

Case of quick logger

- Configuration data file name of created logger: QUICK_date_hour.ini
- Data file name of created logger: QUICK_date_hour.csv

A data file can be edited with Excel.

See “16.5.2 Measured data file” located toward the end of the volume for the recording format.

- (2) Flow velocity distribution ... Beneath VEL folder just beneath folder of site name

- Created flow velocity distribution data file name: Vel_date_hour.csv

A data file can be displayed using flow velocity distribution demonstrate function of PC loader software.

See “16.5.3 Flow velocity distribution file” located toward the end of the volume for the recording format.

- (3) Screen copy ... Beneath DISP folder just beneath folder of site name

- Created screen copy file name: DISP_date_hour.csv

Recording format: Windows Bitmap

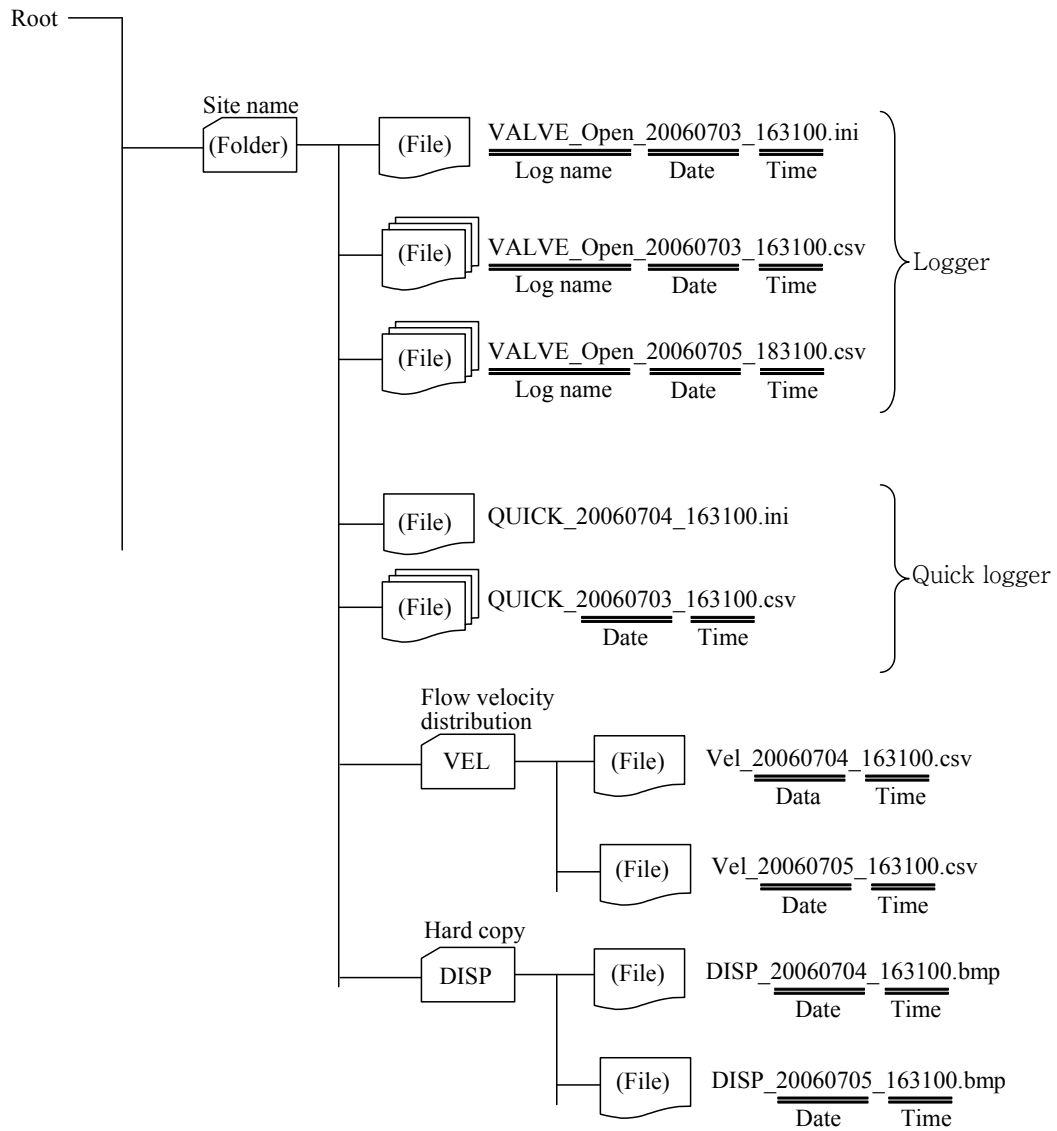

Fig. 4-2 File configuration

(3) Recording capacity

The recording capacity depends on the capacity of the SD memory card.

One logger file is composed of a configuration file and a data file.

The data file is stored as divided by 65,500 lines for permitting high-speed access and due to restrictions in the maximum number of lines of CSV display of Microsoft Excel.

The maximum number of data files in a logger is 20 files in case of a continuous logger, and is 550 files in case of an appointed time logger. If the capacity becomes short during logging operation, logging operation terminates with the following screen displayed.

Replace the SD memory card immediately, if this screen is displayed.

Press the (ESC) key, or remove the memory card, the message will be cleared.

Note) After reaching the maximum data file, the logging will stop.



Recording capacity in case an SD memory card of 256 MB is used with continuous logger

In case where the preservation period is 30 seconds and where logger data of all of 14 types is stored, it is possible to store measured data for about a year.

In the case stated above, the measured data is divided into 16 files, and the capacity of a file is about 15 MB.

See "10.2.1 Setting of data logger function" for the continuous logger and appointed time logger.

See "16.5.1 Types of measured data to be logged" for logger data types.

5. CHARGE METHOD AND OPERATION POWER SUPPLY

5.1 Operating power supply

There are two available methods for operating main unit ; by the built-in battery or with the power adapter.

(1) How to charge the built-in battery.

Please be sure to charge the buid-in battery as following procedure.

(1) Connect the AC power adapter to the main unit.

To insert the connector to the main unit, engage the notch of the connector on the code side and projection part of the connector on the transmitter side and then insert and turn the sleeve to lock.

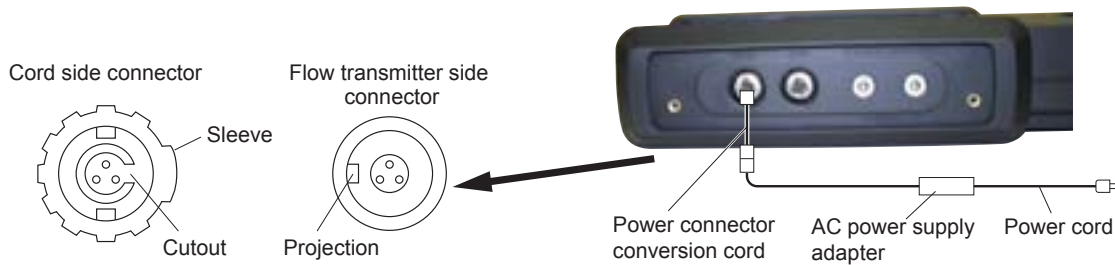

(2) Connect the power code to power receptacle (90 to 264 V AC (50/60Hz))

- “Pilot lamp” of the AC power supply adapter is turned green.....indicates that external power dispatching.
- ”CHARGE”LED of the main unit is turned red.....indicates that it is on charging.
- “DC IN “LED of the main unit is turned green.....indicates that external power dispatching is being conducted.



(3) When the main unit is fully charged, “CHARGE” LED goes out.

Note1) Temperature range for charging the built-in battery is 0 to 40°C. Conducting the charging beyond this range will cause heating battery, leak, performance degradation and short-life battery.

Note2) Soon after unplug the AC power supply adapter from the power receptacle, green LED of “AC power supply adapter” lights up for seconds and then goes off.

Note3) It is available to connect / disconnect the AC power supply adapter while main unit is using.

Note4) Battery maintains the charged status if AC power supply adapter is connected during use of main unit.

Note5) Even build-in battery is removed, main unit can be operated if AC power supply adapter is connected.

Note6) Build-in battery is fully charged when shipping from a factory.

(2) Operating by build-in battery

- (1) When turning on the power supply of the main unit without connecting the AC power adapter, the main unit be operated by the built-in battery.
When the main unit does not work, voltage reduction of battery is considered.
Be sure to charge the build-in battery or connect the AC power adapter to operate the main unit.
* About 3 hours will be required for charging.
- (2) When you use the main unit for a prolonged time, be sure to charge the battery fully prior to use.
* Under fully charged condition, the main unit can measure for about 12 hours.

Note) Conditions : Display backlight should be turned off. do not use current output. Ambient temperature is normal temperature 20°C.

(3) Operating by AC power adapter for a prolonged time

- (1) Connect the AC power supply adapter to use the main unit in the same way when charging.
It is no required to remove the build-in battery.

CAUTION

- Use the exclusive power adapter only. Don't use other adapters, or it may result in an accident.
- Other equipments such as printer, power adapters, etc. except the main unit are not waterproof.
Avoid using the product in a place where it will be exposed to water or humidity.

5.2 Turning on the power and language preference

(1) Press the ON switch of the main unit to turn ON the power.



(2) Turn ON the power, and the following screen appears.

(3) If there is nothing you can do on the screen for about 8 sec. the “MEASURE” screen appears.

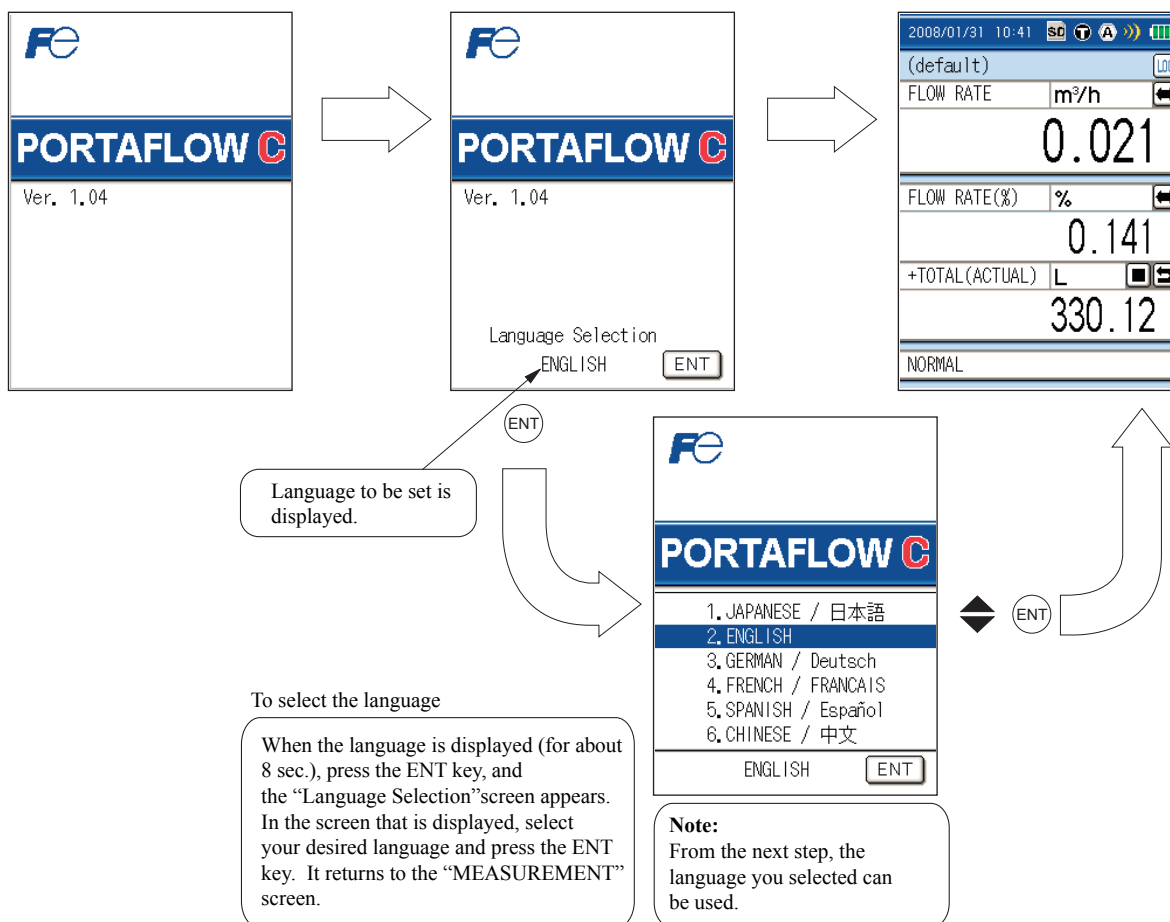

Note1) Select any of 6 languages (Japanese, English, German, French, Spanish, and Chinese).

Note2) To return to the “Language Selection” screen from the “MEASUREMENT” screen in display, turn OFF the power once and then turn it ON again. In the initial screen that is displayed, press the **ENT** key.

5.3 Power OFF

(1) Power OFF by [OFF] switch

Keep pressing the [OFF] switch on the main unit for 3 seconds or longer, to turn OFF the power.

In case where measured data is being logged to an SD memory card, execute logging interrupt processing before turning OFF the power.

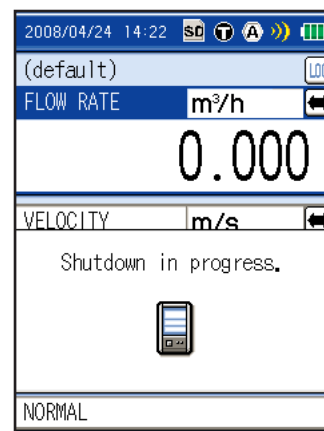

(2) Power OFF caused by drop in capacity of built-in battery

If the flowmeter is operated by the internal battery, the power is turned off after a shut down message appears when the battery runs down.

In case where measured data is being logged to an SD memory card, execute logging interrupt processing before turning OFF the power.

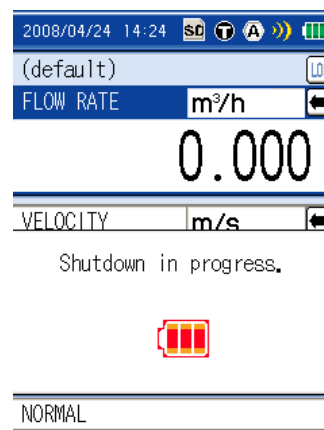

(3) Precautions for parameter setup change

When parameter setup is changed, parameters are stored in the internal non-volatile memory at upon return to the measurement screen.

The stored parameters are held even when the power is turned OFF.

Caution: If the power is turned OFF without returning to the measurement screen after parameter setup changes, the parameters are not stored, and setup is required again.

CAUTION

Do not operate the main unit using an AC power adaptor in the state where the built-in battery is removed from the main unit.

- If the power cable is disconnected from the power outlet or if power failure arises while measured data is being logged to the SD memory card, the data written to the SD memory card may be broken.

6. WIRING

6.1 Diagram

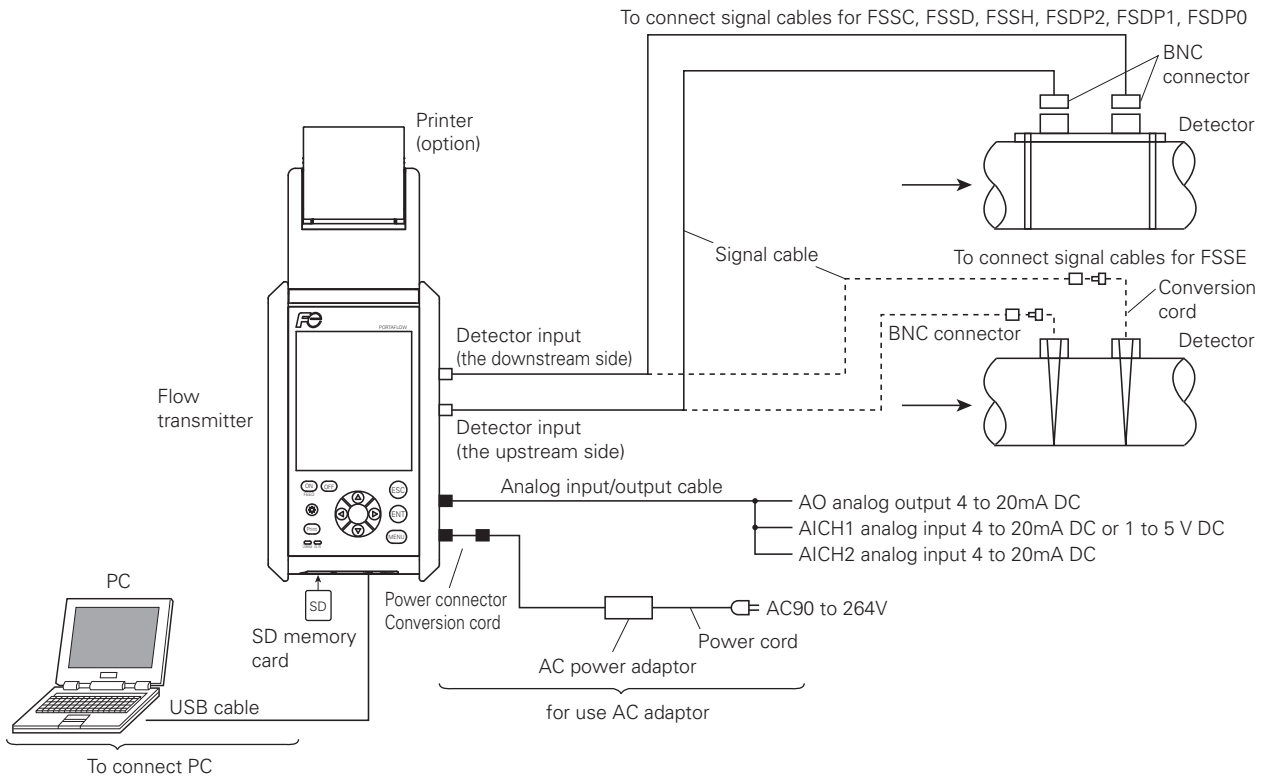

6.2 Connection of dedicated cables

This cable is used for connecting the detector to the main unit.

- (1) Connect dedicated cables to the upstream and downstream sides of the detector.
- (2) Connect one cable connected to the upstream side of the detector to the “UP STREAM” connector of the main unit, and connect the other cable connected to the down stream side of the detector to the “DOWN STREAM” connector.

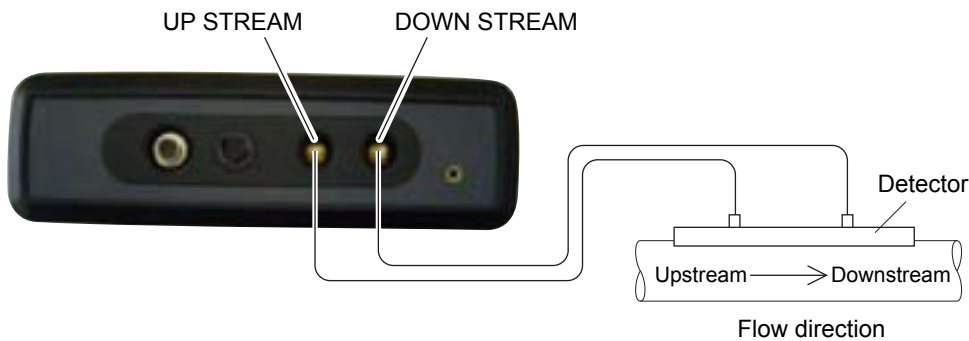

6.3 Connection of analog input/output cable (4 to 20 mA DC)

This cable is used for connection of receiving instruments (indicators, recorders, etc.) and flow transmitter to the main unit. Analog I/O cable is connected as shown below. The cable end is treated with a clip.

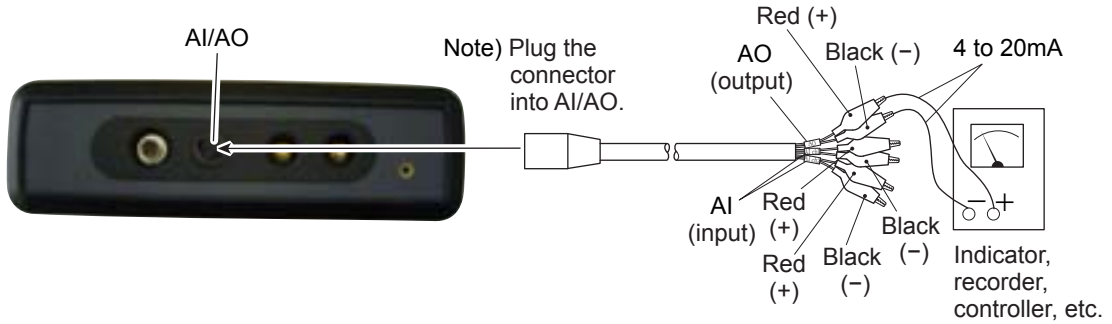

- (1) Connect clips of the analog I/O cable to the (+) and (-) sides of the receiving instruments, respectively.
- (2) Connect the analog I/O cable to the “AI/AO” connector at the side panel of the main unit.
Note) Allowable load resistance of analog output should be adjusted to 600Ω or less.
Input resistance of analog input is 200Ω.

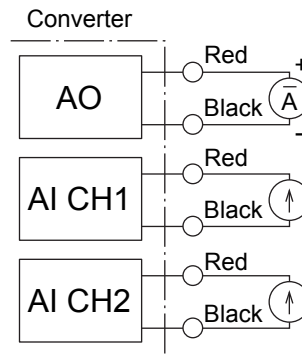

6.4 Connection of USB cable

When PC software is used, open the cap of down face of the main unit and USB port of PC; transmit connecting “USB” port with USB cable.
For PC software, refer to Chapter 13.

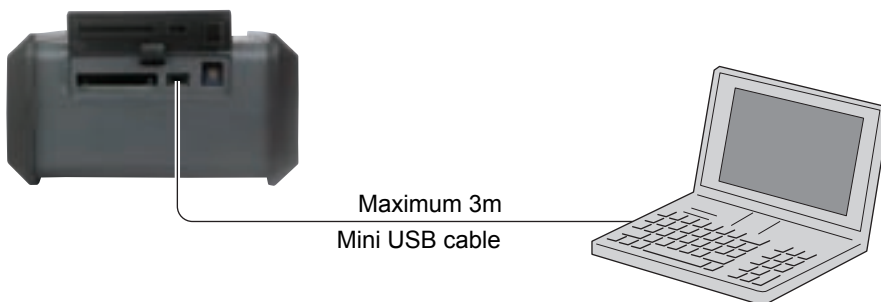

7. INPUT OF PIPING SPECIFICATIONS

Before installing the detector, set the specifications of a pipe in the main unit to allow measurements.

Caution) Measurements cannot be accomplished without these settings.

7.1 Display of pipe setup screen

(1) Press the **MENU** key on the “MEASURE” screen to display the “MENU” screen.

(2) Check that the “SITE SETUP” is reversed from white to blue.

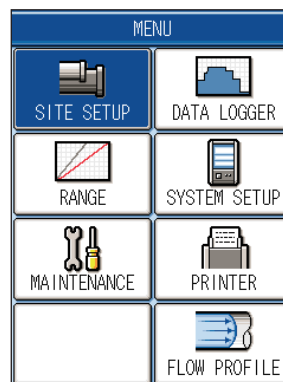

(3) Press the **ENT** key, and the “SITE SETUP” screen is displayed.

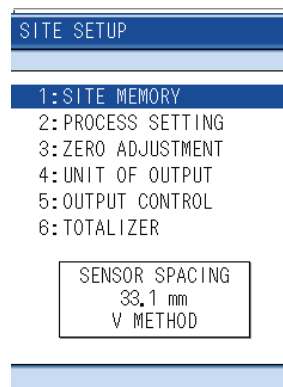

(4) Press the **▼** key, and move the cursor to “2: PROCESS SETTING”.

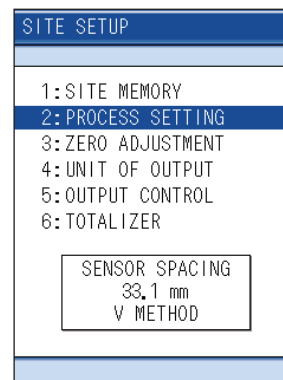

- (5) Pressing the **(ENT)** key returns to the “PROCESS SETTING” screen.

PROCESS SETTING

OUTER DIAMETER

OUTER DIAMETER ▾
60.00 mm

PIPE MATERIAL

PIPE S.V.

WALL THICKNESS

PVC ▾
2307 m/s
4.00 mm

1/4 ▶

- (6) Outline of PIPE PARAMETER (Parameter → Page No. for reference)

PROCESS SETTING

OUTER DIAMETER

OUTER DIAMETER ▾
60.00 mm

PIPE MATERIAL

PIPE S.V.

WALL THICKNESS

PVC ▾
2307 m/s
4.00 mm

1/4 ▶

Sets lining material → P30

Sets outer diameter of pipe → P27

Sets pipe material → P28

Sets lining thickness → P31

Sets pipe thickness → P29

PROCESS SETTING

LINING MATERIAL

LINING MATERIAL ▾
NO LINING

LINING S.V.

LINING THICKNESS

DECISION

0 m/s
0.00 mm

◀ 2/4 ▶

PROCESS SETTING

KIND OF FLUID

KIND OF FLUID ▾
WATER

FLUID S.V.

VISCOSITY

SENSOR MOUNT

DECISION

1440 m/s
1.0038 E-6m²/s
V METHOD ▾

◀ 3/4 ▶

Sets type of sensor → P35

Sets kind of fluid → P32

Sets transmission voltage → P36

Sets sensor mounting method → P34

◀ ▶

PROCESS SETTING

SENSOR TYPE

SENSOR TYPE ▾
FSSD/FSD22/FLD22

TRANS. VOLTAGE

DECISION

80Vpp ▾

◀ 4/4 ▶

(7) Display of mounting dimensions

After you finish the site setting on establish site screen, “Decision” is reversed from white to blue by pressing **ENT** key.

Display the message “After sensor installation, please adjust Zero point”, turn back to “SITE SETUP” screen.

At the last line the “SENSOR SPACING” value is displayed.

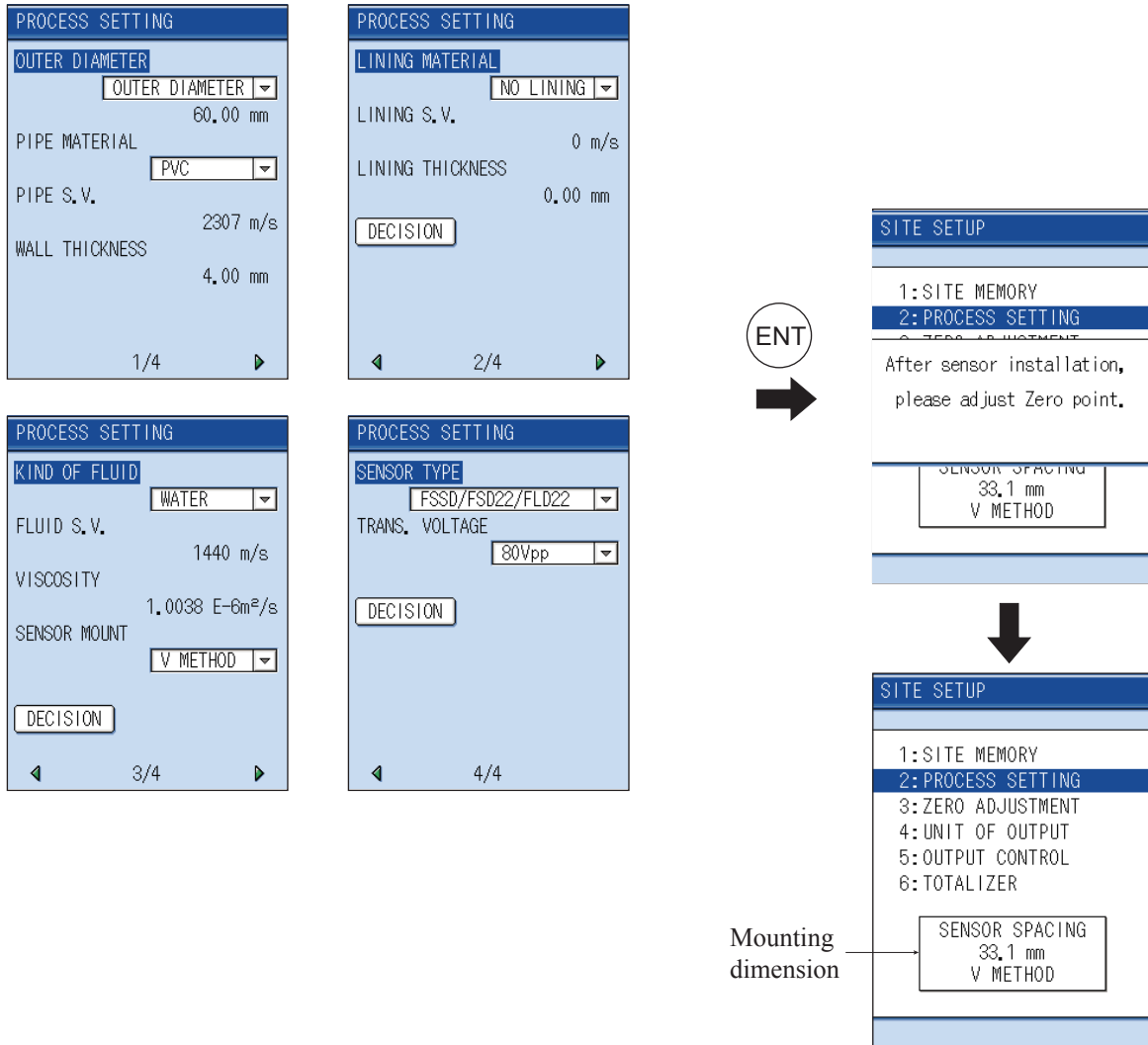

Install the sensor according to chapter 8. MOUNTING OF DETECTOR and the mounting dimension is as displayed on the last line.

CAUTION

- For small pipe diameter, the sensor mounting length can be 0.0mm.
- When the sensor mounting length is 0.0mm, error of the measurement is approximately ± 2 to 5%.

7.2 Entry of site name (not required measurement)

Enter the name of the site (where measurement is performed). This name is registered with process setting ((4) of page 21).

- (1) Move the cursor to “1: SITE MEMORY” on the SITE SETUP screen.

Note) Before setting the “2. Establish setting”, the Site registration is required.

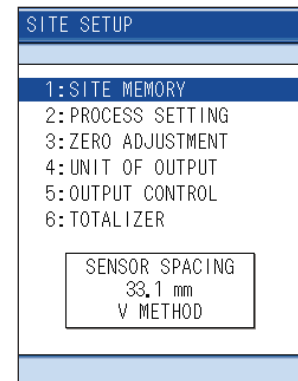

- (2) Press the key to display the SITE MEMORY screen.

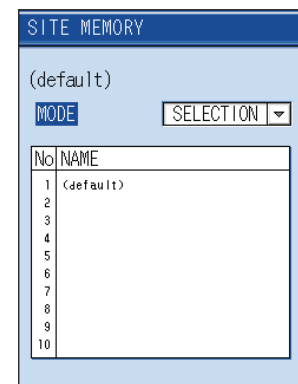

- (3) Press the key after checking that cursor is placed in the MODE.

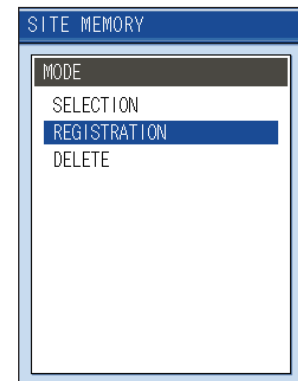

- (4) When the mode selection screen appears, move the cursor to the “REGISTRATION” and press the key.

- (5) Move the cursor to the unregistered field and press the **ENT** key.

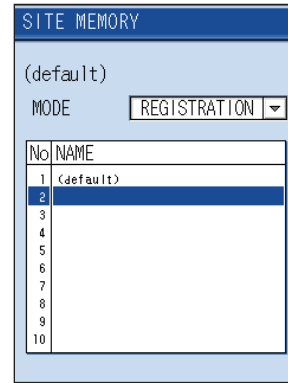

- (6) When the entering screen appears, enter the name of the site.
Up to 10 characters can be entered.
(See the following for the method of entering.)

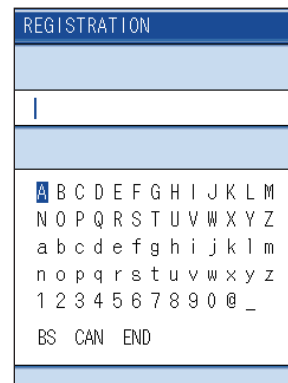

[Reference] Description of character entry screen

Select a character and press the **ENT** key. Characters will be displayed one by one in the entry field.
Select “BS” and press the **ENT** key to delete characters one by one.
In case of stopping entry in the middle, select “CAN” and press the **ENT** key to return to the original SITE MEMORY screen.

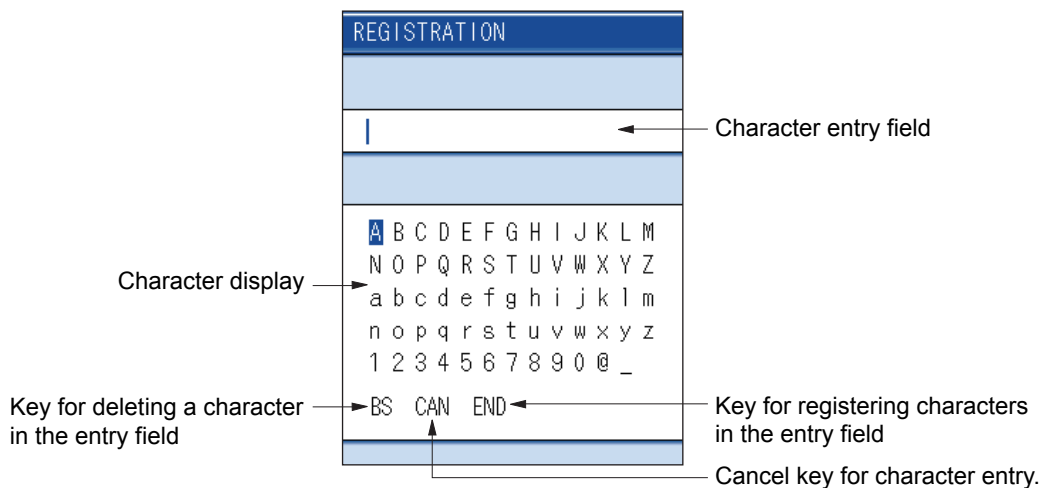

- (7) Move the cursor to “END” and press the (ENT) key to complete the character entry.

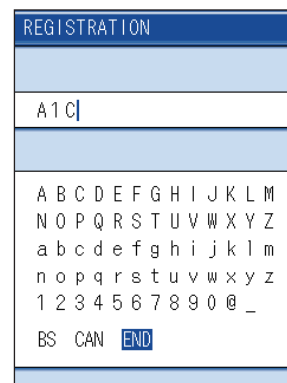

When moving the cursor in the character entry field

Press the (ESC) key so that the cursor “|” will change to “█”.

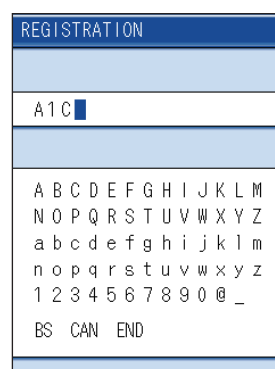

The cursor can be moved by the (▶) and the (◀) key.

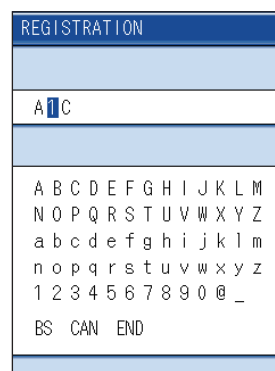

For entering characters to the place the cursor is

moved, press the (ESC) key

The cursor moves to the character entry field.

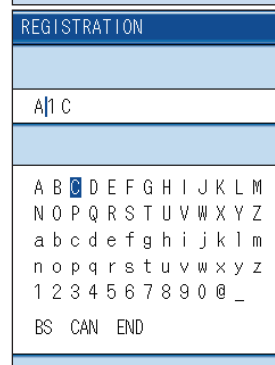

Note 1) Entry can be made with alphanumeric characters.

Note 2) To stop character entry in the middle, select “CAN” and press the (ENT) key.

The original SITE MEMORY screen reappears.

7.3 Outer diameter of piping (unit: mm)

The “OUTER DIAMETER” is reversed from white to blue, on the “PROCESS SETTING” screen

Press the **(ENT)** key, the screen of “OUTER DIAMETER” for selecting the input method of outer diameter measurement and “CIRCUMFERENCE” screen will appear.

Press the **(ENT)** key after the selection to enter the outer dimension.

(See pages 162 to 168 Piping Data)

Use the **(◀)** or **(▶)** key to cause the digit to move in the right and left direction

Use the **(▲)** or **(▼)** key to enter the numeric.

After entry, press the **(ENT)** key.

Note) Enter outer dimensions, not nominal diameter (example: 20A → 20).

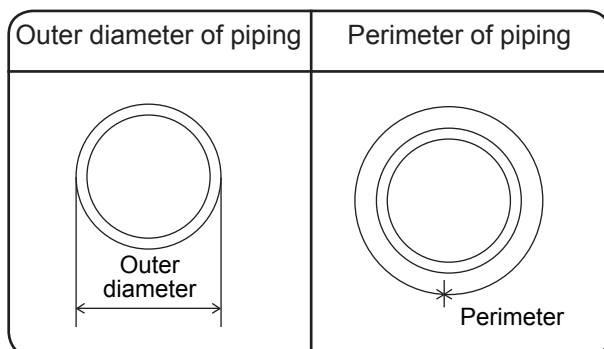

[Input range]

Outer diameter : 6 ~ 6200mm

Perimeter : 18.84 ~ 19477.88mm

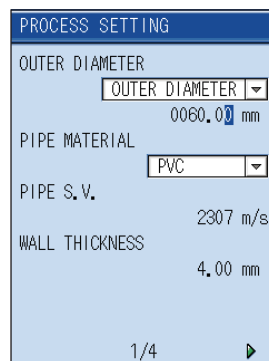
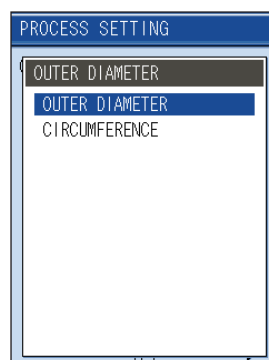
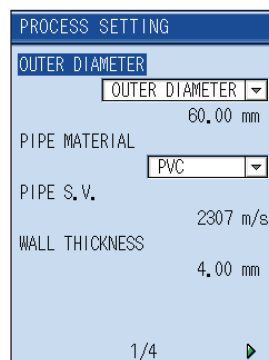

Example) When the outer diameter of piping is 318.5 mm:

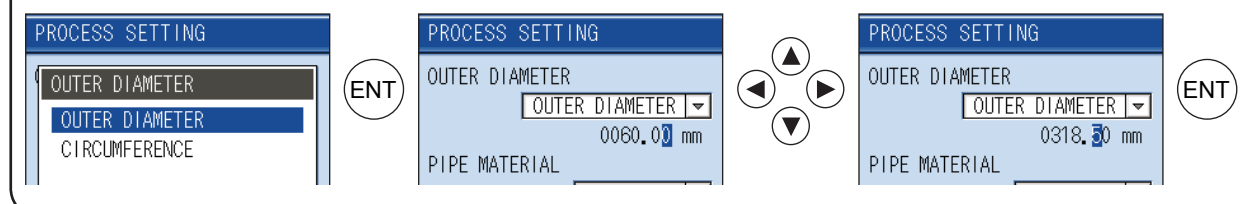

7.4 Piping material

Press the \blacktriangledown key on the “PIPE MATERIAL” is reversed from white to blue.

Press the ENT key, and the “PIPE MATERIAL” screen will appear.

Select the material by the \blacktriangle or \blacktriangledown key.

After entry, press the ENT key.

When “OTHERS” is selected:

Enter the sound velocity (range: 1000 to 3700m/s).
See page 168, Table (25).

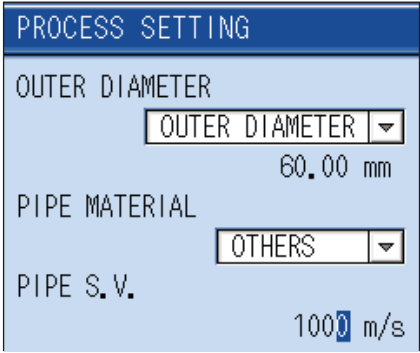

The screenshot shows the 'PROCESS SETTING' screen. The 'PIPE MATERIAL' dropdown is set to 'OTHERS'. The 'PIPE S.V.' field contains '1000' m/s. The 'OUTER DIAMETER' is set to '60.00 mm'.

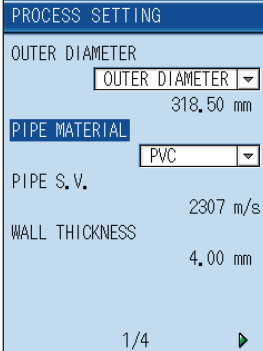

The screenshot shows the 'PROCESS SETTING' screen. The 'PIPE MATERIAL' dropdown is set to 'PVC'. The 'PIPE S.V.' is '2307 m/s' and 'WALL THICKNESS' is '4.00 mm'. A '1/4' indicator is at the bottom right.

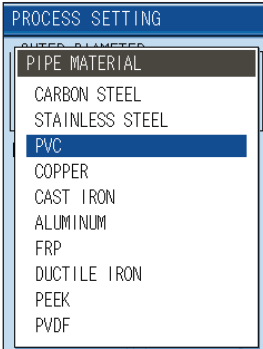
The screenshot shows the 'PIPE MATERIAL' selection screen. The list includes CARBON STEEL, STAINLESS STEEL, PVC (highlighted), COPPER, CAST IRON, ALUMINUM, FRP, DUCTILE IRON, PEEK, and PVDF.



Example) When the piping material is cast iron:

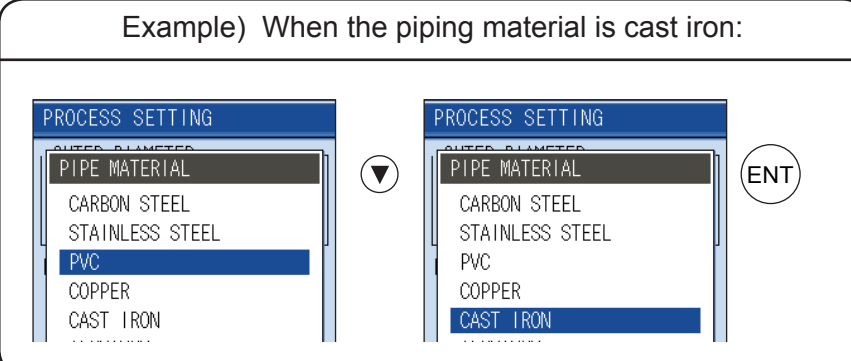

The diagram shows two 'PROCESS SETTING' screens. The first screen shows the 'PIPE MATERIAL' list with 'PVC' highlighted and a \blacktriangledown key icon next to it. The second screen shows 'CAST IRON' highlighted and an ENT key icon next to it.

7.5 Wall thickness (unit: mm) (range: 0.1 to 100.00mm)

Press the \blacktriangledown key, the “WALL THICKNESS” is reversed from white to blue.

Press the ENT key, Wall thickness can be entered (See pages 162 to 168, Piping Data).

Use the \blacktriangleleft or \blacktriangleright key to move the digit to the left and right.

Using the \blacktriangleup or \blacktriangledown key, enter the numeral. After entry, press the ENT key.

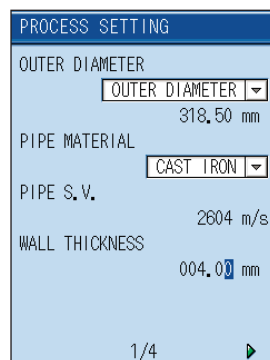
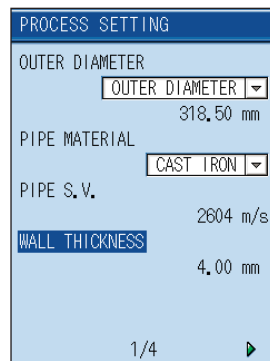

Lining and wall thickness of piping

If the wall thickness is not known, measure it by the wall thickness gauge, and enter the value.

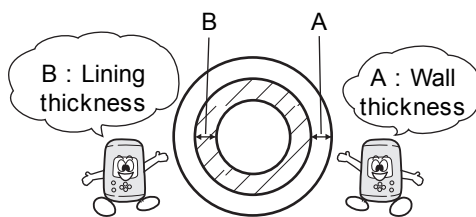

Example) When the wall thickness is 1.25 mm:

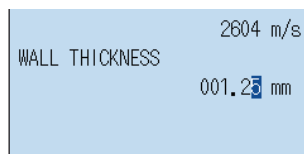
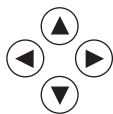
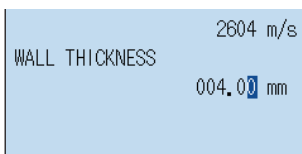

7.6 Lining material

Press the \blacktriangledown key, "LINING MATERIAL" is reversed from white to blue.

Press the ENT key, the "LINING MATERIAL" screen will appear.

Select the material, using the \blacktriangle or \blacktriangledown key. After selection, press the ENT key.

When "OTHERS" is selected:

Enter the sound velocity (range 1000 to 3700m/s).
See page 168, Table (25).

LINING MATERIAL
OTHERS
 LINING S.V. 1000 m/s
 LINING THICKNESS

PROCESS SETTING
 LINING MATERIAL NO LINING
 LINING S.V. 0 m/s
 LINING THICKNESS 0.00 mm
 DECISION
 2/4



PROCESS SETTING
 LINING MATERIAL
 NO LINING
 TAR EPOXY
 MORTAR
 RUBBER
 TEFLON
 PYREX GLASS
 PVC
 OTHERS



Example) When the lining material is mortar:

PROCESS SETTING
 LINING MATERIAL
 NO LINING
 TAR EPOXY
 MORTAR
 RUBBER

PROCESS SETTING
 LINING MATERIAL
 NO LINING
 TAR EPOXY
 MORTAR
 RUBBER

7.7 Lining thickness (unit: mm) (range: 0.01 to 100.00 mm)

When the lining material is set to items other than “None” in 7.6 Lining material.

Press the \blacktriangledown key, the “LINING THICKNESS” is reversed from white to blue.

Press the ENT key, lining thickness numeric entry can be performed.

The cursor can shift the numeric digit by the \blacktriangleleft or \blacktriangleright key. The numeric can be entered by the \blacktriangleup or \blacktriangledown key.

After entry, press the ENT key.

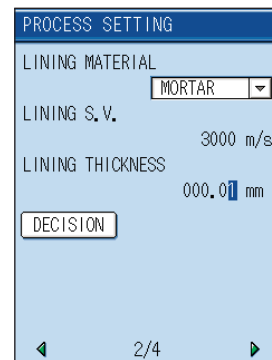
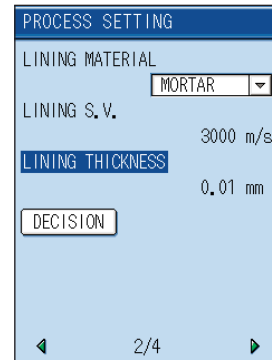

Example) When the lining thickness is 1.25 mm:

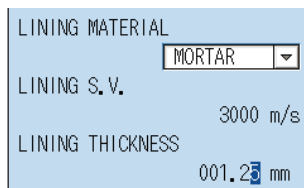
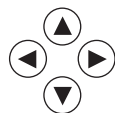
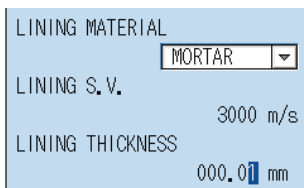

7.8 Kind of fluid

Jump to 3/4 page with \blacktriangledown or \blacktriangleright key.

Select kind of fluid.

For fluid having no entry, enter sound velocity.

(Range: 500 to 2500 m/s)

Press the \blacktriangle or \blacktriangledown key, the “KIND OF FLUID” is reversed from white to blue.

Press the ENT key to display the “KIND OF FLUID” screen.

Select the kind of fluid by the \blacktriangle or \blacktriangledown key.

After selection, press the ENT key.

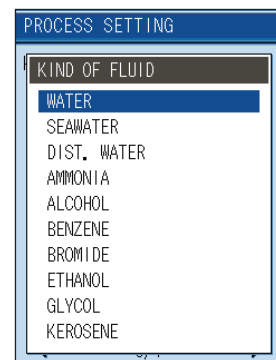
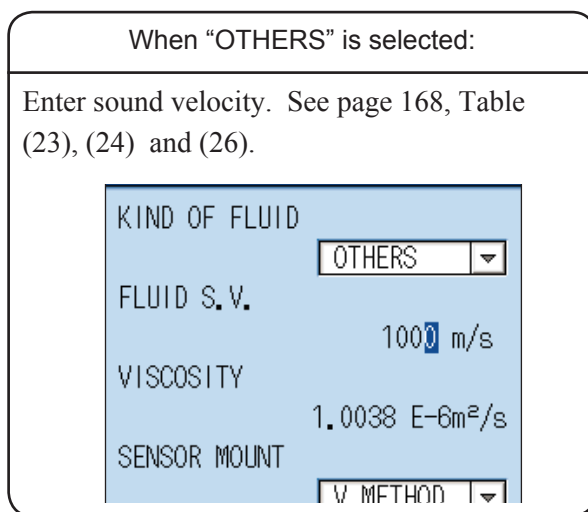
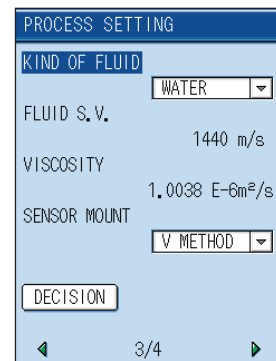

7.9 Viscosity







There is no need to change “1.0038E-6m²/s” when measuring water.
Return the screen by pressing the  key.

Remarks

Dynamic viscosity coefficient is set to water (20°C).
When measuring accurately or measuring fluid other than water, enter as needed.
(See page 168, Table (26).)
(Range: 0.001×10^{-6} to $999.999 \times 10^{-6} \text{m}^2/\text{s}$)

Press the  key, the “VISCOSITY” is reversed from white to blue.

Press the  key, you can enter the dynamic viscosity coefficient.

Move the digit by pressing the  or  key and enter numeric values by using the  or  key.

After entry, press the  key.

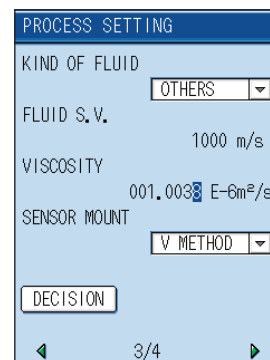
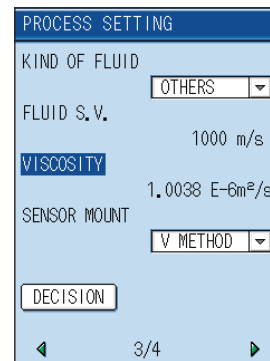

7.10 Selection of sensor mounting method

Mounting methods available for the sensor are V method and Z method as illustrated.

To select the mounting method;

Press the \blacktriangledown key, the “SENSOR MOUNT” is reversed from white to blue.

Press the ENT key. The “SENSOR MOUNT” screen will appear.

Select either V or Z method by the \blacktriangle or \blacktriangledown key.

Remarks

Select the V method generally. Use the Z method in the following cases:

- Ample space is not provided.
- High turbidity
- Weak receiving waveform
- Thick scale is deposited on the pipe internal surface.

V method

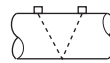

Z method



(Except. Small sensor FLD22.)

PROCESS SETTING	
KIND OF FLUID	OTHERS \blacktriangledown
FLUID S. V.	1000 m/s
VISCOSITY	1.0038 E-6m ² /s
SENSOR MOUNT	V METHOD \blacktriangledown
DECISION	
3/4	



PROCESS SETTING	
SENSOR MOUNT	
V METHOD	
Z METHOD	



7.11 Kind of sensor

Press the \blacktriangledown key, “SENSOR TYPE” is reversed from white to blue.

Press the ENT key to display the sensor type.

Select any sensor from the type code of sensor to be used.

Select the sensor by the \blacktriangle or \blacktriangledown key.

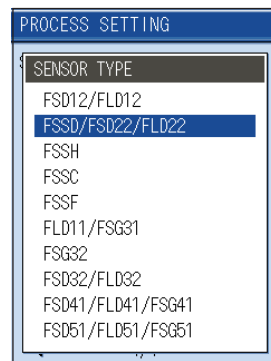
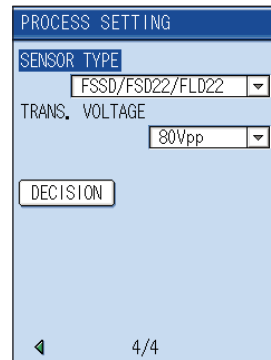

Example) When kind of sensor is FSSD 12:

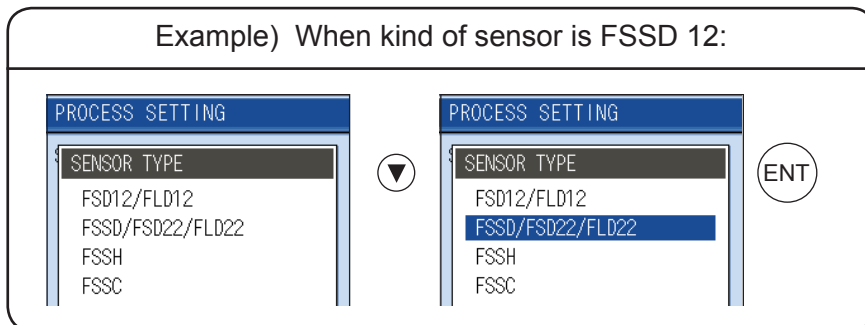

7.12 Transmission voltage (used when an indicator is 1 or less during measurement)

Press the ∇ key, the “TRANS. VOLTAGE” is reversed from white to blue.

Press the ENT key, the screen is ready to allow the selection of the transmission voltage level.

Use the \blacktriangle or ∇ key to select the level.

Select “40Vpp” or “80Vpp” generally.



If the indicator cannot be set to MAX with the level at “160Vpp”, ultrasonic wave may be attenuated due to contamination or scales deposited on the piping external and internal surfaces. Change measurement location.

Example) When transmission voltage is set to “160Vpp”:

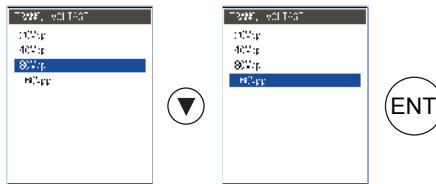

The indicator will be updated on the measurement screen only.

If less than 2 indicators (intensity of receiving waveform) are displayed on the measurement screen, raise the transmission voltage.

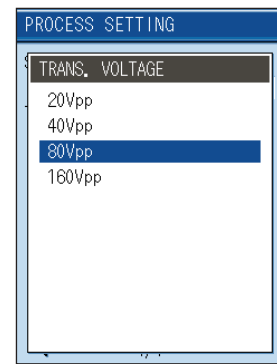
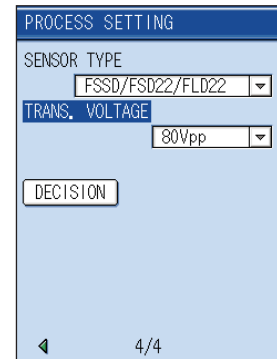

7.13 Completion of PROCESS SETTING

After the settings are completed, press the \blacktriangledown key
 “DECISION” is reversed from white to blue.
 Pressing the ENT key to complete settings, and then
 returns to the “SITE SETUP” screen.
 After mounting the sensor, perform zero point
 calibration.

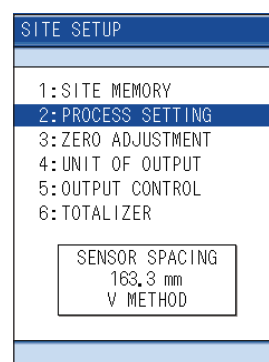
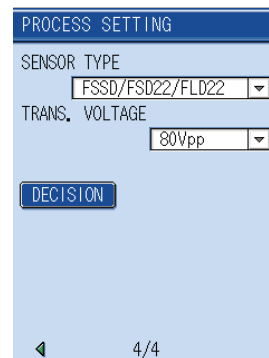

Note) When the inner mounting diameter is 13mm, the sensor mounting method is 0.0mm or less depending on the pipe materials.

[Unit: mm]

Necessary pipe thickness for fluid water			
CARBON STEEL	2.15	FRP	3.21
STAINLESS STEEL	1.87	DUCTILE IRON	2.15
PVC	3.69	PEEK	3.69
COPPER	3.82	PVDF	3.69
CAST IRON	2.98	ACRYLIC	2.90
ALUMINUM	1.99	PP	3.69

When the sensor mounting length is 0.0mm or less, error of the measurement is approximately ± 2 to 5%.

8. MOUNTING OF DETECTOR

8.1 Selection of mounting location

Detector mounting location, i.e., the conditions of the pipe subjected to flow rate measurement exert a great influence on measurement accuracy. So select a location meeting the conditions listed below.

- (1) There is a straight pipe portion of 10D or more on the upstream side and that of 5D or more on the downstream side.
- (2) No factors to disturb the flow (such as pump and valve) within about 30D on the upstream side.

Classification	For upstream side	For downstream side
90° bend		
Tee		
Diffuser		
Reducer		
Valves		
Pump		

Extracted from Japan Electric and Machinery Industry Society (JEMIS-032)

(3) Pipe is always filled with fluid. Neither air bubbles nor foreign materials are contained in the fluid.

(4) There is an ample maintenance space around the pipe to which the detector is to be mounted (see figure below).

Note 1) Secure an adequate space for allowing a person to stand and work on both sides of a pipe.

Note 2) D indicates the inside diameter of a pipe.

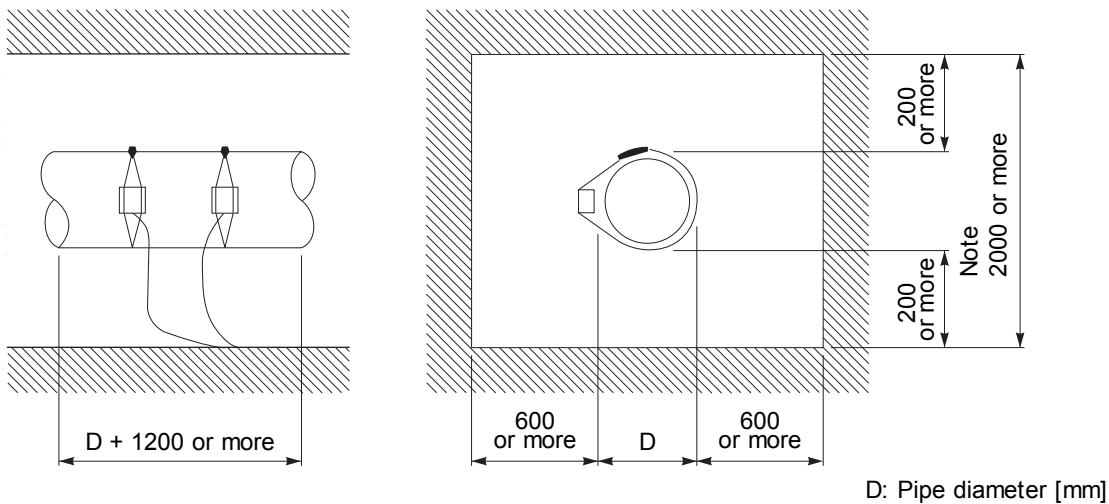

Space required for mounting detector

(5) The piping must completely be filled with fluid when it flows.

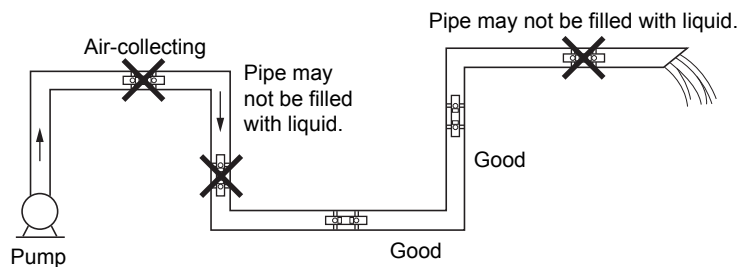

(6) For a horizontal pipe, mount the detector within $\pm 45^\circ$ of the horizontal plane.

For a vertical pipe, the detector can be mounted at any position on the outer circumference.

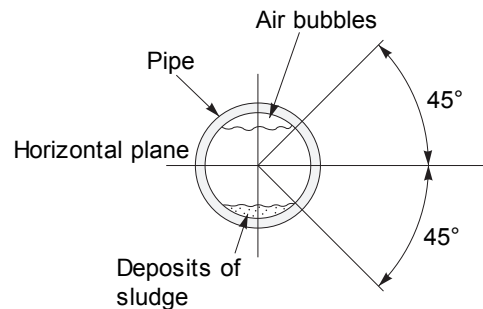

(7) Avoid mounting the detector near a deformation, flange or welded part on the pipe.

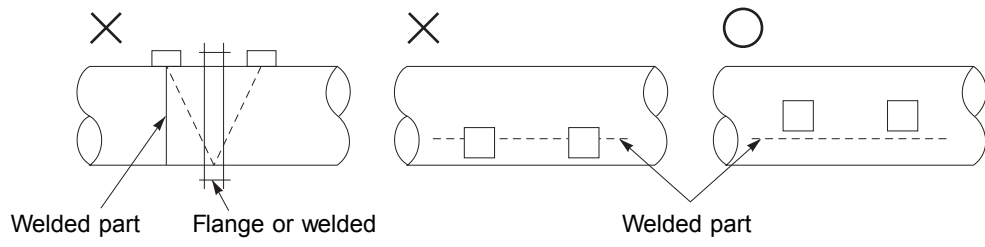

8.2 Selection of detector

(1) Selection of mounting methods

There are 2 methods for mounting the detector; V method and Z method. For the mounting space, see the following sketch.

<Large/Medium sensor>

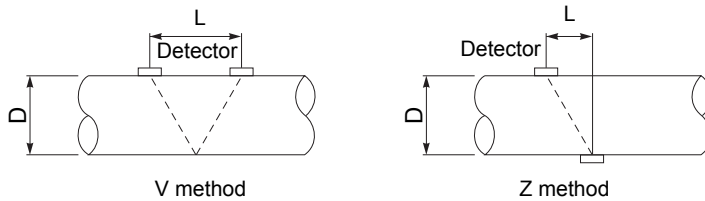

<Small diameter sensor, small sensor or high-temperature sensor>

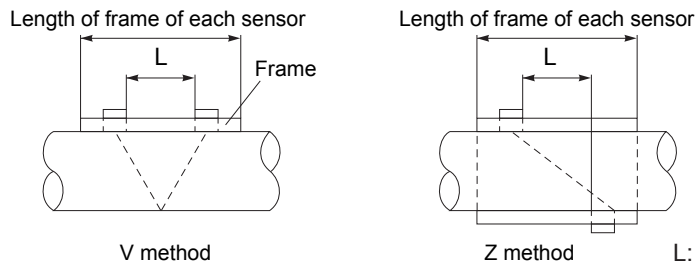

Mounting method

L: Mounting dimension

(The dimension values of the sensor attachment displayed on the SITE SETTING screen of the transmitter.)

Employ the Z method in the following cases.

- Mounting space need be saved (mounting space of the Z method is about one half of the V method's).
- Turbid fluid such as sewage is to be measured.
- Pipe has mortar lining.
- A thick film of scale may have been formed on the inner surface of pipe because it is old.
- In sufficient received signal-strength with mounting detectors in V method while using maximum transmission voltage.

(2) Image figure of mounting dimension

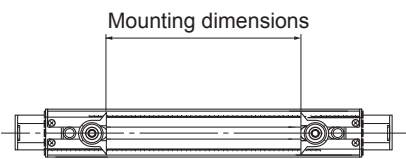
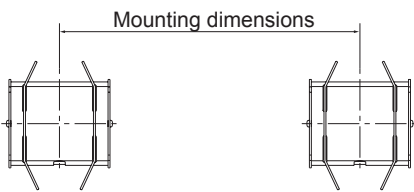
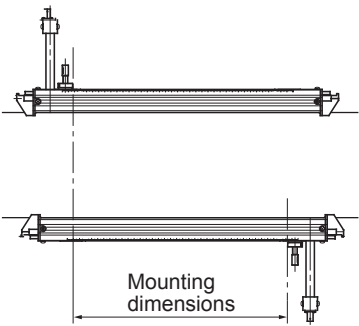
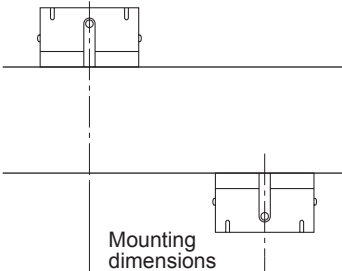
Type	FSSC, FSSD, FSSH	FSSE
Mounting method	V method	V method
Mounting dimensions		
Type	FSSC, FSSD, FSSH	FSSE
Mounting method	Z method	Z method
Mounting dimensions		

(3) Detector selection standards

The Z method for large size sensor is recommended for outer diameter 300mm or more.

FSSE should be used as much as possible for pipes such as old pipes, cast iron pipes, and mortar lining pipes, through which it is difficult for ultrasonic signals to pass.

Type	Fluid temperature [°C]	Mounting method	Inner diameter of piping ϕ (mm)										
			13	25	50	100	200	250	300	400	1000	3000	6000
FSSC	-40 to 120	V	50 Px, P, M 300										
		Z	200 Px, P, M 1200										
FSSE	-40 to 80	V	200 Px, P, M 3000										
		Z	200 Px, P, M 6000										
FSSD	-40 to 100	V	13 Px, P, M 300										
		Z	150 P, M 300										
FSSH	-40 to 200	V	50 Px, P, M 250										
		Z	150 Px, P, M 400										

Classification of piping materials $\left\{ \begin{array}{l} \text{Px} : \text{PP, PVDF} \\ \text{P} : \text{Plastic (PVC, etc.)} \\ \text{M} : \text{Metallic piping (steel pipe, copper pipe, aluminum, etc.)} \end{array} \right.$

8.3 Use of surface-treated accessories

Eliminate pitting, corrosion, unevenness, etc. with paint thinner and sandpaper from the pipe portion where the detector is to be mounted.

Note) In case jute is wound on a pipe, it should be peeled off before the above treatment.

When cast iron pipe is used, grind the sensor mounting surface by using a sander for smoothness.

Detector	Width
Small outer diameter FSD22	320 mm or more
Small size (standard) sensor FSD12	540 mm or more
Medium size sensor FSD41	Mounting dimension (L) + 200 mm or more
Large size sensor FSD51	Mounting dimension (L) + 200 mm or more
High temperature FSD32	530 mm or more

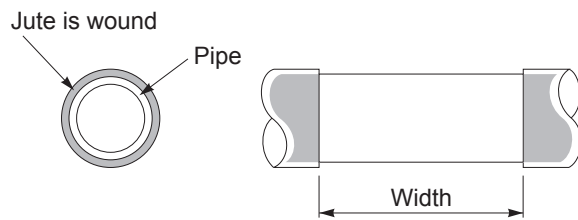

8.4 How to mount FSSC to pipe

8.4.1 How to mount a detector (V method)



CAUTION

When adjusting the length of the rail, make sure to work on the table.
Injury or damage of the products may be caused by falling.
Please pay attention not to loose screws.

- (1) Confirm the Item 2.5. (mounting dimension of the sensor) whether or not you have to extend the rail.
 - Mounting pitch $\leq 300\text{mm}$ Mounting pitch is adjustable without extending the rail.
 - Mounting pitch $> 300\text{mm}$ First, rail is require to be extended.

- (2) How to extend the rail

- Loosen the two fixing screws (M4) on the end of extension rail (blue). (turning screw two times)

Note: Do not turn the screw (M4, L=6mm) excessively .Otherwise loose screw may come off and become lost.



- Slide the guide rail (silver). Fix the rail length with fixing screw which is adjustable in every 10mm.



- When extending the rail 300mm or more, slide the opposite side of the rail as well (Max.400mm extendable).

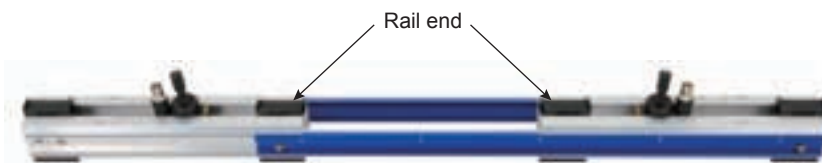

Note: In case the rail is extended 200mm or more, middle of the rail will become unstable. Thus make sure to mount the supplied rail end and fix the four part of the rail with fixing belts to use.

For easy use and maintenance

Even if extending rail is not required, extend the rail 100mm (=3.937inch) at least if mounting dimension is 100mm or more, which enable to remove the sensor unit in the middle of the rail without removing the rail from the pipe.

Additionally, There is a merit that it makes regular maintenance easy only if grease is used as acoustic coupler.

Please conduct it in the same way when removing the sensor with water-proof treatment from the rail.

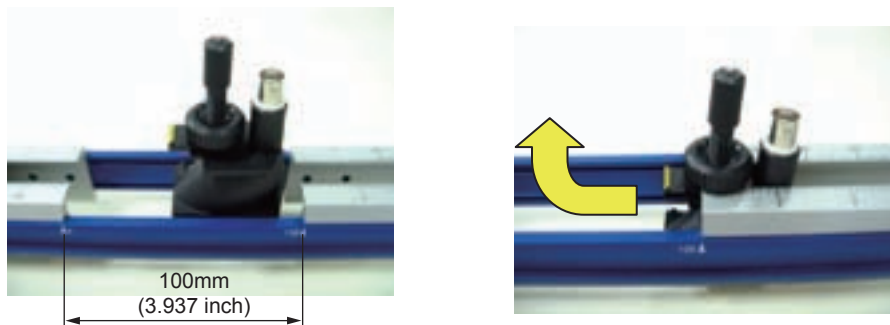

(3) Loosen the lock nut and adjust the mounting dimension of the sensor unit.

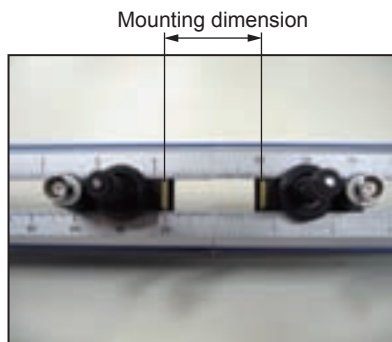

(4) Apply the acoustic coupler on the transmission surface of the sensor unit.
For easy applying, Turn the element holder and remove the sensor unit before applying.
Return the sensor unit where it was after applying.



- (5) Fix the rail with the mounting belt on the pipe to be measured and turn the element holder to attach the transmission surface of the sensor unit on the pipe correctly.

Note: Please pay attention to the contacting part as not to attach the rail on the pipe excessively since excessive pressure causes the rail end to come off the pipe depending on size and type of belt, or causes the resin pipe to deform and causes measurement error to occur.

Please refer to the item “8.4.3 Method of mounting belt” which vary depending on the belt type.

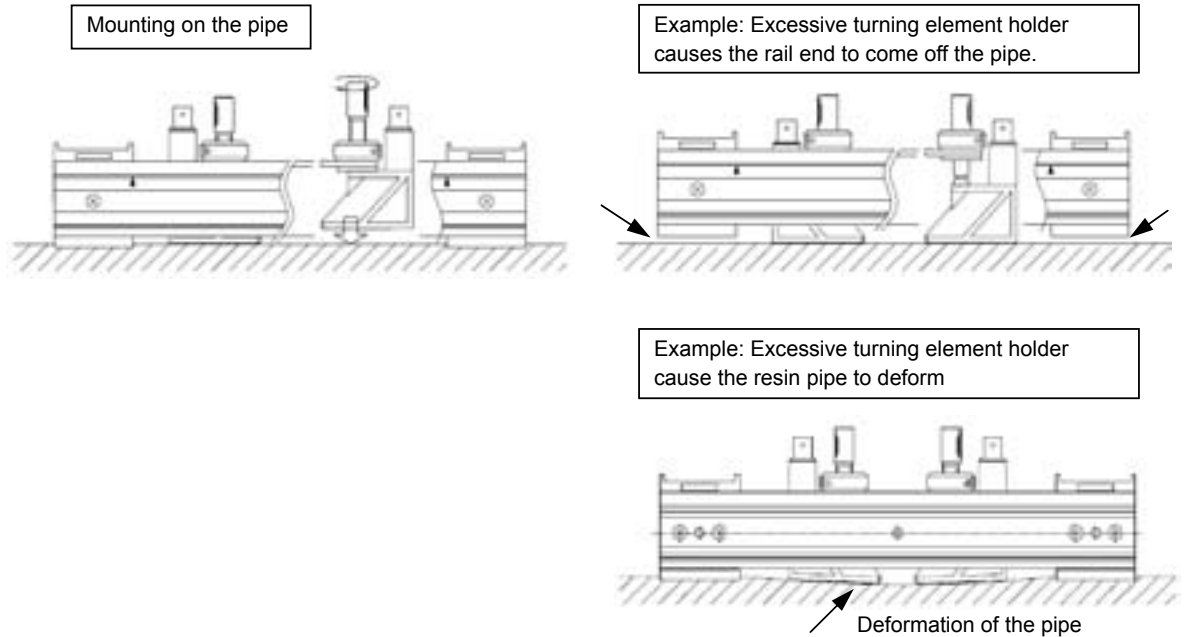

- (6) Connect the signal cable. Note) Please make sure that power of transmitter is turned OFF when connecting.

Connection example: discriminate the cable color between the upper stream “Red” and down-stream “Black” and connect them to transmitter with matching color cable.

For type of water-proof treatment, signal cable is already connected as factory default.

Without water-proof treatment



With water-proof treatment



- (7) If there is not much space to mount since pipe size is small and short length, one of guide rail can be removed and use the rail as a half size as shown below.
However, it is available to use only if dimension of mounting pitch is 65mm or less.

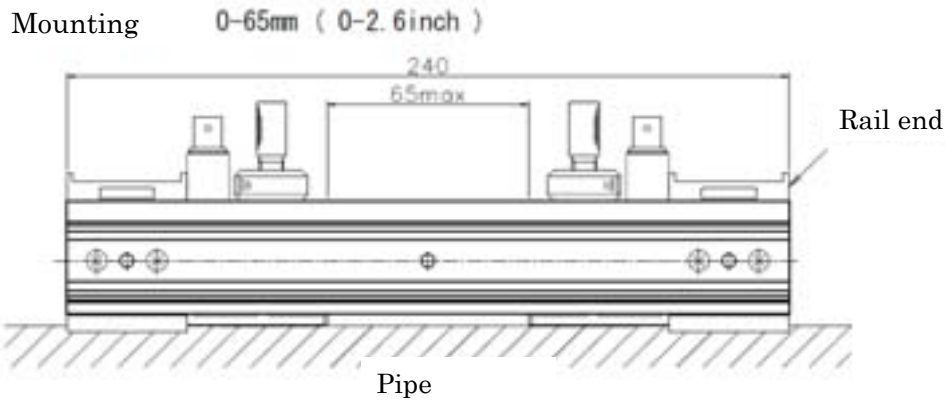

8.4.2 How to mount a detector (Z method)

- (1) Confirm the mounting dimension in Item 7.1.
- (2) Mark the mounting position on the pipe.
Please refer to Item 8.1 ~ 8.3 “How to determine the mounting position”.
- (3) Preparation of the rail
 - Set up the rail for Z method
 - 1) Loosen the 4 screws which fix the extension rail (blue) and remove the guide rail.
 - 2) Screw the each supplied rail end with 4 screws. (2pieces)

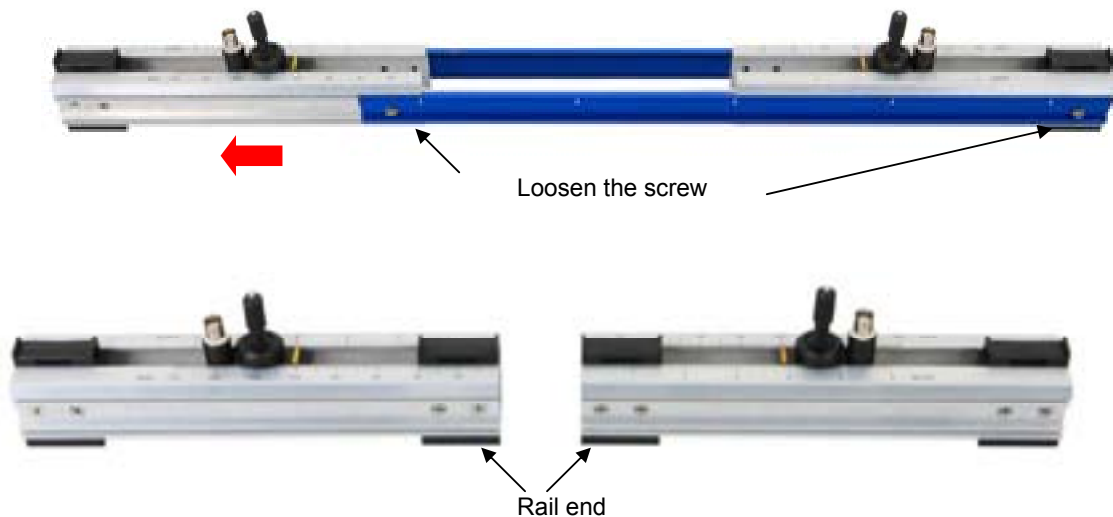

- (4) 8.4.1 Apply the acoustic coupler on the sensor unit as same as Item (4).

-
- (5) Fix the rail of sensor unit with mounting belt on the marked line and turn the element holder to attach the surface of the sensor unit to the pipe.

Note: Note that excessive pressure may cause the rail end to come off the pipe.

Mounting method vary depending on the type of belt. Please refer to the Item.4.3 for details.



- (6) Connect the signal cable.

Note: Please make sure that power of transmitter is turned OFF when connecting.

Connection example: discriminate the cable color between the upper stream “Red” and downstream “Black” and connect them to transmitter with matching color cable.

For type of water-proof treatment, signal cable is already connected as factory default.

In case you bend the base of the signal cable with water-proof, length of minimum radius to bend is 100mm.

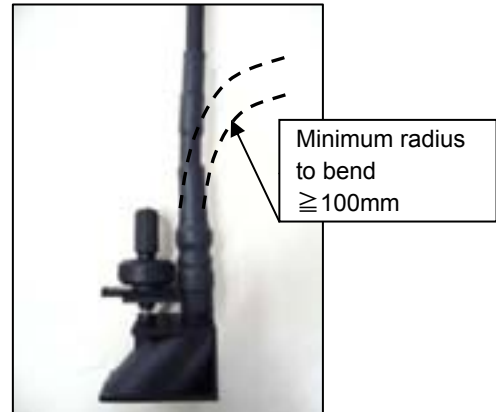

8.4.3 Method of mounting belt

⚠ CAUTION

Please use the gloves and the pliers when conducting work on stainless steel belt. Otherwise, you may hurt yourself.

Followings are description how to use the belt selected at 6th digit of code of symbols. It is described based on FSSC type and it is also reference for other types.

(1) Stainless steel belt (6th digit: A)

1-1) Put the belt through the hole of the rail end and wrap it around the pipe.



1-2) Put the belt through the latch.



1-3) Return the belt at the end of the latch.



1-4) Put the latch back on.



1-5) Lock the latch.

Please make sure the tension of the belt to put the latch back on.

When tension is not tight enough, go back to the procedure 1-3) and make an adjustment.

After locking the latch, make sure to cut the extra length of the belt or wrap it around the pipe.



(2) Plastic cloth belt (6th digit: B)

2-1) Wrap the belt with rough side facing up around pipe.



2-2) Put it through the buckle.



2-3) Fix the belt with pulling back.



(3) Belt with SUS screw clamp (6th digit: C)

3-1) Put the belt through the hole of the rail end and wrap it around the pipe.



3-2) Put the belt through the fixing clamp.



3-3) Pull the belt, lay down the screw and wrap it tighten the screw with screwdriver around the pipe.



3-4) Make sure the tension of the belt and make an adjustment.



(4) Wire (6th digit: D,E)
[For mounting of V method]

4-1) Adjust the wire length to the pipe size.



4-2) Put the wire through the hole of rail end and wrap it around the pipe and hook it with mounting spring to fix. Mounting spring length is approx. 180mm.



[For mounting of Z method]

4-1) Adjust the wire length to the pipe size.



4-2) Put the wire through the hole of rail end and wrap it around the pipe and hook it with mounting spring to fix. Mounting spring length is approx. 180mm.



8.5 How to mount FSSD to pipe

8.5.1 How to mount a detector (V method)

- (1) Loosen the lock nut and slide the sensor so as to meet the mounting dimension and then tighten the nut.

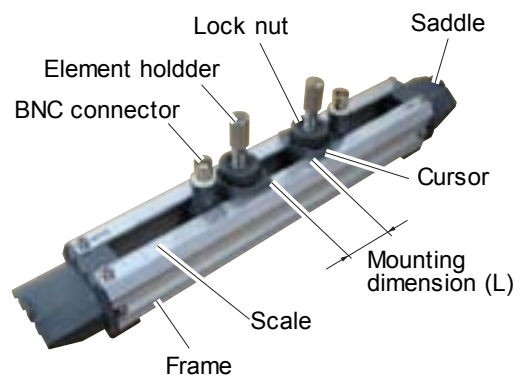

- (2) Apply a coat of silicone grease to the transmitting surface of the sensor. Spread the compound over the entire area. Keep the sensor retracted by turning the element holder counterclockwise. After cleaning the surface of the pipe, the sensor should be mounted

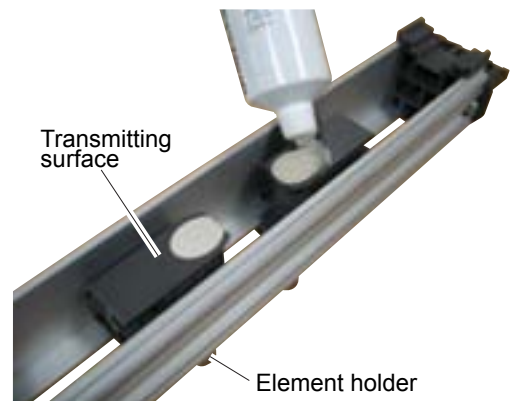

CAUTION

Apply a small quantity (like toothpaste) of silicon grease to the transmitter unit.

- (3) Fix the both ends (saddles) of the sensor to the pipe by cloth belts. Mounting will be facilitated by winding the cloth belts on the pipe in advance. Cloth belts are usable at 80°C or lower. If beyond 80°C, stainless steel belts should be used. (High-temperature stainless belt: Drawing No. ZZP*TK7P1943C1)

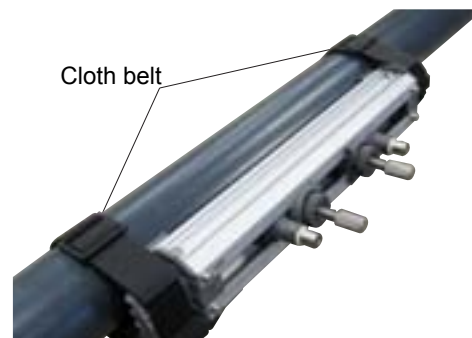

- (4) Make sure the sensor is mounted in parallel with the pipe axis and the mounting dimension is right. Then, turn the element holder clockwise until the sensor comes in close contact with the pipe. While checking that the transmitting surface horizontally comes in contact with the pipe surface, turn the element holder until it becomes difficult to be turned.

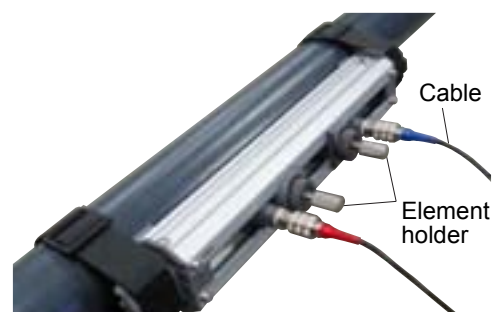

CAUTION

Be careful not to turn the element holder too much, otherwise it may be damaged.

8.5.2 How to mount a type FSSD3 (Z method)

- (1) Turn the lock nut counterclockwise to remove one of two sensor units from frames. Prepare the guide rail (an optional item) for the small size detector.

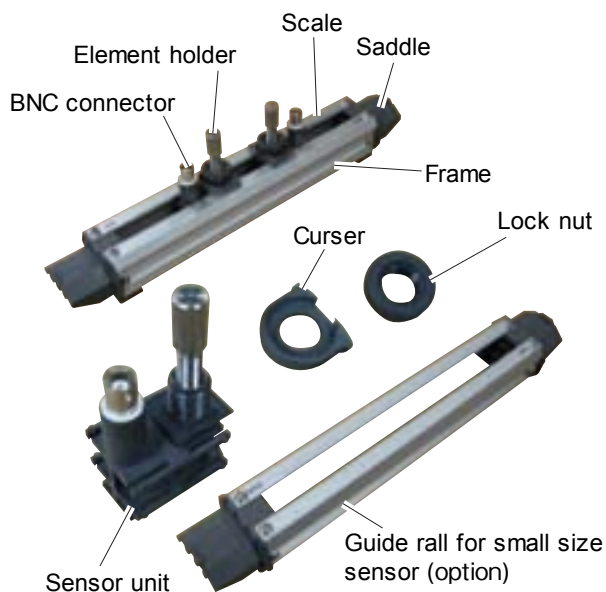

- (2) Mount the removed sensor unit on the guide rail for small size sensor. Fasten the sensor unit with locknuts so that the attachment dimensions (L) are obtained.

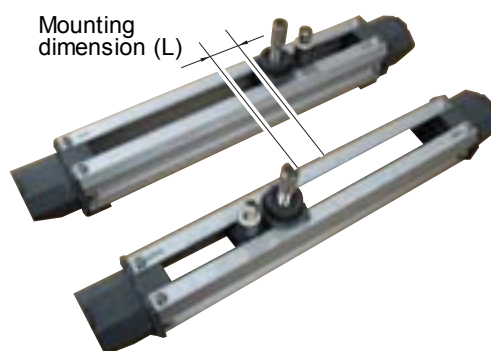

- (3) Spread silicone grease over the whole transmitting surface of the sensor.

Turn the element holder counterclockwise to return the sensor.
After cleaning the surface of the pipe, the sensor should be mounted.

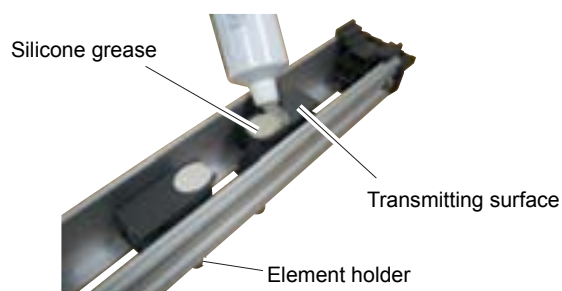

CAUTION

Apply a small quantity (like toothpaste) of silicon grease to the transmitter unit.

- (4) Mount each sensor individually on the marking line.

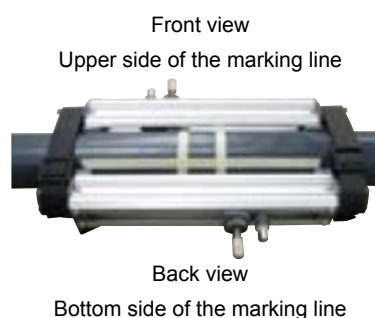

-
- (5) Make sure that the sensor is mounted in parallel with the piping and that the mounting position is correct. Then, turn the element holder clockwise until the sensor is firmly fitted to the piping.

While checking that the transmitting surface horizontally comes in contact with the pipe surface, turn the element holder until it becomes difficult to be turned.



CAUTION

Be careful not to turn the element holder too much, otherwise it may be damaged.

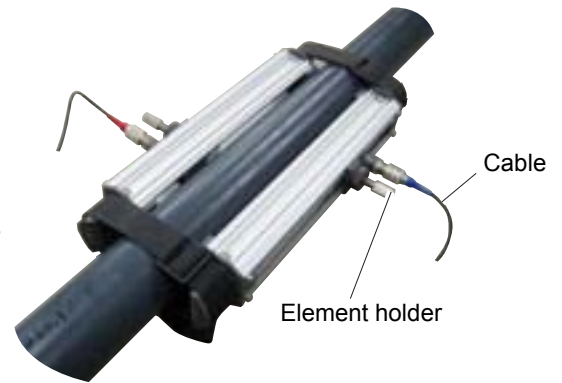

8.6 How to determine the attachment positions of the medium and large size detectors

Determine the mounting position by carrying out the following work.

For this work, gauge paper is necessary (For the gauge paper, refer to Item 8.9).

- (1) Match the edge of gauge paper with the line at about 100mm from one end of the pipe portion treated for detector mounting, and wind the gauge paper so that the line marked on the paper is parallel with the pipe axis (fix with tape not to allow deviation). At this time, the edge of gauge paper should be aligned.

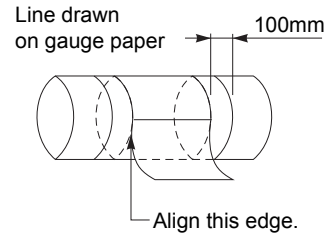

- (2) Extending the line marked on the gauge paper, mark straight line A on the pipe.

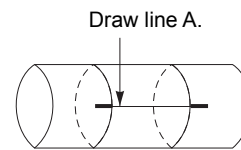

- (3) Mark a line along on edge of the gauge paper. The intersection of this line and straight line A is replaced with A_0 .

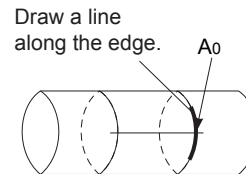

- (4) In mounting by the V method, peel the gauge paper and measure the mounting dimension from A_0 to determine A_2 position. At this position, mark a line orthogonal to the straight line A.

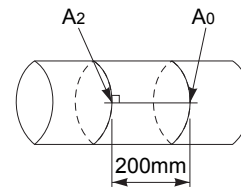

A_0 and A_2 become the mounting positions.

Example) $L = 200\text{mm}$

- (5) In mounting by the Z method, measure the circumference from A_0 with a measuring tape. At 1/2 of the circumference, determine points B_0 and B_1 , and mark a line (straight line B) connecting those points.

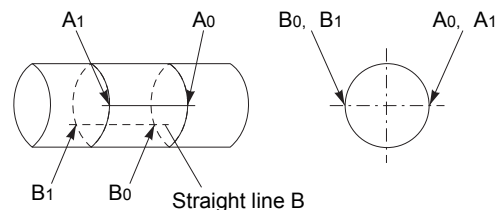

- (6) Mark the points B_0 and peel off the gauge paper. Measure the mounting dimension from B_0 to determine B_2 position. At this position, make a line orthogonal to the straight line B.

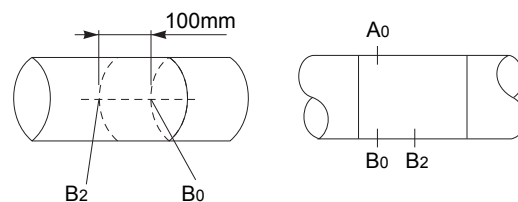

A_0 and B_2 become the mounting positions.

Example) $L = 100\text{mm}$

8.7 How to attach the type FSSE

8.7.1 How to connect the signal cable

9th digit in code symble “Y”: Connect it according to the following procedures.

9th digit in code symble “B”: The connection works are not required.

CAUTION

- Be careful not to cut your hands or etc. by the cover.
- Be sure to turn off the power before connecting the signal cable to the terminal, otherwise electric shock may result.
- Do not tighten the screws too tightly, otherwise the threaded portions may be damaged.
Proper tightening torque: 80 to 120 [N•cm]

- (1) After removing the M4 screws on the cover of the detector, remove the cover while opening it.

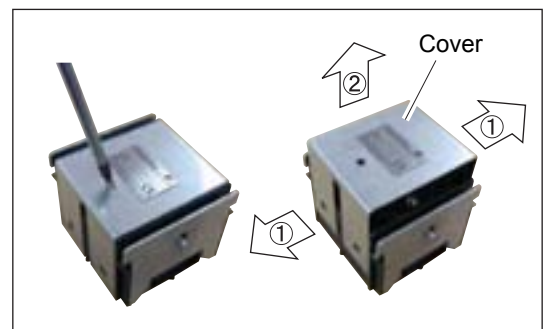

- (2) Determine the attachment position to the piping and the direction of the signal cable so that the transmission direction marks (INSIDE) face each other..



- (3) Remove the two M4 screws to remove the cable clamp.
Put the cable and connect the signal cable. Fix the signal cable with the cable clamp.

CAUTION

Connect the core wire (white) of the signal cable to (+) and the shield wire (Black) to (G).

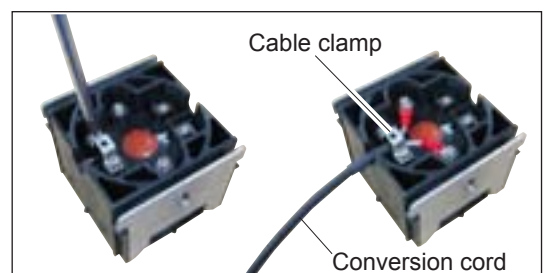

- (4) Put the cover and install screws.



- (5) Connect the signal cable and conversion cord with BNC connector.

Water-proof grade of connector part is IP66 under the condition of interdigitation.
Please avoid using this in the water.

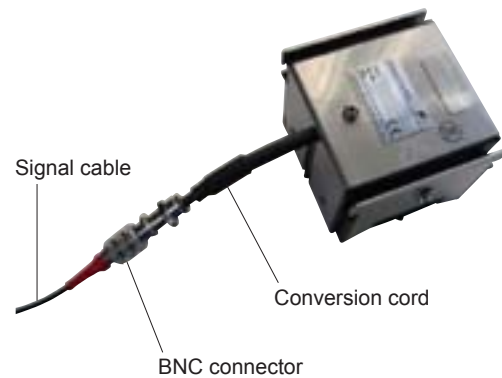

8.7.2 How to mount large size sensor to pipe

(1) Height adjustment of guide plate

- Place the sensor on the pipe surface in parallel with the pipe axis.
- Loosen the guide plate fixing screw and slide the guide plate until its edge and transmitting surface touch the surface of pipe.
- Then tighten the fixing screw.

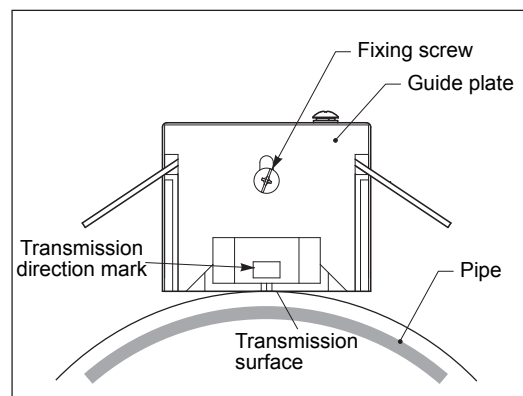

(2) How to determine the length of wire rope

- Place the sensor on the marked lines and fit the wire rope and fastening spring.
- Loosen the wire clip and pull the wire rope until the overall length of fastening spring approximates 180mm. Then tighten the wire clip.
(The fastening spring has a free length of 110mm.)
- While fixing the wire rope, remove the sensor.

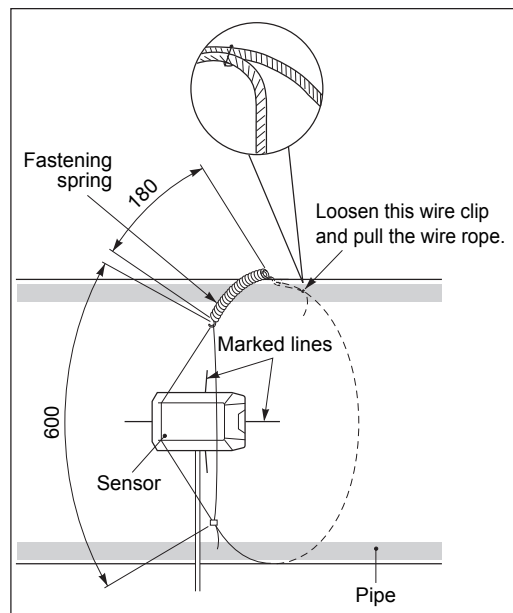

(3) Mounting of sensor

- Wipe off contaminants from the transmitting surface of sensor and the sensor mounting surface of pipe.
- Apply the silicone grease on the transmitting surface of sensor while spreading it evenly.
- Film thickness of the silicone grease should be about 3mm.



- Spread the wire rope near the marked lines in the left-right direction, bring the sensor in close contact and fit the wire rope.



CAUTION

Be careful not to cut your hands with the wire rope or other parts.



- Align the matching mark of sensor with the marked line. In addition, make the transmitting direction marks of sensors face each other.
- Make sure the matching mark of sensor is aligned with the marked line and connect the coaxial cable to the transmitter.



CAUTION

Do not pull the signal cable.
If it is pulled, the sensor is shifted which results in incorrect measurements.

8.8 How to mount FSSH to pipe

8.8.1 How to mount a sensor (V method)

- (1) Loosen the lock nut and slide the sensor so as to meet the mounting dimension and then tighten the nut.

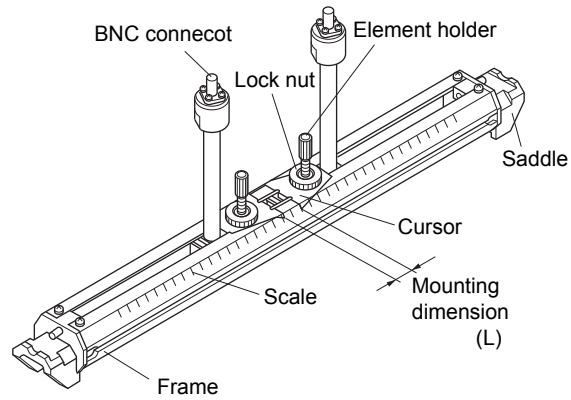

- (2) Apply a coat of grease for high temperature to the transmitting surface of the sensor. Spread the compound over the entire area. Keep the sensor retracted by turning the element holder counterclockwise. After cleaning the surface of the pipe, the sensor should be mounted.

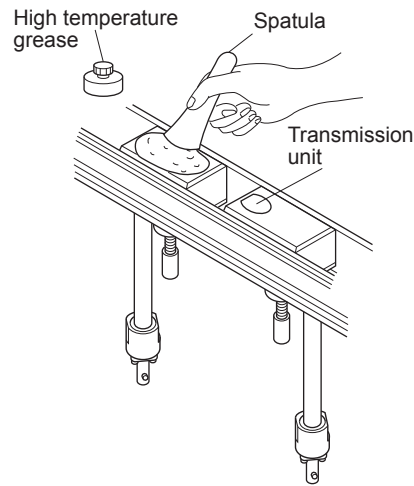

- (3) Fix the both ends (saddles) of the sensor to the pipe by stainless belts.

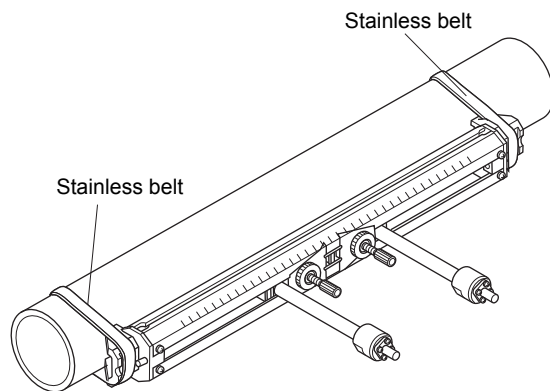

- (4) Make sure the sensor is mounted in parallel with the pipe axis and the mounting dimension is right. Then, turn the element holder clockwise until the sensor comes in close contact with the pipe. Stop turning the element holder when it stiffens because the transmitting surface comes in contact with the pipe surface. Be careful not to turn the holder excessively.

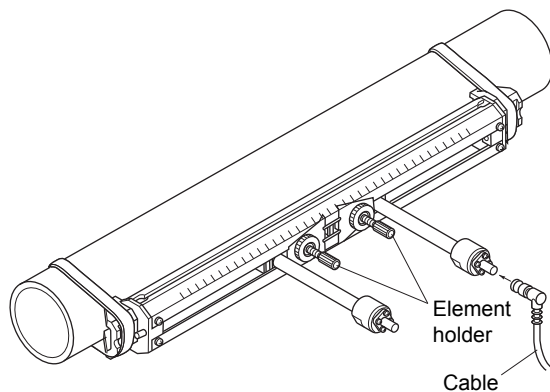

CAUTION

Be careful not to cut your hands with the stainless steel belt or other parts.

8.8.2 How to mount a sensor (Z method)

- (1) Remove saddle set screws at 4 locations, and remove a saddle and a sensor unit out of the frame.
Also, remove a saddle on the guide rail for high temperature sensor (option).

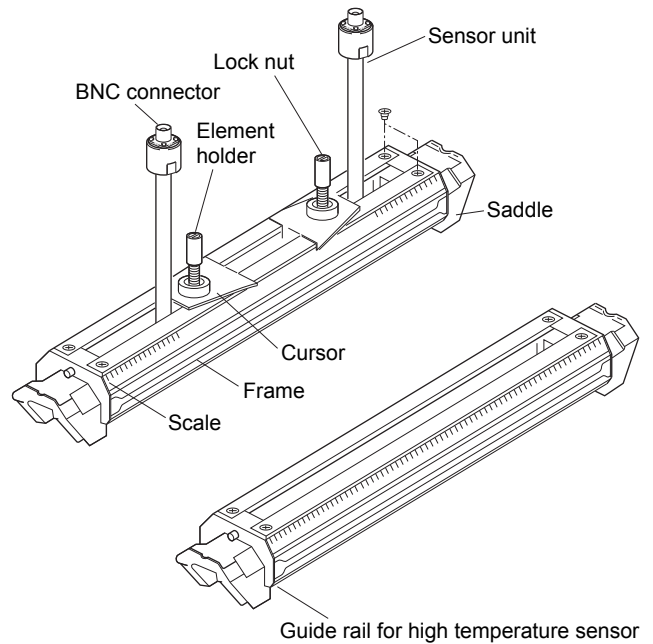

- (2) Mount the removed sensor unit on the guide rail for high temperature sensor. Fasten the sensor unit with mounting dimension (L).

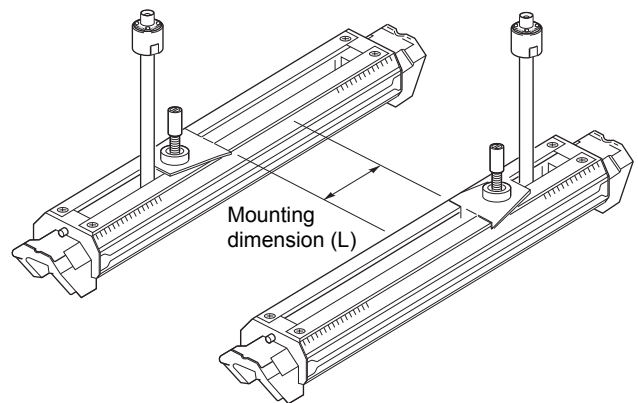

- (3) Spread high-temperature grease over the whole transmitting surface of the sensor.

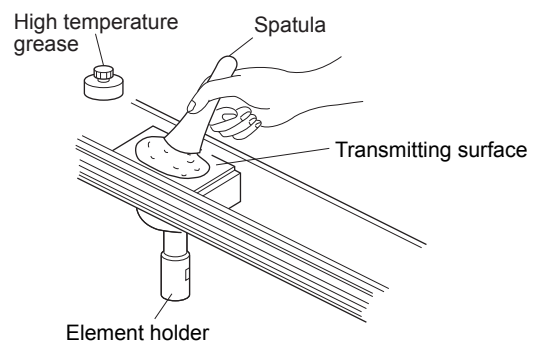

Turn the element holder counterclockwise to return the sensor.
After cleaning the surface of the pipe, the sensor should be mounted.

- (4) Mount each sensor individually on the marking line.

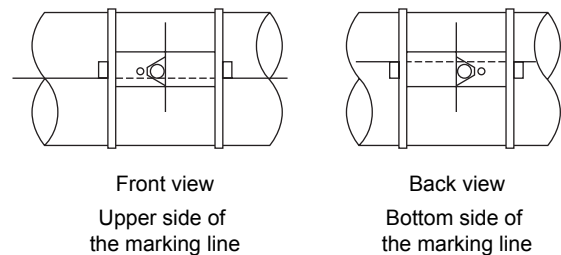

-
- (5) Make sure that the sensor is mounted in parallel with the piping and that the mounting position is correct. Then, turn the element holder clockwise until the sensor is firmly fitted to the piping. Stop turning the element holder where the transmitting surface contacts the surface of pipe, and thus the element holder will not rotate. Do not turn it excessively.

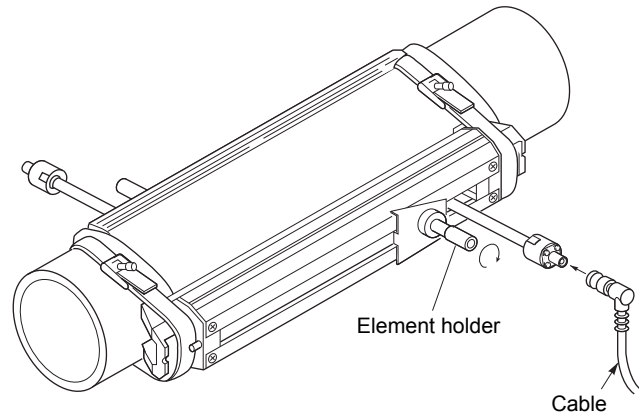

8.9 How to fold gage paper (used for determining mounting position)

- (1) Prepare a sheet of paper (vinyl sheet) of 4 D or more in length and 200 mm or longer in width (D is preferable) as shown below.
- (2) Draw a line intersecting at right angles with the longest sides about 100 mm from one paper end.

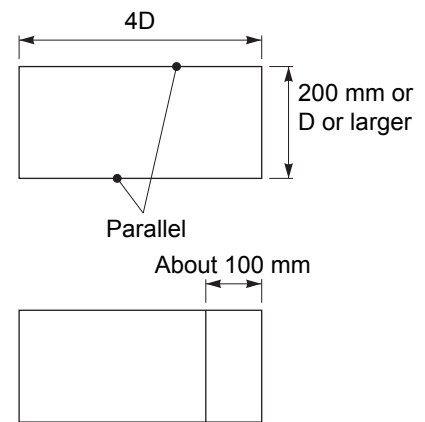

9. START MEASURING

When wiring, piping settings and mounting of the sensor are completed, start the measurement. The contents displayed on the measurement screen are as follows.

- On the measurement screen, instantaneous flow, instantaneous flow velocity, integrated flow rate, analog output, and analog input are displayed. Of the 3 stages displayed on the MEASURE screen, contents can be arbitrarily allocated. Allocation is accomplished by selection of “measurement kind (flow rate, velocity, total, etc.)”. If the flow rate is displayed when water flow stops, refer to page 72, “ZERO ADJUSTMENT” and page 78, “CUT OFF”. If the flow display fluctuates, refer to page 76, “DAMPING”.
- Integrated flow rate value is available in the range from 0000000000 to 9999999999. If the value exceeds 9999999999, it returns to the preset value.
- Move the cursor on the measurement screen using the \blacktriangle , \blacktriangledown , \blacktriangleleft and \blacktriangleright keys.

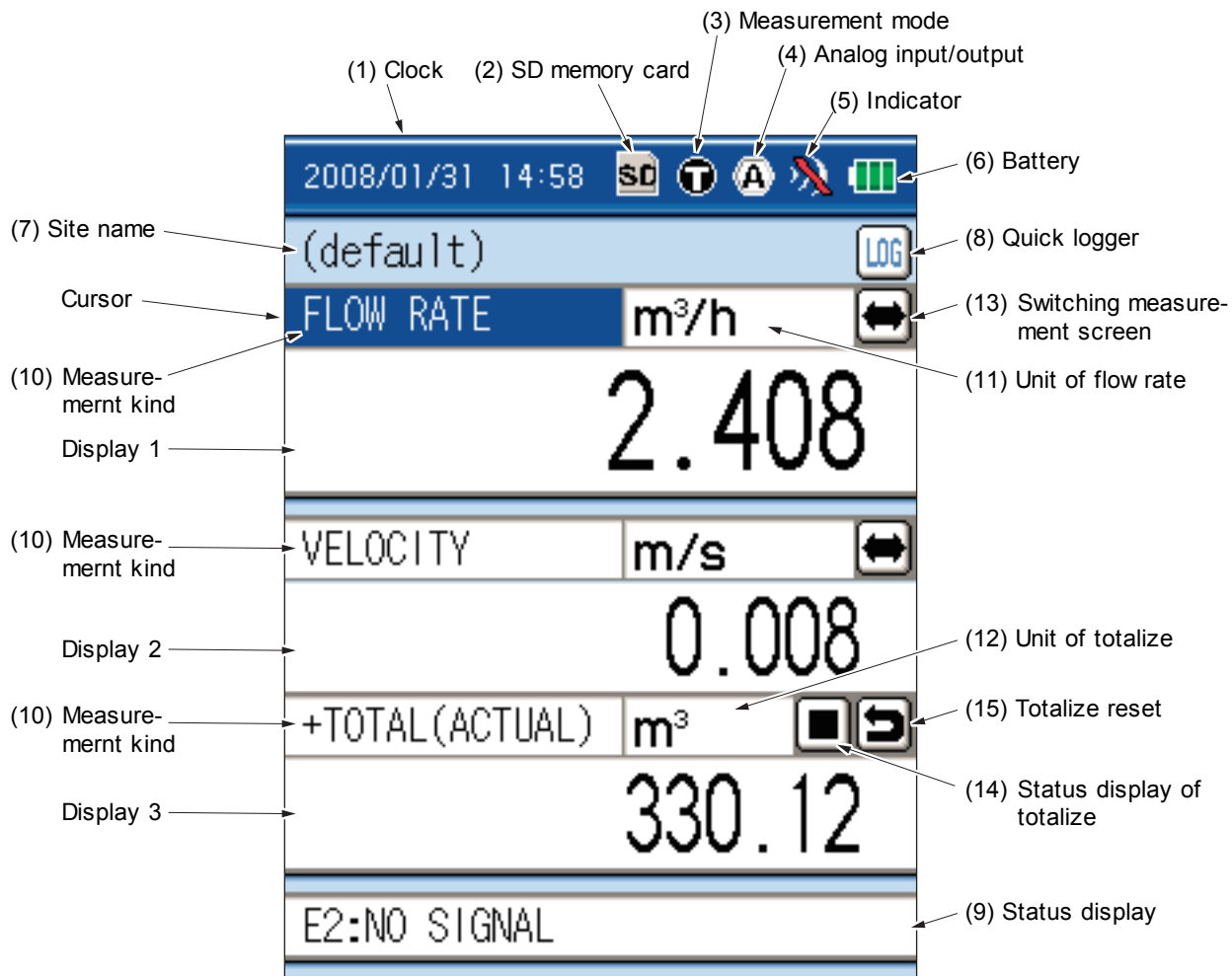

(1) Clock

This instrument has a timer function. Refer to “10.3.1(1) Clock” function to set the time. The timer function should be used based on this clock.

(2) Memory card

Displays the memory card loading status.

 : When the memory card is not set.

 : When the memory card is set.

 : When the memory card is filled up

 : When the memory card is write protected.

 : When the memory card is write-protected and being filled up.

(3) Measurement mode

Displays the current measurement mode.

 : Measured by the transit time method.

Indication at heat quantity measurement (icon color indicates the status).

• Black: No heat quantity measurement (Example: )

• Blue: Heat quantity measurement, cooling operation (Example: )

• Red: Heat quantity measurement, heating operation (Example: )

For measuring heat flow, refer to “10.3.3 ENERGY MODE” function.

(4) Analog input/output

Display the usage state of analog input and output.

For using analog input or output, refer to “10.3.2 analog input/ output” function.

 : Analog input/output valid

 : Analog input/output invalid

(5) Indicator

Shows the intensity of ultrasonic receiving signal. Displays with 4-level.

If the signal is weak, refer to “7.12 Transmission voltage” and raise the transmission voltage level.

 : With signal (max.)

 : With signal

 : Signal decay

 : Without signal

(6) Battery status

Displays the remaining charge of battery.

For charging the built-in battery, refer to (1) Energizing with built-in battery in “5.1 Operating power supply”.

 : Charged

 : Battery level 2

 : Battery level 1

 : Battery shortage } It is recommended to charge the internal battery.

(7) Site name

Displays the name of the operated site.

(8) Quick logger

Logger can be started from the measurement screen. For logger function by timer operation, refer to “10.2.3 LOGGING”.

Note) It cannot be started during data logging.



: Logger started



: Logger stopped



: Cannot be started

(9) Status display

Displays the current status. In case more than one error is displayed, the  is indicated at the far right.

Check if “NORMAL” is displayed. If the sensor is not connected, other messages may be displayed. This is not an error.





In case another message is displayed after installing and connecting the sensor, take corrective actions according to page 146, “10.8 Contents of error in status display”.

If “NORMAL” is not displayed when 1 or less indicator is display, refer to page 153, “12.3 Error in measured value”.

(10) Kind of measurement

When changing the kind of measurement on the measurement screen:

Flow rate, velocity, total display can be changed on the measurement screen.



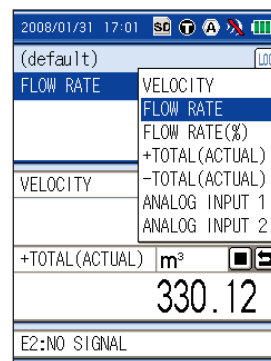



- Move the cursor to the measurement screen to be changed.
- Press the  key, and the screen appears, enabling the kind of measurement to be selected. Select any kind of measurement by the  or  key and then press the  key.



(11) Flow rate

When changing the flow rate on the measurement screen:

Unit of flow rate may be changed on the measurement screen.

- Move the cursor to the unit of flow rate to be changed.
- Pressing  or  key, move the cursor to the unit of flow rate you want to change.
- Press the  key, and the screen appears, enabling the unit of flow rate to be selected. Select any unit by pressing the  or  key and then press the  key.

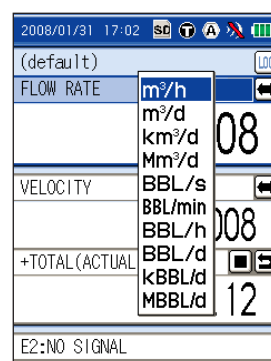

(12) Unit of total

When changing the unit of total, refer to “UNIT OF OUTPUT”.

(13) Changing decimal position

Decimal place can be changed.

Decimal position can be changed on the measurement screen.

- For modification method, move the cursor by pressing \downarrow or \uparrow key.
- Move the cursor to the both ends of numeric by pressing \leftarrow or \rightarrow key ($\leftarrow 000.000 \rightarrow$).
- Press the ENT key, the decimal position can be changed. (The ends of cursor color will thicken up)
- Pressing \leftarrow or \rightarrow key, select the changing position, and then press the ENT key.

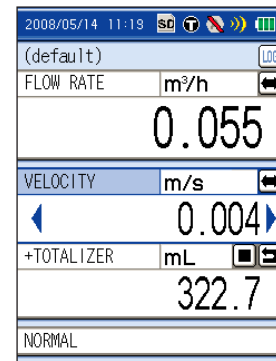

Changing decimal position

(14) Switching measurement screens

The measurement value screen can be switched to the measurement graph screen.

Move the cursor to the ENT key and press the ENT key.

The screen switches as shown below.

Follow the same steps described above to return to the previous measurement value screen.

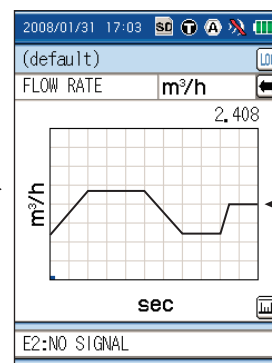
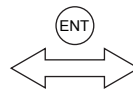
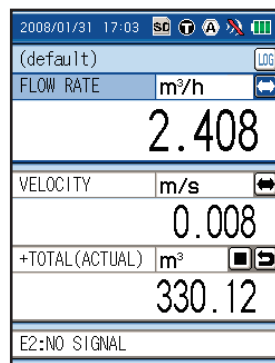

Graph data

If you press the ESC key, the currently displayed graph data is cleared, and the graph display starts again.

Scale setting can be changed on the measurement graph screen.

Move the cursor to the ENT key and press the ENT key.

Select the item by the \uparrow or \downarrow key and press the ENT key to change the setting.

Use the \leftarrow \rightarrow or \uparrow \downarrow key for entering and press the ENT for setting.

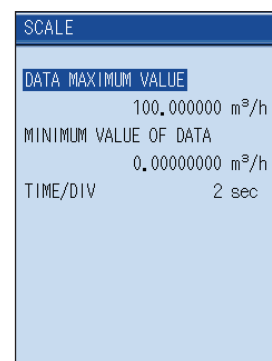
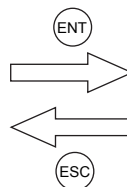
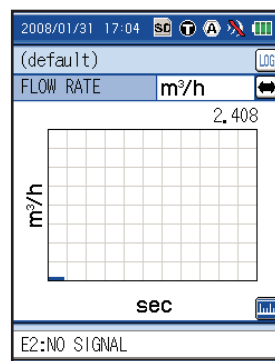

Pressing the ESC key returns to the original status.



(15) Status display of total

It allows you to start/stop the total process on the “MEASUREMENT” screen.

Refer to “10.1.5 TOTAL” about the totalizing function by timer operation.

Move the cursor to the  or  and press the  key.

The total process can be made in the “TOTAL”.

 : START: Totalizing in progress

 : STOP: Not totalized

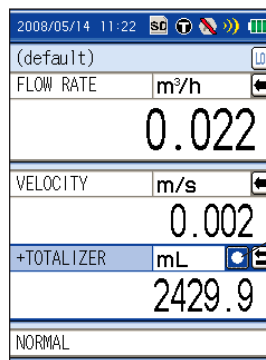



2008/05/14 11:22		SD	⏏	⏏	⏏
(default)		LOG			
FLOW RATE	m ³ /h	↔			
0.022					
VELOCITY	m/s	↔			
0.002					
+TOTALIZER	mL	⏏			
2429.9					
NORMAL					

Start

(16) Total reset

The total value can be set to 0.

Move the cursor to the  and press the  key to reset the total value.

10.SETTING OPERATION (APPLICATION)

This section describes an outline and page configuration of each function page.
 Various function pages are called up from the menu screen.

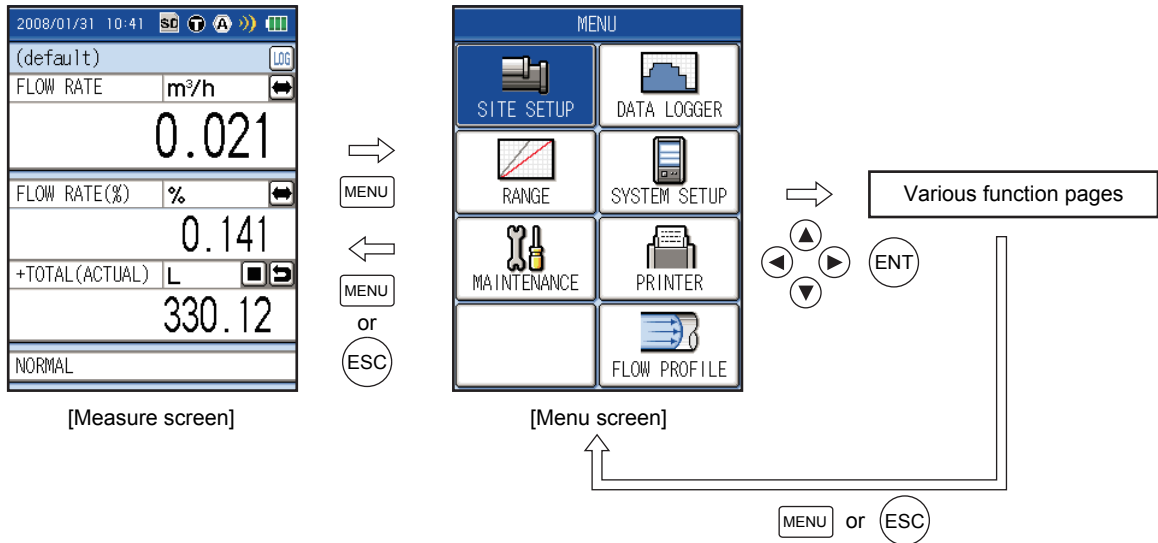

SITE SETUP

Condition settings for measurement

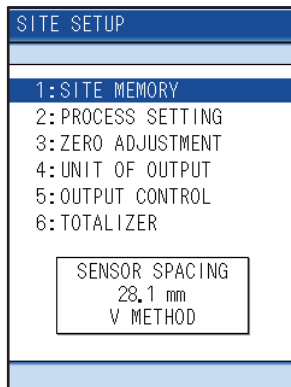

RANGE

Setting of input and output range

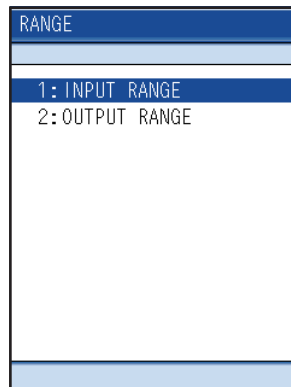

DATA LOGGER

Saving of measured value to memory, and display and output of data

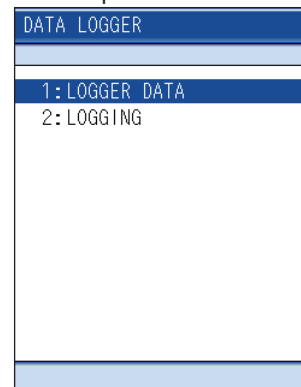

PRINTER

Various outputs on printer

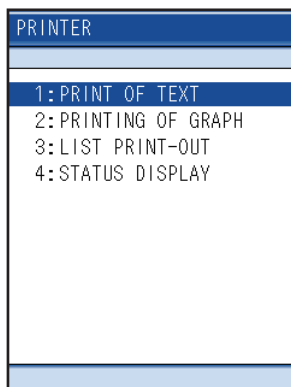

SYSTEM SETUP

Change of basic system settings of main unit

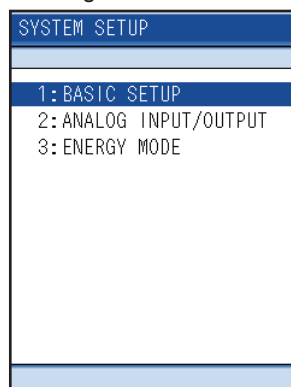

MAINTENANCE

Check function of device status

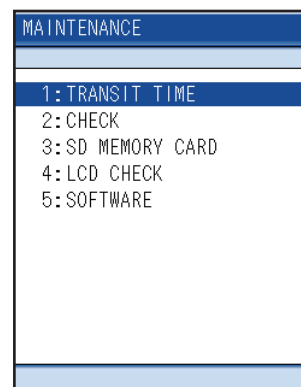

Note) For flow velocity distribution within option, refer to “10.7 Flow velocity distribution display function (option).”

10.1 How to use SITE SETUP function (SITE SETUP page)

10.1.1 SITE MEMORY: when registering data which are set and calibrated on the page

“SITE MEMORY” allows you to register data which are set and calibrated on the “SITE SETUP” page to the memory of the main unit.

When measurements are performed repeatedly in the same pipe, registered data can be loaded to help you in achieving measurements. Up to 32 registrations of data can be made to the memory.

Registration data: Establish setting, zero point adjustment, unit of output, output control.

[Operation]

- (1) Select “SITE MEMORY” by pressing the \blacktriangle or \blacktriangledown key on the “SITE SETUP” page.
Press the ENT key, and the “SITE MEMORY” screen is displayed.
To return to the “SITE SETUP” screen, press the ESC key.

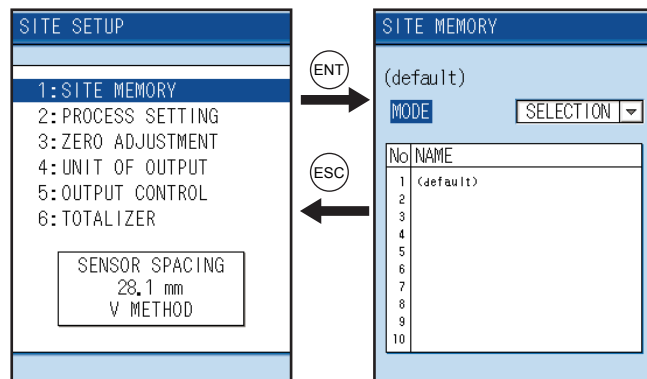

- (2) Move the cursor to “MODE” and press the ENT key. The mode selection screen will appear.
When pressing the ENT key after mode selection, the relevant mode is determined.

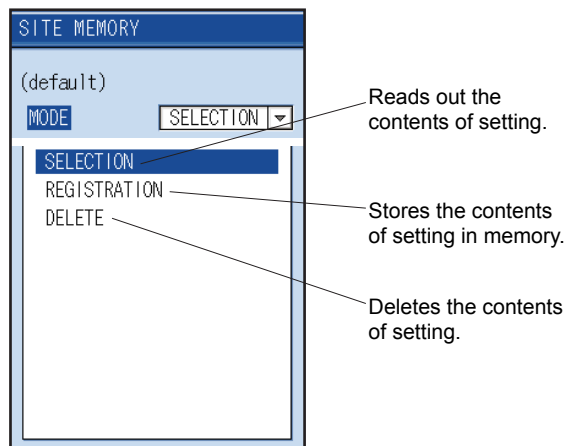

- (3) Select “SELECTION” to read out the data, “REGISTRATION” to register the data and “DELETE” to delete the data.

- For selecting “SELECTION”, select a name of a site by using the cursor and press the (ENT) key. So, this function enables you to load the data.

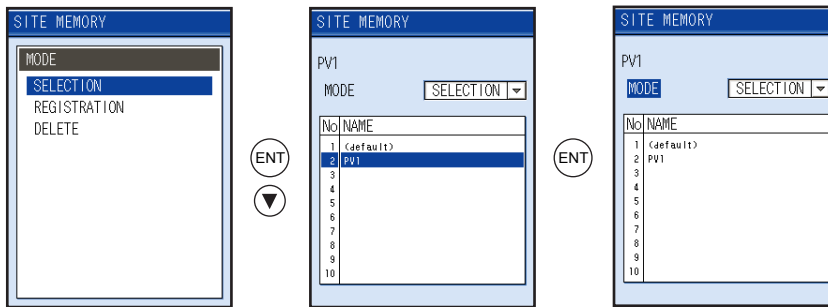

- For selecting “REGISTRATION”, move the cursor to an empty field of NAME and press the (ENT) key. So, this function enables you to register the data you set. Enter the name of the site. (Refer to “7.2 Entry of site name” for details.)

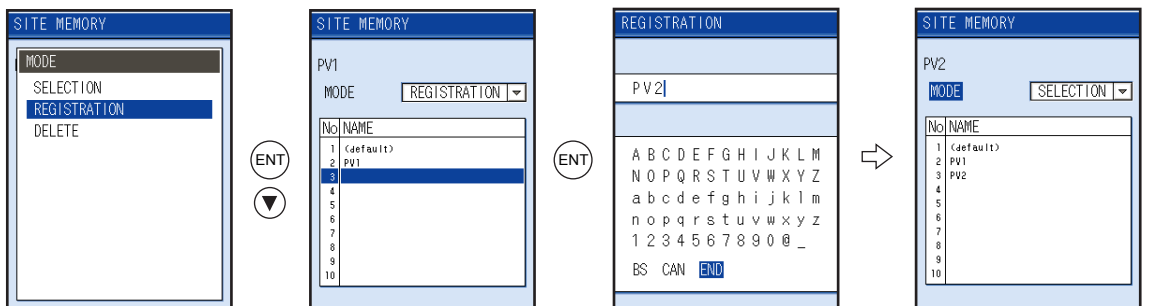

- For selecting “DELETE”, select the name of the deleted site by using the cursor and press the (ENT) key. Select “YES” on the screen and press the (ENT) key. So, this function enables you to delete the data.

Note: Be careful since pressing “YES” deletes the PROCESS SETTING data you registered.

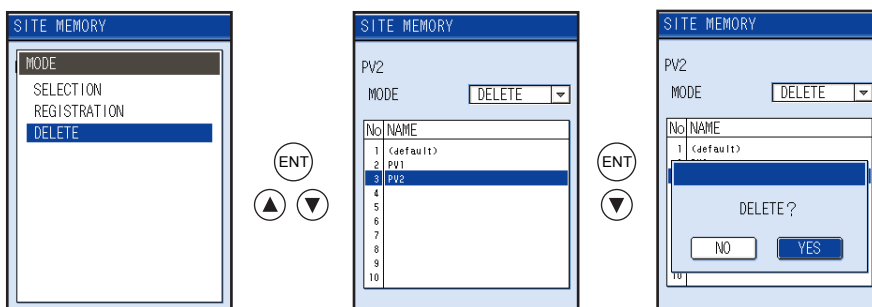

10.1.2 ZERO ADJUSTMENT: when performing zero adjustment

On this screen, zero point is set or cleared.

[Operation]

- (1) Select “ZERO ADJUSTMENT” by the ▲ or ▼ key and press the **ENT** key. The zero adjustment screen will appear.
- (2) Select ZERO ADJUSTMENT, and press the **ENT** key. Zero adjustment to be specified is carried out.
 - **[SET ZERO]**
Perform zero adjustment in situation where the flow is stopped.
The measurement indication should be at zero when the **ENT** key is pressed.
This zero calibration operation should be performed after stopping flow.
 - **[CLEAR]**
Adjustment is cleared.



CAUTION

When PROCESS SETTING or measurement method (page 99) is changed, perform zero adjustment.

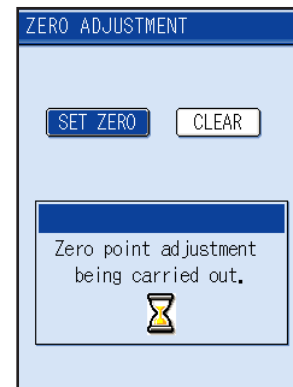
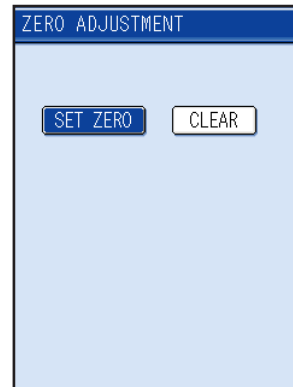
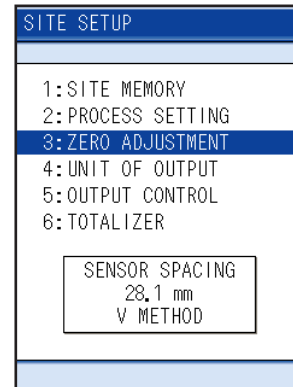

10.1.3 UNIT OF OUTPUT: when changing unit of each output

This function enables you to set unit of flow rate, total, temperature and total heat quantity.

Flow rate unit: Select the unit of flow rate and output range.

Metric system: L/s, L/min, L/h, L/d, kL/d, ML/d, m³/s, m³/min, m³/h, m³/d, km³/d, Mm³/d, BBL/s, BBL/min, BBL/h, BBL/d, kBBL/d, MBBL/d

English system: gal/s, gal/min, gal/h, gal/d, kgal/d, Mgal/d, ft³/s, ft³/min, ft³/h, ft³/d, kft³/d, Mft³/d, BBL/s, BBL/min, BBL/h, BBL/d, kBBL/d, MBBL/d

Flow rate total: Select the unit of flow rate.

Metric system: mL, L, m³, km³, Mm³, mBBL, BBL, kBBL

English system: gal, kgal, ft³, kft³, Mft³, mBBL, BBL, kBBL, ACRE-ft

Temperature: Select the unit of temperature input.

Metric system: °C, K

English system: F, K

Heat flow: Select the unit of heat flow and output range.

MJ/h, GJ/h, BTU/h, kBTU/h, MBTU/h, kWh, MWh

Thermal total: Select the unit of total thermal.

MJ, GJ, BTU, kBTU, MBTU, kW, MW

Note) For the change of SYSTEM UNIT, refer to “10.3.1(2) SYSTEM UNIT”.

Direction of selected unit

	Display	Logger	Printer
Flow rate unit	<input type="checkbox"/>	<input type="radio"/>	<input type="radio"/>
Flow rate total	<input type="radio"/>	<input type="radio"/>	<input type="radio"/>
Temperature	<input type="radio"/>	<input type="radio"/>	<input type="radio"/>
Heat flow	<input type="radio"/>	<input type="radio"/>	<input type="radio"/>
Thermal total	<input type="radio"/>	<input type="radio"/>	<input type="radio"/>

○: The unit selected by the unit of output is used.

☐: The unit selected by measurement screen is used.

[Operation]

- Press the ▲ or ▼ key on the SITE SETUP page and select “UNIT OF OUTPUT”. Then, press the ENT key.

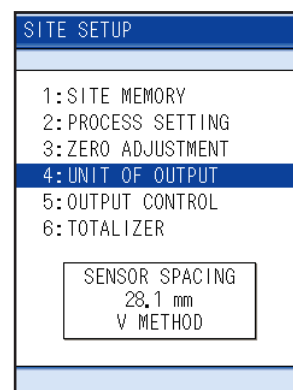

-
- (2) Press the \blacktriangle or \blacktriangledown key and move the cursor to the output item of which unit to be changed.

UNIT OF OUTPUT

FLOW UNIT	L/d
TOTAL UNIT	mBBL
TEMPERATURE	°C
THERMAL FLOW UNIT	kBTU/h
TOTAL UNIT(THERMAL)	BTU

- (3) Press the ENT key to open the unit selection screen. Select the unit by the \blacktriangle or \blacktriangledown key and then press the ENT key.

UNIT OF OUTPUT

FLOW UNIT
L/s
L/min
L/h
L/d
kL/d
ML/d
m³/s
m³/min
m³/h
m³/d

10.1.4 OUTPUT CONTROL: when controlling measured value (output control function)

This function enables you to set the value of damping, output calibration and low flow rate cut off.

[Operation]

- (1) Press the ▲ or ▼ key on the “SITE SETUP” page and select “OUTPUT CONTROL”. Then, press the ENT key and the OUTPUT CONTROL screen is displayed.

SITE SETUP	
1: SITE MEMORY	
2: PROCESS SETTING	
3: ZERO ADJUSTMENT	
4: UNIT OF OUTPUT	
5: OUTPUT CONTROL	
6: TOTALIZER	
SENSOR SPACING 28.1 mm V METHOD	

- (2) Press the ▲ or ▼ key and move the cursor to the item of which output control setting to be changed, and then press the ENT key.

OUTPUT CONTROL	
DAMPING	5.0 sec
CALIBRATION ZERO	0.000 m/s
CALIBRATION SPAN	100.00 %
CUT OFF	0.000 m/s

For details of output control, refer to the items described in the following pages.

- For damping, refer to (1) “DAMPING”: when attenuating the variation of measured value.
- For output calibration, refer to (2) “OUTPUT CALIBRATION”: when calibrating measured value.
- For low flow rate cut, refer to (3) “CUT OFF”: output cut off at low flow rate.

(1) "DAMPING" : when changing output response

Used for attenuating the variation of measured value.
A time constant is set. (Response time of about 63%)
Settable range: 0.0 to 100.0sec in 0.1 sec steps

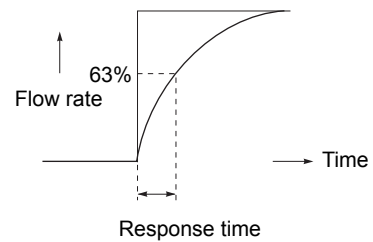

[Operation]

- (1) Press the \blacktriangle or \blacktriangledown key on the OUTPUT CONTROL screen and select "DAMPING". Then, press the ENT key, and the cursor moves to the set item, enabling you to set the response time.

OUTPUT CONTROL	
DAMPING	5.0 sec
CALIBRATION ZERO	0.000 m/s
CALIBRATION SPAN	100.00 %
CUT OFF	0.000 m/s

- (2) Move the digit by pressing the \blacktriangleleft or \blacktriangleright key and enter numeric values by using the \blacktriangle or \blacktriangledown key. After entry, press the ENT key for setting.

OUTPUT CONTROL	
DAMPING	005.0 sec
CALIBRATION ZERO	0.000 m/s
CALIBRATION SPAN	100.00 %
CUT OFF	0.000 m/s

(2) OUTPUT CALIBRATION ZERO/SPAN: when calibrating measured value (output calibration function)

This function enables you to set correction values.

[Settable range of zero point:
-5.000 m/s to 5.000 m/s]
[Settable range of span:
10 to 200%]

Calculation of output value

$$\text{Measured value} \times \frac{\text{Set span value}}{100} + \text{Set zero-point value} = \text{Output value}$$

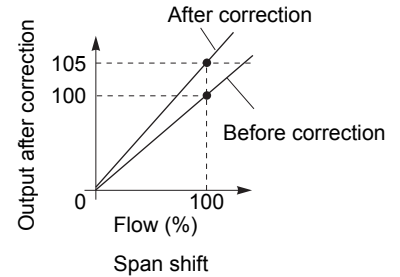
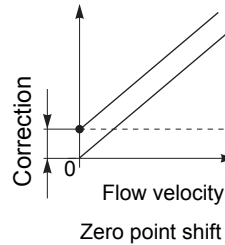

[Operation]

- Press the \blacktriangle or \blacktriangledown key on the OUTPUT CONTROL screen and select “CALIBRATION ZERO” or “CALIBRATION SPAN”. Then, press the ENT key, and the cursor moves to the set item, enabling you to make zero/span setting.

OUTPUT CONTROL	
DAMPING	5.0 sec
CALIBRATION ZERO	0.000 m/s
CALIBRATION SPAN	100.00 %
CUT OFF	0.000 m/s

- Press the \blacktriangleleft or \blacktriangleright key to move the digit, and use the \blacktriangle or \blacktriangledown key to enter a numeric value. After entry, press the ENT key for setting.

OUTPUT CONTROL	
DAMPING	5.0 sec
CALIBRATION ZERO	+0.00 m/s
CALIBRATION SPAN	100.00 %
CUT OFF	0.000 m/s

! CAUTION

As output is corrected, measured value changes.

It is recommended to set as follows unless correction is required.

Zero point: 0.000 m/s

Span point: 100.00%

(3) CUT OFF: output cut off at low flow rate (low flow cutoff function)

When flow rate is extremely low, its output can be cut off. (range: 0 to 5.000 m/s)
If fluid in the pipe is moving due to convection, etc., even though the valve is closed, this flowmeter outputs a measured value. Therefore, values below an appropriate level should be cut off.

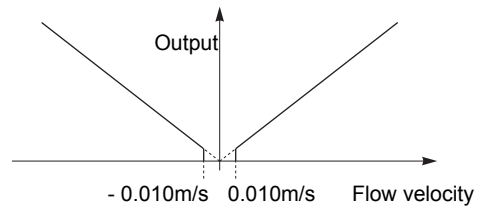

[Operation]

- (1) Press the \blacktriangle or \blacktriangledown key on the OUTPUT CONTROL screen and select "CUT OFF". Then, press the ENT key, and the cursor moves to the set item. Output cut off point is settable.

OUTPUT CONTROL	
DAMPING	5.0 sec
CALIBRATION ZERO	0.000 m/s
CALIBRATION SPAN	100.00 %
CUT OFF	0.000 m/s

- (2) Move the digit by pressing the \blacktriangleleft or \blacktriangleright key and enter a numeric value by pressing the \blacktriangle or \blacktriangledown key. After entry, press the ENT key.

OUTPUT CONTROL	
DAMPING	5.0 sec
CALIBRATION ZERO	0.000 m/s
CALIBRATION SPAN	100.00 %
CUT OFF	0.00 \blacksquare m/s

10.1.5 TOTALIZER: when performing the total process of measured data (totalize)

Total process and setting of total output can be performed.

To set the Total start/stop, there are two modes that Quick logger operated from the Measurement screen and setting from Menu Screen, operation from Measurement screen is given priority.

(1) Total start/stop from Menu screen

[Operation]

- (1) Select "TOTALIZER" on the SITE SETUP screen by pressing the \blacktriangle or \blacktriangledown key.
Press the ENT key to display the total output selection screen.

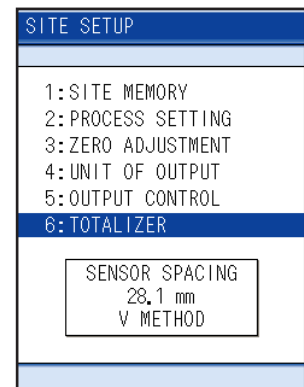

- (2) Pressing the ENT key enables you to select the total output mode.
Select the mode from MANUAL, FIXED TIME, and TIMER by pressing the \blacktriangle or \blacktriangledown key.
(For details of MODE, refer to description of the mode in the following page.)

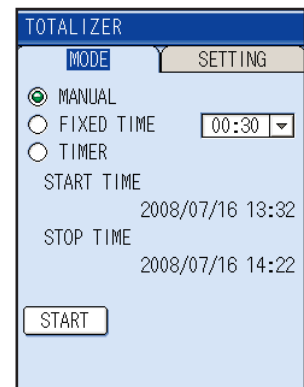

- (3) Move the cursor to "START" by the \blacktriangle or \blacktriangledown key, and then press the ENT key.
The total will start.

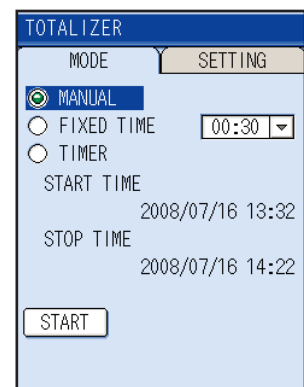

- (4) To stop the total output in the middle, move the cursor to "STOP" and press the ENT key.
"STOP" is also possible from the totalizing calculation display button on the measurement screen.

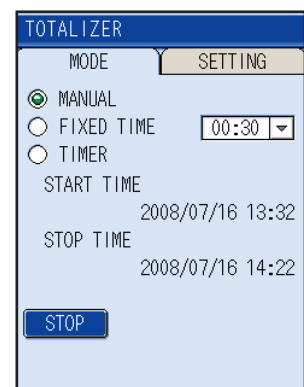

CAUTION

Total will not start unless the cursor is pointed to "START" and the ENT key is pressed.
Even if the timer setting is performed after scheduled Start date may pass than the time of the main unit, total will not be carried out.

Mode Description

“MANUAL” mode:

Instant total starts
Without choosing STOP, total continues.

TOTALIZER

MODE SETTING

MANUAL

FIXED TIME 00:30

TIMER

START TIME
2008/07/16 13:32

STOP TIME
2008/07/16 14:22

START

“FIXED TIME” mode:

Total starts after the time of setting, total is performed within the time selected from the menu, and it stops automatically after the time passed.

- 30min
- 1hour
- 1hour 30min
- 2hour
- 2hour 30min
- 3hour

TOTALIZER

MODE SETTING

FIXED TIME

00:30

01:00

01:30

02:00

02:30

03:00

“TIMER” mode:

Set the time of total to start and stop.
After each time is set, total starts and stops automatically.

TOTALIZER

MODE SETTING

MANUAL

FIXED TIME 00:30

TIMER

START TIME
2008/07/16 13:40

STOP TIME
2008/07/16 14:30

START

(2) To set total output

- (1) Move the cursor to “SETTING” on the TOTAL screen by the ◀ or ▶ key.
Pressing the **ENT** key enables you to select the set item by the ▲ or ▼ key.
Press the **ENT** key to make setting. (See the following.)

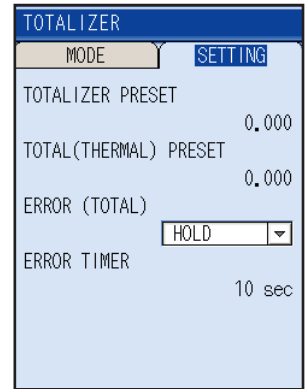

“TOTALIZER PRESET”:

Preset the flow rate total to restart total.
[Settable range: 0.000 to 9999999999]

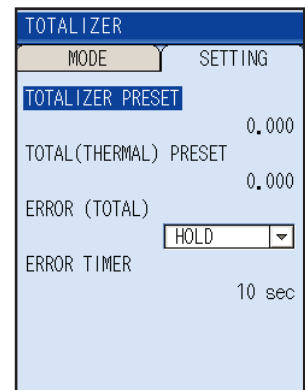

“TOTAL (THERMAL) PRESET”:

Preset the total heat quantity to restart total.
[Settable range: 0.000 to 9999999999]
Resetting actual integral values should be performed on the measurement screen.
(See Page 65)

“ERROR (TOTAL)”:

Determines how to dispose of the total when the measurement status is abnormal on account of an empty pipe interior or bubbles mixed in fluid.
Settable range
HOLD: Stops total (as factory set)
NOT USED: Continues total according to a flow rate marked immediately before the error occurrence.

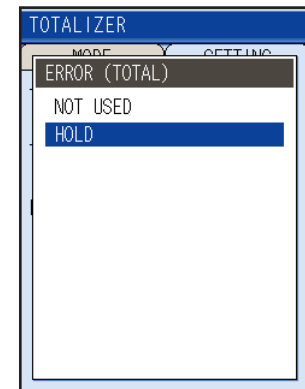

“ERROR TIMER”:

Sets the time from error occurrence to error processing.
[Settable range: 0 to 900sec (factory set: 10sec)]
The total continues until the burnout timer is actuated.

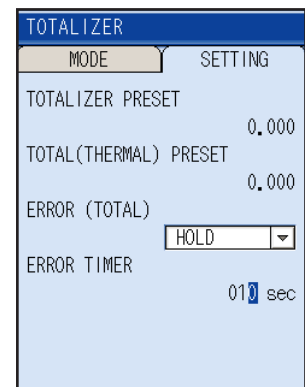

10.2 Setting of data logger function

This function allows you to save measured values to the SD memory card, call the measured data saved in the memory after measurement is completed, display, and produce output of data on a printer.

Recording capacity: Depends on capacity of the SD memory card.

(1) How to view data logger

Call the logged measurement data, make the setting on graph display and print output.

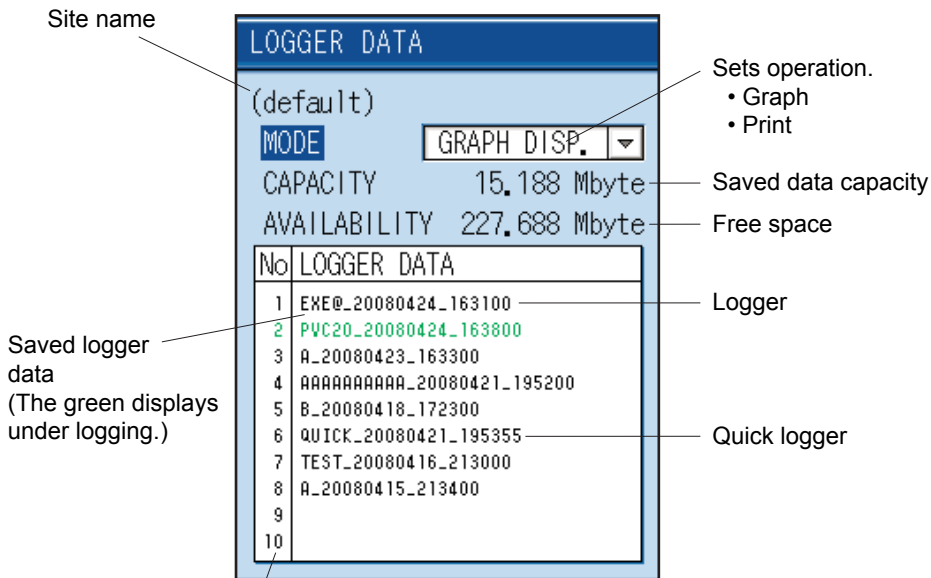

Up to 100 items can be viewed by using the cursor.
For 100 or more, check SD memory card directly by your PC.

(2) How to view logging screen

This is the screen to set the stored file name, kind of measurement data and operation mode which is stored to SD memory card.

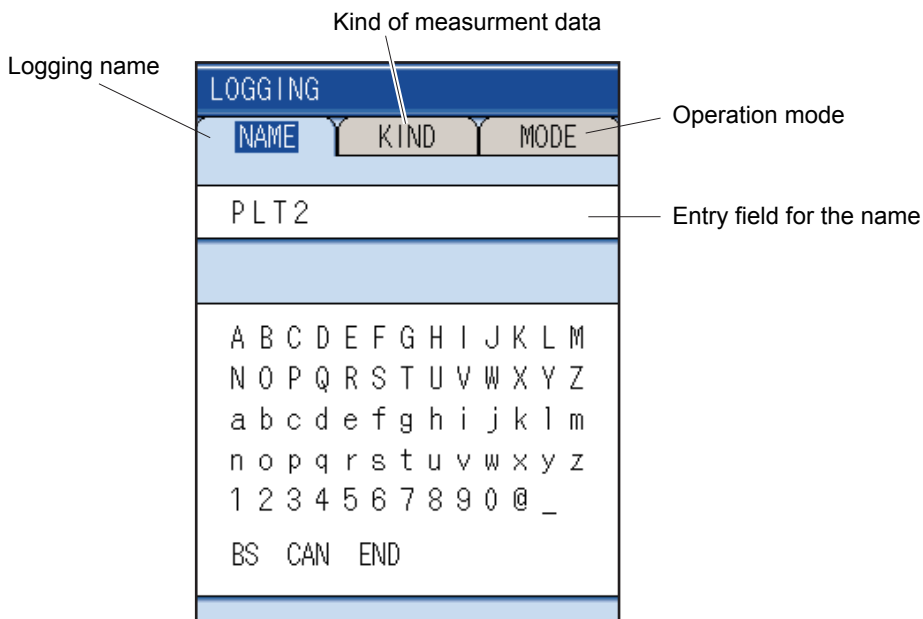

10.2.1 “Logger Operation” mode

There are two logging modes, i.e., quick logger that permits operation from the measurement screen and logger that is set from the menu screen. Logger is of two different modes, i.e., “CONTINUOUS” mode and “SET TIME” mode.

- Quick logger
- Logger
 - (1) “CONTINUOUS” mode
 - (2) “SET TIME” mode

Logger data will be stored at the selected site name in the Site Memory.

(1) Quick logger

The quick logger starts when quick logger start button  in the measurement screen is pressed. When memory card is not inserted, cursor does not move to function button.

The quick logger exits when a period of an hour has elapsed since it was started or when quick logger stop button is pressed.

- Logging time: 1 hour, fixed
- Cycle: 10 seconds, fixed
- Measured data type: 3 types (unit and number of digits after decimal point are the same) displayed in measurement screen and status display
In the case of 3-line or 2-line display, only the flow rate on the first line is stored.

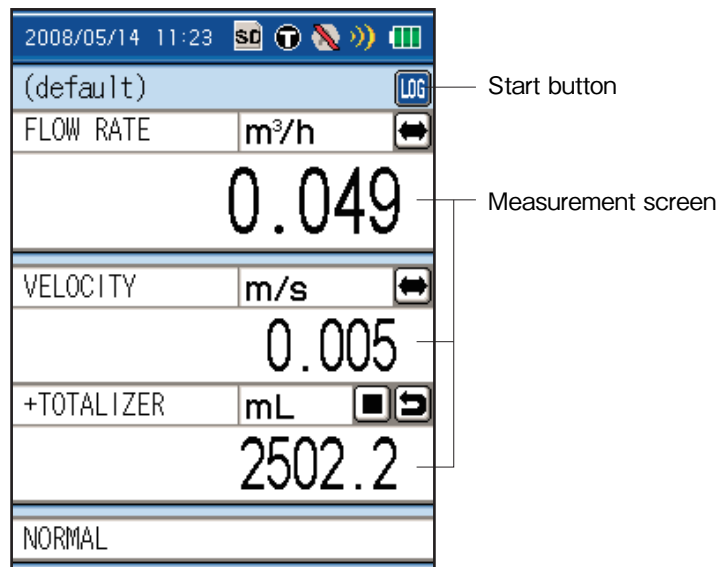

(2) Logger

(1) “CONTINUOUS” mode

“CONTINUOUS” mode is the mode to perform logging in a fixed period from start date and time to exit date and time.

Exit occurs upon elapse of exit date and time or when the stop button is pressed. As the exit time varies by the start time and period, there are cases where it is different from the set exit time.

- Logging time: Start date and time to exit date and time
- Cycle: 10 seconds to 24 hours
- Measured data type: 14 measured data types and status display

Example) Case of setup of logging from 9/1 9:00PM to 9/8 4:00AM

- Start date and hour: 2008/09/01 21:00
- Exit date and hour: 2008/09/08 04:00

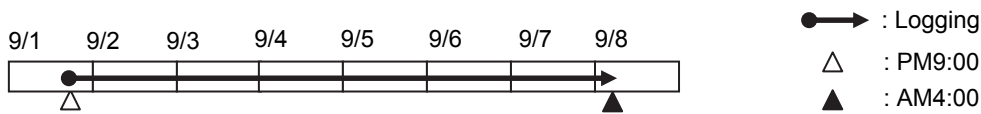

(2) “SET TIME” mode

“SET TIME” mode is the mode to perform logging in a fixed period only during a certain time zone of a day between the start date and exit date.

Exit occurs upon elapse of exit time of exit period or when the stop button is pressed. As the exit time varies by the start time and period, there are cases where it is different from the set exit time.

The difference between start time and exit time is one hour at minimum. If the start time is earlier than the exit time, logging is performed over 0 o'clock.

- Logging period: Start date to exit date
- Logging time: Start time to end time
- Period: 10 seconds to 23 hours
- Measured data type: 14 measured data types and status display

Example) Case of setup of logging for one week from 9/1, from 9:00PM to 4:00AM

- Period: 9/1 to 9/8
- Start date and hour: 21:00
- Exit date and hour: 04:00

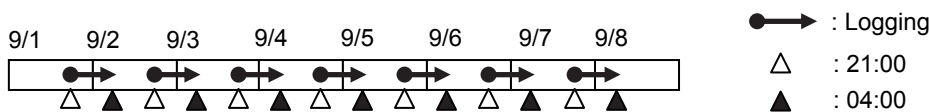

(3) Measured data type

The measurement data is following 14kind.

- VELOCITY
- FLOW RATE
- FLOW RATE (%)
- +TOTALIZER
- TOTALIZER
- AI CHANNEL 1
- AI CHANNEL 2
- SUPPLY TEMP.
- RETURN TEMP.
- TEMP DIFFERENCE
- THERMAL FLOW
- THERMAL FLOW (%)
- +TOTAL (THERMAL)
- TOTAL (THERMAL)

Note 1) Range of specified time in a day : 00:00 to 23:59 (24:00 input results in error)

Note 2) In case START TIME of logging already passed, logging will start right away when you conduct the start of logging regardless of START TIME.

Note 3) “Quick logger”, “CONTINUOUS” mode and “SET TIME” mode in use are given priority, other modes will be invalid.

Display on the Measurement screen is shown as following.

- At the time “Quick logger” is activated: Characters of **LOG** sign will be displayed red.
- At the time “CONTINUOUS” mode / “SET TIME” mode is activated: Slash mark on **LOG** sign will be displayed.

10.2.2 Logger data file format

One logger file is composed of files of two types indicated below. The data file is stored as divided by 65,500 lines for permitting high-speed access and due to restrictions in the maximum number of lines of CSV display of Microsoft Excel.

File type	File name	Remarks
Configuration file	(Logging name)_(date)_(hour).ini	Means logger start time and relevant logger data files.
Data file	(Logging name)_(date)_(hour).csv	Logging data in a specific period

The maximum number of data files in a logger is 20 files in case of a “CONTINUOUS” logger, and is 550 files in case of a ”SET TIME” logger. The appointed time logger is of one file per day.

Note) After reaching the maximum data file, the logging will be stopped.

The logger data list shows the following names excluding extension (.ini) of logger configuration files.

- Logger ... “Logger name_(start date)_(start hour)”
- Quick logger ... “QUICK__(start date)_(start hour)”

If capacity shortage arises during logging operation, logging operation stops with the following screen displayed.

When this screen appears, replace the SD memory card immediately.

Press the **(ESC)** key, or remove SD memory card, the message will be cleared.

Move the cursor to “STOP” to stop logging, press the **(ENT)** key, and once remove the memory card.



10.2.3 LOGGING: when logging (recording) measured data

“LOGGING” only sets logging conditions.
To start logging, follow the steps (2) to (8) given shown below.

[Operation]

- (1) Press the ▲ or ▼ key on the LOGGING screen to select “LOGGING” and press the ENT key.

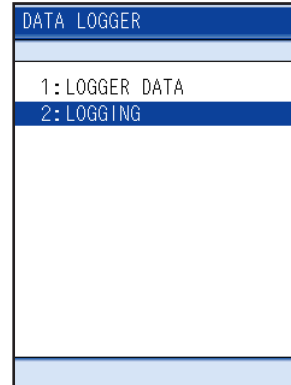

- (2) Register the name of the logger.
Press the ENT key after the cursor is placed in the “NAME”.
The cursor moves to the character entry field.

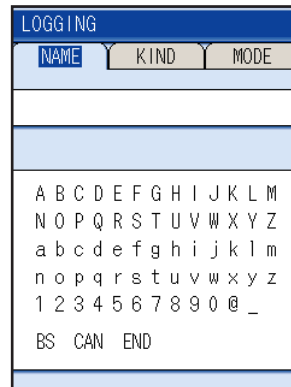

- (3) Register the place or the pipe name for logging.
Refer to Page 24 and 25 to enter characters.

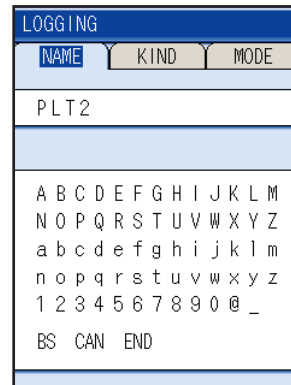

- (4) Select the kind of data to be logged.
Move the cursor pointed from “NAME” to “KIND” by the ► key.
Then, press the ENT key, and the cursor moves to kinds of data.

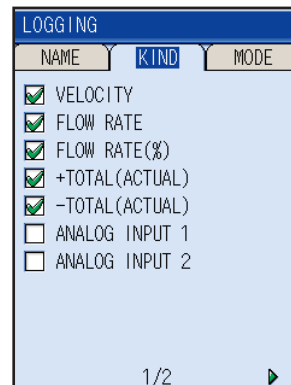

- (5) Select the kind of data by the ▲ or ▼ key and press the **ENT** key so that the selected data will be logged. One or more items are simultaneously selectable. Press the ► key to display kind of data on the second page.

LOGGING		
NAME	KIND	MODE
<input checked="" type="checkbox"/>	VELOCITY	
<input checked="" type="checkbox"/>	FLOW RATE	
<input checked="" type="checkbox"/>	FLOW RATE(%)	
<input checked="" type="checkbox"/>	+TOTALIZER	
<input checked="" type="checkbox"/>	-TOTALIZER	
<input type="checkbox"/>	A1 CHANNEL 1	
<input type="checkbox"/>	A1 CHANNEL 2	

1/2 ▶

- (6) After selection, return the cursor to “KIND” by the **ESC** key.

LOGGING		
NAME	KIND	MODE
<input type="checkbox"/>	SUPPLY TEMP.	
<input type="checkbox"/>	RETURN TEMP.	
<input type="checkbox"/>	TEMP DIFFERENCE	
<input type="checkbox"/>	THERMAL FLOW	
<input type="checkbox"/>	THERMAL FLOW(%)	
<input type="checkbox"/>	+TOTAL(THERMAL)	
<input type="checkbox"/>	-TOTAL(THERMAL)	

◀ 2/2

- (7) Set the logging operation mode. Move the cursor pointed from “KIND” to “MODE” by the ► key.

LOGGING		
NAME	KIND	MODE
	CONTINUOUS.	SET TIME
	START TIME	2008/07/16 14:34
	STOP TIME	2008/07/16 15:24
	INTERVAL	00:00:10
START		

- (8) Press the **ENT** key, and the cursor moves to “CONTINUOUS”. Then, press the ► key to move the cursor to “SET TIME”.

LOGGING		
NAME	KIND	MODE
	CONTINUOUS.	SET TIME
	START TIME	2008/07/16 14:34
	STOP TIME	2008/07/16 15:24
	INTERVAL	00:00:10
START		

⚠ CAUTION

- Do not remove the memory card while data is written in it. Otherwise the logger data can not be read.
- Do not turn the power off during reading the data to memory card. Otherwise the logger data can't be read.

(9) Press the **ENT** key to move the cursor to the set item “CONTINUOUS” or “SET TIME”.

- Setting of “CONTINUOUSNESS”
Sets the start time, the finish time, and the logging cycle.
Move the cursor to “START” and press the **ENT** key to start logging.

LOGGING		
NAME	KIND	MODE
CONTINUOUS.	SET TIME	
START TIME	2008/07/16 14:34	
STOP TIME	2008/07/16 15:24	
INTERVAL	00:00:10	
START		

- Setting of “APPOINT TIME”
Sets the logging period, the start/finish time, and the logging cycle.
Move the cursor to “START” and press the **ENT** key to start logging.

LOGGING		
NAME	KIND	MODE
CONTINUOUS.	SET TIME	
PERIOD	2008/07/16 - 2008/07/16	
START TIME	00:00	
STOP TIME	00:00	
INTERVAL	00:00:10	
START		

CAUTION

- Even if Totalizer is just selected, Totalizer action is not enable when conducting the start of logging.
Be sure to make a setting of Totalizer action according to Item 10.1.5. in this manual.
- In case heat mode is “NOT USED”, it is invalid even if sending temperature and subsequent have been selected.
- If the output unit or system unit was changed after logger start, logging is performed in the unit at the time of start. The changed unit becomes valid after the logger is stopped.
- Start-up is not permitted if the set time is later than the time of the main unit clock. Make sure to set a time with a margin of several minutes after the present time.

10.2.4 “LOGGER DATA”: when checking or printing logged data

(1) When checking logged data on screen

[Operation]

- (1) Press the ▲ or ▼ key on the LOGGER screen, select “LOGGER DATA” and press the (ENT) key.

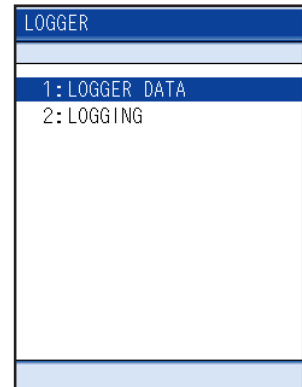

- (2) When the LOGGER DATA screen appears, press the (ENT) key.

Note) Logger data will be stored at the selected site name in the Site Memory.

Thus, when you select the different site name to see the logger data, that logger data will not be shown.

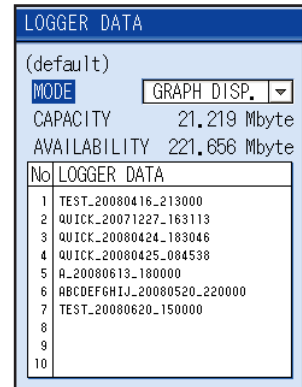

- (3) The MODE screen appears.
Select “GRAPH DISP.” and press the (ENT) key.

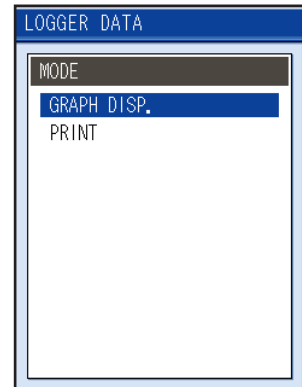

- (4) Select the name (No.) of logger data by pressing the ▲ or ▼ key. and press the (ENT) key. The graph display screen opens.

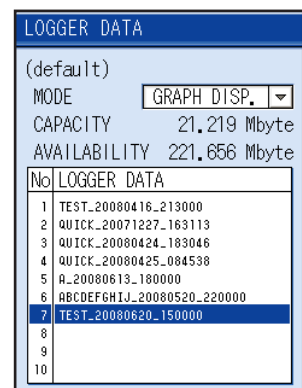

Mode Description

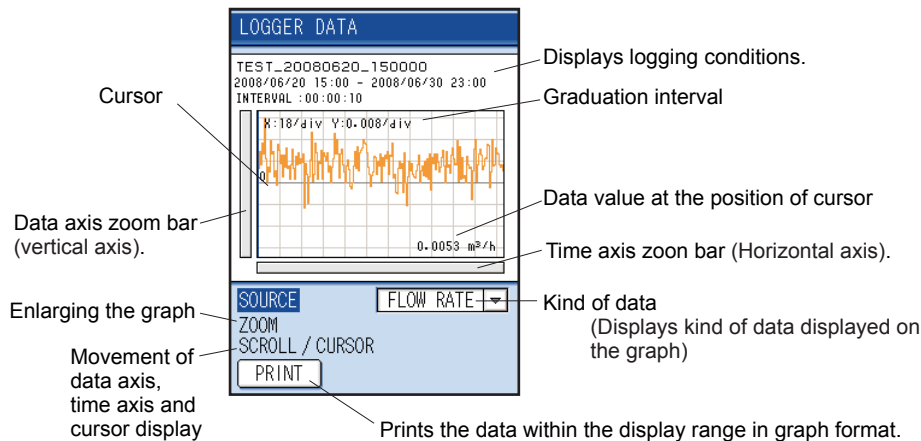

Logging data for up to four screens from the start of logging is displayed. The maximum number of data is 816 data (204 data per screen).

If you check the data after 816, read a SD memory card directly on the PC.

(5) To change kind of data to be displayed:

Move the cursor to “SOURCE” and press the **ENT** key to enter the SOURCE screen. Select the kind of data by pressing the **▲** or **▼** key.

Note) Display only types of logged data.

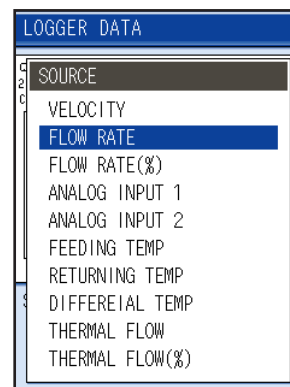
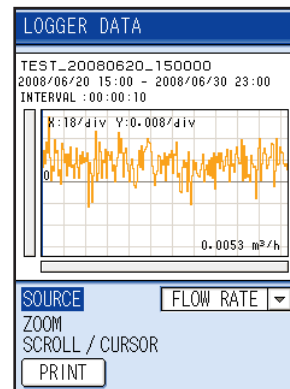

(6) To change scale of time axis (horizontal axis) and data axis (vertical axis):

Move the cursor to “ZOOM” to enlarge or contract the time axis by the **◀** or **▶** key.

Enlarge or contract the data axis by the **▲** or **▼** key.

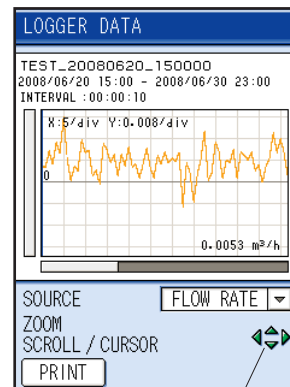

Enlarge/contract

- (7) For moving time axis
 Press ▲ or ▼ key, move the cursor to “SCROLL” and then press the ENT key, SCROLL will be readied.
 For moving time axis, please use ◀ or ▶ key.

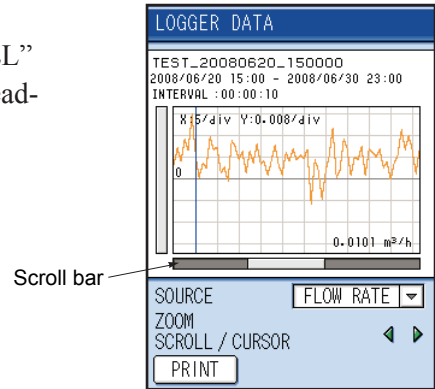

- (8) To display data values of cursor:
 Move the cursor to “CURSOR” by pressing ▲ or ▼ key.
 Move the cursor by pressing the ◀ or ▶ key to display the data value of the time.

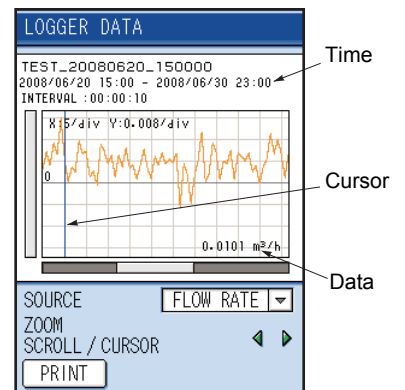

- (9) To print graph:
 Move the cursor to “PRINT” and print a graph by pressing the ENT key.

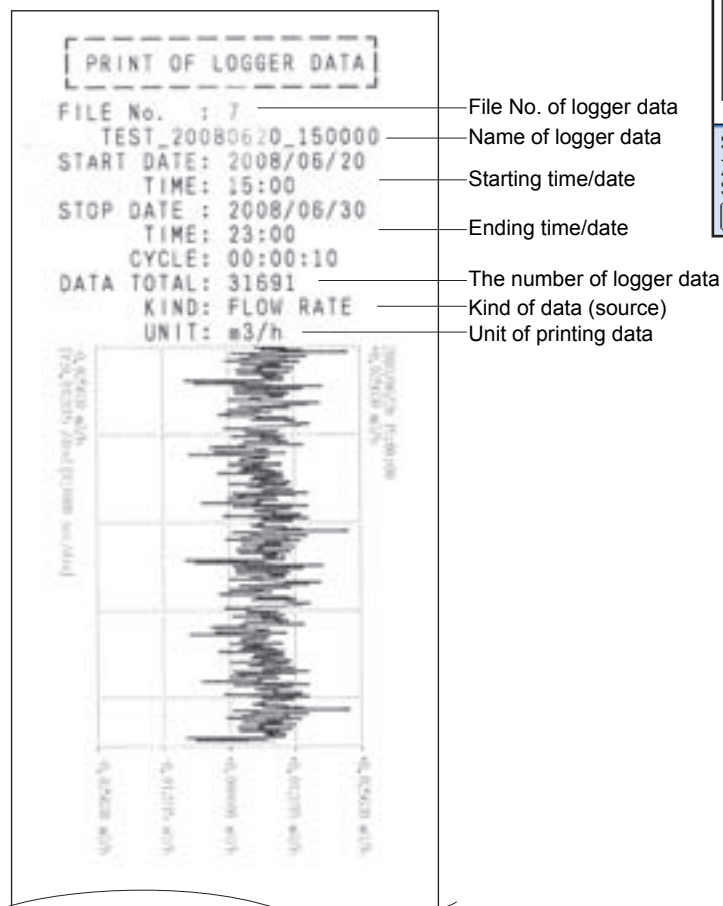
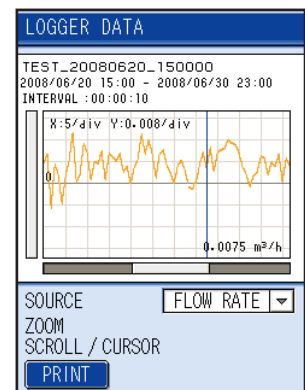

(2) When printing logged data in text

[Operation]

- (1) Press the \blacktriangle or \blacktriangledown key on the LOGGER screen, select “LOGGER DATA” and press the ENT key.
- (2) When the “LOGGER DATA” screen appears, press the ENT key.

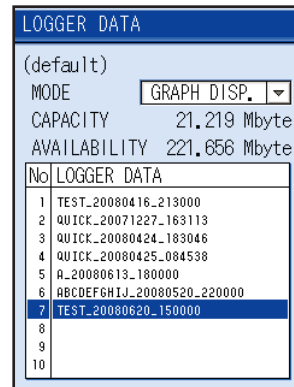

- (3) The MODE screen appears.
Select “PRINT” and press the ENT key.

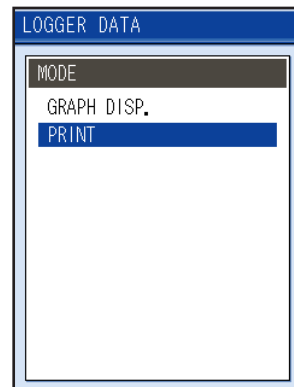

- (4) Press the \blacktriangle or \blacktriangledown key to select the name of logger data (No.) and press the ENT key to display the print-out screen.

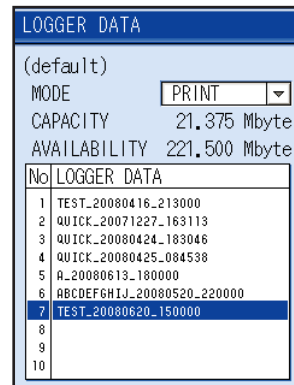

- (5) Set the printing conditions.
Then, move the cursor to “PRINT” and press the ENT key.

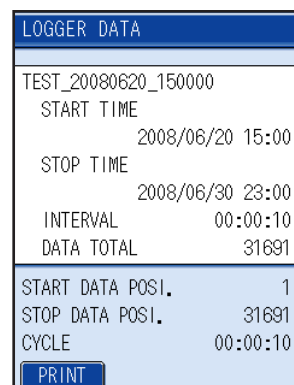

[Example]

22321 data are saved in the “A” logger data every 10 seconds between 2008/06/13 18:00 and 2008/06/16 8:00 (o'clock). The logger data from the 7th (at 18:01) to the 367st (at 19:01) are printed out every 600 seconds.

The screenshot shows a menu titled "LOGGER DATA" with the following items:

- A_20080613_180000
- START TIME 2008/06/13 18:00
- STOP TIME 2008/06/16 08:00
- INTERVAL 00:00:10
- DATA TOTAL 22321
- START DATA POSI. 1
- STOP DATA POSI. 22321
- CYCLE 00:00:10
- PRINT

Annotations on the left side of the menu:

- Name and condition of selected logger data (points to A_20080613_180000)
- Total of logged data (points to DATA TOTAL 22321)
- Printing conditions of logger data above (points to START DATA POSI., STOP DATA POSI., and CYCLE)

Annotations on the right side of the menu:

1. Select "START DATA POSI." and press **ENT**. Change to 7 by the **▲▼** or **◀▶** keys.
2. Select "STOP DATA POSI." and press **ENT**. Change to 361 by the **▲▼** or **◀▶** keys.
3. Select "CYCLE" and press **ENT**. Change to 00:10:00 by the **▲▼** or **◀▶** keys.
4. Select "PRINT" and press **ENT**, and printing is started.

Since the data that can be printed output is up to 10000 data, set “START DATA POSI.” and “STOP DATA POSI.” so that it becomes 10000 data or less.

10.3 Setting of system (SYSTEM SETUP screen)

This system allows you to accomplish the BASIC SETUP (system setup such as setup of clock and measurement unit), the ANALOG INPUT/OUTPUT (analog input setting and input/output calibration) and the ENERGY MODE (setting of mode, operation and temperature).

10.3.1 BASIC SETUP: when setting the system

- (1) Select "BASIC SETUP" on the SYSTEM screen.
Press the **(ENT)** key to display the BASIC SETUP screen.

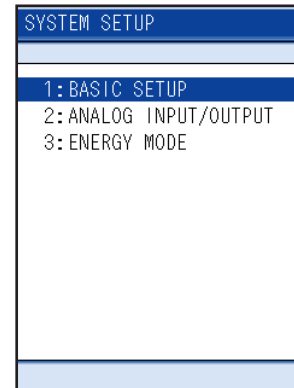

(1) "CLOCK": when setting the clock (set the present time)

- (1) Press the **(▲)** or **(▼)** key on the BASIC SETUP screen and select "CLOCK".
Press the **(ENT)** key, and the cursor moves to "DATE DISPLAY".
Press the **(ENT)** key to display the Date DISPLAY screen.
Select the display of date by the **(▲)** or **(▼)** key, and press the **(ENT)** key.
YYYY: Year
MM: Month
DD: Day

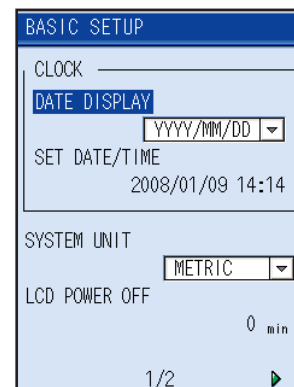
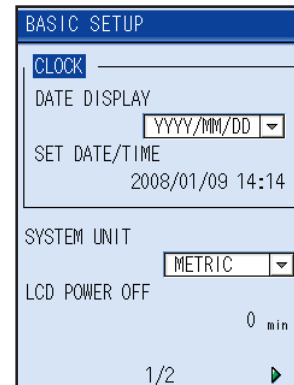

- (2) Move the cursor to SET DATE/TIME by the ▲ or ▼ key and press the (ENT) key so that time and date can be set.
Move the digit by the ◀ or ▶ key and enter numeric values by the ▲ or ▼ key.
After entry, press the (ENT) key.
The setup time is set at this point.

Setup contents

2008/02/01 10:03

(year, month, day, hour, minute)

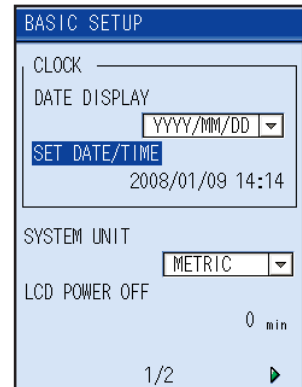
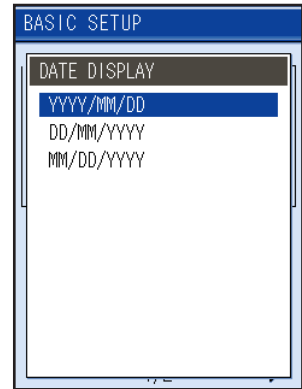

CAUTION

When using the total or the data logger or the timer function of the printer, time setting can not be operated. Stop the timer function, and then set it again.

**(2) SYSTEM UNIT: when setting the measurement and setting unit system
[selection of meter system and inch system]**

[Operation]

- (1) Select “SYSTEM UNIT” by the ▲ or ▼ key on the BASIC SETUP screen.
Press the **(ENT)** key, and the SYSTEM UNIT screen is displayed.

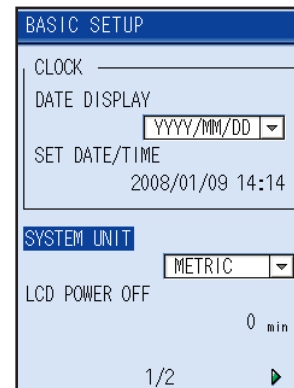

- (2) Select “METRIC” or “ENGLISH” by the ▲ or ▼ key and press the **(ENT)** key.
Note: For using of Inch, please select “ENGLISH”.

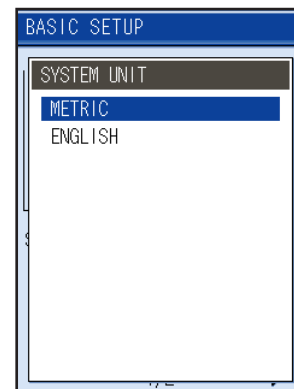

**(3) “LCD POWER OFF”: when setting time for extinguishing LCD.
[To turn off LCD automatically]**

Set the LCD off time (the setting range is from 0 to 30min)

If key operation is not performed, the backlight of the LCD (screen) goes off automatically and then the power of LCD will be OFF. If key operation is performed while the backlight is kept off, it comes on.

If 0 min. is selected for OFF time, the light is kept ON.

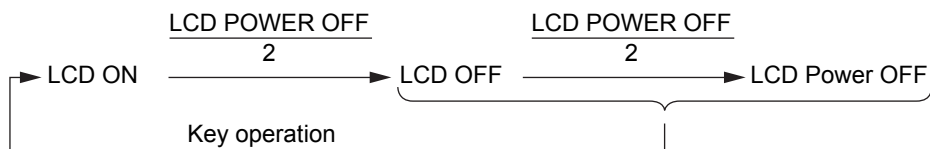

[Operation]

- (1) Press the \blacktriangle or \blacktriangledown key on the BASIC SETUP screen and select “LCD POWER OFF”.
Press the ENT key, and you are ready to set the LCD off time.
- (2) Move the digit by the \blacktriangleleft or \blacktriangleright key and enter numeric values by pressing the \blacktriangle or \blacktriangledown key.
After entry, press the ENT key.

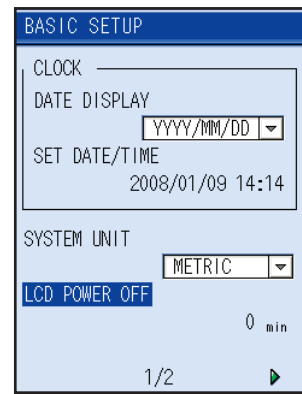

(4) “DEFINITION OF PRINT KEY”: when setting the PRINT key
[To select printer and SD memory]

- PRINTER : Output the screen copy data to the PRINTER
- SD MEMORY : Save the screen copy data to the SD MEMORY.

[Operation]

- (1) Press the \blacktriangle or \blacktriangledown key on the BASIC SETUP screen and select “DEFINITION OF PRINT KEY”.
Press the ENT key to open the DEFINITION OF PRINT KEY selection screen.

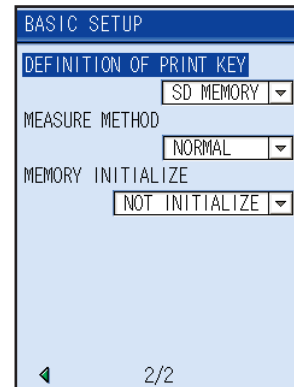

- (2) Select “PRINTER” or “SD MEMORY” by the \blacktriangle or \blacktriangledown key and press the ENT key.

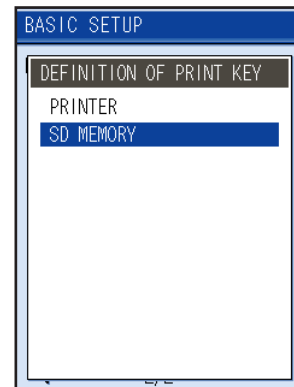

! CAUTION

When the SD MEMORY is selected, display screen capture can be produced and stored in the SD memory as BMP format.
When the printer is selected, print the screen display.

(5) MEASURE METHOD: when changing measurement method

NORMAL is the standard measurement method.

ANTI-DISTURBANCE MODE resists an external disturbance.

If the MODE is not available, change it to the ANTI-DISTURBANCE MODE.

The measurement system is automatically selected according to the kind of sensor or setting of outer diameter. If the ANTI-DISTURBANCE MODE is automatically selected from the beginning, there is no need to switch the method. For the MODE that has been automatically selected, change to the ANTI-DISTURBANCE MODE is possible.

[Operation]

- (1) Press the \blacktriangle or \blacktriangledown key on the BASIC SETUP screen and select "MEASURE METHOD".
Press the ENT key, and the screen appears, prompting you to select measurement method.

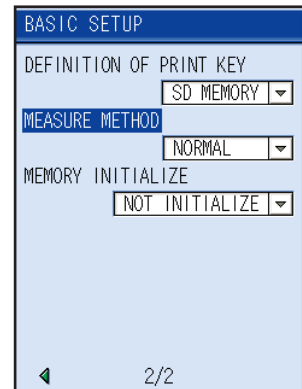

- (2) Select "NORMAL" or "ANTI-DISTURBANCE MODE" by the \blacktriangle or \blacktriangledown key and press the ENT key.

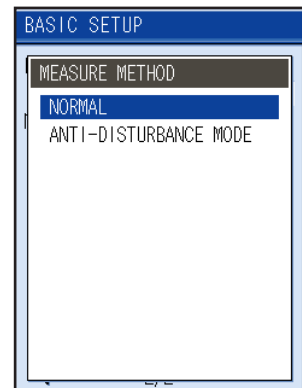

CAUTION

The measurement method is initialized according to the kind of sensor or outer diameter setting at the power ON or just when the PROCESS SETTING screen is displayed on the SITE SETTING. After changing from NORMAL to ANTI-DISTURBANCE MODE, set the measurement method again when the power is turned OFF or the PROCESS SETTING screen is displayed.

CAUTION

When the measurement method has been changed from NORMAL to ANTI-DISTURBANCE MODE, measurement values are subjected to change.

(6) MEMORY INITIALIZE: The setting parameters are initialized.

[Operation]

- (1) Press the \blacktriangle or \blacktriangledown key on the BASIC SETUP screen and select “MEMORY INITIALIZE”.
Press the ENT key, and you are ready to initialize the data.

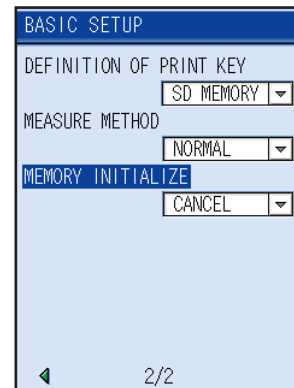

- (2) Select “REBOOT” by pressing the \blacktriangle or \blacktriangledown key and press the ENT key.

CAUTION

NOTE) The following data will be retained.

- (1) The site that has been not selected site memory
- (2) Clock
- (3) Analog output/ input calibration value
- (4) The contents of SD memory card

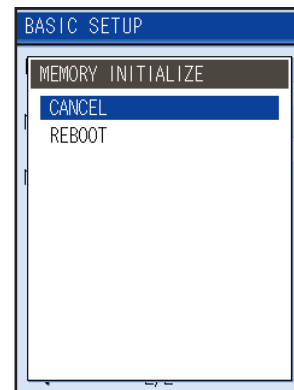

- (3) Select “EXECUTE” by pressing the \blacktriangle or \blacktriangledown key and press the ENT key.

CAUTION

When the parameter is initialized, display language is set to English.
For changing display language, refer to “5.2 Turning on power and language preference”.

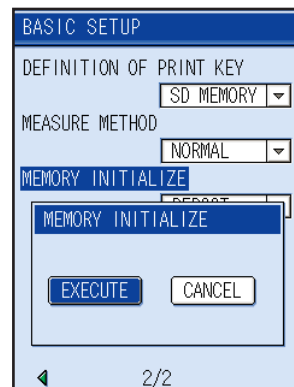

10.3.2 “ANALOG INPUT/OUTPUT”: when performing analog input/output and calibration

This function allows you to set the analog input/output and perform input/output calibration.

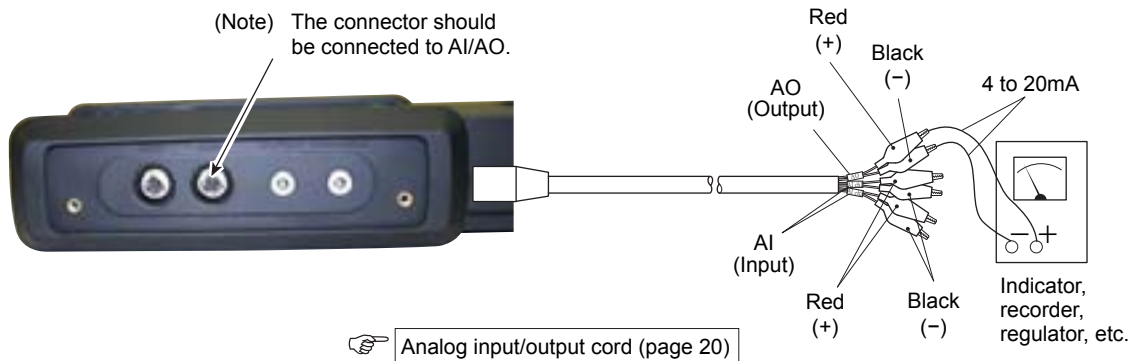

Analog output: 4 to 20mA DC 1 point “Load resistance under 600Ω”

Analog input: 4 to 20mA DC 1 point “Input resistance 200Ω”

4 to 20mA DC 1 point “Input resistance 200Ω” or
1 to 5V DC 1 point

(1) Select “ANALOG INPUT/OUTPUT” on the “SYSTEM SETUP” screen.

Press the **ENT** key to display the ANALOG INPUT/OUTPUT screen.

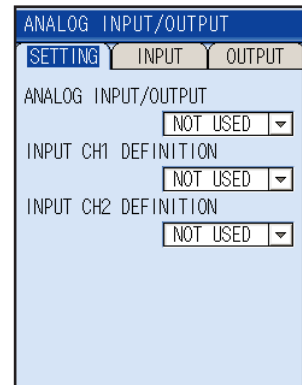
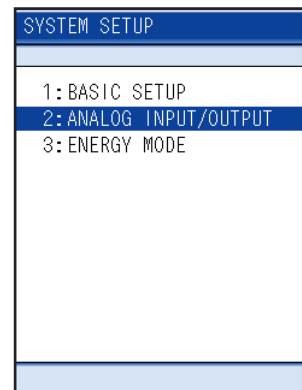

(1) “SETTING”: when using analog input/output.

[Operation]

- (1) Press the **(ENT)** key on the “SETTING” screen and move the cursor to “ANALOG INPUT/OUTPUT”. Press the **(ENT)** key, and the screen appears, prompting you to decide whether analog input/output is used or not.

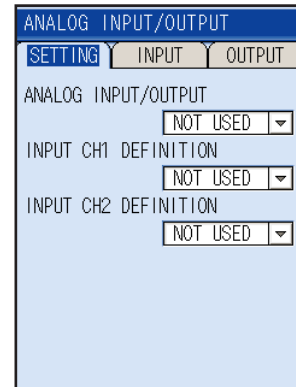

- (2) Select “USED” or “NOT USED” by the **(▲)** or **(▼)** key and press the **(ENT)** key.

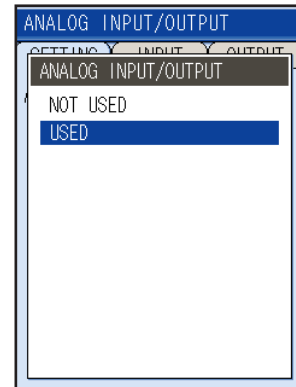

(2) “SETTING”: when setting the kind of analog input

Definition of Analog input1

NOT USED: Select this, when it is not used.

Current input (APPLICATION): Connect the external flow transmitter of 4 to 20mA DC.

Current input (SUPPLY TEMP.): For using the Energy mode, connect the feed-temperature 4 to 20mA DC.

When you set the definition of analog input2 to “CURRENT (TEMP DIFF.)”, “CURRENT (SUPPLY TEMP.)” becomes invalid.

Voltage input: Connect the external flow transmission of 1 to 5V DC.

Definition of Analog input2

NOT USED: select this, when you do not use.

Current input (APPLICATION): Connect the external flow transmitter of 4 to 20mA DC.

Current input (RETURN TEMP.): For using the Energy mode, connect the return-temperature 4 to 20mA DC.

Current input (TEMP DIFF.): For using the Energy mode, connect the SUPPLY TEMP. and the RETURN TEMP. of 4 to 20mA DC.

[Operation]

- Press the **(ENT)** key on the SETTING screen and the cursor moves to “ANALOG INPUT/OUTPUT”. Select “INPUT CH1 DEFINITION” or “INPUT CH2 DEFINITION” by the **(▲)** or **(▼)** key and press the **(ENT)** key.

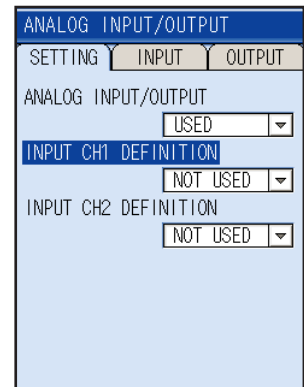

- The screen to select analog input definition is displayed. Select the kind of input and press the **(ENT)** key.

! CAUTION

Refer to “10.4 Setting of range” for setting of input range.

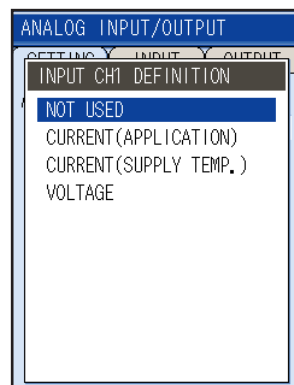

INPUT CH1 DEFINITION

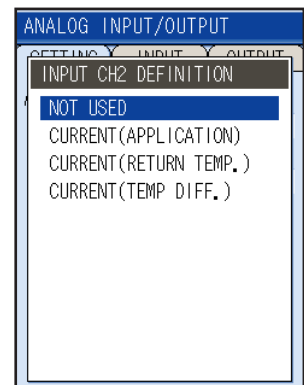

INPUT CH2 DEFINITION

**(3) “Input CH1, CH2 Analog Input CALIBRATION”:
when adjusting zero and span for input signals
[Please prepare a current generator]**

Calibration procedure

- 1) 10.3.2(1) set the “ANALOG INPUT/OUTPUT” to the “USED”
- 2) 10.3.2(2) set the definition of “SETTING” input CH to “CURRENT”.

[Operation]

- (1) Move the cursor to the “INPUT” on the SETTING screen by pressing the ◀ or ▶ key and display the INPUT screen.
Press the **ENT** key, and the cursor moves to “CH1: INPUT CALIBRATION” or “CH2: INPUT CALIBRATION”.
Select “CH1: INPUT CALIBRATION” by the ▲ or ▼ key and press the **ENT** key.
Select the kind of input you set on the “SETTING” screen by the ▲ or ▼ key and press the **ENT** key.
The cursor moves to “ADJUST”. Press the **ENT** key, and you are ready to 4mA calibration.

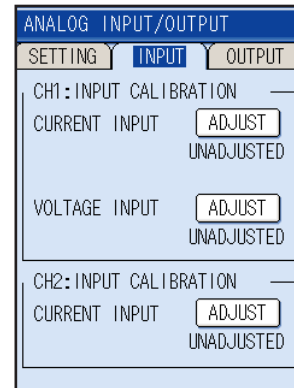

- (2) Input 4mA from external. Then press the **ENT** key to adjust zero.
Follow the procedures described in next page of input calibration.
- (3) After input calibration (4mA) is completed, calibration (20mA) will be ready.

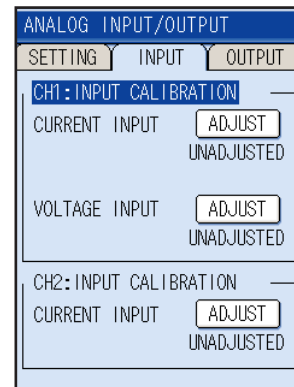

- (4) Input 20 mA from external .Then press the **ENT** key to adjust span.
Follow the procedures described in next page of input calibration.

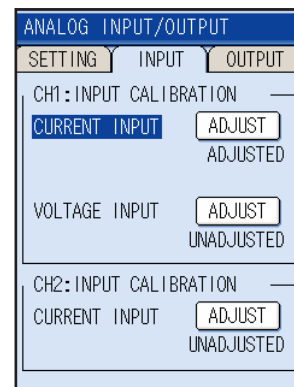

Current Input Caribration procedure

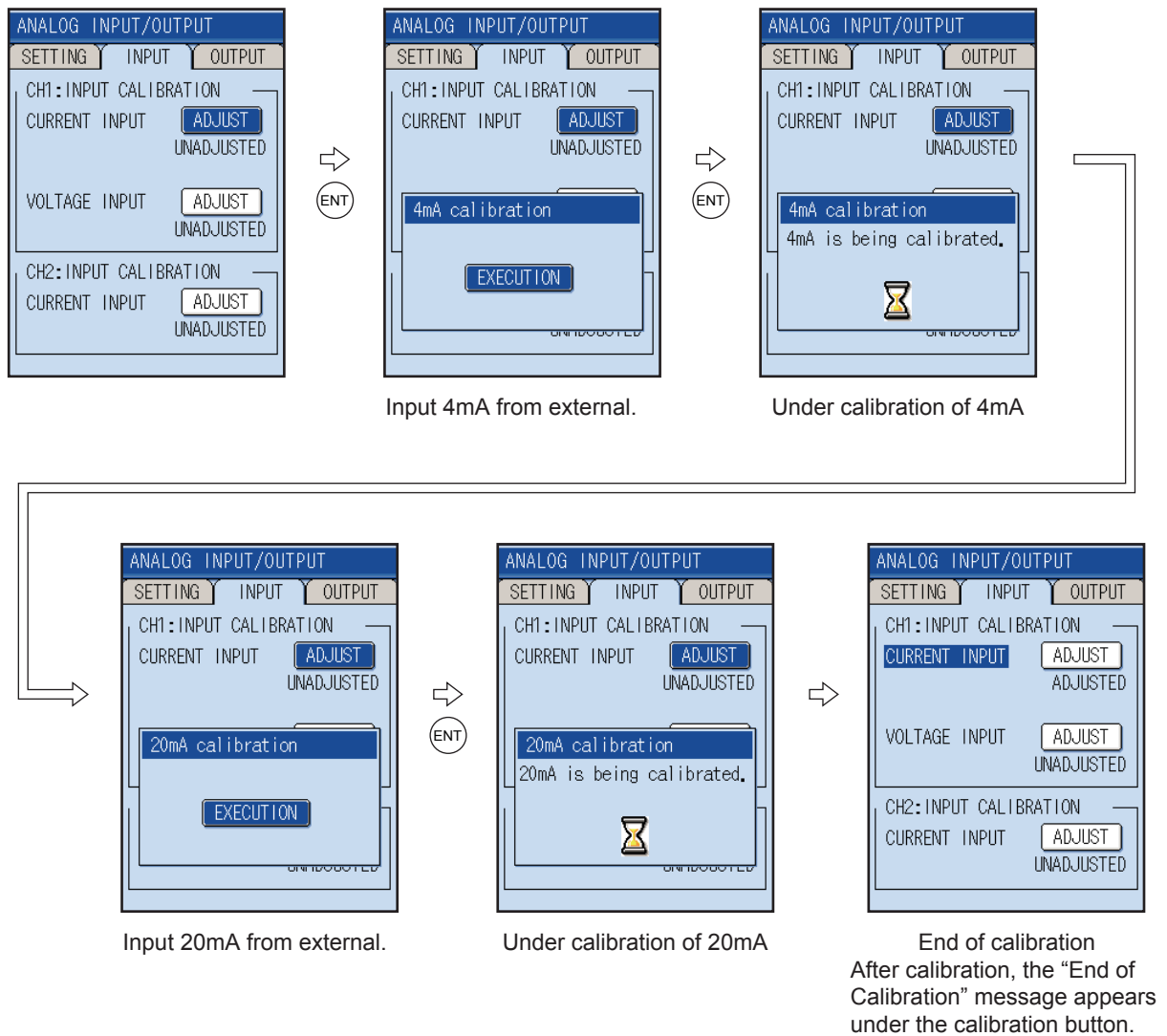

CAUTION

- Analog input has already been calibrated on the factory setting
- When you interrupt the calibration in the middle, the calibration value will be lost. If you interrupt the calibration, start from the beginning again.
- Calibrated analog inout required for AI measurement.

**(4) “Input CH1 Voltage Input CALIBRATION”:
when adjusting zero and span for input signals
[Using a voltage generator]**

Calibration procedure

- 1) 10.3.2(1) set the “ANALOG INPUT/OUTPUT” to the “USE”
- 2) 10.3.2(2) set the definition of “SETTING” input CH to “VOLTAGE INPUT”.

[Operation]

- (1) Move the cursor to the “INPUT” on the SETTING screen by pressing the ◀ or ▶ key and display the INPUT screen.
Press the (ENT) key, and the cursor moves to “CH1: INPUT CALIBRATION”.
Select “CH1: INPUT CALIBRATION.” by the ▲ or ▼ key and press the (ENT) key.
Select the kind of input you set on the “SETTING” screen by the ▲ or ▼ key and press the (ENT) key.
The cursor moves to “ADJUST”. Press the (ENT) key, and you are ready to 1V calibration.

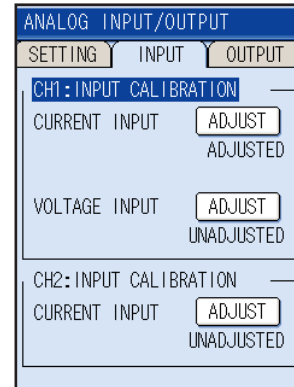

- (2) Input 1V from external source . Then press the (ENT) key to adjust zero.
Follow the procedures described in next page of input calibration.
- (3) After input calibration of 1V is completed, 5V calibration will be ready.

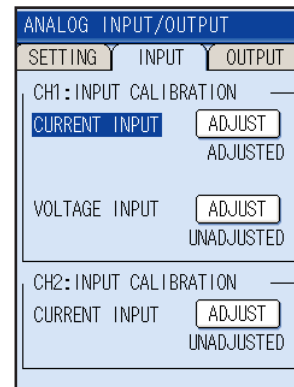

- (4) Input 5V from external source. Then press the (ENT) key to adjust span.
Follow the procedures described in next page of input calibration.

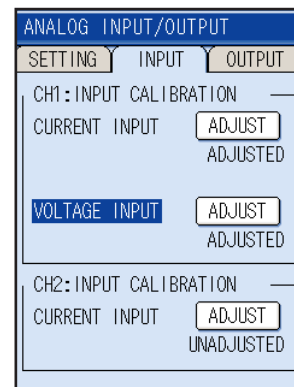

Voltage Input Calibration procedure

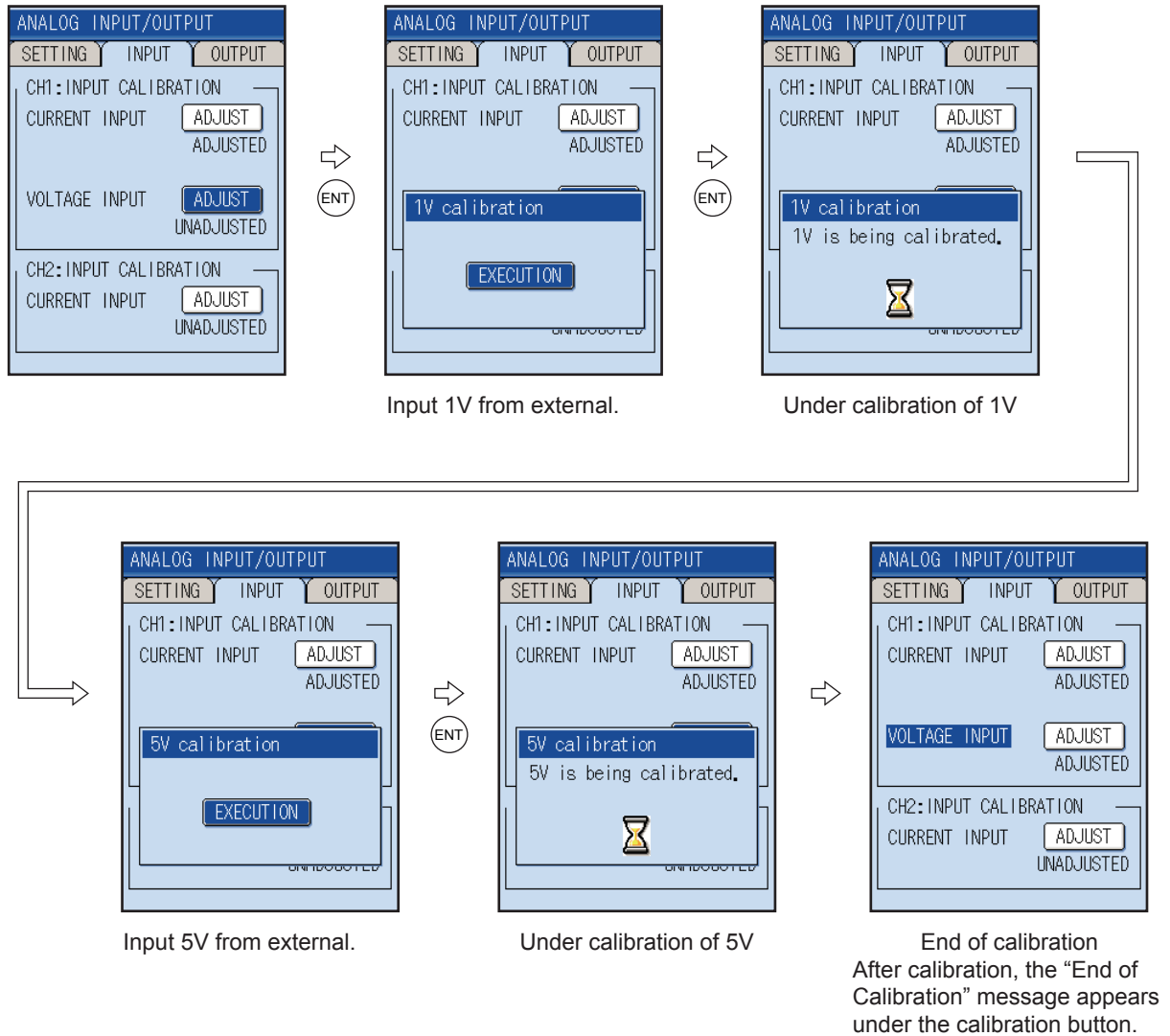

CAUTION

- Analog input has already been calibrated on the factory setting
- When you interrupt the calibration in the middle, the calibration value will be lost. If you interrupt the calibration, start from the beginning again.
- Calibrated analog input is required for AI measurement.

(5) AO CALIBRATION: when adjusting output circuit (prepare an ammeter)

Calibration procedure

10.3.2(1) set the “ANALOG INPUT/OUTPUT” to the “USED”

[Operation]

- (1) Move the cursor to the “OUTPUT” on the SETTING screen by pressing the ◀ or ▶ key and display the OUTPUT screen.
Press the ENT key, and the cursor moves to 4 mA.
- (2) Select either 4 mA or 20 mA by the ◀ or ▶, and press the ENT key.
Adjust the output circuit so that outputs are adjusted to either 4 mA (0% output calibration) or 20 mA (100% output calibration) by pressing the ▲ or ▼ key.
- (3) Press the ENT key to set up.

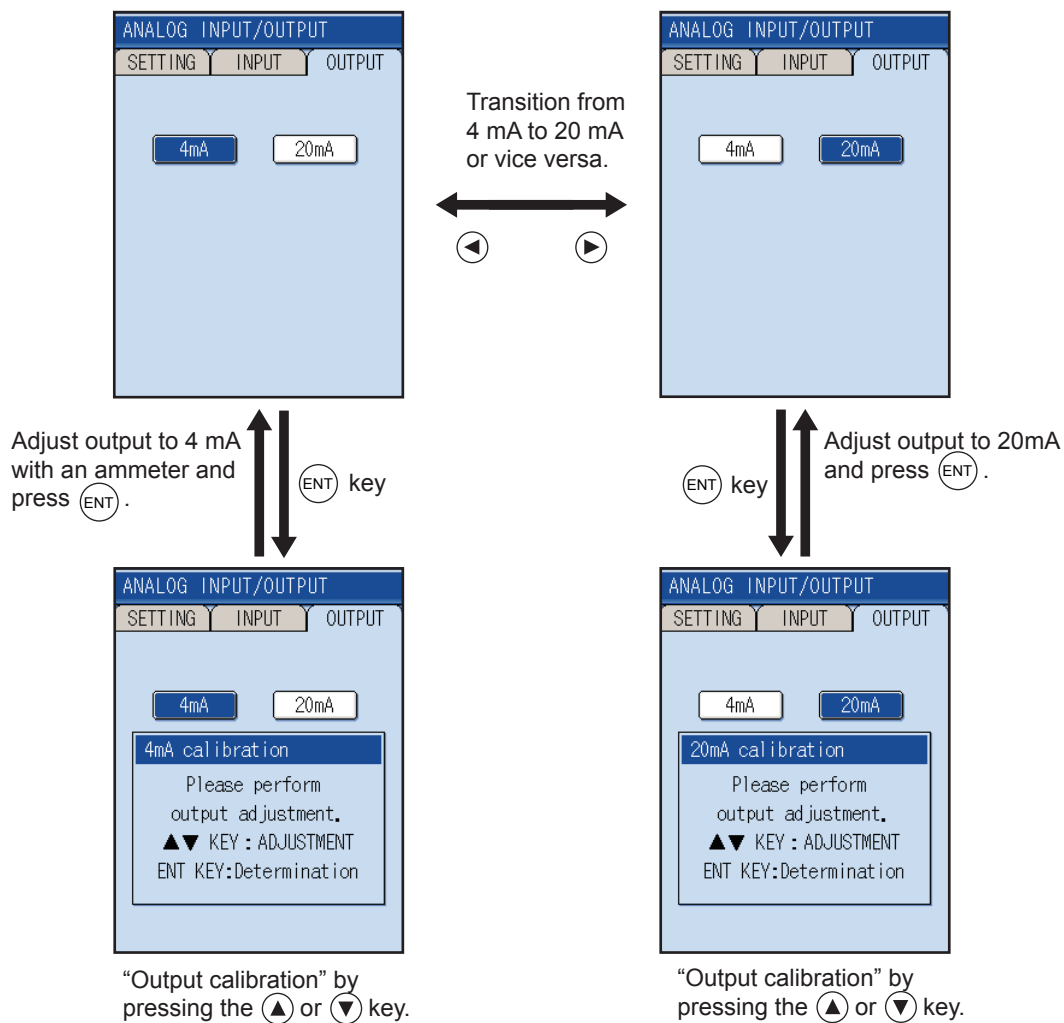

10.3.3 “ENERGY MODE”: when measuring consumed heat quantity

This function calculates the heat quantity received and sent with liquid (water) in cooling and heating.

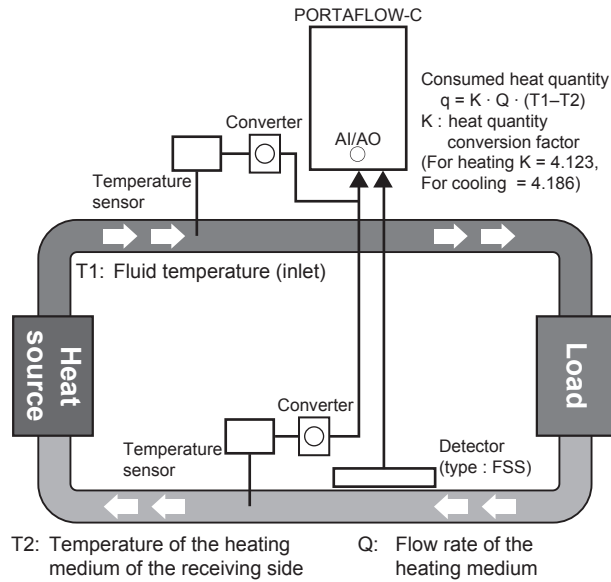

- (1) Select “ENERGY MODE” on the SYSTEM SETUP screen.
Press the **(ENT)** key to display the ENERGY MODE screen.

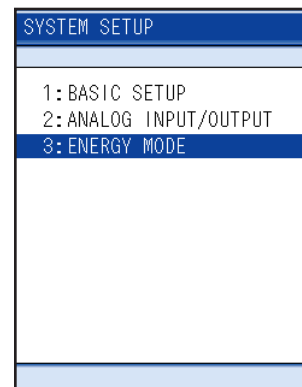

- (2) Make each setting on the ENERGY MODE screen.
(For details, refer to the setting contents in the following page.)

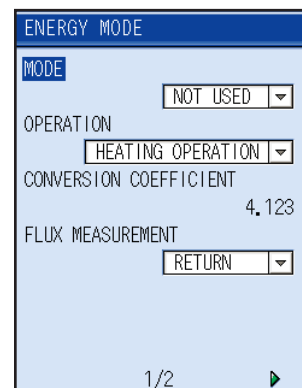

“MODE” : Select the “ENERGY MODE”.
When you select “NOT USED”, calorie is not measured.

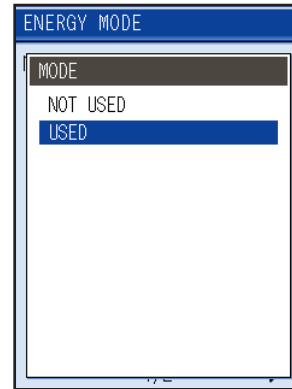

“OPERATION” : Sets the environment for the pipe to be measured. Select from the menu for setting.
* Not cooling/heating operation (when you select “OTHERS”, set the conversion coefficient of heat quantity.)
Setting range: 1.000 to 9.999

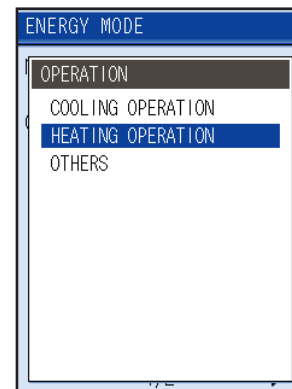

“FLUX MEASUREMENT”:
Sets the position to measure the flow rate of heating medium.

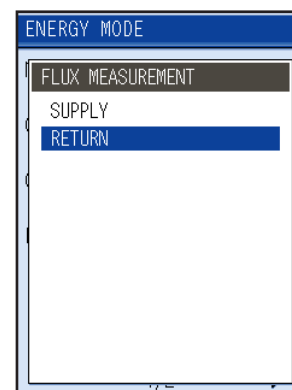

“SUPPLY TEMPERATURE”:
Sets the feeding temperature.
When you select “ANALOG INPUT CHANNEL1”, current input of CH1 is set to returning temperature.
Set the 10.3.2(1) Input CH1 of clause definition to “CURRENT (SUPPLY TEMP.)”.
When you set the definition of Input CH2 to the “CURRENT (TEMP DIFF.)”, the SUPPLY TEMP. will be disabled.
When you select “TEMPERATURE SETTING”, the temperature you entered is set to feeding temperature.
Setting range : -40 to 240°C

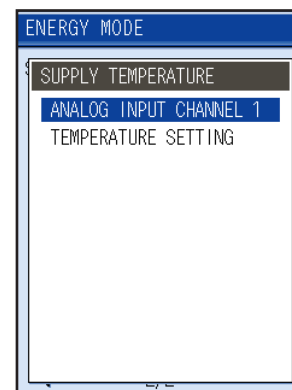

“RETURN TEMPERATURE”:

Sets the returning temperature.

When you select “ANALOG INPUT CHANNEL2”, current input of CH1 is set to the returning temperature.

Set the 10.3.2(1) Input CH2 of clause definition to “CURRENT (TEMP DIFF.)” or “CURRENT (RETURN TEMP.)”.

When you select “TEMPERATURE SETTING”, the entered temperature is set to returning temperature.

Setting range : -20 to 120°C

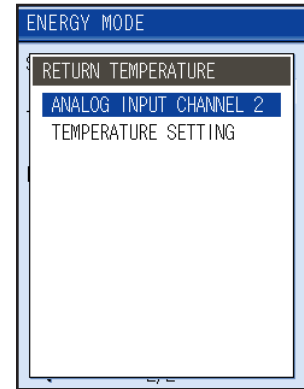

Note1) To set the feed/return temperature to the fixed temperature (TEMPERATURE SETTING), make settings for feed/return temperature on the ANALOG INPUT CHANNEL1 and ANALOG INPUT CHANNEL2 screen.

Note2) When the difference between the feeding temperature and the returning temperature is -0.5 to +0.5, thermal flow is zero.

10.4 Setting of range (setting screen for input/output range)

Set the measuring unit, range, output mode and error handling for analog input/output.

10.4.1 Setting the input range: When setting the range for the input current or input voltage.

Setting range: 0.000 to ±9999999999

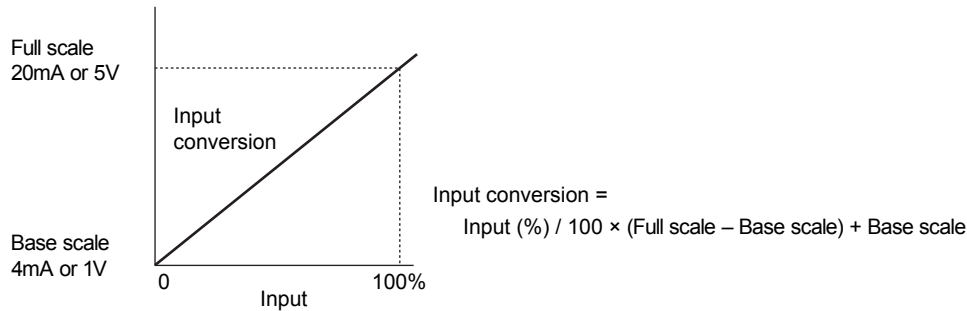

- Press the \uparrow or \downarrow key on the RANGE screen to select "INPUT RANGE".
Press the ENT key to display the INPUT RANGE screen.

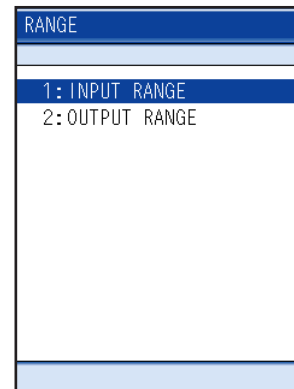

- Select "CH1" or "CH2" by the \leftarrow or \rightarrow key and press the ENT key.

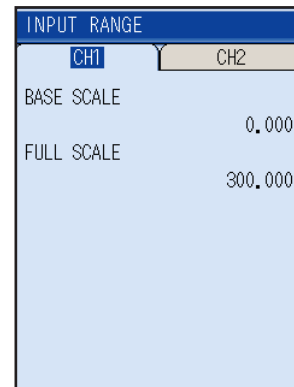

- The cursor moves to "BASE SCALE".
Press the ENT key, and you are ready to set the base scale.
Move the digit by the \leftarrow or \rightarrow key and enter numeric values by pressing the \uparrow or \downarrow key.
After entry, press the ENT key to set the base scale.

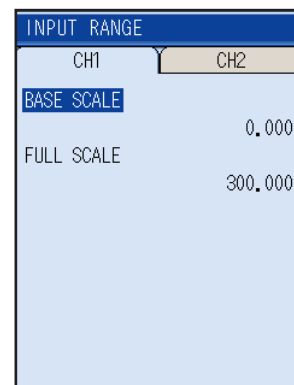

-
- (4) Move the cursor to “FULL SCALE” by the ▲ or ▼ key, and set the full scale in the same manner as the base scale.

INPUT RANGE	
CH1	CH2
BASE SCALE	0.000
FULL SCALE	300.000

10.4.2 Setting the output range

- Press the \blacktriangle or \blacktriangledown key on the RANGE screen and select "OUTPUT RANGE" from "OUTPUT". Press the ENT key, and the OUTPUT RANGE screen is displayed

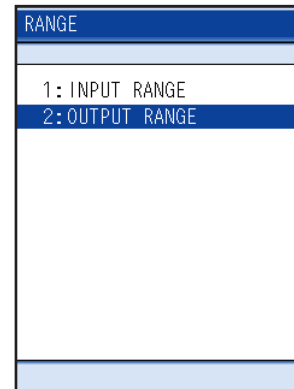

- "RANGE": when setting kind of output range, range type, full scale value and output limit value.

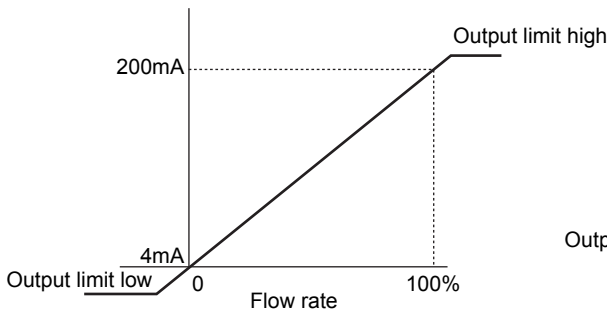

Single range: Output one way by 0 to 100%
 $\text{Output} = \text{Momentum flow rate} \times 100 / \text{Full scale}$

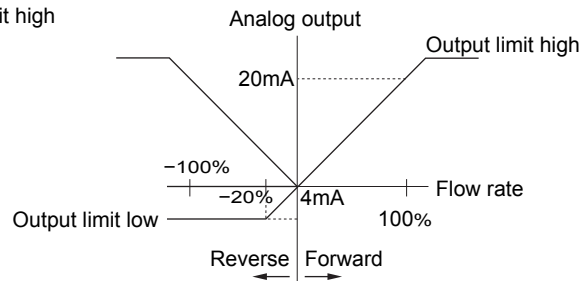

Bi-directional range: Also output back-flow by 0 to 100%.
 When switching flow direction, Hysteresis will be 10% in full scale.

- Select "RANGE" on the OUTPUT RANGE screen and press the ENT key and the cursor moves to "KIND".

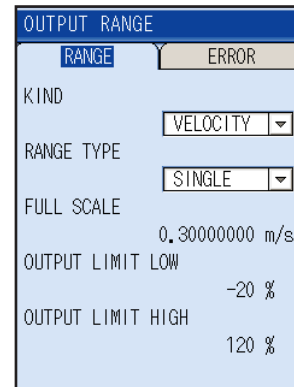

- Set the kind of output range (velocity, flow rate and thermal flow). Press the ENT key, and the screen appears, enabling you to select the output range. Select the kind of output range by the \blacktriangle or \blacktriangledown key and press the ENT key. For the thermal flow of the range kind, make 10.3.3 clause of "ENERGY MODE" "USED" and use it.

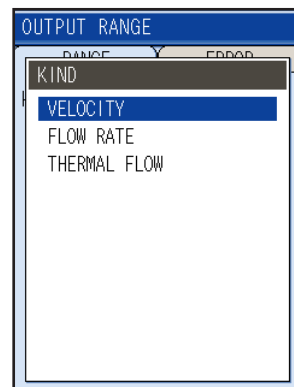

- (3) Set the range type (single range or bi-directional range).

Select "RANGE TYPE" by pressing the \blacktriangle or \blacktriangledown key.

- (4) Press the ENT key to display the RANGE TYPE screen.

Select the range type by the \blacktriangle or \blacktriangledown key and press the ENT key.

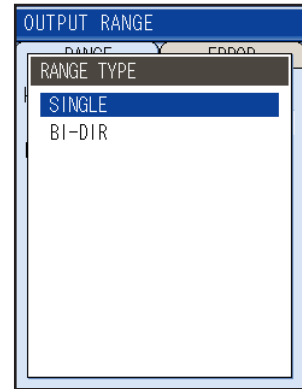

- (5) Set the full scale value for output range.

Setting range:

When the range kind is velocity or flow rate

0.000, ± 0.300 to ± 32.000 m/s

(Flow velocity conversion)

When the range kind is thermal flow rate

0.000 to 9999999999

Select "FULL SCALE" by pressing the \blacktriangle or \blacktriangledown key.

Press the ENT key, and you are ready to set the full scale.

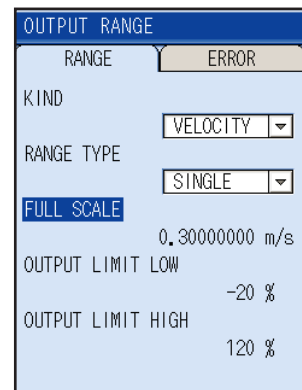

- (6) Move the digit by the \blacktriangleleft or \blacktriangleright key and enter numeric values by pressing the \blacktriangle or \blacktriangledown key.

After entry, press the ENT key to set the range. The full scale value will be set.

- (7) Make settings for output limit high/low (upper/lower limit for analog output).

Setting limit: Output limit low -20 to 0%

Output limit high 100 to 120%

Select "OUTPUT LIMIT LOW" by the \blacktriangle or \blacktriangledown key.

Press the ENT key, and you are ready to set the output limit low.

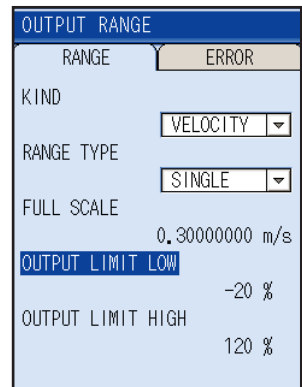

- (8) Move the digit by the \blacktriangleleft or \blacktriangleright key and enter numeric values by pressing the \blacktriangle or \blacktriangledown key. After entry, press the ENT key to set the range.

- (9) Select "OUTPUT LIMIT LOW" by pressing the \blacktriangle or \blacktriangledown key.

Set the output limit high in the same manner as the output limit low.

CAUTION

Set RANGE so that flow rate to be measured exceeds 1.2 times its maximum value.

If measured value exceeds the set value, the status display on the measurement screen turns "E4: RANGE OVER".

Unless analog output is used, set the full scale setting at 0, and "E4: RANGE OVER" is not displayed.

(2) “ERROR”: setting of analog output at error (Burnout)

When an error occurs, set a current output to force a set value. When resolving the cause, the current output is automatically restored.

“ERROR” means that the error code shows E2 or E3.

- (1) Select “ERROR” on the OUTPUT RANGE screen and press the **(ENT)** key, the cursor moves to “OUTPUT ERROR”.

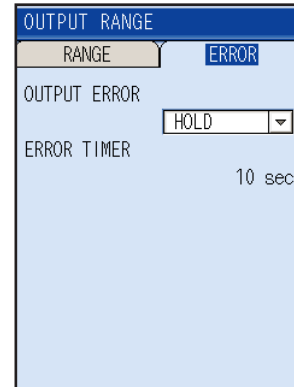

- (2) Set the action to be taken at the time of burn-out. Press the **(ENT)** key, and the ERROR screen appears.

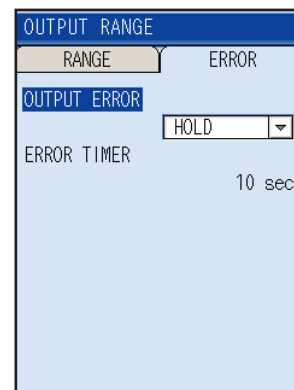

- (3) Select any of the ERROR items by the **(▲)** or **(▼)** key and press the **(ENT)** key.

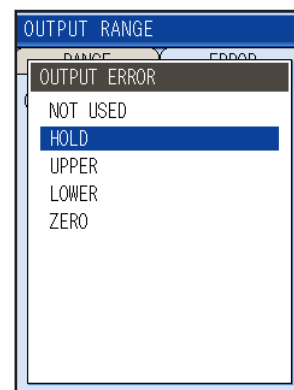

(4) Set “ERROR TIMER”

Setting range: 0 to 900sec

Select “ERROR TIMER” by pressing the ▲ or ▼ key.

Press the ENT key, and you are ready to set the time.

(5) Move the digit by the ◀ or ▶ key and enter numeric values by pressing the ▲ or ▼ key.

After entry, press the ENT key.

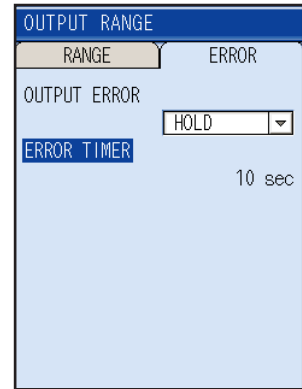

- **HOLD:** Holds output indications before the occurrence of errors.
- **UPPER:** 10.4.2(1) the setting of "Output limit high" is output.
- **LOWER:** 10.4.2(1) the setting of "Output limit high" is output.
- **ZERO:** Outputs (0%, 4 mA) at zero point

10.5 Use of printer function (PRINTER screen)

It allows you to print measured value as well as hard copy on an optional printer. On this page, setting for printing measured values and screen hard copy can be performed.

For connecting the printer, refer to section “14 HOW TO USE PRINTER”.

10.5.1 Selection of printing mode

(1) Select any of the modes of “TEXT”, “GRAPH”, and “LIST” on the PRINTER screen by the  or  key.

Press the  key to switch the printing mode setting screen. For the meaning of each mode, refer to the example below.

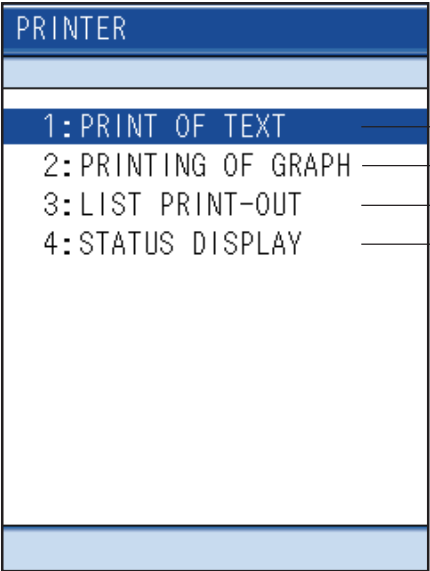
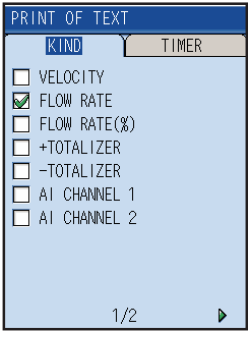
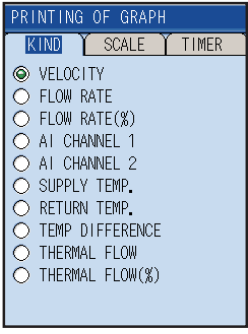
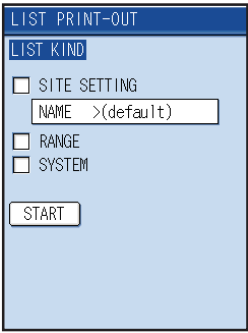
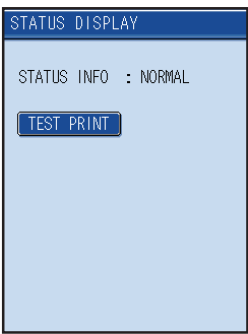
		<p>Prints text data for selected unit in industrial value. Example of printout</p>
		<p>Prints data for selected unit in graph. Example of printout</p>
		<p>Prints selected list. Example of printout</p>
		<p>Displays the status of printer and performs test printing. Example of printout</p>

10.5.3 PRINT OF TEXT

Up to 14 items available for printing are listed below:

- Flow rate (2 items)
- Flow velocity
- Totalizer (2 items)
- Analog input (2 items)
- Thermal flow rate (7 items)

Only desired items out of 14 items are allowed to print. One or more items are selectable simultaneously.

- (1) When the cursor is pointed to “KIND” on the PRINT OF TEXT screen, press the (ENT) key to select the item to be printed as text data.
Press the (▲) or (▼) key to select the item to print and press the (ENT) key.

To display the items on the second page, press the (◀) or (▶) key so that the page is switched.

After selection, return the cursor to “KIND” by the (ESC) key.

- (2) Move the cursor to “TIMER” by pressing the (◀) or (▶) key
Press the (ENT) key to select the following mode of the timer.
 - MANUAL
 - FIXED TIME
 - TIMER

Then, set the printing cycle.
Setting range: 1min. to 24hours

- (3) Move the cursor to “START” and press the (ENT) key to start printing.
“START” switches to “STOP” indication.
Move the cursor to the “STOP” for interruption of printing, and press the (ENT) key, the printing will stop.

⚠ CAUTION
When the power supply is cut while printing, make a setting again.

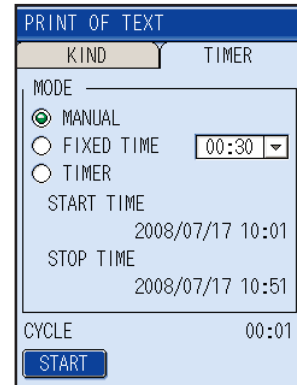
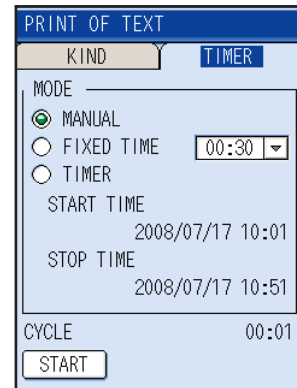
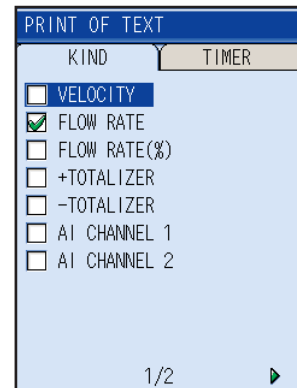
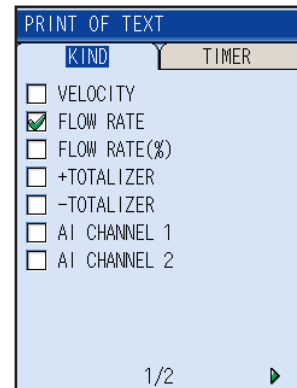

10.5.5 LIST PRINT-OUT

It allows you to print lists of site setting, range and system:

- (1) Selects the kind of list.
As for site setting, the currently selected setting will be printed.
- (2) Move the cursor to “START” and press the (ENT) key to start printing.

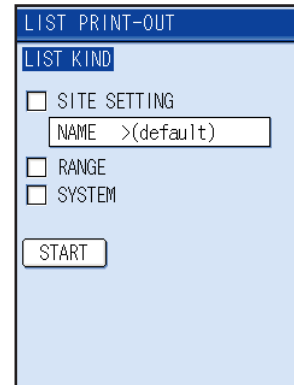

The screenshot shows a menu titled "LIST PRINT-OUT" with a blue header. Below the header, there is a sub-menu "LIST KIND" with three options: "SITE SETTING", "RANGE", and "SYSTEM", each preceded by an unchecked checkbox. The "SITE SETTING" option is selected, and a text box next to it contains "NAME >(default)". At the bottom of the menu, there is a "START" button.

10.5.6 STATUS DISPLAY

It allows you to display the printer status and perform the printing test.

Content of “STATUS DISPLAY“

- 1) NORMAL
- 2) PRINTING
- 3) PRINTER FAIL
Show the contents of error display below
 - Printer is not connected
 - Printer is broken
 - Printer has run out of roll paper

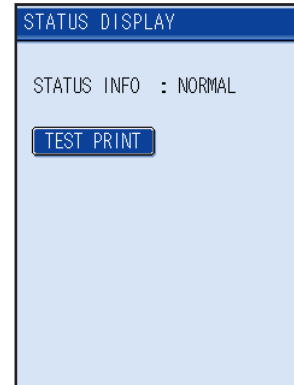

The screenshot shows a menu titled "STATUS DISPLAY" with a blue header. Below the header, the text "STATUS INFO : NORMAL" is displayed. At the bottom of the menu, there is a "TEST PRINT" button.

10.6 Maintenance function (MAINTENANCE screen)

This function allows you to check the condition of this instrument.

10.6.1 Checking receiving status for transit time

(1) When an error is detected on measurement screen

- (1) Move the cursor to “1:TRANSIT TIME” on the MAINTENANCE screen and press the **(ENT)** key. The TRANSIT TIME/SIGNAL CHECK screen is displayed.

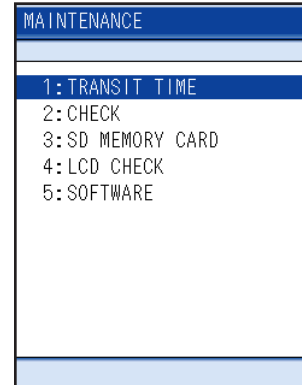

- (2) Move the cursor to the status display field on the “TRANSIT TIME/SIGNAL CHECK” screen and press the **(ENT)** key.

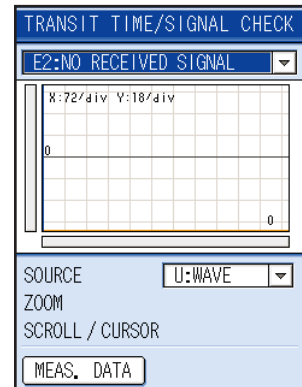

For content of error, refer to “10.8 Contents of errors in status display”

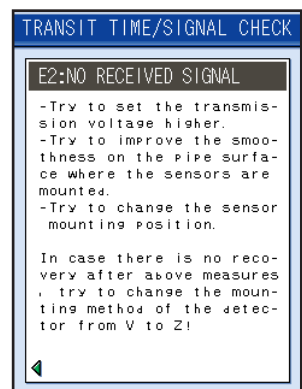
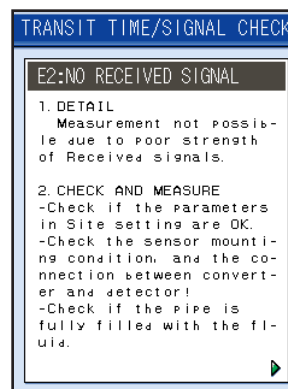

(2) To check for ultrasonic receiving signal waveform;

- (1) Move the cursor to “TRANSIT TIME” on the MAINTENANCE screen and press the **ENT** key, and the TRANSIT TIME/SIGNAL CHECK screen is displayed.

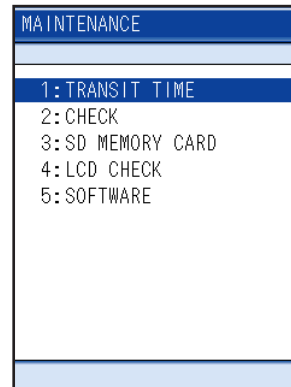

- (2) Move the cursor to “SOURCE” on the TRANSIT TIME/SIGNAL CHECK screen and press the **ENT** key.

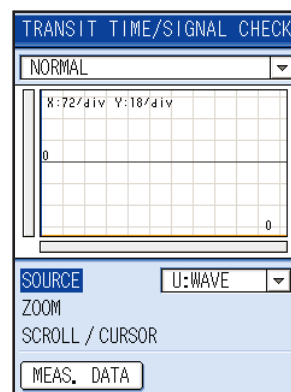

- (3) The SOURCE screen appears. Select the following waveform by the **▲** or **▼** key and press the **ENT** key.
- U: WAVE
 - D: WAVE

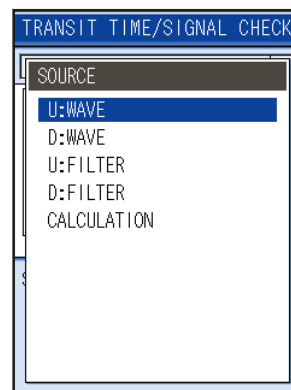

- (4) When SOURCE is selected, SIGNAL CHECK display will be started.

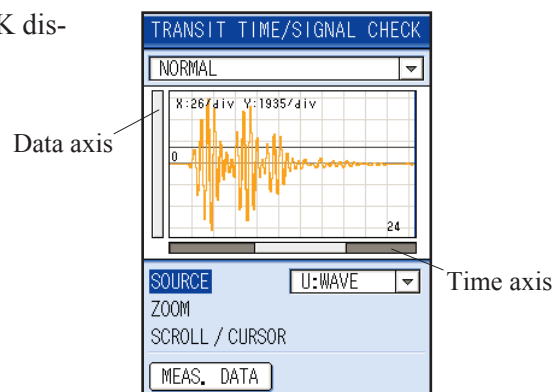

- (5) To enlarge/contract waveform;
 By pressing ▲ or ▼ key, move the cursor to “ZOOM” and press the (ENT) key to enlarge/contract waveform.
 To enlarge/contract the time axis (horizontal axis), press the ◀ or ▶ key.
 To enlarge/contract the data axis (vertical axis), press the ▲ or ▼ key.

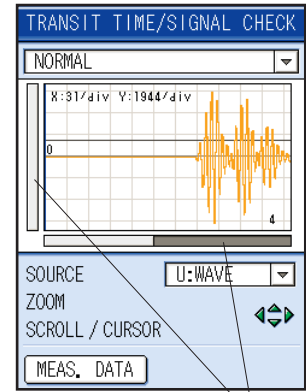

Zoom bar

- (6) To move Time axis;
 Press the ▲ or ▼ key, move the cursor to “SCROLL” and then press (ENT) key, SCROLL will be readied.
 For movement of time axis, press the ◀ or ▶ key.

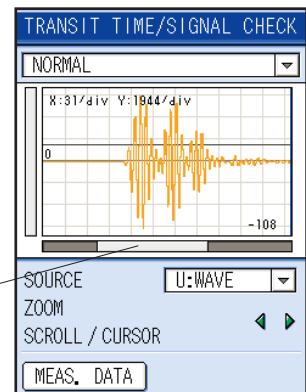

Scroll bar

- (7) For adjusting the time axis migration;
 Point the cursor to “CURSOR” and press the (ENT) key to display the cursor.
 Press the ◀ or ▶ key to move the cursor to a receiving signal waveform-like point.

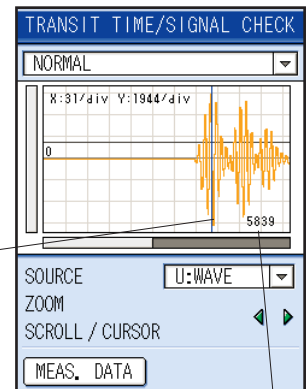

Cursor

Data

- (8) To check measurement data;
 By pressing ▲ or ▼ key, Point the cursor to “MEAS. DATA” and press the (ENT) key to display the TRANSIT TIME/MEAS. DATA screen.
 You are now ready to check measurement data.

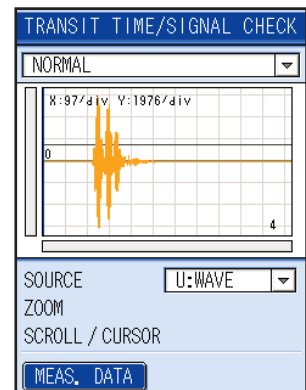

Explanation of measurement data

- Signal power
Displays the intensity of received signals.
The larger the value, the larger the intensity of received signals.
Normal measurement values fall in 35% or more.
For 0%, there is no received signal.
Ultrasonic waves may not be transmitted because of insufficient water volume or rust of piping.
- Trigger level
Displays the detection level of received waveform.
- Signal peek
Displays the peak value of received waveform.
Normal values stably fall within the range from 5528 to 6758.
If the value fluctuates significantly, objects that constitute barriers against ultrasonic wave transmission such as air bubbles or foreign matter may be contained in the fluid.
Stop the flow, and the measurement is found to be normal. If so, there is a possibility that air bubbles are contained.
- Fluid sound velocity
Displays the calculated value of the fluid sound velocity.

TRANSIT TIME/MEAS. VALUE	
SIGNAL POWER(U)	50.72 %
SIGNAL POWER(D)	50.74 %
TRIG. LEVEL (U)	25 %
TRIG. LEVEL (D)	25 %
SIGNAL PEEK (U)	5826
1/2 ▶	

TRANSIT TIME/MEAS. VALUE	
SIGNAL PEEK (D)	5819
FLUID S.V.	1477.9 m/s
◀ 2/2	

[Remark] Check to judge whether ultrasonic receiving signal waveform is normal or not

(1) Normal waveform

The receiving waveform free of noise, normal measurement can be performed.

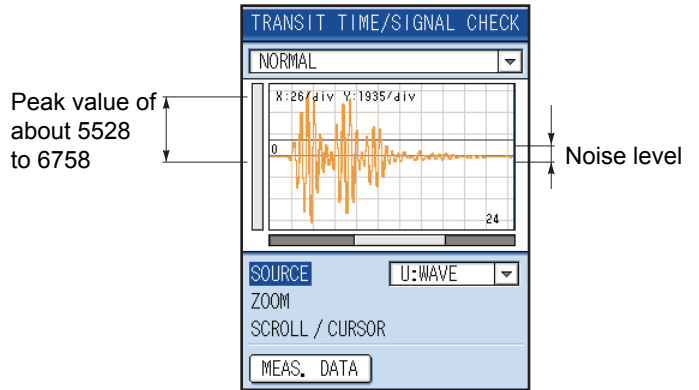

(2) Abnormal waveform

The receiving waveform is not covered within the range of the ultrasound waveform. It is displayed as “E2: CALCULATION ERROR” or “E2: RECEIVED SIGNAL ERROR”. Check the pipe setting and sensor mounting dimensions.

When ultrasonic receiving signal waveform is weakened by the effect of rust in the pipe, abnormal waveform may result. Raise the transmission voltage and perform measurement. (See page 36).

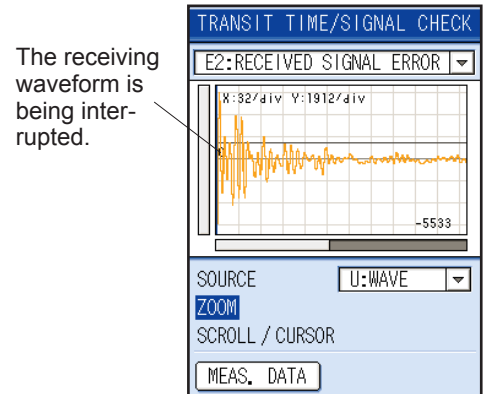

(3) No received signal

The waveform is free of the received waveform, and this is the waveform to which the noise is expanded. The equipment cannot measure. Ultrasonic waves may not be transmitted because of insufficient water volume or rust of piping.

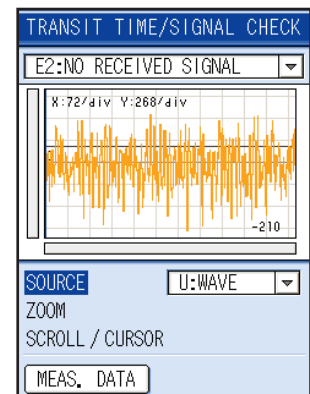

10.6.2 Check for analog input/output

(1) Analog input

When the current input for CH1 and CH2 is 4-20mA or the voltage input is 1-5V, it is possible to check for the input status.

- (1) Move the cursor to “CHECK” on the MAINTENANCE screen and press the **(ENT)** key to display the CHECK screen.

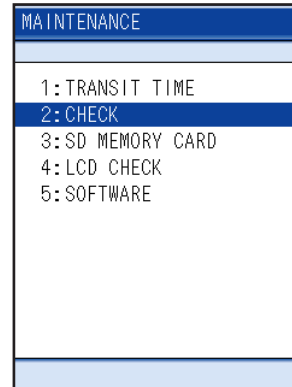

- (2) Check for the current input and the voltage output on ANALOG INPUT of the CHECK screen.

Display unit

- Current input: mA
- Voltage input: V

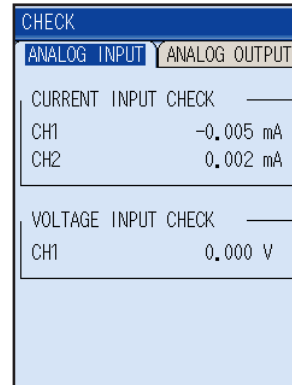

(2) Analog output

It allows you to set the constant current output of analog signal.

When setting the simulating output (test mode), each output can be checked (LCD display, analog output). With the output at the actuated time as an initial value, the output changes up to the input value (simulated flow rate target value) in a selected tracking time and, at the input data, the analog output value becomes constant.

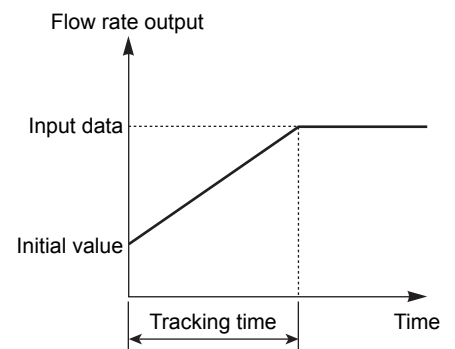

- (1) Generate a fixed value output; use when checking the operation of a connected receiver and current output circuit of the main unit.

Setting range: -20 to 120%

Move the cursor to ANALOG OUTPUT on the CHECK screen and press the **(ENT)** key.

The cursor moves to ANALOG OUTPUT, prompting you to set the constant current output value.

- (2) When using the test mode to check for the measurement status, move the cursor pointed to ANALOG OUTPUT to TEST MODE and make the following settings.

“TEST MODE”: USED/NOT USED

“INPUT DATA”: Simulated flow rate target (percentage of maximum flow rate).

“TRACKING TIME”: Time required to attain the simulated flow rate target.

Setting range: Input data: 0 to ±120%

Tracking data: 0 to 900sec.

* For setting TRACKING TIME, 0sec is set to the damping (See 10.1.4(4)).

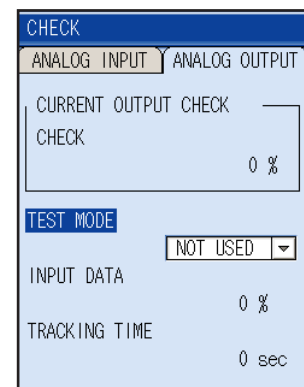
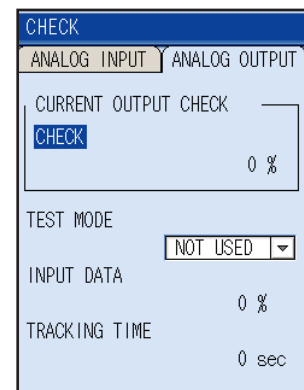
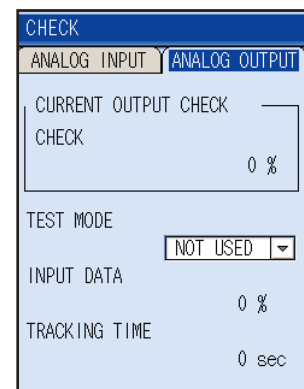

⚠ CAUTION

- Be sure to return the setting to “NOT USED” after the test is completed. Otherwise, the output will be held at the input data value until power is turned off.
- For being started TOTAL, total value will also change.
- If you set the Thermal flow of “10.4.2(1) Type of Output range”, test mode function will be disabled.
- When changing to the transit time difference on the maintenance screen or the flow velocity profile screen, the test mode will be cancelled.

10.6.3 SD memory card

It allows you to check for the following data in the SD memory.

- Logger data: Display of logger conditions and total data.
- Print screen: Display of data screen.
- Flow profile: Display of file name only.

(1) Move the cursor to “SD MEMORY CARD” on the MAINT screen and press the **(ENT)** key to display the SD MEMORY CARD screen.

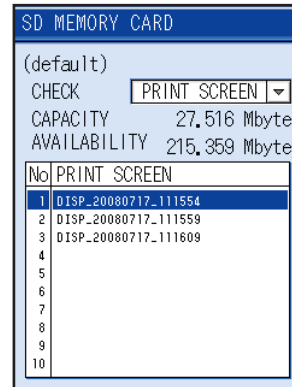

(2) Press the **(ENT)** key on the SD MEMORY CARD screen and the CHECK screen appears.

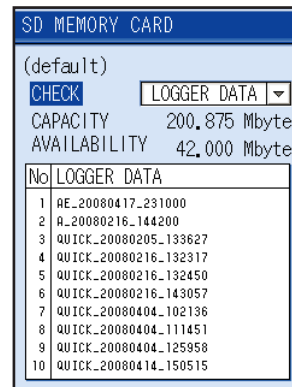

(3) Move the cursor to the data items to be checked (LOGGER DATA, PRINT SCREEN and FLOW PROFILE) by the **(▲)** or **(▼)** key and press the **(ENT)** key.

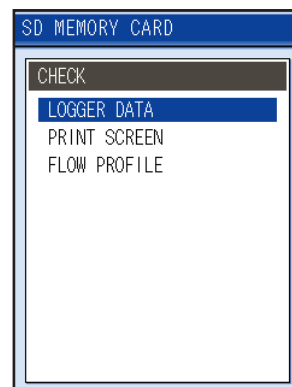

(1) To check for logger data

- (1) When “LOGGER DATA” is selected on the SD MEMORY CARD screen, the screen appears, prompting you to select the logger data. Move the cursor to the logger data file to be checked by the \blacktriangle or \blacktriangledown key and press the ENT key.

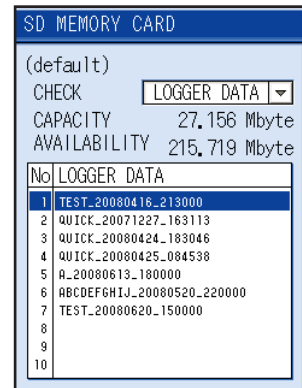

- (2) The contents of the logger data is displayed as text data.
Turn back to the selection screen, press the ESC key.

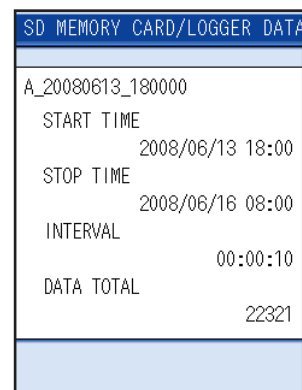

(2) To check for print screen data

- (1) When “PRINT SCREEN” is selected on the SD MEMORY CARD screen, the screen appears, prompting you to select the dump data. Move the cursor to the screen data file to be checked by the \blacktriangle or \blacktriangledown key and press the ENT key.

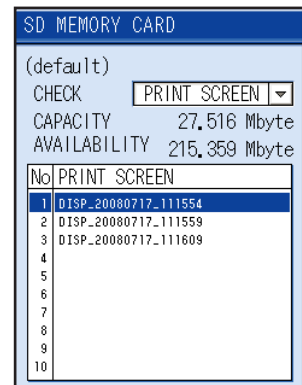

- (2) The screen data is displayed.
Turn back from data screen display, press the ESC key.

(3) To check for flow profile data

- (1) When you select “FLOW PROFILE DATA” on the SD memory card screen. File name list for “FLOW PROFILE DATA” is displayed.

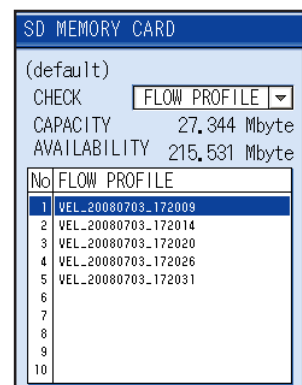

(4) To delete logger data

- (1) Select “LOGGER DATA” on the SD memory card screen.
The selection screen of logger data appears, move the cursor to the logger data which you want to delete by the ◀ or ▶ key.

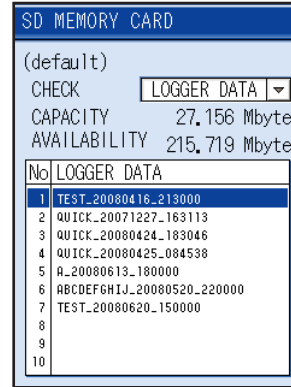

- (2) Move the cursor to the logger data you want to delete, press the ◀ or ▶ key. The message on the right side will be displayed.
Press the (ENT) key selecting “YES”, the data will be deleted.

Note) The logger data can not be deleted under logging.

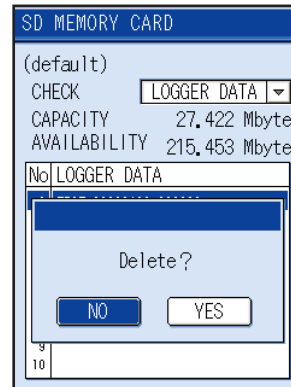

10.6.4 LCD check

The display unit uses 4.7 inch color graphic display (240×320 dots). This function checks pixels of the liquid crystal display by displaying 16 colors in the horizontal stripes.

There is a possibility that surface irregularity occurs in the brightness due to characteristics of liquid crystal display. You are kindly requested to understand it in advance.

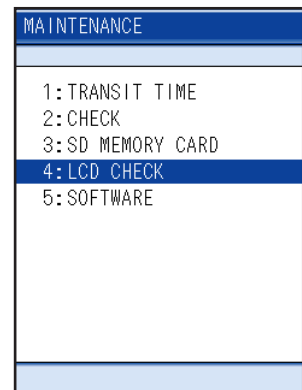

Press the **(ESC)** or **(MENU)** key for returning from the LCD check screen.

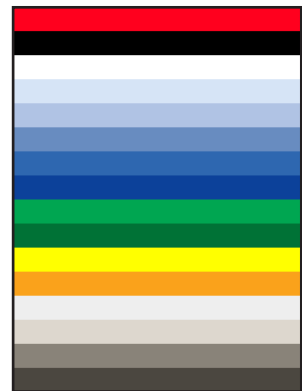

10.6.5 Software

Software version check and software update are permitted.

- Version
- Update

(1) In order to check the version

Move the cursor to [Software] in the maintenance screen and press the **(ENT)** key. Transition to the software screen appears, and the version number is displayed.

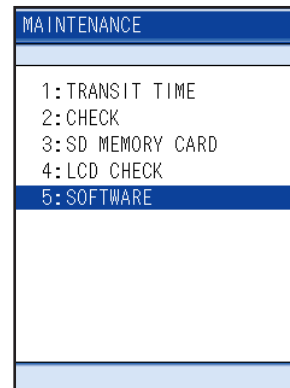

Example)

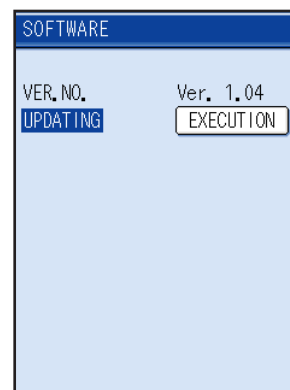

(2) In order to update the software

Preparation

Prepare an SD memory card containing update files.

Create a folder by name “UPDATE” just beneath the root folder of the SD memory card. Save two update files provided from manufacturer just beneath the folder.

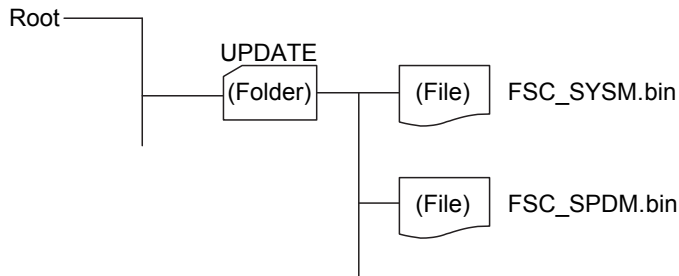

1. Insert a SD memory card into the SD memory card slot.
2. Please connect AC power adapter to a transmitter and perform electric supply.
3. Turn the power ON by pressing the “ON” switch on the main unit.
4. Press the **(ENT)** key on the software screen of the MAINTENANCE screen.

A message appears.

- (1) If update is not necessary, select “No” using **(◀)** or **(▶)** keys, and then press the **(ENT)** key.

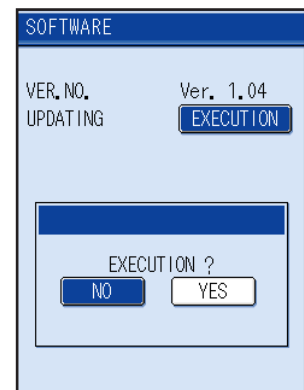

- (2) If update is necessary, select “Yes” using **(◀)** or **(▶)** keys, and then press the **(ENT)** key

Update is executed.

Restart occurs automatically on termination of update.

The length of time required for update is about 30 seconds.

Check the version after restart.

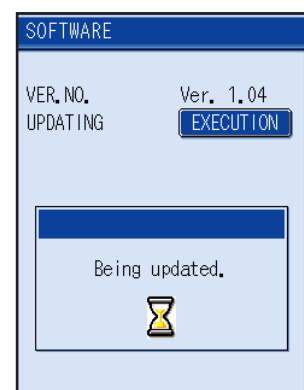

CAUTION

- Do not insert or remove a SD memory card during update.
- Start-up is disabled, if power is OFF during update.

10.7 Flow velocity distribution display function (optional)

It is possible to measure the flow velocity distribution in real time by the pulse doppler method and to display the flow state in the piping.

Use this function for judgment if the flow rate measuring position is appropriate, for diagnosis of flow, for research, testing and others.

This function is applicable to the following types.

Main unit type: FSC□□1□□-□

(with flow velocity distribution display function, if the 6th digit is "1")

Sensor type: FSDP2 (Bore diameter; $\phi 40$ to 200mm Fluid temperature; -40 to $+100^{\circ}\text{C}$)

FSDP1 (Bore diameter; $\phi 100$ to 400mm Fluid temperature; -40 to $+80^{\circ}\text{C}$)

FSDP0 (Bore diameter; $\phi 200$ to 1000mm Fluid temperature; -40 to $+80^{\circ}\text{C}$)

10.7.1 Installing Detector

(1) Processing of detector mounting surface

Remove rust, pitch, surface irregularity and others from the pipe surface, to which a sensor is to be mounted, by the frame length of the sensor to be mounted, using thinner, sandpaper and/or other appropriate means.

Note) If the piping outer circumference is wound with jute, remove the jute from the entire outer circumference in a length that is frame length (L) + 200 mm.

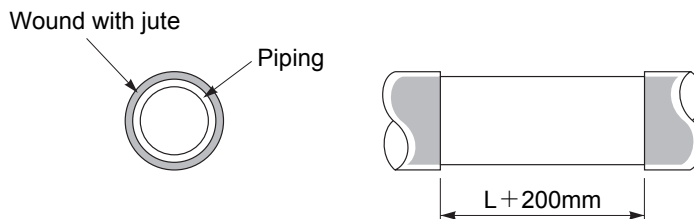

(2) Installation of detector

- (1) Wrap the belt around the pipe.

FSDP2, FSDP1

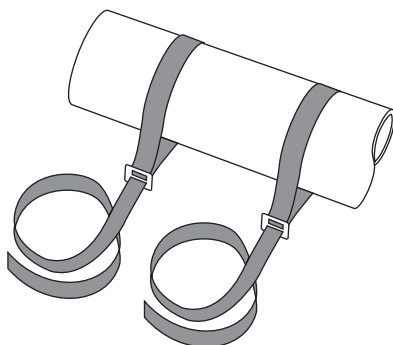

Adjusts the length of the wire rope according to the piping size, fixes the wire on the pipe.

FSDP0

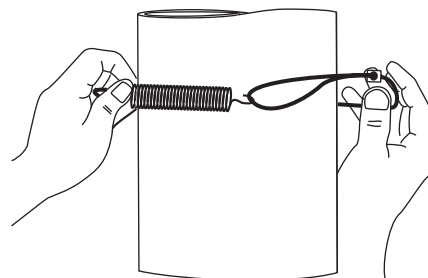

- (2) Fully screw up to the right side.

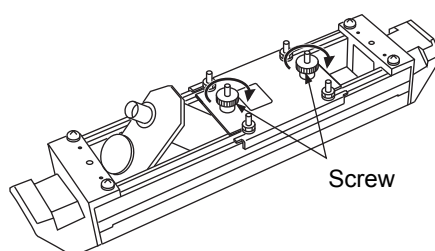

-
- (3) Before mounting the sensor to the pipe, apply grease evenly over the sensor unit and the absorber unit that are to contact the pipe.

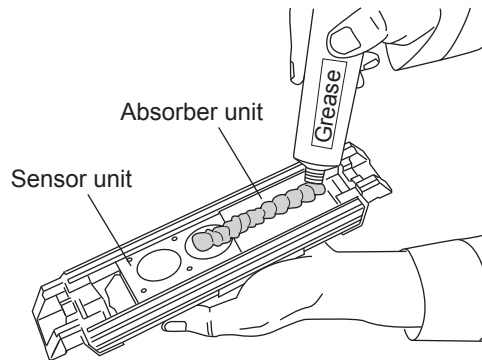

- (4) Fasten the sensor with the belt checking the flow direction.

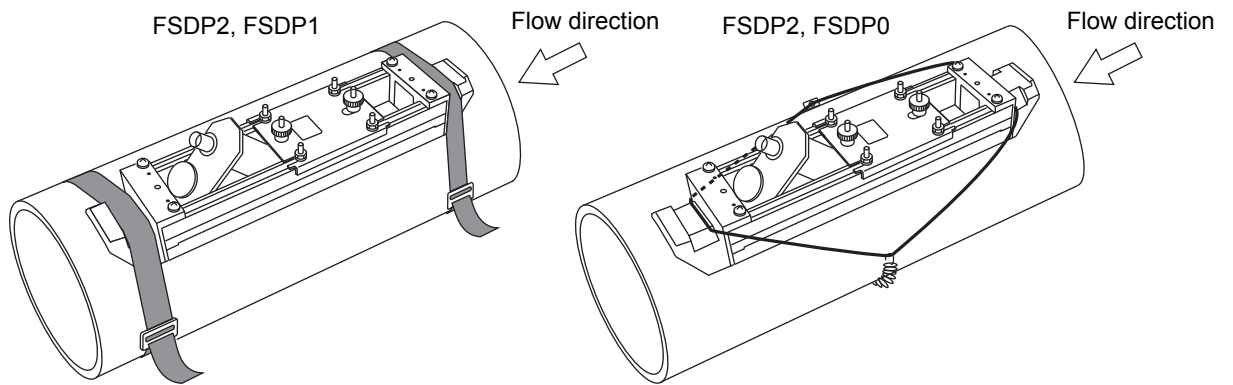

- (5) After fastening the sensor to the pipe, screw to the left side, attach the sensor firmly to the pipe.

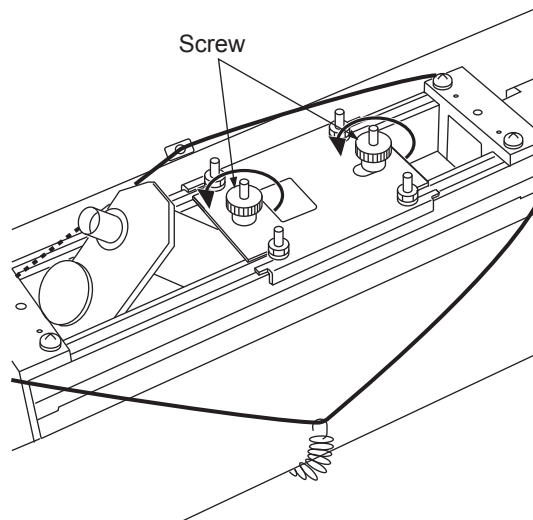

(3) 2-paths

Gauge paper may be necessary for this work. (Refer to “8.9. How to make gauge paper”.)

- How to determine mounting position

- (1) Match the edge of gauge paper with the line at about 100mm from one end of the pipe portion treated for detector mounting, and wind the gauge paper so that the line marked on the paper is parallel with the pipe axis (fix with tape not to allow deviation). At this time, the edge of gauge paper should be aligned.

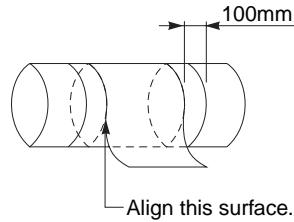

- (2) Extending the line marked on the gauge paper, mark straight line A on the pipe.

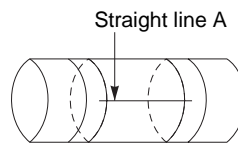

- (3) Mark a line along on edge of the gauge paper. Assume the intersection of the line and the straight line A is A_0 .

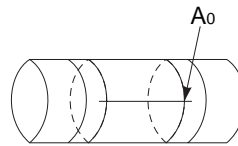

V method

Z method

Example) When $L = 200\text{mm}$

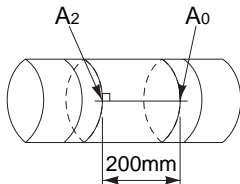

- (4) Remove the gauge paper and measure the mounting dimension from A_0 . Then, draw a line which crosses the straight line A (determine the position A_2).

A_0 and A_2 become the mounting positions.

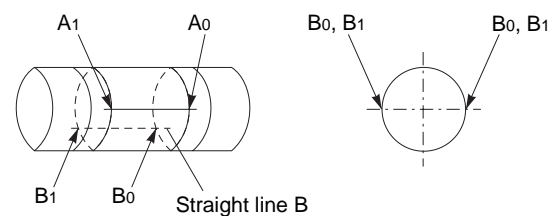

- (4) Measure the circumference of the pipe from the point A_0 , and mark a line (straight line B) between the point B_0 and B_1 obtained at $1/2$ of the circumference.

(4) Installation of detector

- (1) Wrap the belt around the pipe.

FSDP2, FSDP1

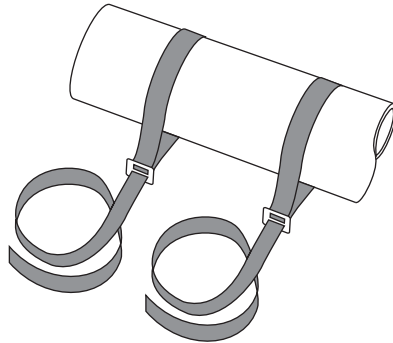

Adjusts the length of the wire rope according to the piping size, fixes the wire on the pipe.

FSDP0

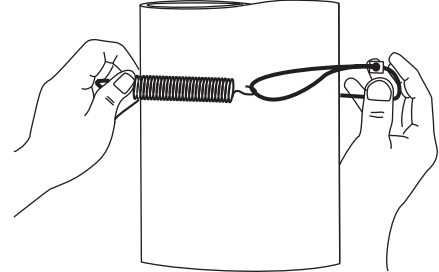

- (2) Fully screw up to the right side.

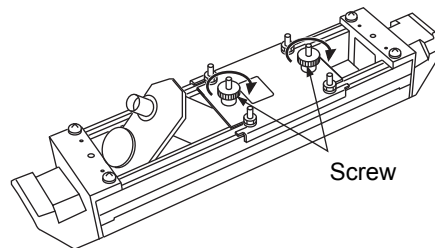

- (3) Before mounting the sensor to the pipe, apply grease evenly over the sensor unit and the absorber unit that are to contact the pipe.

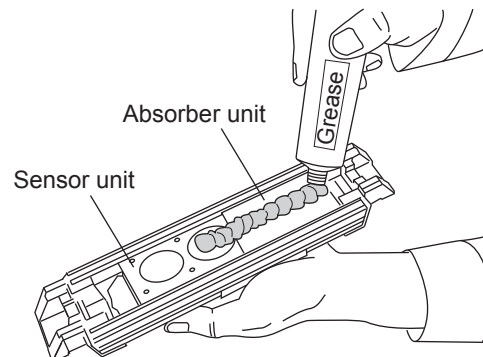

- (4) Fasten the sensor with the belt checking the flow direction.

FSDP2, FSDP1

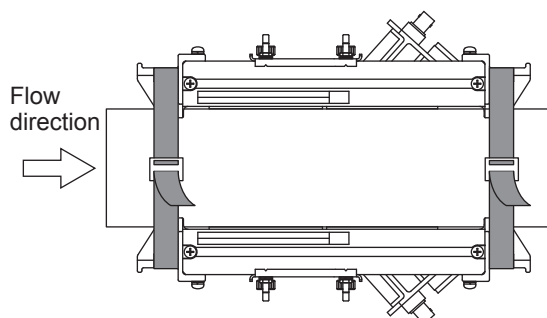

FSDP0

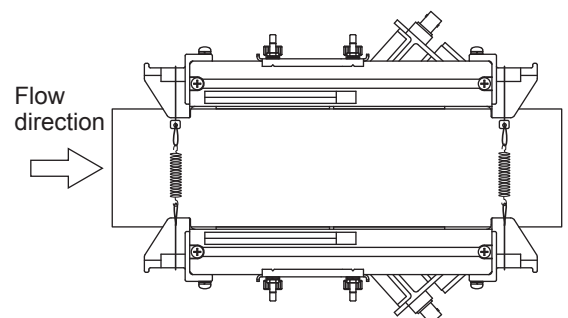

(5) After fastening the sensor to the pipe, screw to the left side, attach the sensor firmly to the pipe.

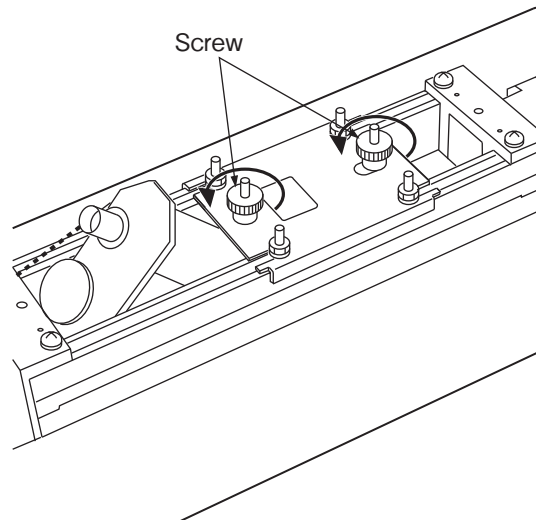

(5) Connect the detector and the converter unit

Connect the sensor unit and the converter unit with the signal cable.
For 1 path, connect them on the upstream side.



For 2 paths, connect them on both side of the upstream and the downstream.



10.7.2 Operation

(1) Flow velocity profile display

(1) Measurement screen

Preparation

Set the following items on the process setting screen

- Pipe outer diameter (Page 27), Material (Page 28), Thickness (Page 29)
- Lining material (Page 30), Thickness (Page 31)
- Fluid kind (Page 32)
- Transmission voltage (Page 36)

Note) For metal pipes, raise the transmission voltage to 160Vp-p.

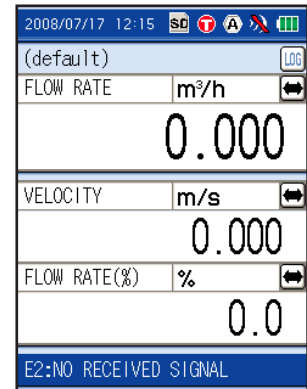

(2) Press **MENU** key to display “MENU” screen.

Select flow velocity profile with the cursor key.

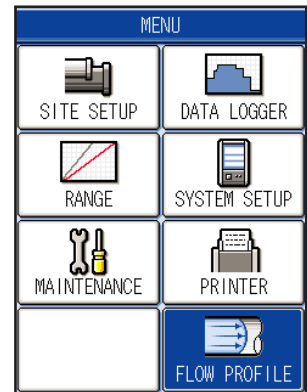

(3) Press the **ENT** key twice, flow velocity profile screen will display.

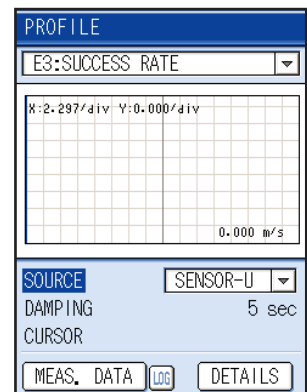
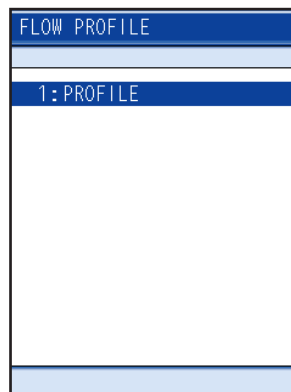

[flow velocity profile screen]

(2) How to observe flow velocity distribution screen

Typical flow velocity distribution measured using two sensors is shown below.
Displays the radius of flow velocity profile by a single sensor.

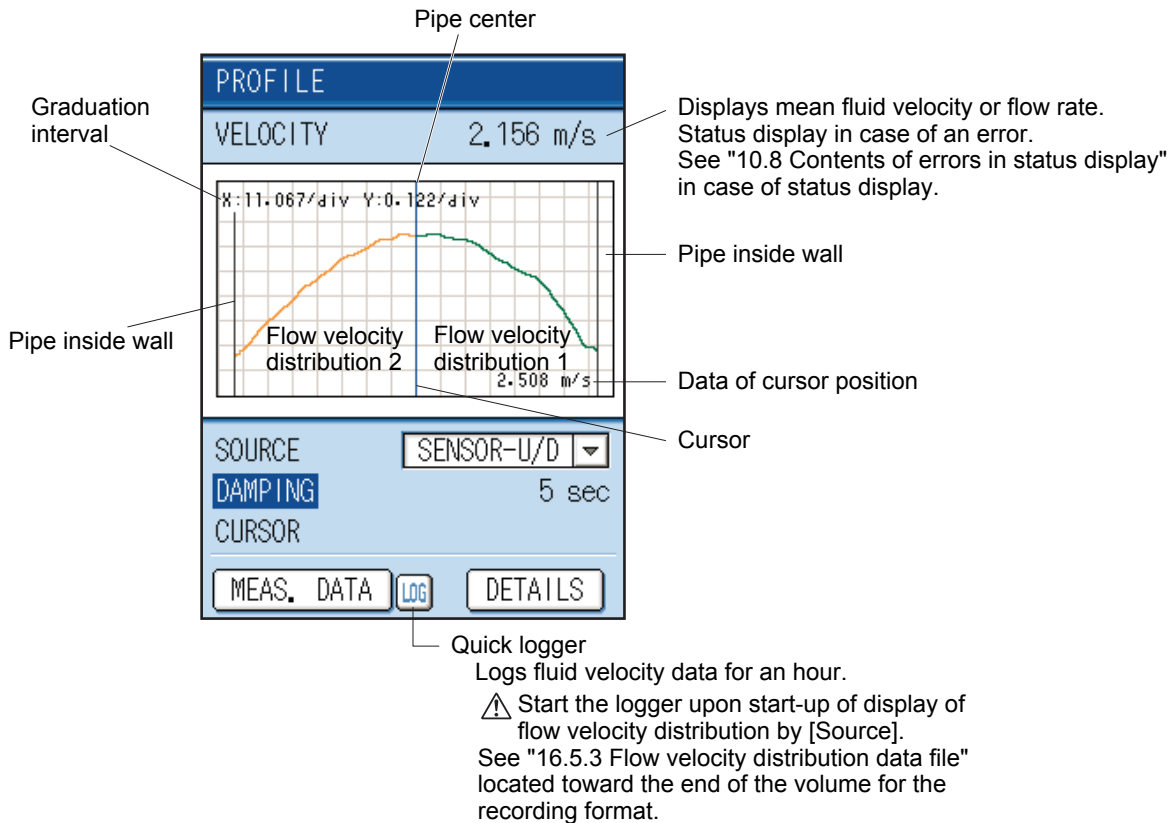

(How to observe Flow velocity distribution 1 and Flow velocity distribution 2)

- [Source]: Select the sensor to be displayed.
⚠ Display of flow velocity distribution begins upon selection of a source.
- [Dumping] The flow velocity distribution is displayed as averaged.
Instantaneous data is displayed, if 0 display is set.
- [Cursor] Move the cursor using ◀, ▶ keys, and check the fluid velocity data.

Case where the measuring range is set as radius F

- Flow velocity distribution 1: Distribution in the radius in case a sensor is connected to the upstream side connector (Sensor U)
- Flow velocity distribution 2: Distribution in the radius in case a sensor is connected to the downstream side connector (Sensor D)

Case where the measuring range is set as radius N

- Flow velocity distribution 1: Distribution in the radius in case a sensor is connected to the downstream side connector (Sensor D)
- Flow velocity distribution 2: Distribution in the radius in case a sensor is connected to the upstream side connector (Sensor U)

Case where the measuring range is set as diameter

Distribution is displayed by diameter in areas of Flow velocity distribution 1 and Flow velocity distribution 2. (Sensor U, Sensor D or Sensor U/D)

Note) Measurement is normally taken in radius F.

(3) Detail setup

Set measuring conditions.

Point the cursor to “DETAILS” by pressing \blacktriangle , \blacktriangledown key, and then press the ENT key.

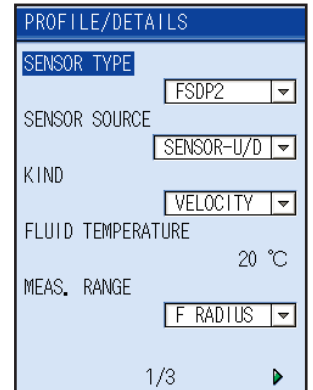
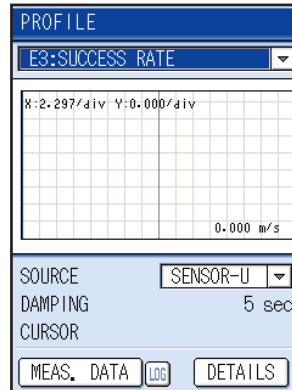

(1) Sensor type

Point the cursor to “SENSOR TYPE” by using the \blacktriangle , \blacktriangledown key and press the ENT key.

Select the type of sensors to be used.

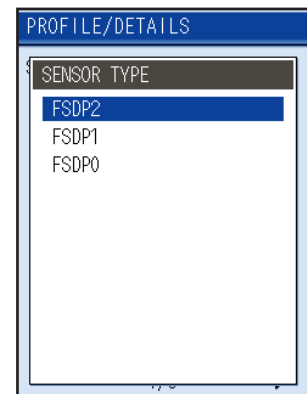

(2) Sensor source

Point the cursor to “SENSOR SOURCE” by using the \blacktriangle , \blacktriangledown key and press the ENT key.

Set connection between the sensor and conversion unit's connector.

Use the upstream side, normally in case one measuring line. (Sensor U)

In case of two measuring lines, use both of upstream side and downstream side. (Sensor U/D)

Make selection corresponding to the connection.

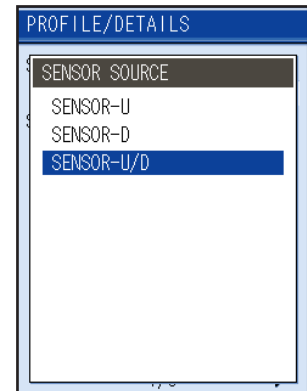

(3) Display selection

Point the cursor to “KIND” by using the \blacktriangle , \blacktriangledown key and press the ENT key.

Either fluid velocity or flow rate is displayed together with flow velocity distribution.

Select the item to be displayed.

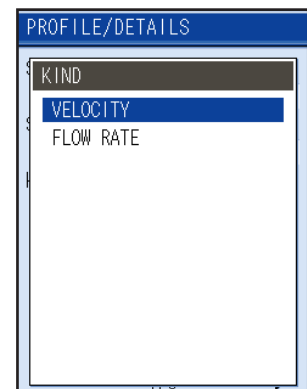

(4) Fluid temperature

Point the cursor to “FLUID TEMPERATURE” by using the \blacktriangle , \blacktriangledown key and press the ENT key.

Input the fluid temperature.

The status for numerical value input is produced when the ENT key is pressed.

Move the cursor to the point to change the numerical value, and change the numerical value using \blacktriangle , \blacktriangledown keys.

Finalize the numerical value by pressing the ENT key.

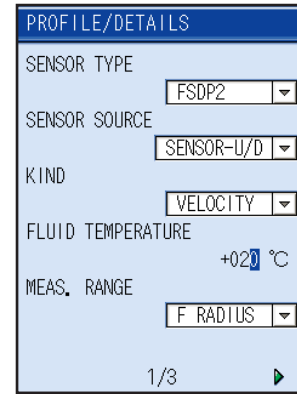

(5) Measuring range

Point the cursor to “MEAS. RANGE” by using the \blacktriangle , \blacktriangledown key and press the ENT key.

Select the range of flow velocity distribution to be measured.

Radius F: Measurement is taken on the radius side opposite to the sensor. (Normally used.)

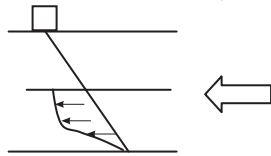

Radius N: Measurement is taken on the radius side adjacent the mounted sensor.

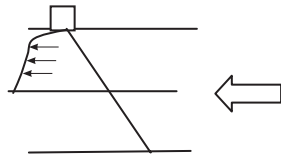

Diameter: Measurement is taken across the entire diameter.

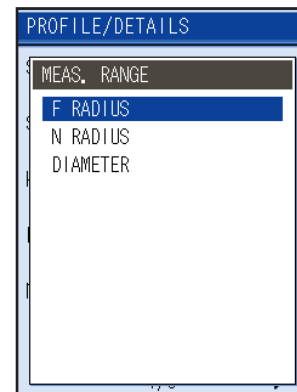
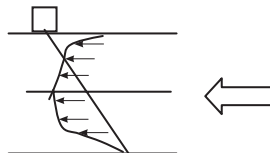

(6) Setup of judgment value

Selects a page by using \blacktriangleleft , \blacktriangleright key.

Set values for judgment of whether flow velocity distribution measurement is normal or abnormal. Success rate error arises, if measured values are less than judgment values. (Normally not used.)

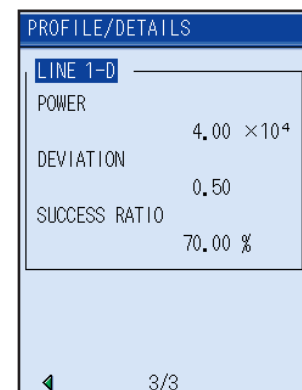
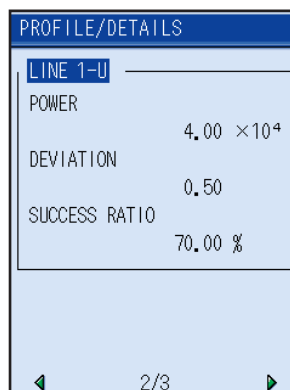

(4) Measured data

Measured data is displayed.

Select measured data by the cursor key, and then press the (ENT) key.

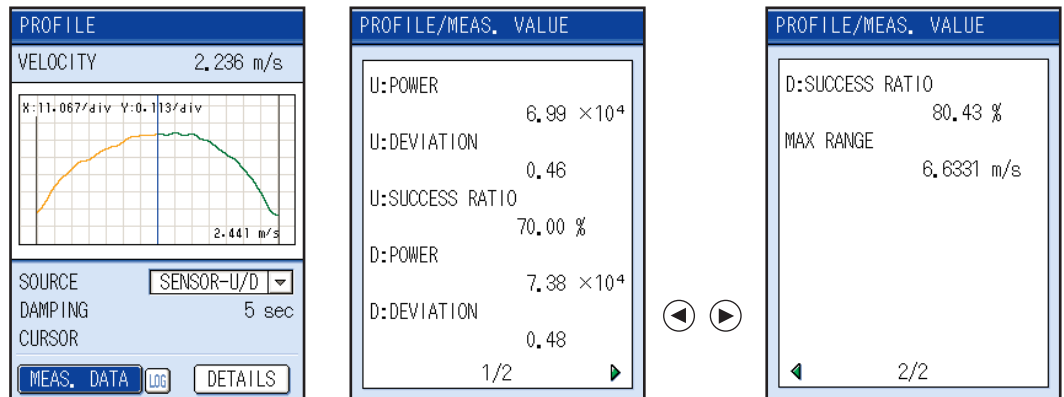

Data of the present measuring conditions is displayed.

Power: Displays the intensity of the incoming signal.

Deviation: Displays the standard deviation of the Doppler shift.

Success rate: Displays the success rate of power and deviation.

MAX range: Displays the maximum measurable flow rate.

Analyzer measurable range can be changed by pipe usage or the sensor to be used in the Pulse Doppler method.

When stainless steel is selected as pipe material, nominal wall thickness is Sch20s, and the fluid is water, the following chart displays the measurable range in above condition.

<Maximum measurable flow velocity>

Unit: m/s

Diameter	FSDP2	FSDP1	FSDP0
40A	6.56		
50A	6.52		
65A	5.31		
80A	4.65		
90A	4.12		
100A	3.69	7.25	
125A	3.08	6.08	
150A	2.63	5.20	
200A	2.04	4.05	7.77
250A		3.30	6.38
300A		2.78	5.41
350A		2.51	4.90
400A		2.20	4.31
450A			3.80
500A			3.48
550A			3.17
600A			2.91
650A			2.71
700A			2.52
750A			2.35
800A			2.21
850A			2.08
900A			1.97
1000A			1.77

<Maximum measurable flow rate>

Unit: m³/h

FSDP2	FSDP1	FSDP0
33.6		
52.7		
72.1		
86.5		
102		
118	231	
147	289	
179	354	
239	474	908
	604	1168
	735	1428
	820	1598
	951	1858
		2118
		2358
		2618
		2879
		3096
		3357
		3618
		3879
		4140
		4400
		4902

10.8 Contents of errors in status display

Use this page for checking the status of this equipment.

The present status is displayed in the measurement screen, propagation time difference receiving waveform screen, and flow velocity profile screen.

If any error was found, take actions in accordance with countermeasures against display contents and "12. ERROR AND REMEDY".

10.8.1 How to check status display

- (1) For checking an error in the measurement screen
Move the cursor to the status display and then press the **(ENT)** key.

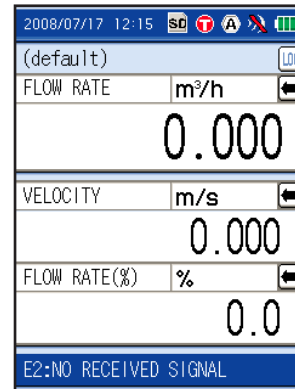

- (2) If multiple errors were found
Move the cursor to the error item to be corrected using **(▲)**, **(▼)** keys, and then press the **(ENT)** key.

- (3) The troubleshooting screen appears.

[**◀**] and [**▶**] are displayed, if the troubleshooting screen is of multiple pages.

Change the page using **(◀)**, **(▶)** keys.

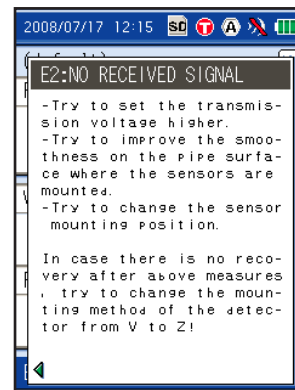
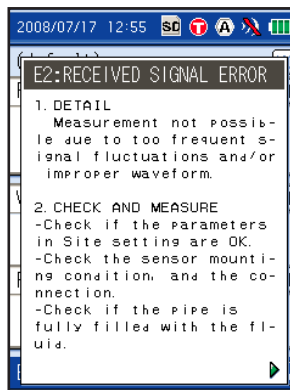

10.8.2 Action on error

(1) Error code: E1

Display the instrument abnormality.

(1) E1: Device error 1

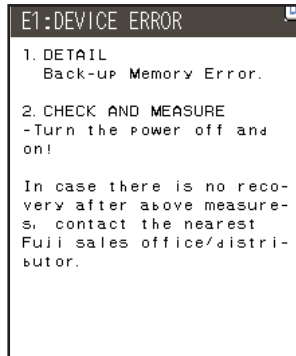

(2) E1: Device error 2

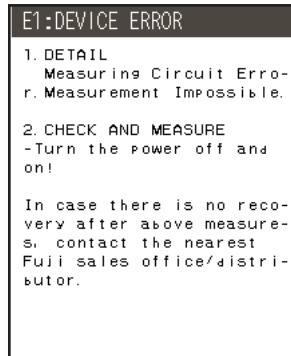

(2) Error code: E2

Display the flow rate abnormality.

(1) E2: Windows scan

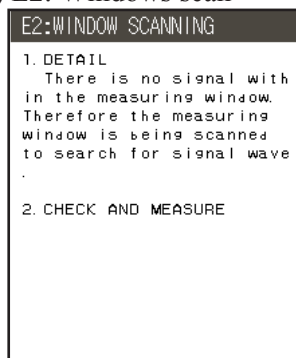

(2) E2: No-received signal

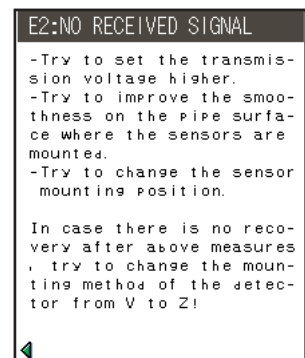
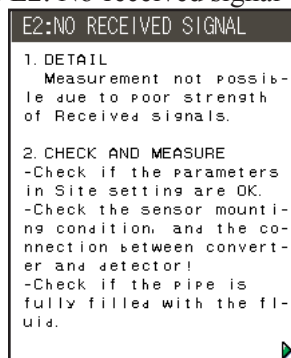

(3) E2: Received signal error

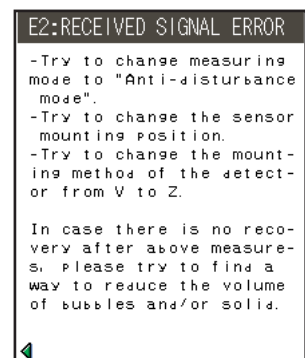
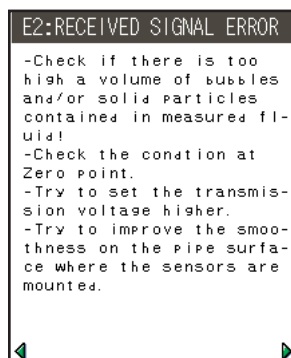
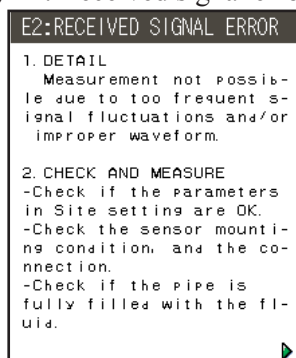

(4) E2: Calculation error 1

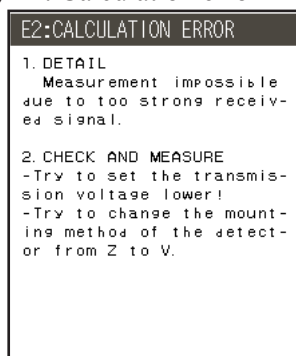

(5) E2: Calculation error 2

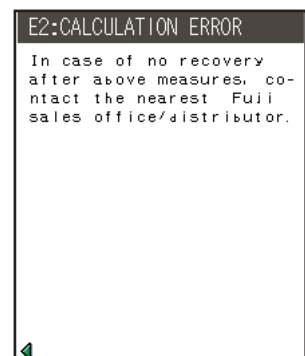
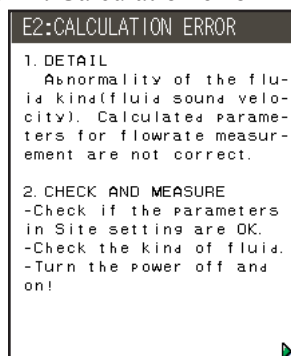

(3) Error code: E3

Display the flow velocity profile measurement.

(1) E3: Measurement range error

```
E3:MEASURE RANGE ERR.
1. DETAIL
  Setting is out of a measurement range. Measurement Impossible.
2. CHECK AND MEASURE
  -Check if the parameters in Site setting are OK.
    Pipe size(inner diameter):40mm to 1000mm
  -Check if the sensor type is correctly selected.
  -Turn the power off and on!
```

(2) E3: Frequency calculation error

```
E3:FREQUENCY ERROR
1. DETAIL
  Measurement impossible due to Error in Measurement Calculation of velocity distribution.
2. CHECK AND MEASURE
  -Check if the parameters in Site setting are OK.
  -Check if the sensor type is correctly selected.
  -Turn the power off and on!
```

```
E3:FREQUENCY ERROR
In case of no recovery after above measures, there is insufficient volume of the particle reflectors in the fluid.
(Measurement impossible.)
```

(3) E3: Success rate

```
E3:SUCCESS RATE
1. DETAIL
  Measurement impossible due to too small a volume of particle reflectors in fluid.
2. CHECK AND MEASURE
  -Check if the parameters in Site setting are OK.
  -Check if the sensor type is correctly selected.
  -Try to reduce the success rate value.
```

(4) Error code: E4

Display the analog output error.

(1) E4: Range over

```
E4:RANGE OVER
1. DETAIL
  Output signal is out of the adjustable range.
2. CHECK AND MEASURE
  -Check and re-set the measuring range.
In case output signal is not needed, set parameter setting of Analog Input/Output function to "OFF"
```

(5) Error code: E5

Display the analog printer error.

(1) E6: Printer fail

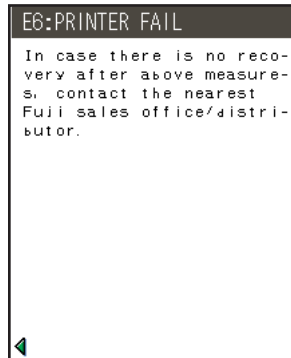
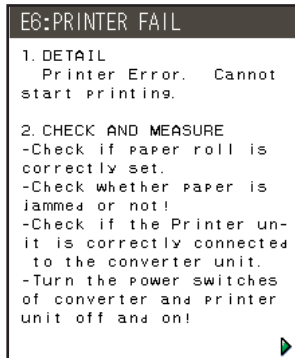

11. MAINTENANCE AND CHECKUP

(1) Cleaning of converter and detector

Wipe off contamination, dust, etc. from the keyboard and main frame of the converter unit occasionally with soft cloth or the like. If contaminants cannot be removed by wiping with dry cloth, moisten cloth with water, wring it adequately and wipe again.

When putting the detector in the carrying case after use, wipe off the grease completely. (Note)

Do not use volatile agents such as benzene and paint thinner for cleaning.

(2) When instrument unused

Put the instrument in the furnished carrying case and store it at a place which meets the following conditions.

- Not exposed to direct sunlight, rain, etc.
- Free from extremely high temperature and humidity (away from a heater)

Storage temperature: -10 to 45°C

- Absence of excessive dust and other contaminants.

Note: Detectors that can be put in the carrying case: only FSSC and FSSD.

(3) Replacement of clock backup battery

In normal usage, the battery has a service life of about 10 years.

When the battery has reached the end of its service life, the clock will be cleared.

For replacement, contact Fuji Electric.

(4) Replacement of LCD

LCD has a lifetime of 5 years or longer when used continuously. When display becomes difficult to be read or the backlight does not come on, the LCD should be replaced with a new one.

For replacement, contact Fuji Electric.

(5) Replacement of built-in battery

If it cannot be charged, it is an indication that the battery life is terminated and it needs to be replaced.

For replacement, be sure to use the battery specified by Fuji Electric (Dwg. No.

ZZP*TK7N6384P1).

(6) Replacement of printer roll-paper

When roll-paper is used for panel copy (hard copy), up to about 777 panels can be printed.

When a red band appears on the roll-paper, it is an indication that little paper is left for printing.

Replace with new one (manufacture: SEIKO I SUPPLY Co. Ltd., Japan, type: TP-211C-1).



(7) Optional items

	Name	Specifications	Arrangement No.
1	Battery	Special type Li-ion battery (7.4V, 2500mAh)×2	ZZP*TK7N6384P1
2	Power adapter	Special type power adapter 90 to 264V AC, 50/60Hz	ZZP*TK7N6380C4
3	Power code	Japan, North America:125V AC 2m Europe, Korea: 250V AC 2m China: 250V AC 2m	ZZP*TK7N6621P1 ZZP*TK7N6608P1 ZZP*TK7N6609P1
4	Printer unit	To be mounted on top of converter Thermal serial dot system (8 x 384 dot)	ZZP*TK4J2634C1
5	Printer roll paper	Maker: SEIKO I SUPPLY Co. Ltd. Type: TP-211C-1 Specifications: Thermal roll paper Width: 58mm×φ48mm, No core	ZZP*TK7N6381P1
6	Silicone grease	Maker: Shin-Etsu Chemical Co., Ltd. Type: · For standard use G40M, 100g · Silicobe free 100g · For high temperature KS62M, 100g	ZZP*45231N5 ZZP*TK7M0981P1 ZZP*TK7P1921C1
7	Signal cable	Special type signal cable, 5m × 2 · Connector on both sides	ZZP*TK7N7795C1
8	Extension signal cable	Special type coaxial cable with BNC connector · 10m × 2 · 50m × 2	ZZP*TK468664C3 ZZP*TK468664C4
9	Analog input/output cable	6-core cable, 1.5m, with connector	ZZP*TK4J2639C1
10	Mounting belt /wire	· Plastic cloth belt · Stainless wire Nominal diameter f200 to f500mm f200 to f1000mm f200 to f2000mm f200 to f3000mm f200 to f6000mm · Stainless steel belt	ZZP*TK7G7979C1 ZZP*TK7G7980C1 ZZP*TK7G7980C2 ZZP*TK7G7980C3 ZZP*TK7G7980C4 ZZP*TK7G7980C5 ZZP*TK7G7981C1
11	Guide rail for FSSH (In mounting by the Z method)	· Mounting bracket material: Aluminum alloy+SUS304	ZZP*TK4J5917C3
12	Guide rail for FSSD3 (In mounting by the Z method)	· Mounting bracket material: Aluminum alloy+plastic	ZZP*TK4J5917C1
13	SD memory card	Maker: Apacer Technology, Inc. Type: AP-ESD256CD21 Capacity: 256MB	ZZP*TK7N6386P1
14	USB cable	Maker: Sunwa Supply Inc. Type: KU-AMB510 Specifications: Mini USB cable (1.0m)	ZZP*TK7N6622P1
15	Signal cable conversion cord	M4 clamp terminals/ BNC juck, L=150mm	ZZP*TK4K6304C1

12. ERROR AND REMEDY

If an error occurs, refer to Table below.

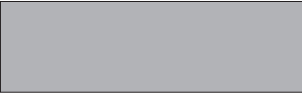
12.1 Error in LCD Display

Status	Cause	Remedy
 No display appears.	<ul style="list-style-type: none"> • Power supply is not turned on. • Voltage is low. • Fuse has blown. • LCD is abnormal. ⇒ See section 11 (4) “Replacement of LCD” • Connection of DC power supply is reverse in polarity. 	
 Irrational display	<ul style="list-style-type: none"> • Hardware error 	
 Display is not clear.	<ul style="list-style-type: none"> • Ambient temperature is high (50°C or higher) ⇒ Lower the temperature. • LCD has reached the end of its service life. ⇒ Replace the LCD. 	
 Entire display is blackish.	<ul style="list-style-type: none"> • Line voltage is low. • LCD is abnormal. ⇒ See section 11 (4) “Replacement of LCD” • Ambient temperature is high (50°C or higher) ⇒ Lower the temperature. 	

12.2 Error of key

No response is made to key input.	<ul style="list-style-type: none"> • Hardware error
Any particular key does not function or functions in a wrong way.	

12.3 Error in measured value

State	Cause	Remedy
Indication of measured value is negative (-).	<ul style="list-style-type: none"> • Connection between the main unit and sensors (upstream sensor and downstream sensor) is reverse. 	⇒ Connect correctly.
	<ul style="list-style-type: none"> • Fluid is actually flowing in the (-) direction. 	
Measured value fluctuated widely though flow rate is constant.	<ul style="list-style-type: none"> • Straight pipe portion is inadequate. 	⇒ Shift measurement location to the site where 10D and 5D can be secured on the upstream and downstream sides.
	<ul style="list-style-type: none"> • A flow disturbing factor such as pump or valve is provided in the vicinity. 	⇒ Mount the instrument with a clearance of 30D or more.
	<ul style="list-style-type: none"> • Pulsation is occurring actually. 	⇒ Extend response time through damping setting.
Measured value remains the same though flow rate is changing.	<ul style="list-style-type: none"> • Measured value is held because ultrasonic wave cannot be propagated into a pipe. 	
	<p>1. Incomplete installation</p> <div style="border: 1px solid black; padding: 5px;"> <ul style="list-style-type: none"> • Piping specifications are wrong. • Sensor is mounted at the welded part. • Sensor mounting dimension is wrong. • Grease application at sensor mounting is incomplete. • Sensor connector is not connected completely. • Pipe surface is contaminated. </div> <p>⇒</p> <div style="border: 1px solid black; padding: 5px;"> <p>After check, separate the sensor once. Apply the grease again and remount the sensor with a slight shift.</p> </div> <p>2. Problem on pipe or fluid</p> <div style="border: 1px solid black; padding: 5px;"> <ul style="list-style-type: none"> • When V method is used, it should be changed to Z method. • When sensor extension cable is used, it should be avoided. • If error persists, check and eliminate the true cause as instructed below. </div> <p>◎</p> <div style="border: 1px solid black; padding: 5px;"> <p>Fluid is not filled.</p> </div> <p>⇒</p> <div style="border: 1px solid black; padding: 5px;"> <p>Find the location on the same pipe line, where fluid is filled up and move the sensors to that location. Mount the sensors at the lowest location on pipe line.</p> </div>	

State	Cause	Remedy
	<p>① Air bubbles have entered.</p> <p>[In case measurement is normal with water flow stopped, entrance of air bubbles is the cause of this error.]</p> <p>[When the sensor is mounted just after a valve, cavitation will occur to cause the same effect as entrance of air bubbles.]</p> <p>② Turbidity is high.</p> <p>[Turbidity is higher than those of sewage and return sludge.]</p> <p>③ Because of an old pipe, scale has stuck to the inside.</p> <p>④ Lining is thick.</p> <p>[Because of mortar lining or the like, thickness is a few ten mm or more.]</p> <p>⑤ Lining is peeled.</p> <p>[There is a gap between lining and piping.]</p> <p>⑥ Sensor is mounted at a bent pipe or tapered pipe.</p> <p>3. Influence by external noise</p> <p>[• There is a radio broadcasting station in the vicinity.] [• Measurement has been conducted near heavy traffic.]</p> <p>• Sensor mounting is incomplete. • Mounting dimension is improper. • Sensor is not in contact with pipe.</p> <p>4. Hardware error</p>	<p>⇒ Eliminate entrance of air bubbles.</p> <ul style="list-style-type: none"> • Raise the level of pump well. • Confirm the shaft seal of pump. • Retighten the flange of negative pressure piping. • Prevent fluid from rushing into pump well. <p>-----</p> <p>Move the sensor to the location where air bubbles have not entered.</p> <ul style="list-style-type: none"> • To the inlet side of pump • To the upstream side of valve <p>⇒</p> <ul style="list-style-type: none"> • Change the sensor mounting method from V to Z. • Move the sensor to the location on the same line, where the outer diameter of pipe is smaller. • Move to a different place or different pipe. • Raise the voltage for transmission (refer to p.36). <p>↓</p> <p>Try measurement with the optional large size sensor.</p> <p>⇒ Contact Fuji Electric.</p> <p>⇒ Mount to a straight pipe.</p> <p>⇒</p> <ul style="list-style-type: none"> • Minimize the cable between main unit and sensors. <p>⇒</p> <p>Mount the sensors in parallel with the pipe following the correct mounting dimension. Bring the sensor in close contact with the pipe.</p> <p>⇒ Contact Fuji Electric.</p>

State	Cause	Remedy
Measured value is not zero though water flow has stopped.	<ul style="list-style-type: none"> Water is subjected to convection in a pipe. Zero adjustment has been performed. When water flow stops, pipe is not filled up with water or becomes empty. 	<ul style="list-style-type: none"> ⇒ Normal ⇒ • Perform zero adjustment again after making sure water flow has stopped completely. ⇒ • The measured value, just when ultrasonic wave cannot be propagated, is held. ⇒ Normal
Measured value has an error.	<ul style="list-style-type: none"> Input piping specifications are different from actual ones. Because of an old pipe, scale has stuck. ⊙ The length of straight pipe portion is inadequate. 10D and 5D are required at least on the upstream and downstream sides. Flow disturbing element should not be present within 30D on upstream side. Pump, valve, flow joining pipe or the like is unallowable. Pipe is not filled with water or mud and sand have precipitated. 	<ul style="list-style-type: none"> ⇒ • A difference of 1% in inner diameter causes an error of about 3%. ↓ ⇒ • Input specifications correctly. • Input scale as lining. ⇒ Select a different location of sensor mounting (move the upstream side of a flow disturbing element). • Mount the sensor at different angles with respect to the cross section of pipe to find the location where mean value is obtainable. The mount the sensor at that location. ⇒ Precipitation is more when the cross section of pipe has a smaller area. ↓ Shift the sensor to the vertical portion of pipe.
Flow velocity profile is not available.	<ul style="list-style-type: none"> ⊙ No reflector in the fluid or weak reflection. ⊙ Low flow velocity. 	<ul style="list-style-type: none"> ⇒ Measure in a place subject to reflector. ⇒ Increase flow velocity.

12.4 Error in analog output

State	Cause	Remedy
Output remains at 4mA though indication value is other than 0.	<ul style="list-style-type: none"> ⊙ Full scale range setting has not been made. 	<ul style="list-style-type: none"> ⇒ Set the full scale. Otherwise, output remains at 4mA.
Output is 0mA.	<ul style="list-style-type: none"> ⊙ Cable is broken. ⊙ The setting of analog output is set as "NOT USED". 	<ul style="list-style-type: none"> ⇒ Repair ⇒ Change to "USE".
Output is not 4mA when indication value is 0.	<ul style="list-style-type: none"> ⊙ The zero point of analog output is not adjusted properly. 	<ul style="list-style-type: none"> ⇒ Calibrate analog output.
Output rises beyond 20mA.	<ul style="list-style-type: none"> ⊙ Indication value is larger than analog span value. ⊙ Span is deviated. 	<ul style="list-style-type: none"> ⇒ Overshoot Set analog span again. Calibrate analog output.
Analog output remains the same despite change in indication value.	<ul style="list-style-type: none"> ⊙ Output load is larger than 600Ω. 	<ul style="list-style-type: none"> ⇒ Permissible load is 600Ω. Reduce the load to less than 600Ω.
Indication value does not match analog output.	<ul style="list-style-type: none"> • Zero point and span of analog output are deviated. 	<ul style="list-style-type: none"> ⇒ Calibrate analog output.
Output remains the same even after calibration of analog output.	<ul style="list-style-type: none"> • Hardware error 	<ul style="list-style-type: none"> ⇒ Contact Fuji Electric.

13. EXTERNAL COMMUNICATION SPECIFICATION

(1) General specification

Item	Specification
Transmission scheme	Half duplex
Synchronization scheme	Asynchronous
Transmission rate	500kBPS
Parity	Odd parity
Start/stop bit	1 bit
Data length	8 bits
Station	0, fixed
Number of connectable units	1 unit
Transmission code	Hexadecimal value (MODBUS RTU mode)
Error detection	CRC-16
Echo back	None
Flow control	Xon/off

(2) Interface specification

Electrical specification: Conforms to USB standard.

Cable length: 3 m or less

Conforming cable: Mini USB cable

Connection scheme: 1:1 connection

■ Support software

Loader software for PC is provided as standard.

- Main function: To display and change main unit parameters (site setup), and to acquire measured data.

It is capable of importing instantaneous flow rate, instantaneous fluid velocity, integrated value, error information, wave receiving level and others.

See "PortaFlow-C LOADER INSTRUCTION MANUAL: INF-TN5A1784-E (separate volume) for details.

14. HOW TO USE PRINTER

14.1 How to connect printer

- (1) Turn off the power supply of main unit.
- (2) Remove the rubber guards.



- (3) Detach the top cover of main unit.



- (4) Attach the printer.
Connect the printer cord.

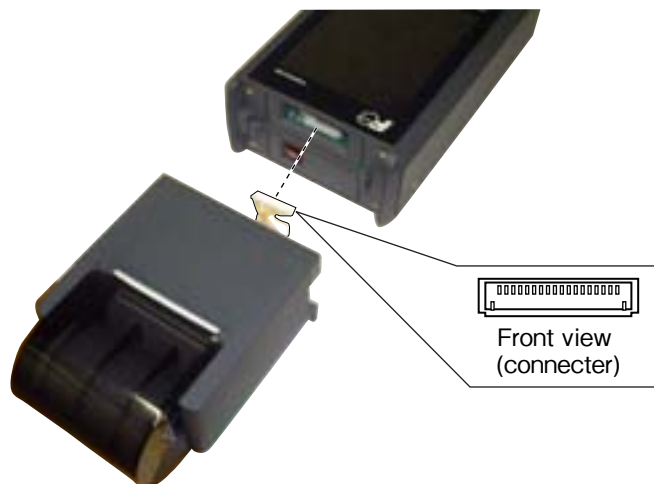

-
- (5) Install the printer with 2 screws.



- (6) Install the rubber guards
Note) Install it so that the groove of the rubber guards may fit tightly on the edges of the main unit.
- (7) Turn ON the power supply of the main unit.

14.2 How to load printer roll sheet

- (1) Open the cover and load a roll sheet



- (2) Insert the edge of roll paper into the head assembly.

Cut the edge of the recording paper so that central part of it can be inserted first.

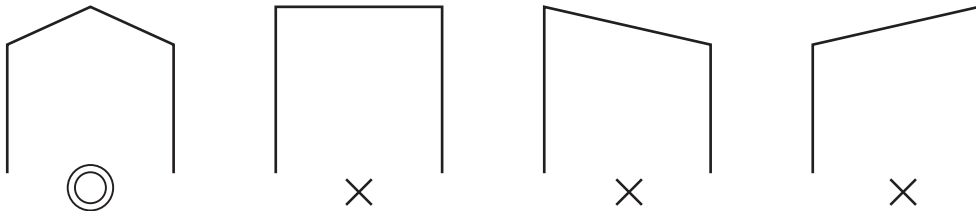

Insert the paper straight to the paper insertion section.



⚠ CAUTION

Don't pull the sheet opposite the FEED direction, or printer damage may result.

- (3) For feed paper, use FEED key of the main unit.



15. REPLACEMENT OF BUILT-IN BATTERY

- (1) Turn off the power supply of main unit.
- (2) Remove the rubber guard.



- (3) Locate 4 screws at the corners of the back cover diagram label. Remove the 4 screws and cover as shown.



- (4) Remove the battery and replace it with the appropriate service part.
Note) Install a combination of the main unit side terminal and the battery side terminal.



CAUTION

- Do not give the equipment a shock
- Do not disassemble or modify the equipment
- Do not use the equipment with the built-in battery removed..

16. APPENDIX

16.1 Piping data

(1) Stainless steel pipe for pipe arrangement (JIS G3459-2012)

Nominal diameter		Outer diameter mm	Thickness						
			Schedule 5S	Schedule 10S	Schedule 20S	Schedule 40	Schedule 80	Schedule 120	Schedule 160
A	B		Thickness mm	Thickness mm	Thickness mm	Thickness mm	Thickness mm	Thickness mm	Thickness mm
10	1/8	17.3	1.2	1.65	2.0	2.3	3.2	–	–
15	1/2	21.7	1.65	2.1	2.5	2.8	3.7	–	4.7
20	3/4	27.2	1.65	2.1	2.5	2.9	3.9	–	5.5
25	1	34.0	1.65	2.8	3.0	3.4	4.5	–	6.4
32	1 1/4	42.7	1.65	2.8	3.0	3.6	4.9	–	6.4
40	1 1/2	48.6	1.65	2.8	3.0	3.7	5.1	–	7.1
50	2	60.5	1.65	2.8	3.5	3.9	5.5	–	8.7
65	2 1/2	76.3	2.1	3.0	3.5	5.2	7.0	–	9.5
80	3	89.1	2.1	3.0	4.0	5.5	7.6	–	11.1
90	3 1/2	101.6	2.1	3.0	4.0	5.7	8.1	–	12.7
100	4	114.3	2.1	3.0	4.0	6.0	8.6	11.1	13.5
125	5	139.8	2.8	3.4	5.0	6.6	9.5	12.7	15.9
150	6	165.2	2.8	3.4	5.0	7.1	11.0	14.3	18.2
200	8	216.3	2.8	4.0	6.5	8.2	12.7	18.2	23.0
250	10	267.4	3.4	4.0	6.5	9.3	15.1	21.4	28.6
300	12	318.5	4.0	4.5	6.5	10.3	17.4	25.4	33.3
350	14	355.6	–	–	–	11.1	19.0	27.8	35.7
400	16	406.4	–	–	–	12.7	21.4	30.9	40.5
450	18	457.2	–	–	–	14.3	23.8	34.9	45.2
500	20	508.0	–	–	–	15.1	26.2	38.1	50.0
550	22	558.8	–	–	–	15.9	28.6	41.3	54.0
600	24	609.6	–	–	–	17.5	31.0	46.0	59.5
650	26	660.4	–	–	–	18.9	34.0	49.1	64.2

(2) Polyethylene pipe for city water (JIS K6762-2010)

Nominal diameter (mm)	Outer diameter (mm)	1st type (Soft pipe)		2nd type (Hard pipe)	
		Thickness (mm)	Weight (kg/m)	Thickness (mm)	Weight (kg/m)
13	21.5	3.5	0.184	2.5	0.143
20	27.0	4.0	0.269	3.0	0.217
25	34.0	5.0	0.423	3.5	0.322
30	42.0	5.6	0.595	4.0	0.458
40	48.0	6.5	0.788	4.5	0.590
50	60.0	8.0	1.216	5.0	0.829

(3) Galvanized steel pipe for city water SGPW (JIS G3442-2010)

How to call pipe		Outer diameter (mm)	Thickness (mm)
(A)	(B)		
15	1/2	21.7	2.8
20	3/4	27.2	2.8
25	1	34.0	3.2
32	1 1/4	42.7	3.5
40	1 1/2	48.6	3.5
50	2	60.5	3.8
65	2 1/2	76.3	4.2
80	3	89.1	4.2
90	3 1/2	101.6	4.2
100	4	114.3	4.5
125	5	139.8	4.5
150	6	165.2	5.0
200	8	216.3	5.8
250	10	267.4	6.6
300	12	318.5	6.9
350	14	355.6	7.9
400	16	406.4	7.9
450	18	457.2	7.9
500	20	508.0	7.9

(4) Polyethylene pipe for general use (JIS K6761-1998)

Nominal diameter	Outer diameter (mm)	1st type (Soft pipe)	2nd type (Hard pipe)
		Thickness (mm)	Thickness (mm)
13	21.5	2.7	2.4
20	27.0	3.0	2.4
25	34.0	3.0	2.6
30	42.0	3.5	2.8
40	48.0	3.5	3.0
50	60.0	4.0	3.5
65	76.0	5.0	4.0
75	89.0	5.5	5.0
100	114	6.0	5.5
125	140	6.5	6.5
150	165	7.0	7.0
200	216	-	8.0
250	267	-	9.0
300	318	-	10.0

(6) Hi vinyl chloride pipe (conduit size)

Nominal diameter of pipe	Outer diameter	Pipe thickness
ND32	32	1.6
ND40	40	1.9
ND50	50	2.4
ND63	63	3.0
ND75	75	3.6
ND90	90	4.3
ND110	110	4.7
ND125	125	4.8
ND140	140	5.4
ND160	160	6.2

(8) PVC pipe PVC-U (JIS K6741-2007)

Type Nominal (mm)	VP		VU	
	Outer diameter	Thickness	Outer diameter	Thickness
13	18	2.2	-	-
16	22	2.7	-	-
20	26	2.7	-	-
25	32	3.1	-	-
30	38	3.1	-	-
40	48	3.6	48	1.8
50	60	4.1	60	1.8
65	76	4.1	76	2.2
75	89	5.5	89	2.7
100	114	6.6	114	3.1
125	140	7.0	140	4.1
150	165	8.9	165	5.1
200	216	10.3	216	6.5
250	267	12.7	267	7.8
300	318	15.1	318	9.2
350	-	-	370	10.5
400	-	-	420	11.8
450	-	-	470	13.2
500	-	-	520	14.6
600	-	-	630	17.8
700	-	-	732	21.0

(5) PVC pipe for water (JIS K6742-2007)

VP: PVC pipe
HIVP: anti-shock PVC pipe etc.

Nominal diameter	Outer diameter	Pipe thickness
13	18.0	2.5
20	26.0	3.0
25	32.0	3.5
30	38.0	3.5
40	48.0	4.0
50	60.0	4.5
75	89.0	5.9
100	114.0	7.1
125	140.0	7.5
150	165.0	9.6

(7) Vertical type cast iron pipe (JIS G5521)

Nominal diameter D	Pipe thickness T		Actual outer diameter D1
	T		
	Normal pressure pipe	Low pressure pipe	
75	9.0	-	93.0
100	9.0	-	118.0
150	9.5	9.0	169.0
200	10.0	9.4	220.0
250	10.8	9.8	271.6
300	11.4	10.2	322.8
350	12.0	10.6	374.0
400	12.8	11.0	425.6
450	13.4	11.5	476.8
500	14.0	12.0	528.0
600	15.4	13.0	630.8
700	16.5	13.8	733.0
800	18.0	14.8	836.0
900	19.5	15.5	939.0
1000	22.0	-	1041.0
1100	23.5	-	1144.0
1200	25.0	-	1246.0
1350	27.5	-	1400.0
1500	30.0	-	1554.0

(9) Carbon steel pipe for pipe arrangement SGP (JIS G3452-2010)

How to call pipe		Outer diameter (mm)	Thickness (mm)
(A)	(B)		
15	1/2	21.7	2.8
20	3/4	27.2	2.8
25	1	34.0	3.2
32	1 1/4	42.7	3.5
40	1 1/2	48.6	3.5
50	2	60.5	3.8
65	2 1/2	76.3	4.2
80	3	89.1	4.2
90	3 1/2	101.6	4.2
100	4	114.3	4.5
125	5	139.8	4.5
150	6	165.2	5.0
175	7	190.7	5.3
200	8	216.3	5.8
225	9	241.8	6.2
250	10	267.4	6.6
300	12	318.5	6.9
350	14	355.6	7.9
400	16	406.4	7.9
450	18	457.2	7.9
500	20	508.0	7.9

(10) Steel pipe coated for city water STW (JIS G3443-1:2007)

Nominal diameter (A)	Outer diameter (mm)	Symbol for type			
		STW 290	STW 370	STW 400	
				Nominal	thickness
		A	B		
Thickness (mm)	Thickness (mm)	Thickness (mm)	Thickness (mm)		
80	89.1	4.2	4.5	—	—
100	114.3	4.5	4.9	—	—
125	139.8	4.5	5.1	—	—
150	165.2	5.0	5.5	—	—
200	216.3	5.8	6.4	—	—
250	267.4	6.6	6.4	—	—
300	318.5	6.9	6.4	—	—
350	355.6	—	—	6.0	—
400	406.4	—	—	6.0	—
450	457.2	—	—	6.0	—
500	508.0	—	—	6.0	—
600	609.6	—	—	6.0	—
700	711.2	—	—	7.0	6.0
800	812.8	—	—	8.0	7.0
900	914.4	—	—	8.0	7.0
1000	1016.0	—	—	9.0	8.0
1100	1117.6	—	—	10.0	8.0
1200	1219.2	—	—	11.0	9.0
1350	1371.6	—	—	12.0	10.0
1500	1524.0	—	—	14.0	11.0
1600	1625.6	—	—	15.0	12.0
1650	1676.4	—	—	15.0	12.0
1800	1828.8	—	—	16.0	13.0
1900	1930.4	—	—	17.0	14.0
2000	2032.0	—	—	18.0	15.0
2100	2133.6	—	—	19.0	16.0
2200	2235.2	—	—	20.0	16.0
2300	2336.8	—	—	21.0	17.0
2400	2438.4	—	—	22.0	18.0
2500	2540.0	—	—	23.0	18.0
2600	2641.6	—	—	24.0	19.0
2700	2743.2	—	—	25.0	20.0
2800	2844.8	—	—	26.0	21.0
2900	2946.4	—	—	27.0	21.0
3000	3048.0	—	—	29.0	22.0

(11) Centrifugal nodular graphite cast iron pipe for city water (A type) (JWWA G-105 1971)

Nominal diameter	Pipe thickness			Actual outer diameter
	T			
D	1st type pipe	2nd type pipe	3rd type pipe	D ₁
75	7.5	—	6.0	93.0
100	7.5	—	6.0	118.0
150	7.5	—	6.0	169.0
200	7.5	—	6.0	220.0
250	7.5	—	6.0	271.6
300	7.5	—	6.5	332.8
350	7.5	—	6.5	374.0
400	8.5	7.5	7.0	425.6
450	9.0	8.0	7.5	476.8
500	9.5	8.5	7.0	528.0

(12) Centrifugal nodular graphite cast iron pipe for city water (K type) (JWWA G-105 1971)

Nominal diameter	Pipe thickness			Actual outer diameter
	T			
D	1st type pipe	2nd type pipe	3rd type pipe	D ₁
400	8.5	7.5	7.0	425.6
450	9.0	8.0	7.5	476.8
500	9.5	8.5	8.0	528.0
600	11.0	10.0	9.0	630.8
700	12.0	11.0	10.0	733.0
800	13.5	12.0	11.0	836.0
900	15.0	13.0	12.0	939.0
1000	16.5	14.5	13.0	1041.0
1100	18.0	15.5	14.0	1144.0
1200	19.5	17.0	15.0	1246.0
1350	21.5	18.5	16.5	1400.0
1500	23.5	20.5	18.0	1554.0

(13) Arc welded large-diameter stainless steel pipe for pipe arrangement SUS (JIS G3468-2011)

Nominal diameter		Outer diameter (mm)	Nominal thickness			
			Schedule 5S	Schedule 10S	Schedule 20S	Schedule 40S
A	B		Thickness mm	Thickness mm	Thickness mm	Thickness mm
150	6	165.2	2.8	3.4	5.0	7.1
200	8	216.3	2.8	4.0	6.5	8.2
250	10	267.4	3.4	4.0	6.5	9.3
300	12	318.5	4.0	4.5	6.5	10.3
350	14	355.6	4.0	5.0	8.0	11.1
400	16	406.4	4.5	5.0	8.0	12.7
450	18	457.2	4.5	5.0	8.0	14.3
500	20	508.0	5.0	5.5	9.5	15.1
550	22	558.8	5.0	5.5	9.5	15.9
600	24	609.6	5.5	6.5	9.5	17.5
650	26	660.4	5.5	8.0	12.7	–
700	28	711.2	5.5	8.0	12.7	–
750	30	762.0	6.5	8.0	12.7	–
800	32	812.8	–	8.0	12.7	–
850	34	863.6	–	8.0	12.7	–
900	36	914.4	–	8.0	12.7	–
1000	40	1016.0	–	9.5	14.3	–

(14) Ductile iron specials (JIS G5527-1998)

Nominal diameter (mm)	Pipe thickness (mm)
75	8.5
100	8.5
150	9.0
200	11.0
250	12.0
300	12.5
350	13.0
400	14.0
450	14.5
500	15.0
600	16.0
700	17.0
800	18.0
900	19.0
1000	20.0
1100	21.0
1200	22.0
1350	24.0
1500	26.0
1600	27.5
1650	28.0
1800	30.0
2000	32.0
2100	33.0
2200	34.0
2400	36.0

(15) Dimensions of centrifugal sand mold cast iron pipe (JIS G5522) For reference, following items are discontinued.

Nominal diameter D	Pipe thickness (T)			Actual outer diameter D ₁
	High pressure pipe	Normal pressure pipe	Low pressure pipe	
75	9.0	7.5	–	93.0
100	9.0	7.5	–	118.0
125	9.0	7.8	–	143.0
150	9.5	8.0	7.5	169.0
200	10.0	8.8	8.0	220.0
250	10.8	9.5	8.4	271.6
300	11.4	10.0	9.0	322.8
350	12.0	10.8	9.4	374.0
400	12.8	11.5	10.0	425.6
450	13.4	12.0	10.4	476.8
500	14.0	12.8	11.0	528.0
600	–	14.2	11.8	630.8
700	–	15.5	12.8	733.0
800	–	16.8	13.8	836.0
900	–	18.2	14.8	939.0

(16) Dimensions of centrifugal sand mold cast iron pipe (JIS G5523 1977) For reference, following items are discontinued.

Nominal diameter (mm)	Pipe thickness (T)		Actual outer diameter D ₁
	High pressure pipe	Normal pressure pipe	
75	9.0	7.5	93.0
100	9.0	7.5	118.0
125	9.0	7.8	143.0
150	9.5	8.0	169.0
200	10.0	8.8	220.0
250	10.8	9.5	271.6
300	11.4	10.0	322.8

(19) Cast iron pipe for waste water(JIS G5525-1975)

Nominal diameter	Mechanical type								Insertion type	
	1st type pipe				2nd type pipe				RJ pipe	
	Straight pipe		Deformed pipe		Straight pipe		Deformed pipe		Straight/deformed pipe	
	Outer diameter	Pipe thickness	Outer diameter	Pipe thickness	Outer diameter	Pipe thickness	Outer diameter	Pipe thickness	Outer diameter	Pipe thickness
50	58	4	60	5	—	—	58	4	—	—
75	83	4	85	5	83	4	83	4	89	4.5
100	108	4	110	5	108	4	108	4	114	4.5
125	134	4.5	136	5.5	134	4.5	134	4.5	140	4.5
150	159	4.5	161	5.5	—	—	—	—	—	—
200	211	5.5	213	6.5	—	—	—	—	—	—

(18) Arc welded carbon steel pipe STPY 400 (JIS G3457:2012)

(Unit mass: kg/m)

Nominal diameter	Thickness (mm)		Outer diameter (mm)													
			6.0	6.4	7.1	7.9	8.7	9.5	10.3	11.1	11.9	12.7	13.1	15.1	15.9	
(A)	(B)	Outer diameter (mm)														
350	14	355.6	51.7	55.1	61.0	67.7										
400	16	406.4	59.2	63.1	69.9	77.6										
450	18	457.2	66.8	71.1	78.8	87.5										
500	20	508.0	74.3	79.2	87.7	97.4	107	117								
550	22	558.8	81.8	87.2	96.6	107	118	129	139	150	160	171				
600	24	609.6	89.3	95.2	105	117	129	141	152	164	175	187				
650	26	660.4	96.8	103	114	127	140	152	165	178	190	203				
700	28	711.2	104	111	123	137	151	164	178	192	205	219				
750	30	762.0		119	132	147	162	176	191	206	220	235				
800	32	812.8		127	141	157	173	188	204	219	235	251	258	297	312	
850	34	863.6				167	183	200	217	233	250	266	275	316	332	
900	36	914.4				177	194	212	230	247	265	282	291	335	352	
1000	40	1016.0				196	216	236	255	275	295	314	324	373	392	
1100	44	1117.6						260	281	303	324	346	357	411	432	
1200	48	1219.2						283	307	331	354	378	390	448	472	
1350	54	1371.6									399	426	439	505	532	
1500	60	1524.0									444	473	488	562	591	
1600	64	1625.6											521	600	631	
1800	72	1828.8											587	675	711	
2000	80	2032.0												751	791	

(19) Stainless steel sanitary pipe SUS (JIS G3447:2009)

Outer diameter (mm)	Thickness (mm)	Internal diameter (mm)
25.4	1.2	23.0
31.8	1.2	29.4
38.1	1.2	35.7
50.8	1.5	47.8
63.5	2.0	59.5
76.3	2.0	72.3
89.1	2.0	85.1
101.6	2.0	97.6
114.3	3.0	108.3
139.8	3.0	133.8
165.2	3.0	159.2

(20) PVDF-HP

Outer diameter (mm)	SDR33	SDR21	SDR17
	S16 PN10	S10 PN16	S8 PN20
	Thickness (mm)	Thickness (mm)	Thickness (mm)
16		1.5	1.5
20		1.9	1.9
25		1.9	1.9
32		2.4	2.4
40		2.4	2.4
50		3.0	3.0
63	2.5	3.0	
75	2.5	3.6	
90	2.8	4.3	
110	3.4	5.3	
125	3.9	6.0	
140	4.3	6.7	
160	4.9	7.7	
180	5.5	8.6	
200	6.2	9.6	
225	6.9	10.8	
250	7.7	11.9	
280	8.6	13.4	
315	9.7	15.0	
355	10.8		
400	12.2		
450	13.7		

(21) Heat-resistant hard vinyl chloride pipe PVC-C (JIS K6776:2007)

Nominal diameter	Outer diameter (mm)	Thickness (mm)	Weight (kg/m)
13	18.0	2.5	0.180
16	22.0	3.0	0.265
20	26.0	3.0	0.321
25	32.0	3.5	0.464
30	38.0	3.5	0.561
40	48.0	4.0	0.818
50	60.0	4.5	1.161

(22) Polyethylene pipe for city water service

(Japan Polyethylene Pipes Association for Water Service standard PTC K 03:2006)

Nominal diameter	Outer diameter (mm)	Thickness (mm)	Inner diameter (mm)	Weight (kg/m)
50	63.0	5.8	50.7	1.074
75	90.0	8.2	72.6	2.174
100	125.0	11.4	100.8	4.196
150	180.0	16.4	145.3	8.671
200	250.0	22.7	201.9	16.688

(23) Velocity of sound subject to change temperature in water (0 to 100°C)

T°C	Vm/s	T°C	Vm/s	T°C	Vm/s	T°C	Vm/s
0	1402.74						
1	1407.71	26	1499.64	51	1543.93	76	1555.40
2	1412.57	27	1502.20	52	1544.95	77	1555.31
3	1417.32	28	1504.68	53	1545.92	78	1555.18
4	1421.96	29	1507.10	54	1546.83	79	1555.02
5	1426.50	30	1509.44	55	1547.70	80	1554.81
6	1430.92	31	1511.71	56	1548.51	81	1554.57
7	1435.24	32	1513.91	57	1549.28	82	1554.30
8	1439.46	33	1516.05	58	1550.00	83	1553.98
9	1443.58	34	1518.12	59	1550.68	84	1553.63
10	1447.59	35	1520.12	60	1551.30	85	1553.25
11	1451.51	36	1522.06	61	1551.88	86	1552.82
12	1455.34	37	1523.93	62	1552.42	87	1552.37
13	1459.07	38	1525.74	63	1552.91	88	1551.88
14	1462.70	39	1527.49	64	1553.35	89	1551.35
15	1466.25	40	1529.18	65	1553.76	90	1550.79
16	1469.70	41	1530.80	66	1554.11	91	1550.20
17	1473.07	42	1532.37	67	1554.43	92	1549.58
18	1476.35	43	1533.88	68	1554.70	93	1548.92
19	1479.55	44	1535.33	69	1554.93	94	1548.23
20	1482.66	45	1536.72	70	1555.12	95	1547.50
21	1485.69	46	1538.06	71	1555.27	96	1546.75
22	1488.63	47	1539.34	72	1555.37	97	1545.96
23	1491.50	48	1540.57	73	1555.44	98	1545.14
24	1494.29	49	1541.74	74	1555.47	99	1544.29
25	1497.00	50	1542.87	75	1555.45	100	1543.41

Note) T: temperature, V: velocity of sound

(24) Velocity of sound and density of various liquids

Name of liquid	T°C	ρ /cm ³	Vm/s
Acetone	20	0.7905	1190
Aniline	20	1.0216	1659
Alcohol	20	0.7893	1168
Ether	20	0.7135	1006
Ethylene glycol	20	1.1131	1666
n-octane	20	0.7021	1192
o-xylene	20	0.871	1360
Chloroform	20	1.4870	1001
Chlorobenzene	20	1.1042	1289
Glycerin	20	1.2613	1923
Acetic acid	20	1.0495	1159
Methyl acetate	20	0.928	1181
Ethyl acetate	20	0.900	1164
Cyclohexane	20	0.779	1284
Dithionic acid	20	1.033	1389
Heavy water	20	1.1053	1388
Carbon tetrachloride	20	1.5942	938
Mercury	20	13.5955	1451
Nitrobenzene	20	1.207	1473
Carbon disulfide	20	1.2634	1158
Chloroform	20	2.8904	931
n-propyl alcohol	20	0.8045	1225
n-pentane	20	0.6260	1032
n-hexane	20	0.654	1083
Light oil	25	0.81	1324
Transformer oil	32.5	0.859	1425
Spindle oil	32	0.905	1342
Petroleum	34	0.825	1295
Gasoline	34	0.803	1250
Water	13.5	1.	1460
Sea water (salinity: 3.5%)	16	1.	1510

Note) T: temperature, ρ : density, V: velocity of sound

(25) Velocity of sound per piping material

Material	Vm/s
Steel	3000
Ductile cast iron	3000
Cast iron	2604
Stainless steel	3141
Copper	2260
Lead	2170
Aluminum	3080
Brass	2050
Vinylchloride	2307
Acrylics	2644
FRP	2505
Mortar	3000
Tar epoxy	2505
Polyethylene	1900
Teflon	1240
Rubber	1510
Pyrex glass	3280

Note) V: velocity of sound

(26) Dynamic viscosity coefficient of various liquids

Name of liquid	T°C	ρ /cm ³	Vm/s	ν ($\times 10^{-6}$ m ² /s)
Acetone	20	0.7905	1190	0.407
Aniline	20	1.0216	1659	1.762
Ether	20	0.7135	1006	0.336
Ethylene glycol	20	1.1131	1666	21.112
Chloroform	20	1.4870	1001	0.383
Glycerin	20	1.2613	1923	1188.5
Acetic acid	20	1.0495	1159	1.162
Methyl acetate	20	0.928	1181	0.411
Ethyl acetate	20	0.900	1164	0.499
Heavy water	20	1.1053	1388	1.129
Carbon tetrachloride	20	1.5942	938	0.608
Mercury	20	13.5955	1451	0.114
Nitrobenzene	20	1.207	1473	1.665
Carbon disulfide	20	1.2634	1158	0.290
n-pentane	20	0.6260	1032	0.366
n-hexane	20	0.654	1083	0.489
Spindle oil	32	0.905	1324	15.7
Gasoline	34	0.803	1250	0.4 to 0.5
Water	13.5	1.	1460	1.004(20°C)

Note) T: temperature, ρ : density, V: velocity of sound
 ν : kinematic viscosity

16.2 Command tree

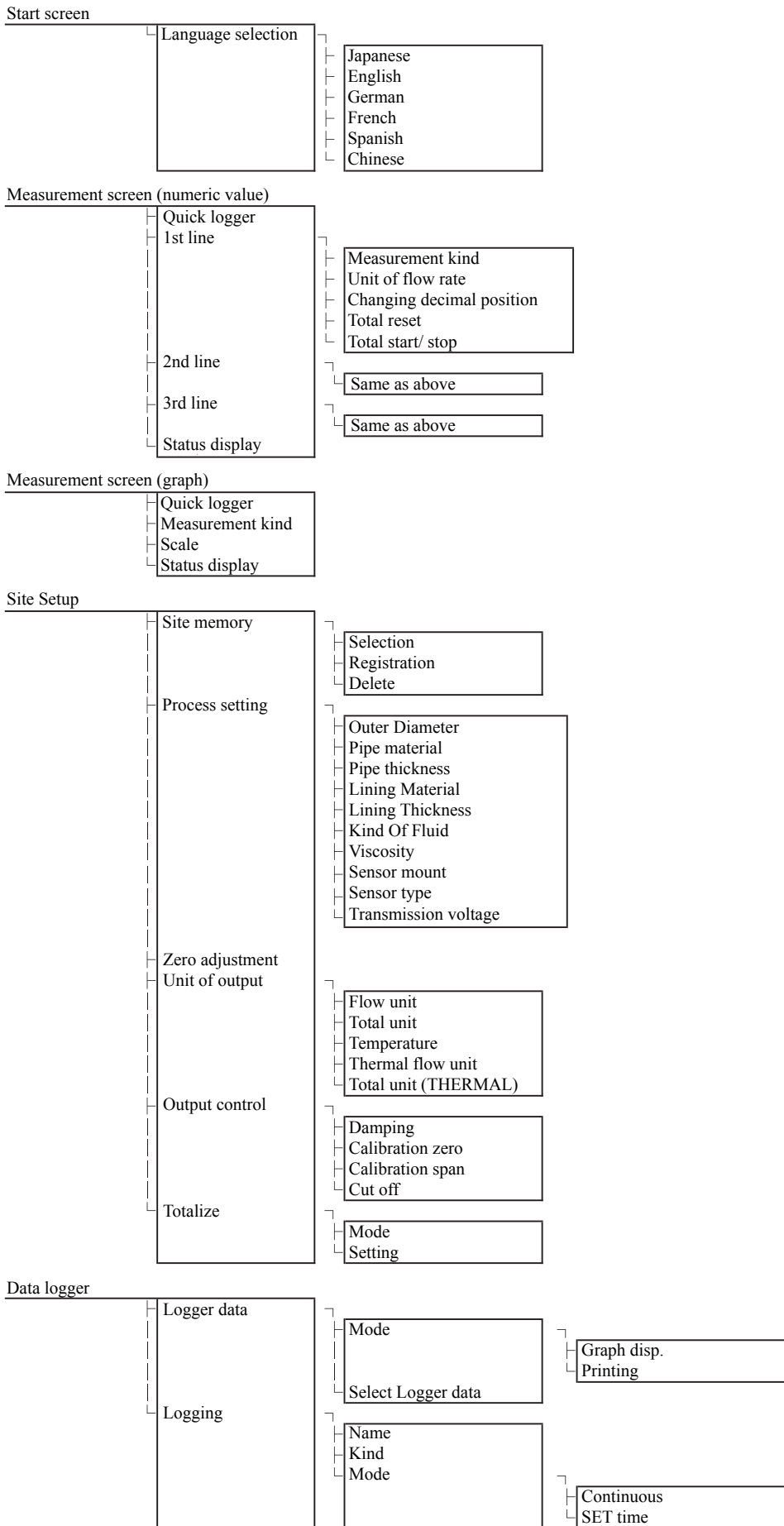

Range

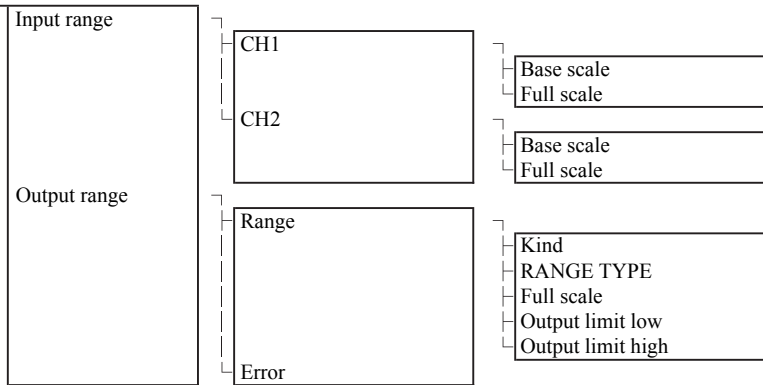

System setup

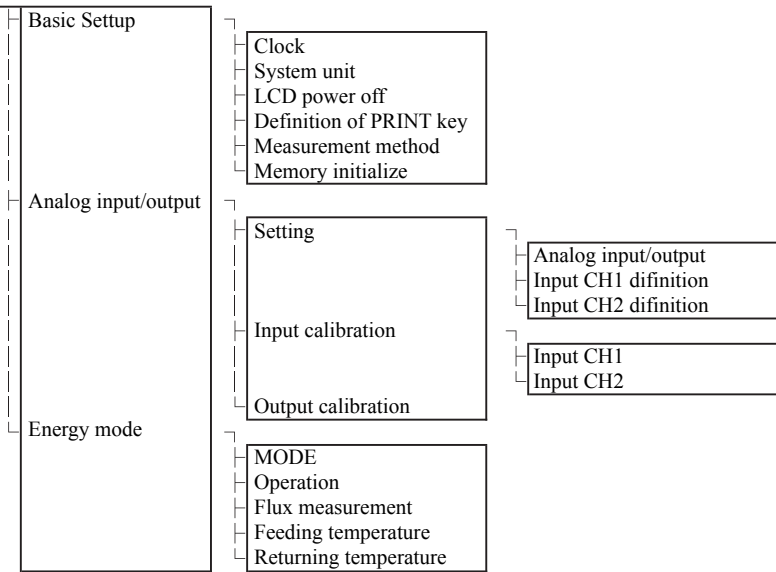

Maintenance

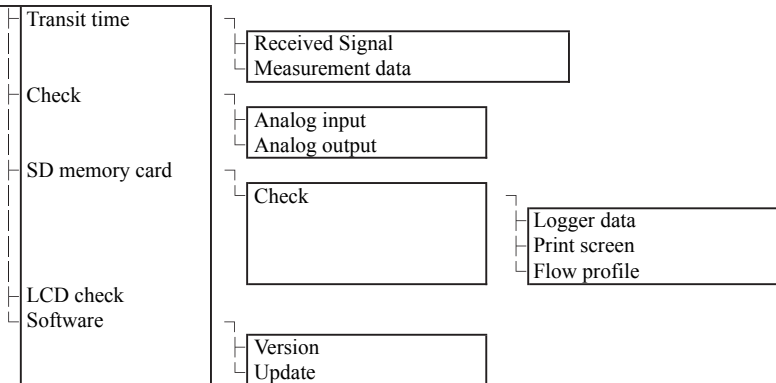

Printer

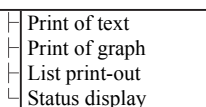

Flow velocity distribution

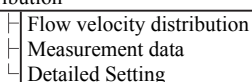

16.3 Specifications

Measuring objects

Measurement fluid:	Uniform liquid in which ultrasonic waves can propagate.
Turbidity of fluid:	10000 mg/L or less
State of fluid:	Well-developed turbulent or laminar flow in a filled pipe.
Fluid temperature:	-40 to +200°C
Measuring range:	0...±0.3 to ±32m/s

Piping conditions

Applicable piping material:	Select from carbon steel, stainless steel, cast iron, PVC, FRP, copper, aluminum, acrylic or material of known sound velocity.
Pipe size:	Flow rate measurement φ13 to φ6000mm Flow velocity profile measurement φ40 to φ1000mm
Lining material:	Select from no lining, tar epoxy, mortar, rubber, Teflon, pyrex glass or material of known sound velocity. Note) No gap allowed between the lining and the pipe.
Straight pipe length:	10D or more upstream and 5D or more downstream (D: internal pipe diameter) Refer to Japan Electric Measuring Instruments Manufacturers' Association's standard JEMIS-032 for details.

Performance specifications

Accuracy rating:

Piping diameter (inner diameter)	Flow velocity range	Accuracy
φ13 to φ50mm	2 to 32m/s	±1.5 to 2.5% of rate
	0 to 2m/s	±0.03 to 0.05m/s
φ50 to φ300mm	2 to 32m/s	±1.0 to 1.5% of rate
	0 to 2m/s	±0.02 to 0.03m/s
φ300 to φ6000mm	2 to 32m/s	±1.0 to 1.5% of rate
	0 to 2m/s	±0.02 to 0.03m/s

Note) Reference conditions are based on JEMIS-032.

Flow transmitter (Type: FSC)

Power supply:	Built-in battery or AC power adapter
Built-in battery:	Exclusive lithium button battery (5000m Ah) Continuous operation time, approx. 12 hours (without printer, back light OFF, Not use the current output, the ambient temperature is near normal temperature (20°C).) The charging time range: 0 to +40°C Recharging time, approx. 3 hours (power adapter used) Power Consumption: Min. 3W and Max. 16W The consumption varies depending on the used conditions.
Power adapter:	Exclusive power adapter 90V to 264V AC (50/60Hz), 70VA or less
LCD:	Semi-transmissive color graphic display 240 × 320 (with back light) Measurement value (instantaneous flow rate, integrated flow rate) and various settings are displayed. Excellent visibility even outdoors in direct sunlight.
LED display:	Status display when using AC power adapter. DC IN (green): Power supply status CHARGE (red): Battery charging underway
Operation keypad:	11 buttons (ON, OFF, ENT, ESC, MENU, △, ▽, ◀, ▶, LIGHT, PRINT)
Power failure backup:	Measurement value is backed up by nonvolatile memory. Clock backup with lithium battery (effective term, 10 years or more)
Response time:	1 second

Analog output signals:	4 to 20mA DC, one point (load resistance, 600Ω or less) Instantaneous velocity, instantaneous flow rate or heat quantity (calorie) after scaling.
Analog input signal:	4 to 20mA DC, one point (input resistance, 200Ω or less) 4 to 20mA DC, one point (input resistance, 200Ω or less) or 1 to 5V DC, one point
	} Total 2 points
SD memory card:	Used to input temperature for heat quantity measurement, etc. Used for data logger function and recording screen data. Available up to 8GB (Option256MB) Compliant media • SD memory card: speed class 2, 4, 6 • SDHC memory card: speed class 4, 6 Format • FAT16: 64MB, 128MB to 2GB • FAT32: 4GB, 8GB Otherwise, reading and saving are impossible. File format • Date logger: CSV file • Screen date: Bit map file
Serial communication:	USB port (device* compatible): Mini B receptacle Connectable number of Mini B receptacles: 1 unit Transmission distance: 3m max. Transmission speed: 500kbps Data: Instantaneous velocity, instantaneous flow rate, total value, heat quantity (calorie) value, error information, logger data, etc. * Device: Connected plug from PC
Printer (option):	To be mounted on top of transmitter unit Thermal line dot printing Note) For selecting Chinese, the printing character will be Japanese Kanji character.
Ambient temperature:	-10 to +55°C (Without printer) -10 to +45°C (With printer)
Ambient humidity:	90%RH or less
Type of enclosure:	IP64 (Without printer)
Enclosure case:	Plastic case
Outer dimensions:	H210 × W120 × D65mm (Without printer) H320 × W120 × D65mm (With printer)
Weight:	1.0kg (Without printer) 1.2kg (With printer)

Various functions

Display language:	Selectable from Japanese, English, German, French, Spanish or Chinese (switchable by key operation).
Clock display function:	Time (year, month, day, hour, minute) display (configurable) Monthly error: about 1 minute at common temperature (20°C).
Instantaneous value display function:	Instantaneous velocity, instantaneous flow rate display (The flow in reverse direction is displayed with minus “-.”) Numeric value: 10 digits (decimal point equals 1 digit) Unit: Metric/English system selectable Metric system Velocity: m/s Flow rate: L/s, L/min, L/h, L/d, kL/d, ML/d, m ³ /s, m ³ /min, m ³ /h, m ³ /d, km ³ /d, Mm ³ /d, BBL/s, BBL/min, BBL/h, BBL/d, kBBL/d, MBBL/d English system Velocity: ft/s Flow rate: gal/s, gal/min, gal/h, gal/d, kgal/d, Mgal/d, ft ³ /s, ft ³ /min, ft ³ /h, ft ³ /d, kft ³ /d, Mft ³ /d, BBL/s, BBL/min, BBL/h, BBL/d, kBBL/d, MBBL/d

Total value display function: Display of forward or reverse total (reverse is displayed as minus)
 Numeric value: 10 digits (decimal point is corresponding to 1 digit)
 Unit: Metric/English system selectable

Metric system

Flow rate total: mL, L, m³, km³, Mm³, mBBL, BBL, kBBL

English system

Flow rate total: gal, kgal, ft³, kft³, Mft³, mBBL, BBL, kBBL, ACRE-ft

Consumed heat quantity (calorie) display function:

Display of consumed heating medium

Metric system

Heat flow: MJ/h, GJ/h

Total heat quantity: MJ, GJ

English system

Heat flow: MJ/h, GJ/h, BTU/h, kBTU/h, MBTU/h, kWh, MWh

Total heat quantity:

MJ, GJ, BTU, kBTU, MBTU, kW MW

J: Joule BTU: British thermal unit W: Watt

Computation function of consumed heat quantity (calorie):

This function calculates the heat quantity received and sent with liquid (water) in cooling and heating.

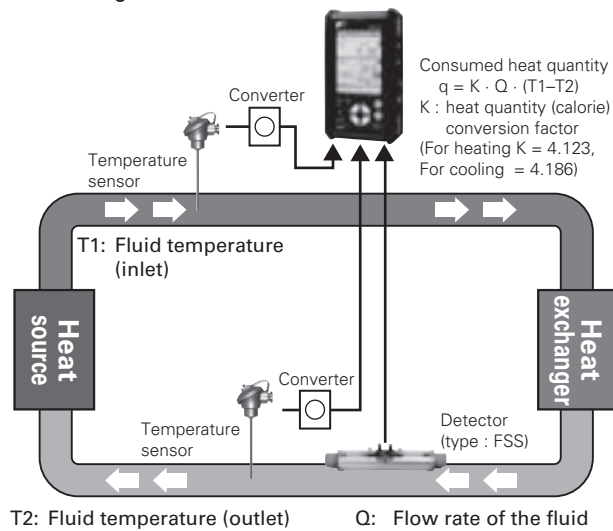

Temperature display function:

Fluid temperature be displayed by current input from temperature transmitter.

Metric system

Temperature unit: °C or K

English system

Temperature unit: F or K

Site data storage function: Max. 32 locations (sites) data (pipe size, material, fluid type and etc) can be stored into built-in non-volatile memory.

Damping:

0 to 100sec (every 0.1sec) configurable for analog output and velocity/flow rate display

Low flow cut:

Equivalent to 0 to 5m/s

Output setting function:

Current output scaling, output type, burnout setting and calibration

Serial communication function:

Instantaneous velocity, instantaneous flow rate, total value, heat flow, error information, received waveform, analog input, velocity profile data, logger data, etc. may be downloaded to personal computer.

Logger function:

Instantaneous velocity, instantaneous flow rate, total value, heat flow, error information, received waveform, analog input, velocity profile data can be saved in a SD memory card.

Waveform display function:

Bi-directional received waveforms may be displayed.

Graph display function:

Flow rate trend graph may be displayed.

Printing function (option):

Hard copy output of a screen

Periodic printing (type: text, graph)

Logger date (type: text, graph)

Flow velocity profile measurement (option):

Flow velocity profile may be observed in real time using the exclusive detector (option).

Detector (Type: FSD)

Type of detector:

Classification	Type	Internal pipe diameter (mm)	Fluid temperature
Middle diameter	FSSC	ø50 to ø1200	-40 to 120°C
Small diameter	FSSD	ø13 to ø300	-40 to 100°C
Large diameter	FSSE	ø200 to ø6000	-40 to 80°C
High temperature	FSSH	ø50 to ø400	-40 to 200°C

Mounting method:	Mounting on outside of pipe
Sensor mounting method:	V or Z method
Signal cable:	Exclusive coaxial cable, 5m (Included with FSC)
Connection method:	Transmitter side Exclusive connector Detector side (FSSE) Screw terminal Others: BNC connector
Ambient temperature:	-20 to +60°C
Ambient humidity:	FSSE 100%RH or less Other 90%RH or less
Type of enclosure:	FSSC IP65 (When waterproof BNC connector is provided) FSSE IP67 Others IP52

Material of detector:

Classification	Type	Sensor case	Rail material
Small diameter	FSSC	Plastic	Aluminum alloy + Plastic
Middle diameter	FSSD	Plastic	Aluminum alloy + Plastic
Large diameter	FSSE	Plastic	————
High temperature	FSSH	SUS304	Aluminum alloy

Material of mounting belt/wire:

Detector type 6th digit	Dimensions	Material
A	1.5mX2	SUS304
B	3.0mX1	Plastic cloth belt
C	1.0mX4	SUS304
D	Inner pipe diam.<ø1500mm	SUS304
E	Inner pipe diam.<ø6000mm	SUS304

Extension cable(option): Extended when the length of the detector signal cable is not sufficient.
Length: 10m, 50m

FLOW VELOCITY PROFILE DISPLAY FUNCTION (OPTION)

Flow velocity profile can be observed in real time using the dedicated detector from the outside. It is specifiable by the code symbol of flow transmitter.

APPLICATION

Pulse Doppler method is applicable to observe flow velocity profile in real time, display the flow status in the pipe, and decide the appropriate measurement location. Also, it can be used for diagnosis of flow and laboratory test.

SPECIFICATIONS

Measuring fluid:	Uniform liquid in which ultrasonic waves can propagate.
Turbidity of fluid:	Axisymmetric flow in a filled pipe.
Fluid temperature:	-40 to +100°C (FSDP2) -40 to +80°C (FSDP1,FSDP1)
Air bubble quantity:	0.02 to 15Vol% (Velocity is 1m/s)
Pipe size:	Small type sensor : $\phi 40$ to $\phi 200$ mm Middle type sensor : $\phi 100$ to $\phi 400$ mm Large type sensor : $\phi 200$ to $\phi 1000$ mm
Measurement range:	0 to ± 0.3 : \pm Maximum Velocity (depending on the pipe diameter) Refer to chart, page 145. Note) This function is to observe flow velocity profile, and it may be different from actual flow rate.

DETECTOR FOR FLOW VELOCITY PROFILE MEASUREMENT (TYPE: FSD)

Mounting method:	Mounting on outside of existing pipe
Ambient temperature:	-20 to +80°C
Ambient humidity:	100% RH or less
Type of enclosure:	IP67 (with waterproof BNC connector provided.)
Material:	Sensor housing: PBT Guide frame: Aluminum alloy Mounting belt: Plastic cloth belt/stainless wire

16.4 Q & A

I. Q & A about pipes

1. How is piping setting made when piping specifications are unknown ?

Flow rate can be measured within the range of the specifications of PORTAFLOW C by entering the standard value, but the accuracy cannot be guaranteed.

* Outer diameter can be confirmed by measuring the outside circumference.

* Thickness can be confirmed by using a piping thickness gauge available optionally.

2. What is the effect of coating outside the piping ?

In general, when the outside wall of the piping is rusted and contaminated with deposits of foreign objects, coating materials, etc., so the sensor is not fitted firmly to the piping, measurement cannot be made if there is an air gap which prevents the passage of ultrasonic waves.

In this case, the sensor should be mounted after removing the contamination.

Measurement at a point with uniform coating can be made without problems.

There are no problems with a thick coating (more than several mm), but the measurement accuracy can be improved by adding the lining thickness to the coating thickness and entering it prior to measurement.

When wrapped with jute, the jute should be removed before measurement.

3. What is the effect of scales in the piping ?

Measurement can be made even when there are scales in the piping, but the amount of reduction of the sectional area due to scaling will become an error.

Therefore, the flow indicated is a little larger than the actual flow.

When the scale thickness is known, it can be compensated by adding it to the lining thickness and entering it for measurement. In general, the state of deposit of scales in old piping is not uniform, and shows an uneven surface. Therefore, an accurate cross-sectional area of flow passage cannot be measured.

Also, the flow profile is not uniform, and an accurate measurement of flow cannot be expected, strictly speaking.

II. Q & A about fluids

1. What is homogenous fluid through which ultrasonic waves are transmitted ?

Municipal water can be measured over the range from raw water to clean water without problems. Sewage flows can be measured up to return sludge.

If the flow contains many air bubbles, it cannot be measured. In general, the less foreign objects (including air bubbles) the flow contains, the more easily can it be measured.

2. Is it possible to measure the flow in piping that is not full?

In horizontal piping, if the pipe is filled with liquid up to $2/3$ of inside diameter D as shown below, the flow velocity can be measured. In this case, the flow rate indicated is the assumed one under filled pipe conditions.

Therefore, the flow indicated is larger than the actual flow.

If sludge is accumulated on the bottom of the piping, the flow velocity can be measured up to $1/3$ of inside diameter D . In this case, the flow rate indicated is the assumed one under filled pipe conditions without any sludge.

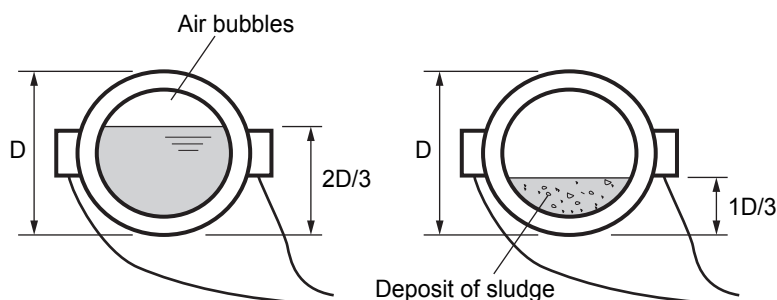

3. What happens when the liquid contains air bubbles ?

PORTAFLOW C is highly resistant to entry of air bubbles in pipes with the aid of the advanced ABM system as shown below.

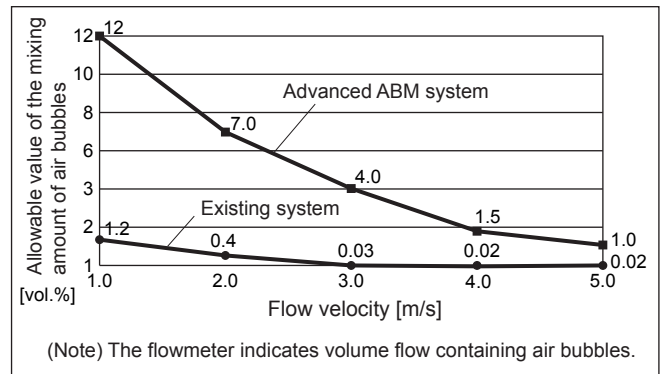

* Example of measured data

When liquid contains excessive air bubbles, no measurement can be made because of transmission failure of the ultrasonic waves. When air bubbles enter the liquid momentarily, the output is retained by the self-check function, thereby causing no problems. Air bubbles easily enter liquid in the following cases.

- (1) Suction of air due to low liquid level of pump well
- (2) Occurrence of cavitation
- (3) Pressure in the piping becomes negative and air enters from piping connection.

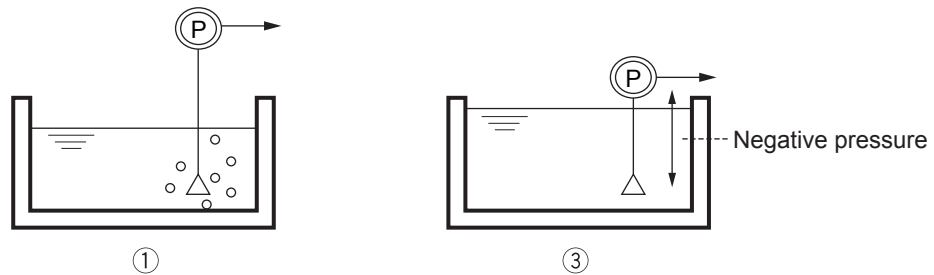

III Q & A about measuring conditions at locations

1. What about mounting the sensor on horizontal piping ?

The sensor should be mounted in the horizontal direction on the piping circumference to prevent the effects of accumulated sludge (lower) and air bubbles (upper).

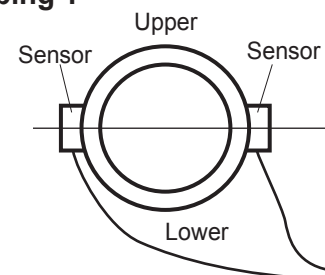

2. What about mounting the sensor on vertical piping ?

The sensor can be mounted on any external position of vertical piping. The recommendable flow direction is upward to avoid the interference of bubbles.

3. When the length of straight piping is short and a pump, valve, orifice, etc. is present, what is required for measurement ?

In general, the length of straight piping on upstream side should be longer than 10D, and that on downstream side should be longer than 5D. When a pump, valve, orifice, etc. is present, measurement should be made at a location greater than 30D away on the upstream side and greater than 5D away on the downstream side.

4. How far can the sensor extension cord be extended ?

Extension cords can be connected and extended up to 100m.
(Special cable with BNC connector: 10m × 2 or 50m × 2 available optionally)

IV. Q & A about accuracy

1. What is the approximate accuracy of measurement ?

Specifications:

Inside diameter	Flow velocity	Accuracy
φ15 to φ25 or less	2 to 32m/s	± 2.5% of measured flow
	0 to 2m/s	± 0.05m/s
φ25 to φ50 or less	2 to 32m/s	± 1.5% of measured flow
	0 to 2m/s	± 0.03m/s* ¹
φ50 to φ300 or less	2 to 32m/s	± 1.0 to 1.5% of measured flow
	0 to 2m/s	± 0.02 to 0.03m/s
φ300 to φ6000	1 to 32m/s	± 1.0 to 1.5% of measured flow
	0 to 1m/s	± 0.01 to 0.02m/s

*1: Example of calculation

Error at 2m/s? → $\pm 0.03 \times 100/2 = \pm 1.5\%$

Error at 1m/s? → $\pm 0.03 \times 100/1 = \pm 3.0\%$

Formerly, the expression ■% of full scale was often used. But, in the recent age of digital system, it is more frequently expressed in % of the displayed value. Under the condition of low flow velocity, the absolute value of error is used as a standard of accuracy in consideration of the threshold of device performance.

2. What about error factors ?

On PORTAFLOW C, ultrasonic waves are emitted from the outside of the piping and the time is measured while the waves are passing through the piping material - fluid - piping material. The following points become the error factors to be considered when evaluating the measured values.

(1) Piping size

When the value set for piping size is different from the actual size of piping, and if the difference from the inside diameter is about 1% in size, the error is about 3% of deviation obtained by flow conversion.

(The following shows an example of 1mm deviation in inside diameter)

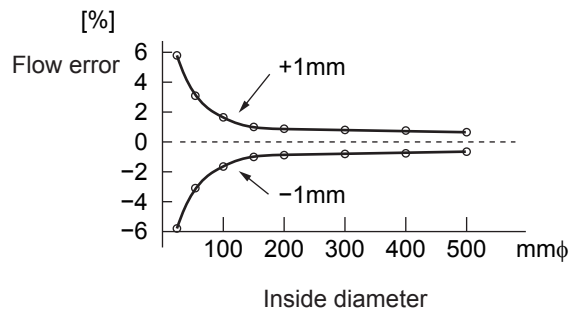

(2) Difference in sensor mounting length

As a general standard, when the error in mounting length is ±1mm, the error of flow is within 1%.

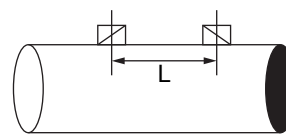
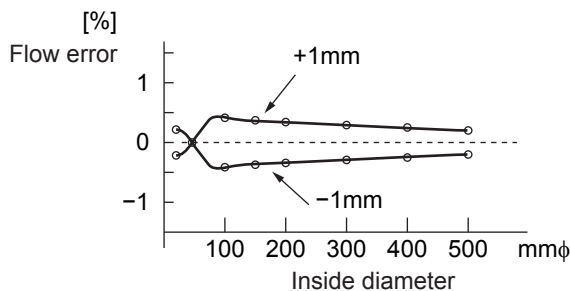

(3) Flow in piping is deviated

When the straight piping is short (particularly upstream side), the flow has become skewed and some deviation error will occur, or fluctuation of indicated value will occur when the flow is swirling.

(4) Inside diameter different from set value due to deposits of scales inside the piping

The error is the same as noted in (1). If scales are badly deposited, receiving waves are not available and measurement may be disabled.

(5) Change in water temperature

Sound velocity of the water is calculated in real time and change in fluid temperature is compensated (new sound velocity measuring system), but there is a slight error.

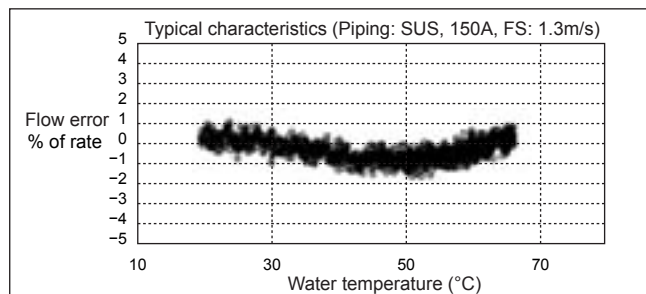

* Example of measurement

(6) Weak received wave due to improper mounting condition and piping condition

Measurement may be possible. But, if received wave is weak, it may result in a large error due to the effect of external noise.

(7) Output when the liquid contains air bubbles

When the amount of air bubbles contained in the liquid is lower than the allowable value indicated before, PORTAFLOW C indicates volume flow containing air bubbles.

3. What about comparison with other flowmeters ?

Although thermometers and pressure gauges can easily be calibrated at a site, flowmeters are generally very difficult to calibrate at a site.

Therefore, PORTAFLOW C is often used for checking other flowmeters. After checking, the result of comparison of flowmeters should be evaluated with care while considering to the following points.

(1) Consideration of error of each flowmeter

Evaluate the calibration error in consideration for accuracy indication (percentage in FS or percentage of the rate)

(2) Study data systematically, if an error is found.

Do not compare values only at 1 point of flow. Draw many samples on a graph and arrange them systematically for clear evaluation.

(3) Thoroughly check the piping system.

If fluid flows into or out of a branch pipe in the middle of a piping system, the comparison data of each side of such a pipe-junction may not match each other.

When there is storage in the middle of piping system and it becomes a buffer for the flow, the liquid level of the storage area should be taken into consideration.

(4) Comparison of 2 different sets of flowmeters is difficult.

When there is a difference between 2 sets of flowmeters, it is difficult to judge the correct one. So, another judgement criteria needs to be considered.

V. Others

1. Life span of LCD

The life span of LCD is considered to be about 10 years under general operating conditions, according to the manufacturer's catalogue. Generally, it is about 5 to 6 years in actual service. The life span is not so much related to the number of displaying operations.

2. Printer roll sheet

(1) Supplied printer roll sheet is 28 meters long.

The roll sheet is fed at 0.125 mm/dot.

Setting the paper feed at a cycle of 1 second uses a roll of paper in 224,000 sec. (about 62.2 hours) = $28 \text{ m} / 0.125 \text{ mm}$.

(2) In case of TEXT mode

A single printing consists of the following:

- 1) Date (1 line),
- 2) Flow velocity, flow rate, and total (several lines),
- 3) Measuring conditions (1 line)
- 4) Paper-feed (4 mm)

A printer has a paper fed at 4 mm/line.

For example, if you select flow rate (m^3/h), flow velocity and +total, the paper feed totals 5 lines (24 mm). If a printing cycle is assumed to set to 1 minute, a roll of paper will be used for 1167 minutes (about 19.4 hours) = $28 \text{ meters} / 24 \text{ mm}$

16.5 File contents of SD memory card

16.5.1 Types of measured data to be logged

Measured data to be logged is of 14 types indicated below.

Table 16-1 Data types

Kind	Name	Sign	Maximum number of places of integer section	Number of places of decimal	Unit
VELOCITY	VELOCITY	Yes	3 places	3 places	m/s
FLOW RATE	FLOW RATE	Yes	12 places	4 places	Flow unit
FLOW RATE (%)	FLOW RATE (%)	Yes	3 places	3 places	%
+TOTALIZER	+TOTALIZER	No	10 places	3 places	Total unit
-TOTALIZER	-TOTALIZER	No	10 places	3 places	Total unit
AI CHANNEL 1	AI CHANNEL 1	Yes	10 places	3 places	—
AI CHANNEL 2	AI CHANNEL 2	Yes	10 places	3 places	—
SUPPLY TEMP.	SUPPLY TEMP.	Yes	3 places	3 places	Temperature unit
RETURN TEMP.	RETURN TEMP.	Yes	3 places	3 places	Temperature unit
TEMP DEFFERENCE	TEMP DEFFERENCE	Yes	3 places	3 places	Temperature unit
THERMAL FLOW	THERMAL FLOW	Yes	10 places	3 places	Thermal flow unit
THERMAL FLOW (%)	THERMAL FLOW (%)	Yes	3 places	3 places	%
+TOTAL (THERMAL)	+TOTAL (THERMAL)	No	10 places	3 places	Total unit (Thermal)
-TOTAL (THERMAL)	-TOTAL (THERMAL)	No	10 places	3 places	Total unit (Thermal)

In case heat mode is “NOT USED”, it is invalid even if feeding temperature and subsequent have been selected.

If the system unit was changed after logger start, logging is performed in the unit at the time of start. The changed unit becomes valid after the logger is stopped.

16.5.2 Measured data file

(1) Configuration data file

A file is roughly configured of three sections.

- Section [START] A file is generated at start, and this section is created at that time.

Item	Contents
PRODUCT	Product name ("PORTAFLOW"), fixed
VERSION	File format version number (1.0.0, fixed)
TIME	Logger start date and hour
CYCLE	Logger acquisition period (sec)

- Section [DATAx] Added at the time of generation of target data file.

Item	Contents
FILE	File name of logger data
INDEXx	Offset (bytes) to (date and hour) data in the logger data is added sequentially beginning from 1 as indicated below. (offset, total number of data in offset, date/hour of offset)
TIME	Logger data exit date and hour
COUNT	Total number of data in target data file
STATUS	Exit status NORMAL: Normal exit caused by termination of acquisition period STOP: Normal exit caused by stop operation during acquisition POWER OFF: Interruption caused by OFF button during acquisition BATTERY LOW: Interruption caused by battery capacity drop during acquisition FIFO EMPTY: No vacancy in measurement FIFO ABNORMAL: Stop caused by system error during acquisition
SIZE	Byte size of target data file
SUM	Total number of data up to target data file

- Section [END] Added at the time of termination of the logger.

Item	Contents
PRODUCT	Logger exit date and hour
VERSION	Total byte size of all data files
TIME	Number of all data files
CYCLE	Total number of data

```
[START]
PRODUCT=PORTAFLOW
VERSION=V1.0.0
TIME=2007/01/01 00:00:00
CYCLE=00:00:01
[DATA1]
FILE=AAA_20071214_193032.csv
INDEX1=490047,5000,2007/12/14 20:53:51
INDEX2=980047,10000,2007/12/14 22:17:11
INDEX3=1470047,15000,2007/12/14 23:40:31
INDEX4=1960047,20000,2007/12/15 01:03:51
INDEX5=2450047,25000,2007/12/15 02:27:11
INDEX6=2940047,30000,2007/12/15 03:50:31
INDEX7=3430047,35000,2007/12/15 05:13:51
INDEX8=3920047,40000,2007/12/15 06:37:11
INDEX9=4410047,45000,2007/12/15 08:00:31
INDEX10=4900047,50000,2007/12/15 09:23:51
INDEX11=5390047,55000,2007/12/15 10:47:11
INDEX12=5880047,60000,2007/12/15 12:10:31
INDEX13=6370047,65000,2007/12/15 13:33:51
TIME=2007/12/15 13:42:11
COUNT=65500
STATUS=NORMAL
SIZE=6419145
SUM=65500
[END]
TIME=2007/12/17 09:52:11
SIZE=6419145
FCOUNT=1
SUM=65500
```

(2) Data file

A file is generated in CSV format.

The following table indicates contents of lines of rows in case the file is opened with Excel.

Table 16-2 Contents of data file

Line	Row	Contents
1	A	
Line 1	B and subsequent	Names of logged types for the quantity, including RAS. ASCII characters show names. See "16.5.1 Types of measured data to be logged".
Line 2	B and subsequent	Units of logged types for the quantity. ASCII characters show units.
Line 3 and subsequent	A	Date and hour
Line 3 and subsequent	B and subsequent	Date/hour name measured data and RAS. 32-bit binary numbers indicates RAS. See "16.5.4 Regarding RAS".

	A	B	C	D	E
1		4 VELOCITY	FLOW RATE	+TOTALIZER	RAS
2		m/s	m ³ /s	L	
3	2009/9/30 11:00:00	1.23	123.45	1234.56	1001000
4	2009/9/30 11:10:00	1.24	123.46	1234.57	1001000
5	2009/9/30 11:20:00	1.25	123.47	1234.58	1001000
6	2009/9/30 11:30:00	1.26	123.48	1234.59	1001000
7	2009/9/30 11:40:00	1.27	123.49	1234.6	1001000
8	2009/9/30 11:50:00	1.28	123.5	1234.61	1001000
9	2009/9/30 12:00:00	1.29	123.51	1234.62	1001000
10	2009/9/30 12:10:00	1.3	123.52	1234.63	1001000
11	2009/9/30 12:20:00	1.31	123.53	1234.64	1001000
12	2009/9/30 12:30:00	1.32	123.54	1234.65	1001000
13	2009/9/30 12:40:00	1.33	123.55	1234.66	1001000
14	2009/9/30 12:50:00	1.34	123.56	1234.67	1001000
15	2009/9/30 13:00:00	1.35	123.57	1234.68	1001000
16	2009/9/30 13:10:00	1.36	123.58	1234.69	1001000

When data is indicated in a point diagram of Excel, for instance, it is as indicated below.

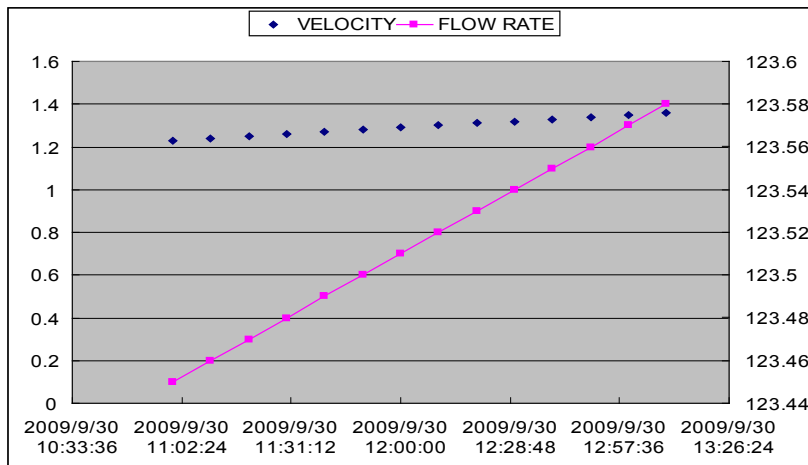

16.5.3 Flow velocity profile data file

A file is generated in the CSV format indicated below, and it contains data for up to one hour. The following table indicates contents of lines of rows in case the file is opened with Excel.

Table 16-3 Contents of flow velocity distribution file

Line	Row	Contents
Line 2	A	Describes "<Measurement result>".
	B and subsequent	Describes "Channel number".
	C and subsequent	Channel number 126 to 1, 1 to 126 in case of connection of sensor U 1 to 126, 126 to 1 in case of connection of sensor D 1 to 126, 126 to 1 to IT row in case of connection of sensor U/D
	IU	Describes "<F.RATE/VEL.VALUE>".
	IV	Describes "<RAS>".
Line 3	B	Describes "<Start/End Channel>".
	C and subsequent	Describes 1 in start/end channels of channel number in line 2, and describes 0 in others.
Line 4	A	Describes "<Measurement time>".
	C	Describes acquisition date/hour in the "2007/10/29 10:19:44" format.
Line 5 and subsequent	A	Describes "<Velocity Profile The measurement data>".
	C to IU	Fluid velocity that corresponds to channel number in line 2.
	IU	Flow rate/fluid velocity at acquisition date/hour.
	IV	RAS is indicated by 32-bit binary numbers, with " " added at first. See "16.5.4 Regarding RAS".

A flow velocity distribution file can be displayed using flow velocity distribution demonstrate function of PC loader software.

16.5.4 Regarding RAS

Expresses the status of the measurement screen by 32-bit binary numbers.

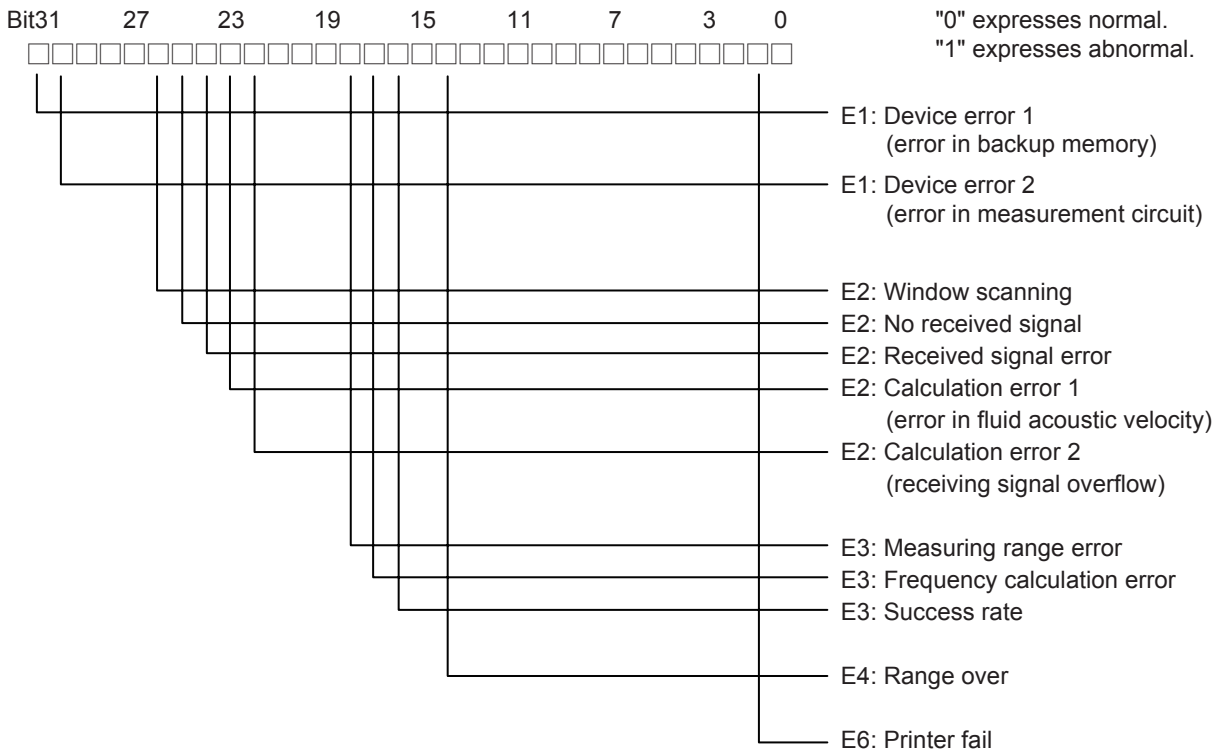

See "10.8 Contents of errors in status display" for error contents.

 Fuji Electric Co., Ltd.

**International Sales Div
Sales Group**

Gate City Ohsaki, East Tower, 11-2, Osaki 1-chome,
Shinagawa-ku, Tokyo 141-0032, Japan
<http://www.fujielectric.com>
Phone: 81-3-5435-7280, 7281 Fax: 81-3-5435-7425
<http://www.fujielectric.com/products/instruments/>
