

Photoelectrics Through-beam Type ET 1820 DC, Nickel-plated Brass Housing

CARLO GAVAZZI



- Range: 20 m
- Adjustable sensitivity
- Modulated infrared light
- Make and break switching functions, NPN, PNP (200 mA)
- LED-indication for power supply ON (emitter) and target detected (receiver)
- Supply voltage: 10 to 40 VDC
- Heavy duty M18 metal housing, IP 67
- Cable and plug versions



Product Description

The ET1820 is a family of general purpose through-beam sensors in an industrial standard M18 nickel-plated brass housing for heavy duty applications. They are useful for simple applications where a basic sensor provide adequate

sensing performance. The sensors are easy to adjust with a 270° single turn potentiometer. The output is a 4-wire complementary (NO and NC) circuit with NPN (current sinking) or PNP (current sourcing) open collector transistor output.

Ordering Key

ET 18 20 NPA S-1

Type	_____
Housing diameter	_____
Range	_____
Output type	_____
Housing material	_____
Connection type	_____

Type Selection

Housing diameter	Rated operating dist. (S _n)	Connection	Ordering no. Receiver/NPN Make & break switching	Ordering no. Receiver/PNP Make & break switching	Ordering no. Emitter
M18	20 m	Cable	ET 1820 NPAS	ET 1820 PPAS	ET 1820
M18	20 m	Plug	ET 1820 NPAS-1	ET 1820 PPAS-1	ET 1820-1

Note: Please order emitter and receiver separately.

Specifications Emitter

Rated operational volt. (U _B)	10 to 40 VDC (ripple included)
Ripple (U _{ripp})	≤ 10%
Supply current (I _o)	≤ 20 mA
Protection	Reverse polarity, short-circuits, transients
Light source	GaAlAs LED, 880 nm
Light type	Infrared, modulated
Optical angle	± 2°
Indication Supply ON	LED, green

Specifications Receiver

Rated operating dist. (S _n)	Up to 20 m
Sensitivity	270° single turn pot. meter
Temperature drift	0.6%/°C
Hysteresis (H) (Differential travel)	3 to 20%
Rated operational volt. (U _B)	10 to 40 VDC (ripple included)
Ripple (U _{ripp})	Max. 10%
No-load supply current (I _o)	Max. 12 mA (typ. 8 mA)
Min. operational current (I _e)	0.5 mA
OFF-state current (I _i)	Max. 100 μA (typ. 0)
Output current Continuous (I _e) Short-time (I)	Max. 200 mA 200 mA Max. load capacity 100 nF
Voltage drop (U _d)	Max. 2.5 VDC
Protection	Reverse polarity, short-circuit, transients
Optical angle	± 2°
Ambient light	Max. 5,000 lux
Operating frequency (f)	Typ. 170 Hz
Response time OFF-ON (t _{ON}) ON-OFF (t _{OFF})	Typ. 1.6 ms Typ. 4.2 ms



General Specifications

Power ON delay (t_v)	70 ms	Housing material	
Indication	Light and dark (Complementary switch) Output ON LED, yellow	Body	Nickel plated brass
Environment	Overvoltage category III (IEC 60664/664A; 60947-1) Pollution degree 3 (IEC 60664/664A; 60947-1) Degree of protection IP 67 (IEC 60529; 60947-1)	Front	PC, black
Temperature	Operating -20° to +60°C (-4° to +140°F) Storage -30° to +70°C (-22° to +158°F)	Cable end	Polyester, black
Vibration	10 to 150 Hz, 0.5 mm/7.5 g (IEC 60068-2-6)	Nuts	Nickel plated brass
Shock	2 x 1 m & 100 x 0.5 m (IEC 60068-2-32)	Connection	
Dielectric voltage	500 VAC (IEC 60364-4-41)	Cable	Grey, 2 m oilproof, PVC, Receiver 4 x 0.34 mm ² , Ø 5.2 mm
		Ermitter	2 x 0.5 mm ² , Ø 5.2 mm
		Plug	M12 x 1
		Cables for plug (M1)	CON.14NF.. series
		Weight	
		Cable version	137 g
		Plug version	54 g
		Approvals	UL, CSA
		CE-marking	Yes

Operation Diagram

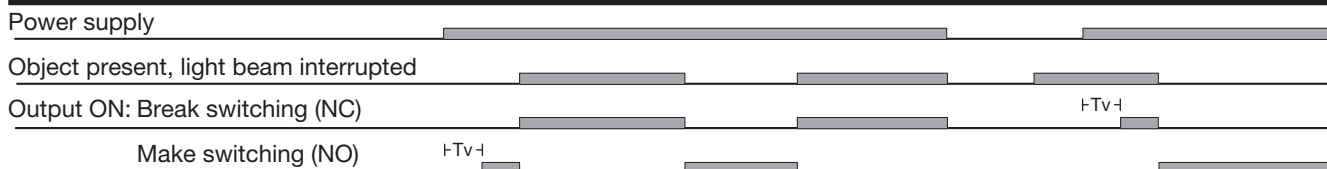

Dimensions

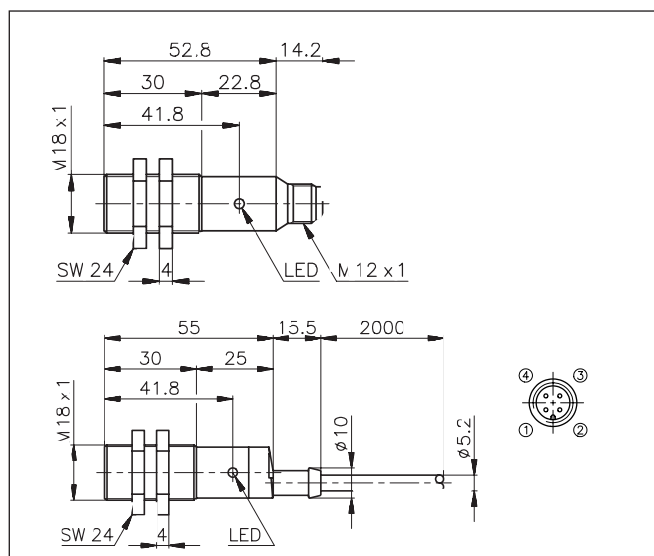

Wiring Diagrams

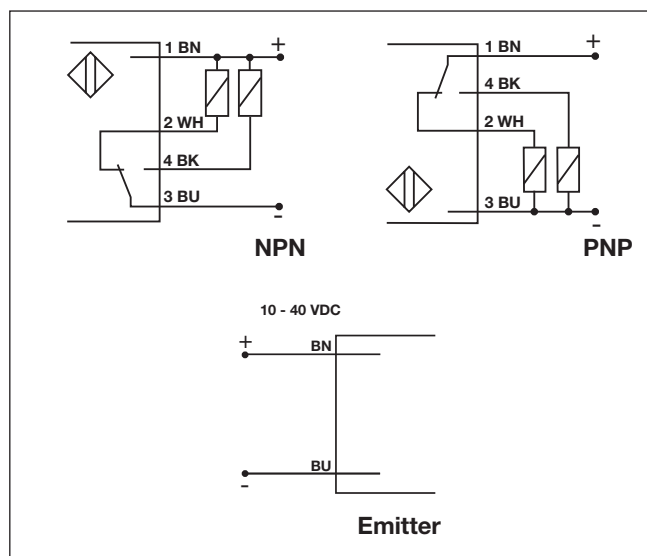

Detection Diagram

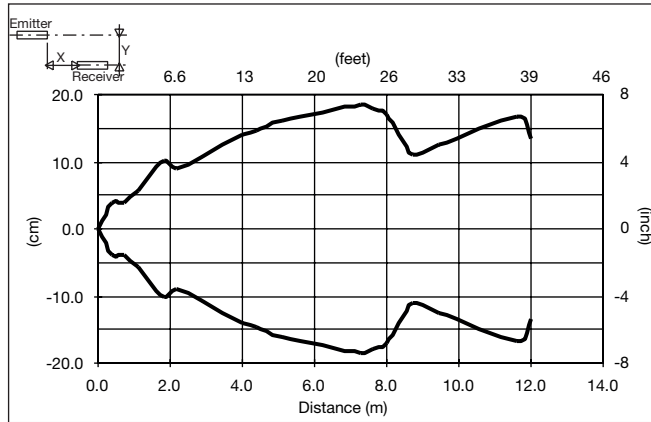

Delivery Contents

- Photoelectric switch: ET 1820 ..
- 2 nuts
- **Packaging:** Plastic bag

Accessories

- MB18A
- Connector type CON.14NF.. series
- APA18-RAR
- APA18-AR

Installation Hints

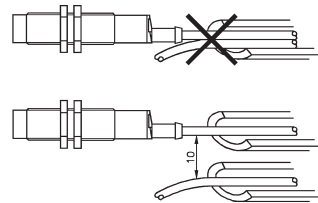
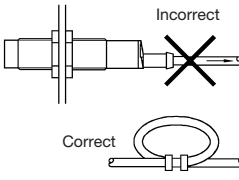
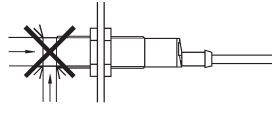
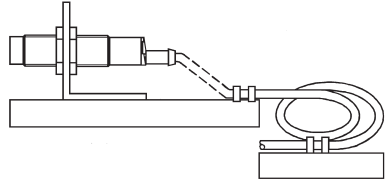
<p>To avoid interference from inductive voltage/current peaks, separate the prox. switch power cables from any other power cables, e.g. motor, contactor or solenoid cables</p> 	<p>Relief of cable strain</p>  <p>The cable should not be pulled</p>	<p>Protection of the sensing face</p>  <p>A proximity switch should not serve as mechanical stop</p>	<p>Switch mounted on mobile carrier</p>  <p>Any repetitive flexing of the cable should be avoided</p>
--	--	---	---