

compact™
USER MANUAL

PIVOT
vapors™

EVOLVE TO LUXURY

Welcome to the world of vaping! We are sure you are as excited about vaping as we are, and all that vaping has to offer.

At PIVOT, we are sticklers for perfection, driven by one basic principle: To create value for our customers. We are confident that our passion, dedication and pursuit of excellence will clearly show through in all our **consumer-centric** products and services.

No costs are spared in ANY vertical of our processes, ONLY the BEST materials are used, the latest technologies employed, and countless man-hours spent researching and perfecting every minute aspect.

The labor of love...is there any other kind?! We are hopeful that you will derive as much pleasure in using our products as we do in making them.

Thank you for purchasing a Pivot Vapors Product. Go on, take a hit!!

Queries, questions, concerns?

✉ wecare@pivotvapors.com

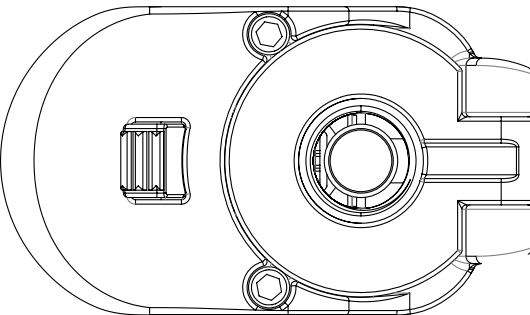

"Intelligence is based on how efficient a species became at doing the things they need to survive"

Let's EVOLVE!

- Charles Darwin

Technical Specifications

Battery Capacity:	1050 mAh
Voltage Range:	0-5.5V
Wattage Range:	0-15W
Size:	37 x 21 x 58 mm

Notice of Use

Do take time to read this manual. It will take **ONLY 10 minutes** of your time, but it will ensure that you enjoy your device to the fullest.

Schematic Diagram

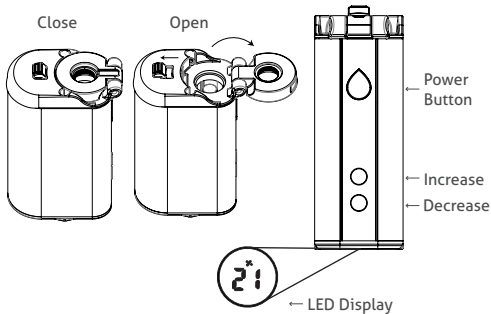

Standard Features

Main Display:

- a) Seconds Vaped Per Hit.
or
- b) Battery Life Indicator.
or
- c) Voltage Or Wattage Setting.
or
- d) Total Puff Count

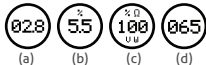

Toggle Display:

- Resistance of Coil.
- Battery Life Indicator.
- Voltage Or Wattage Setting.



Display During Usage:

- Seconds Vaped Per Hit.



To maximize convenience, we have designed a state-of-the-art hinge that allows you to collapse the tank and bring it next to the body of the device. To fold, simply pull the lever back to release lock.

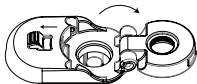

Variable voltage/wattage:

You can lower the voltage/wattage in all our devices. Lowering voltage/wattage will decrease the amount of heat of vapor and also the amount of vapor being produced.

Pass-through: All our devices are charged through a Micro USB Port and can be recharged with any standard Micro USB cable. Pass-through means that you can vape WHILE the power unit is being charged!

Settings retention: Our power units remember the last voltage/wattage setting you applied, eliminating the need to set it every time.

Constant power level: Our devices are programmed to not reduce the voltage/wattage setting (aka heat and vapor) just because the battery has low power, thus providing you with a consistent and best experience throughout the day.

10-second cut-off: If the power button remains pressed for more than ten seconds, our devices will automatically stop to ensure safety.



Lock feature: Pressing the increase and decrease button together and holding for 3 seconds will lock the voltage setting.

Total Puff Count:

The total puff count can be seen on the screen after the fire button is pressed and then released. The screen flashes puff count as one of the displays.



- **To Reset Total Puff Count:** hold the power button and increase button simultaneously for 2 seconds.

Assembling Device

Let's start with the basics, how to assemble your tank.

Power Unit

Although our units come charged, it is advisable to charge your battery for a few hours before first use.

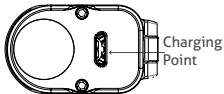

Tell us your experience! We would love to hear from you!

✉ wecare@pivotvapors.com

How To Use

There are three main buttons on the Compact model:
Power Button, Increase Button, and Decrease Button.

Using these three buttons can activate all functions of the device.

Turn on/off:

Click the power button 5 times within a span of 7 seconds to turn your device on or off.

Main Screen/Toggle Screen:

Press the power button 3 times within a span of 7 seconds to view the different displays.

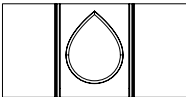

To Use:

- a) Inhale SLOWLY. You do not need to apply too much force as vapor is already being produced on pressing the button.
- b) Inhale smaller puffs than you normally would. In just 2 seconds of vaping you inhale a higher quantity of vapor as compared to cigarette smoke. Vapor is much lighter than smoke.

- c) Vapor is very light because it does NOT have any toxic chemicals, whereas cigarettes have 4000 chemicals, and these chemicals increase the weight of smoke.
- d) Inhaling too much vapor at one time may cause condensation of vapor in your throat, thereby causing you to cough.

Remember that you are NOT coughing due to throat damage from harsh chemicals like those found in cigarette smoke.

All devices will stop producing vapor after 10 seconds of holding the button as a protection mechanism.

Increase/Decrease voltage:

When the screen is blank, click the power button 3 times within a span of 5 seconds. Press increase/decrease button till V flashes, then press fire button to select volts. Press increase button to increase volts and decrease button to decrease volts. When done press fire button again to return to original screen.

(Follow similar procedure to change wattage, but until W flashes)

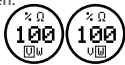

Voltage/Wattage Settings:

Set the wattage of the device according to your user preference of how hot and how much vapor you want. **Ensure, you do not set wattage to more than Maximum Tank operating wattage ability. (Refer to tank manual).**

How To Hold

- There can be many comfortable ways to hold your device, find the way most suited to you! If you think you have stumbled upon a cool new way to vape, then upload your picture on our social platform to win a free gift.
facebook.com/pivotvapors.

Tell us your experience! We would love to hear from you!

✉ wecare@pivotvapors.com

Troubleshooting

LEAKAGE

1. Open the tank and check if the coil is screwed tightly to the tank base.
2. In some tank models, the tank opens from both sides. Make sure both sides are tightly shut.
3. If you can taste the E-Juice while inhaling then check if you have overfilled the tank or filled liquid in the center chamber by accident *(If you have, simply clean the mouth piece and the center tunnel using a tissue paper.)*

BURNT TASTE

1. If you did NOT wet the coil before first use, then it is possible that you have burnt the coil. Take a new coil and make sure you wet the coil before first use.
2. If you have been using the device for a while, then it is possible that it may be time to replace your coil. The lifespan of a coil is between 10-15 days, depending on usage.

3 Make sure your tank has enough E-Juice.

4. Ensure that you aren't using a higher voltage than the tank's operating capability. *For more information on this, refer to the manual that came with the tank.*

LESS VAPOR

1. Unscrew the tank from the battery. (Be careful not to unscrew the tank base from the tank as that will lead to spilling of E-Juice).
2. Clean the contact point of tank and battery with a tissue.
3. Clean the mouth piece and the center tunnel using a tissue paper.
4. Check to see if the voltage is too low and increase if necessary.

“No Coil” Indication or Not Firing:

- Open the tank and tighten the coil into the base.
- Clean the contact point of the battery and tank well.
- If this doesn't work then try replacing the coil.
- Check to see if your power unit is charged.

“Coil Low” Indication:

- Open the tank and tighten the coil into the base.
- Make sure the tank is also tightened into the battery.
- If this doesn't work then try replacing the coil.

If any problem continues to persist despite the steps mentioned above, then please contact Pivot at ✉ wecare@pivotvapors.com

Warning !

- Our Products are NOT TO BE used by anyone under the age of 18, women who are pregnant or breastfeeding, people with or at risk of heart disease, or people taking medication for depression or asthma.
- This unit may include small parts, please keep out of the reach of children and pets.
- Please obey local laws or regulations while vaping. If there are any bans or potential dangers, please keep the device off.

Refund/Returns

We want you to enjoy your device. If you are not satisfied for any reason, we offer a 15 days, "no questions asked" return policy on the power unit and tank.

Warranty

We also offer a 6 months limited warranty on our devices.

Damage caused due to negligence or abuse will not be covered under the warranty.

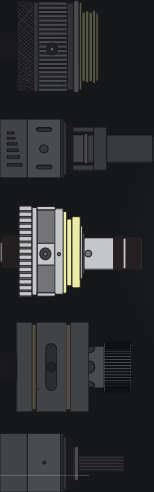

dew™
USER MANUAL

PIVOT
vapors™

EVOLVE TO LUXURY

Welcome to the world of vaping! We are sure you are as excited about vaping as we are, and all that vaping has to offer.

At PIVOT, we are sticklers for perfection, driven by one basic principle: To create value for our customers. We are confident that our passion, dedication and pursuit of excellence will clearly show through in all our **consumer-centric** products and services.

No costs are spared in ANY vertical of our processes, ONLY the BEST materials are used, the latest technologies employed, and countless man-hours spent researching and perfecting every minute aspect.

The labor of love...is there any other kind?! We are hopeful that you will derive as much pleasure in using our products as we do in making them.

Thank you for purchasing a Pivot Vapors Product. Go on, take a hit!!

Queries, questions, concerns?

✉ wecare@pivotvapors.com

“Intelligence is based on how
efficient a species became
at doing the things they
need to survive”

- Charles Darwin

Let's EVOLVE!



Technical Specifications

Ideal Operating Wattage: 15W

Wattage Range: **5-15W**

Resistance: **1.6 Ω or 1.8 Ω**

Tank Capacity: **2.5ml**

Tank Construction: **Stainless Steel 304 and
Pyrex Glass**

Tank Size: **Ø18mm * 71mm**

Coil Type: **Bottom Vertical Coil**

Schematic Diagram

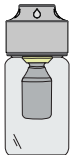

Mouth Piece

Tank Cap

Glass Tube

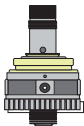

Coil

Rubber Ring

Tank Base

Airflow Control Valve

Standard Features

Adjustable airflow

Less Airflow: Harder pull (more effort), higher heat, less flavor intensity, smaller cloud size, and apt for mouth hits.

More Airflow: Easier to pull (less effort), lower heat, more flavor intensity, larger cloud size, and apt for deep and lung filling hits.

Zero Airflow: Completely closing the airflow will eliminate the flow of vapor.

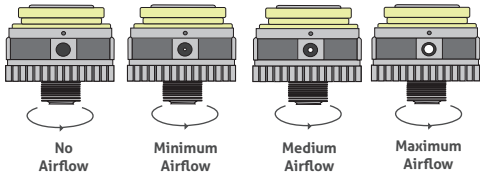

Assembling Device

Let's start with the basics, how to assemble your tank.

Tank Unit

1. Unscrew the tank base (counter clockwise) from tank.

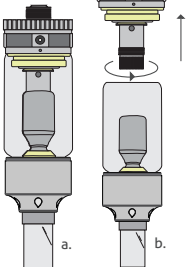

- 2.

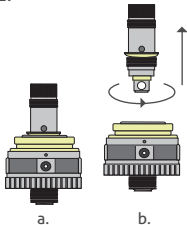

Unscrew the coil (counter clockwise) from the tank base.

3. Slowly drop about 3-4 drops of Pivot E-Juice on the coil to soak the internal cotton (if visible) and external cotton holes. Only do this step if your coil is brand new.

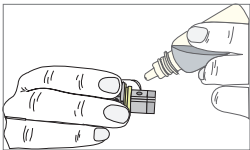

- a. The goal is to soak the cotton completely before the *FIRST* use.
- b. The coil will need be replaced every few days, depending on usage.
- c. You will know it's time to replace if your flavor starts to taste like ash!
(Refer to trouble shooting and tips on "Burnt Taste")

4. Screw the soaked coil into base, ensuring it is tight.

5. To fill

- a. To avoid spilling, invert the tank so the mouthpiece is pointing downwards, then unscrew the base counter-clockwise.

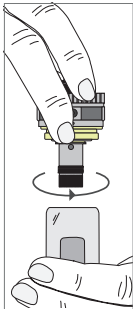

- b. Fill the tank with Pivot E-Juice by pouring the juice into the tank at an angle.

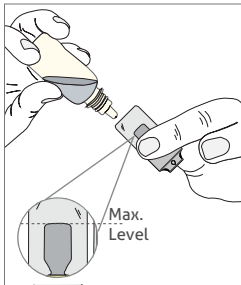

- c. Ensure you do not overfill the tank! Every tank has a different maximum level.

d. Do not pour E-Juice into the center vapor chamber.

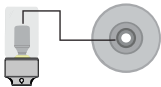

7. If needed clean the outside and the bottom of the tank with a tissue.

8. Screw the tank (clockwise) onto the power unit.

9. If you are using a new coil then wait 1-2 mins before using, then inhale 5 times before turning on the power unit, to completely soak the coil.

6. Screw the base onto the tank, ensuring that it is tight.



Write to us at

✉ wecare@pivotvapors.com
and tell us your experience!

We would love to hear from you!

Troubleshooting

LEAKAGE

1. Open the tank and check if the coil is screwed tightly to the tank base.
2. In some tank models, the tank opens from both sides. Make sure both sides are tightly shut.
3. If you can taste E-Juice while inhaling then check if you have overfilled the tank or filled liquid in the center chamber by accident.

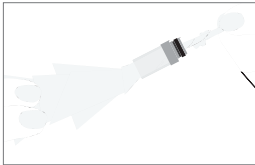

BURNT TASTE

1. If you did NOT wet the coil before first use, then it is possible that you have burnt the coil. Take a new coil and make sure you wet the coil before first use (instructions on page 8).
2. If you have been using the device for a while, then it is possible that it may be time to change your coil. The lifespan of a coil is a few days, depending on usage.
3. Make sure your tank has enough E-Juice.

4. **Ensure that you aren't using a higher voltage than the tank's operating capability.**

For more information on this, refer to the technical specifications in this manual.

LESS VAPOR

1. Unscrew the tank from the battery. (Be careful not to unscrew the tank base from the tank as that will lead to spilling of E-Juice).
2. Clean the contact point of tank and battery with a tissue.
3. Clean the mouth piece and the center tunnel using a tissue paper.

4. Check to see if the voltage is low and increase if necessary.

“No Coil” Indication or Not Firing:

- Open the tank and tighten the coil into the base.
- Clean the contact point of the battery and tank well.
- If this doesn't work then try replacing the coil.
- Check to see if your power unit is charged.

“Coil Low” Indication:

- Open the tank and tighten the coil into the base.
- Make sure the tank is also tightened into the battery.
- If this doesn't work then try replacing the coil.

If any problem continues to persist despite the steps mentioned above, then please contact Pivot at [✉ wecare@pivotvapors.com](mailto:wecare@pivotvapors.com)

Warning !

- Our Products are NOT TO BE used by anyone under the age of 18, women who are pregnant or breastfeeding, people with or at risk of heart disease, or people taking medication for depression or asthma.
- This unit may include small parts, please keep out of the reach of children and pets.
- Please obey local laws or regulations while vaping. If there are any bans or potential dangers, please keep the device off.

Refund/Returns

We want you to enjoy your device. If you are not satisfied for any reason, we offer a 15 days, "no questions asked" return policy on the power unit and tank.

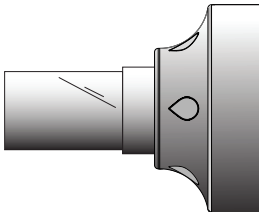

Warranty

We also offer a 6 months limited warranty on our devices.

Damage caused due to negligence or abuse will not be covered under the warranty.

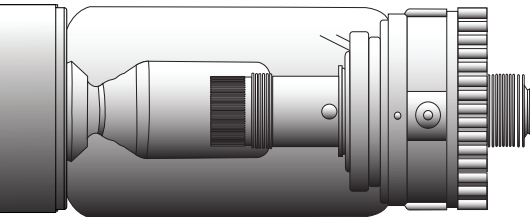

Copyright © Pivot Vapors
All Rights Reserved.

✉ wecare@pivotvapors.com  facebook.com/pivotvapors