

INSTRUCTION MANUAL

VERTICAL COOLER

Ventilated Cooling Series

Static Cooling Series



*Please read the user' s manual before you use this product.
If you request unnecessary services, you may waste money.
Thus, fix simple troubles by yourself which you have found.*



Content:

1.Preface.....	2
2.Use of the equipment.....	3
3.Technical features.....	3
4.Operation.....	3
5.Control unit.....	4
6.Handling.....	4
7.Installation procedure.....	5
8.Connecting to the main power supply.....	5
9.Maintenance instructions.....	6
Cleaning.....	6
Cleaning the refrigerator surface.....	6
Cleaning the inside of the refrigerator.....	7
Cleaning the condenser.....	7
10.Troubleshooting.....	7
11.Technical service.....	7
12.Configuration Sketch Map.....	8
Operating Instruction.....	8
Official Approval And Rules.....	14
Technical Parameters.....	15



1. Preface

This instruction manual provides all the necessary information regarding:

- ▲ use of the refrigerator
- ▲ technical specifications
- ▲ installation and handling
- ▲ operator procedures and instructions
- ▲ maintenance operation

The manual is to be considered an integral part of the refrigerator and should be stored in a safe place for future consult to permit a good working life of the refrigerator.



ATTENTION

The manufacturer cannot be held liable in the following cases:

- improper installation (not in accordance with the guidelines indicated herein)
- misuse of the refrigerator
- power supply defects
- improper or inadequate maintenance
- unauthorised modification or tampering
- use of non-original spare parts
- partial or total failure to comply with the instructions

All electrical equipment can be hazardous to health. Current standards and legal requirements must be complied with during the installation and use of any equipment.



2. Use of the equipment

The refrigerator are for preserving fresh perishable foodstuffs, with an in-built refrigerated unit.

Do not utilise the equipment to store medical supplies.

The optimum operational ambient temperatures are between +10°C /+40°C

3. Technical features

The refrigerator is a ventilated system, the evaporator is in a separate insulated box on the top. All the materials used in the manufacture of this unit are guaranteed to be suitable for use with foodstuffs. The gases used in refrigerator is R134a; in the refrigerator for frozen food maintenance is R404a.

The refrigerating circuit are in compliance with the current normative.

4. Operation

The gas in the refrigerating circuit is in the first time compressed, liquefied and then evaporated in the ventilated evaporator, situated on the top of the container.

This cycle involves the absorption of heat from the air in the refrigerator compartment and the reason is cooled. The heat produced is then dissipated to the outside environment by a condenser unit located on the top of the refrigerator.



5. Control unit

The refrigerator is command from a “digital control unit” and a “main switch pilot light” in the top panel of the refrigerator.

The “main switch pilot light” is for turning on the power supply.

The red pilot light comes on to indicate that the unit is connected to the main electricity and to start work.

The red pilot light comes off to indicate that the unit is disconnected and don’ t work. The “digital control unit” is for the regulation of all parameters to provide the correct working of the refrigerator. Please consult all parameters in the attachment manual of the “digital control unit”.

This manual is part of the instruction manual and is very important in case of service.

6. Handling

The refrigerator arrive in PET film and packed in cardboard box on a wood pallet.



The refrigerator must be transported and handled with care to avoid posing a hazard to persons or property.

Never place a refrigerator with an in-built refrigerated unit on its side or turn it upside

down as this may damage or impair operation of the refrigerated unit.

We can not held liable for any damage or defects arising directly or indirectly from improper handling of the equipment or non-compliance with the safeguards illustrated above.





7. Installation procedure

▲ Place the refrigerator in the coolest and best ventilated part of the room. Don't install the refrigerator in the near of heat and direct sunlight sources.

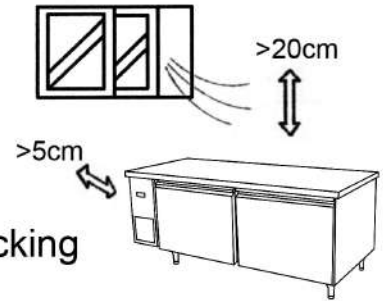

▲ Remove the straps securing the cardboard packing

Remove the cardboard. Covering

Remove the PET protection film

▲ Clean the refrigerator with mild detergent and then dry it with a soft cloth.

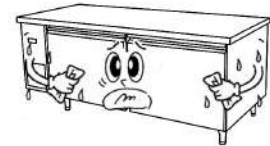

8. Connecting to the main power supply



This operation must be carried out by professionally and qualified persons.

The refrigerator are supplied complete with a power supply cable for the connection to the main power supply. A thermomagnetic circuit breaker (not supplied) must be installed between the mains power point and the power supply cable of the refrigerator.

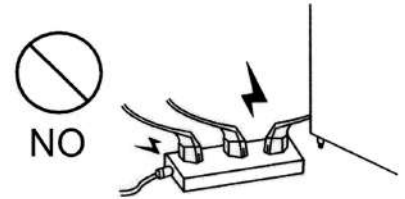

Before proceeding make sure that:

▲ the mains voltage corresponds to the voltage on the refrigerator 220V/50Hz/1Ph; to ensure proper operation it is essential for the power supply voltage to come within a range of +/- 6% of the unit's rated voltage

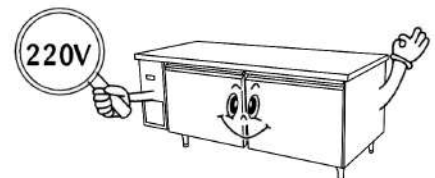



- ▲ the electric system to which the refrigerator is sized to cater for the rated electric output of the buffet unit being installed
- ▲ the electronic system to which the refrigerator is connected is made in compliance with current standard requirements
- ▲ the electric connections and the installation of the thermomagnetic circuit breaker have been done by qualified person.

Connecting steps:

- ▲ Install a thermomagnetic circuit breaker suited to the rated output of the unit being installed
- ▲ Connect the refrigerator unit to the thermomagnetic circuit breaker outlet
- ▲ Check that the refrigerator is in order as demonstrated by the pilot light incorporated in the main switch coming on

9. Maintenance instructions

The smooth operation and life of the equipment are mainly determined by correct and regular maintenance

Cleaning:

Regular cleaning of the refrigerator unit is strongly recommended each month. Please follow the instructions below.



Disconnect the refrigerator power supply cable from the mains prior to carrying out any type of cleaning operation.

Cleaning the refrigerator surface:

Clean the refrigerator with mild detergent and then dry it with a soft cloth.

Do not use abrasive detergents!

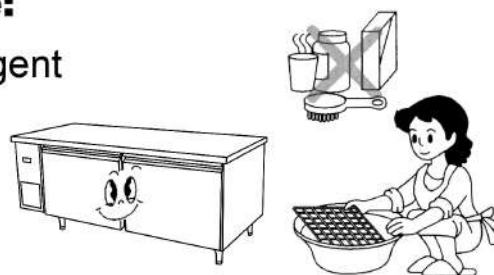



Cleaning the inside of the refrigerator:

Clean the inside area min. each month with a detergent suitable for use with foodstuffs.

Cleaning the condenser:

For an efficient operation of the refrigerator it is advisable to clean the condenser regularly approx. every 4 months with a dry brush or vacuum cleaner.

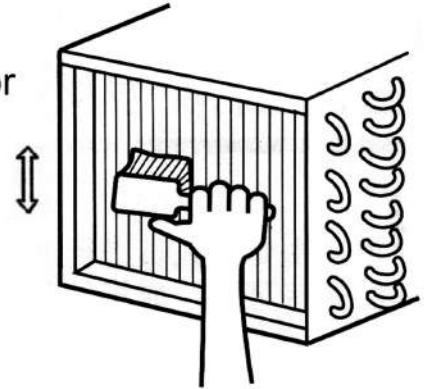

10. Troubleshooting

Refrigerator stops working (light off):

- ☆ Power supply failure

▲ Remedies:

- ☆ Check that the plug is inserted properly in the socket
- ☆ Check that the switch on/off
- ☆ Check that the mains voltage powers the plug

Refrigerator temperature go up:

- ☆ Unit too near to a heat source
- ☆ Condenser dirty or close

▲ Remedies:

- ☆ Move the counter or the heat source further away
- ☆ Clean the condenser

11. Technical service

For technical service please contact the dealer technical department and give him the serial n°, and the date of buy.



12. Configuration Sketch Map

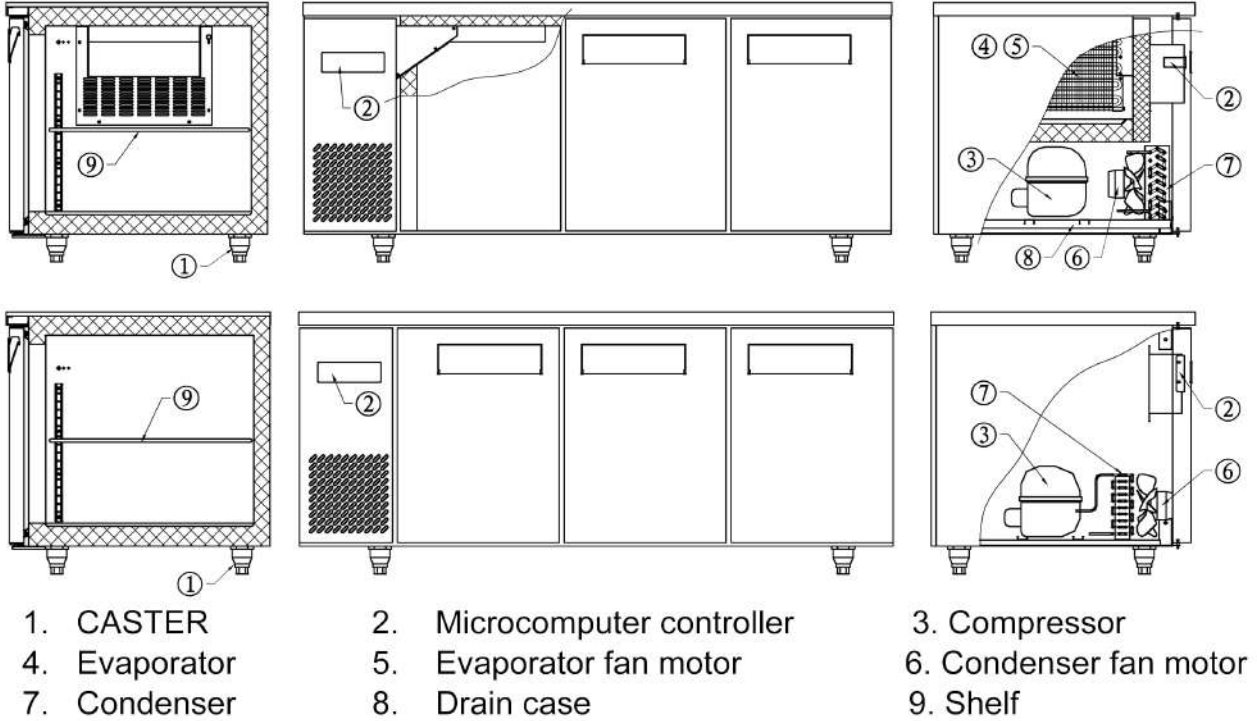

Operating Instruction

1. New upright air-cooling refrigerator should be opened and ventilate it before it is in use. After that, users should use warm water clean its inside.
2. After connecting the power supply, press the "POWER" switch on the controller keyboard (Green Indicator Light ON), the fridge will come to work. The microcomputer controller, installed in the controller keyboard, could automatically adjust the temperature ranges. This intelligent digital controller works as: if the temperature increases and reaches set point plus differential the compressor is started and then turned off when the temperature reaches the set point value again.





3. Microcomputer Controller Operation Instruction:

4. Microcomputer panel sketch map, meanings of running indicator light and LED showing.

5. **SET** To display target set point, in programming mode it selects a parameter or confirm an operation.



(Mod. XR06CX)

❄ To start a manual defrost.

▲ In programming mode it browses the parameter codes or increases the displayed value .

▼_{AUX} In programming mode it browses the parameter codes or decreases the displayed value .

▼+▲ To lock or unlock the keyboard

SET+▼ To enter in programming mode

SET+▲ To return to room temperature display .

6. How to see the point .

Push and immediately release the SET key, the set point will be showed;
Push and immediately release the SET key or wait about 5s to return to normal visualisation.

7. How to change the setpoint .

Push the SET key for more than 2 seconds to change the Set point value;
The value of the set point will be displayed and the “°C” or “°F” LED starts blinking;

To change the Set value push the ▲ or ▼_{AUX} arrows.

To memorise the new set point value push the SET key again or wait 10s.

8. How to start a manual defrost .

Push the DEF ❄ key for more than 2 seconds and a manual defrost will start .

LED	MODE	SIGNIFICATO
❄	On	Compressor enabled
	Flashing	Anti short cycle delay enabled (AC parameter)
❄	On	Defrost in progress
	Flashing	Dripping in progress
🌀	On	Fans output enabled
	Flashing	Fans delay after defrost
°C	On	Measurement unit
	Flashing	Programming mode
°F	On	Measurement unit
	Flashing	Programming mode



9. How to change a parameter value

To change the parameter's value operate as follows:

Enter the Programming mode by pressing the **SET+▼** keys for 3s
(“°C” or “°F” LED starts blinking).

Select the required parameter. Press the “SET” key to display its value

Use **▲** or **▼_{AUX}** to change its value.

Press “SET” to store the new value and move to the following parameter.

To exit: Press **SET+▲** or wait 15s without pressing a key.

NOTE: the set value is stored even when the procedure is exited by waiting the time-out to expire.

10. To lock the keyboard .

Keep pressed for more than 3s the **▼+▲** keys.

The “OF” message will be displayed and the keyboard will be locked.

If a key is pressed more than 3s the “OF” message will be displayed.

11. To unlock the keyboard .

Keep pressed together for more than 3s the **▼+▲** keys till the “on” message will be displayed .

12. Alarm signalling .

Mess.	Cause	Outputs
"P1"	Room probe failure	Compressor output according to “Cy” e “Cn”
"P2"	Evaporator probe failure	Defrost end is timed
"HA"	Maximum temperature alarm	Outputs unchanged
"LA"	Minimum temperature alarm	Outputs unchanged
"EA"	External alarm	Outputs unchanged
"CA"	Serious external alarm	All outputs OFF
"dA"	Door Open	Compressor and fans restarts



CAREL: PJEZ*

Display and functions:

During normal operation, the controller displays the value of the probe set using parameter/4(=1 ambient probe, default,=2 second probe, =3 third probe).In addition, the display has LEDs that indicate the activation of the control functions(see Table 1),while the 3 buttons can be used to activate/deactivate some of the functions (see table 2).

LEDs and associated functions Tab.1

icon	function	normal operation			start up
		ON	OFF	blink	
	Compressor	on	off	request	ON
	fan	on	off	request	ON
	defrost	on	off	request	ON
AUX	aux	output on	output off	-	ON
	alarm	all	no alarm	-	ON
	clock	RTC fitted and enabled,at least 1 time band set	RTC not fitted or disabled,not even 1 time band set	-	ON if RTC fitted

Table of functions activated by the buttons Tab.2

button	normal operation		start up	
	pressing the button alone	pressed together		
	up ON/OFF	more than 3s toggle ON/OFF	pressed together start/ stop continuous cycle	-
	down defrost	more than 3s: start/stop defrost		Pressed together start parameter reset procedure
	set mute	-1s: display/set the set point -more than 3s: access parameter setting menu(enter password 22) -mute audible alarm (buzzer)	-	for 1s display firmware vers. code for 1s RESET current EZY set



Setting the set point(desired temperature)

- press SET for 1s the set value will start flashing after a few moments;
- increase or decrease the value using UP or DOWN;
- press SET to confirm the new value.

Switching the device ON/OFF

Press UP for more than 3s. the control and defrost algorithms are now disabled and the instrument displays the message "OFF" alternating with the temperature read by the set probe.

Manual defrost

Press for DOWN more than 3s (the defrost starts only the temperature conditions are valid).

Continuous cycle

Press UP and DOWN together for more than 3s.

Table of alarms

Alam code	buzzer and alarm relay	LED	Description	Parametri coinvolti
E0	active	ON	probe 1 error=control	-
E1	inactive	ON	probe 2 error=defrost	[d0=0/1]
E2	inactive	ON	probe 3 error=condenser	[A4=10]
IA	active	ON	external alarm	[A4=10][+A7]
dOr	active	ON	open door alarm	[A4=7/8][+A7]
LO	active	ON	low temperature alarm	[AL][Ad]
HI	active	ON	high temperature alarm	[Ah][Ad]
EE	inactive	ON	unit parameter error	-
EF	inactive	ON	operating parameter error	-
Ed	inactive	ON	defrost ended by timeout	[dP][dt][d4][A8]
dF	inactive	ON	defrost running	[d6=0]
cht	inactive	ON	condenser dirty pre-alarm	[A4=10]
CHT	active	ON	condenser dirty alarm	[A4=10]
EtC	inactive	ON	clock alarm	



Our products have been modified precisely before leaving factory, so to avoid damaging compressor unit or other malfunctions, users mustn' t modify the microcomputer parameters privately.



OFFICIAL APPROVAL AND RULES

Our products full fill the present E.U. rules, including the CE mark of the European official approval

Latest version of following directives and standards

2006/42/EC

2014/30/EU

2012/19/EU

2011/65/EU

EN 60335-1

EN 60335-2-89

EN 62233

EN 55014-1

EN 61000-3-2

EN 61000-3-3

EN 55014-2





Technical Parameters

Ventilated Cooling Series

Product Name	Model code	Prevention class of getting an electric shock	Power source (V) Rating frequency(Hz)	Rated current(A)	Temperature range (°C)	Refrigerant	Dimension (mm)	Net Weight (kg)
TWO DOOR REFRIGERATOR	YPF9020	I	220/50	1.5	-2~+8	R134a	1200×600×800	71
TWO DOOR FREEZER	YPF9025	I	220/50	2.5	-22~-12	R134a	1200×600×800	71
TWO DOOR REFRIGERATOR	YPF9022	I	220/50	1.5	-2~+8	R134a	1200×700×800	79
TWO DOOR FREEZER	YPF9027	I	220/50	2.5	-22~-12	R134a	1200×700×800	79
TWO DOOR REFRIGERATOR	YPF9023	I	220/50	1.5	-2~+8	R134a	1200×750×800	83
TWO DOOR FREEZER	YPF9028	I	220/50	2.5	-22~-12	R134a	1200×750×800	83
TWO DOOR REFRIGERATOR	YPF9024	I	220/50	1.5	-2~+8	R134a	1200×800×800	85
TWO DOOR FREEZER	YPF9029	I	220/50	2.5	-22~-12	R134a	1200×800×800	85
TWO DOOR REFRIGERATOR	YPF9030	I	220/50	1.8	-2~+8	R134a	1500×600×800	74
TWO DOOR FREEZER	YPF9035	I	220/50	2.8	-22~-12	R134a	1500×600×800	76
TWO DOOR REFRIGERATOR	YPF9032	I	220/50	1.8	-2~+8	R134a	1500×700×800	85
TWO DOOR FREEZER	YPF9037	I	220/50	2.8	-22~-12	R134a	1500×700×800	85
TWO DOOR REFRIGERATOR	YPF9033	I	220/50	1.8	-2~+8	R134a	1500×750×800	89
TWO DOOR FREEZER	YPF9038	I	220/50	2.8	-22~-12	R134a	1500×750×800	89
TWO DOOR REFRIGERATOR	YPF9034	I	220/50	1.8	-2~+8	R134a	1500×800×800	94
TWO DOOR FREEZER	YPF9039	I	220/50	2.8	-22~-12	R134a	1500×800×800	94
THREE DOOR REFRIGERATOR	YPF9040	I	220/50	1.8	-2~+8	R134a	1800×600×800	81
THREE DOOR FREEZER	YPF9045	I	220/50	2.8	-22~-12	R134a	1800×600×800	81
THREE DOOR REFRIGERATOR	YPF9042	I	220/50	2.0	-2~+8	R134a	1800×700×800	91
THREE DOOR FREEZER	YPF9047	I	220/50	3.2	-22~-12	R134a	1800×700×800	91
THREE DOOR REFRIGERATOR	YPF9043	I	220/50	2.0	-2~+8	R134a	1800×750×800	96
THREE DOOR FREEZER	YPF9048	I	220/50	3.2	-22~-12	R134a	1800×750×800	96
THREE DOOR REFRIGERATOR	YPF9044	I	220/50	2.0	-2~+8	R134a	1800×800×800	101
THREE DOOR FREEZER	YPF9049	I	220/50	3.2	-22~-12	R134a	1800×800×800	101



Static Cooling Series

Product Name	Model code	Prevention class of getting an electric shock	Power source (V) Rating frequency(Hz)	Rated current(A)	Temperature range (°C)	Refrigerant	Dimension (mm)	Net Weight (kg)
TWO DOOR REFRIGERATOR	YPL9120	I	220/50	1.3	-5~+5	R134a	1200×600×800	67
TWO DOOR FREEZER	YPL9125	I	220/50	2.0	-18~-8	R134a	1200×600×800	67
TWO DOOR REFRIGERATOR	YPL9122	I	220/50	1.3	-5~+5	R134a	1200×700×800	75
TWO DOOR FREEZER	YPL9127	I	220/50	2.0	-18~-8	R134a	1200×700×800	75
TWO DOOR REFRIGERATOR	YPL9123	I	220/50	1.3	-5~+5	R134a	1200×750×800	79
TWO DOOR FREEZER	YPL9128	I	220/50	2.0	-18~-8	R134a	1200×750×800	79
TWO DOOR REFRIGERATOR	YPL9124	I	220/50	1.3	-5~+5	R134a	1200×800×800	83
TWO DOOR FREEZER	YPL9129	I	220/50	2.0	-18~-8	R134a	1200×800×800	83
TWO DOOR REFRIGERATOR	YPL9130	I	220/50	1.4	-5~+5	R134a	1500×600×800	72
TWO DOOR FREEZER	YPL9135	I	220/50	2.0	-18~-8	R134a	1500×600×800	72
TWO DOOR REFRIGERATOR	YPL9132	I	220/50	1.4	-5~+5	R134a	1500×700×800	81
TWO DOOR FREEZER	YPL9137	I	220/50	2.0	-18~-8	R134a	1500×700×800	81
TWO DOOR REFRIGERATOR	YPL9133	I	220/50	1.4	-5~+5	R134a	1500×750×800	85
TWO DOOR FREEZER	YPL9138	I	220/50	2.0	-18~-8	R134a	1500×750×800	85
TWO DOOR REFRIGERATOR	YPL9134	I	220/50	1.4	-5~+5	R134a	1500×800×800	90
TWO DOOR FREEZER	YPL9139	I	220/50	2.0	-18~-8	R134a	1500×800×800	90
THREE DOOR REFRIGERATOR	YPL9140	I	220/50	1.5	-5~+5	R134a	1800×600×800	77
THREE DOOR FREEZER	YPL9145	I	220/50	2.0	-18~-8	R134a	1800×600×800	77
THREE DOOR REFRIGERATOR	YPL9142	I	220/50	1.5	-5~+5	R134a	1800×700×800	87
THREE DOOR FREEZER	YPL9147	I	220/50	2.0	-18~-8	R134a	1800×700×800	87
THREE DOOR REFRIGERATOR	YPL9143	I	220/50	1.5	-5~+5	R134a	1800×750×800	92
THREE DOOR FREEZER	YPL9148	I	220/50	2.0	-18~-8	R134a	1800×750×800	92
THREE DOOR REFRIGERATOR	YPL9144	I	220/50	1.5	-5~+5	R134a	1800×800×800	97
THREE DOOR FREEZER	YPL9149	I	220/50	2.0	-18~-8	R134a	1800×800×800	97
TWO DOOR REFRIGERATOR	EPL3520	I	220/50	1.8	-5~+5	R134a	1360×700×800	95
TWO DOOR FREEZER	EPL3521	I	220/50	2.9	-18~-12	R134a	1360×700×800	95
THREE DOOR REFRIGERATOR	EPL3530	I	220/50	1.8	-5~+5	R134a	1795×700×800	120
THREE DOOR FREEZER	EPL3531	I	220/50	2.9	-18~-12	R134a	1795×700×800	120

NOTES :

If the technical data has any changes, we will not notify you any longer.

