

User Guide

Thank you for purchasing a SKOPE refrigeration product.

Safety

Always observe safety precautions when using any electrical appliance. Read these instructions carefully and retain them for future reference.

WARNING

- Ensure the appliance is disconnected from the power supply before performing any cleaning or maintenance.
 - Do not cover the grilles or block the entry or exhaust of airflow by placing objects up against the refrigeration unit.
 - Should manual defrosting be necessary, turn off the refrigeration system and allow the ice to melt by air circulation. Collect ice and water during defrost to prevent a slip hazard. Do not use mechanical methods to remove ice, as this may damage the refrigeration circuit.
 - Do not use any electrical devices or appliances inside the food storage compartment.
-
- This appliance is not intended for use by persons (including children) with reduced physical, sensory or mental capabilities, or lack of experience and knowledge, unless they have been given supervision or instruction concerning use of the appliance by a person responsible for their safety. Children should be supervised to ensure that they do not play with the appliance.
 - Do not use this appliance for other than its intended use.
 - Do not insert fingers / foreign objects into any holes.
 - Only use this appliance with the voltage specified on the cabinet rating label.
 - Ensure the appliance has adequate ventilation as this is essential to economical, high performance.
 - Be careful not to touch internal moving parts and hot surfaces.
 - For your own safety and that of others, ensure that all electrical work is done by authorised personnel.
 - If the power supply flexible cord becomes damaged, it must be replaced by an authorised service agent or similarly qualified person in order to avoid a hazard.
 - Ensure all necessary safety precautions are observed during installation or removal of the refrigeration unit.
 - The appliance is not designed to be stable while in motion. Use extreme caution when moving or transporting it.
 - Do not store explosive substances such as aerosol cans with a flammable propellant in this appliance.
 - Do not exceed a maximum load of 20kg per shelf.
 - If the cabinet is to be scrapped, ensure the cabinet is unplugged from the power supply and cut off the mains flex close to the back of the cabinet. Be mindful of the risk of animals or children becoming trapped in the appliance - either remove or secure doors if necessary.
 - Refrigerant must be removed by a qualified service person and the cabinet recycled/disposed of in accordance with local regulations.

This cabinet is designed to operate within a specific climatic class environment. See the cabinet rating label inside the cabinet for climate class number.

Climate class	Ambient temperature	Relative humidity
3	25°C	60%
4	30°C	55%
5	40°C	40%
7 (tropical)	35°C	75%

The cabinet includes relevant hazard symbols that may be associated with the cooler. Refer to the information below for symbol description.



WARNING

The refrigeration system contains flammable R290 refrigerant. Do not tamper with it.

The refrigeration system must only be serviced by qualified personnel.

Door(s)/Drawers

Cabinets may have hinged stainless steel or glass doors, or stainless steel drawers. All cabinets are fitted with key locks, which can be unlocked with the supplied keys. It is not recommended to open the door(s) past 90°. The underbench drawers fit GN1/1, 100mm deep pans as an insert (supplied separately), and the pan top lip maximum height should be no more than 5mm. The chef base cabinet drawers fit GN 2/1, GN 1/1 and GN 1/6, 100mm deep pans (Pans are not supplied with fridge).

Installation Guidelines

Ensure the installation guidelines below are considered and met.

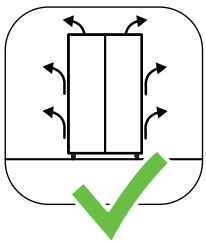

Ventilation

Ensure all ventilation requirements below are met.

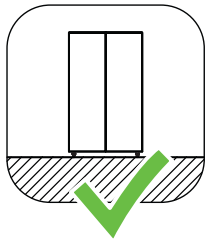

Surface

The installation surface must be capable of supporting the loaded cabinet.

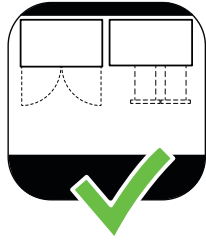

Door/Drawer Opening

Allow adequate space for the door(s)/drawers to open and close properly.

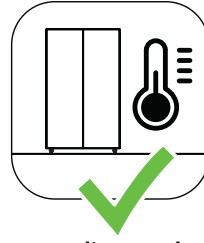

Climate Class

The cabinet must be installed in an environment within its climate class. The climate class is stated on the cabinet rating label inside the fridge, and explained on the front page of this user guide.

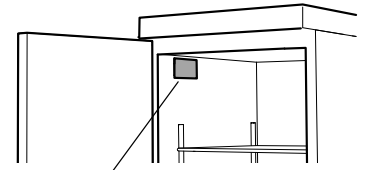

The rating label is located inside the cabinet at the top front of the left or right side wall. For cabinets with drawers it may be necessary to remove a top drawer to view the label.

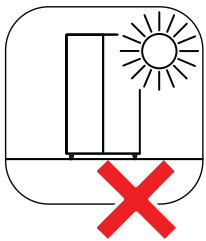

Sunlight

Do not install the cabinet in direct sunlight.

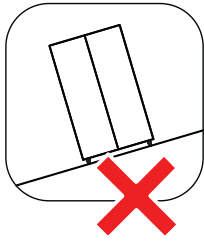

Uneven Surface

Do not install the cabinet on an uneven surface.

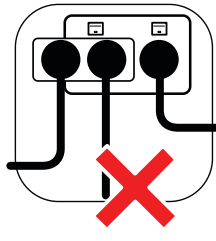

Power Supply

Do not overload the power supply.

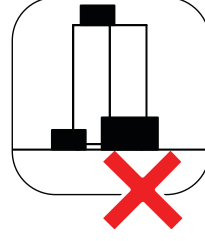

Blocking Ventilation

Do not store boxes or items in front or on top of the cabinet.

Ventilation Requirements

This cabinet must have the following ventilation clearances at all times:

Upright Cabinets

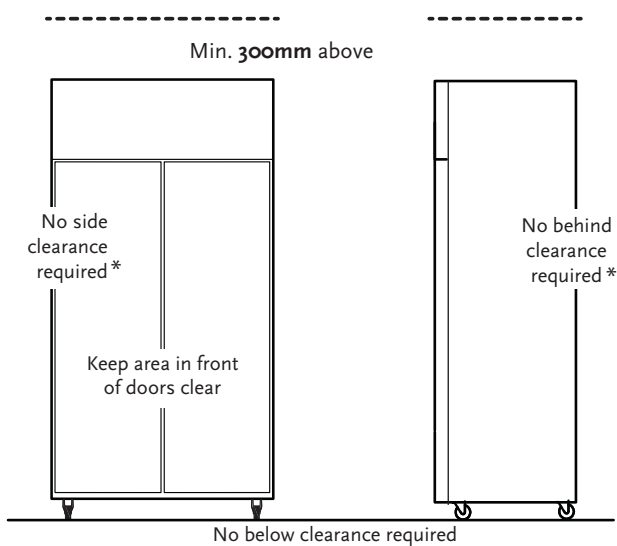

Underbench Cabinets

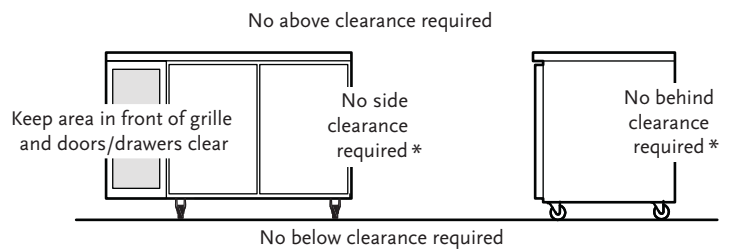

Chef Base Cabinets

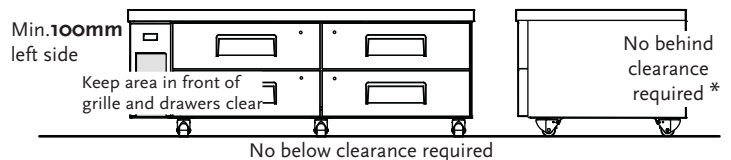

*When installed for continuous duty in climate class 7 environment (35°C ambient / 75% relative humidity), it is recommended to provide 50mm clearance around the sides and back of the cabinet.

Cleaning Before First Use

The cabinet interior, drawers and food contact surfaces such as the worktop must be thoroughly cleaned and sanitised before first use. Ensure the cabinet is unplugged from the power supply before cleaning, and use only standard stainless steel cleaners suitable for food preparation areas. If required, the cabinet exterior can be cleaned as instructed on the back page of this user guide.

Drawers

Where fitted, drawers should be removed for cleaning. Pull the drawer out of the cabinet, release latches at side of drawer as shown, and lift the drawer out at an angle. The drawer slider can also be removed by releasing the side catches as shown. Reverse operation to refit drawers to cabinet after cleaning.

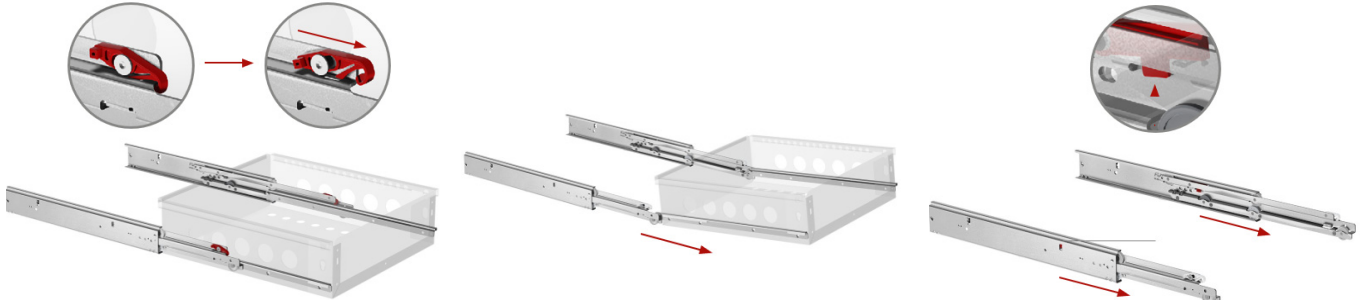

Shelves

Each shelf is held in place with four shelf clips, which clip into the shelf support strips, or on shelf feet which sit on the cabinet floor. The shelf clips may be positioned at different heights to suit various product.

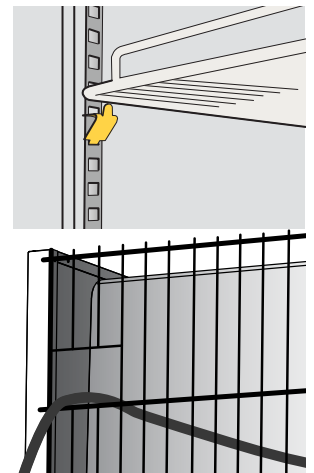

Power Cord

Before final positioning of the cabinet, pull the power cord out and connect to the power supply. When connecting an upright cabinet, ensure the power cord is routed through the opening on the wire grille at the back of the cabinet.

Loading product

Let the cabinet cool down to the desired storage temperature before loading it with product. When loading the shelves:

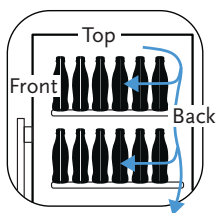

Internal Airflow

Leave 25mm space between product and the back and top of cabinet interior



Max. Loading

Do not overload the shelves



Shelf Flexing

Remove product if the shelf is flexing



Shelf Overhang

Do not let product overhang the shelves



Cabinet Floor

Do not load product on the cabinet floor. Use the shelves.

Weight Limits for Chef Base Fridge

To ensure a safe workplace, carefully examine and make note of how much weight you plan to place on the bench top of the chef base fridge. SKOPE recommends no greater than 200kg for the 2 drawer fridge and no greater than 400kg for the 4 drawer fridge.

Electronic Controller

The electronic controller regulates the cabinet internal temperature, signals alarms and captures operational information. The internal temperature is factory set for storage of perishable product.

To customise the settings to your requirements and view historical data, download the SKOPE-connect app from the Google Play Store or Apple App Store, and connect via **Bluetooth®** wireless technology.



Lights

Cabinets with hinged doors have interior lights which switch on and off automatically depending on usage.

Marine Edge

A Marine Edge on top of a chef base helps contain drips and spills. It also discourages items and equipment from slipping off the table, which increases safety.

Heat Shield

A heat shield is fitted inside the bench top of the chef base which can deflect some of the heat from the cooking equipment away from the refrigerated space. It is important to follow the equipment manufacturer's guidelines to maintain food safe holding temperatures and prolong the unit's life.

Routine Cleaning

Ensure the cabinet is unplugged from the power supply before cleaning.

IMPORTANT: Do **NOT** use abrasive, corrosive or solvent based cleaners, as this could damage the protective coating on the door exterior.

Wipe the outside of the cabinet with a damp cloth, and the inside of the cabinet with standard stainless steel cleaners suitable for food preparation areas. Take care to keep moisture away from electrical parts.

The condenser coil must be kept clean. SKOPE strongly recommends monthly cleaning of the condenser coil and air filter. Do **NOT** use hard or sharp tools to clean the coil as these may cause damage.

Note: Combination cabinets (cabinets with fridge and freezer) have two filters and coils.

Upright cabinets

Clean filter

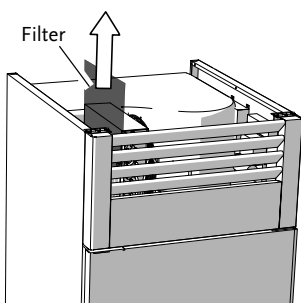

1. Unplug the cabinet from the power supply.
2. The filter is located on the side of the condenser coil, on top of the cabinet. Reach over the top of the cabinet and slide the filter up and off the cabinet.
3. Clean the filter with a vacuum cleaner, wash with cold water and shake off any excess water before refitting. Do NOT apply hot water, blow-dry or place in dishwasher. If necessary, discard and refit new filter.

Clean coil

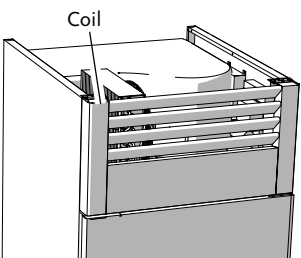

1. With the cabinet unplugged from the power supply and the filter removed (see steps above), brush the condenser coil with a soft brush to remove any dust and fluff.
2. Refit the filter and reconnect to the power supply.

Underbench & chef base cabinets

Clean filter

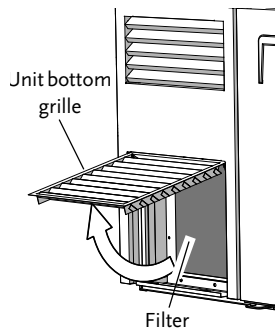

1. Unplug the cabinet from the power supply.
2. The filter is located behind the unit bottom grille. Rotate the grille out and slide the filter up and off the cabinet.
3. Clean the filter with a vacuum cleaner, wash with cold water and shake off any excess water before refitting. Do NOT apply hot water, blow-dry or place in dishwasher. If necessary, discard and refit new filter.

Clean coil

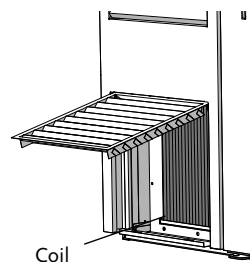

1. With the cabinet unplugged from the power supply and the filter removed (see steps above), brush the condenser coil with a soft brush to remove any dust and fluff.
2. Refit the filter, close the bottom grille and reconnect to the power supply.

Service & Support

We know you will get years of satisfaction from your new SKOPE product when you follow a few simple preventative maintenance guidelines.

Helpful information is available on the SKOPE website www.skope.com/serviceandsupport

