



Thanks to a continuous and regular flow, the water is distributed on a refrigerated surface designed to increase ice production. Three different sizes are available **FULL DICE, HALF DICE** and **LARGE DICE**

High production modular ice maker.  
Up to 400kg production per 24/hr of dice cube.  
Head only, stainless steel cabinet.  
Complete with water & drain hoses.  
15 AMPS, single phase power supply.



## ICE PRODUCTION

### Air Cooled Unit

Air Temp.		Water Temperature			
		32°	21°	15°	10°
°C					
°F					
10°		<b>360</b>	<b>395</b>	<b>420</b>	<b>430</b>
50°		794	871	926	948
21°		<b>340</b>	<b>370</b>	<b>390</b>	<b>400</b>
70°		750	816	860	882
32°		<b>280</b>	<b>305</b>	<b>312</b>	<b>320</b>
90°		617	672	688	705
38°		<b>225</b>	<b>250</b>	<b>257</b>	<b>265</b>
100°		496	551	567	584

### Water Cooled Unit

Air Temp.		Water Temperature			
		32°	21°	15°	10°
°C					
°F					
10°		<b>315</b>	<b>347</b>	<b>365</b>	<b>370</b>
50°		694	765	805	816
21°		<b>300</b>	<b>332</b>	<b>350</b>	<b>355</b>
70°		661	732	772	783
32°		<b>280</b>	<b>315</b>	<b>327</b>	<b>335</b>
90°		617	694	721	739
38°		<b>270</b>	<b>305</b>	<b>317</b>	<b>325</b>
100°		595	672	699	716

## CUBE TYPE

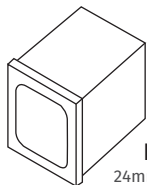

**10g**  
**FULL CUBE**  
24mm x 22mm x 22mm

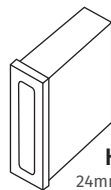

**6g**  
**HALF CUBE**  
24mm x 10mm x 29mm

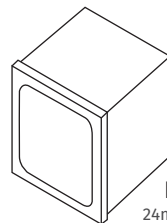

**17g**  
**LARGE CUBE**  
24mm x 29mm x 29mm

Solid ice cube, suitable for quick drink cooling, available in three different sizes, **FULL DICE (M models)**, **HALF DICE (MH models)** and **LARGE DICE (ML models)**, can be used in various applications: ice buckets, whisky on the rocks and cocktails.

## CONTROL PANEL

	Power
	Operating
	Bin Full / Washing
	Alarm
	High Pressure Alarm
	Reset Button / Washing

## SUGGESTED STORAGE BIN



BH122+KBT25  
Stainless steel  
storage bin.  
406kg capacity.













## DIMENSIONS

W x D x H (mm)  
760 x 620 x 725

## OPERATING REQUIREMENTS

Rejected Heat	4559 W
Air Volume	1180 m <sup>3</sup> /h
220-240/50/1	R404a GWP=3922
MIN	MAX
10°C (50°F)	40°C (104°F)
5°C (41°F)	35°C (95°F)
- 10 %	+ 10 %
1 Bar (14 psi)	5 Bar (70 psi)

## SPECIFICATIONS

	 cond	 comp. W	 ABS. W	 Fuse	 kWh/100kg	 L / hr	 kg	 lbs	 kg	 lbs	 Ton CO2 equiv.
<b>M402 A</b>		4360	2100	16	13.1	19.0	88	194	106	234	4.94
<b>M402 W</b>		4360	1900	16	10.6	210	83	183	101	223	2.55

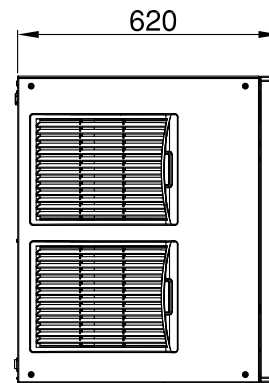
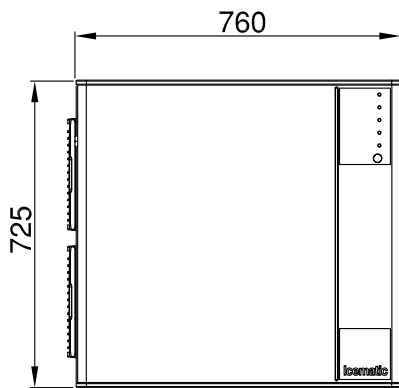

AIR COOLED

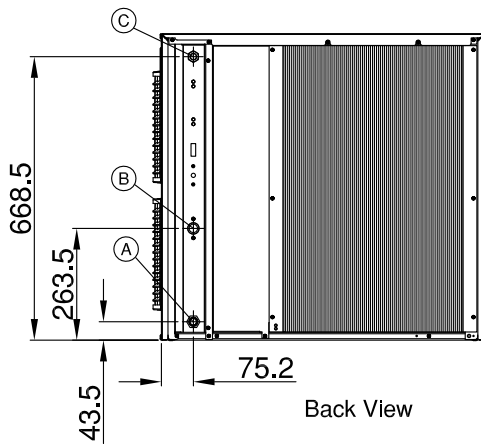

WATER COOLED

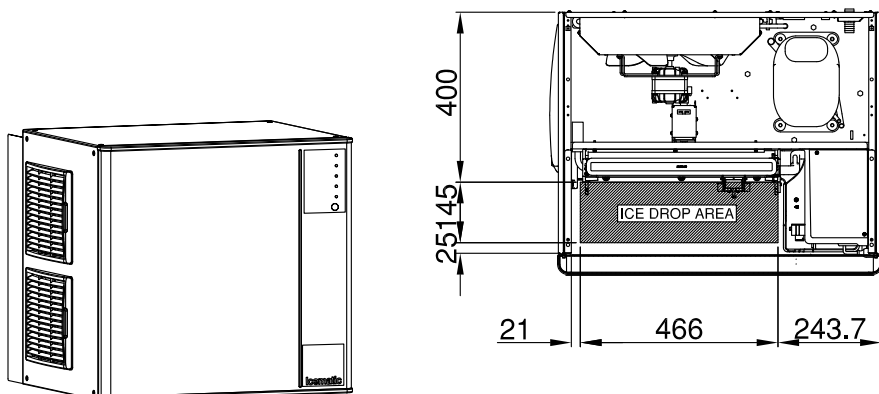
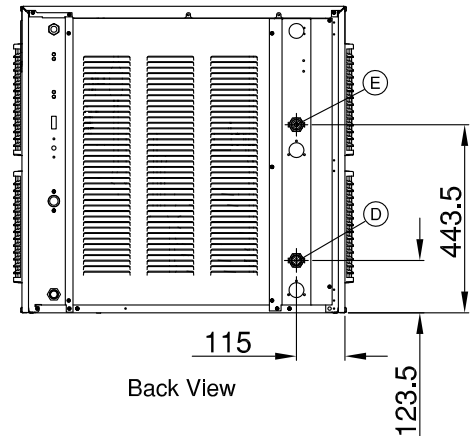

- A** Water drain 20mm diam.
- B** Potable water inlet 3/4" gas
- C** Electrical cable supply
- D** Water cooled inlet 3/4" gas
- E** Water cooled outlet 3/4" gas