

Operating instructions

Freezer with explosion-proof interior container

Read the operating instructions before switching on for the first time

Page 14

GB

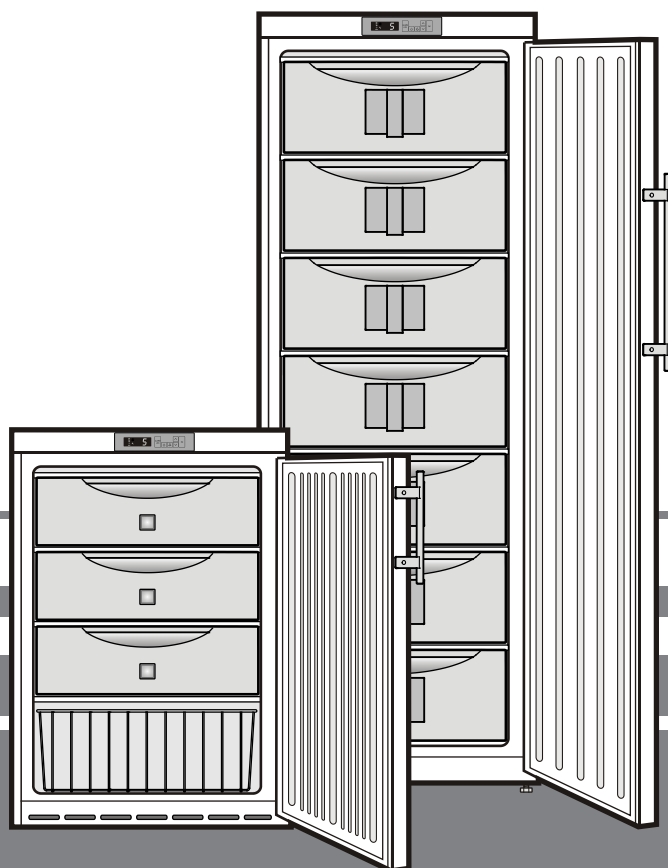

7083 241-00

LGex

LIEBHERR

Disposal notes

The appliance contains reusable materials and should be disposed of properly - not simply with unsorted household refuse. Appliances which are no longer needed must be disposed of in a professional and appropriate way, in accordance with the current local regulations and laws.



When disposing of the appliance, ensure that the refrigerant circuit is not damaged to prevent uncontrolled escape of the refrigerant it contains (data on type plate) and oil.

- Disable the appliance.
- Pull out the mains plug.
- Cut through the connection cable.

! WARNING

Danger of suffocation due to packing material and plastic film! Do not allow children to play with packaging material. Take the packaging material to an official collection point.

Description of the appliance

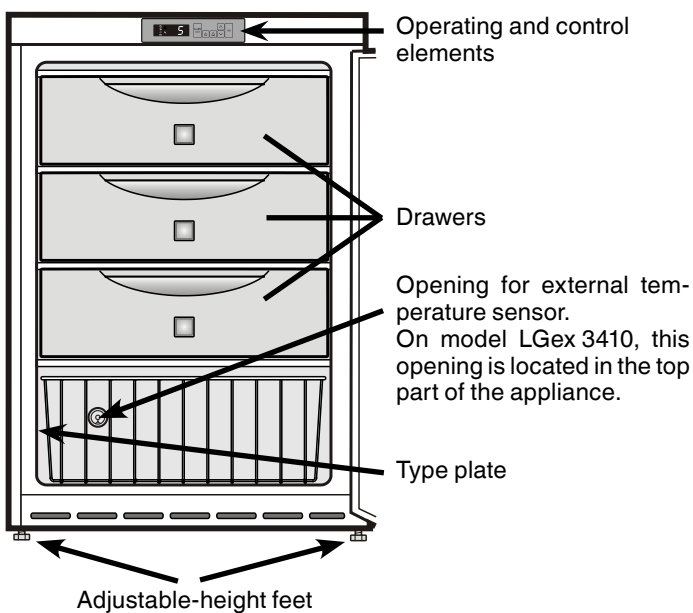

Other features

- Audible and visual temperature alarm (adjustable limits).
- Audible and visual door open alarm.
- Floating contact for connection to a remote monitoring system.
- Serial interface (RS485) for external temperature and alarm documentation.
- Maximum/minimum interior temperature are stored.
- Last 3 temperature alarms are saved with time, date and duration of alarm.
- Last 3 power cuts are saved with time, date and duration of power cut.
- Opening for installing a reference sensor.

It is essential to use these safety facilities to avoid damage to stored items. These facilities must not be deactivated or decommissioned!

Range of appliance use

The interior, which is free from sources of ignition, is used for storing flammable substances in closed containers and is therefore classified as a Zone 2 hazardous area.

The appliance is **not** suitable for use in explosion-hazard areas.

For the storage of valuable or temperature-sensitive substances or products the use of an independent, constantly monitoring alarm system is necessary.

This alarm system must be designed so that each alarm status is detected immediately by an authorised person who can then take appropriate action.

Position the temperature sensor for this system in the upper part of the interior container (see **Opening for external temperature sensor**).

<p>INNENRAUM EXPLOSIONSGESCHÜTZT! EXPLOSION-PROOF INTERIOR! CUVE INTÉRIEURE ANTIDÉFLAGRANTE !</p> <p>II 3G <i>Ex nA II T6</i> SEV 08 ATEX 0150 X</p> <p>Innentemperaturbereich: -9 bis -26°C Interior temperature range: -9 to -26°C Gamme de températures intérieures : -9 à -26 °C</p>	<p>Achtung! Kunststoffteile nur mit feuchtem Tuch reinigen! Gefahr elektrostatischer Aufladung!</p> <p>Warning! Only clean plastic parts with a damp cloth! Risk of electrostatic discharge.</p> <p>Attention ! Nettoyer les éléments plastique avec un chiffon humide uniquement ! Danger de décharge électrostatique.</p>	<p>LGUex 1500</p>

<p>INNENRAUM EXPLOSIONSGESCHÜTZT! EXPLOSION-PROOF INTERIOR! CUVE INTÉRIEURE ANTIDÉFLAGRANTE !</p> <p>II 3G <i>Ex nA II T6</i> SEV 08 ATEX 0151 X</p> <p>Innentemperaturbereich: -9 bis -30°C Interior temperature range: -9 to -30°C Gamme de températures intérieures : -9 à -30 °C</p>	<p>Achtung! Kunststoffteile nur mit feuchtem Tuch reinigen! Gefahr elektrostatischer Aufladung!</p> <p>Warning! Only clean plastic parts with a damp cloth! Risk of electrostatic discharge.</p> <p>Attention ! Nettoyer les éléments plastique avec un chiffon humide uniquement ! Danger de décharge électrostatique.</p>	<p>LGex 3410</p>

Climate rating

The climate rating indicates the room temperature at which the appliance may be operated in order to achieve full refrigeration performance.

The climate rating is indicated on the type plate.

The position of the type plate is shown in the section entitled **Description of the appliance**.

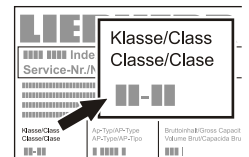

Climate rating	Room temperature
SN	+10°C to +32°C
N	+16°C to +32°C
ST	+16°C to +38°C
T	+16°C to +43°C
SN-ST	+10°C to +38°C
SN-T	+10°C to +43°C

Do not operate the appliance outside the specified room temperature range.

Safety instructions and warnings

- To prevent injury or damage to the unit, the appliance should be unpacked and set up by two people.
- In the event that the appliance is damaged on delivery, contact the supplier immediately before connecting to the mains.
- To guarantee safe operation, ensure that the appliance is set up and connected as described in these operating instructions.
- Disconnect the appliance from the mains if any fault occurs. Pull out the plug, switch off or remove the fuse.
- When disconnecting the appliance, pull on the plug, not on the cable.
- Any repairs and work on the appliance should only be carried out by the customer service department, as unauthorised work could prove highly dangerous for the user. The same applies to changing the mains power cable.
- Do not allow naked flames or ignition sources to enter the appliance. When transporting and cleaning the appliance, ensure that the refrigerant circuit is not damaged. In the event of damage, make sure that there are no ignition sources nearby and keep the room well ventilated.
- Do not stand on the plinth, drawers or doors or use them to support anything else.
- This appliance is not intended for use by persons (including children) with reduced physical, sensory or mental capabilities or lack of experience and knowledge unless they have been given initial supervision or instruction concerning use of the appliance by a person responsible for their safety. Children should be supervised to ensure that they do not play with the appliance.
- Avoid prolonged skin contact with cold surfaces or chilled/frozen food. This could cause pain, numbness and frostbite. In the case of prolonged skin contact, protective measures should be taken, e.g. gloves should be worn.
- Do not consume food which has been stored for too long, as it could cause food poisoning.
- Do not use electrical appliances inside the appliance.
- If you have a lockable appliance, do not keep the key near the appliance or within reach of children.

- The appliance is designed for use in enclosed areas. Do not operate the appliance outdoors or in areas where it is exposed to splash water or damp conditions.
- Do not install the appliance in the immediate vicinity of an air-conditioning unit. The appliance should also not be operated under a wall-mounted air-conditioning unit.
- The appliance is **not** suitable for storing drugs pursuant to DIN 58345.
- The appliance is **not** suitable for storing blood bottles pursuant to DIN 58371.
- The appliance is **not** suitable for storing blood plasma pursuant to DIN 58375.
- In special fields of application which are subject to their own standard, the user is responsible for complying with this standard.

Setting up

- Avoid positioning the appliance in direct sunlight or near cookers, radiators and similar sources of heat.
- The floor on which the appliance stands should be horizontal and level. Compensate for uneven floors with the adjustable feet.
- Do not cover ventilation openings or grille. 
- Standard EN 378 specifies that the room in which you install your appliance must have a volume of 1 m³ per 8 g of R 600a refrigerant used in the appliance, so as to avoid the formation of inflammable gas/air mixtures in the room where the appliance is located in the event of a leak in the refrigerant circuit. The quantity of refrigerant used in your appliance is indicated on the type plate on the inside of the appliance.

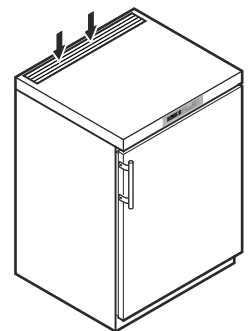

Dimensions

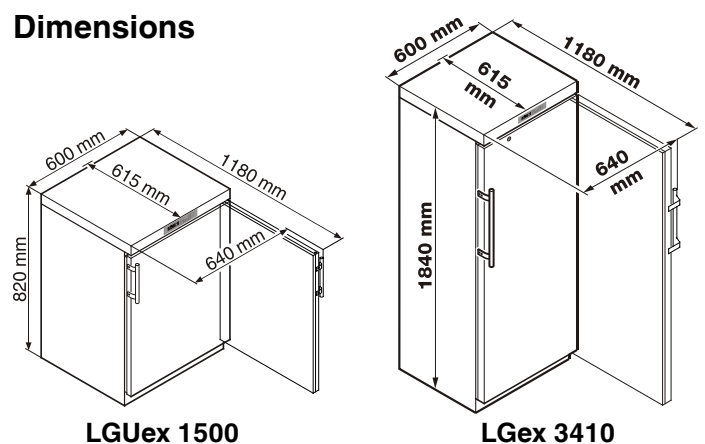

LGUex 1500

LGex 3410

Electrical connection

Only operate the appliance with **alternating current (AC)**.

The permissible voltage and frequency are indicated on the type plate. The position of the type plate is shown in the section entitled **Description of the appliance**.

The socket must be properly earthed and protected by a fuse. The tripping current of the fuse must be between 10 A and 16 A.

The socket must not be situated behind the appliance and must be easily accessible.

Do not connect the appliance using an extension cable or extension socket.

Do not use stand-alone inverters (conversion of direct current to alternating/three-phase current) or energy-saving plugs. Risk of damage to the electronic control system!

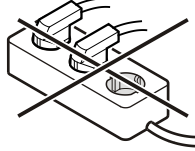

Operating and control elements

- ① **ON/OFF** button (to switch the appliance on and off)
- ② Selection buttons
- ③ **Set** button (Enter)
- ④ **Audible warning** on/off button
- ⑤ Button for calling up stored alarm events
- ⑥ Temperature display

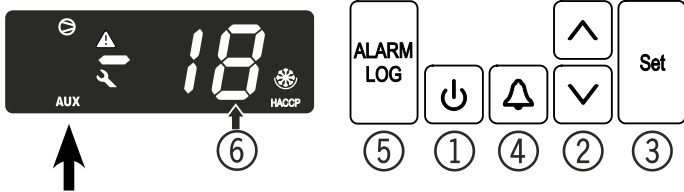

Control elements

- Compressor is running
- LED flashing - refrigeration unit switches on after a delay. The compressor will start automatically after the pressure in the refrigerant circuit has equalised.)

AUX Temperature display via product sensor is activated

- Alarm function
- If appears in the display, the appliance has a fault. Consult your nearest customer service point.

HACCP (Hazard Analysis Critical Control Point)

The HACCP display means that the power supply and interior temperature of the appliance are recorded. If HACCP flashes in the display, there has either been a power failure or the temperature in the appliance exceeded the permissible range.

Switching the appliance on and off

Connect the appliance to the mains - the display reads **OFF**.

Switching the appliance on: Keep the **ON/OFF** button pressed for approx. 5 seconds - the display reads **ON**.

No alarm is displayed or sounded when the appliance is switched on for the first time.

If the appliance is disconnected from the mains for a long time after it has been switched on for the first time and if the temperature inside the appliance rises above the upper alarm limit, this will be detected as a fault by the electronic control system (**HACCP** appears in the display).

When the appliance is switched on again, this display must be reset as shown below.

Press button .

Press + for 5 seconds. The display will read **rES**.

The **HACCP** LED will now light up permanently.

Press for 5 seconds.

The electronic control system will automatically switch back to normal operating mode.

Switching the appliance off: Keep the **ON/OFF** button pressed for approx. 5 seconds - the display reads **OFF**.

Setting the temperature

- Press button for 1 second. The temperature display flashes.
- To increase the temperature (warmer): press button .
- To reduce the temperature (colder): press button .
- Press button again.

The desired temperature setting is saved.

Adjustable temperature range

LGUex 1500 from -9°C to -26°C

LGex 3410 from -9°C to -30°C

Audible warning signal

The audible warning signal will sound in certain alarm events. It can be cancelled by pressing button .

Door open alarm

When the door is opened, the LED and the temperature display begin to flash.

When the door has been left open for more than 60 seconds, the LED begins to flash, and **door** and the temperature indication flash alternately in the display.

The audible warning signal sounds (unless the audible warning signal function has been deactivated).

If the door has to stay open for longer in order to insert items to be cooled, cancel the audible warning signal by pressing button .

Setting the delay time for the door open alarm

The time before the audible warning signal sounds after the door has been opened can be adjusted.

Press for 5 seconds. Display = *r61*

Display = *rA3*

Display = *rC1*

Display = *rC3*

Display = *d8d*

Display = *!* (minute)

Setting range = 1 - 5 minutes

Use buttons and to select the desired setting.

Display = *d8d*

Press for 5 seconds.

The electronic control system will automatically switch back to normal operating mode.

Deactivating the audible warning signal function

The audible warning signal function can be completely deactivated if necessary.

Note

In this case, the sentence stated in these operating instructions "The audible warning signal sounds" must be skipped when reading the section in question.

Press for 5 seconds. Display = *r61*

Display = *tC*

Display = *H4*

Display = *0*

Use buttons and to select the desired setting.

0 = audible warning signal function activated

! = audible warning signal function deactivated

Display = *H4*

Press for 5 seconds.

The electronic control system will automatically switch back to normal operating mode.

Audible warning signal settings

The audible warning signal will be muted for the current alarm after the button has been pressed. Complete the following steps if you want the audible warning signal to reactivate automatically.

Press for 5 seconds. Display = *r61*

Display = *tC*

Display = *H4*

Display = *H0*

Display = *ASd*

Display = *ASn*

Display = *0*

Display = *!*

Display = *ASn*

Automatic reactivation of the audible warning signal is now active.

The time before the audible warning signal sounds again must be set.

Display = *ASd*

Display = *!* Time in minutes after which the audible warning signal will sound again after the button has been pressed. Setting range = 1 - 120 minutes.

Use buttons and to select the desired setting.

Display = *ASd*

Press for 5 seconds.

The electronic control system will automatically switch back to normal operating mode.

Alarm messages

1. LED flashes

If  appears in the display, the appliance has a fault. Consult your nearest customer service point.

2. LED flashes, the display reads *HI* or *LO*

The interior is too warm (HI) or too cold (LO).

The audible warning signal sounds (unless the audible warning signal function has been deactivated).

Note

The alarm parameters can be adjusted. See **Adjusting the alarm parameters**.

3. HACCP flashes

There has been a power cut of some length or the interior was too warm or too cold during a certain period of time.

Up to three alarm events can be stored and called up.

Alarm test

This test checks the function of the internal and any external connected alarm device.

The appliance does not stop its refrigerating function during this test.

Activating the test

Press  +  for 5 seconds.

- The display will change to a temperature value of 0.2°C below the set upper alarm limit.
- The temperature value will now rise by 0.1°C every 2 seconds.
- When the upper alarm limit is reached, *HI* will appear in the display. An external alarm unit connected to the floating alarm output will now be activated.
- The temperature value will continue to rise up to 0.2°C above the upper alarm limit.
- The same process will take place automatically for the lower alarm limit. *LI* will appear in the display.

The LED  will be lit during the test.

The electronic control system will automatically switch back to normal operating mode.

Cancelling the test prematurely

Press  for 5 seconds.

Note

If the values of the upper and lower alarm limit (**AL** and **AH** in the section entitled "Adjusting the alarm parameters") are set to **0**, *H-* - and *L-* - will appear in the display during this test.

Adjusting the alarm parameters

The alarm limits (difference to the set temperature) and the alarm delay (delay until alarm goes on) can be adjusted.

Press  for 5 seconds. Display = *rE1*

 Display = *rA3*



 Display = *rC1*

 Display = *rC3*

 Display = *d8d*

 Display = *AL* Lower alarm limit



 Display = temperature difference in °C

Use buttons  and  to select the desired setting.

 Display = *AL*

 Display = *AH* Upper alarm limit



 Display = temperature difference in °C

Use buttons  and  to select the desired setting.

 Display = *AH*

 Display = *Ad*

 Display = alarm delay in minutes

Use buttons  and  to select the desired setting.

 Display = *Ad*

Press  for 5 seconds.

The electronic control system will automatically switch back to normal operating mode.

Calling up stored alarm events and reading the temperature progression

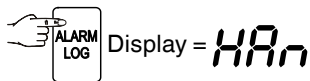

Scroll through the list using or .

- HAn** Number of temperature alarms
- HA** Last temperature alarm
- HA 1** Last temperature alarm but one
- HA 2** Temperature alarm before **HA 1**
- HF_n** Number of power cuts
- HF** Last power cut
- HF 1** Last power cut but one
- HF 2** Power cut before **HF 1**
- r_t** Period in hours in which the maximum and minimum interior temperatures were measured
- r_H** Maximum (highest) measured temperature
- r_L** Lowest measured temperature

Select the required item using the button. Press this button again to return to the list.

Note: You can exit the menu at any time by pressing for 5 seconds.

If no button is pressed within 60 seconds, the electronic control system switches back automatically.

Resetting the recorded temperature progression **r_t**

Complete the following steps if you wish to reset the value saved for **r_t** in the previous section to 0.

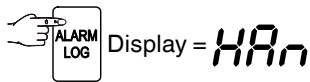

Press the button or until **r_t** appears in the display.

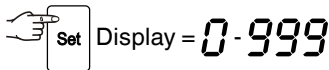

Press for 5 seconds. Display = **r_{ES}**.

The values for **r_H** and **r_L** (highest and lowest measured interior temperature) are then reset to the current interior temperature.

Press for 5 seconds.

The electronic control system will automatically switch back to normal operating mode.

Example of an alarm query

Situation: HACCP flashes in the display.

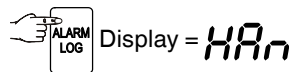

Display = **0** There has not been an alarm status with a too high or too low temperature. You must switch to display **HF_n**.

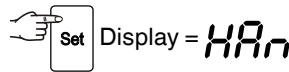

Press this button until **HF_n** appears in the display.

Display = **1 1** 1 power failure has occurred.



Display = **HF** Last power failure.

Display = **4 12** Year 2012

Display = **05** Month 05 (May)

Display = **30** Day 30

Display = **23** Hour 23

Display = **14** Minute 14

Display = **3** The power failure lasted 3 hours.

Press + for 5 seconds. The display will read **r_{ES}**.

The **HACCP** LED will now light up permanently.

The electronic control system is now ready for the next alarm.

Press for 5 seconds.

The electronic control system will automatically switch back to normal operating mode.

Calibrating the control sensor (standard sensor for temperature control)

Possible tolerances of the control sensor (the displayed temperature compared to the actual interior temperature) can be offset with this function.

Press for 5 seconds. Display = *r61*

Display = *rA3*

Display = *rC1*

Display = correction value set at the factory

Use buttons or to increase or decrease the correction value in 0.1°C increments.

Display = actual (corrected) interior temperature

Display = *rC1*

Press for 5 seconds.

The electronic control system will automatically switch back to normal operating mode.

Product sensor (available accessory)

The temperature may be measured or recorded at any point in the interior using the product sensor.

- Connect sensor (see section entitled **External alarm**)

Activating the sensor

Press for 5 seconds. Display = *r61*

Display = *rA3*

Display = 0

Display = 1

Display = *rA3*

Press for 5 seconds.

The electronic control system will automatically switch back to normal operating mode.

If **---** appears in the display, the product sensor has not been activated.

If **E2** appears in the display, the product sensor has not been connected, or is faulty.

Calibrating the product sensor

Possible tolerances of the product sensor (the set temperature compared to the actual interior temperature) can be offset with this function.

Press for 5 seconds. Display = *r61*

Display = *rA3*

Display = *rC1*

Display = *rC3*

Display = 0.0

Use buttons or to increase or decrease the correction value in 0.1°C increments.

Display = actual (corrected) product sensor temperature

Press for 5 seconds.

The electronic control system will automatically switch back to normal operating mode.

Switching the temperature display between control sensor and product sensor

Press for 5 seconds. Display = *r61*

Display = 1 (control sensor)

Display = 2 (product sensor)

If the product sensor is activated, AUX appears in the display.



Display = *r61*

Press for 5 seconds.

The electronic control system will automatically switch back to normal operating mode.

Changing the network address

When connecting several appliances via the RS485 interface, each appliance must have its own network address.



Press  for 5 seconds. Display = **rt1**

 Display = **tc**

 Display = **H4**

 Display = **H0**

 Display = **!**

Use buttons  or  to change the network address (**1-207**).

 Display = **H0**

Press  for 5 seconds.

The electronic control system will automatically switch back to normal operating mode.

Resetting the parameters to factory settings

The **alarm limits** and **sensor calibration values** can be reset to the factory settings using this function.

Pull out the mains plug.

Keep  pressed and connect the mains plug.

Display = **bn1**

 Display = **Std**

The electronic control system will automatically switch back to normal operating mode.



Setting the real time clock

The real time clock is preset (CET). Other time zones or summer/winter time must be adjusted manually.

Press  for 5 seconds. Display = **rt1**



 Display = **tc**

 Display = **Y12** Year 2012

 Display = **10** Set the year by pressing the   buttons.



 = save new setting

 Display = **07** Month (1-12)

 Display = **7** Set the month by pressing the   buttons.



 = save new setting

 Display = **01** Day (1-31)

 Display = **!** Set the day by pressing the   buttons.



 = save new setting

 Display = **03** Days of the week (1 = Monday, 7 = Sunday)

 Display = **3** Set the day of the week by pressing the   buttons.



 = save new setting

 Display = **12** Hour (0-23)

 Display = **12** Set the hour by pressing the   buttons.

 = save new setting

 Display = **48** Minute (0-59)

 Display = **48** Set the minutes by pressing the   buttons.

 = save new setting

Press  for 5 seconds.

The electronic control system will automatically switch back to normal operating mode.

Note

When **etc** appears in the display, the real time clock must be reset.

Safety lock

The lock in the appliance door is equipped with a safety mechanism.

Locking the appliance:

- Insert the key as shown by arrow 1.
- Turn the key 90°.

To unlock the appliance, the same procedure must be repeated in the same order.

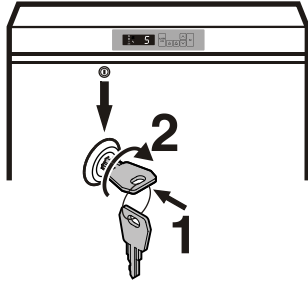

Defrosting

After a longer period of operation a layer of frost or ice can build up on the cooling plates in the freezer compartment. This will increase the energy consumption of the freezer. The cooling plates should therefore be defrosted regularly.

- To defrost, switch the appliance off. Pull out the mains plug.
- Remove the drawers.
- Transfer items to other appliances.
- To speed up the defrosting process put a saucepan of hot but not boiling water on one of the cooling plates.
- Leave the door of the appliance open while defrosting. After defrosting mop up the remaining water with a cloth and clean the appliance.

Do not use any mechanical devices or other artificial aids for defrosting other than those recommended by the manufacturer.

Cleaning

Before cleaning always switch off the appliance. Pull out the mains plug or switch off or unscrew the fuse.

- Clean the inside, equipment and outer walls with lukewarm water and a little detergent. Do not use abrasive or acid cleaners or chemical solvents.

Do not use steam cleaners because of the risk of injury and damage.

- Ensure that no cleaning water penetrates into the electrical components or ventilation grille.
- The dust should be removed from the refrigeration unit and heat exchanger - metal grid at the back of the appliance - once a year.
- Do not damage or remove the type plate on the inside of the appliance. It is very important for servicing purposes.

Warning!

**Only clean plastic parts with a damp cloth!
Risk of electrostatic discharge.**

Malfunctions

You may be able to rectify the following faults by checking the possible causes yourself:

• Appliance does not function:

- Is the appliance switched on?
- Is the plug correctly fitted in the mains socket?
- Is the fuse intact?

• Loud running noise:

- Is the appliance set up firmly on the floor?
- Does the appliance cause nearby items of furniture or objects to vibrate? Please note that noises caused by the refrigerant circuit cannot be avoided.

• The temperature is not low enough:

- Is the temperature setting correct (see "Setting the temperature")?
- Does the separately installed thermometer show the correct reading?
- Is the ventilation system working properly?
- Is the appliance set up too close to a heat source?

• *Etc* appears in the display:

- Reset the real time clock (see "Setting the real time clock").

If none of the above causes apply and you cannot rectify the fault yourself, contact the nearest customer service department stating the type designation ①, service number ② and appliance number ③ as indicated on the type plate.

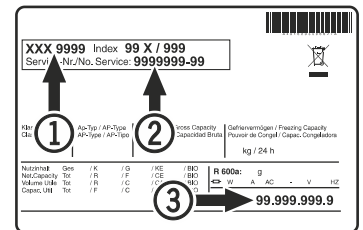

The position of the type plate is shown in the section entitled **Description of the appliance.**

Shutting your appliance down

If your appliance is to be shut down for any length of time, switch it off and disconnect the plug or switch off or unscrew the fuse. Clean the appliance and leave the door open in order to prevent unpleasant smells.

External alarm

We recommend connecting the appliance to an external alarm device.

There are various connection options at the back of the appliance.

The appliance may only be connected to an external alarm device by trained personnel.

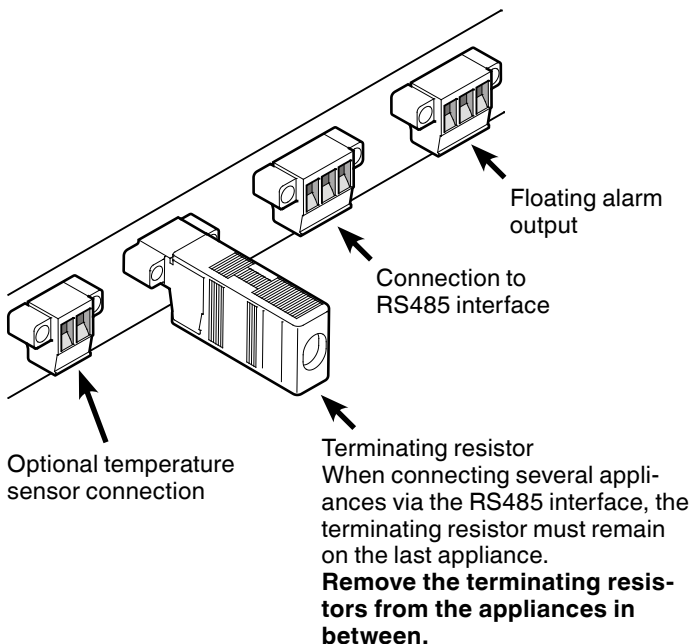
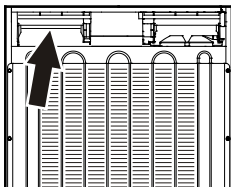

Note
The connectors are secured with screws. To remove the connectors, undo the left and right screws.

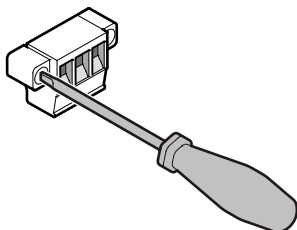

Floating alarm output

These three contacts can be used to connect the appliance to an optical or acoustic alarm device.

The connection is designed for a maximum of **42 V/8 A DC** from a safety extra-low voltage (SELV) source (**minimum current: 150 mA**).

Important
When supplying mains voltage to the floating alarm contact, the technical safety requirements of standard EN 60335 will not be satisfied.

N.O Alarm output
Connection for a visual warning light or an acoustic alarm signal.

N.C Operating light
Connection for a control lamp to indicate that the appliance is in normal mode.

COM External power supply unit
42 V/8 A DC maximum.
Minimum current: 150 mA.

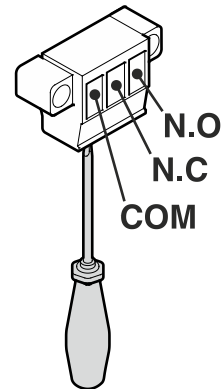

RS485 interface

Rx- / Tx-
Send/Receive data cable (negative pole)

Rx+ / Tx+
Send/Receive data cable (positive pole)

GND
Earth cable

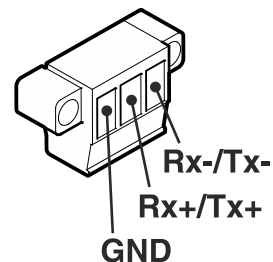

Opening for external temperature sensor Model LGUex 1500

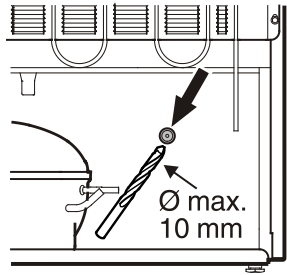

1. Drill marked section on the back of the appliance.

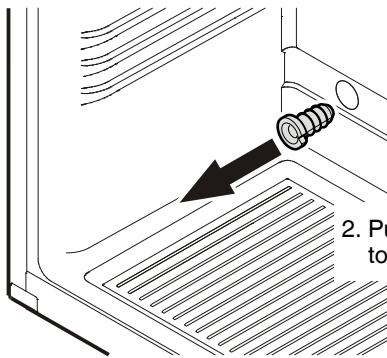

2. Pull out strain relief device (bottom left of interior container).

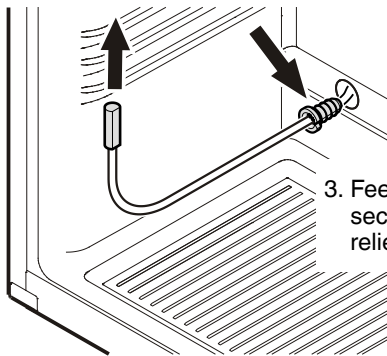

3. Feed sensor through opening and secure sensor cable with strain relief device.

Important!

Position the sensor at the top of the interior container. The sensor must not come into contact with objects so that only the air temperature is measured.

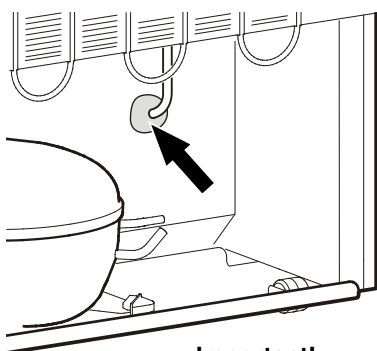

4. Close the sensor cable opening at the back of the appliance with the sealant provided.

Opening for external temperature sensor Model LGex 3410

Remove upper drawer before beginning work.

The condenser must be unscrewed to make the sensor cable opening accessible.

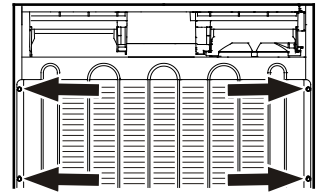

1. Unscrew condenser screws (6 pcs.) and fold out condenser at an angle.

Important!

Make sure that no pipes are bent.

2. Drill marked section at the back of appliance.

Important!

Only drill the outer wall of the housing.
Do not drill too far.

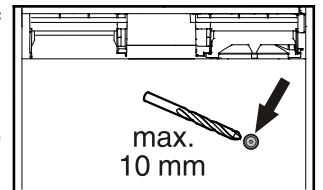

3. Pull out strain relief device (top left of interior container).

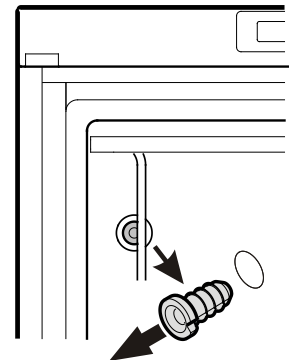

4. Feed sensor through opening and secure sensor cable with strain relief device.

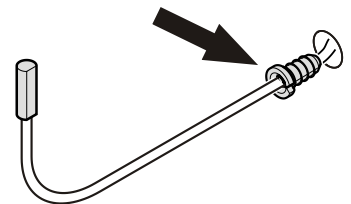

Important!

Position the sensor at the top of the interior container. The sensor must not come into contact with objects so that only the air temperature is measured.

Important!

5. Close the sensor cable opening at the back of the appliance with the sealant provided.

6. Screw condenser back on.

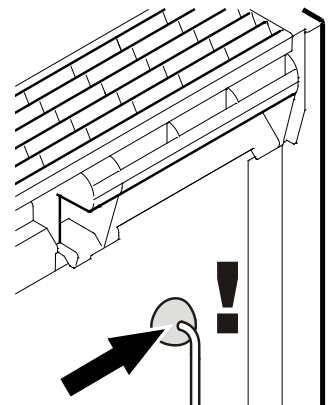

Changing over door hinges

1. Unscrew the hinge bracket.

Important: The door mounting has a spring mechanism enabling the door to close by itself. The hinge bracket turns to the left when the screws are undone.

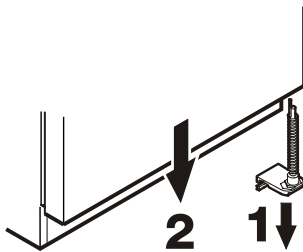

2. Pull the door out at the bottom and lift off.

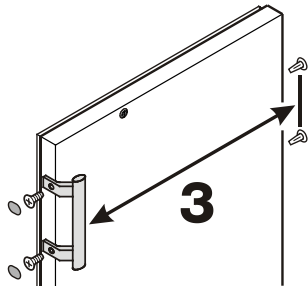

3. Transfer handle and plugs to the opposite side of the door.

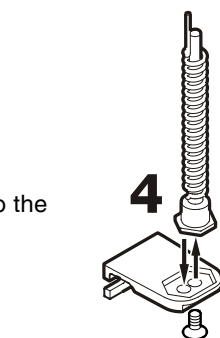

4. Transfer pin on hinge bracket to the opposite side.

5. Transfer upper hinge components to the opposite side.

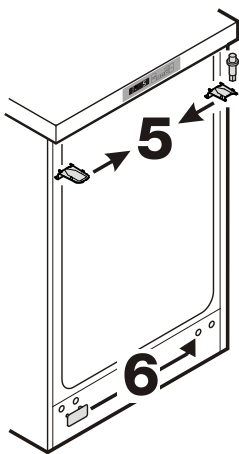

6. Transfer cover plate to the opposite side.

7. Mount door on hinge pin and close.

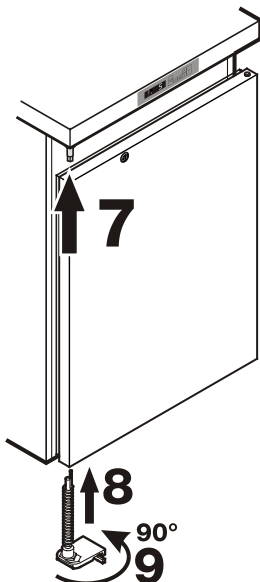

8. Insert hinge bracket in lower door mounting.

9. Turn hinge bracket by 90° - spring is compressed. Screw on hinge bracket.



Installation dimensions (mm) LGUex 1500

Version 1

A cross-section of min. 200 cm² is required in the worktop for ventilation of the rear of the appliance.

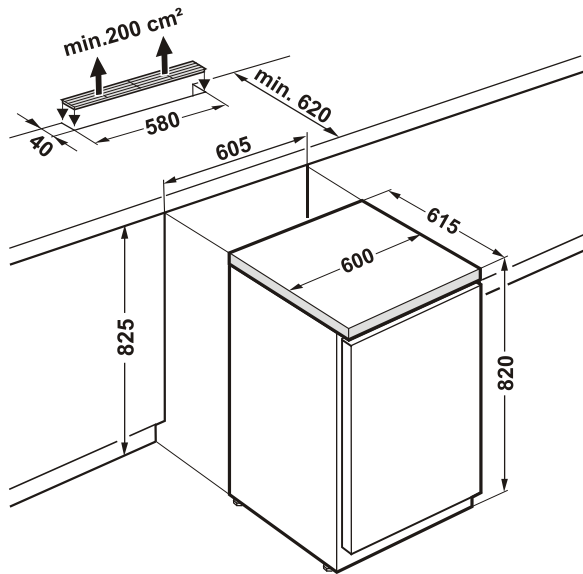

Version 2

If no ventilation grill is provided in the worktop, the recess must be at least 860 mm high to ensure adequate heat dissipation to the front.

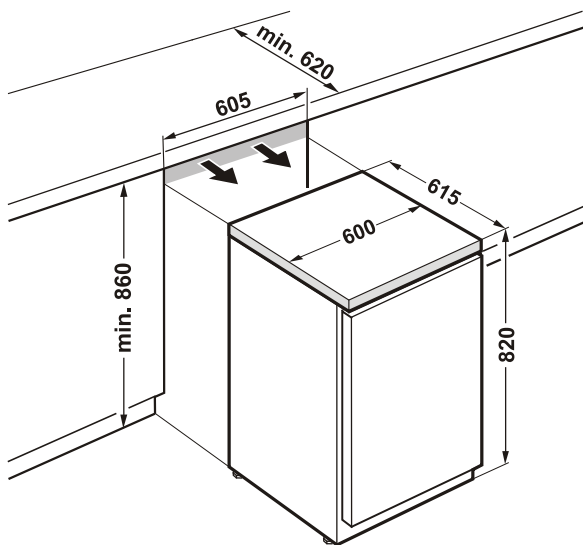

The appliance complies with the relevant safety regulations and EC Directives 2004/108/EC, 2006/95/EC and ATEX 94/9/EC (EN/IEC 60079-15, IEC 60079-0, EN 1127-1).