

ICS PACIFIC Pharma 1000
Medical

ICS PACIFIC Pharma 3000
Medical



USER MANUAL



Pharma 1000 GD



Pharma 3000 GD



Pharma 3000 SD

Installation.....	3
Stocking with vaccines.....	6
QCPP accreditation / Temperature Data Logging.....	6
Connection to electricity.....	7
Operating instructions.....	8
Reading and resetting High/Low Temperatures.....	9
Alarm function.....	10
Fitting an external alarm.....	10
Maintenance.....	11
Cleaning.....	11
Spare parts.....	11
Servicing.....	11
Disposal.....	11



www.icspacific.com.au

info@icspacific.com.au

Phone 1800 630 360

Installation



The cabinet must only be used indoors and be placed in an area that is dry and well ventilated. It must not be positioned in direct or indirect sunlight, near warm appliances or locations with drafts.

The cabinet is designed to perform in an ambient temperature of between +10°C (minimum) and +32°C (maximum) and a maximum ambient humidity of 60%.

By placing the cabinet in an environment above 60% ambient humidity it may be necessary to wipe the glass door of condensation.

The cabinet can be installed freestanding, against a wall or built in. If built in refer to instructions below.



Important!

The cabinet must have a minimum 30 mm uninterrupted ventilation and free air circulation underneath and on top of the cabinet.

The drawings on Page 4 show how much air space is needed.

Fig 1. Shows the cabinet freestanding or against a wall.

Fig 2. Shows the cabinet built in.

The dimensions must be maintained to ensure adequate air circulation.



If the cabinet is installed inside a construction and the ventilation dimensions cannot be strictly observed good air circulation must be provided by making a large hot-air escape channel in the construction - with particular attention given to the top ventilation of the cabinet.

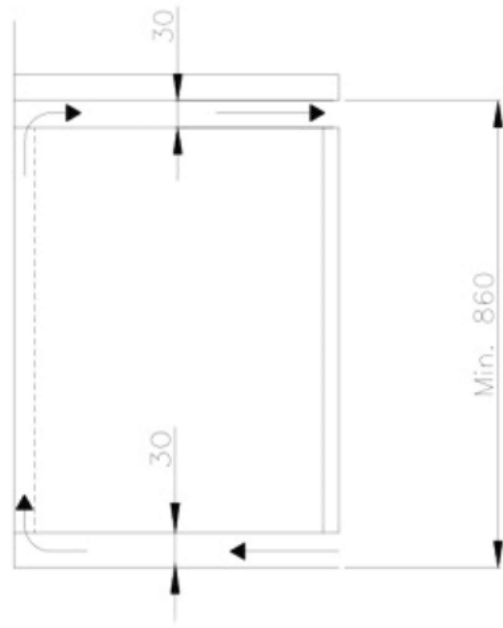
IMPORTANT !!

In order to ensure good ventilation and not to void the Warranty contact **ICS PACIFIC** if further information is required.

Fig 1: Freestanding or against a wall

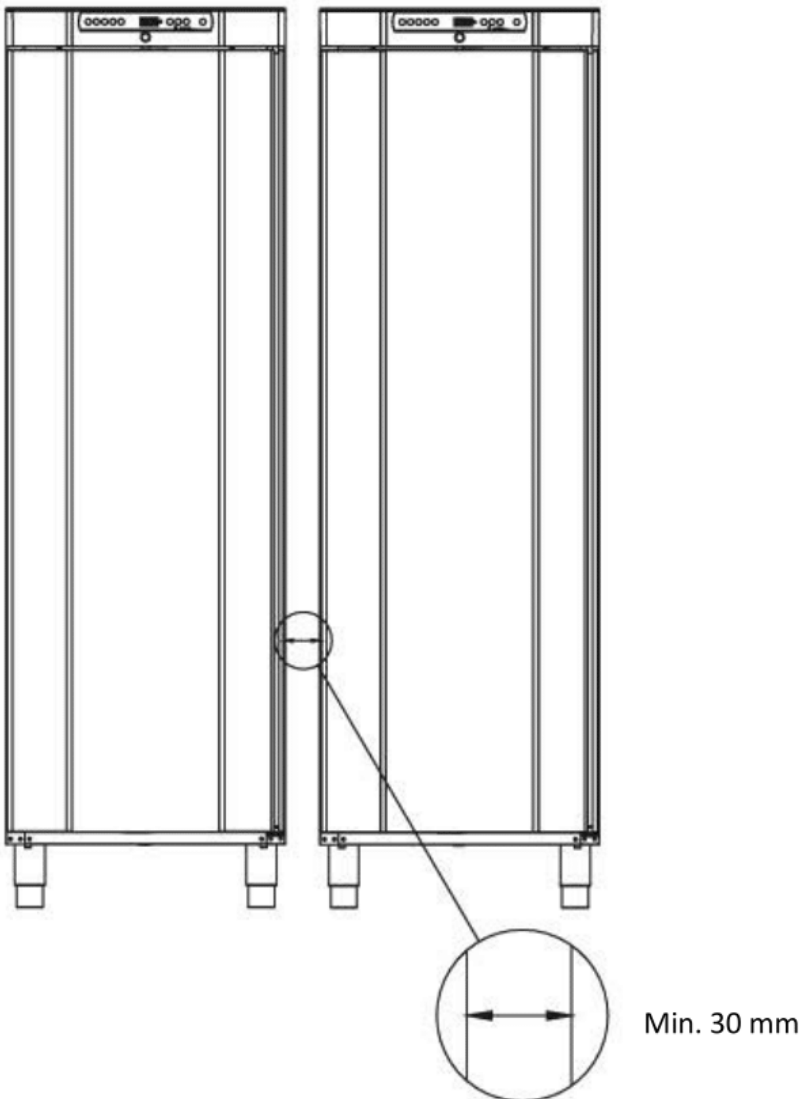


Fig 2: Built in



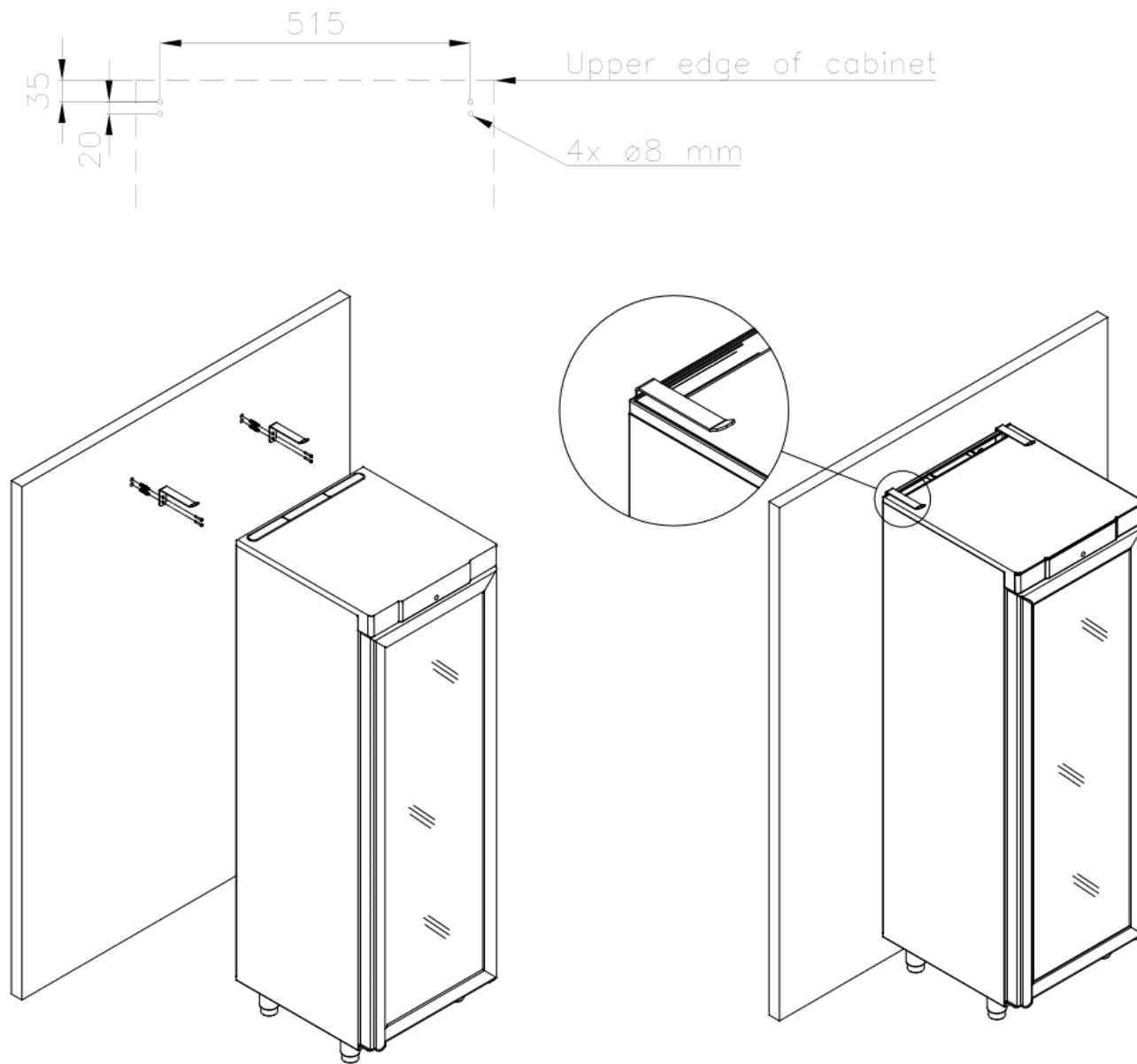
Side by Side:

If cabinets are placed side by side, the minimum distance between the cabinets of 30 mm shown below is required due to the risk of condensation between the cabinets.



Anti-topple brackets must be installed to avoid any possibility of the cabinet toppling over when the door is opened.

The brackets which are delivered with the cabinet must be fastened to the wall behind the cabinet as shown in the drawings.



Stocking with Vaccines

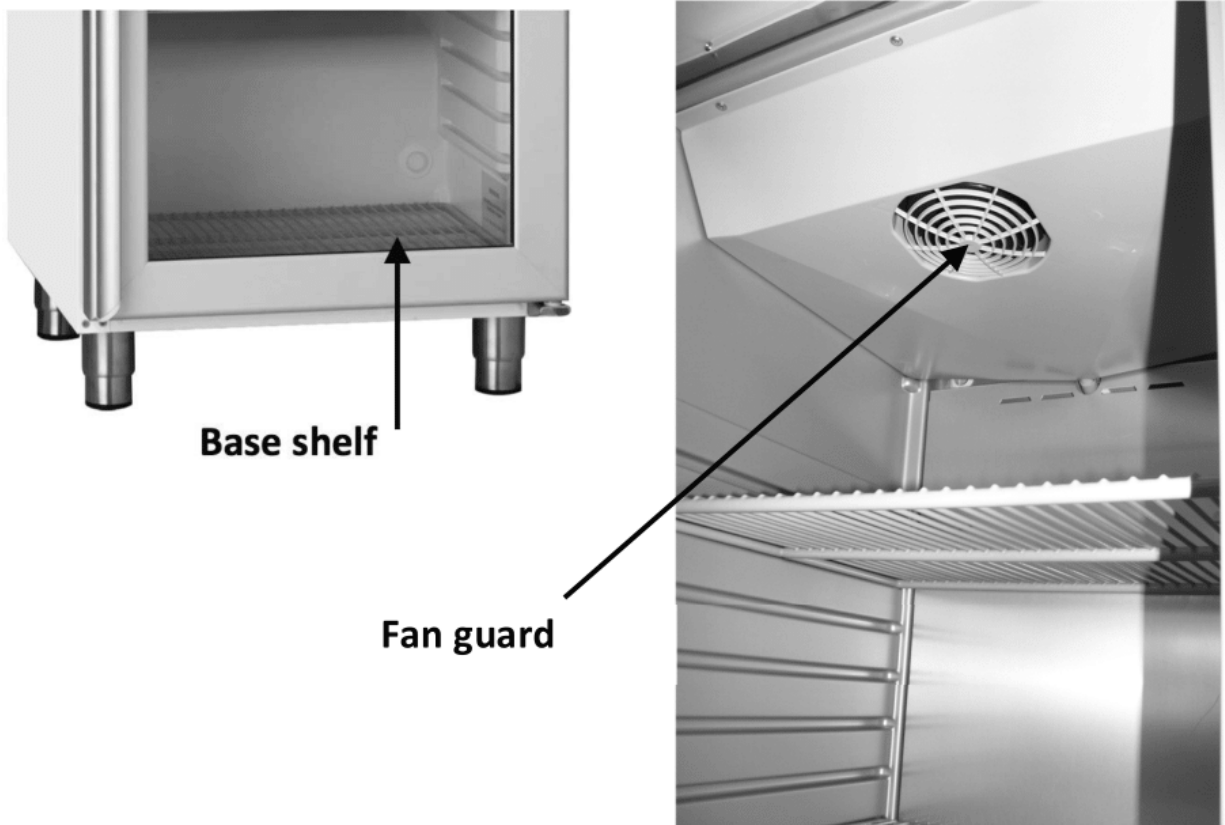
The base shelf (shown below) must be placed on the bottom of the cabinet to ensure good ventilation.

Stocking the cabinet:

When using containers such as boxes or trays on the shelves ensure there is adequate ventilation in the bottom of the containers and around the containers so that the air flow is not restricted.

The fan guard (shown below) must not be covered or restricted.

If in doubt, contact the vaccine supplier.



QCPP Accreditation / Temperature Data Logging

When performing Data Logging of the temperature ensure the data logger is placed in the cabinet as per instructions provided by the data logger manufacturer.

Using a data logger with a sensor probe (at the end of a cable).

The cabinet is fitted with an Access Port for the probe to be inserted. It is located at the bottom rear of the cabinet. Before inserting the probe gently push the plug from outside the cabinet inwards. The sensor probe can now be inserted into the cabinet.

The access port must always be sealed with the access port plug or other material (eg BluTack) to ensure no outside air can enter the cabinet.



Connection to Electricity

The cabinet is designed for connection to 230-240/50/1 alternating current. Power connection must be a 3-pin plug inserted into a 10 Amp power point.

The plug and power point must have the correct earth connection.

If in any doubt contact the cabinet supplier or authorized electrician.



Warning - the cabinet must be earthed.

The flexible cord fitted to this cabinet has three cores for use with a 3-pin 10 Amp plug.

Important

The wires in this mains lead are coloured in accordance with the following code:

Green-and-yellow: earth

Blue: neutral






Brown: live

Operating instructions

The cabinet is pre-set to operate within a temperature range of +2°C to +8°C in accordance with Quality Care Pharmacy Program (QCPP) Cold Chain Standards.



The LED Illuminations:

LED	MODE	FUNCTION
	On	Compressor on
	Flashing	Compressor start delay
	On	In Defrost
	Flashing	Defrost finishing
HI/LO	On	Current Highest / Lowest temperature displaying
	On	Menu password locked
°C	On	Temperature inside the fridge

The Buttons:

HI/LO

- Read Highest / Lowest temperatures and Reset.



- Turn internal light on / off.



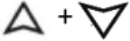
- Display temperature set point / Mute alarm.



- Increase parameter values - Disabled. Authorised personel use only.



- Decrease parameter values - Disabled. Authorised personel use only.



- Restore parameters to factory defaults - Disabled. Authorised personel use only.



- Manual Defrost – Disabled. Authorised personel use only.

How to read Highest / Lowest temperatures and to Reset

1. To read the highest inside temperature the cabinet has reached **press the HI/LO Button once**. The highest temperature will flash on the display and the LED display dot will be illuminated.

2. To read the lowest inside temperature the cabinet has reached **press the HI/LO Button again once straight after reading the highest temperature**.

The lowest temperature will flash on the display and the LED display dot will be illuminated.

3. To Reset the highest / lowest temperature readings **press the HI/LO Button again once for a few seconds until a long “beep” sounds** and “CL” (=memory cleared) is illuminated.

The highest and lowest temperature readings are now reset and the current cabinet temperature is displayed. The LED display dot will be off.

Every time the highest and lowest temperatures are viewed it is critical to ensure that 1., 2. and 3. above have all been carried out.

For any enquiries please contact the **ICS PACIFIC** Service Department - info@icspacific.com.au or **1800 630 360**.

Alarm function

If the temperature inside the cabinet goes below +2°C or rises above +8°C for longer than 30 minutes the alarm will activate and the display flash.

The alarm may be activated if:

There is no electrical power to the cabinet e.g. a power failure to the building, the power point is not switched on, the plug has been removed from the power point

The self-closing door has been left open for too long during removal / restocking of vaccines

The self-closing door has been prevented from closing e.g. something placed between the cabinet and the partially open door

Also refer to "Installation" on Page 3 and "Stocking with Vaccines" on Page 6

To mute the alarm press the  button.

The display will continue to flash until the cabinet returns to its normal operating temperature range of between +2°C to +8°C.



If the alarm is still activated after checking all the above and after allowing the inside cabinet temperature to stabilise for 30 minutes contact the **ICS PACIFIC** Service Department - info@icspacific.com.au or **1800 630 360**.

Please note:

Please understand that if a technician is sent by ICS PACIFIC and no Warranty fault / manufacturing defect is found there will be a service charge.

Fitting an external alarm – By authorised personnel only.

The connection cable is located externally on the top rear of the cabinet labelled "External Alarm".

The connection is voltage free and N/O (normally open).

In the event that the alarm is activated the contact is N/C (normally closed).

Maintenance



Before maintenance switch off the cabinet at the mains and remove the 3-pin plug from the wall.

The cabinet should be maintained regularly.

Ensure the grill on the back of the cabinet is kept clean of dust and dirt. Use ONLY a soft brush or vacuum cleaner to gently remove any dust or dirt build up that may occur. DO NOT USE WATER. Wipe the body of the cabinet with a damp cloth using a mild soap solution. Do not use anything abrasive or corrosive.

Cleaning



Before cleaning - switch off the cabinet at the mains and remove the 3-pin plug from the wall.

It is recommended that for hygiene purposes the cabinet be cleaned regularly.

Wipe the cabinet with a damp cloth using a mild soap solution. Do not use anything abrasive or corrosive.

Wipe the rubber door gasket to ensure any sticky substances etc. are removed that could otherwise damage the gasket or make the door difficult to open.

Spare parts

Should spare parts be required please contact the **ICS PACIFIC** Service Department - info@icspacific.com.au or **1800 630 360**.

Before contacting please obtain the cabinet Serial number (S/N) located inside the cabinet on the top right hand side.

Servicing

The hermetically sealed refrigeration system requires no inspection - just maintenance. If the cabinet fails to operate correctly and you cannot find the cause, contact the **ICS PACIFIC** Service Department.

Disposal

If the cabinet for which there is no longer any use is to be disposed of, please do so in an environmentally correct way. There might be special requirements / conditions to be observed. Information on the disposal of refrigeration appliances can be obtained from the Local Council and the Department of Environment, etc.