



TECHNICAL MANUAL

For Sun Xtender® Batteries

Manufactured by:

Concorde Battery Corporation
2009 San Bernardino Road
West Covina, CA 91790
Phone 626-813-1234
Fax 626-813-1235
www.sunxtender.com

Document No. 6-0100
Revision E
April 14, 2014

NOTICE: *The technical data contained herein has been reviewed and approved for general release on the basis that it contains no export controlled information. No part of this document may be copied or reproduced by any means, including electronic or mechanical, without written permission from Concorde Battery Corporation.*

DISCLAIMER: *The technical data contained herein is based upon the best information available as of the latest revision date. Concorde Battery Corporation makes no warranty of merchantability, fitness for any particular purpose, or any other warranty, expressed or implied, with respect to such information, and we assume no liability resulting from its use. It is the obligation of each user of the product to determine the suitability for any particular application and to comply with the requirements of all applicable laws regarding use and disposal of this product.*

RECORD OF REVISIONS

Revision	Date
Initial Release	8/26/08
A	10/22/08
B	3/25/09
C	9/03/09
D	7/18/11
E	4/14/14

SAFETY SUMMARY

DANGER OF EXPLODING BATTERIES

Lead acid batteries can produce explosive mixtures of hydrogen and oxygen. Take the following precautions:

- Never install batteries in an airtight or sealed enclosure and make sure installation is adequately ventilated.
- Charge batteries in accordance with the instructions given in this manual.
- Keep all sparks, flames and cigarettes away from batteries.
- Connect cables tightly to the terminals to avoid sparks.
- Wear proper eye and face protection when installing and servicing batteries.

DANGER OF CHEMICAL BURNS

Lead acid batteries contain sulphuric acid electrolyte which can cause severe burns to body tissue. Take the following precautions:

- Avoid contact of the electrolyte with skin, eyes or clothing.
- Never remove or damage vent valves.
- In the event of an accident, flush with water and call a physician immediately.

DANGER OF BURNS IF TERMINALS ARE SHORTED

Lead acid batteries are capable of delivering high currents if the external terminals are short circuited. The resulting heat can cause severe burns and is a potential fire hazard. Take the following precautions:

- Do not place metal objects across battery terminals.
- Remove all metallic items such as belt buckles, watches, bracelets and rings when installing or servicing batteries.
- Wear insulating gloves when installing or servicing batteries.
- Use insulated tools when installing or servicing batteries.

DANGER OF THERMAL RUNAWAY

Thermal runaway is a condition in which the battery temperature increases rapidly resulting in extreme overheating of the battery. Under rare conditions, the battery can melt, catch on fire, or even explode. Thermal runaway can only occur if the battery is at high ambient temperature and/or the charging voltage is set too high. Take the following precautions:

- Charge batteries in accordance with the instructions given in this manual.
- Do not install batteries near heat sources or in direct sunlight that may artificially elevate their temperature.
- Provide adequate air circulation around the batteries to prevent heat build up.



Table of Contents

Chapter 1 - Introduction	
1.1 Company Background	5
1.2 Overview of Sun Xtender® AGM Technology	5
1.3 About this Manual	5
Chapter 2 - Battery Construction	
2.1 Component Description	6
2.2 Battery with Cut Away View	8
2.3 Terminal Types	9
Chapter 3 - Technology Comparison	
3.1 Sun Xtender® versus Flooded Batteries	10
3.2 Sun Xtender® versus Gel Batteries	11
3.3 Sun Xtender® versus other AGM Batteries	12
Chapter 4 - Battery Specifications	
4.1 Battery Models	13
4.2 Terminals	13
4.3 Handles	13
4.4 Definition of Ratings	13
4.5 Temperature Range	13
4.6 UL Recognition	13
4.7 Shipping Classification	13
Chapter 5 - Commissioning and Servicing Instructions	
5.1 Storing	14
5.2 Installation	14
5.3 Discharging	18
5.4 Charging	19
5.5 Conditioning	20
5.6 Deep Discharge Recovery	21
5.7 Servicing	21
5.8 Recycling	22
Chapter 6 - Application Guide	
6.1 Load Calculations	23
6.2 Days of Autonomy	24
6.3 Temperature Considerations	24
6.4 Battery Sizing	25
Chapter 7 - Safety Information	
7.1 Release of Ignitable Gases	26
7.2 Acid Exposure	26
7.3 Shorting of Terminals	26
7.4 Thermal Runaway	26
Appendix A – Glossary	
Appendix B – Frequently Asked Questions	
Appendix C – Charts and Graphs	

CHAPTER 1 - INTRODUCTION

1.1 Company Background

Concorde Battery Corporation was founded in 1977 and is a manufacturer of premium quality lead acid batteries. Originally, Concorde's main product emphasis was dry charged and gelled electrolyte lead acid batteries. In 1985, Concorde developed its valve regulated, absorbent glass mat [AGM] technology for use in aircraft applications. The success of this technology in the aviation market has been outstanding. Concorde is now the largest manufacturer of valve regulated lead acid batteries for both commercial and military aircraft.

In 1986, Concorde further developed the AGM technology for deep cycle applications. This development effort provided higher energy density (higher capacity) and better cycle life than its gelled electrolyte battery. Concorde soon discontinued the gel product line and concentrated all engineering developments on the AGM product line. In 1987, Concorde began supplying the photovoltaic (PV) industry with our deep cycle AGM batteries. Over the years it has been our design expertise, quality and customer focus that has made Concorde a leader in providing the best battery available for the PV and Renewable Energy markets. Concorde is committed to the proposition that the customer deserves the best performing and highest quality product. Our batteries are tailored to the application rather than make the designer/user settle for what is available. It is this commitment – to meet the needs of the customer – that sets Concorde apart.

1.2 Overview of Sun Xtender® AGM Technology

Sun Xtender® AGM batteries are valve-regulated, recombinant gas, absorbed electrolyte, lead acid batteries. The cells are sealed with a pressure relief valve that prevents gases within the battery from escaping. The positive and negative plates are sandwiched between layers of glass mat consisting of a blend of glass micro fibers of varying length and diameter. This blend features superior wicking characteristics and promotes maximum retention of the electrolyte. An envelope of micro porous polyethylene surrounds each wrap of glass mat to further protect the plates from shorting. Electrolyte is absorbed and held in place by the capillary action between the fluid and the glass mat fibers. The mat is over 90% saturated with the electrolyte. By design it is not totally saturated with electrolyte, a portion is filled with gas. This void space provides the channels by which oxygen travels from the positive to the negative plates during charging. When the oxygen gas reaches the negative plate, it reacts with lead to form lead oxide and water. This reaction at the negative plate suppresses the generation of hydrogen that otherwise would come off the negative plate. In this manner, virtually all of the gas is “recombined” inside the cell, eliminating the need to add water, resulting in “maintenance free” operation. Furthermore, since the acid electrolyte is fully absorbed in the AGM separator, the battery is nonspillable even when turned upside down.

1.3 About this Manual

This manual is intended to provide the customer with technical information for selecting, installing, operating, and servicing Sun Xtender® AGM batteries. The next Chapter provides a detailed description of the product, its design features and materials of construction. Concorde is very proud of this innovative product line and we think you will share our enthusiasm. Chapter 3 provides a comparison of Sun Xtender® with other lead acid technologies: flooded-electrolyte batteries, gelled-electrolyte batteries, and AGM batteries from other manufacturers. Chapter 4 presents an overview of the battery specifications for the Sun Xtender® product line; detailed specifications for each model are published separately. Chapter 5 provides instructions for storing, operating and servicing Sun Xtender® AGM batteries. Chapter 6 gives an application guide and Chapter 7 gives important safety information. Further technical information can be found in the Appendices. If you have additional questions beyond what is covered in this manual, please contact Concorde Battery Corporation or any of our distributors.

CHAPTER 2 - BATTERY CONSTRUCTION

2.1 Component Description

Refer to the battery pictorial in Section 2.2 showing a cut away view of the cell and a summary of the features and benefits. A more detailed description of the battery's construction is given below.

GRIDS - The negative grid is made of pure lead calcium alloy. The positive grid is extra thick and is made from a proprietary, pure lead-tin-calcium alloy with special grain refiners. These features improve corrosion resistance of the grid and gives the battery excellent cycling capability and float life.

PLATES – The grids are pasted on state-of-the-art pasting machines to give the highest quality plates with tightly controlled weight and thickness specifications. The lead oxide paste used to make the positive plates is our high density formula. With time and use, the active material tends to soften and give less discharge capacity. The high density paste formula retards the active material softening and extends battery life.

ABSORBENT GLASS MAT [AGM] SEPARATOR – The AGM is a premium blend of glass micro fibers having an optimum ratio of fine and extra fine fiber sizes. This blend features superior wicking characteristics and promotes maximum retention of the electrolyte. The AGM layer is squeezed to an optimum level of compression during assembly to provide sufficient contact with the surface of the plate over the life of the battery. This compression also promotes retention of the active material if the battery is exposed to shock or vibration conditions.

POLYETHYLENE ENVELOPE – Concorde is the only manufacturer that envelopes the AGM separator with a thin layer of microporous polyethylene. The microporous layer is wrapped around the glass-matted plate and then sealed along the sides to eliminate the possibility of shorts at the edges of the plate (a common failure mode). The microporous polyethylene is more durable and puncture resistant than the AGM material alone and significantly reduces the occurrence of plate to plate shorts.

INTERCELL CONNECTIONS - Massive “over the partition” fusion welds are used which increase the strength of the intercell connection. This minimizes the possibility of open welds and provides a low resistance connection between cells. Other manufacturers use “through the partition” spot welded construction that inserts a weak point into the assembly because of the small cross section area and the difficulty of making a reliable weld and leak proof construction.

HIGH IMPACT, REINFORCED CONTAINER & COVER – The battery container and cover are made of a thick walled polypropylene copolymer. This material provides excellent impact resistance at extreme low temperatures and minimizes bulging at high temperatures.

COVER-TO-CONTAINER SEAL - The batteries use an epoxy-filled tongue and groove seal between the cover and container. Most other manufacturers heat seal their cover to the container. The epoxy-filled tongue and groove seal is far stronger than a heat seal and will not separate in high or low temperature extreme applications.



PRESSURE RELIEF SAFETY VALVE - Each cell in the battery employs a pressure relief safety valve. The valve is designed to release excess pressure that builds up over time to vent the small quantity of gasses that do not recombine inside of the battery. Once the pressure is released, the valve automatically re-seals. The gasses that escape are mainly oxygen and some hydrogen, and these gasses rapidly dissipate into the atmosphere.

TERMINALS - Sun Xtender® AGM batteries employ copper alloy (i.e., silicon bronze) terminals providing an improved low resistance electrical connection. The copper alloy terminals are non corrosive. Additionally, the copper alloy terminals offer increased environmental protection and personal safety in comparison to commonly used lead terminals. The terminals on most Sun Xtender® AGM batteries are recessed below the top of the battery cover. This prevents short circuiting across the battery terminals. Refer to the pictorial in Section 2.3 to see a detailed view of the various terminal designs that are available.

HANDLES – Lifting handles are incorporated into most Sun Xtender® AGM batteries. This provides easier handling for lifting, carrying and installation.

2.2 Battery with Cut Away View

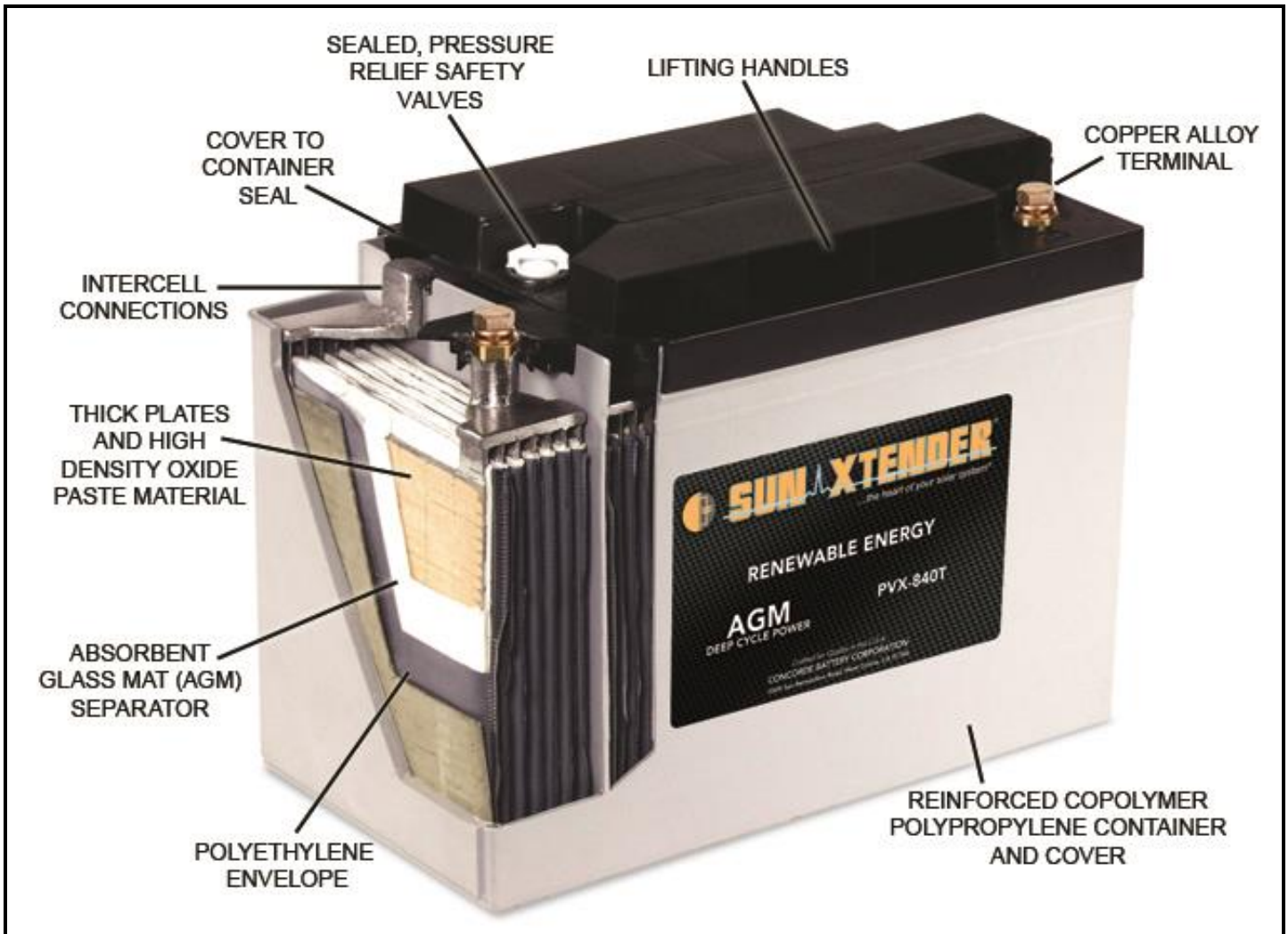

2.3 Terminal Types

Sun Xtender Battery Terminal Types

Copper Alloy Corrosion Free Connections for Maximum Conductivity

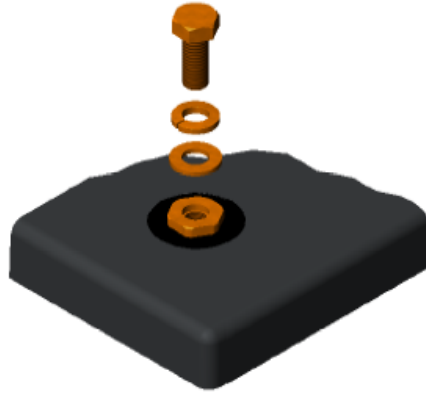

M8 Threaded Insert (Copper Alloy)
M6 Threaded Insert for PVX-340T & PVX-420T only

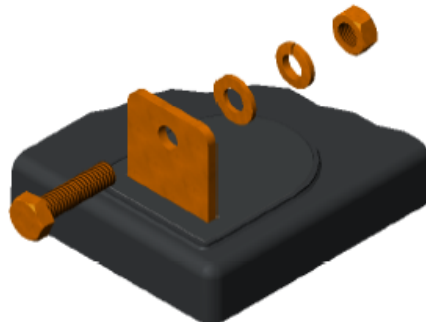

L-Blade Terminal (Solid Copper)
M8 Hardware

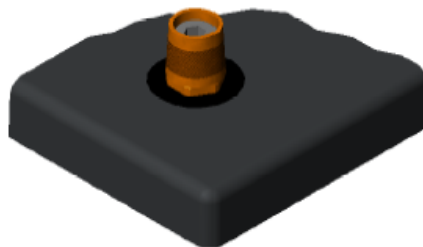

"A" - SAE Automotive Post (Copper Alloy)
Available as a separate kit, or installed at the factory
Kit Part Number: 6918

CHAPTER 3 - TECHNOLOGY COMPARISON

3.1 Sun Xtender® versus Flooded Batteries

Flooded-electrolyte lead acid batteries have been around since 1859 and tend to be less expensive than AGM or Gel batteries. However, they have major deficiencies compared to AGM or Gel batteries. For instance, deep cycle flooded lead acid batteries contain antimony in the grid alloy which causes a high rate of self discharge and rapid water loss due to gassing reactions. The escape of hydrogen and oxygen from the battery represents a serious safety hazard if the gasses are not ventilated properly. In flooded batteries, replacing the antimony lead alloy with calcium lead alloy reduces the amount of gassing and water loss, but the cycle life is much lower and they are no longer considered deep cycle batteries.

Electrolyte stratification can occur in all types of flooded batteries. As the battery is discharged and charged, the concentration of acid becomes higher at the bottom of the cell and becomes lower at the top of the cell. The low acid concentration reduces capacity at the top of the plates, and the high acid concentration accelerates corrosion at the bottom of the plates and shortens the battery life. Although stratification can be minimized by raising the charging voltage so that the increased gassing agitates the electrolyte, this will accelerate the water loss and watering frequency.

One other difference is that flooded batteries can not tolerate freezing temperatures when in the discharged state, whereas AGM batteries are not damaged by freezing temperatures. The following table provides a side by side comparison of Sun Xtender® AGM and flooded deep cycle batteries.

Table 3-1. Comparison of Sun Xtender® AGM Batteries with Flooded Deep Cycle Batteries

Characteristic	Sun Xtender® AGM Battery	Flooded Deep Cycle Battery
Self Discharge	1 to 3% per month – remains stable over life.	5-10% per month when new – increases drastically with age due to antimony contamination of the negative plate.
Water Addition	Never.	Frequent – increases dramatically with age due to antimony contamination of the negative plate.
Hydrogen Gas Emissions	Negligible unless severely overcharged.	Significant volume is generated and must be ventilated to prevent explosion.
Electrolyte Spillage	Non-spillable in all orientations – electrolyte is retained in AGM separator.	Spills when tilted, inverted, or cracked.
Electrolyte Stratification	No stratification occurs.	Stratification occurs when operated at low charging voltages or in taller batteries.
Tolerance to freezing temperatures	Resistant to damage when frozen.	Battery destroyed when frozen.

3.2 Sun Xtender® versus Gel Batteries

Gel batteries have been commercially available since the early 1970's and are still offered by some manufacturers. Concorde manufactured gel batteries for many years before developing the AGM technology and, therefore, is aware of inherent deficiencies associated with gel batteries.

The gel product employs a highly viscous, semisolid mixture of silica gel and dilute sulfuric acid in a colloidal suspension as an electrolyte. The electrolyte is difficult to keep homogeneous and the solid silica can separate from the acid, creating a “flooded” battery. Handling and vibration exposure are operational factors that can cause the silica and acid mixture to separate as there is no chemical bond. In high temperature environments, the semisolid electrolyte develops cracks and voids that reduce contact between the plates and causes the battery to lose capacity. This same effect gradually occurs even at normal room temperatures.

By contrast, AGM batteries employ a glass micro fiber mat separator that holds the liquid electrolyte like a sponge. Shrinkage of the separator does not occur as the battery ages and the electrolyte remains in direct contact with the plates. The electrolyte remains immobilized even when the battery is exposed to severe vibration, so electrolyte spillage or leakage is prevented.

Since it is easier to fill a container with a liquid than a semi-solid, AGM batteries require less space between battery plates. The closer plate spacing gives the AGM battery a lower internal resistance, making it more charge efficient and giving better power performance on discharge, especially at low temperatures.

Gel batteries are also more sensitive to charging voltage. If the charging voltage is not controlled within a very tight range relative to the battery's temperature, the life of the battery will be adversely affected. For example, one manufacturer of gel batteries claims that if the charging voltage is 0.7V higher than the recommended level, the cycle life will be reduced by 60 percent. The reason for this effect is the limited oxygen recombination capability of gelled batteries. Sun Xtender® AGM batteries are more forgiving in overcharge conditions and their ability to recombine the hydrogen and oxygen gases back into water is more efficient. With Sun Xtender® AGM batteries, tests have shown that increasing the charging voltage 1.0V above the recommended charging voltage results in only a 23% reduction in the cycle life.

The charge acceptance of gel batteries is also less than that of Sun Xtender® AGM batteries. This means it takes longer to recharge gel batteries. As an example, tests have shown that when discharged to 50% of rated capacity (fairly common in a PV system), gel batteries took twice as long to reach full charge as compared to Sun Xtender® AGM batteries.

The following table provides a side by side comparison of Sun Xtender® AGM and gel batteries:

Table 3-2. Comparison of Sun Xtender® AGM Batteries with Gel Batteries

Characteristic	Sun Xtender® AGM Battery	Gel Batteries
Electrolyte Stability	Excellent – AGM acts like a flexible sponge.	Prone to solid / liquid separation leading to spillage / spewage of acid and premature failure. Electrolyte loses contact with plates due to cracks and voids as the battery ages, especially at higher ambient temperatures.
High Rate Performance	Excellent due to low internal impedance.	Inferior. Plate spacing must be greater to allow for gel passage during filling. Gel adds to impedance, especially at low temperatures.
Sensitivity to Charging Voltage Levels	Moderately sensitive. Life is somewhat reduced if charged outside of recommended charge voltage levels.	Very Sensitive. Life is greatly reduced if charged outside of recommended charge voltage levels.
Charge Acceptance Rate	Excellent. Battery can be fully charged in 2 hours if high inrush current is available.	Inferior. Must limit inrush current and charge time is at least twice as long to reach full charge.

3.3 Sun Xtender® versus other AGM Batteries

Sun Xtender® AGM batteries have been specifically designed for true deep cycle, long service life capability in adverse temperature and handling conditions. Concorde uses extra thick positive plates, high density paste, thick AGM separator layers encased within a microporous polyethylene envelope, thick walled containers with epoxy-sealed covers. A side by side comparison of Sun Xtender® AGM batteries with typical AGM batteries from other manufacturers is provided in the following table:

Table 3-3. Comparison of Sun Xtender® AGM Batteries with Other AGM Batteries

Characteristic	Sun Xtender® AGM Battery	Other AGM Batteries
Positive Grids	Extra thick grids (typically 0.095" or greater) and extra thick plates (typically 0.105" or greater), for long cycle and float life.	Thinner grids, typically 0.045 to 0.060".
Pasted Plates	High density positive paste for long cycle life.	Lower density, resulting in lower cycle life.
AGM Separator	Extra thick for maximum electrolyte reserve. Premium grade of AGM with extra fine fibers for long life.	Thinner material used. Inferior grade of AGM without the extra fine fiber content.
Microporous polyethylene separators	Envelopes the positive plate to prevent shorting due to shock, vibration and dendrites	Not present, AGM is the only separator protecting the plates.
Intercell connections	Massive over the partition connectors provide a robust, leak proof connection with low voltage loss.	Inferior through the partition welds have less cross sectional area, provide weaker structural connection, and are leak prone.
Battery Terminals	Copper alloy – low electrical resistance and no exposed lead.	Lead alloy - higher in electrical resistance and user is exposed to lead contamination.
Container	Thick wall for rigid support of cell elements and high compression of AGM separator.	Thinner walls, less support of cell elements and lower compression of AGM separator.
Cover Seal	Cover is epoxied to container – high strength bond for reliable operation at temperature extremes.	Cover is heat sealed (melted) to container – prone to separation and leakage at temperature extremes.



CHAPTER 4 - BATTERY SPECIFICATIONS

4.1 Battery Models

The Sun Xtender® Series consists of batteries ranging in capacity from 34 to 1215 ampere hours (rated at the 24 hour rate). A variety of 2-volt, 6-volt and 12-volt models are available. Refer to the battery specification sheet (published separately) for a complete listing of the mechanical and electrical specifications for each battery model.

4.2 Terminals

Standard Terminals: Batteries with a “T” at the end of the part number incorporate M6 or M8 (copper alloy) threaded insert terminals. Batteries with an “L” at the end of the part number incorporate “L” Blade (solid copper) terminals. All batteries are supplied with silicon bronze bolts, nuts, and washers required for installation.

Optional (Copper Alloy) Terminal Installed at the Factory: Batteries with a “T” at the end of the part number (except PVX-340T & PVX-420T) are available with an optional factory installed SAE automotive type terminal by adding the “A” suffix to the end of the part number. For example, order PVX-1040TA instead of PVX-1040T.

Optional (Copper Alloy) Terminal Kit: Kits can be ordered for “After Factory” customer conversions of “T” type batteries (except PVX-340T & PVX-420T) by ordering P/N 6918 for the “A” SAE automotive post kit. Kit includes terminals and installation bolts required for installation.

Terminal Torque Values: M6 use 35 in-lbs / 4.0 nm. M8 use 70 in-lbs / 7.9 nm.

4.3 Handles

All batteries include built in lifting handles except the PVX-490T and PVX-560T.

4.4 Definition of Ratings

Capacity ratings are after 15 cycles per BCI specifications and are stated at 77°F (25°C) to 1.75 volts per cell.

4.5 Temperature Range

Storage (when fully charged): -55°C (-67°F) to 50°C (122°F).
Operating: -40°C (-40°F) to 71°C (160°F).

4.6 UL Recognition

All Sun Xtender® AGM batteries meet the requirements of UL® 1989 (Standby Battery) and are UL recognized under UL File Number MH-17983.

4.7 Shipping Classification

Sun Xtender® AGM batteries have been tested and determined to be in compliance with the vibration and pressure differential tests in accordance with DOT 49 CFR 173.159(d) and Special Provision A67 of the International Air Transport Association (IATA) Dangerous Goods regulations. As such, they are classified as a “NONSPILLABLE BATTERY” and can be shipped as non-hazardous material by any means. To comply with DOT shipping regulations, the battery must be packaged to protect against short circuits and the battery and outer packaging must be plainly and durably marked “NONSPILLABLE” or “NONSPILLABLE BATTERY”.

CHAPTER 5 - COMMISSIONING AND SERVICING INSTRUCTIONS

5.1 Storage

Sun Xtender® batteries are charged at the factory and are ready for installation when they are received. Batteries may be stored prior to installation for up to 2 years, provided they are boost charged as described below. Batteries should be stored in the coolest environment available, preferably not exceeding 20°C (68°F). The higher the temperature, the faster the battery will self-discharge and require boost charging. See Appendix C for data on storage time versus temperature.

While in storage, batteries should be boost charged every 90 days or when the open circuit voltage (OCV) drops to 2.08 volts per cell (12.5 volts for a 12 volt battery). This OCV corresponds to approximately 75% state of charge. Boost charge batteries using a constant voltage charger set at 2.45 volts per cell (14.7 volts for a 12 volt battery) at a temperature of 20°C (68°F). If the temperature is above 20°C (68°F), compensate the charge voltage by subtracting 0.04V/cell for every 10°C difference (0.24V for a 12 volt battery). If the temperature is below 20°C (68°F), compensate the charge voltage by adding 0.04V/cell for every 10°C difference. The boost charge should be applied until the charging current falls below 0.5 percent of the battery's 24 hour rated capacity (0.5 amps for a 100 Ah battery). The time it takes for boost charging can be estimated from the following equation, based on the battery state of charge (SOC), rated capacity, and rated output of the charger:

Time to Reach Full Charge = $[(1 - \text{SOC}/100) \times \text{Rated Capacity (Ah)} \div \text{Rated Output of Charger (Amp)}] + 2$ hours.

For example, when boosting a 258 Ah battery at 75% SOC using a 15A charger, the charging time can be estimated as follows:

Time to Reach Full Charge = $[(1 - 75/100) \times 258 \text{ Ah} \div 15\text{A}] + 2$ hours = 6.3 hours.

5.2 Installation

Be sure there is adequate ventilation in the area where the batteries are to be installed (see Chapter 7). Batteries may be installed in any orientation except upside down (i.e., terminals facing the earth). The space surrounding adjacent batteries should be at least 0.25 inch to permit airflow around each battery. Always use batteries of the same size and condition in multi-battery installations. When replacing batteries, it is best to replace the entire set of batteries so they remain balanced.

Connect batteries using cabling that is sized for the maximum load of the system. The voltage drop on the cables during charging should not exceed 0.2 volts at full output. Protect the battery terminals from shorting during installation.

Batteries may be connected in series (voltage adds, capacity stays the same), in parallel (capacity adds, voltage stays the same), or a combination of series and parallel (voltage and capacity adds). Each of these connection options are illustrated in Figures 5-1 through 5-3, respectively.

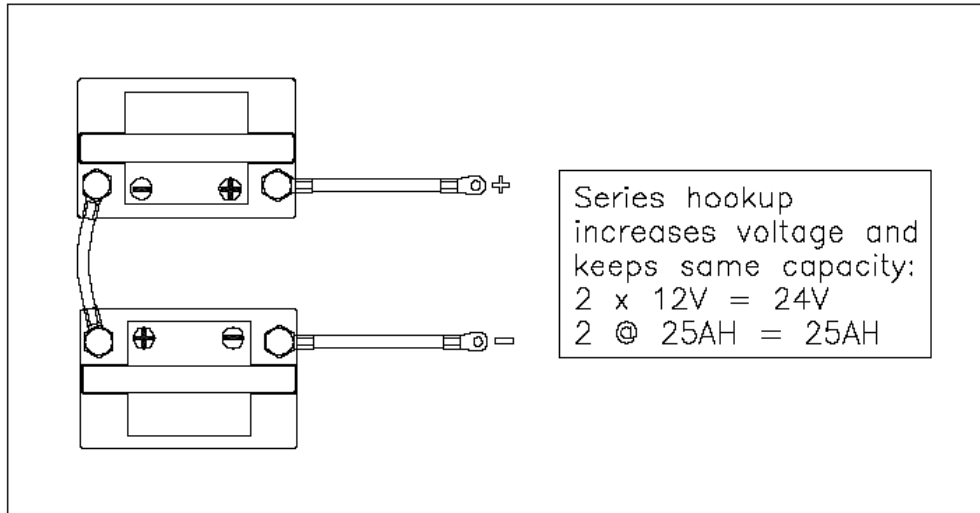

Figure 5-1. Series Connection

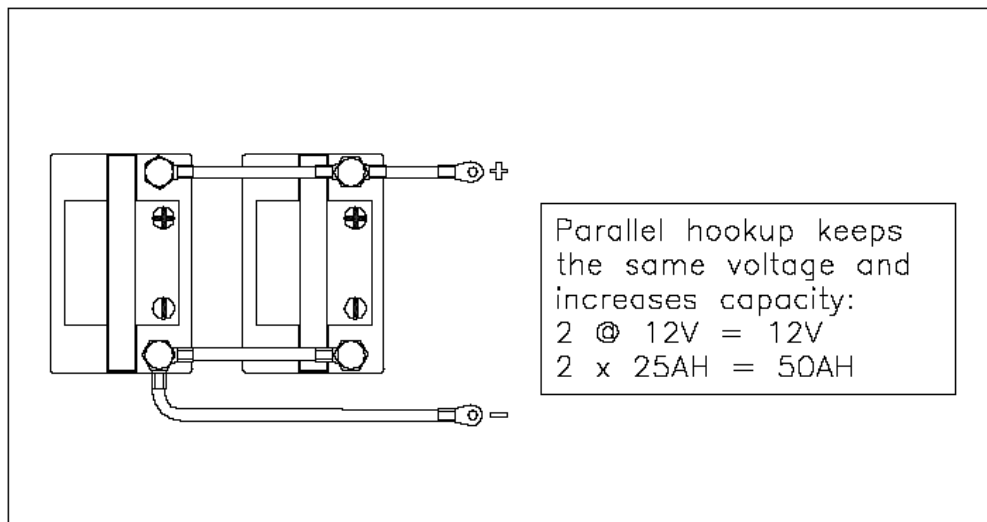

Figure 5-2. Parallel Connection

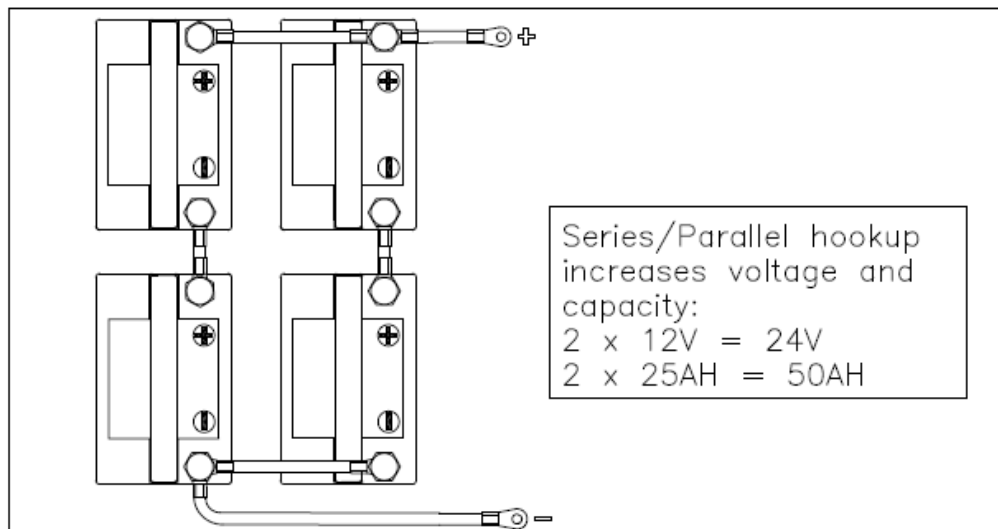

Figure 5-3. Series/Parallel Connection

Connection options for 4-terminal batteries are illustrated in Figures 5-4 through 5-8. For low rate applications (current levels less than 400 amperes), only two of the four terminals need to be connected, but it is still best to use all four terminals for redundancy. For high rate applications (current levels greater than 400 amperes), all four terminals should be connected.

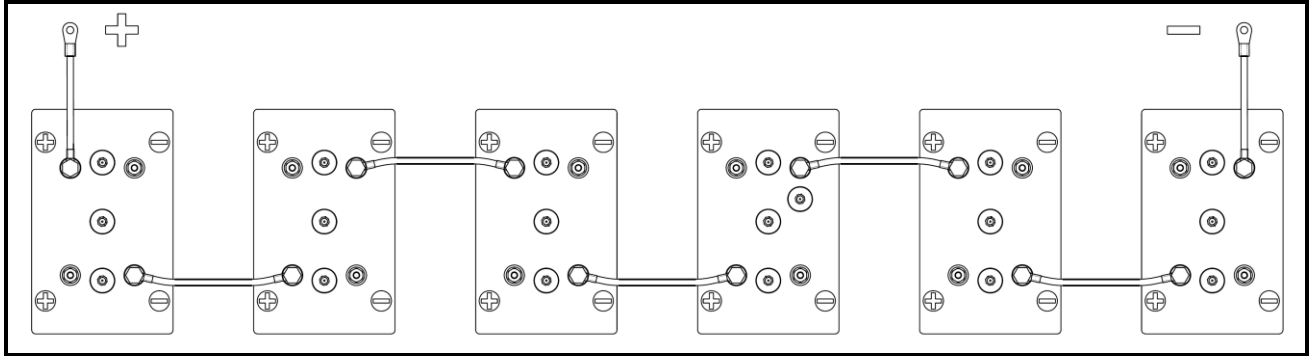

Figure 5-4. Series Connection for 4-Terminal Batteries (Low Rate Applications Only)

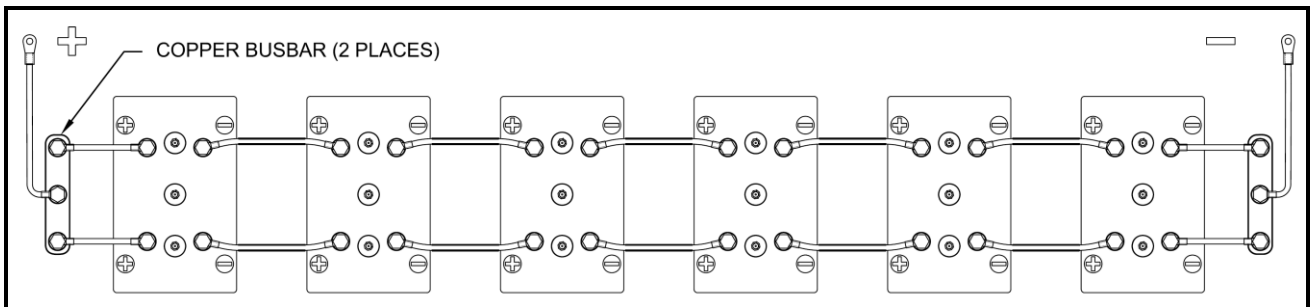

Figure 5-5. Series Connection for 4-Terminal Batteries (Low or High Rate Applications, Option A)

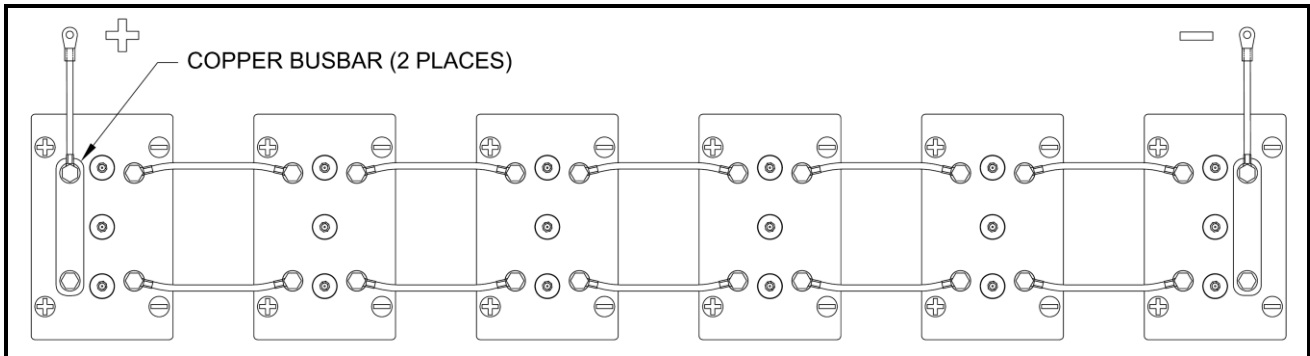

Figure 5-6. Series Connection for 4-Terminal Batteries (Low or High Rate Applications, Option B)

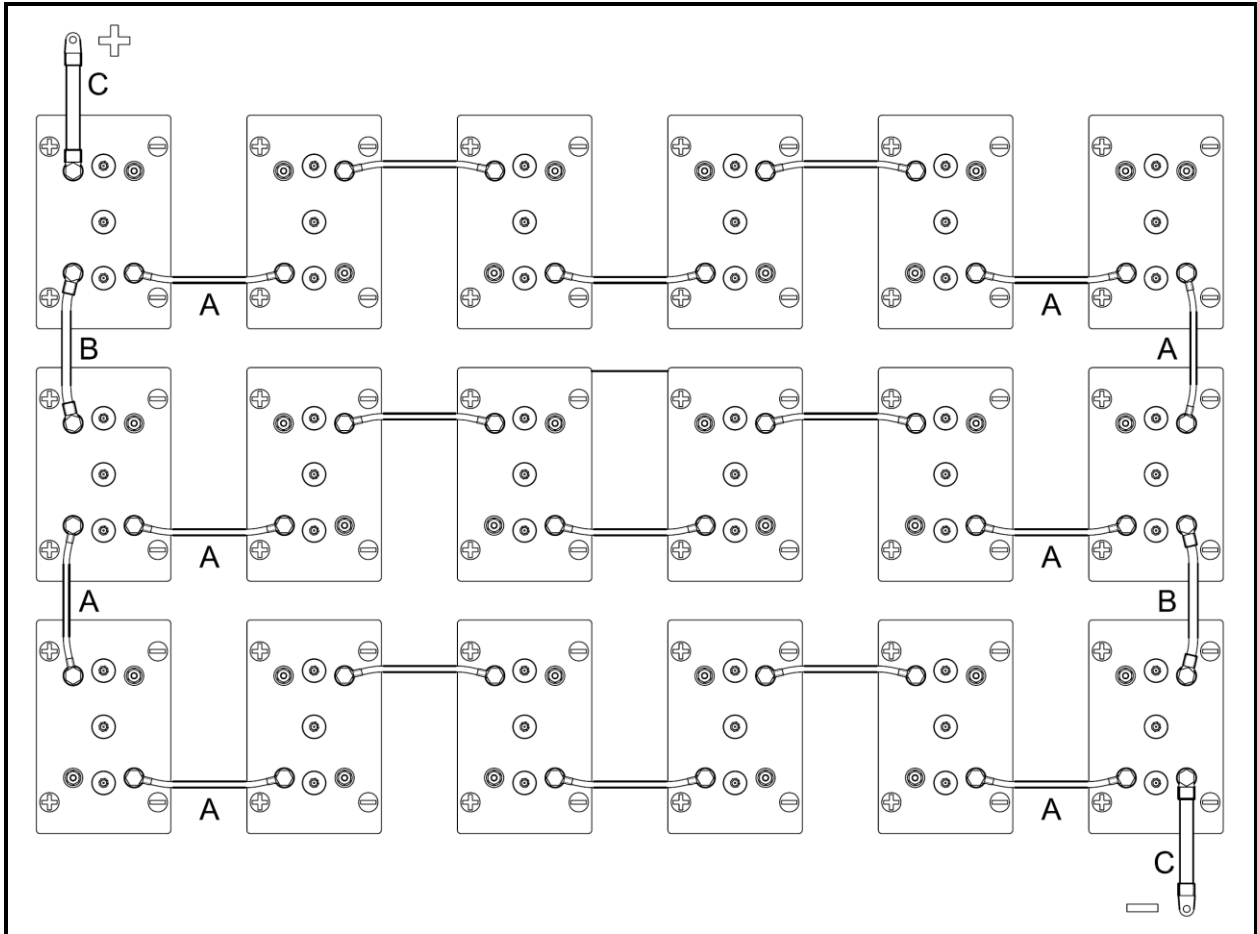

Figure 5-7. Series/Parallel Connection for 4-Terminal Batteries (Low Rate Applications Only)

NOTE: Cables A, B and C carry different current levels and should be sized accordingly. In this example, the current in Cable B is 2 times that of Cable A and the current in Cable C is three times that of Cable A.

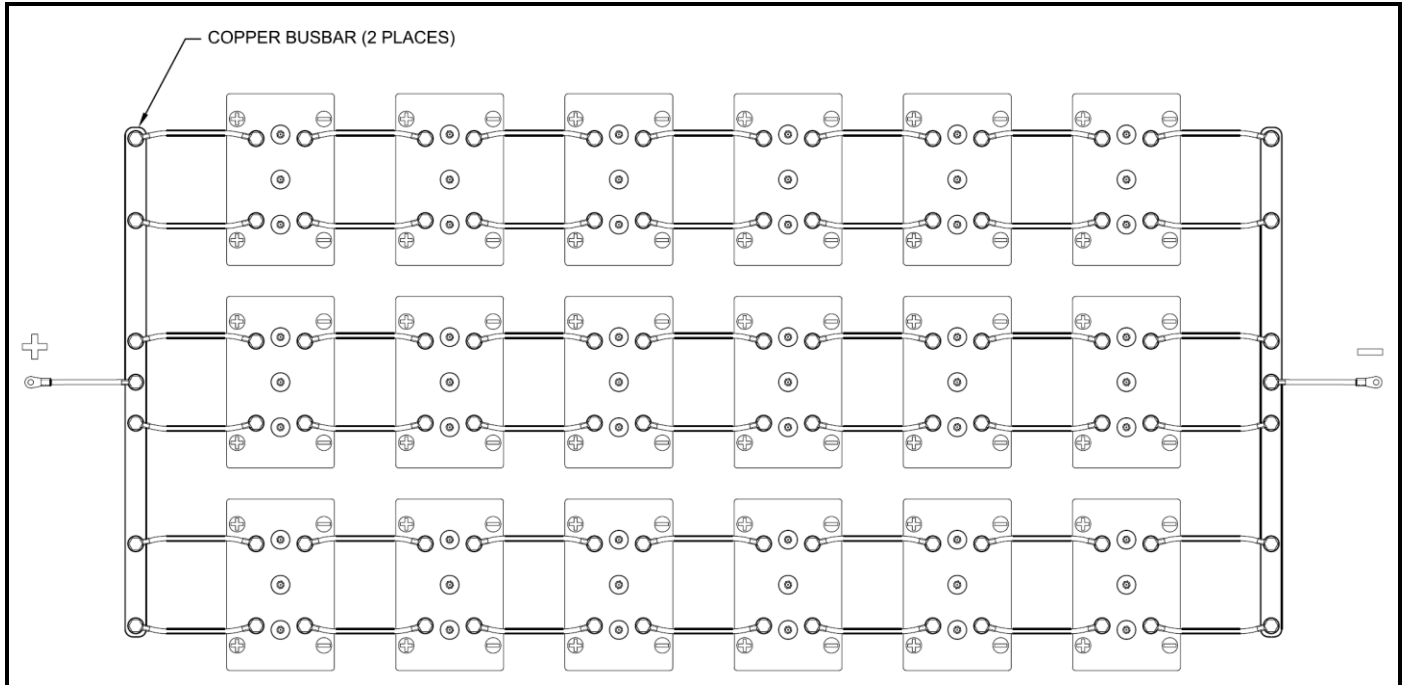

Figure 5-8. Series/Parallel Connection for 4-Terminal Batteries (Low or High Rate Applications)

5.3 Discharging

Discharge data for Sun Xtender® AGM batteries are given in Appendix C. The capacity delivered by the battery depends on the rate of discharge as well as the battery temperature. The battery will deliver less capacity as the discharge rate increases and less capacity as the temperature is lowered. Graphs are provided in Appendix C to quantify these effects. Peukert plots (Amps vs Time) are also included, along with formulas for calculating the current that can be removed or any discharge time from 0.5 hours to 120 hours. To calculate the discharge time for a specified amperage, these formulas can be inverted as follows:

$$A = C \times T^{-n}$$

$$T = C^{1/n} \times A^{-1/n}$$

(A = Amps, T = Time in hours, C & n are constants specific for each battery model)

In general, batteries should be sized such that the rated capacity is at least twice the capacity required by the load. For example, if 100 Ah is required on average, select at least a 200Ah battery. This approach will limit the average depth of discharge to 50% and will dramatically extend the life of the battery (see chart of Cycle Life versus Depth of Discharge in Appendix C).

5.4 Charging

Charging Sun Xtender® AGM batteries is a matter of replacing the energy removed during discharge plus a little extra to make up for charging inefficiency. The amount of energy necessary for complete recharge depends on the depth of discharge, rate of recharge, and temperature. Typically, between 102% and 110% of the discharged ampere-hours must be returned for full recharge.

The most efficient method of charging Sun Xtender® AGM batteries is to use a 3 stage charging profile. In the first stage, a constant current is applied until the voltage reaches a pre-set limit. The first stage is often called the **Bulk** charging stage. In the second stage, the voltage is held constant at the same pre-set limit until the charging current tapers to a very low value, at which point the battery is fully charged. The second stage is often called the **Absorption** charging stage. The battery is fully charged when the current drops below 0.5% of the battery's rated capacity (0.5A for a 100Ah battery). The absorption stage will typically last 2 – 4 hours before the current reaches this level. In the third stage, the charging voltage is reduced to a lower value that minimizes the amount of overcharge, while maintaining the battery at 100% state of charge. This third stage is often called the **Float** charging stage. The following table provides the recommended charge voltage settings for Sun Xtender® Batteries:

Table 5-1 Recommended Charge Voltage Settings for Sun Xtender® Batteries

	Absorption Voltage at 25°C (77°F)	Float Voltage at 25°C (77°F)
Volts per Cell	2.37 - 2.40V	2.20 - 2.23V
For 12V System	14.2 - 14.4V	13.2 - 13.4V
For 24V System	28.4 - 28.8V	26.4 - 26.8V
For 48V System	56.8 – 57.6V	52.8 – 53.6V

The charging volts per cell (VPC) at other temperatures can be determined from the following equations:

$$\text{VPC (Absorption)} = 0.00004T^2 - 0.006T + 2.510 \quad (\text{where } T = ^\circ\text{C})$$

$$\text{VPC (Float)} = 0.00004T^2 - 0.006T + 2.340 \quad (\text{where } T = ^\circ\text{C}), \text{ but not less than } 2.167 \text{ volts per cell.}$$

See Appendix C for a chart of charging voltage versus temperature.

The charging current during the Bulk stage should be set as high as practical; higher current levels mean faster recharge time. Due to the low impedance design, Sun Xtender® batteries can tolerate in-rush current levels as high as 5C (500A for a 100Ah battery). The time to reach full charge at temperatures in the range of 20-30°C (68 to 86°F) can be estimated from the following equation:

$$\text{Time to Reach Full Charge} = [(\text{DOD}/100) \times \text{Rated Capacity (Ah)} \div \text{Rated Output of Charger (Amp)}] + 2 \text{ hours.}$$

For example, charging a 100Ah battery at 50% DOD with a 25A charger would take:

$$[(50/100) \times 100 \div 25] + 2 = 4 \text{ hours to reach full charge.}$$

If a 10A charger is used, it would take:

$$[(50/100) \times 100 \div 10] + 2 = 7 \text{ hours to reach full charge.}$$

Note that this formula is approximate and the full charge state should be verified using the criteria given above (current drops below 0.5% of rated capacity). If the recharge does not return 102 to 110% of the discharged capacity, the battery's state of charge will gradually "walk down" as it is cycled leading to premature failure. Therefore, it is important to verify that the battery is not being undercharged.

For repetitive deep cycling applications (deeper than 50% DOD), chargers should have an output current of at least 0.2C (20 Amps for a 100 Ah battery). If the output current is less than this value, the cycle life of the battery may be negatively affected. If a charger with at least 0.2C output is not practical, an alternative charge profile using a low rate constant current stage at the end of the absorption stage will normally improve the cycle life. The constant current stage should be at 0.02C (2 Amps for a 100Ah battery) for no more than one hour.

Some types of battery chargers allow the user to input the Peukert constant to obtain an optimum charging profile. For Sun Xtender® batteries, the recommended value of the Peukert constant is $n = 1.12$.

5.5 Conditioning

Conditioning should be done when the battery is showing symptoms of capacity loss or when the float voltages of series-connected batteries show excessive variation. These conditions can be caused by letting the battery dwell too long in a low state of charge condition, or by repetitive undercharging.

NOTE: Some chargers use the term Equalizing Charge instead of Conditioning Charge. An Equalizing Charge is generally applied to flooded lead acid batteries that are susceptible to acid stratification. However, an Equalizing Charge may be used to provide a Conditioning Charge for Sun Xtender® batteries as described below.

To apply a Conditioning Charge, first go through the normal charge cycle to bring the battery to full charge. The Conditioning Charge should then be applied by charging for 8 hours using the volts per cell (VPC) given in the following equation:

$$\text{VPC (Conditioning)} = 0.00004T^2 - 0.006T + 2.705 \quad (\text{where } T = ^\circ\text{C}).$$

At 25°C, the conditioning voltage is 2.58 VPC (15.5 volts for a 12 volt battery). By using the temperature-compensated voltage, calculated from the above equation, batteries that are not in controlled temperature environments may be conditioned without bringing them to room temperature. If temperature compensation is not available, it is best to bring the battery to room temperature before applying the conditioning charge.

5.6 Deep Discharge Recovery

Batteries that have been in storage for long periods of time without boost charging, or have been kept deeply discharged for an extended time, may need to be charged at constant current instead of constant voltage to restore capacity. The following procedure is effective if the batteries are not too badly sulfated. **WARNING: This procedure should only be done in a well ventilated area because a significant amount of hydrogen gases may be released from the battery.**

1. Stabilize the battery at 20-30°C (68-86°F) for at least 24 hours.
2. Charge at a constant current of 5% of rated (24 hour) capacity until the voltage reaches 2.60 VPC (15.6 volts for a 12 volt battery), then continue charging at this rate for an additional 4 hours. Note that the charging voltage may get as high as 3.0 volts per cell, so the power supply must be capable of outputting this level to maintain constant current. This constant current charge may take 16 to 20 hours.

CAUTION: If the battery becomes hot (above 55°C/130°F) during this charge, stop the current and allow the battery to cool to room temperature before continuing.

NOTE: The above procedure should be performed by an experienced battery maintenance facility utilizing the proper charging and test equipment. For information regarding Concorde's recommended test equipment go to: www.concordebattery.com/accessories.php.

5.7 Servicing

SunXtender® AGM batteries do not need electrolyte additions as do flooded lead-acid batteries, but periodic servicing is essential to assure continued integrity of the battery system. Servicing should include good record keeping to document the life history of the battery system and to identify whether corrective action needs to be taken.

The following servicing schedule is recommended:

Installation

1. Within the first week of operation, put the battery system on a full charge cycle and record the following parameters (baseline readings):
 - a. Charger amperage output
 - b. Absorption voltage at battery system terminals
 - c. Float voltage at battery system terminals
 - d. Ripple voltage at battery system terminals (see Note 1)
 - e. Voltage of each battery when charger is in float mode (see Note 2)
 - f. Ambient temperature
2. Allow the battery system to discharge until it reaches the low voltage disconnect, and record the following parameters:
 - a. Run time
 - b. Capacity delivered (Ampere-hours)
 - c. Average DC load (amperes)
 - d. Endpoint voltage at battery system terminals
3. After discharging, return the battery to a fully charged condition as soon as possible.

Quarterly

1. Inspect each battery terminal for any corrosion deposits. If present, remove with a wire brush, neutralize with a baking soda solution, dry, and then apply NO-OX-ID grease.
2. Record the following parameters with the battery on float charge:
 - a. Float voltage at battery system terminals
 - b. Voltage of each battery (see Note 2)
 - c. Ambient temperature

Yearly

1. Put the battery on a full charge cycle and record the following parameters:
 - a. Charger amperage output
 - b. Absorption voltage at battery system terminals
 - c. Float voltage at battery system terminals
 - d. Ripple voltage at battery system terminals (see Note 1)
 - e. Voltage of each battery when charger is in float mode (see Note 2)
 - f. Ambient temperature
2. Allow the battery system to discharge until it reaches the low voltage disconnect, and record the following parameters:
 - a. Run time
 - b. Capacity delivered (Ampere-hours)
 - c. Average DC load (amperes)
 - d. Endpoint voltage at battery system terminals
3. After discharging, return the battery to a fully charged condition as soon as possible.

NOTES:

- (1) Excessive ripple voltage will negatively impact battery life. Maximum recommended ripple voltage (peak to peak) is 0.5% of the float voltage setting.
- (2) A large variation of individual float voltages in a new battery system is normal because of variations in oxygen recombination efficiency due to slight variations of acid saturation within the AGM. As the battery ages, the variation should drop to lower values. Excessive variation of float voltages after the first 1-2 months is an indication that the batteries may be out of balance. If individual battery voltage readings during float charge vary by more than 0.10 volt per cell (0.10 volt for 2V batteries, 0.30 volt for 6V batteries, and 0.6 volt for 12V batteries), then a conditioning charge per Section 5.5 is recommended.

5.8 Recycling

Batteries that have reached the end of their service life should be returned to a local or regional collection center for recycling. All local regulations and ordinances must be followed. Never discard Sun Xtender® AGM batteries in the trash or in a landfill. The recycle rate of lead acid batteries is close to 100% and this is very good for the environment!

CHAPTER 6 – APPLICATION GUIDE

The following section contains guidelines for sizing a battery system that should provide a reliable energy storage system for stand alone Renewable Energy systems. The primary emphasis is for photovoltaic (PV) systems but other renewable energy source systems would have similar requirements.

6.1 Load Calculations

DC Loads

To calculate the *DC Ampere Hours per Day* required to power the system:

$$\text{DC Load Amps} = 1000 \times \text{kW} \div \text{DC System Voltage}$$

$$\text{Total Daily Load [AH]} = \text{DC Load Amps} \times \text{No. of Operating Hours per Day}$$

Example:

For a 0.12 kW DC load at 48 VDC,
 DC Load Amps = $1000 \times 0.12\text{kW} \div 48\text{VDC} = 2.5\text{A}$.
 Total Daily Load = $2.5\text{A} \times 24 \text{ Hours/Day} = 60 \text{ AH/Day}$.

For variable DC Loads, establish the duty cycle based on percentages of the daily operations.

$$(\text{P1\% of day at xx Amps}) + (\text{P2\% of day at yy Amps}) + \text{Etc} = \text{Total AH Consumed/Day}$$

Example:

A system operates at 5A for 70% of the day and 10A for 30% of the day:
 Total Daily Load = $(70\% \times 5\text{A} \times 24 \text{ Hrs}) + (30\% \times 10\text{A} \times 24 \text{ Hrs})$
 Total Daily Load = $84 \text{ AH} + 72 \text{ AH} = 156 \text{ AH/Day}$.

AC Loads

When an inverter is used to power 120 or 240 VAC appliances, such as pumps, refrigerators, lighting, etc., the AC voltage must be converted to the Battery's DC voltage and the efficiency of the inverter must be considered.

If the inverter AC voltage is 120 VAC and the battery DC voltage is 24 VDC, then the conversion factor is 5.0. For every AC amp drawn there will be 5 times as many DC amps required. Also, the inverter's conversion efficiency from DC to AC is not 100%. There is an internal loss in the inverter which is normally about 10% to 15%. See inverter/charger manufacturer's data for efficiency specifications.

Example:

For a 2.4 kW AC Load at 120VAC with a 48VDC battery and Inverter operating at 90% efficiency,
 AC Load = $1000 \times 2.4 \text{ kW} \div 120 \text{ VAC} = 20 \text{ Amps @ } 120 \text{ VAC}$
 DC Load = $20 \text{ Amps AC} \times 120/48 \div 0.90 = 55.6 \text{ Amps DC}$
 Total Daily Load = $55.6 \text{ A} \times 24 \text{ Hours/Day} = 1,334 \text{ AH/Day}$

Note: When sizing the battery for non continuous loads or for larger loads for short periods of time per day, it may not be possible to use the 20, 24 or 120 hr. rate of discharge for the battery's capacity. When discharged at different rates, a battery's capacity will vary. The higher the rate of discharge, the lower the capacity of the battery will be. More detailed calculations are required in these cases.

6.2 Days of Autonomy

As everybody knows, the sun does not shine with equal intensity every day, nor does it shine at night and during inclement weather. Cloud cover, rain, snow, etc. diminish the daily insolation (*Insolation* is the amount of solar energy delivered to the earth's surface, measured in W/m^2 or $kWh/m^2/day$). A storage factor must be employed to allow the photovoltaic battery system to operate reliably throughout these periods.

In addition, it is desired to obtain the best service life of the battery by limiting its average daily depth of discharge. This storage factor is commonly referred to as "Number of Days of Battery Autonomy." The number of days is established by evaluating the peak hours of sun per day for the lowest insolation month of the year with the solar array oriented for maximum output during that month.

The minimum number of days that should be considered is 5 days of storage for even the sunniest locations on earth. In these high sun locations there will be days when the sun is obscured and the battery's average depth of discharge should not be more than 20% per day. The recommended days of autonomous storage are shown in the following table:

Table 6-1. Recommended Days of Autonomy

Insolation Level ($kWh/m^2/day$)	Days of Autonomy
4.5+	5
3.5 to 4.5	6
2.7 to 3.5	7
2.0 to 2.7	8
< 2.0	10 or more

6.3 Temperature Considerations

The temperature of the battery is a major factor in sizing a PV system. Battery capacity is reduced significantly in cold temperatures. For example, a battery that operates continuously at $-18^{\circ}C$ ($0^{\circ}F$.) will only provide about 60% of its normal room temperature capacity. Appendix C provides a chart of capacity versus temperature at various discharge rates.

Battery life is also affected by temperature. As a rule of thumb, the battery life decreases by 50% for every $10^{\circ}C$ rise in temperature. Thus, a battery that lasts 6 years at $25^{\circ}C$ will last 3 years at $35^{\circ}C$, 1.5 years at $45^{\circ}C$, and 0.75 years at $55^{\circ}C$.

It should be realized that the temperature of the battery itself and ambient temperature can be vastly different. While ambient temperatures can change very quickly, battery temperature change is much slower. This is due to the large thermal mass of the battery. It takes time for the battery to absorb temperature and it takes time for the battery to relinquish temperature.

The earth is a great heat sink which can be used to attenuate temperature fluctuations of the battery. By locating the battery in an underground chamber, it will be better insulated from extreme ambient conditions. The battery capacity will improve at cold ambient temperatures, so a smaller battery may be selected. The cool underground temperature will prolong battery life, reducing replacement costs. Of course, there is added cost associated with underground installations. Therefore, a cost/benefit analysis should be performed to determine if locating the battery underground is economically justified.

If the battery is exposed to cold climates, the state of charge should be kept at a maximum to prevent freezing of the electrolyte. A fully charged battery will not freeze even under the coldest weather conditions, but a discharged battery will freeze even when moderately cold. Table 6-2 gives the freezing point of electrolyte at various states of charge.

Frozen batteries are not capable of charging or discharging except at very low rates, and may be permanently damaged by expansion of the electrolyte. If a battery becomes frozen, it should be thawed by placing it at room temperature for at least 24 hours, and then charged in accordance with Sections 5.4, 5.5 or 5.6 as applicable. However, if the battery container has any evidence of cracking, the battery is no longer serviceable and should not be used.

Table 6-2. Electrolyte Freezing Point at Various Battery States of Charge

Battery State of Charge (%)	Approximate Electrolyte Freezing Temperature
100%	-70°C (-94°F)
75%	-47°C (-53°F)
50%	-25°C (-13°F)
25%	-13°C (9°F)
0%	-6°C (21°F)

6.4 Battery Sizing

The battery capacity for a PV system can be calculated using the following formula:

$$\text{Capacity (AH)} = \text{Total Daily Load} \times \text{Days of Autonomy} \times \text{Design Factor}$$

The Design Factor depends on the battery's average temperature during the coldest time of the year, as discussed above. Table 6-3 provides recommended Design Factors at various temperatures.

Table 6-3. Recommended Design Factors for Battery Sizing

Lowest Battery Temperature Averaged over 24 Hours		Design Factor
Degrees C	Degrees F	
25 or above	77 or above	1.25
20 to 24	68 to 76	1.39
10 to 19	50 to 67	1.43
0 to 9	32 to 49	1.60
-10 to -1	14 to 31	1.84
-20 to -11	-4 to 13	2.23
-30 to -21	-22 to -5	2.84
-40 to -31	-40 to -23	4.17

Example:

For a 48VDC system, Total Daily Load of 30AH, 5 Days of Autonomy, and -8°C is the lowest average temperature; the recommended battery capacity is as follows:

Battery Capacity = 30 x 5 x 1.84 = 276AH. This requirement could be satisfied with a PVX-2580L, which has a C/120 rating of 305AH. Four of these batteries in series gives 4 x 12VDC = 48VDC.

CHAPTER 7 - SAFETY INFORMATION

There are four main safety hazards associated with the use of any valve regulated lead acid (VRLA) battery. These hazards are: a) Release of ignitable gas, b) Exposure to acid, c) Shorting of terminals, d) Thermal runaway. This chapter provides a description of each of these hazards and means to mitigate them.

7.1 Release of Ignitable Gasses

All lead acid batteries, including VRLA batteries, produce hydrogen and oxygen gases during normal charging. Even though VRLA batteries are designed to recombine these gases internally, the recombination efficiency is less than 100%. Small amounts of hydrogen and oxygen are released from the pressure relief valve during charging. Normally, the hydrogen gas dissipates very rapidly and never reaches a concentration level that is hazardous. However, if the battery is installed in an enclosure with minimal airflow, the concentration of hydrogen could build up to a high enough concentration to be of concern. Hydrogen can ignite at concentrations as low as 4% in air. **For this reason, never install a Sun Xtender® AGM battery in a sealed or an airtight container.**

7.2 Exposure to Acid

All lead acid batteries contain sulfuric acid in the electrolyte, which can cause chemical burns to body tissue. Although Sun Xtender® AGM batteries are classified as Nonspillable, exposure to the electrolyte is possible under extreme conditions (e.g., if the battery is cracked open or crushed). **In the event that electrolyte is displaced from the battery, avoid contact with the skin, eyes and clothing. In the event of an accident, flush with water and call a physician immediately.**

7.3 Shorting of Terminals

Sun Xtender® AGM batteries have very low internal impedance and therefore are capable of delivering high currents if the external terminals are short circuited. The resulting heat can cause severe burns and is a potential fire hazard. Accidentally placing metal objects across the terminals can result in severe skin burns. **It is a good practice to remove all metallic items such as belt buckles, watches, bracelets and rings when installing or servicing batteries. As a further precaution, insulating gloves should be worn and only insulated tools should be used when installing or servicing batteries.**

7.4 Thermal Runaway

Thermal runaway is a condition in which the battery temperature increases rapidly resulting in extreme overheating of the battery. Under rare conditions, the battery can melt, catch on fire, or even explode. Thermal runaway can only occur if the battery is at high ambient temperature and/or the charging voltage is set too high. As the battery accepts current, its internal temperature rises. The rise in temperature reduces the battery impedance, causing it to accept more current. The higher current further heats the battery, and so on, causing the battery temperature to “runaway.” An upper limit will eventually be reached when the electrolyte starts to boil, but once the electrolyte has boiled away, the temperature can climb even further to the point of plastic meltdown and possible fire.

As of this writing, Concorde does not know of any Sun Xtender® AGM batteries that have failed due to thermal runaway. **To preclude the possibility of thermal runaway, the charging instructions in Chapter 5 should be carefully followed, especially if the battery will be subjected to high ambient temperatures. Batteries should not be installed near heat sources or in direct sunlight that may artificially elevate their temperature. Also, there should be adequate air circulation around the batteries to prevent heat build-up.**

APPENDIX A – GLOSSARY OF BATTERY TERMS

- AGM** - Stands for Absorbed Glass Mat. This is the separator system used in all Sun Xtender® AGM batteries.
- Active Material** - Electrode material which produces electricity during its chemical conversion. In the positive plate it is lead dioxide. In the negative plate, it is sponge lead.
- Ampere** - Unit of electrical current abbreviated as amps or A.
Amps = Watts/Volts or $A = W/V$.
- Ampere Hour (Ah)** - The capacity of a storage battery is measured in ampere hours. One ampere hour is defined as a current flow of one ampere for a period of one hour. Five ampere hours means a current flow of one ampere for five hours, a current flow of 2 1/2 ampere for 2 hours, or any multiple of current and time that will result in five. This relationship can be expressed as follows:
Capacity (Ampere hours) = $I \cdot T$, where I is the current (in amperes) and T is the time (in hours). The capacity of a storage battery is based on a given discharge rate, since the capacity will vary with the rate of discharge.
- Battery** - Two or more chemical cells electrically connected together to produce electric energy. Common usage permits this designation to be applied also to a single cell used independently.
- Boost Charge** - A charge applied to a battery which is already near a state of full charge, usually of short duration.
- C/X Rate** - Discharge rate in amperes that will take X hours to fully discharge the battery. $C/1 = 1$ -hour rate, $C/120 = 120$ -hour rate, $C/0.5 = 1/2$ -hour rate (normally written as 2C).
- Capacity** - The quantity of electricity delivered by a battery under specified conditions, usually expressed in ampere hours.
- Capacity, Rated** - A designation by the battery manufacturer which defines the performance of a new battery at a defined rate of discharge. For Sun Xtender® AGM batteries, the rated capacity is based on the 24 hour rate.
- Capacity, Residual** - Capacity remaining at a particular point in time and operating conditions, usually at a partial state of charge condition.
- Case** - The battery box which contains the cells and associated internal connectors.
- Cell** - An electrochemical device composed of positive and negative plates, separator, and electrolyte which is capable of storing electrical energy. When encased in a container and fitted with terminals, it is the basic building block of the battery.
- Cell Reversal** - Reversing of polarity within a cell in a multi cell battery due to over discharge.
- Charge** - The conversion of electrical energy from an external source, into chemical energy within a cell or battery.
- Charge Rate** - The rate at which current is applied to a cell or battery to restore its capacity.
- Charge Retention** - The ability of a charged cell or battery to resist self discharge.
- Charge, State of** - Ratio of the amount of capacity remaining in a battery to the capacity when fully charged. A battery at 25% state of charge has 25% capacity remaining versus what it could give if fully charged.
- Charger** - Device capable of supplying electrical energy to charge a battery.

- Charging** - The process of converting electrical energy to stored chemical energy. The opposite of discharging.
- Charging Efficiency** - Ratio of the Ampere hours delivered on discharge to the Ampere hours needed to fully charge a battery.
- Conditioning** - A special constant current charge process used to restore a battery's capacity after extended storage periods or deep discharge exposure. Also known as reconditioning.
- Connector** - An electrically conductive bar or cable which joins individual cells together in a battery.
- Constant Current (CC) Charge** - Charging technique where the output current of the charge source is held constant. Warning! This procedure may damage the battery if performed on a repetitive basis.
- Constant Voltage (CV) Charge** - Charging technique where the output voltage of the charge source is held constant and the current is limited only by the resistance of the battery and / or the capacity of the charge source. Also known as Constant Potential (CP) charge.
- Container** - The bottom portion of the cell container (excluding the cover).
- Coulometer** - Electrochemical or electronic device, capable of integrating current and time to tally ampere-hours. Used for charge control.
- Counter EMF** - Voltage of a cell or battery opposing the voltage of the charging source.
- Current** - The rate of flow of electricity. The movement of electrons along a conductor. It is comparable to the flow of a stream of water. The unit of measurement is an ampere.
- Current Density** - The amount of electric current passing through a given cross-sectional area of a conductor in amperes per square inch, i.e: the ratio of the current in amperes to the cross-sectional area of the conductor.
- Cut Off Voltage** - Battery voltage reached at the termination of a discharge. Also known as end point voltage or EPV.
- Cycle** - One sequence of discharge and charge.
- Cycle Life** - The total number of charge/discharge cycles before the battery reaches end of life (generally 80% of rated capacity).
- Deep Discharge** - Withdrawal of more than 80% of the rated capacity.
- Depth Of Discharge** - The portion of the capacity taken out during a discharge, expressed as a percent of rated capacity.
- Discharge** - The conversion of the chemical energy of a cell or battery into electrical energy and withdrawal of the electrical energy into a load.
- Discharge rate** - The rate of current flow from battery, generally expressed in amperes.
- Duty Cycle** - The conditions and usage to which a battery is subjected during operation, consisting of discharge, charge, and rest periods.
- Electrode** - Conducting body in which active materials are placed and through which current enters or leaves cell.
- Electrolyte** - In a lead acid battery, the electrolyte is sulfuric acid diluted with water. It is a conductor and is also a supplier of hydrogen and sulfate ions for the reaction.
- Electromotive Force (EMF)** - Potential causing electricity to flow in a closed circuit. Measured in volts.
- End Of Discharge Voltage** - The voltage of the battery at the termination of a discharge but before the discharge is stopped. See End Point Voltage (EPV).

- End Of Life** - The stage at which the battery fails to deliver acceptable capacity (typically 50% of nameplate rating).
- End Point Voltage** - Voltage at which point the rated discharge capacity had been delivered at a specified rate of discharge. Also used to specify voltage below which the connected equipment will not operate or below which operation is not recommended. Sometimes called cutoff voltage or voltage end point.
- Energy** - Output capability, expressed as capacity times voltage, or Watt hours (Whr).
- Energy Conversion** - The change from chemical to electrical energy within the cell, or the reverse.
- Energy Density** - The ratio of battery energy to either the weight (Wh/lb or Wh/kg) or the volume (Wh/L or Wh/cu.in.).
- Environmental Conditions** - External circumstances to which a cell or battery may be subjected, such as ambient temperature, humidity, shock, and vibration.
- Equalization Charge** - A maintenance procedure consisting of a sustained overcharge used to correct cell imbalance.
- Fast charging** - Rapid return of energy to a battery at the C rate or higher.
- Float charge** - A method of maintaining a battery in a charged condition by continuous, long term, constant voltage charging at level sufficient to balance self-discharge.
- Flooded cell** - A cell design which incorporates an excess amount of electrolyte, also see Vented Cell.
- Gassing** - The evolution of gas from one or more of the electrode plates in a cell. Gassing commonly results from local action (self discharge) or from the electrolysis of water in the electrolyte during charging.
- High Rate Discharge** - Withdrawal of large amounts of current for short intervals of time from a battery, usually at a rate that will completely discharge a cell or battery in less than 1 hour.
- Internal Impedance** - Same as Internal Resistance.
- Internal Resistance** - The opposition or resistance to the flow of a direct electric current within a cell or battery; the sum of the ionic and electronic resistance of the cell components. Its value varies with the current, state of charge, temperature, and age. With an extremely heavy load, such as an engine starter, the cell voltage may drop significantly. This voltage drop is due to the internal resistance of the cell. A cell that is partly discharged has a higher internal resistance than a fully charged cell, hence it will have a greater voltage drop under the same load. This change in internal resistance is due to the accumulation of lead sulfate in the plates.
- Ion** - Part of a molecule or group of atoms, positively or negatively charged, which transports electricity through the electrolyte.
- Lead Acid** - Terms used in conjunction with a battery that utilizes lead and lead dioxide as the active plate materials in a diluted electrolyte solution of sulfuric acid and water.
- Lead Dioxide** - A higher oxide of lead present in charged positive plates and frequently referred to as lead peroxide (PbO₂).
- Lead Sulfate** - A lead salt formed by the action of sulfuric acid on lead oxide during paste mixing and formation. It is also formed electrochemically when a battery is discharged.
- Life** - The duration of satisfactory performance, measured as usage in years or as the number of charge/discharge cycles.
- Low Rate Discharge** - Withdrawal of small amounts of current for long periods of time from a battery.

- Migration** - Directed movement of an ion of the electrolyte under the influence of an electric field.
- Monobloc** - A battery assembly that contains multiple cells connected in series or parallel and housed in a single container.
- Negative Electrode** - See Negative Plate.
- Negative Plate** - The plate which has an electrical potential below that of the other plate during normal cell operation. Positive current flows to the negative plate during discharge.
- Nominal Voltage** - Equivalent to the number of cells in series in a battery times 2 volts per cell. A 6 cell battery has a nominal voltage of 12 volts.
- Open Circuit Voltage** - The voltage of a battery when it is not delivering or receiving power, and has been at rest long enough to reach a steady state (normally, at least 4 hours).
- Overcharge** - The forcing of current through a cell after all the active material has been converted to the charged state. In other words, charging continued after 100% state of charge is achieved. The result will be the decomposition of water in the electrolyte into hydrogen and oxygen gas, heat generation, and corrosion of the positive electrode.
- Oxygen recombination** - The process by which oxygen generated at the positive plate during charge reacts with the pure lead material of the negative plate and in the presence of sulfuric acid reforms water.
- Parallel connection** - Voltage stays the same, discharge rate and AH capacity are additive.
- Plate** - A grid or framework that gives mechanical support to the active materials of a cell. The combination is termed a pasted plate.
- Polarity** - The electrical term used to denote the voltage relationship to a reference potential (+).
- Positive Electrode** - See Positive Plate.
- Positive Plate** - The plate which has an electrical potential higher than that of the other plate during normal cell operation. Positive current flows from the positive plate during discharge.
- Power** - Rate at which energy is released or consumed (expressed in watts).
- Power Efficiency** - The proportion, expressed in percent, of energy recovered from a storage system, i.e: output power divided by input power.
- Rated Capacity** - See Capacity, Rated
- Rechargeable Secondary Cell or Battery** - A cell or battery which can be recharged many times after being discharged without appreciable depreciation of capacity.
- Recombination** - See Oxygen recombination.
- Resealable** - In a cell, pertains to a safety vent valve which is capable of closing after each pressure release, in contrast to the non resealable vent cap.
- Reversible Reaction** - A chemical change which takes place in either direction, as in the reversible reaction for charging or discharging a secondary battery.
- Sealed Cells** - Cells that are free from routine maintenance and can be operated without regard to position.
- Secondary Battery** - A system which is capable of repeated use by employing chemical reactions that are reversible, i.e., the discharged energy may be restored by supplying electrical current to recharge the cell.
- Self Discharge** - The decrease in the state of charge of a cell or a battery, over a period of time, due to internal electrochemical losses.

- Separator** - An insulating sheet or other device employed in a storage battery to prevent metallic contact between plates of opposite polarity within a cell.
- Series Connection** - Voltage of the system is cumulative. Capacity stays the same.
- Shelf Life** - The period of time (measured from date of manufacture) at a specified storage temperature after which the cell or battery needs to be boost charged so it does not suffer permanent capacity loss.
- Specific Energy** - The energy storage ability of a battery on a weight basis, usually expressed in watt hours per pound (or kilogram); sometimes given on a volume basis in watt hours per cubic foot (or liter).
- Starved Cell** - A cell containing little or no free fluid electrolyte solution; this enables gases to reach electrode surfaces readily, and permits relative high rates of recombination.
- State Of Charge (SOC)** - The available ampere hours in a battery at any given time relative to its full charge capacity.
- State Of Health (SOH)** - The available ampere hours in a battery when fully charged relative to its rated capacity.
- Sulfation** - Refers to the formation of hard lead sulfate crystals in the plates that are difficult, if not impossible, to reconvert to active material.
- Temperature, Ambient** - The average temperature of the battery's surroundings.
- Temperature, Cell** - The average temperature of the battery's internal components.
- Terminal** - An electrical conductor used in a battery to make electrical connection to external circuits for charging and discharging.
- Trickle Charging** - Method of charging in which the battery is either continuously or intermittently connected to a constant current charging source to maintain the battery in a fully charged condition. Not recommended for use with Sun Xtender® AGM batteries.
- Vent Valve** - A normally closed check valve located in a cell which allows the controlled escape of gases when the internal pressure exceeds its rated value.
- Venting** - A release of gas either controlled (through a vent) or accidental from a battery cell.
- Volt** - Unit of electromotive force, voltage or potential. The volt is the voltage between two points of a conductor carrying a constant current of one ampere, when the power dissipated between these points is one watt.
- Voltage Limit** - The upper limit of the charge voltage that is applied to the battery.

APPENDIX B – FREQUENTLY ASKED QUESTIONS (FAQ'S)

What does AGM stand for?

It stands for Absorbed Glass Mat, the type of separator used in all Sun Xtender® AGM batteries.

What is the difference between AGM batteries and Gel batteries?

Both AGM and Gel batteries utilize oxygen recombination and pressure relief valves to minimize water loss and allow maintenance-free operation. That is where the similarities end. AGM batteries have the advantage of being mountable in any orientation without capacity loss, have lower internal impedance to support high load currents, and have better capacity at low temperatures. Gel batteries must be mounted upright to prevent air pockets from forming that will burn out the plates. They have inferior performance at high discharge rates and low temperatures. Refer to Chapter 3 for further details.

Why should I choose Sun Xtender® AGM batteries?

Concorde has been supplying Sun Xtender® AGM batteries to the Renewable Energy Storage/ Solar Energy / Photovoltaic (PV) Industries for over 20 years, providing excellent performance, reliability and life. Applications include installations for telecommunications, village power, medical refrigeration, remote home, supervisory control & data acquisition, cathodic protection, telemetry, residential homes, aids to navigation [sea & air], lighting, and many more uses. With this long history and wide variety of successful applications, prospective customers are assured that Sun Xtender® AGM batteries have proven themselves over and over again.

What depth of discharge should be used when sizing a battery?

To get the best cycle life, the average depth of discharge should be as low as possible. Concorde recommends the average depth of discharge be no greater than 50% of the battery's 24 hour rating.

What is the maximum number of batteries that can be connected in parallel?

There is no theoretical limit to the number of batteries that can be connected in parallel. As more batteries are paralleled together, the risk of one faulty battery affecting the entire battery bank increases. Depending on the criticality of the application, there may be a need to isolate each battery or battery string for fault protection or to allow servicing of individual batteries. This can be accomplished by incorporating additional circuitry in the battery system that includes fuses, circuit breakers, or diodes. For more details on this subject, contact Concorde Battery for technical assistance.

Can Sun Xtender® AGM batteries be installed in sealed containers?

NO! Do not install Sun Xtender® AGM batteries in a sealed box or enclosure. During storage, charging, or discharging hydrogen gas can be released and must be ventilated to prevent the possibility of ignition and/or explosion.

What is the best way to charge my battery?

Charge with a 3 stage charger that compensates the voltage setting as the battery temperature changes. See Chapter 5 for further information.

What is the best charge voltage setting for outdoor applications if temperature sensing is not available?

NONE! Charging voltage varies widely depending on the battery's temperature and there is no single voltage that will work over a wide temperature range. Batteries will fail prematurely if this is attempted.

How can I tell if my battery is fully charged?

For a battery at room temperature, it can be considered fully charged when the charging current falls below 0.5A per 100Ah of rated capacity. The open circuit voltage (after at least 4 hours of rest) will be 2.17 volts per cell or higher (13.0 volts for a 12-volt battery), regardless of the battery temperature.

What causes some batteries to have convex or concave end walls?

Sun Xtender® AGM batteries contain a pressure relief valve (PRV) that prevents excessive pressure buildup when the battery is being charged, and automatically reseals once the pressure is released. A slight bulge in the battery container (convex end walls) can appear when the internal pressure is above the surrounding atmospheric pressure but not enough to open the PRV. Alternatively, the end walls can flex inward (concave end walls) when the internal pressure is less than surrounding atmospheric pressure. Both of these conditions are normal and do not affect the battery's operation.

How do I know when it is time to replace my battery?

Replace the battery when it no longer is capable of supporting the discharge load for the minimum required run time.

APPENDIX C – CHARTS AND GRAPHS

Battery Load Voltage vs. DOD

Below are listed the one hour, 8 hour, 24 hour and 120 hour load voltages during the discharge cycle from full charge to 100% discharge to 1.75V/cell or 10.5V (6 cells) at 25°C (77°F).

DOD (%)	1 hr. Rate	8 hr. Rate	24 hr. Rate	120 hr. Rate
10	12.23	12.60	12.65	12.69
20	12.16	12.51	12.55	12.58
30	12.07	12.39	12.42	12.45
40	11.96	12.25	12.28	12.32
50	11.83	12.11	12.15	12.18
60	11.70	11.98	12.02	12.05
70	11.55	11.79	11.83	11.88
80	11.38	11.59	11.61	11.65
90	11.15	11.32	11.34	11.40
100	10.50	10.50	10.50	10.50

Note that these voltages are averages and will vary slightly from battery to battery even of the same rating. They are, however, a good indicator of state of charge and can be used when setting low voltage alarms or disconnects for a Concorde AGM battery. Other battery types or manufacturers voltage vs. DOD may be substantially different. The data is for newer batteries with relatively few cycles. An older battery will measure a lower voltage for a given DOD.

SOC (%) vs. OCV

An easy method to estimate the State of Charge (SOC) of the battery is by measuring its Open Circuit Voltage (OCV). This measurement should be made after the battery has been at rest for a minimum of four hours with the battery shut off from its charging source and load. The voltage is listed as Volts/cell and for a 12V (6 cell) battery at 25°C (77°F).

State of Charge (%)	OCV per cell	OCV per 12V battery
100	2.13 or greater	12.8 or greater
75	2.08	12.5
50	2.03	12.2
25	1.98	11.9
0	1.93 or less	11.6 or less

These voltage levels are approximate and give an indication of the state of charge of a battery at rest. As the battery ages these voltage measurements will be lower.

Self Discharge Characteristics

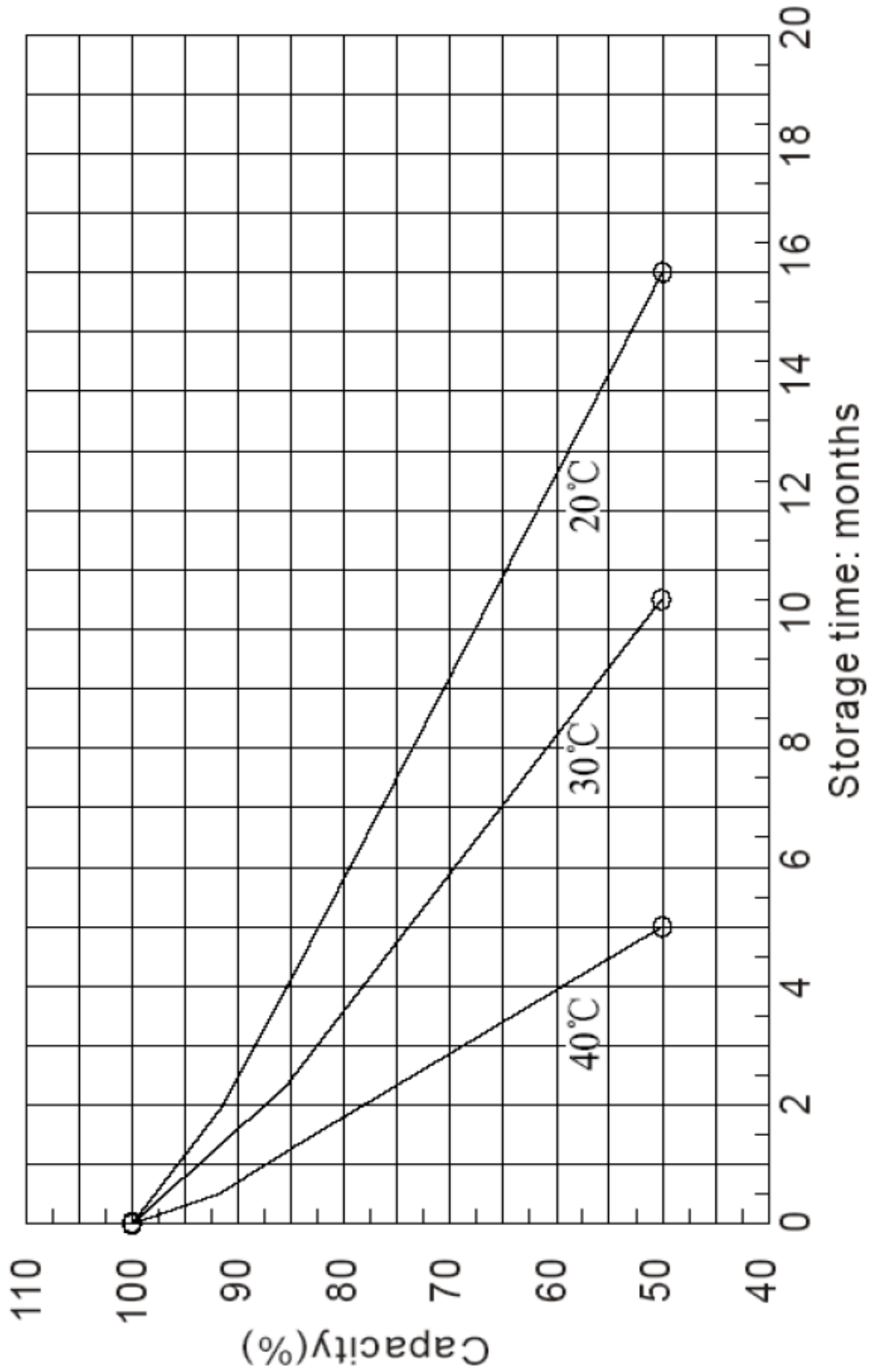

Concorde Battery Corporation, 2009 San Bernardino Rd., West Covina, CA 91790 www.concordebattery.com Phone 626-813-1234

Discharge Curves at Various Rates
 T = 25C (77F)

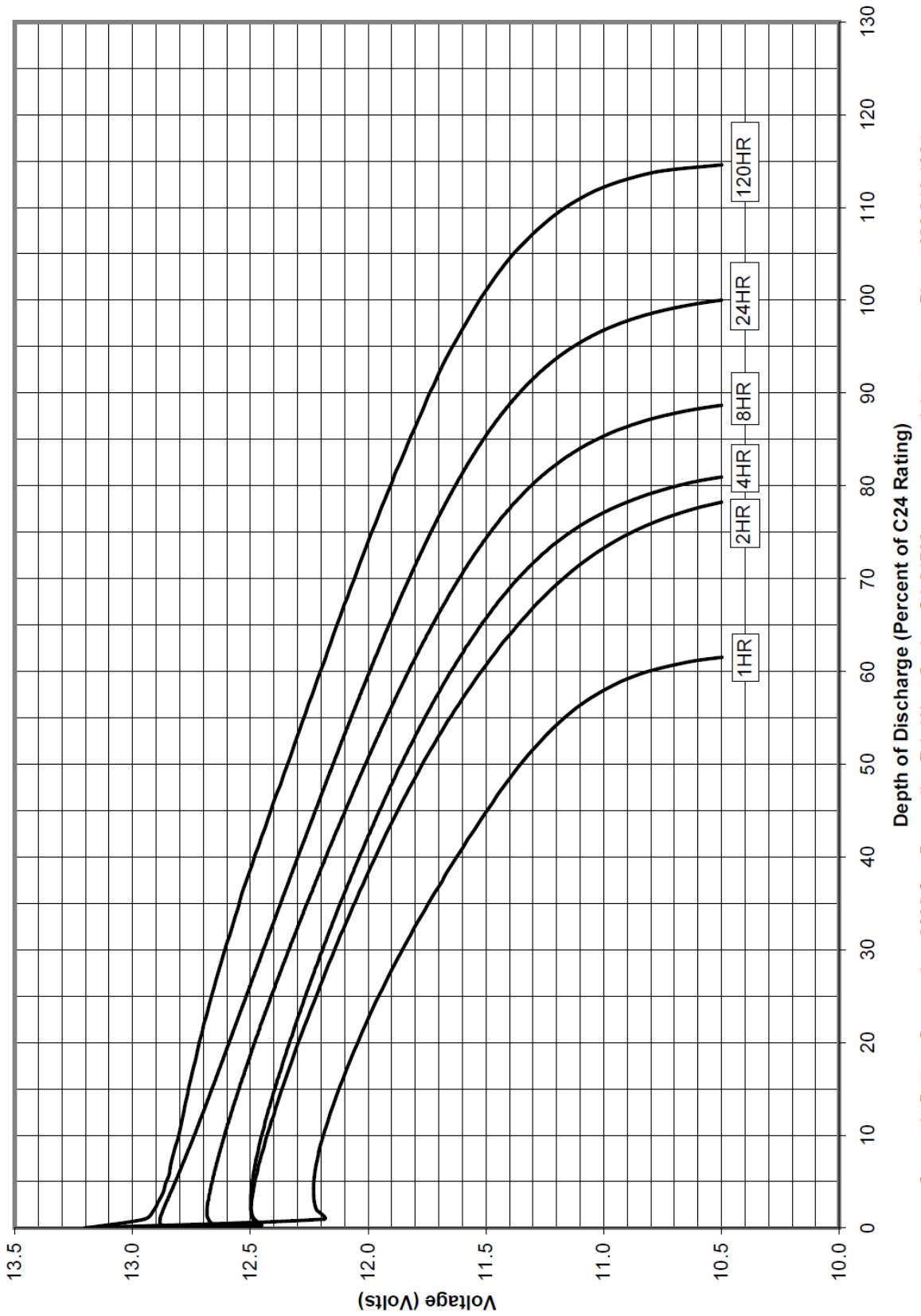

Concorde Battery Corporation, 2009 San Bernardino Rd., West Covina, CA 91790 www.concordebattery.com Phone 626-813-1234

Peukert Plot for PVX Series 12-Volt Models

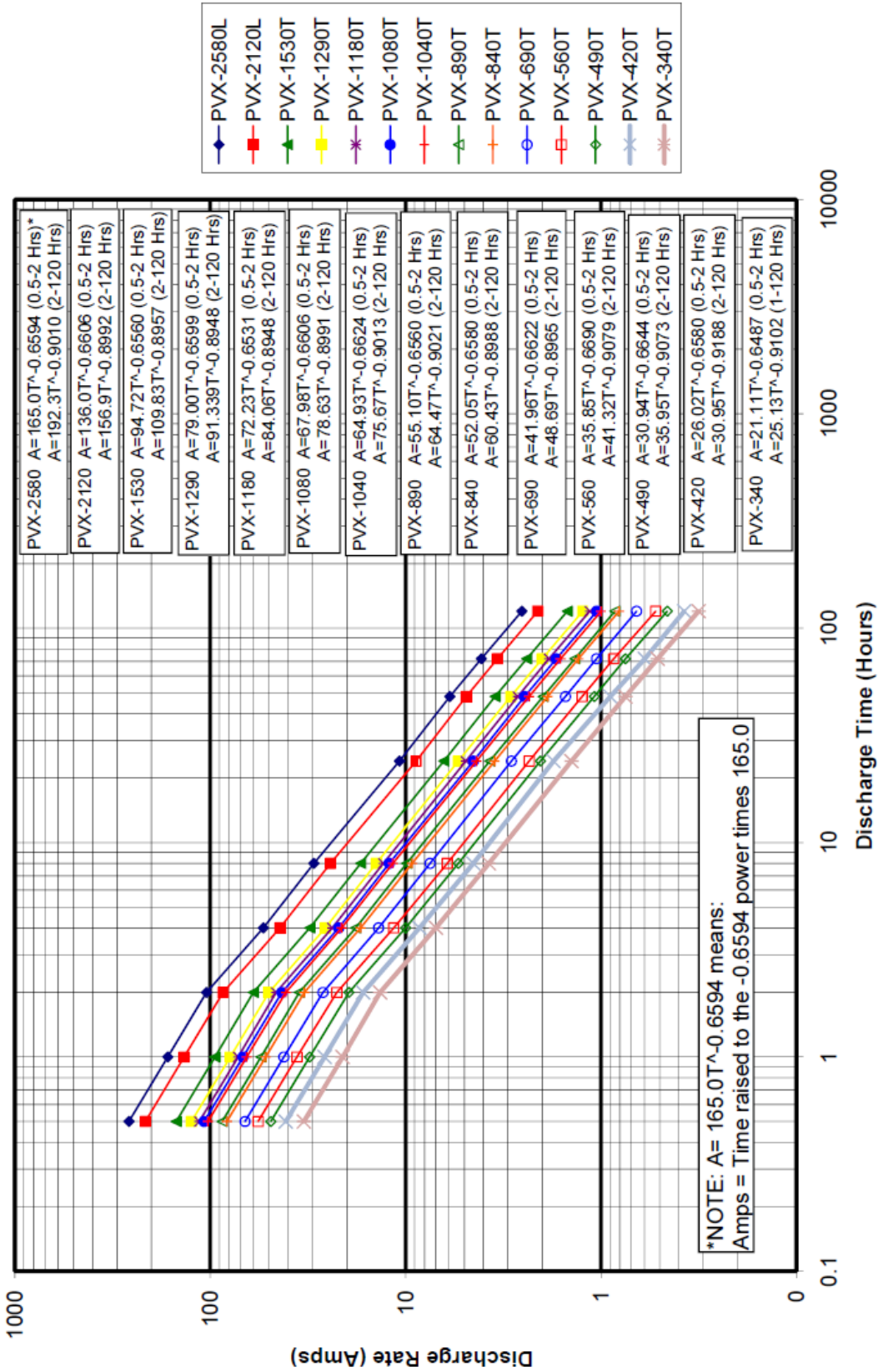

Copyright © Concorde Battery Corporation 2014

Peukert Plot for PVX Series
6-Volt Models

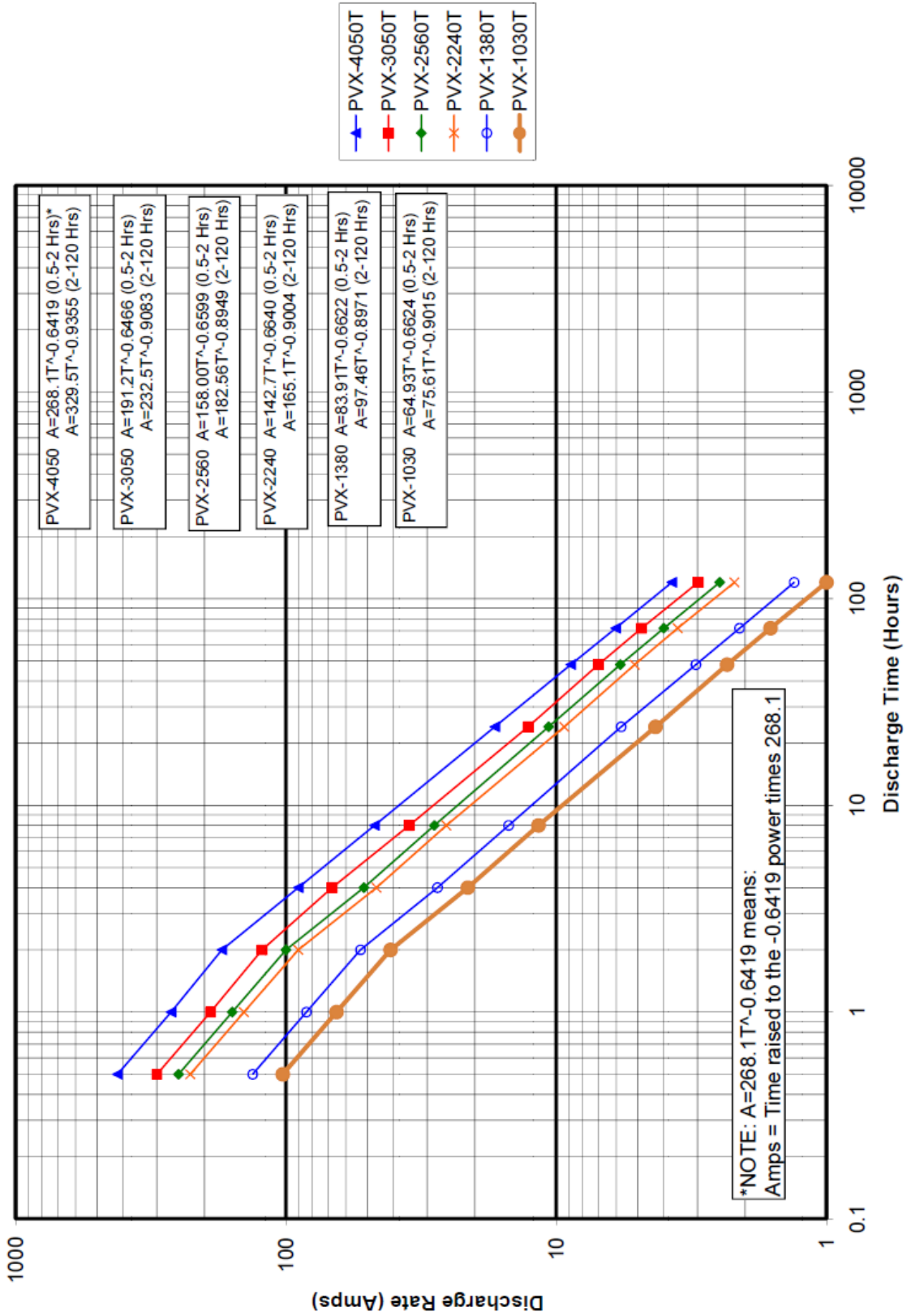

Peukert Plot for PVX Series
2-Volt Models

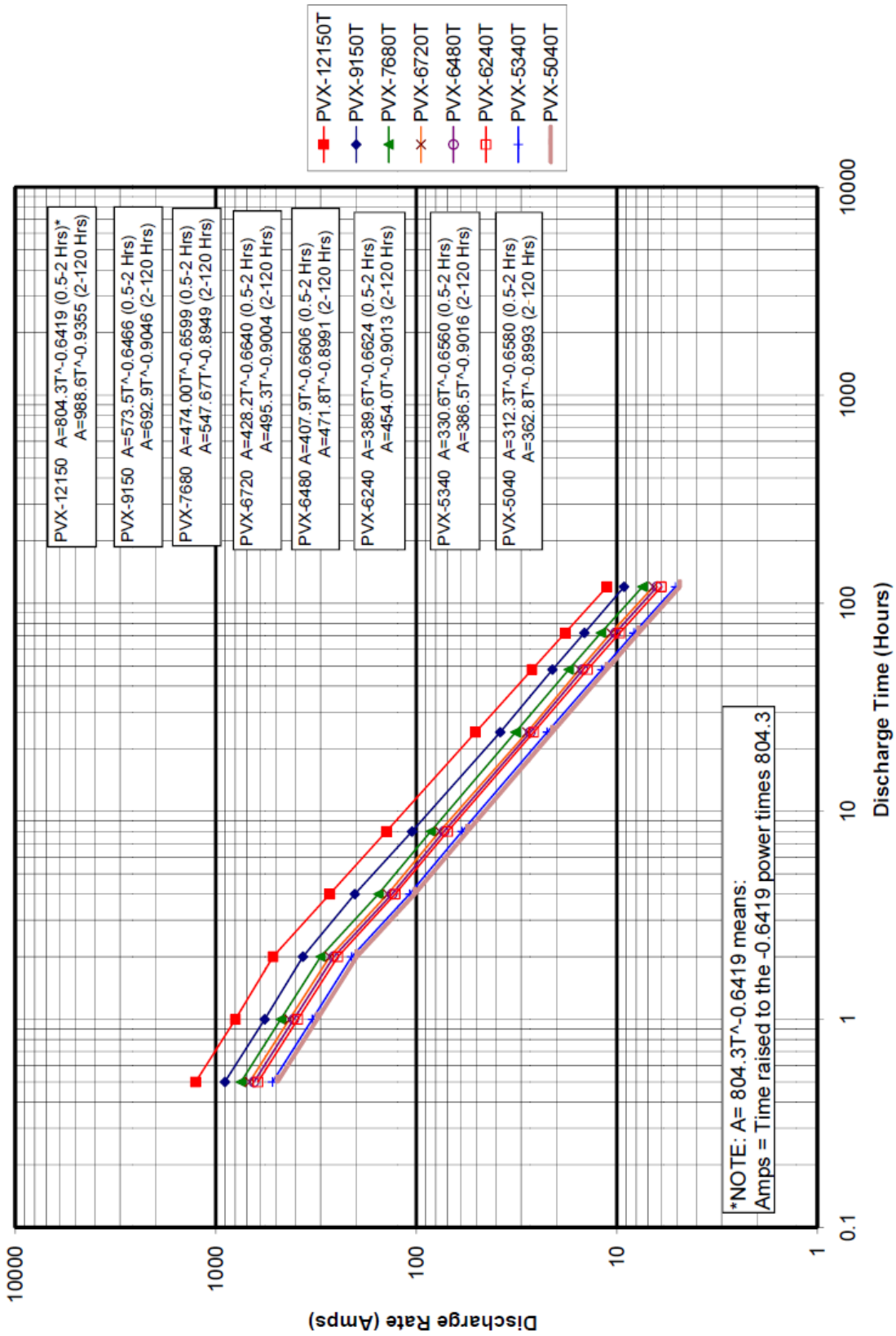

Copyright © Concorde Battery Corporation 2014

Concorde Battery Corporation, 2009 San Bernardino Rd., West Covina, CA 91790 www.concordebattery.com Phone 626-813-1234

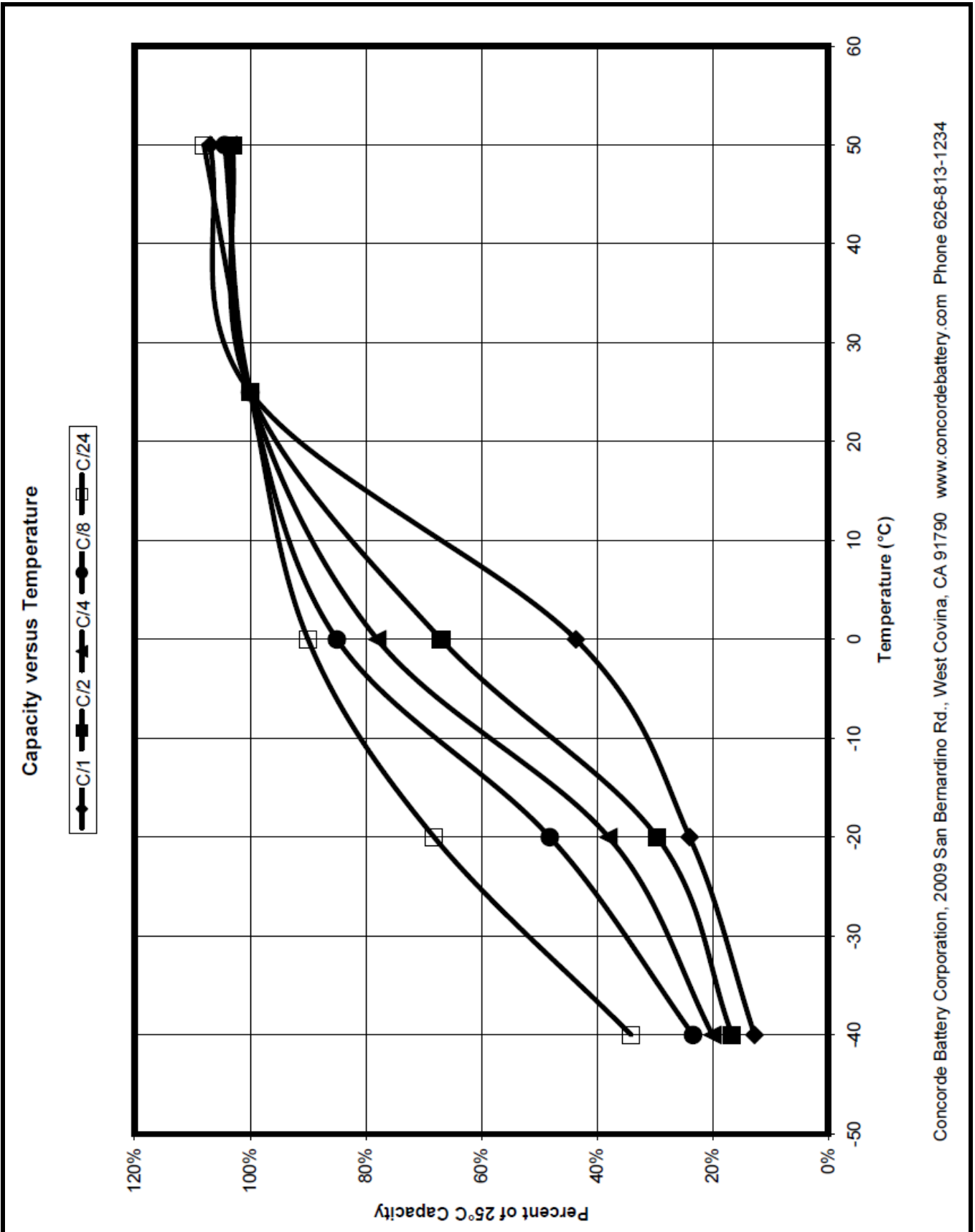

Concorde Battery Corporation, 2009 San Bernardino Rd., West Covina, CA 91790 www.concordebattery.com Phone 626-813-1234

Copyright © Concorde Battery Corporation 2014

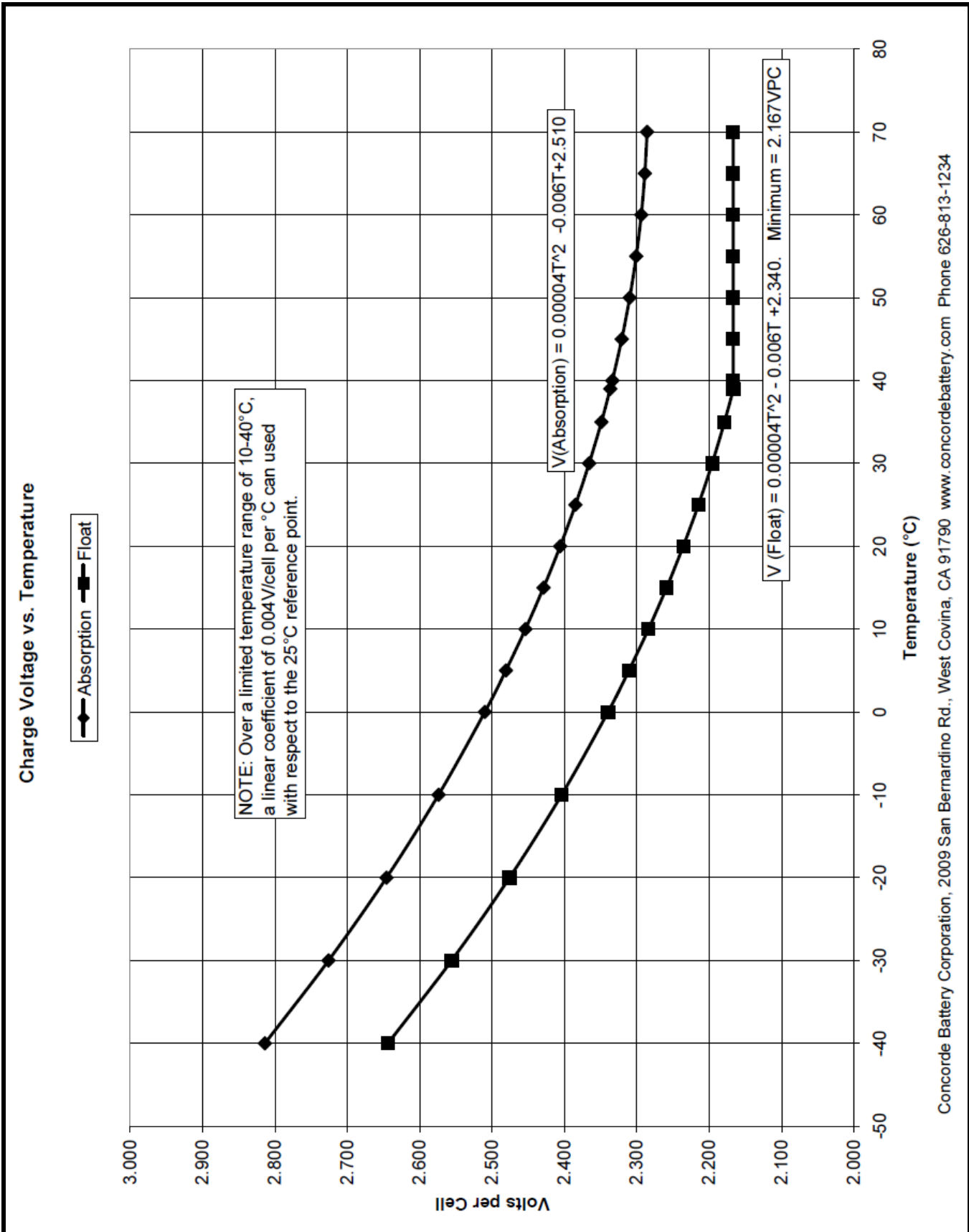

Concorde Battery Corporation, 2009 San Bernardino Rd., West Covina, CA 91790 www.concordebattery.com Phone 626-813-1234

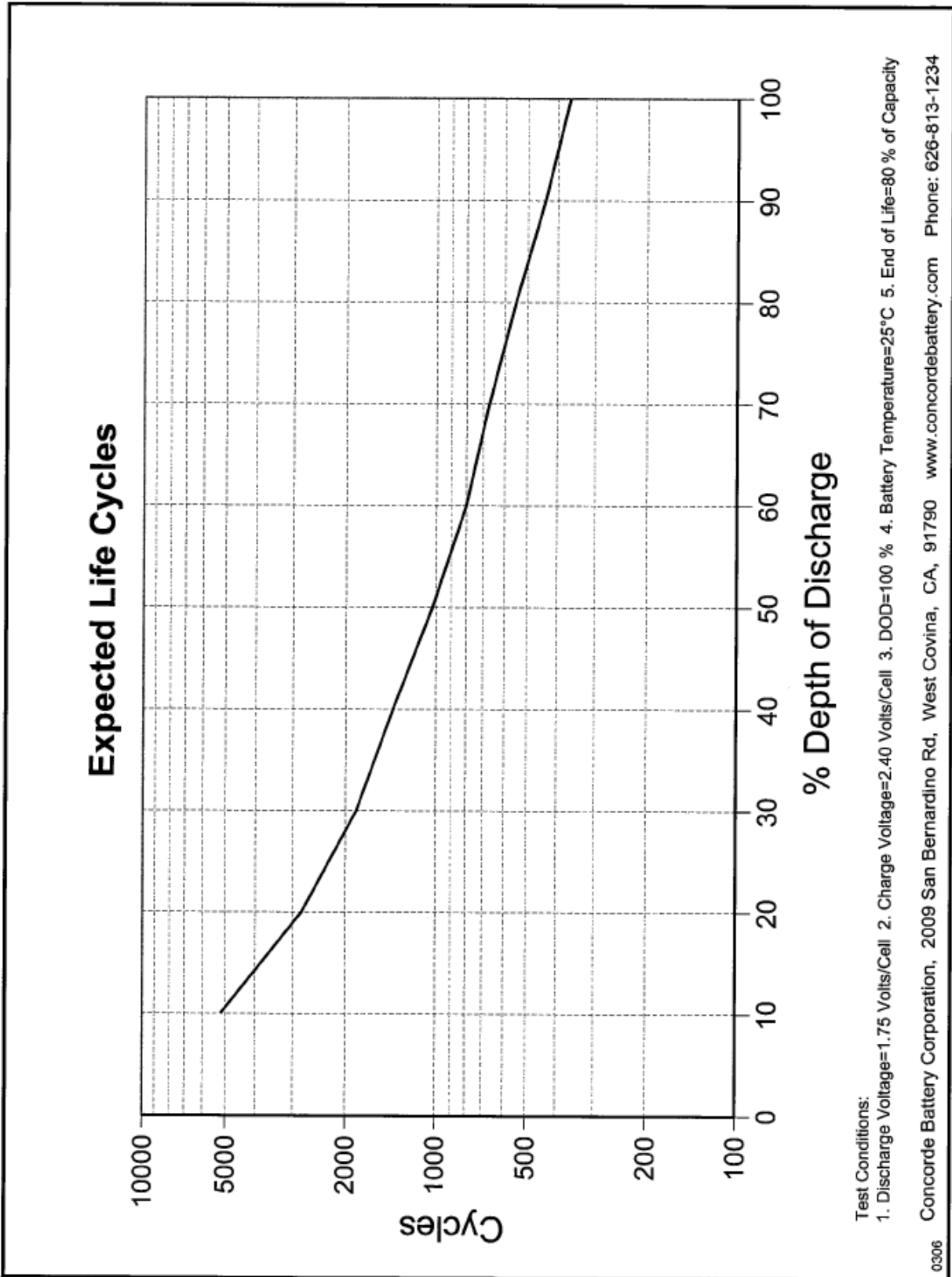

Copyright © Concorde Battery Corporation 2014