

Wall Mounting Template

Rev 001

Applicable to:

- ScreenBeam 1100Plus (Catalog #SBWD1100P)

Arranging screws horizontally

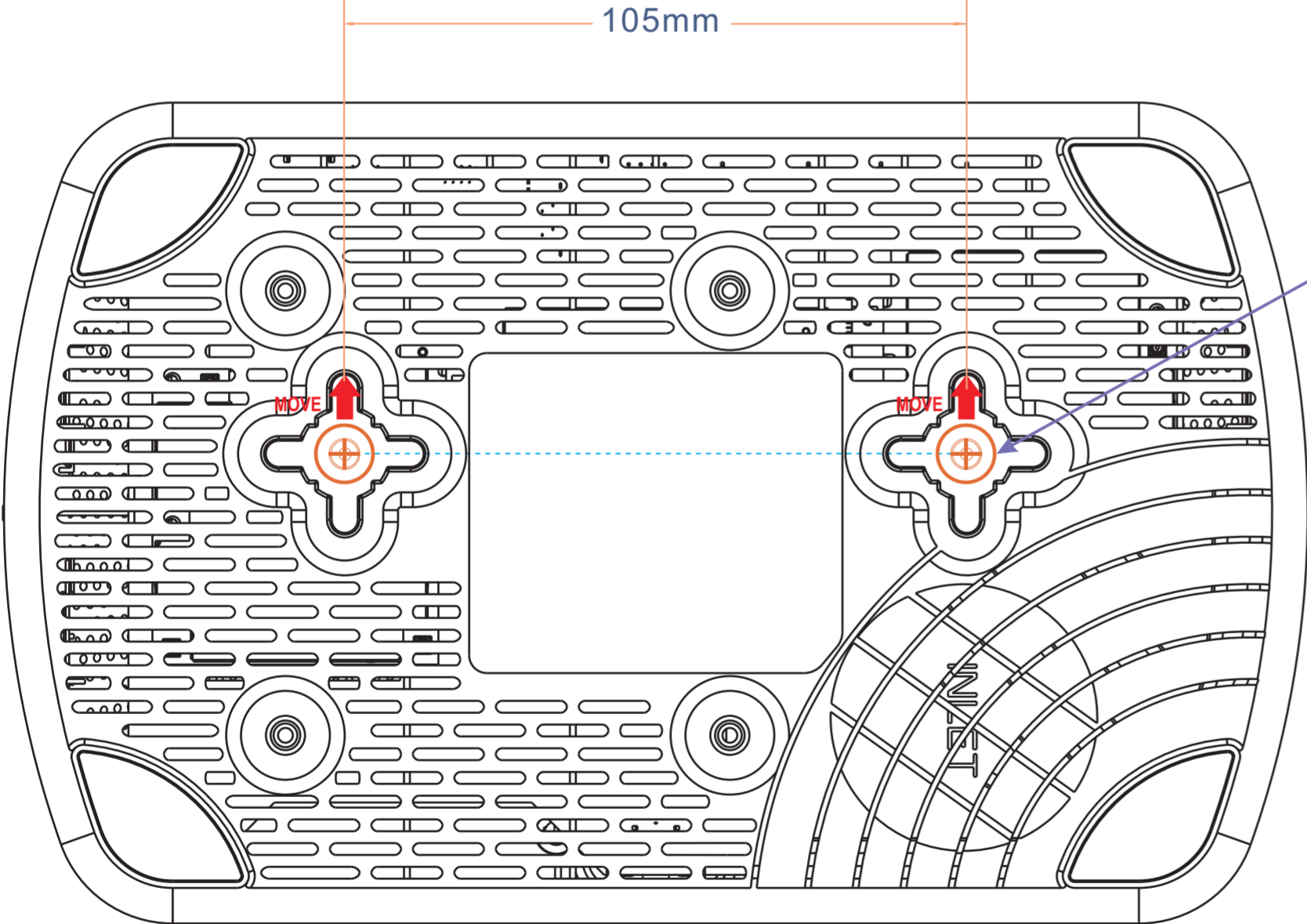

Arranging screws vertically

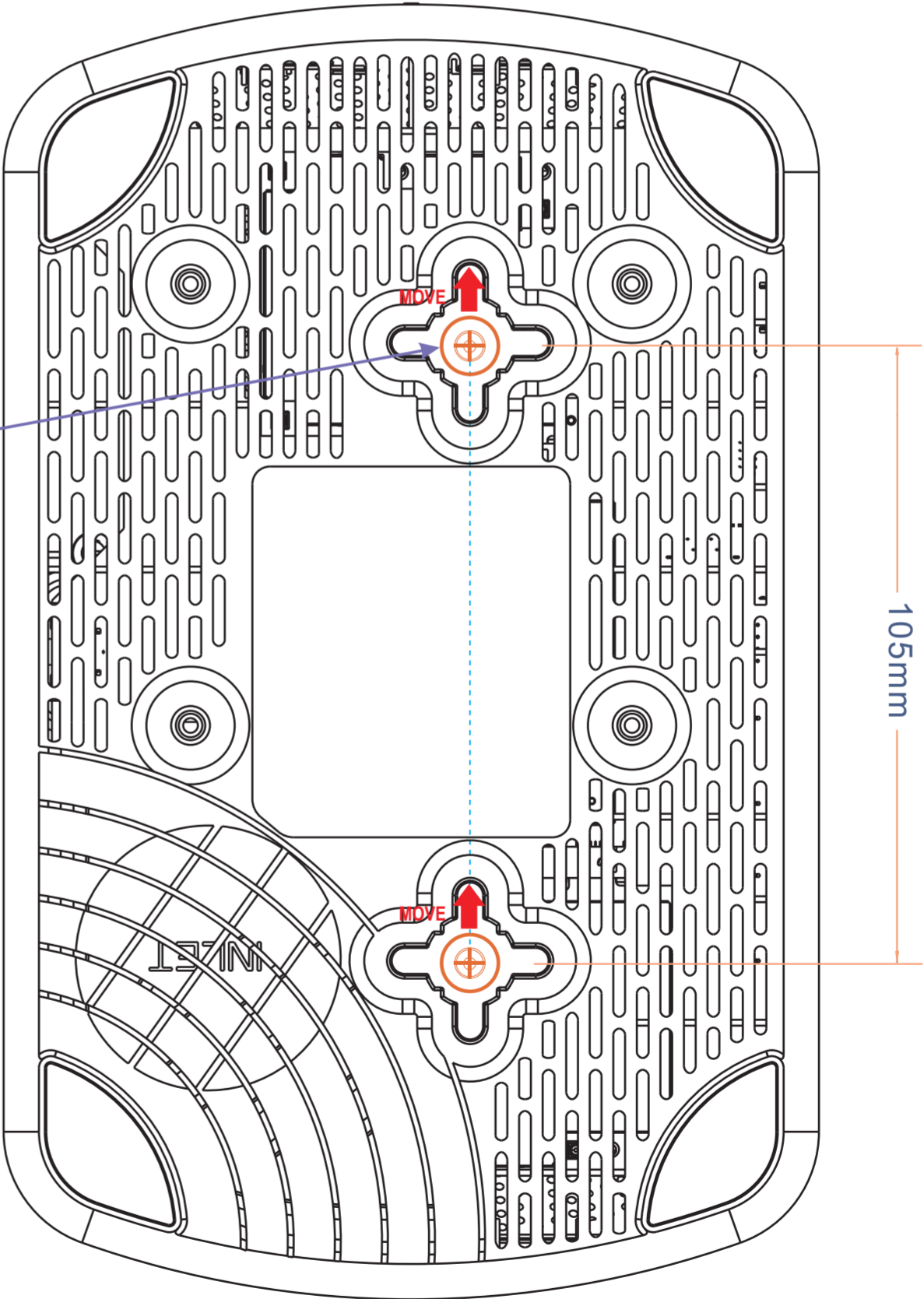

1. Place the template on the wall in the position the receiver will be mounted.
2. Mark the mounting holes. If mounting on wood, drill holes for the screws. If mounting on drywall, drill holes to accept drywall anchors.
3. Leave screws extended about 3mm from the wall.
4. Locate the receiver keyhole openings over the screw heads and push down lightly on the receiver to lock it onto the screws.

#6 screw specification

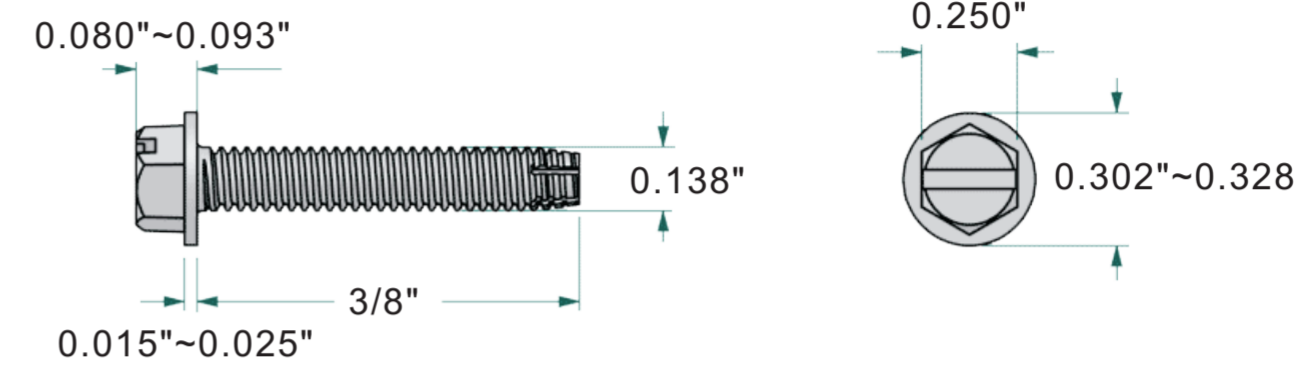

Arranging screws horizontally

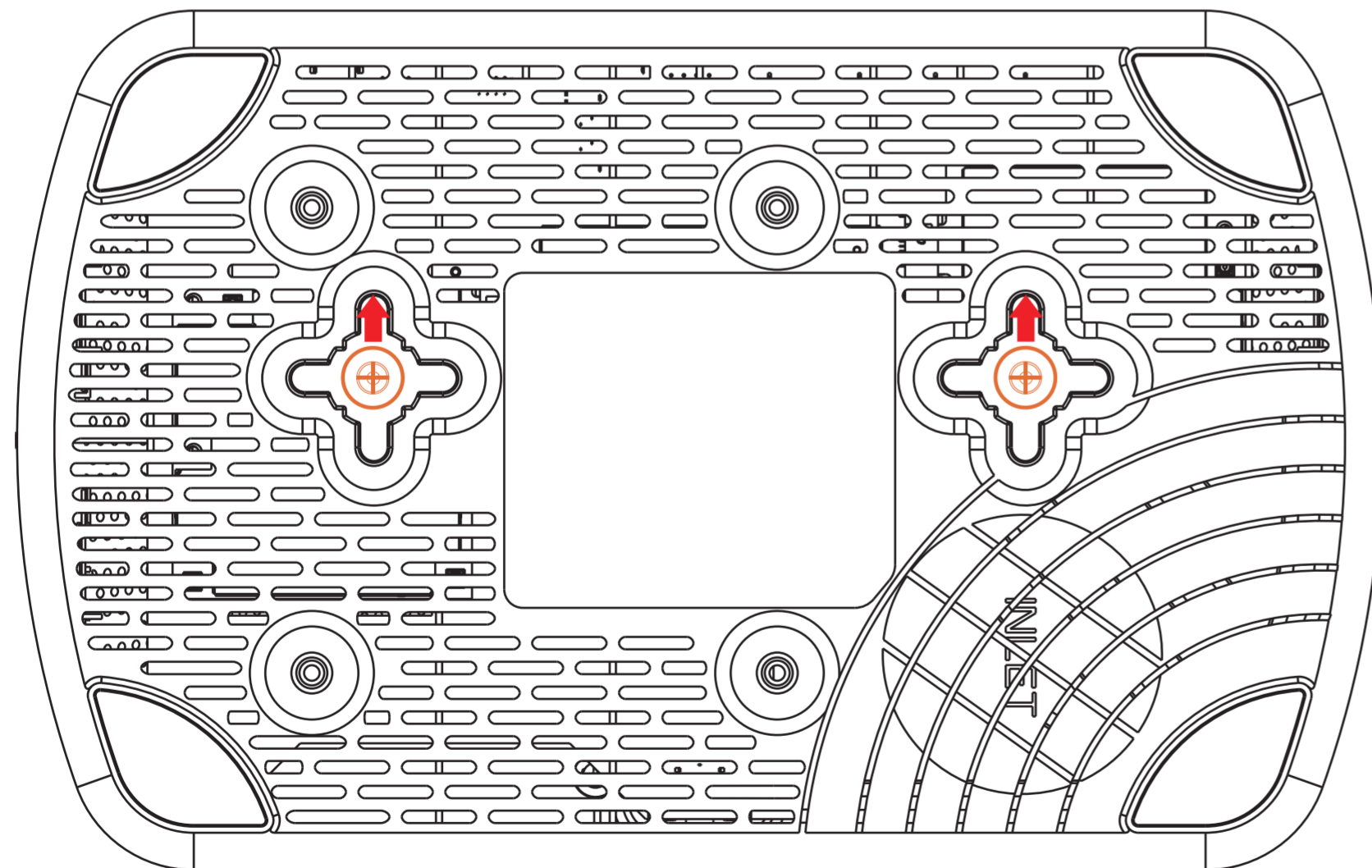

Illustrations Not to Scale

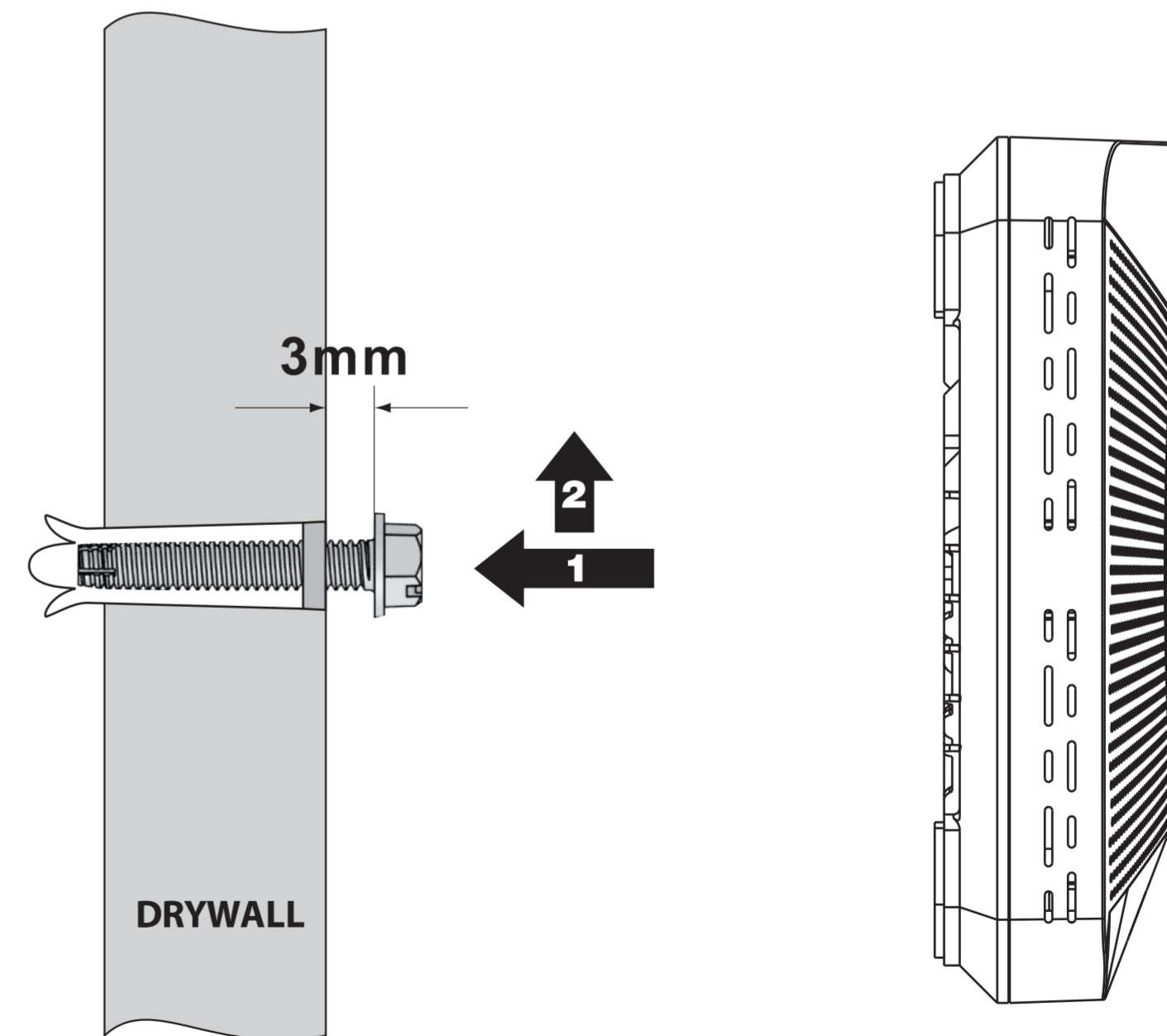

Arranging screws vertically

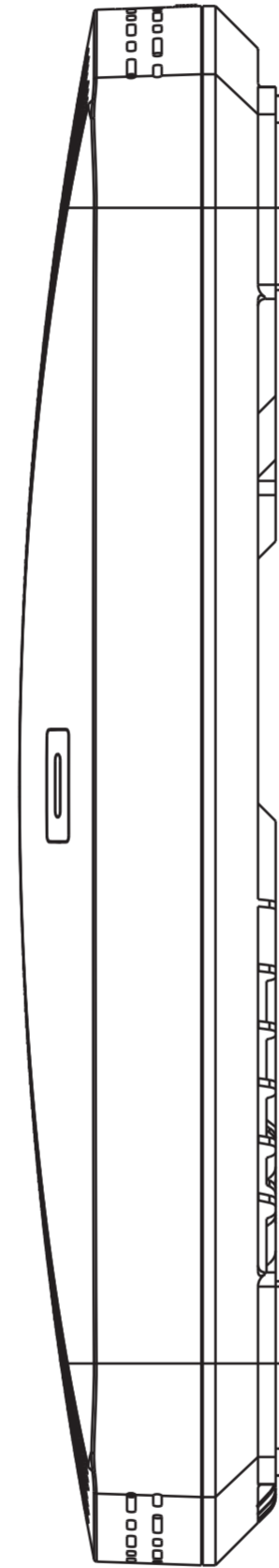
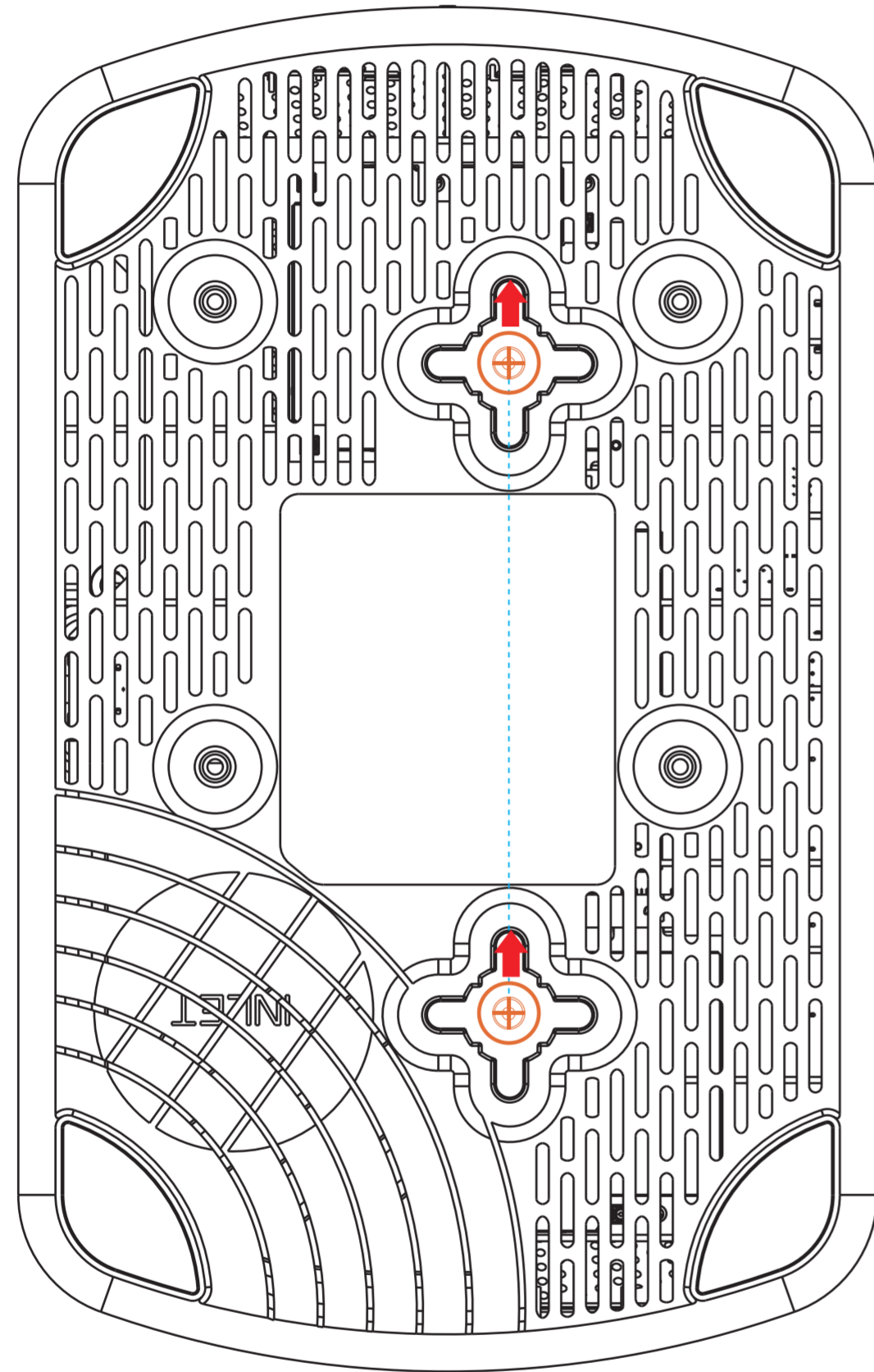

Illustrations Not to Scale

