

**Specifications**

Nominal Voltage		12 V
Capacity (25°C)	10HR(10.8V)	78 Ah
	5HR(10.5V)	68.5Ah
	1HR(9.60V)	48.4Ah
Dimension	Length	350±2mm (13.78inch)
	Width	167±2mm (6.57inch)
	Height	179±2mm (7.05inch)
	Total Height	T5: 186±2mm (7.32inch) T9: 179±2mm (7.05inch)
Approx. Weight		23kg (50.7lbs)±4%
Terminal type		T5/T9
Internal resistance (Fully charged, 25°C)		Approx. 5mΩ
Capacity affected by temperature (10HR)	40°C	102%
	25°C	100%
	0°C	85%
	-15°C	65%
Self-discharge (25°C)	3 month	Remaining Capacity: 91%
	6 month	Remaining Capacity: 82%
	12 month	Remaining Capacity: 65%
Nominal operating temperature		25°C±3°C (77°F±5°F)
Operating temperature range	Discharge	-15°C~50°C (5°F~122°F)
	Charge	-10°C~50°C (14°F~122°F)
	Storage	-20°C~50°C (-4°F~122°F)
Float charging voltage(25°C)		13.50 to 13.80V Temperature compensation: -18mV/°C
Cyclic charging voltage(25°C)		14.50 to 14.90V Temperature compensation: -30mV/°C
Maximum charging current		23.4A
Terminal material		Copper
Maximum discharge current		750A(5 sec.)
Designed floating life(20°C)		7~10 years

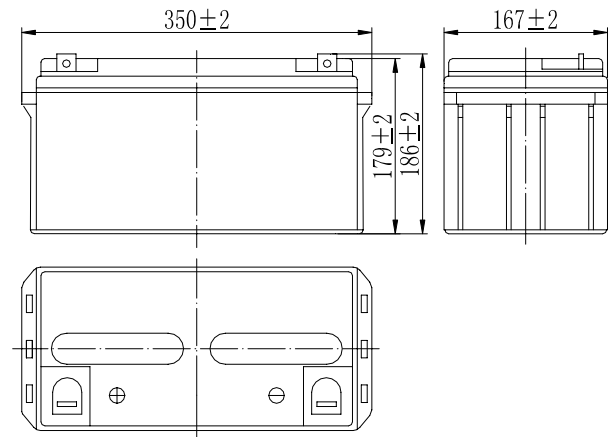

**Dimensions**



**Terminal**

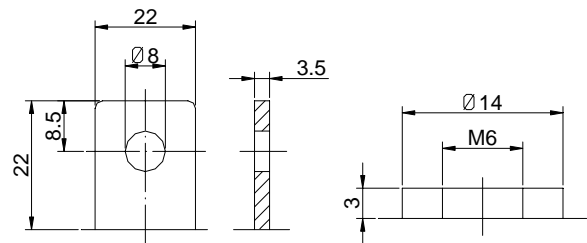

Terminal T5

Terminal T9

- ◆ Absorbent glass mat technology;
- ◆ Recognized by UL & CE;
- ◆ ABS container.

**Constant Current Discharge Characteristics (A, 25°C)**

F.V/TIME	10min	15min	30min	60min	2h	3h	4h	5h	8h	10h	20h
9.60V	164	129	78.0	48.4	28.5	19.9	16.3	13.9	9.55	7.94	4.17
9.90V	159	126	76.4	47.6	28.3	19.8	16.2	13.8	9.49	7.92	4.16
10.2V	152	121	74.1	46.4	28.1	19.6	16.1	13.7	9.43	7.90	4.15
10.5V	146	117	72.3	45.5	27.7	19.5	16.0	13.7	9.36	7.85	4.12
10.8V	138	111	69.7	44.1	27.0	18.9	15.5	13.2	9.08	7.80	4.10

**Constant Power Discharge Characteristics (Watt, 25°C)**

F.V/TIME	10min	15min	30min	60min	2h	3h	4h	5h	8h	10h	20h
9.60V	1769	1413	875	551	330	234	192	165	113	94.8	50.0
9.90V	1716	1379	858	543	328	233	191	164	113	94.6	49.9
10.2V	1645	1328	831	529	325	231	189	162	112	94.3	49.8
10.5V	1574	1283	811	519	320	229	188	161	111	93.8	49.5
10.8V	1486	1215	782	503	312	222	182	157	108	93.1	49.1

Note: The above characteristics data can be obtained within three charge/discharge cycles.

**Discharge Characteristics(25°C)**

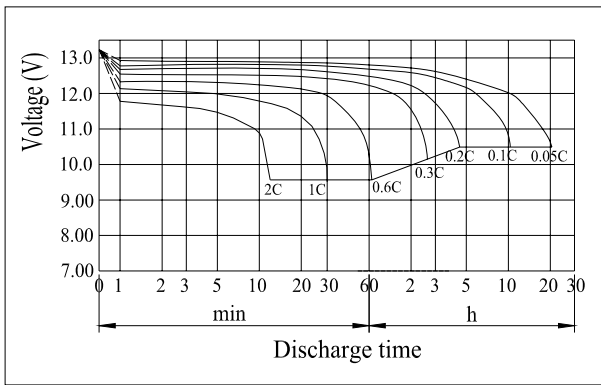

**Charging Characteristics(25°C)**

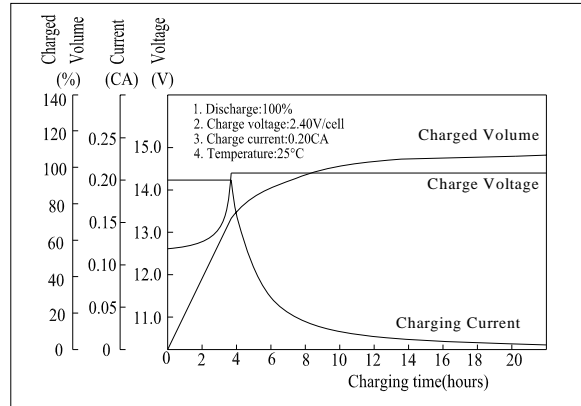

**Effect of Temperature on Capacity**

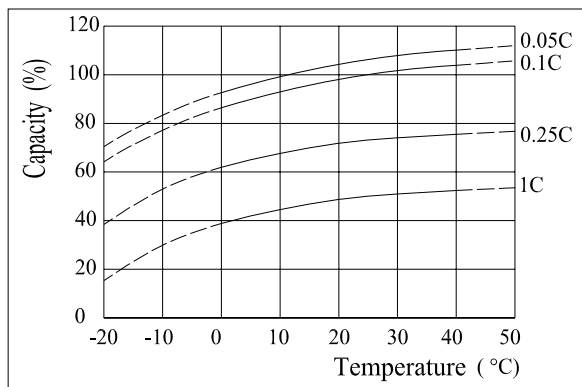

**Self-discharge Characteristics**

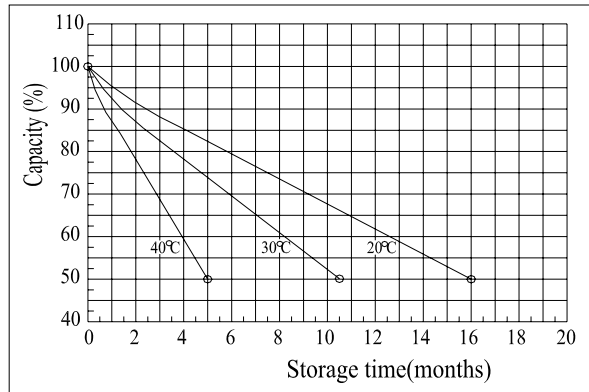

**The Relationship for Open Circuit Voltage and Residual Capacity (25°C)**

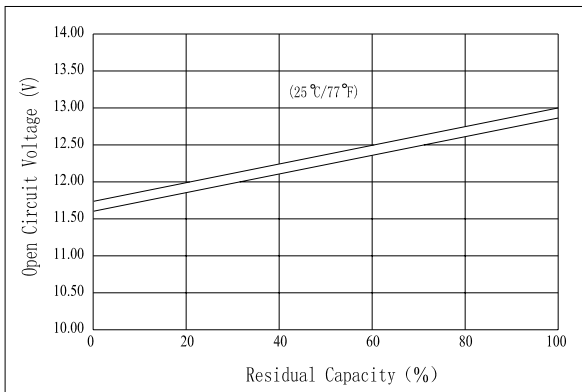

**The Relationship for Charging Voltage and Temperature**

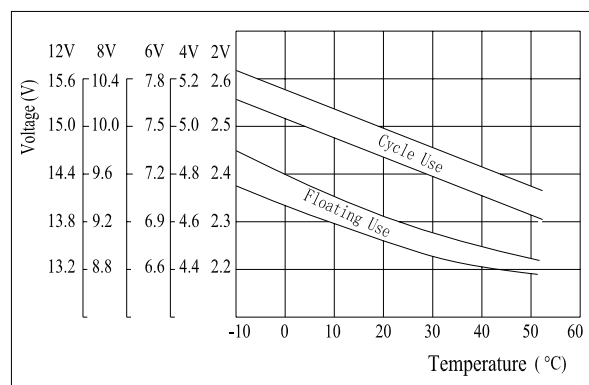

**Floating Life on Temperature**

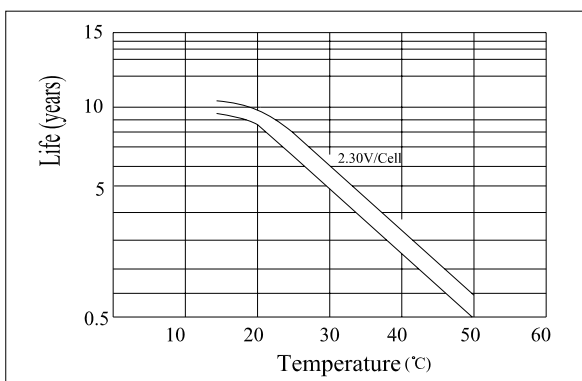

**Cycle Life on D.O.D(25°C)**

