

Specifications

Nominal Voltage		6 V
Capacity (25°C)	20HR(5.25V)	4.5Ah
	10HR(5.25V)	4.2Ah
	1HR(4.80V)	2.93Ah
Dimension	Length	70±1mm (2.76inch)
	Width	47±1mm (1.85inch)
	Height	101±1mm (3.98inch)
	Total Height	107±1mm (4.21inch)
Approx. Weight		0.73kg (1.61lbs)±5%
Terminal type		T1
Internal resistance (Fully charged, 25°C)		Approx. 25mΩ
Capacity affected by temperature (20HR)	40°C	102%
	25°C	100%
	0°C	85%
	-15°C	65%
Self-discharge (25°C)	3 month	Remaining Capacity: 91%
	6 month	Remaining Capacity: 82%
	12 month	Remaining Capacity: 65%
Nominal operating temperature		25°C±3°C (77°F±5°F)
Operating temperature range	Discharge	-15°C~50°C (5°F~122°F)
	Charge	-10°C~50°C (14°F~122°F)
	Storage	-20°C~50°C (-4°F~122°F)
Float charging voltage(25°C)		6.80 to 6.90V Temperature compensation: -9mV/°C
Cyclic charging voltage(25°C)		7.25 to 7.45V Temperature compensation: -15mV/°C
Maximum charging current		1.35A
Terminal material		Copper
Maximum discharge current		67.5A(5 sec.)
Designed floating life(20°C)		3~5 years

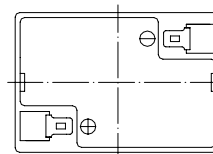

Dimensions

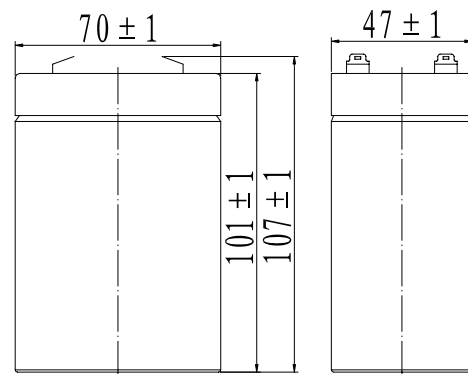

Terminal

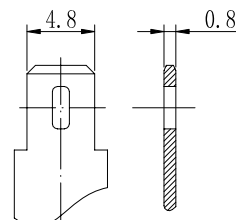

Terminal T1

- ◆ Absorbent glass mat technology;
- ◆ Recognized by UL & CE;
- ◆ ABS container.

Constant Current Discharge Characteristics (A, 25°C)

F.V/TIME	5min	10min	15min	30min	60min	2h	3h	4h	5h	10h	20h
4.80V	17.1	10.8	8.55	4.77	2.93	1.60	1.15	0.92	0.78	0.42	0.228
4.95V	16.6	10.5	8.34	4.67	2.88	1.59	1.14	0.91	0.78	0.42	0.227
5.10V	15.9	10.0	8.04	4.53	2.81	1.58	1.13	0.91	0.77	0.42	0.226
5.25V	15.2	9.61	7.76	4.42	2.75	1.55	1.13	0.90	0.77	0.42	0.225
5.40V	14.4	9.07	7.35	4.26	2.67	1.51	1.09	0.87	0.74	0.41	0.221

Constant Power Discharge Characteristics (Watt, 25°C)

F.V/TIME	5min	10min	15min	30min	60min	2h	3h	4h	5h	10h	20h
4.80V	95.4	60.9	48.7	27.3	16.9	9.35	6.82	5.47	4.66	2.55	1.37
4.95V	92.6	59.1	47.6	26.8	16.7	9.30	6.78	5.43	4.63	2.54	1.36
5.10V	88.7	56.6	45.8	26.0	16.3	9.21	6.73	5.40	4.60	2.53	1.36
5.25V	84.9	54.2	44.3	25.3	15.9	9.08	6.68	5.36	4.57	2.51	1.35
5.40V	80.2	51.2	41.9	24.4	15.4	8.85	6.48	5.20	4.43	2.46	1.32

Note: The above characteristics data can be obtained within three charge/discharge cycles.

Discharge Characteristics(25°C)

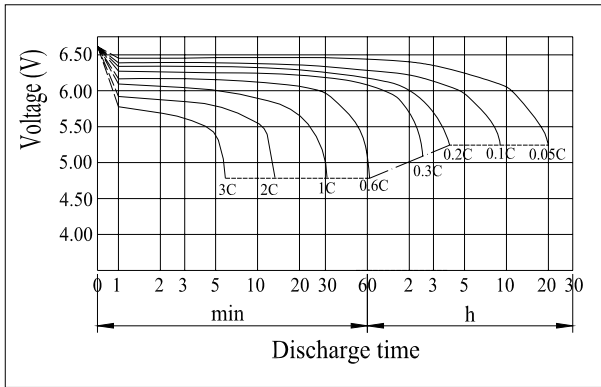

Charging Characteristics(25°C)

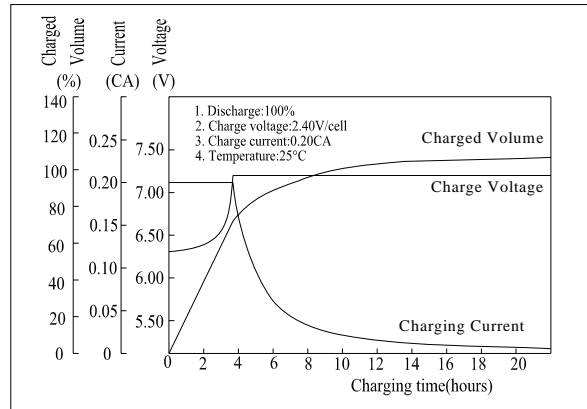

Effect of Temperature on Capacity

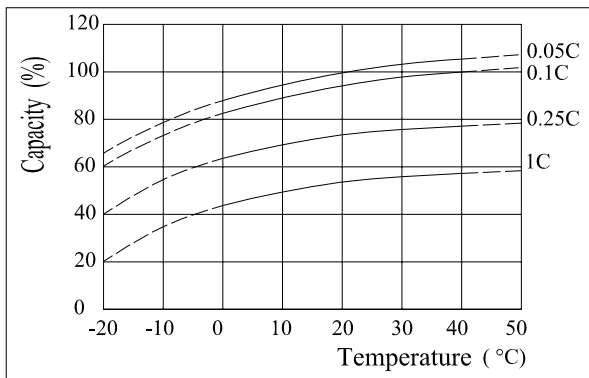

Self-discharge Characteristics

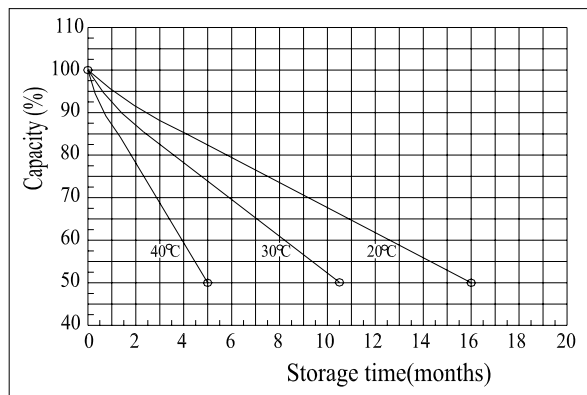

The Relationship for Open Circuit Voltage and Residual Capacity (25°C)

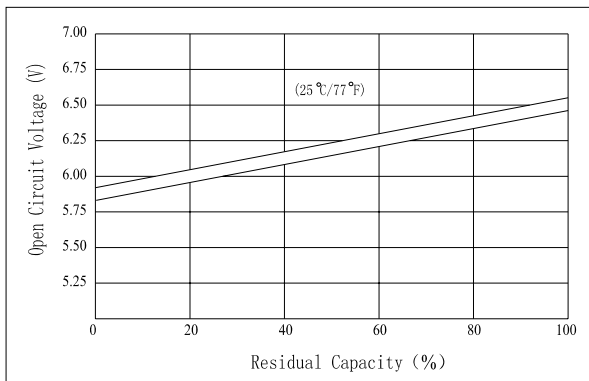

The Relationship for Charging Voltage and Temperature

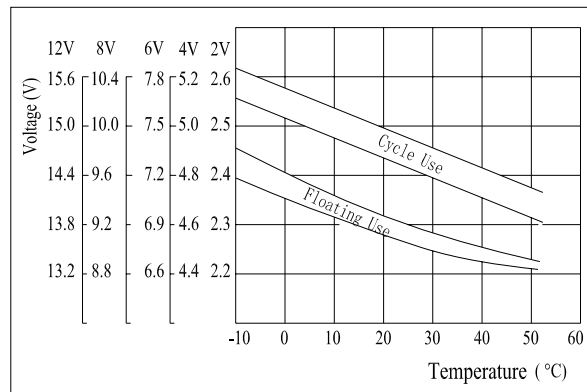

Floating Life on Temperature

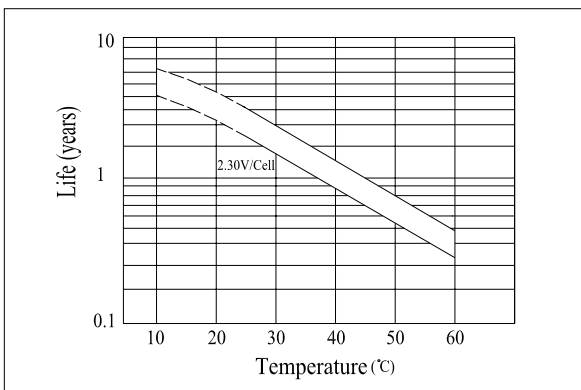

Cycle Life on D.O.D(25°C)

