

# CleanWave<sup>®</sup>

## Sanitizing Bagless Vacuum

Reduce Germs and Deodorize<sup>§</sup>  
While You Vacuum<sup>†</sup>



## Owner's Manual

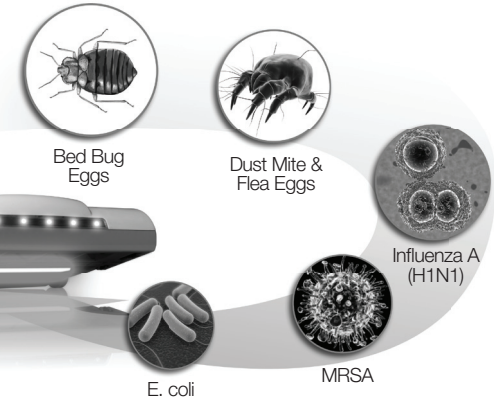

Bed Bug  
Eggs

Dust Mite &  
Flea Eggs

Influenza A  
(H1N1)

E. coli

MRSA

Model: VH04WW1

Due to ongoing improvements, actual product may have slight variations from the product described in this manual.

<sup>†</sup> Based on exposure of UV-C light to bed bug eggs, viruses and bacteria in the laboratory under controlled conditions. May be less effective when used on pile carpets and certain fabric surfaces. UV-C effectiveness depends on direct exposure duration and intensity and must shine on organism to be effective. In the event of bed bug infestation, a qualified pest exterminator should be contacted.

<sup>§</sup> Deodorization based on UV-C reduction of odor-causing bacteria and HEPA filtration.

Job#:	Title: VH04 Manual
Date: 10/16/11	Version: VH04-MAN-Rev23

# Table of Contents

Dear Customer,

Thank you for purchasing the Verilux CleanWave® Sanitizing Bagless Vacuum. You have received an innovative and quality manufactured product backed by a five year limited warranty.

Many other healthy lighting products are available through our catalog and online. Visit us on the web at [www.verilux.com](http://www.verilux.com) to request a free catalog and learn more about all our quality Verilux products, or call us toll-free at 1-800-454-4408.

As a Verilux customer, your satisfaction means everything to us. We look forward to serving you now and in the future.

Have a bright day!

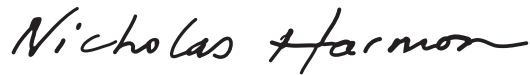

Nicholas Harmon  
President, Verilux, Inc.

- 1. Important Safeguards . . . . . 3
- 2. CleanWave® Sanitizing Bagless Vacuum . . . . . 6
  - 2.1 Introduction . . . . . 6
  - 2.2 Special Functions . . . . . 6
- 3. Carton Contents . . . . . 7
- 4. Features . . . . . 8
  - 4.1 Vacuum Canister . . . . . 8
  - 4.2 Handle and Hose . . . . . 9
  - 4.3 Sanitizing Power Head . . . . . 10
  - 4.4 Telescoping Wand . . . . . 11
  - 4.5 Accessories . . . . . 11
  - 4.6 Spare Parts . . . . . 11
- 5. Assembly . . . . . 16
  - 5.1 Connecting the Hose . . . . . 12
  - 5.2 Connecting the Telescoping Wand . . . . . 13
  - 5.3 Connecting the Sanitizing Power Head . . . . . 13
- 6. CleanWave Sanitizing Bagless Vacuum Operation . . . . . 14
  - 6.1 Handle . . . . . 14
  - 6.2 Cord Release / Rewind . . . . . 14
  - 6.3 Canister . . . . . 15
  - 6.4 Handle and Hose . . . . . 15
  - 6.5 Sanitizing Power Head . . . . . 15
  - 6.6 Operating Modes . . . . . 16
  - 6.7 Using the Accessories . . . . . 18
- 7. Care and Maintenance . . . . . 19
  - 7.1 How to Empty . . . . . 19
  - 7.2 Cleaning and Replacing Filters . . . . . 20
  - 7.3 HEPA-12 Pre-Filter . . . . . 20
  - 7.4 Sponge Filter . . . . . 21
  - 7.5 HEPA-12 Exhaust Filter . . . . . 21
  - 7.6 Replacement Filters . . . . . 21
  - 7.7 Cleaning and Replacing the Sanitizing Light Bulb . . . . . 22
  - 7.8 Sanitizing Light Bulb Disposal . . . . . 23
  - 7.9 Replacement Parts . . . . . 24
    - 7.9a-b Replacing the Wheels and Stand-up Locks . . . . . 24
    - 7.9c Replacement Part List . . . . . 25
- 8. Troubleshooting . . . . . 26
- 9. Five Year Limited Warranty . . . . . 28

# 1. Important Safeguards

## READ ALL INSTRUCTIONS BEFORE USING

### **▲ DANGER:**

- Do not operate this device near a water source to avoid electrocution.
- Always direct the UV-C light AWAY from the eyes and skin. Direct prolonged exposure of eyes or skin to the UV-C light bulb can cause serious skin burn and eye inflammation from short wave ultraviolet radiation. Radiation from these lamps is harmful to the eyes and skin.
- Application of UV-C light to existing mold growth can cause respiratory irritation and allergic symptoms. Do not use UV-C light where active mold growth exists. Remove active mold growth from surface prior to exposure. Ultraviolet (UV-C) Radiation Hazard.

### **▲ WARNING:**

- Do not use outdoors or on wet surfaces.
- Do not allow to be used as a toy. Close attention is needed when used by or near children.
- Do not handle plug or appliance with wet hands.
- Keep all openings away from your face and body.
- Do not use to vacuum flammable or combustible liquids such as gasoline or use in areas where they may be present.
- Do not touch the UV-C bulb during or directly after use; it will be hot and may burn.
- Do not use with damaged cord or plug. Do not use vacuum if it has been dropped, damaged, left outdoors or dropped in water.
- DO NOT point the vacuum cleaner directly at your or anyone's face.
- The bulb in this product contains a trace amount of mercury, a chemical known to the state of California to cause birth defects or other reproductive harm. This substance may also cause injury if inhaled or ingested.
- No serviceable parts. Refer all servicing to qualified service personnel. Servicing is required when the apparatus is damaged in any way, such as power supply cord or plug is damaged, liquid has been spilled or objects have fallen into the apparatus, the apparatus has been exposed to rain or moisture, does not operate normally or has been dropped.
- Never use this device on pets.
- Allow bulb to cool before replacing.

### **▲ CAUTION:**

- Do not leave appliance when plugged in. Unplug from outlet when not in use and before servicing.
- With prolonged use, UV-C light may degrade, discolor and/or bleach fabrics, plastic and rubber. Safety features are included to help ensure surface damage does not occur. Do not override these features.

Job#:	Title: VH04 Manual
Date: 10/16/11	Version: VH04-MAN-Rev23

## 1. Important Safeguards – continued

### **▲ CAUTION:** – continued

- Do not attempt to pick up large or sharp objects as these may cause damage to the vacuum cleaner.
- Do not use the vacuum cleaner without dust filter in place.
- Use only as described in this manual. Use only with manufacturer's recommended attachments.
- Do not pull or carry cord, use cord as a handle, close a door on cord or pull cord around sharp edges or corners.
- Do not leave appliance when plugged in. Unplug from outlet when not in use and before servicing.
- Do not run vacuum over cord. Keep cord away from heated surfaces.
- Do not unplug by pulling on cord. To unplug, grasp the plug, not the cord.
- Do not put any object into openings. Do not use with any openings blocked; keep free of dust, lint, hair and anything that may reduce air flow.
- Keep hair, loose clothing, fingers and all body parts away from openings and moving parts.
- Do not vacuum anything that is burning or smoking, such as cigarettes, matches or hot ashes.
- Turn off vacuum before unplugging.
- Use extra care when cleaning on stairs.
- Follow all labels and instructions.
- Store the vacuum cleaner indoors. Put the vacuum cleaner away after use to prevent tripping accidentally.
- Using improper voltage may result in damage to the motor and possible injury to the user. The correct voltage is listed on the rating label.
- Use on dry, indoor surfaces.
- Do not use for any purpose other than described in this manual.
- Always turn off this appliance before connecting or disconnecting the UV-C base unit.
- All repairs must be carried out by a qualified service technician.
- There are a number of safety switches on the underside of the unit. These switches prevent the UV-C bulb from activating when the product is removed from the cleaning surface. The UV-C bulb will re-activate when placed back on a cleaning surface.
- For your safety, DO NOT attempt to manually override the safety switch.
- Do not leave product unattended while on.
- Care should be taken to prevent bulb breakage.

# 1. Important Safeguards – continued

## **⚠ CAUTION:** – continued

- Use only Verilux® bulbs. Use of an incorrect bulb can result in damage. To order a replacement bulb, use the Component Reorder form included with this product, or call Verilux Customer Service at 1-800-786-6850 or visit [www.verilux.com](http://www.verilux.com).
- Dispose of bulbs per local regulations. For more information on clean-up and disposal, see [www.lamprecycle.org](http://www.lamprecycle.org).



## SAVE THESE INSTRUCTIONS

### **⚠ DANGER**

Direct prolonged exposure of eyes or skin to the UV-C light bulb can cause serious skin burn and eye inflammation from short wave ultraviolet radiation. Radiation from these lamps is harmful to the eyes and skin.

### **⚠ DANGER** POTENTIAL MOLD SPORE RELEASE

Application of UV-C light to existing mold growth can cause respiratory irritation and allergic symptoms. Do not use UV-C light where active mold growth exists. Remove active mold growth from surfaces prior to exposure.

Job#:	Title: VH04 Manual
Date: 10/16/11	Version: VH04-MAN-Rev23

## 2. CleanWave® Sanitizing Bagless Vacuum

### 2.1 Introduction

Your new Verilux® CleanWave Sanitizing Bagless Vacuum is both a convenient and powerful vacuum with Ultraviolet (UV-C) Light Technology that destroys up to 99.9% of viruses, odor causing bacteria, certain molds and other allergens and even pest eggs like bed bug, flea and dust mite eggs, while you vacuum†‡§

### 2.2 Special Functions

Your new Verilux CleanWave Sanitizing Bagless Vacuum features include:

- Significantly reduces germs and deodorizes§ while you vacuum†
- Combats certain molds and allergens without chemicals or liquids‡
- Safely sanitizes surfaces without irritants\* or residues†
- Laboratory proven to eliminate up to 99% of H1N1 and MRSA in 1 second†
- Specially designed floor sensor safety switches that prevent direct exposure to UV-C light. **Note:** do not override these floor sensor safety switches.
- Powerful suction quickly and efficiently lifts and removes dust, dirt and debris from floors, carpets and rugs into generous 1.5-liter capacity, bagless canister
- The HEPA-12 multi-stage filtration system traps pollen, certain allergens and large and small particles and prevents recirculation of pollutants
- Won't warp, dull or damage flooring\*
- Variable suction speed control slide adjusts desired level of suction to suit energy-saving, decibel, fabric and fiber treatment preferences
- Includes accessories for tight spaces, corners, stairs, lamps, blinds, drapes and upholstery
- Telescoping wand with an ergonomic handle, power and suction controls, lets you adjust its length for height and reach preferences
- Offers 3 modes of operation so you can engage the Powered Brush Roller, the Sanitizing Light or both
- Built-in safety feature turns off the sanitizing light when sanitizing power head is held or left stationary for more than 5 seconds preventing direct exposure to UV-C light and assuring your vacuum is always safe to operate
- Easy-access controls are right on top of the power head for smooth transitions from carpets to bare floors or from only vacuuming to vacuuming and sanitizing
- Snap-in, replaceable filters and parts require no tools
- Perfect for use on carpets and all types of hard floors.

† Based on exposure of UV-C light to bed bug eggs, viruses and bacteria in the laboratory under controlled conditions. May be less effective when used on pile carpets and certain fabric surfaces. UV-C effectiveness depends on direct exposure duration and intensity and must shine on organism to be effective. In the event of bed bug infestation, a qualified pest exterminator should be contacted.

‡ Based on exposure of UV-C light to test organisms in laboratory on non-porous hard surface, under controlled conditions. MRSA refers to Methicillin Resistant Staphylococcus Aureus (ATCC 33592). H1N1 refers to A/Swine/Iowa Swine Influenza A (ATCC 333)

§ Direct UV-C Light exposure is effective on certain allergen producing organisms such as Mold A and reduces dust mites. HEPA-12 filtration can trap pet dander and mold spores.

\* When used as directed.

§ Deodorization based on UV-C reduction of odor-causing bacteria and HEPA filtration.

### 3. Carton Contents

Remove all parts from the carton and identify each item as shown below. Make sure all items are removed before recycling the packaging material.

1. Sanitizing Power Head
2. Vacuum Canister
3. Handle and Hose
4. Telescoping Wand
5. Crevice Tool, Dusting Brush and Upholstery Tool
6. Spare Power Head Rear Wheels (2), Spare Stand-up Locks (2)
7. Owner's Manual, Other Literature

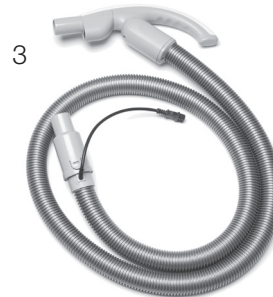

Job#:	Title: VH04 Manual
Date: 10/16/11	Version: VH04-MAN-Rev23

## 4. Features

### 4.1 Vacuum Canister

1. ON/OFF Switch
2. Suction Control Slider
3. Low Airflow Indicator
4. Canister Handle
5. Retractable Power Cord
6. Cord Rewind Button
7. Dirt Cup
8. Release Latch
9. Canister Inlet
10. Canister Power Receptacle
11. Sponge Filter
12. HEPA-12 Pre-Filter
13. Cone Filter
14. HEPA-12 Exhaust Filter
15. Filter Access Panel
16. Access Panel Tabs

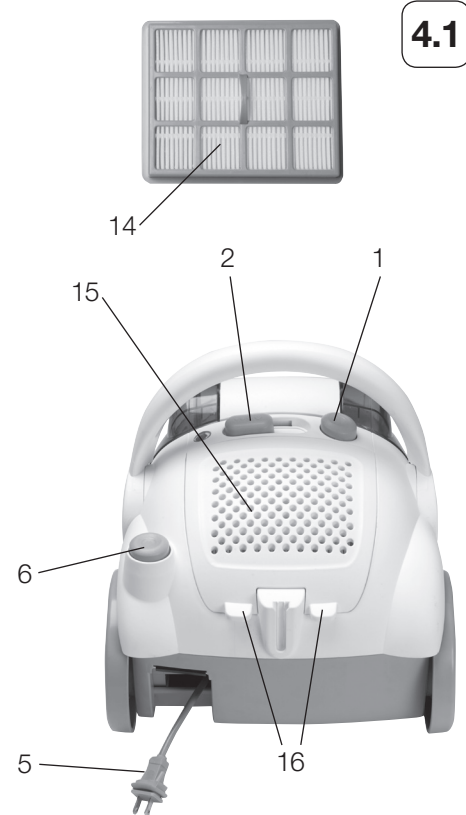
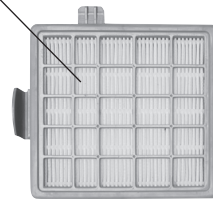
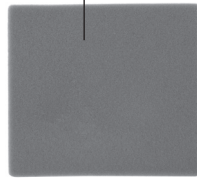

8

4.1



#### 4.2 Handle and Hose

1. Power Head ON/OFF Switch
2. Airflow Selector
3. Wand Coupler
4. Hose Power Plug
5. Canister Coupler
6. Release Button

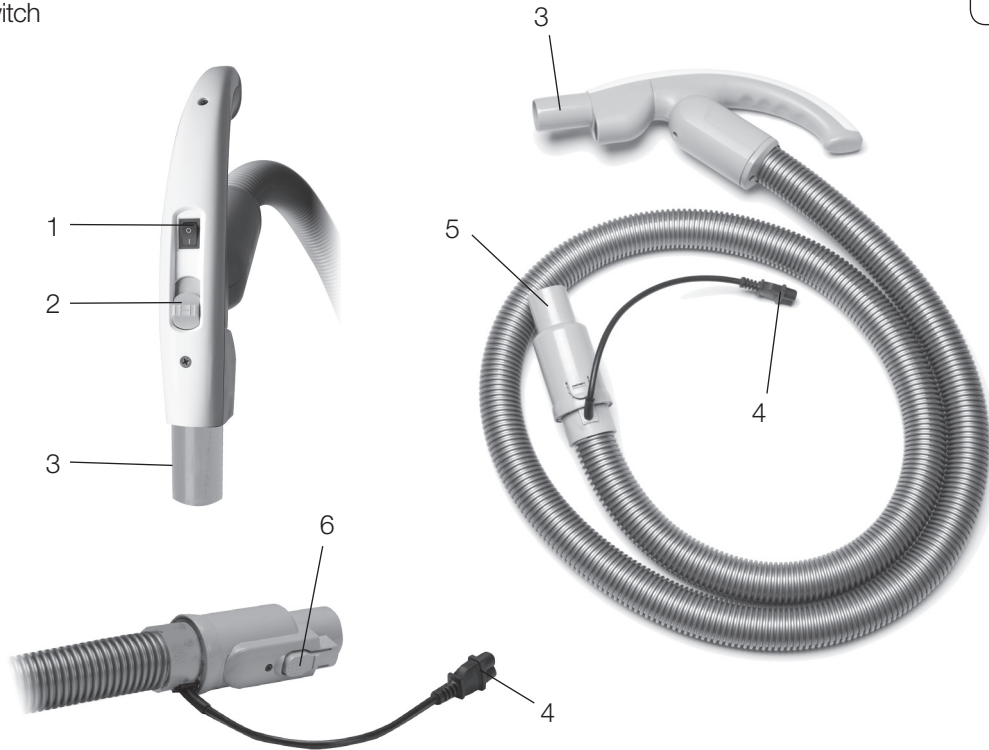

Job#:	Title: VH04 Manual
Date: 10/16/11	Version: VH04-MAN-Rev23

## 4. Features — continued

### 4.3 Sanitizing Power Head

1. Mode Selector Switch
2. Mode Indicator
3. Floor Selector
4. Syphon Receptacle
5. Syphon Release
6. Headlight
7. Sanitizing Light Bulb
8. Bulb Cover
9. Floor Sensor (safety switch)
10. Powered Brush Roll
11. Squeegee
12. Bulb Cover Release Tabs
13. Rear Wheels
14. Stand-up Locks

4.3

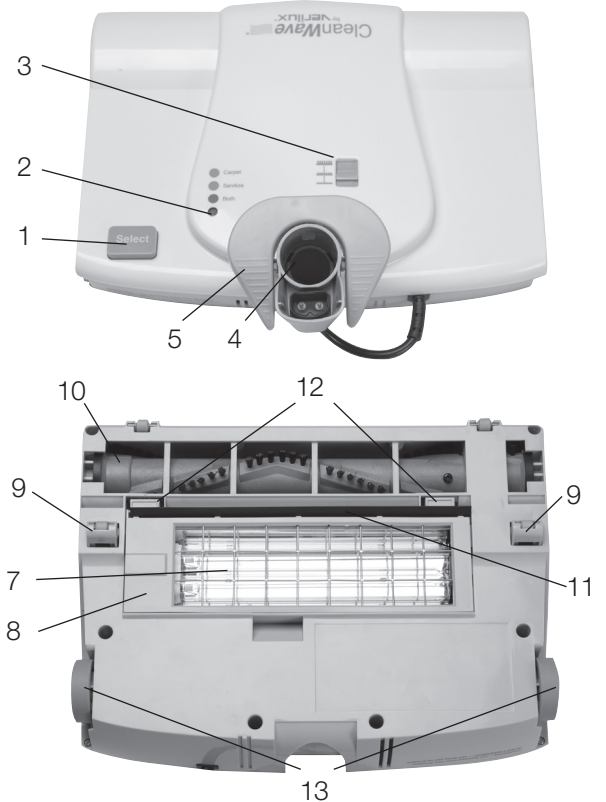
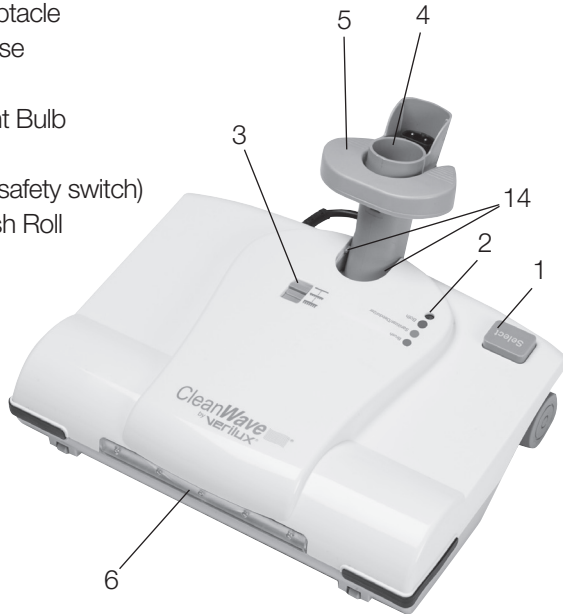

**4.4 Telescoping Wand**

1. Wand Receptacle
2. Release Button
3. Release Cuff
4. Sanitizing Power Head Coupler

4.4



**4.5 Accessories**

1. Crevice Tool
2. Dusting Brush
3. Upholstery Tool

4.5



**4.6 Power Head Spare Parts**

1. Rear Wheels (2)
2. Stand-up Locks (2)

4.6

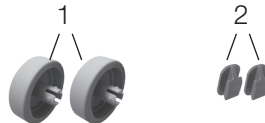

Job#:	Title: VH04 Manual
Date: 10/16/11	Version: VH04-MAN-Rev23

## 5. Assembly

**Note:** Before assembling or disassembling, always ensure that the CleanWave® Sanitizing Bagless Vacuum has been unplugged from the electrical outlet.

### 5.1 Connecting the Hose

1. Align the latch of the Canister Coupler (A) with the Canister Inlet (B) and push until the latch clicks. To disconnect, press the Release Button (C) on the Canister Coupler (A) and pull out.
2. Insert the Hose Power Plug (D) into the Canister Power Receptacle (E) pressing firmly to ensure a good connection. To disconnect, grasp the Hose Power Plug (D) firmly and pull out.

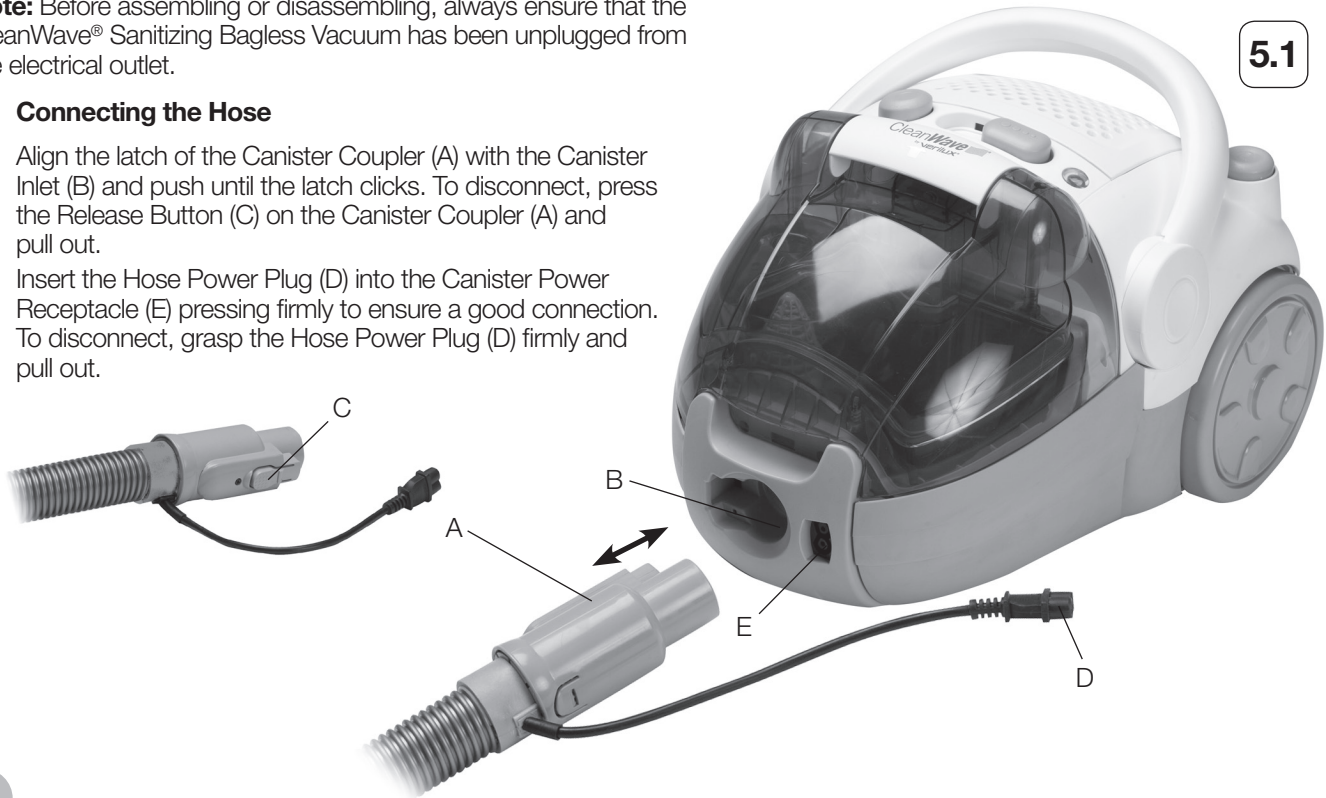

5.1

### 5.2 Connecting the Telescoping Wand

1. Align the Wand Coupler (A) with the Wand Receptacle (B) and push together until the latch clicks. To disconnect, press the Release Button (C) and pull apart.
2. To operate the Telescoping Wand, grab the Release Cuff (D) and push it forward to extend the wand and pull it back to contract the wand.

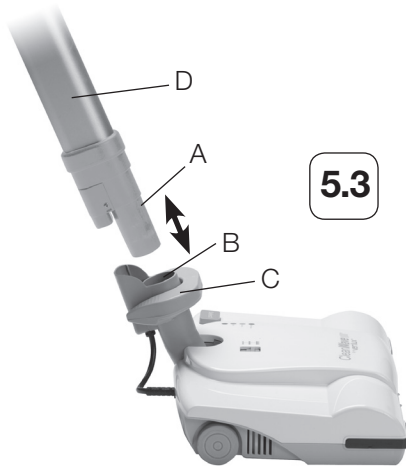
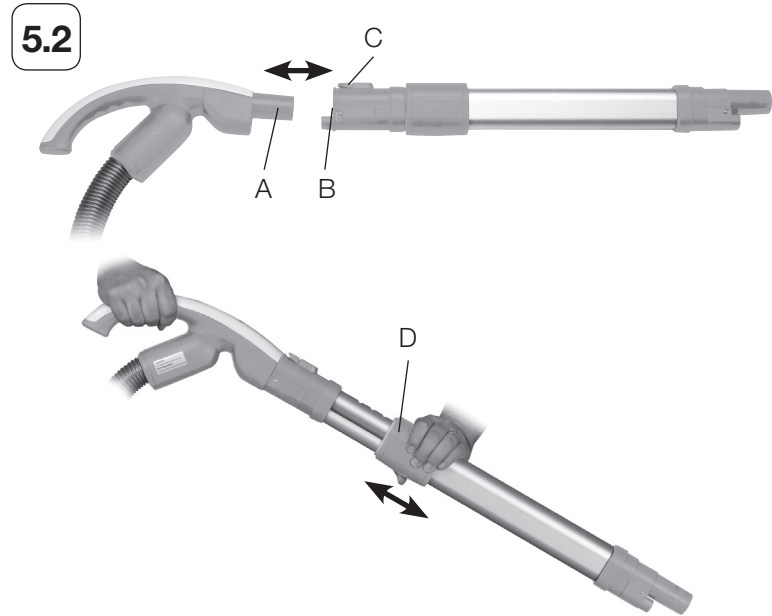

### 5.3 Connecting the Sanitizing Power Head

1. Align the Sanitizing Power Head Coupler (A) with the Syphon Receptacle (B) and push together firmly until they latch. To disconnect, depress (step on) the Syphon Release (C) and pull Wand (D) out of Syphon Receptacle (B).

## 6. CleanWave® Sanitizing Bagless Vacuum Operation

### 6.1 Handle

1. Grasp the Canister Handle (A) to move the CleanWave® Sanitizing Bagless Vacuum from room to room. Before moving, make sure the Dirt Cup is secured and the canister is unplugged from the electrical outlet.

### 6.2 Cord Release / Rewind

1. Pull on the Power Cord (B) to unwind to desired length and insert the plug into a convenient electrical outlet. The yellow mark on the Power Cord (B) shows the typical cord length. Do not pull out beyond the red mark.
2. When done vacuuming, retract the Power Cord by pressing the Cord Rewind Button (C) and guiding the Power Cord into the canister with one hand.

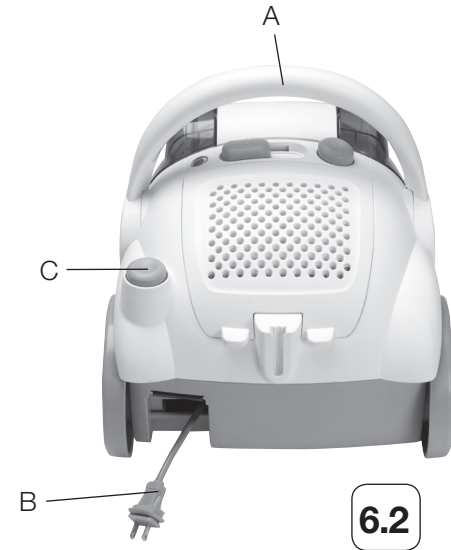

## 6. CleanWave® Sanitizing Bagless Vacuum Operation — continued

### Vacuum Suction Controls

#### 6.3 Canister

1. ON/OFF Button (A)  
Press to turn the canister on and off.
2. Suction Control Slider (B)  
Slide to the maximum position (closest to ON/OFF Button) for the maximum suction power.

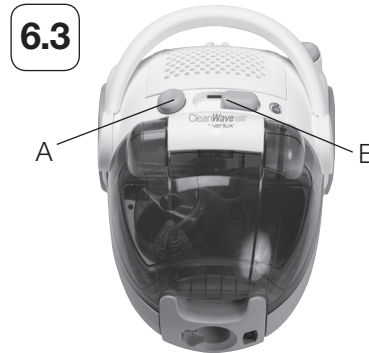

#### 6.4 Handle and Hose

1. Power Head ON/OFF Button (C)  
Press to turn the Sanitizing Power Head on and off.
2. Airflow Selector (D)  
Slide the Airflow Selector to the open position to reduce suction when cleaning delicate fabrics.

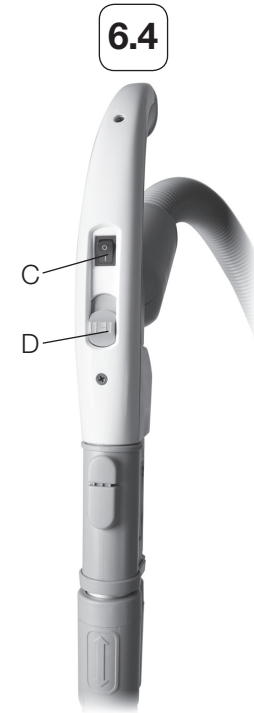

#### 6.5 Sanitizing Power Head

1. Floor Selector (E)  
The 3-position Floor Selector provides adjustment for the desired cleaning surface. Slide Floor Selector to match the floor type:
  - i) bare floor,
  - ii) low-pile carpet,
  - iii) high-pile carpet.



## 6. CleanWave® Sanitizing Bagless Vacuum Operation — continued

### 6.6 Operating Modes

The Sanitizing Power Head has three operating modes:

- i) Brush
  - ii) Sanitizer/Deodorizer
  - iii) Both
1. The Mode Indicator (A) will illuminate as one of three colors depending on the selected operating mode. The Sanitizing Power Head will be controlled as shown in Table 6-1, with the default power-up mode being Brush Mode:

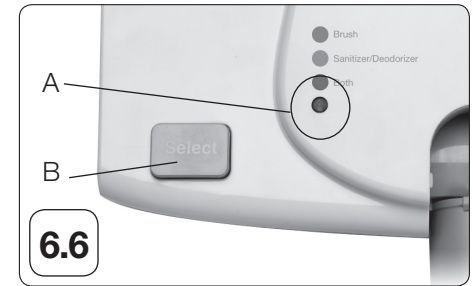

**Table 6-1. CleanWave® Sanitizing Bagless Vacuum Operating Modes**

Operating Mode	Mode Indicator Color	Sanitizing Light	Powered Brush Roll	Suction	Function
Brush	Red	Off	On	On	Powered Brush Roll & Suction
Sanitizer/Deodorizer	Blue	On	Off	On	Sanitizing Light & Suction
Both	Purple	On	On	On	Sanitizing Light, Powered Brush Roll & Suction
Surface Protection	Sanitizer/Deodorizer Mode (Blue) Both Mode (Purple) (slow blinking)	Off	Sanitizer/Deodorizer Mode (Off) Both Mode (On)	On	Protects surfaces from overexposure to Sanitizer/Deodorizer
Low Airflow	Red (rapid blinking)	Off	Off	On	<b>Notice:</b> Clean all filters and clear any blockages. See Section 7.

2. Press the Mode Selector Switch (B) repeatedly to select the desired operating mode.
3. Proceed to vacuum your floors and surfaces just as you normally would. You can sanitize your floors and surfaces at the same time with little or no additional effort.



## 6. CleanWave® Sanitizing Bagless Vacuum Operation — continued

### Brush Mode

Select Brush Mode for conventional vacuuming with a Powered Brush Roll and Powerful Suction. Use this setting when you wish to operate the Powered Brush Roll without the Sanitizing Light. The Mode Indicator will illuminate as RED.

### Sanitizer/Deodorizer Mode

Select the Sanitizer/Deodorizer Mode when you want to engage the Sanitizing Light and Powerful Suction. The Sanitizing Light Bulb will turn on when the Floor Sensors detect a surface. When the Sanitizing Light Bulb is on, the Mode Indicator will illuminate as BLUE. Selecting this mode disengages the Powered Brush Roll. The Sanitizing Light Bulb will turn off when the Floor Sensors do not detect a surface, such as when the Sanitizing Power Head is lifted off the floor. When this occurs, the Mode Indicator will not be illuminated (turns off).

### Both Mode (Brush and Sanitizer/Deodorizer Modes Simultaneously)

Select the Both Mode when you want to engage the Sanitizing Light as well as the Powered Brush Roll and Powerful Suction. When the Sanitizing Light Bulb is on, the Mode Indicator will illuminate as PURPLE. The Sanitizing Light Bulb will turn off when the Floor Sensors do not detect a surface. When this occurs, the Mode Indicator will not be illuminated (turns off).

### Surface Protection

When the Sanitizing Power Head is held or left stationary on a surface (i.e., not moving) for more than 5 seconds, the Sanitizing Light Bulb will automatically turn off. When this occurs, the Mode Indicator will blink slowly (blink BLUE if in Sanitizer/Deodorizer Mode; blink PURPLE if in Both Mode). Once movement is re-initiated, the Sanitizing Light Bulb will turn back on and the Mode Indicator blinking will stop. This happens automatically and is one of the features designed to protect your surfaces.

Job#:	Title: VH04 Manual
Date: 10/16/11	Version: VH04-MAN-Rev23

## 6. CleanWave® Sanitizing Bagless Vacuum Operation — continued

### 6.7 Using the Accessories

The accessories can be used by sliding them onto either the Wand Coupler of the Hose and Handle or to the Sanitizing Power Head Coupler of the Telescoping Wand.

6.7

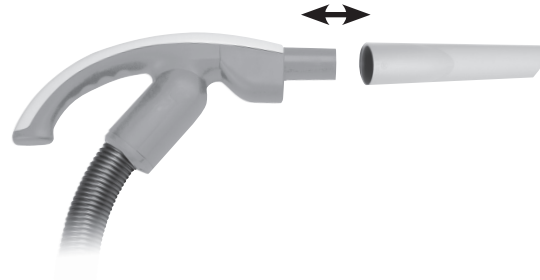

#### Crevice Tool

Use the crevice tool in tight spaces, corners or along edges such as baseboards and stairs. You can use this tool in drawers, cupboards and upholstery.



#### Dusting Brush

Select the dusting brush to clean furniture, lamps, lighting fixtures, blinds, drapes, shutters, baseboards and registers.



#### Upholstery Tool

The upholstery tool can be used to clean upholstery, carpeted stairs and mattresses.

# 7. Care and Maintenance

**Note:** Always unplug the CleanWave® Sanitizing Bagless Vacuum from the electrical outlet prior to completing any care and maintenance.

## Dirt Cup

Empty the Dirt Cup (A) after each use.

### 7.1 How to Empty

1. Disconnect Power Cord from electrical outlet.
2. Remove the Dirt Cup (A) by lifting up on the Cup Release Latch (C).
3. Hold the Dirt Cup (A) over a garbage receptacle and press on the Lid Release Latch (D) to open and empty the Dirt Cup (A). For bed bug disposal, see note below.
4. After emptying the Dirt Cup (A), remove and clean the Cone Filter (E) by rotating counter-clockwise and pulling out. If desired, rinse with water, dry completely, and replace Cone Filter (E) by inserting and rotating clockwise to lock.
5. Close the Lid (F) and slide Dirt Cup (A) into the canister until it securely latches.

**Note:** When disposing of bed bugs, tie or seal garbage bag tightly and immediately remove from home. Do not leave inside home.

**Note:** When removed, emptied, and with filters removed, the Dirt Cup (A) may be washed with mild detergent and water.

**Note:** The Cone Filter (E) is specially designed to trap and capture pet hair. This filter may require frequent cleaning if exposed to large amounts of pet or human hair.

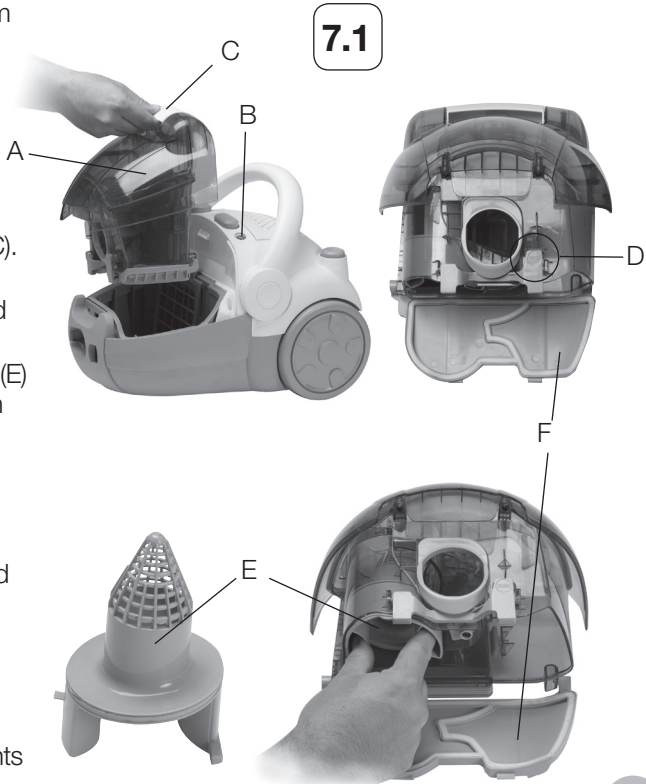

Job#:	Title: VH04 Manual
Date: 10/16/11	Version: VH04-MAN-Rev23

## 7. Care and Maintenance — continued

### 7.2 Cleaning and Replacing Filters

For best performance, clean filters after each use. Replace filters periodically depending on frequency of use and the amount of dirt picked up with each use.

**Note:** If the Power Head Mode Indicator light begins to rapidly blink RED, the airflow may be blocked. The Low Airflow Indicator (A) may also be illuminated. Clean all filters as directed below.

#### How to Clean

Before cleaning or replacing any filters, disconnect Power Cord from electrical outlet.

### 7.3 HEPA-12 Pre-Filter

The HEPA-12 Pre-Filter (B) is located outside dirt cup (C).

1. Remove the Dirt Cup (C) by lifting up on the Release Latch (D).
2. The HEPA-12 Pre-Filter (B) can be removed by pressing the Release Tab (E) and rotating away from the Dirt Cup (C).
3. Gently tap the filter on the inside of a garbage receptacle to remove excess dust and dirt. If very dirty can be cleaned with a damp cloth (warm water) — should not be wet, just damp.
4. Replace filter by aligning Hinge Tabs (F) and rotating into place until latched into the Dirt Cup (C).

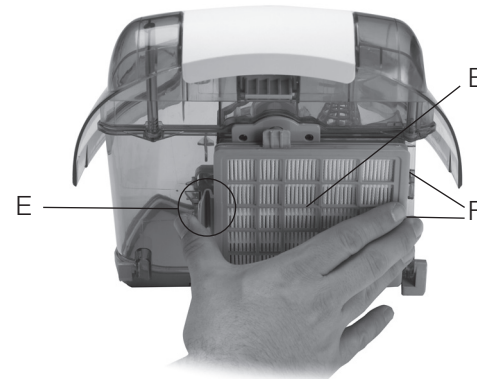
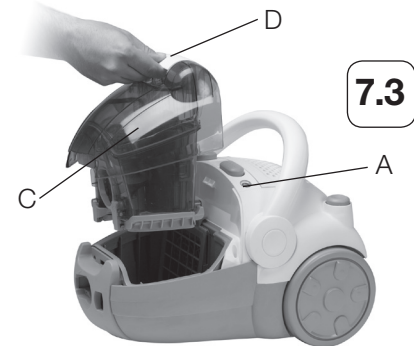

## 7. Care and Maintenance — continued

### 7.4 Sponge Filter

The Sponge Filter is located behind the HEPA-12 Pre-Filter attached to the Dirt Cup.

1. Access the Sponge Filter by first removing the HEPA-12 Pre-Filter.
2. Grasp Sponge Filter and remove.
3. Hold filter under cold running water to remove dirt. Squeeze filter to remove excess water and allow to dry completely.
4. Replace filter into Dirt Cup with proper orientation.

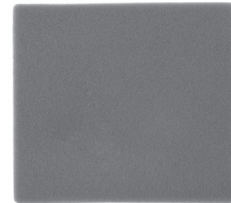

7.4

**Note:** Assure the Sponge Filter and the HEPA-12 Pre-Filter are installed properly before replacing the Dirt Cup into the Canister.

### 7.5 HEPA-12 Exhaust Filter

The HEPA-12 Exhaust Filter (A) is located under the Filter Access Panel (B) on the back of the canister.

1. Remove the the HEPA-12 Exhaust Filter (A) by lifting up on the Access Panel Tabs (C).
2. Grasp the filter by the tab (D) and lift away from canister.
3. Gently tap the filter on the inside of a garbage receptacle to remove excess dust and dirt.
4. Replace filter by first aligning filter's rear edge inside the lip of the recess and then rotate filter down flat into recess (E).
5. Replace Filter Access Panel (B) by first aligning capture tabs, then pressing down on the two Access Panel Tabs (C) to latch in place.

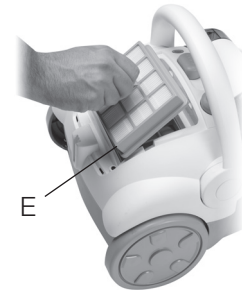
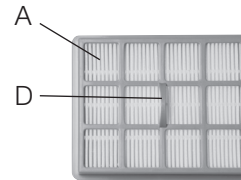
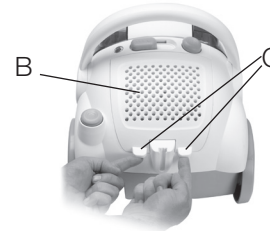

7.5

### 7.6 Replacement Filters

A Replacement Filter Kit is available for purchase. Please refer to the Replacement Part List in Table 7-1 on page 28.

21

Job#:	Title: VH04 Manual
Date: 10/16/11	Version: VH04-MAN-Rev23

## 7. Care and Maintenance — continued

### 7.7 Cleaning and Replacing the Sanitizing Light Bulb

The Sanitizing Light Bulb (A) is located on the bottom of the Sanitizing Power Head (B).

**Note:** Before cleaning or replacing the Sanitizing Light Bulb (A), disconnect Power Cord from electrical outlet. Also disconnect the Sanitizing Power Head (B) from the Telescoping Wand.

1. Turn the Sanitizing Power Head (B) over (bottom up) with the Powered Brush Roll (C) closest to you.
2. With one hand, depress one Bulb Cover Release Tab (D) by pulling it toward the Powered Brush Roll (C).
3. With the other hand, grasp the Squeegee (E) near the Bulb Cover Release Tab (D) and gently lift the Bulb Cover (F).
4. Repeat Steps 2 and 3 for the other Bulb Cover Release Tab (D). The Bulb Cover (F) should now lift freely from the Sanitizing Power Head (B).
5. Wipe the Sanitizing Light Bulb (A) clean with a soft, dry cloth. Be careful not to leave fingerprints on the Sanitizing Light Bulb (A) or the Reflector.

7.7a

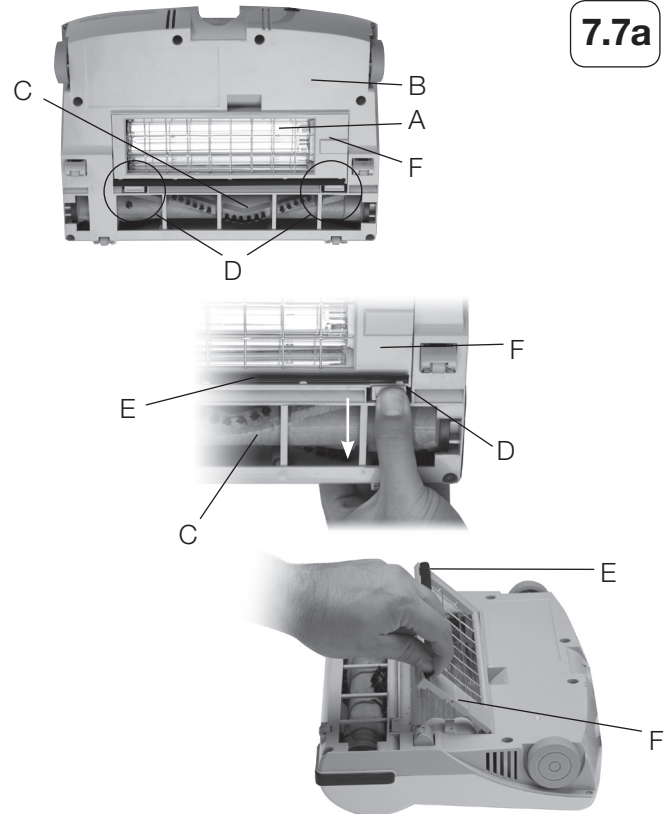

## 7. Care and Maintenance — continued

- Should additional cleaning be required or if replacing the Sanitizing Light Bulb, remove the Sanitizing Light Bulb (A) by depressing the Bulb Socket Tab (H) with your thumb. Grasp the Bulb Cap Tab (I) with your other hand and lift the Bulb Cap (G) and Sanitizing Light Bulb (A) away from the Power Head (B).
- Gently grasp the Sanitizing Light Bulb (A) and remove from Bulb Socket.
- Wipe Sanitizing Light Bulb (A) and Reflector clean with a soft, dry cloth.
- To re-install the Sanitizing Light Bulb (A), place the Bulb Cap (G) over end of the Sanitizing Light Bulb (A).
- With your thumb, depress the Bulb Socket Tab (H).
- Grasp the Sanitizing Light Bulb (A), align its four pin conductors with the four holes in the Bulb Socket. Firmly insert the Sanitizing Light Bulb (A) into the Bulb Socket.
- Slide the Bulb Cap (G) end down into the Capture Slots (I) of the Sanitizing Power Head (B) to secure the Sanitizing Light Bulb (A) in place.
- To replace the Bulb Cover (F), first assure the Squeegee (E) is slid on completely. Grasp the Bulb Cover (F) by the Squeegee (E) with both hands, place opposite edge into recessed slots, rotate down and press firmly until latched securely.

**Note:** Use only Verilux Sanitizing Light Bulbs. Use of non-Verilux light bulbs can result in damage to the unit. To order a replacement Verilux Sanitizing Light Bulb, refer to the Replacement Part List on Table 7-1.

### 7.8 Sanitizing Light Bulb Disposal

If disposing of a Verilux Sanitizing Light Bulb, follow local regulations for proper disposal. For more information, see [www.lamprecycle.org](http://www.lamprecycle.org) or call 1-866-666-6850.



7.7b

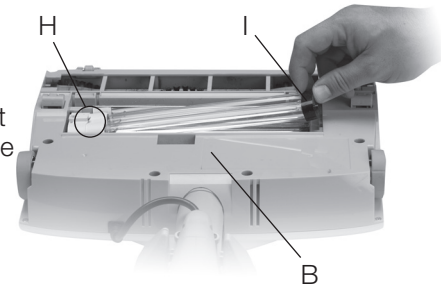
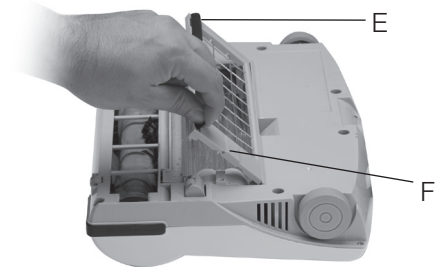

23

Job#:	Title: VH04 Manual
Date: 10/16/11	Version: VH04-MAN-Rev23

## 7. Care and Maintenance — continued

### 7.9 Replacement Parts

#### A) Rear Wheels (2 included)

If a rear wheel on the Sanitizing Power Head of your CleanWave should become cracked or come off, simply push a replacement wheel onto the axel until you hear a snapping sound signifying it is securely in place.

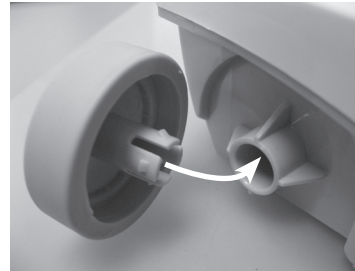

7.9a

Insertion of wheel onto axel of the Sanitizing Power Head

#### B) Stand-up Locks (2 included)

Your CleanWave is designed with rubber locks to allow the wand to remain upright when desired. To remove a lock, press your thumb on the base of the lock, push up and pull out as the lock is removed from the slot. To replace the lock, insert a spare rubber lock into the slot as shown (note the orientation) and slide downward so as to seat in the bottom of the slot.

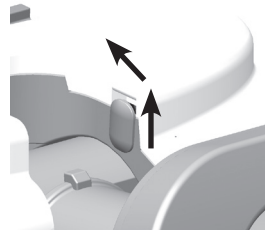

Removal of Stand-up Lock

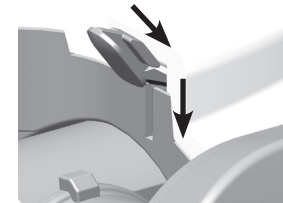

Insertion of Stand-up Lock

7.9b



## 7. Care and Maintenance — continued

### C) Replacement Part List

**Table 7-1 Replacement Part List** For ordering information, see below.

Available Replacement Parts	Part Number	Price*
Telescoping Wand	VH04WD1	\$39.95
Hose and Handle	VH04HH1	\$39.95
Belt and Brush Roll Kit (Drive Belt, Brush Roll)	VH04BR1	\$14.95
UV Bulb Kit (Sanitizing Light Bulb, Bulb Cap)	VH04RB1	\$14.95
Bulb Cover Kit (Bulb Cover, Grill, Squeegee)	VH04BC1	\$9.95
Attachment Kit (Crevice Tool, Dusting Brush, Upholstery Tool)	VH04AK1	\$9.95
Filter Kit (HEPA-12 Pre-Filter, HEPA-12 Exhaust Filter, Sponge Filter)	VH04RF1	\$14.95

\*Prices do not include Shipping & Handling, and are subject to change without notice.

**To order please visit our web site at [www.verilux.com](http://www.verilux.com)**

or Call our Order Department at

**1-800-454-4408**

Monday – Saturday 8 AM – 10 PM; Sunday 9 AM – 8 PM Eastern Time

Canadian Customers Order by Phone Only

**1-800-786-6850**

Job#:	Title: VH04 Manual
Date: 10/16/11	Version: VH04-MAN-Rev23

## 8. Troubleshooting

### 8.1 Troubleshooting

To troubleshoot your vacuum, see Table 8-1 below.

**Note:** Always turn off the vacuum and disconnect the power cord from the electrical outlet before troubleshooting or servicing.

**Table 8-1 Troubleshooting Your Vacuum**

Problem	Possible Cause	Possible Solution	Reference
Vacuum cleaner will not run, or runs intermittently	Switch not "ON" on Canister.	Toggle switch to "ON" on canister.	6.3
	Switch not "ON" on Hose/Handle.	Toggle switch to "ON" on hose handle.	6.4
	No voltage at wall electrical outlet.	Try a different electrical outlet or contact a licensed electrician.	N/A
	Power cord not securely plugged in.	Plug power cord securely in wall electrical outlet.	6.2
Poor Suction: Canister / Sanitizing Power Head	Filter(s) are dirty or clogged.	Clean or replace filters.	7.1—7.6
	Dirt Cup is full.	Empty Dirt Cup and clear Cone Filter.	7.1
	Blockage in Sanitizing Power Head Syphon, Wand or Hose.	Remove wand from syphon receptacle and carefully remove blockage.	5.2
	Suction power controls open.	Slide Suction Control Slider to maximum position and Airflow Selector to closed position; set Floor Selector for bare floors.	6.3—6.5
	Loose hose or wand connection.	Check that all hose and wand connections are secured properly.	5.1—5.3

## 8. Troubleshooting – continued

Problem	Possible Cause	Possible Solution	Reference
Sanitizing Power Head will not run, or runs intermittently	Sanitizing Power Head Coupler or Wand Coupler not securely fastened.	Assure Sanitizing Power Head and Hose/Handle are firmly connected.	5.3
	Hose Power Plug not plugged into Canister	Firmly insert Hose Power Plug.	5.1
	Switch not “ON” on Hose/Handle.	Toggle switch to “ON” on hose handle.	6.4
Sanitizing Light Bulb does not illuminate	Floor Sensors may not be properly activated.	Assure the Floor Sensors actuate properly when Sanitizing Power Head lies flat on cleaning surface.	NA
	Sanitizing Power Head is stationary.	Push Sanitizing Power Head back and forth. If the Sanitizing Power Head is stationary for 5 or more seconds, the Sanitizing Light Bulb will turn off.	6.6 Floor Protection
	Sanitizing Light Bulb may be burned out.	Replace Sanitizing Light Bulb.	7.7
Sanitizing Light Bulb turns off unexpectedly	Sanitizing Power Head is stationary.	Push Sanitizing Power Head back and forth. If the Sanitizing Power Head is stationary for 5 or more seconds, the Sanitizing Light Bulb will turn off.	6.6 Floor Protection
Brush Roll will not turn	Belt may be broken.	Order a replacement Belt and Brush Roll Kit (VH04BR1)	Table 7-1

**Note:** Any other servicing should only be completed by authorized service personnel.

## 9. Five Year Limited Warranty

### **ATTENTION! ONCE OPENED, PLEASE DO NOT RETURN THIS PRODUCT TO THE STORE WHERE IT WAS PURCHASED FOR REPAIR OR REPLACEMENT!**

Many questions may be answered by visiting [www.verilux.com](http://www.verilux.com), or you may call our Customer Service Department at 800-786-6850 during normal business hours.

This limited warranty is provided by: Verilux, Inc., 340 Mad River Park, Waitsfield, VT 05673

#### **Covered By This Warranty**

Verilux warrants this product when used and maintained in normal household use and in accordance with the Owner's Manual to be free from original defects in material and workmanship for a period of five years from the date of the original retail purchase (the "Limited Warranty Period") from Verilux or an authorized Verilux distributor. During the limited warranty period, Verilux, Inc. will, at its option, repair or replace defective parts of this product, at no charge to the customer, to correct any such defects.

#### **Not Covered By This Warranty**

This warranty does not cover the brush roll, drive belt, UV-C bulb, motor brushes, wheels or the filters. This warranty does not include any postage, freight, handling, insurance, or delivery fees. This warranty does not cover damage, defect or failure caused by or resulting from accident, external destruction, alteration, modification, abuse, misuse or misapplication of this product. This warranty does not cover damage to the product resulting from return shipping or handling. The use of shipping insurance is recommended to help protect your product.

#### **Additional Warranty Terms**

This warranty is non-transferable and may not be assigned. The Limited Warranty Period will not be extended by any replacement or repair performed under this warranty.

THIS WARRANTY IS THE EXCLUSIVE WARRANTY AND REMEDY, ALL OTHER WARRANTIES, EXPRESSED OR IMPLIED, INCLUDING WARRANTIES OF MERCHANTABILITY OR FITNESS FOR PARTICULAR PURPOSE, ARE DISCLAIMED, IN NO EVENT WILL VERILUX BE LIABLE FOR ANY SPECIAL, INDIRECT, INCIDENTAL OR CONSEQUENTIAL DAMAGES OF ANY KIND OR NATURE TO OWNER OR ANY PARTY CLAIMING THROUGH OWNER, WHETHER BASED IN CONTRACT, NEGLIGENCE, TORT OR STRICT PRODUCTS LIABILITY OR ARISING FROM ANY CAUSE WHATSOEVER. Some states do not allow the exclusion of consequential damages, so the above exclusion may not apply to you. This warranty gives you specific rights; you may also have others that vary from state to state.

#### **Making A Warranty Claim**

**Proof of purchase is required for all warranty claims. Return Authorization is required for all returns.** To obtain a Return Authorization, please contact the Verilux Customer Service Department at 800-786-6850.

If, during the first five years of ownership, this product fails to operate properly, it should be returned as specified at [www.verilux.com/warrantyreplacement](http://www.verilux.com/warrantyreplacement) or as instructed by a Verilux customer service representative at 800-786-6850.

Due to ongoing improvements, the actual product may have slight variations from the product described in this manual.

**Please visit our website at [www.verilux.com](http://www.verilux.com) or call our Customer Service Department at  
1-800-786-6850**

Representatives are available Monday — Friday, 9 AM — 5 PM Eastern Time

***Do not return product for warranty claim without a Return Authorization number.***