



BigBaba
www.BigBaba.com

QUICKSHIP 2023

ONE STOP SHOP FOR PATIO SOLUTIONS

www.bigbaba.com







QUICKSHIP 2023 TABLE OF CONTENTS

ARM CHAIRS.....	12
SIDE CHAIRS	31
BAR STOOLS.....	52
TABLES: DINING & BAR HEIGHT	68
TABLES: TOPS & BASES.....	95
LOUNGE	108
COMPLEMENTS	148
SHADE	163
PLANTERS.....	174
FLAME.....	183
PARTS.....	191
SWATCHES	198
WARRANTY & CARE	203

TERMS & CONDITIONS

PRODUCT DIMENSIONS

All dimensions and weights shown are to be considered approximate as a majority of the products are manufactured in countries using the metric system; all measurements are converted from metric units.

Please note that all finishes on our marketing materials and website are approximate due to the variation in colour monitors and the processes of photography and printing.

ASSEMBLY

Some products require assembly; please refer to the instructions included with item packaging or visit our website for information on assembly instructions. If instructions are not available, please contact your sales rep or BigBaba.com.

WARRANTY

This limited warranty does not apply to damage resulting from accident, alteration, misuse, tampering, negligence, abuse or normal wear and tear. All items must be properly assembled per instructions.

The warranty is only valid if all parts that wear, such as chair foot caps, get replaced at least annually. Parts must be purchased within one month of replacement time and proper maintenance must be followed. Product failure caused by a lack of reasonable and necessary care and maintenance is not covered under warranty.

Please note that our steel items are not recommended in installations proximate to salt water.

GENERAL MAINTENANCE

As with any equipment, proper and periodic maintenance is necessary to ensure longevity of the product and customer satisfaction. To ensure you get the most out of your investment, please follow our recommended maintenance and care instructions.

We recommend that the products be examined every 30 days. Items requiring adjustments, showing any sign of structural failure, that have missing hardware or that show any cracks at the welds should be taken out of service immediately until repaired.

Loose screws should be tightened as required and missing or worn out foot caps must be replaced.

To obtain replacement parts, please contact your local representation or local dealer.

Furniture should be handled with care. When chairs are stacked, the stack should not be dragged. Stackable chairs should not be dropped or slammed down when being un-stacked. People should not rock backwards or stand on.

For storage, all furniture should be stored neatly, stacked to suggested height, and packed in a clean and dry area. Tables should not be flipped and stacked; any standing water needs to be removed to avoid damage to finish. Cushions that are stored for longer periods of time should be stored in a dry ventilated area.

NOTE: Warranty may be voided if proper maintenance or care is not followed.

PRICING

All prices published are "MSRP" and "SELL PRICE" per single unit, and do not include shipping costs, taxes or installation. Due to frequent currency and raw material fluctuations, we reserve the right to change prices without notice.

QUOTES

Please contact your local BigBaba.com representative for quotes. All quotations received from BigBaba.com or our sales representatives are valid for (30) days unless prolonged in writing.

STOCK HOLD

Quick ship items cannot be reserved or held for over 30 days unless a 25% deposit is received.

PLACING ORDERS

All orders are subject to acceptance by BigBaba.com Orders must be received by fax, mail or e-mail on the buyer's company purchase order form or letterhead or Bum's order form. Purchase Orders must be complete including: item#, quantity, colour finish, required on site date, ship to address, shipping instructions and contact name and phone number of receiver. If a Call Before is required, please supply this information at time of order.

Orders must be approved by the credit department before being confirmed. Invoices are faxed, mailed or e-mailed with tracking information the day of shipment.

ACKNOWLEDGMENT

Order acceptance will be made in the form of a Sales Order Confirmation with an estimated ship date assigned and lead times/ estimated warehouse arrivals (EWA) listed after each line item if applicable.

Sales Order Confirmations need to be reviewed for corrections immediately upon receipt; BigBaba.com will not be held responsible for any errors or missing information on sales order confirmations. All orders will ship ASAP unless otherwise noted on the Purchase Order.

ESTIMATED SHIP DATE

All estimated ship dates are approximate only. BigBaba.com cannot be held responsible for financial damages due to late shipping.

All orders are subject to delay or failure of delivery due to problems with source of supply, transportation, war, riots, fire, accidents, compliance with government regulations, strikes, Acts of God, or other causes beyond our control.

SHIPPING

Shipping and routing instructions are required for each 3rd party shipment. If no such instructions are received we have the right to ship by the carrier of our choice. If billing third party, the payer's discount program will take precedence; please consult your carrier for a freight quote.

Customer pick up is available from our distribution center, a pick up appointment must be scheduled, if customers come to the warehouse without an appointment they will be turned away; any missed appointments may be subject to additional fees.

PAYMENT & CREDIT

REQUIRED DEPOSITS

Each of the following requires a 50% non-refundable deposit prior to the order being placed into production:

- All special order items
- Direct containers

DEDUCTIONS

No deductions may be made from remittance without written authorization from BigBaba.com

COLLECTIONS

In event of delinquency, the customer shall be responsible for all collection costs, including attorney's fees incurred by BigBaba.com

REFUNDS

Should a refund be required due to overpayment, this may only be processed after the completion of the related purchase order. A completion of purchase order is when the order is shipped and invoiced.

FREIGHT CLAIMS & DAMAGES

VIA 3rd Party

If a specific carrier was requested on the purchase order, the customer takes full responsibility for all freight issues, including contacting the carrier, damages, losses, additional freight charges and claims.

VIA CARRIER

Before accepting and signing for the merchandise from the carrier, inspect all cartons for visible or concealed damage and clearly note any loss or damage on the delivery receipt/BOL. If there is loss or damage, make an immediate claim with the delivering carrier. In the event of concealed damage, save all cartons and packing materials, and notify the freight carrier and BigBaba.com immediately for inspection.

Missing items/parts/hardware claims against us will be considered only if filed with us in writing via email sales@bigbaba.com within 3 days of delivery date. Failure to make such a claim shall constitute acceptance of the merchandise and waiver of any defects, errors, or shortages.

BigBaba.com is not responsible for damage or loss incurred in transit. All furniture is shipped at the purchaser's own risk after it has been inspected and securely packed at the distribution center. It is accepted as such by the freight carrier.

REFUSALS

If a shipment is refused, re-consigned, re-delivered, stored or additional services are rendered, the customer is responsible for all additional charges incurred, and applicable re-stocking fee.

RETURNS

Special order items, parts, clearance and cushions are not returnable or refundable.

Clearance Items are not returnable

Quick Ship items may be returned within 30 days from the invoice date with an RMA. Items must be received in original condition, original boxes including all original interior packaging and palletized for a full refund minus the restocking fee.

BACK ORDERS

Standard shipping charges apply to back orders. All back orders will ship once the product becomes available.

RE-STOCKING FEE

A minimum of 25% restocking fee will be charged for the return of quick ship items in original condition.

Credit for returns will only be issued after receipt and inspection of returned merchandise.

Damaged returns are subject to additional charges incurred to restore goods to original condition or customer may reclaim the items if determined credit amount is insufficient.

No return of merchandise will be accepted to our **BigBaba.com** Distribution Center without our written consent via RMA (Return Merchandise Authorization) number, which includes the appropriate shipping instructions. Unauthorized returns will be refused and/or returned freight collect.

RMA # is only valid for 15 days from issue date. A copy of the RMA must accompany the returned merchandise, and the RMA # must appear on each carton returned.

Any additional cartons needed for return will be charged to your account. No credit will be issued for goods without our written consent.



QUICKSHIP 2023

ICON LEGEND



• Non Slip Replaceable Feet



• Stackable



• Nesting



• Umbrella Hole



• Assembly Required



• Adjustable Feet



• Custom Cushions

• Wheels

• Illuminated

• Flame/Heater



• ADA Compliant



• International Testing Laboratory for the Furniture Industry



• All chairs are tested and rated to hold 300 lbs





WE NOW SUPPLY...

CORPORATE OUTDOOR SPACES

EMPLOYEE BREAK SPACES

PROFESSIONAL BUILDING OUTDOOR SPACES

EDUCATIONAL SETTINGS

OUTDOOR MEETING SPACES

CONDO PATIOS

RETIREMENT RESIDENCE PATIOS





ARM CHAIRS

Carousel     MADE IN ITALY

Tubular aluminum frame • Full woven synthetic rope back • E-coated powder coat finish
Cushion included 900/77 Small Weft Weave Grey

MSRP: \$2700 EA.

SELL PRICE: **\$1750 EA.**

Lounge Pg.128



CEMENT
1214-73-18

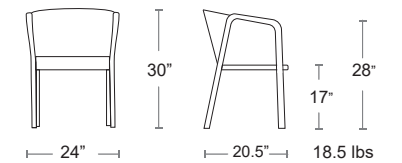

Lyze Teak     MADE IN ITALY

Tubular aluminum frame • Teak seat • Stainless steel mesh back rest • E-coated powder coat finish

MSRP: \$1860 EA. SELL PRICE: **\$1200 EA.**

Side Chair Pg. 34, Lounge Pg.131



WHITE + TEAK
616T-23-82

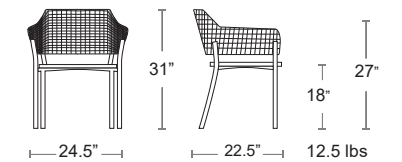

Shine Teak Arms     MADE IN ITALY

Tubular aluminum frame • Teak arm rests • E-coated powder coat finish

MSRP: \$1230 EA. SELL PRICE: **\$800 EA.**



BRONZE + TEAK
248-41-82

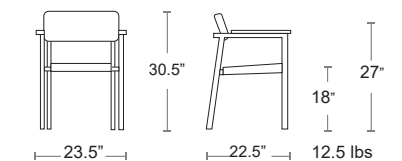

ARM CHAIRS



Holly

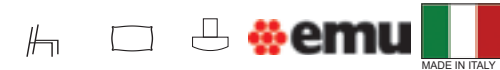

Tubular aluminum frame • Textilene sling seat and back • E-coated powder coat finish

MSRP: \$920 EA. SELL PRICE: \$600 EA.

Lounge Pg.131



WHITE + WHITE
1310-23-300/52

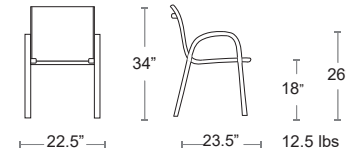

BRONZE + HAZEL
1310-41-300/86

ARM CHAIRS



Sid Wicker



Tubular aluminum frame • All-Weather Wicker seat and back

MSRP: \$710 EA. SELL PRICE: \$460 EA.

Side Chair Pg.38, Bar/Counter Stool Pg.57

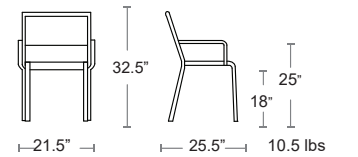

BLACK + GREY
1130-24-76

Aria



Resin frame with slats • UV Protected

Seat and Back cushion included, choose your cushion color below

MSRP: \$800 EA. SELL PRICE: \$520 EA.



ANTRACITE - FRAME ONLY
203308002

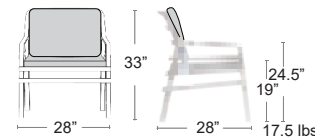

Aria Cushions sunbrella

INCLUDED WITH FRAME 2 piece cushion set with Velcro straps



PEYTON
GRANITE
56075-0000



MILANO
CHAR
56079-0000



SPECTRUM
CARBON
48085-0000



SPECTRUM
DAFFODIL
48024-0000



CANVAS
GRANITE
5402-0000



SPECTRUM
EGGSHELL
48018-0000



VOLT
SILVER
58020



SPECTRUM
CHERRY
48096-0000



Apero

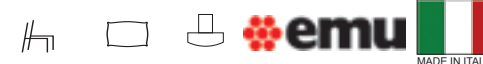

Tubular steel frame • Wrought Iron seat and back • E-coated powder coat finish

MSRP: \$680 EA. SELL PRICE: \$440 EA.

Side Chair Pg.37, Bar Stool Pg.54



MARINE BLUE
1301-16

BLACK
1301-24

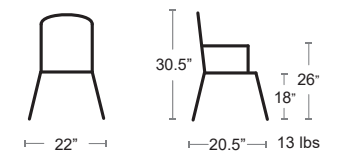

Segno - Teak



Square Tubular Frame • Teak slat seat & steel slat back • E-coated powder coat finish

MSRP \$640 EA. SELL PRICE: \$410 EA.



IRON
267-22-82



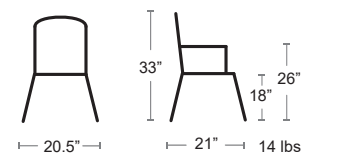

BRONZE
267-41-82



ARM CHAIRS



Sole  **emu** 

Tubular steel frame • Interlace steel mesh seat and back • E-coated powder coat finish

MSRP: \$640 EA. **SELL PRICE: \$410 EA.**
HD Side Chair Pg.37

IRON
3403-22

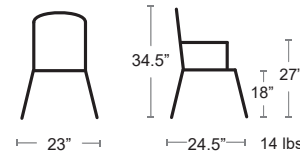

ARM CHAIRS

ReCLIPS Arm Chair  **HOUE** 

A line of stackable chairs with wide plastic slats clipped on a light powder coated aluminum frame with optional Bamboo arm rests.

ReCLIPS is a product of Danish design and innovation, re-using post consumer polypropylene as a functional and stylish material for commercial furniture applications.

The slats are made from 97% household recycled polypropylene + color pigments + UV protection
Produced in Denmark.

MSRP: \$600 EA. **SELL PRICE: \$390 EA.**

BAMBOO ARMS AVAILABLE FOR ALL COLORS
PT-HOUE-BAMBOO ARM REST-03
MSRP: \$20 EA. **SELL PRICE: \$10 EA.**



SKY BLUE
HOUE-22302-1414-14



HOUE-BAMBOO ARM REST-03



DARK GREY
HOUE-22302-7026-26



OLIVE GREEN
HOUE-22302-2727-27



BLACK
HOUE-22302-2024-24

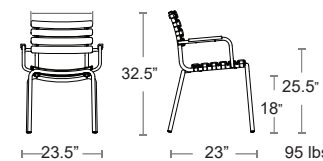

Topper  **emu** 

Tubular steel frame • Small interlace steel mesh seat and back • E-coated powder coat finish

MSRP: \$640 EA. **SELL PRICE: \$410 EA.**
Side Chair Pg.37



IRON
151-22

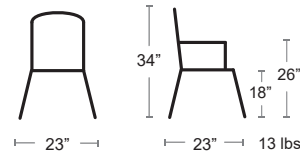

Sid  **emuamericas** 

Square tubular aluminum frame • Wood-look powder coated aluminum slat seat and back

MSRP: \$620 EA. **SELL PRICE: \$400 EA.**

Find other Sid products
Bench Pg.34,
Side Chair Pg.39,
Bar/Counter Stool Pg.59,
Backless Bar/Counter Pg.62,
Picnic Tables Pg.70,
Tables Pg.73, Table Tops Pg.97,
Lounge Pg.133



WALNUT WITH
IRON FRAME
1120-22-404



OAK WITH
BRUSHED
ALUMINUM FRAME
1120-06-401



GREY WITH
BLACK FRAME
1120-24-400



WENGE WITH
BRUSHED
ALUMINUM FRAME
1120-06-402

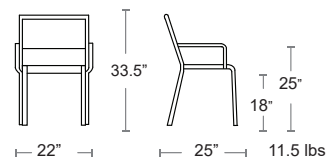

ARM CHAIRS



Segno MADE IN ITALY

Square tubular steel frame • Steel slat seat and back • E-coated powder coat finish

MSRP: \$580 EA. SELL PRICE: **\$370 EA.**

Side Chair Pg.39,
Bar/Counter Stool Pg.56
Bench Pg.159

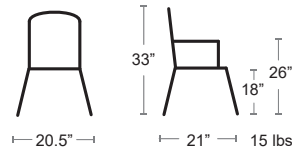

IRON
268-22

ARM CHAIRS



Darwin MADE IN ITALY

Tubular steel frame • Steel mesh seat and back • E-Coated powder coat finish

MSRP: \$550 EA. SELL PRICE: **\$350 EA.**

Side Chair Pg.41, Bar/Counter Stool Pg.58, Tables Pg.84/85, Lounge Pg.129



CHERRY
522-50



CEMENT
522-73



BRONZE
522-41



BLACK
522-24



WHITE
522-23

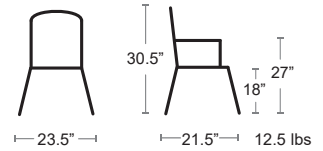

Mom MADE IN ITALY

Tubular steel frame • Solid steel slat seat and back • E-Coated powder coat finish

MSRP: \$580 EA. SELL PRICE: **\$370 EA.**

Side Chair Pg.40, Bar/Counter Stool Pg.55



CURRY YELLOW
640-62



CHERRY
640-50



BRONZE
640-41



MARINE BLUE
640-16



CEMENT
640-73



Star MADE IN ITALY

Tubular steel frame • Solid steel slat seat and back • E-Coated powder coat finish

MSRP: \$580 EA. SELL PRICE: **\$370 EA.**

Side Chair Pg.40, Bar/Counter Stool Pg.57, Table Pg.75, Lounge Pg.130



BLUE
162-61



GREEN
162-60



BRONZE
162-41

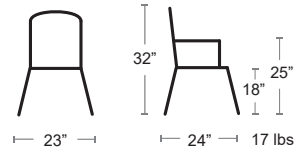

Bridge MADE IN ITALY

Tubular steel frame • Solid steel slat seat and back • E-Coated powder coat finish

MSRP: \$520 EA. SELL PRICE: **\$340 EA.**

Side Chair Pg.41, Bar/Counter Stool Pg.56



BLACK
147-24

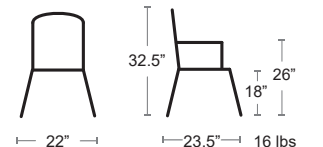

ARM CHAIRS

Ronda 2.0 **emu** MADE IN ITALY

Tubular steel frame • Extended steel mesh seat and back • E-coated powder coat finish
MSRP: \$470 EA. SELL PRICE: \$300 EA.
Side Chair Pg.43, Bar/Counter Stool Pg.59



IRON
458-22



WHITE
458-23



MAPLE RED
458-26



BLACK
458-24



MARINE BLUE
458-16

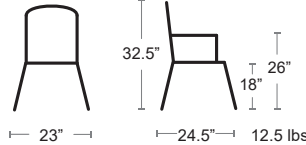

Africa **VONDOM** MADE IN SPAIN

Tubular resin and fiberglass frame • Solid seat and back • UV Protected
MSRP: \$460 EA. SELL PRICE: \$300 EA.
Side Chair Pg.45, Bar Stool Pg.63



RED
65005-RED



WHITE
65005-WHITE



BLACK
65005-BLACK

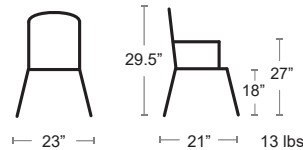

Ronda Heavy Duty **emu** MADE IN ITALY

Tubular steel frame with stretcher bar • Steel mesh seat and back • E-coated powder coat finish
MSRP: \$440 EA. SELL PRICE: \$290 EA.
Side Chair Pg.44, Bar/Counter Stool Pg.54



BLACK
116HD-24



BRONZE
116HD-41



DARK GREEN
116HD-75



IRON
116HD-22

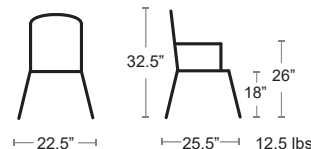

ARM CHAIRS



Croisette Arm Chair **SERRALUNGA CATAS** MADE IN ITALY

Stackable monobloc chair made of fiberglass reinforced polypropylene.
With its simple clean lines it is suitable for living/dining areas in contract applications. UV Protected.

MSRP: \$440 EA. SELL PRICE: \$290 EA.

Side Chair Pg.43



LIGHT GREEN
SL-CROISE/BR/5635C



ANTRACITE
SL-CROISE/BR/447C

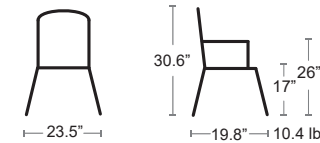

Marco Sling MADE IN CHINA

Square tubular aluminum powder coated frame • Batyline seat and back • Polywood Armrests
MSRP: \$430 EA. SELL PRICE: \$280 EA.
Side Chair Pg.42, Bar Stool Pg.60/61, Tables Pg.89



SILVER / BATYLINE
516A-BT-GS

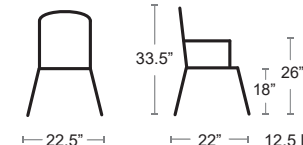

ANTRACITE / BATYLINE
516A-BT-GA

ARM CHAIRS

Marco Wicker 



Square tubular aluminum powder coated frame • Viro wicker seat and back • Polywood Armrests

MSRP: \$430 EA. SELL PRICE: **\$280 EA.**
Side Chair Pg.42, Bar Stool Pg.60-/61 Tables Pg.89



ANTRACITE / GRAPHITE
516A-SW-BA

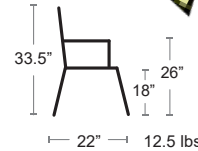

SILVER / GRAPHITE
516A-SW-B5

ARM CHAIRS

Sara 



emuamericas

Tubular aluminum frame • Aluminum slat seat and back • Polished aluminum • 9 lbs

MSRP: \$280 EA. SELL PRICE: **\$180 EA.**
Flora Side Chair Pg.46



POLISHED ALUMINUM
1101-00

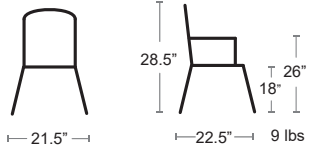

Marco Polywood 



Square tubular aluminum powder coated frame • Polywood seat, back and armrests

MSRP: \$430 EA. SELL PRICE: **\$280 EA.**
Side Chair Pg.42, Bar Stool Pg.61/ 62 Tables Pg.89



ANTRACITE / GREY
516A-PW-GA



SILVER / GREY
516A-PW-GS



ANTRACITE / TEAK
516A-PW-TA



SILVER / TEAK
516A-PW-TS

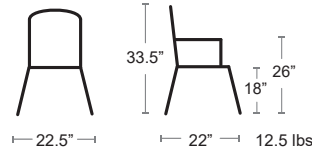

Net Arm Chair 



Uniformly colored fiberglass polypropylene resins with UV additives •

Matte finish • Non-slip feet • Recyclable resin.

MSRP: \$270 EA. SELL PRICE: **\$220 EA.**



TORTORA
40326.10.000



CORALLO
40326.75.000



BIANCO
40326.00.000



SALICE
40326.04.000



SENAPE
40326.56.000



ANTRACITE
40326.02.000

Bit Side Chair Pg.46,
Bar Stool Pg.64,
Lounge Pg.140-143

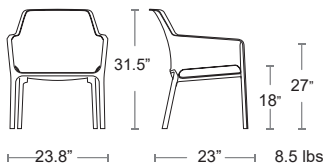

Darsena 



Tubular resin and fiberglass frame • Perforated seat and back • UV Protected
4 positions • Folding

MSRP: \$300 EA. SELL PRICE: **\$200 EA.**



ANTRACITE
40316.02.000



FOLDED

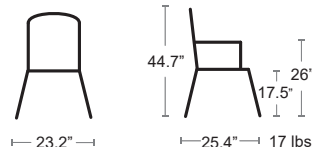

Net Cushion 

MADE IN NORTH AMERICA

Made in North America • Sunbrella 100% Solution dyed acrylic • 1.8 lbs

Zippered removable cover • Washable

Custom Sunbrella cushions available for a 25% Surcharge

MSRP: \$110 EA. SELL PRICE: **\$70 EA.**



PEYTON GRANITE
NET-56075

SPECTRUM CARBON
NET-48085

CANVAS GRANITE
NET-5402

VOLT SILVER
NET-58020



SPECTRUM CHERRY
NET-48096



MILANO CHAR
NET-56079



SPECTRUM DAFFODIL
NET-48024



SPECTRUM EGGSHELL
NET-48018

ARM CHAIRS

Doga Arm Chair



Uniformly colored fiberglass polypropylene resins with UV additives • Matte finish • Non-slip feet •

Recyclable resin
MSRP: \$260 EA. SELL PRICE: \$200 EA.

Side Chair Pg.47, Lounge Pg.143/144



PERA
40254.18.000



AGAVE
40254.16.000



MARSALA
40254.21.000



BIANCO
40254.00.000



ANTRACITE
40254.02.000

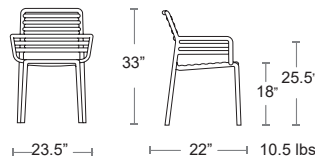

Doga Cushion sunbrella

Made in North America • Sunbrella 100% Solution dyed acrylic • 1.8 lbs
Zippered removable cover • Velcro Ties • Washable
Custom Sunbrella cushions available for a 25% Surcharge

MSRP: \$110 EA. SELL PRICE: \$70 EA.

PEYTON GRANITE
DOGA-56075

SPECTRUM CARBON
DOGA-48085

CANVAS GRANITE
DOGA-5402

VOLT SILVER
DOGA-58020

SPECTRUM CHERRY
DOGA-48096

SPECTRUM DAFFODIL
DOGA-48024

SPECTRUM EGGSHELL
DOGA-48018

MILANO CHAR
DOGA-56079

ARM CHAIRS

Luna



Uniformly colored fiberglass polypropylene resins with UV additives • Matte finish • Non-slip feet •

Recyclable resin
MSRP: \$250 EA. SELL PRICE: \$170 EA.



ANTRACITE / SMOKE
PPY-LUNA-22-38

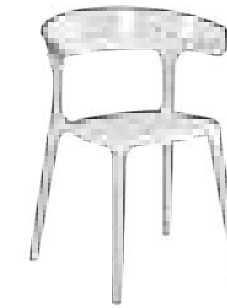

WHITE / CLEAR
PPY-LUNA-01-37

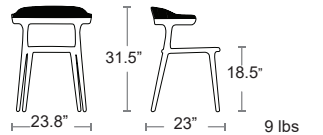

9 lbs

Mambo



Uniformly colored fiberglass polypropylene resins with UV additives • Matte finish • Non-slip feet •

Recyclable resin
MSRP: \$250 EA. SELL PRICE: \$170 EA.



ANTRACITE
PPY-MAMBO-22



WHITE
PPY-MAMBO-01

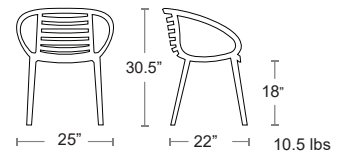

10.5 lbs

Trill



Uniformly colored fiberglass polypropylene resins with UV additives • Matte finish • Non-slip feet • Recyclable resin

MSRP: \$260 EA. SELL PRICE: \$200 EA.

See in stock cushions Pg.29 Side Chair Pg.47, Bar Stool Pg.64



AGAVE
40250.16.000



BIANCO
40250.00.000



SENAPE
40250.56.000



OTTANIO
40250.49.000



GRIGIO
40250.03.000



TORTORA
40250.10.000



ANTRACITE
40250.02.000

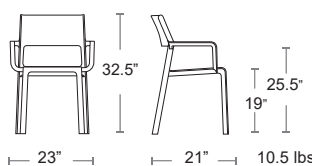

10.5 lbs

Seginus Arm Chair



Elegant stackable polypropylene and fiberglass chair with perforated seat and back.
UV Protected with anti-static and antioxidant additives to protect against dust and deterioration.

Suitable for indoor and outdoor environments.
MSRP: \$230 EA. SELL PRICE: \$150 EA.



WHITE / ANTRACITE
NVS-026-Ant/Wh



ANTRACITE / ANTRACITE
NVS-026-Ant/An

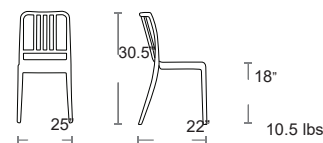

10.5 lbs

ARM CHAIRS

Riva

NARDI CATAS
YOUR OUTDOOR LIVING

Uniformly colored fiberglass polypropylene resins with UV additives • Matte finish • Non-slip feet •
Recyclable resin

MSRP: \$230 EA. SELL PRICE: **\$150 EA.**

See in stock cushions Pg.29 Side Chair Pg.48, Faro Bar & Counter Stools Pg.66



ARM CHAIRS

Costa

NARDI CATAS
YOUR OUTDOOR LIVING

Uniformly colored fiberglass polypropylene resins with UV additives • Matte finish • Non-slip feet •
Recyclable resin

MSRP: \$230 EA. SELL PRICE: **\$150 EA.**

See in stock cushions Pg.29 Side Chair Pg.49, Faro Bar & Counter Stools Pg.66



Bora

NARDI CATAS
YOUR OUTDOOR LIVING

Uniformly colored fiberglass polypropylene resins with UV additives • Matte finish • Non-slip feet •
Recyclable resin

See in stock cushions Pg.29 Side Chair Pg.48, Lido Bar & Counter Stools Pg.65

MSRP: \$230 EA. SELL PRICE: **\$150 EA.**



Cushions

sunbrella MADE IN NORTH AMERICA

Custom fit cushion with ties. Custom Sunbrella colours available for a 40% Surcharge

MSRP: \$90 EA. SELL PRICE: **\$70 EA.**

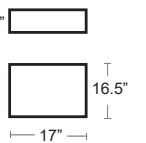

PEYTON GRANITE
GENERIC-56075



MILANO CHAR
GENERIC-56079



SPECTRUM CARBON
GENERIC-48085



SPECTRUM DAFFODIL
GENERIC-48024



CANVAS GRANITE
GENERIC-5402



SPECTRUM EGGSHELL
GENERIC-48018



VOLT SILVER
GENERIC-58020

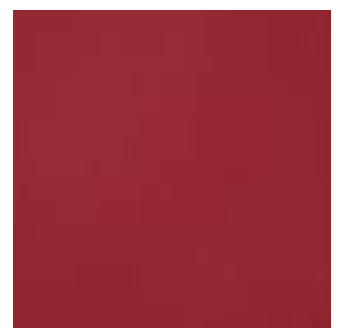

SPECTRUM CHERRY
GENERIC-48096

ARM CHAIRS

Sunset Rattan Arm Chair



Elegant one piece stackable polypropylene and fiberglass chair with perforated seat and back • UV Protected with anti-static and antioxidant additives to resist dust and deterioration • Suitable for indoor and outdoor environments

MSRP: \$130 EA. SELL PRICE: \$90 EA.

Sunny Side Chair Pg. 51

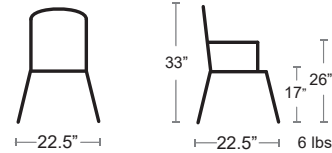

ANTRACITE
NVS-030



Castello Arm Chair



Stackable fiberglass reinforced polypropylene seat with anodized aluminum legs • UV Protected with anti-static and antioxidant additives to resist dust and deterioration • Suitable for indoor and outdoor environments

MSRP: \$130 EA. SELL PRICE: \$90 EA.

Castel Side Chair Pg. 51



WHITE
NVS-010-WHITE



ANTRACITE
NVS-010-ANTRACITE



MUSTARD
NVS-010-MUSTARD



RED
NVS-010-RED

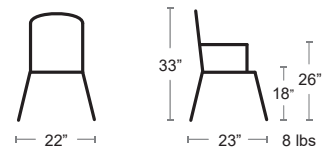

GREEN
NVS-010-GREEN





SIDE CHAIRS

Skyline Booth



MADE IN CHINA
 All weather resin wicker fish-bone weave • Powder coated aluminum frame • Built in cushion
 Cover Included
 MSRP: \$2600 EA. SELL PRICE: **\$1700 EA.**
 Lounge Pg.118-122

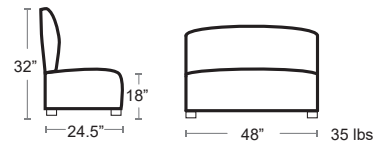

SKY-WBS-48x32-FB

SIDE CHAIRS

Como



MADE IN ITALY
 Tubular steel frame and seat • Stainless steel lattice back rest • E-coated powder coat finish
 Cushion included 900/50 - Black Brown
 MSRP: \$1400 EA. SELL PRICE: **\$910 EA.**
 Lounge Pg.128

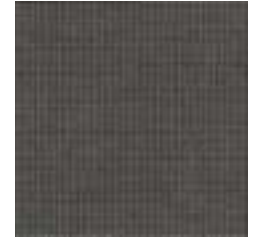

BRONZE1200-41

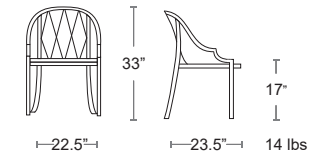

Lyze Teak



MADE IN ITALY
 Tubular aluminum frame • Teak seat • Stainless steel mesh back rest • E-coated powder coat finish
 MSRP: \$1530 EA. SELL PRICE: **\$995 EA.**
 Armchair Pg.15, Lounge Pg.131



WHITE + TEAK
 615T-23-82

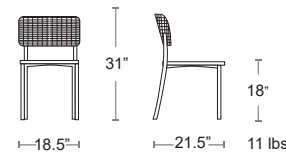

Rio Bench ALU



An informal idea for enjoying convivial moments outdoors. Rio Bench echoes the characteristic slats of the extendable Rio table • aluminum powder coated frame and seat • Adjustable height feet
 MSRP: \$900 EA. SELL PRICE: **\$720 EA.**
 Tables Pg.74

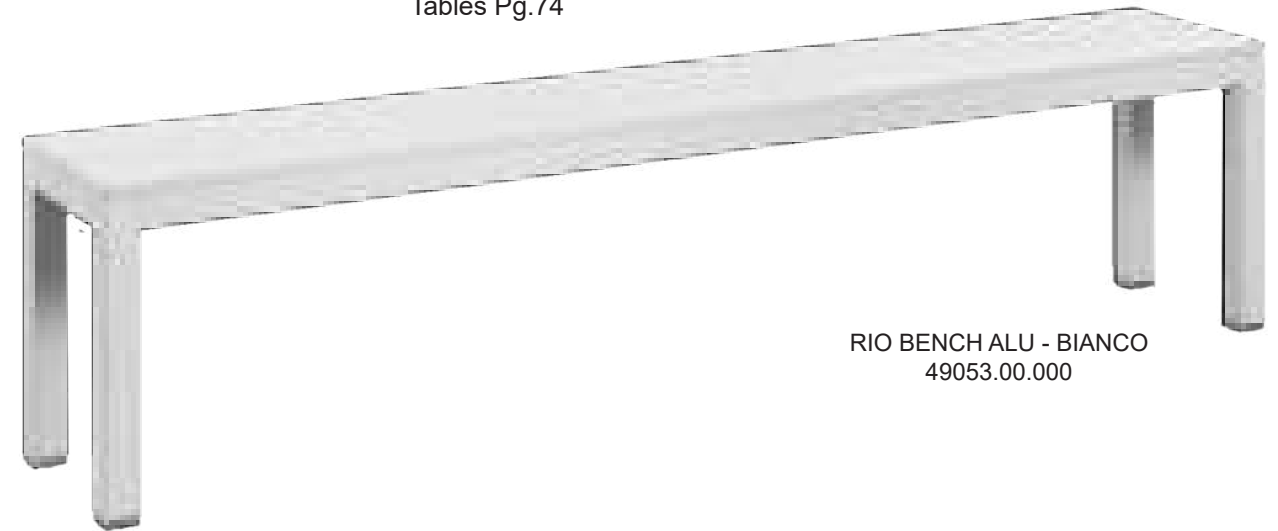

RIO BENCH ALU - BIANCO
 49053.00.000

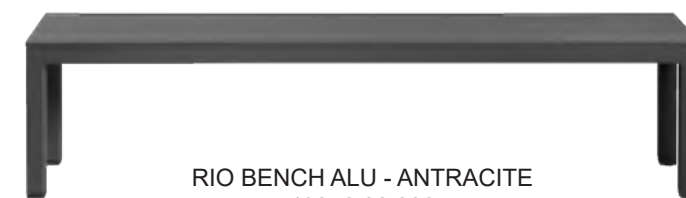

RIO BENCH ALU - ANTRACITE
 49052.02.000

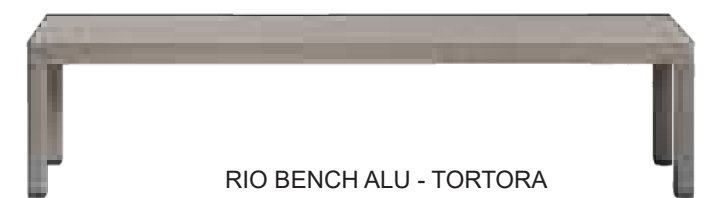

RIO BENCH ALU - TORTORA
 49059.10.000



Sid Bench



Aluminum wood look slats • Aluminum frame and legs
 MSRP: \$1530 EA. SELL PRICE: **\$995 EA.**

Find other Sid products
 Armchair Pg.18,
 Side Chair Pg.39,
 Bar/Counter Stool Pg.59,
 Backless Bar/Counter Pg.62,
 Picnic Tables Pg.70,
 Tables Pg.73, Table Tops Pg.97,
 Lounge Pg.133



WALNUT WITH
 IRON FRAME
 1022-22-404



GREY WITH
 BLACK FRAME
 1022-24-400

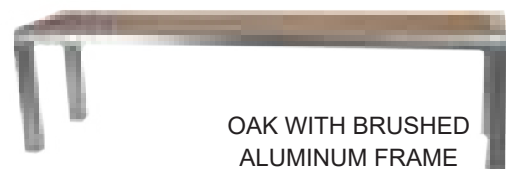

OAK WITH BRUSHED
 ALUMINUM FRAME
 1022-06-401

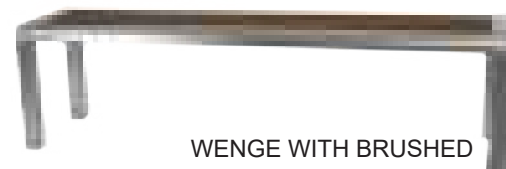

WENGE WITH BRUSHED
 ALUMINUM FRAME
 1022-06-402



SIDE CHAIRS

Riviera **emu** MADE IN ITALY

Tubular steel frame • Wrought Iron seat and back • E-coated powder coat finish

MSRP: \$800 EA. SELL PRICE: **\$520 EA.**

Lounge Pg.132, Bar Stool Pg.54,



BLACK
434-24

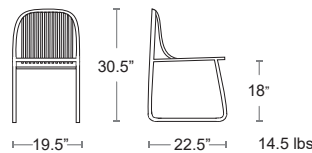

SIDE CHAIRS

Sole HD **emu** MADE IN ITALY

HEAVY DUTY Tubular steel frame • Steel mesh seat and back • E-coated powder coat finish

MSRP: \$650 EA. SELL PRICE: **\$420 EA.**

Armchair Pg.18



IRON
3402HD-22

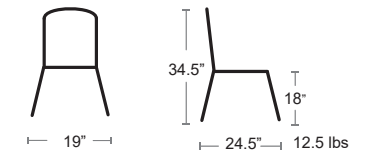

Thor Teak **emu** MADE IN ITALY

Tubular steel frame • Solid Teak seat • E-coated powder coat finish

MSRP: \$780 EA. SELL PRICE: **\$500 EA.**

Backless Bar Stool Pg.55



CHERRY + TEAK
655T-50-82



IRON + TEAK
655T-22-82

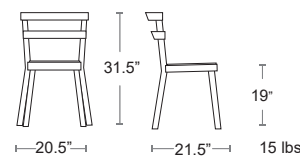

Apero **emu** MADE IN ITALY

Tubular steel frame • Wrought Iron seat and back • E-coated powder coat finish

MSRP: \$620 EA. SELL PRICE: **\$400 EA.**

Armchair Pg.17, Bar/Counter Stool Pg.54



MARINE BLUE
1300-16



BLACK
1300-24

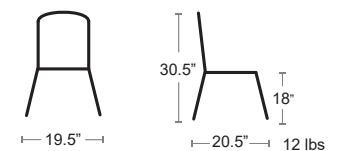

Topper **emu** MADE IN ITALY

Tubular steel frame • Steel mesh seat and back • E-coated powder coat finish

MSRP: \$620 EA. SELL PRICE: **\$400 EA.**

Armchair Pg.18



IRON
150-22

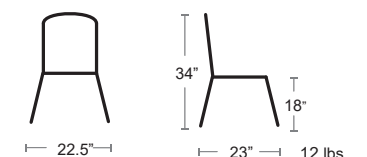

SIDE CHAIRS



Sid Wicker **emuamericas**

Tubular aluminum frame • All-Weather Wicker seat and back
MSRP: \$600 EA. **SELL PRICE: \$390 EA.**
Armchair Pg.17, Bar/Counter Stool Pg. 57

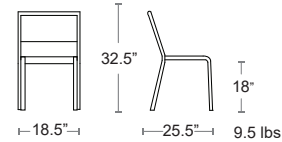

BLACK + GREY
1030-24-76

SIDE CHAIRS



Anna RAL **emuamericas**

Square tubular aluminum frame • Solid aluminum seat and slat back
CUSTOMIZE YOUR ANNA CHAIR
188 DIFFERENT COLOURS

Brushed aluminum powder coated in an available RAL colour • Special Order
MSRP: \$800 EA. **SELL PRICE: \$520 EA.**
Bar Stool Pg.56, Backless Bar Pg. 57



See swatches
Pg.198

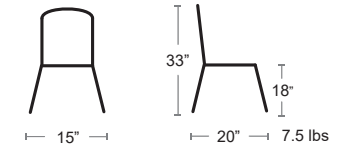

1004-RAL



Elly **emuamericas**

Tubular powder coated frame • All weather wicker seat and back
MSRP: \$580 EA. **SELL PRICE: \$380 EA.**
Bar Stool Pg.55

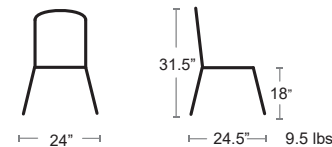

DRIFTWOOD + GREY
1010-500-74



Segno **emuamericas**

Square tubular steel frame • Steel slat seat and back • E-coated powder coat finish
MSRP: \$550 EA. **SELL PRICE: \$360 EA.**

Armchair Pg.20
Bar/Counter Stool Pg.56
Bench Pg.159

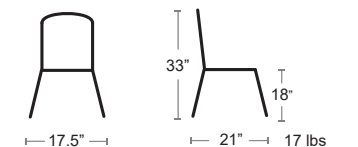

IRON
263-22



Anna **emuamericas**

Square tubular aluminum frame • Solid aluminum seat and slat back
Brushed aluminum with lacquered clear coat
MSRP: \$550 EA. **SELL PRICE: \$360 EA.**
Bar Stool Pg.56, Backless Bar Pg. 57

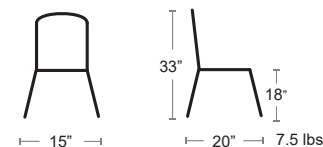

ALUMINUM
1004-00



Sid **emuamericas**

Square tubular aluminum frame • Wood look aluminum slat seat and back
MSRP: \$540 EA. **SELL PRICE: \$350 EA.**



WENGE WITH BRUSHED
ALUMINUM FRAME
1020-06-402



OAK WITH BRUSHED
ALUMINUM FRAME
1020-06-401



GREY WITH
BLACK FRAME
1020-24-400

Find other Sid products
Armchair Pg.18,
Bench Pg.34,
Bar/Counter Stool Pg.59,
Backless Bar/Counter Pg.62,
Picnic Tables Pg.70,
Tables Pg.73, Table Tops Pg.97,
Lounge Pg.133

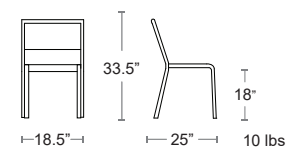

WALNUT WITH
IRON FRAME
1020-22-404

SIDE CHAIRS

Mom **emu** MADE IN ITALY

Tubular steel frame • Solid steel slat seat and back • E-coated powder coat finish

MSRP: \$540 EA. SELL PRICE: **\$350 EA.**

Armchair Pg.20, Bar/Counter Stool Pg.55



CURRY YELLOW
639-62



MARINE BLUE
639-16



CEMENT
639-73



BRONZE
639-41



CHERRY
639-50

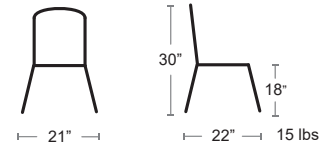

SIDE CHAIRS

Darwin **emu** MADE IN ITALY

Tubular steel frame • Steel mesh seat and back • E-coated powder coat finish

MSRP: \$490 EA. SELL PRICE: **\$320 EA.**

Armchair Pg.21, Bar/Counter Stool Pg.58, Tables Pg.84/854, Lounge Pg.129



BRONZE
521-41



BLACK
521-24



WHITE
521-23



CEMENT
521-73



CHERRY
521-50

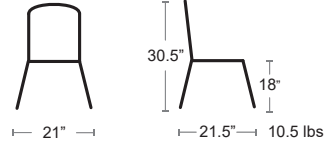

Thor **emu** MADE IN ITALY

Tubular steel frame • Solid steel seat • E-coated powder coat finish

MSRP: \$540 EA. SELL PRICE: **\$350 EA.**

Backless Bar/Counter Stool Pg.60



CHERRY
655-50



IRON
655-22

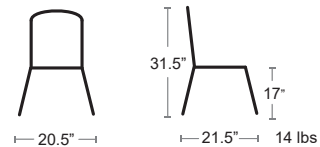

Bridge **emu** MADE IN ITALY

Tubular steel frame • Steel slat seat and back • E-coated powder coat finish

MSRP: \$490 EA. SELL PRICE: **\$320 EA.**

Armchair Pg.21, Bar/Counter Stool Pg.56



BLACK
146-24



Star **emu** MADE IN ITALY

Tubular steel frame • Steel seat and back • E-coated powder coat finish

MSRP: \$520 EA. SELL PRICE: **\$340 EA.**

Armchair Pg.20, Bar/Counter Stool Pg.57, Table Pg.75, Lounge Pg.130



BLUE
161-61



GREEN
161-60



BRONZE
161-41

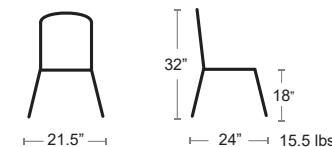

Coupole **emu** MADE IN ITALY

Tubular steel frame • Cut design steel seat and back • E-coated powder coat finish

MSRP: \$450 EA. SELL PRICE: **\$295 EA.**

Bar Stool Pg.58



WHITE
440-23



IRON
440-22



CURRY YELLOW
440-62

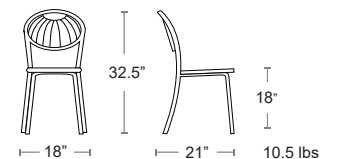

SIDE CHAIRS



Marco Sling



Square tubular aluminum powder coated frame • Batyline seat and back

MSRP: \$430 EA. SELL PRICE: **\$280 EA.**

Arm Chair Pg.23, Bar Stool Pg.60/61, Tables Pg.89

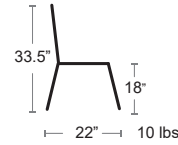

SILVER / BATYLINE
516S-BT-GS



ANTRACITE / BATYLINE
516S-BT-GA



Marco Wicker



Square tubular aluminum powder coated frame • Viro wicker seat and back

MSRP: \$430 EA. SELL PRICE: **\$280 EA.**

Arm Chair Pg.24, Bar Stool Pg.60/61, Tables Pg.89

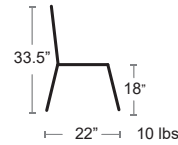

ANTRACITE / GRAPHITE
516S-SW-BA



SILVER / GRAPHITE
516S-SW-BS



Marco Polywood



Square tubular aluminum powder coated frame • Polywood seat and back

MSRP: \$430 EA. SELL PRICE: **\$280 EA.**

Arm Chair Pg.24, Bar Stool Pg.61/62, Tables Pg.89



ANTRACITE / TEAK
516S-PW-TA



ANTRACITE / GREY
516S-PW-GA



SILVER / GREY
516S-PW-GS

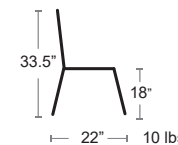

SILVER / TEAK
516S-PW-TS

SIDE CHAIRS

Croisette Side Chair

SERRALUNGA CATAS

Stackable monobloc chair made of fiberglass reinforced polypropylene. With its simple clean lines it is suitable for living/dining areas in contract applications. UV protected. Suitable for indoor and outdoor environments.

MSRP: \$420 EA. SELL PRICE: **\$270 EA.**

Arm Chair Pg.23



LIGHT GREEN
SL-CROISSETTE5635C



ANTRACITE
SL-CROISSETTE447C

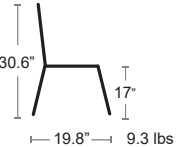

Ronda 2.0

emu

Tubular steel frame • Extended steel mesh seat and back • E-coated powder coat finish

MSRP: \$420 EA. SELL PRICE: **\$270 EA.**

Arm Chair Pg.22, Bar/Counter Stool Pg.59



WHITE
457-23



MAPLE RED
457-26



MARINE BLUE
457-16





BLACK
457-24



BRONZE
457-41



SIDE CHAIRS

Ronda  **emu** 
 Tubular steel frame • Steel mesh seat and back • E-coated powder coat finish
 MSRP: \$400 EA. SELL PRICE: **\$260 EA.**
 Arm Chair HD Pg.22, Bar/Counter Stool Pg.54

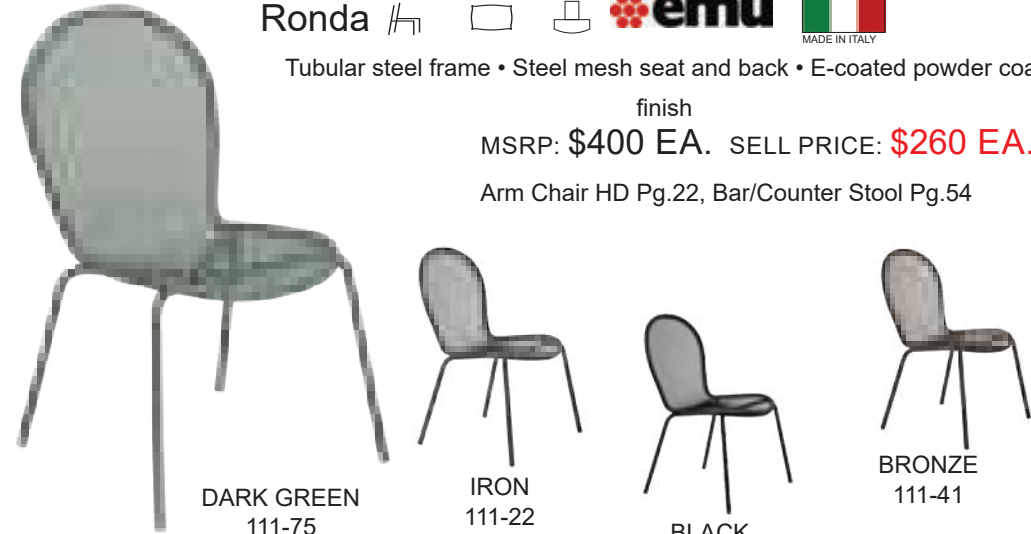

DARK GREEN 111-75
IRON 111-22
BLACK 111-24
BRONZE 111-41



SIDE CHAIRS

Africa  **VONDOM** 
 Tubular resin and fiberglass frame • Solid resin and fiberglass seat and back • UV Protected
 MSRP: \$370 EA. SELL PRICE: **\$240 EA.**
 Armchair Pg.22, Bar Stool Pg.63



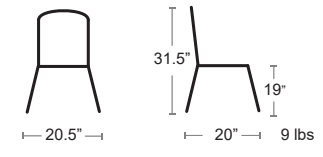

WHITE 65036-WHITE
BLACK 65036-BLACK
RED 65036-RED



Milo  **emuamericas** 
 Outdoor/Indoor stacking chair in bright cheerful colours • Constructed of thermoplastic polymer (PPL)
 MSRP: \$370 EA. SELL PRICE: **\$240 EA.**





BLUE 9007-14
WHITE 9007-01
RED 9007-31
ORANGE 9007-68
GREEN 9007-59

Olly  **emuamericas** 
 Outdoor/Indoor stacking chair • Constructed of thermoplastic polymer (PPL)
 MSRP: \$320 EA. SELL PRICE: **\$210 EA.**
 Bar/Counter Stool Pg.63



ALUMINUM/GREEN 9008-05-59
ALUMINUM/ORANGE 9008-05-66
ALUMINUM/ANTRACITE 9008-05-22



Arc En Ciel  **emu** 
 Steel frame • Steel slat seat and back • E-coated powder coat finish • Folding
 MSRP: \$250 EA. SELL PRICE: **\$160 EA.**
 Tables Pg.90, Bistro Set Pg. 159



GREEN 314-60
IRON 314-22
BLUE 314-61
CHERRY 314-50



SIDE CHAIRS

Bit  **NARDI CATAS** 
YOUR OUTDOOR LIVING MADE IN ITALY

Uniformly colored fiberglass polypropylene resins with UV additives •

Matte finish • Non-slip feet • Recyclable resin.

MSRP: \$230 EA. MSRP: \$170 EA.

Net Arm Chair Pg.25, Bar Stool Pg.64, Lounge Pg.140-143



SENAPE
40328.56.000



SALICE
40328.04.000



CORALLO
40328.75.000



ANTRACITE
40328.02.000



TORTORA
40328.10.000



BIANCO
40328.00.000

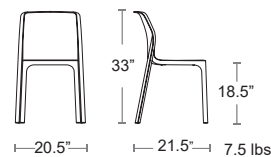

SIDE CHAIRS

Doga Bistrot  **NARDI CATAS** 
YOUR OUTDOOR LIVING MADE IN ITALY

Uniformly colored fiberglass polypropylene resins with UV additives •

Matte finish • Non-slip feet • Recyclable resin

MSRP: \$230 EA. MSRP: \$170 EA.

Arm Chair Pg.26, Lounge Pg.143/144



BIANCO
40255.00.000



AGAVE
40255.16.000



PERA
40255.18.000



ANTRACITE
40255.02.000



MARSALA
40255.21.000

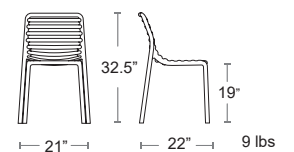

Flora  **emuamericas** 
MADE IN CHINA

Tubular aluminum frame • Solid aluminum slats seat and back • Polished aluminum

MSRP: \$230 EA. SELL PRICE: \$150 EA.

Sara Armchair Pg.25



POLISHED ALUMINUM
1000-00

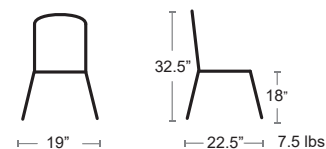

Trill Bistrot  **NARDI CATAS** 
YOUR OUTDOOR LIVING MADE IN ITALY

Uniformly colored fiberglass polypropylene resins with UV additives •

Matte finish • Non-slip feet • Recyclable resin

MSRP: \$230 EA. SELL PRICE \$170 EA.

Armchair Pg.26, Bar Stool Pg.64

See in stock cushions Pg.49



SENAPE
40253.56.000



OTTANIO
40253.49.000



GRIGIO
40253.03.000



AGAVE
40253.16.000



TORTORA
40253.10.000



ANTRACITE
40253.02.000



BIANCO
40253.00.000

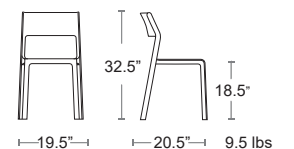

SIDE CHAIRS

Riva Bistrot



Uniformly colored fiberglass polypropylene resins with UV additives •
 Matte finish • Non-slip feet • Recyclable resin
 MSRP: \$200 EA. **SELL PRICE: \$130 EA.**



TORTORA
40247.10.000



AGAVE
40247.16.000



ROSSO
40247.07.000



ANTRACITE
40247.02.000



BIANCO
40247.00.000



CELESTE
40247.39.000

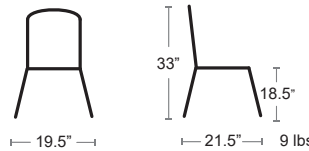

Arm Chair Pg.28, Faro Bar/Counter Stools Pg.66
 See in stock cushions Pg.49

SIDE CHAIRS

Costa Bistrot



Uniformly colored fiberglass polypropylene resins with UV additives •
 Matte finish • Non-slip feet • Recyclable resin
 MSRP: \$200 EA. **SELL PRICE: \$130 EA.**



CELESTE
40245.39.000



ROSSO
40245.07.000



BIANCO
40245.00.000



AGAVE
40245.16.000



ANTRACITE
40245.02.000



TORTORA
40245.10.000

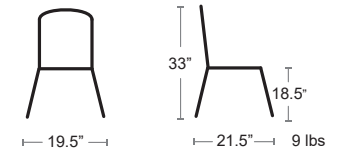

Arm Chair Pg.29, Faro Bar/Counter Stool Pg.66
 See in stock cushions Pg.49

Bora Bistrot



Uniformly colored fiberglass polypropylene resins with UV additives •
 Matte finish • Non-slip feet • Recyclable resin
 MSRP: \$200 EA. **SELL PRICE: \$130 EA.**



BIANCO
40243.00.000



AGAVE
40243.16.000



TORTORA
40243.10.000



ROSSO
40243.07.000



ANTRACITE
40243.02.000



CELESTE
40243.39.000

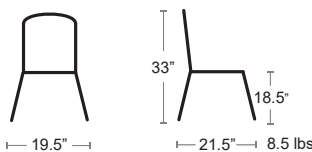

Arm Chair Pg.28, Lido Bar/Counter Stools Pg.65
 See in stock cushions Pg.49

Cushions sunbrella

MADE IN NORTH AMERICA

Custom fit cushion with ties. Custom Sunbrella cushions available for a 40% Surcharge
 MSRP: \$90 EA. **SELL PRICE: \$70 EA.**

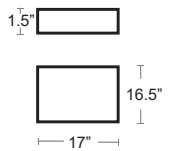

PEYTON GRANITE
GENERIC-56075



MILANO CHAR
GENERIC-56079



SPECTRUM CARBON
GENERIC-48085



SPECTRUM DAFFODIL
GENERIC-48024



CANVAS GRANITE
GENERIC-5402



SPECTRUM EGGSHELL
GENERIC-48018



VOLT SILVER
GENERIC-58020

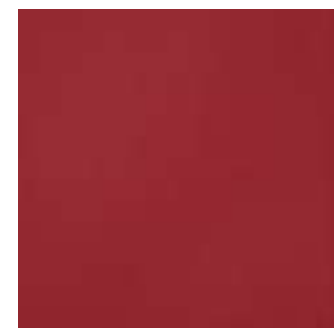

SPECTRUM CHERRY
GENERIC-48096

SIDE CHAIRS

Varia   **PAPATYA CATAS**  MADE IN TURKEY

Stackable monobloc chair made of fiberglass reinforced polypropylene •
With its simple clean lines it is suitable for all commercial applications •
Anti UV stabilized • Suitable for indoor and outdoor environments
MSRP: \$200 EA. SELL PRICE: **\$130 EA.**



RED
PPY-VARIA-04RED



ANTRACITE
PPY-VARIA-22ANTRACITE



WHITE
PPY-VARIA-01WHITE



WARM GREY
PPY-VARIA-17WARM GREY

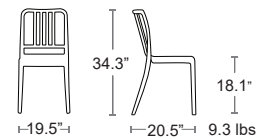

SIDE CHAIRS

Castel   **NOVUSI CATAS**  MADE IN TURKEY

Stackable fiberglass reinforced polypropylene seat with anodized aluminum legs.
UV Protected with anti-static and antioxidant additives to resist dust and deterioration.
Suitable for indoor and outdoor environments.

MSRP: \$120 EA. SELL PRICE: **\$80 EA.**

Castello Arm Chair Pg.30



RED
NVS-009-RED



ANTRACITE
NVS-009-ANTRACITE



GREEN
NVS-009-GREEN



MUSTARD
NVS-009-MUSTARD



WHITE
NVS-009-WHITE

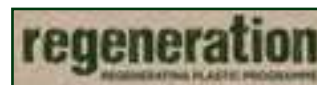
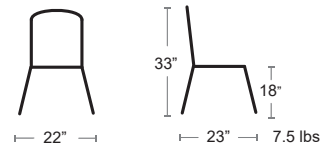

Regeneration Stack Mini  

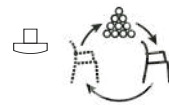

NARDI CATAS  YOUR OUTDOOR LIVING MADE IN ITALY

The Nardi Regeneration industrial program is creating a line of outdoor furniture specifically dedicated to regenerated plastic products, made of post-industrial and post-consumer polypropylene, which can in turn be recycled.
The uneven colour that changes into various shades of brown is not a defect but a specific feature of recycled plastic.
We call the color Terra, the natural colour of earth

MSRP: \$150 EA. SELL PRICE: **\$95 EA.**



TERRA
40357.44.000

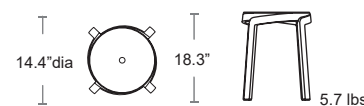

Stack Maxi Pg.67
Combo Tables Pg.93
Sipario Planters Pg.180-182



Sunny Rattan Side Chair  

NOVUSI CATAS  MADE IN TURKEY

Elegant one piece stackable polypropylene and fiberglass chair with perforated seat and back.
UV Protected with anti-static and antioxidant additives to resist dust and deterioration.
Suitable for indoor and outdoor environments.

MSRP: \$120 EA. SELL PRICE: **\$80 EA.**

Sunset Rattan Arm Chair Pg.30



ANTRACITE
NVS-029-ANTRACITE

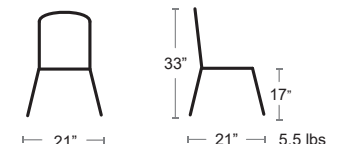



BAR STOOLS



Riviera Bar **emu** MADE IN ITALY

Tubular steel frame • Wrought Iron seat and back • E-coated powder coat finish

MSRP: \$1080 EA. SELL PRICE: **\$700 EA.**

Side Chair Pg.36, Lounge Pg.132

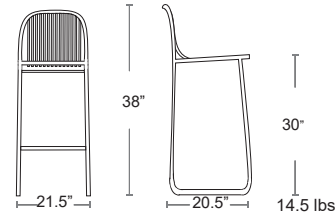

BLACK
436-24

BAR STOOLS



Mom Bar or Counter **emu** MADE IN ITALY

Tubular steel frame • Steel slat seat and back • E-coated powder coat finish

MSRP: \$870 EA. SELL PRICE: **\$570 EA.**

ADD NET \$40 FOR COUNTER HEIGHT
Armchair Pg.20, Side Chair Pg.40

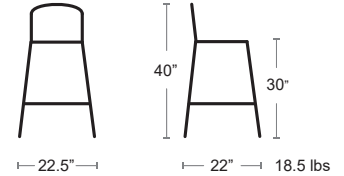

CURRY YELLOW
649-62

Apero Bar or Counter **emu** MADE IN ITALY

Tubular steel frame • Wrought Iron back and seat • E-coated powder coat finish

MSRP: \$970 EA. SELL PRICE: **\$630 EA.**

ADD NET \$40 FOR COUNTER HEIGHT

Arm Chair Pg.17, Side Chair Pg.37



MARINE BLUE
1303-16



BLACK
1303-24

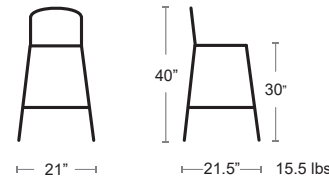

Elly Bar **emuamericas** MADE IN CHINA

Tubular powder coated frame • All weather wicker seat and back

MSRP: \$840 EA. SELL PRICE: **\$550 EA.**

Side Chair Pg.38



DRIFTWOOD + GREY
1210-500-74

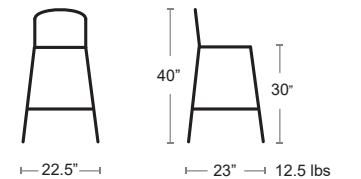

Ronda Bar or Counter **emu** MADE IN ITALY

Tubular steel frame • Extended steel mesh seat and back • E-coated powder coat finish

MSRP: \$890 EA. SELL PRICE: **\$580 EA.**

ADD NET \$40 FOR COUNTER HEIGHT

Armchair HD Pg.22, Side Chair Pg.44



CEMENT
128-73



IRON
128-22



BLACK
128-24



BRONZE
128-41

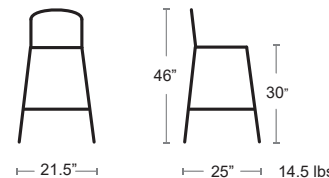

Thor Teak Bar **emu** MADE IN ITALY

Tubular steel frame • Solid Teak seat • E-coated powder coat finish

MSRP: \$840 EA. SELL PRICE: **\$550 EA.**

Side Chair Pg.36

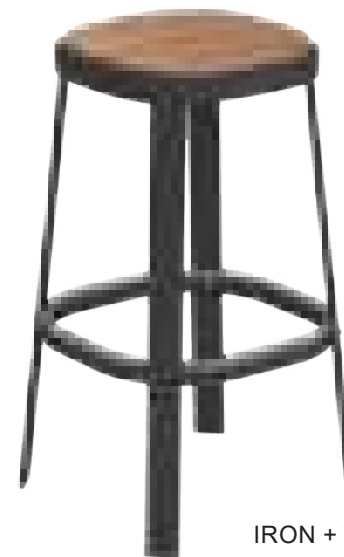

IRON + TEAK
657T-22-82

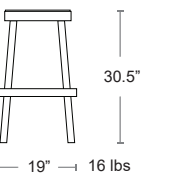

BAR STOOLS



Bridge Bar or Counter



Tubular steel frame • Steel slat seat and back • E-coated powder coat finish
 MSRP: \$810 EA. SELL PRICE: \$530 EA.
 ADD NET \$40 FOR COUNTER HEIGHT
 Armchair Pg.21, Side Chair Pg.41

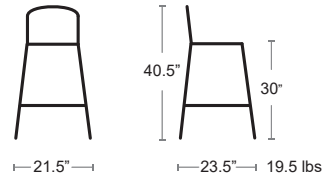

BLACK
148-24

BAR STOOLS

Side Chair Pg.38

Anna Backless Bar



Side Chair Pg.39



ALUMINUM
1206-00

Square tubular aluminum frame and seat
 Lacquered clear coat
 MSRP: \$630 EA. SELL PRICE: \$410 EA.

CUSTOMIZE YOUR ANNA STOOL
 188 DIFFERENT COLOURS
 Brushed aluminum powder coated in an available RAL colour
 Special Order
 MSRP: \$880 EA. SELL PRICE: \$570 EA.

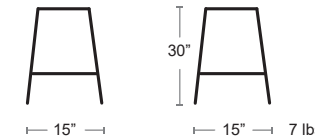

See swatches
Pg.198



1206-RAL



IRON
264-22

Segno Bar or Counter



Square tubular steel frame • Steel slat seat and back • E-coated powder coat finish
 MSRP: \$790 EA. SELL PRICE: \$520 EA.
 ADD NET \$40 FOR COUNTER HEIGHT
 Armchair Pg.20
 Side Chair Pg.39,
 Bench Pg.159

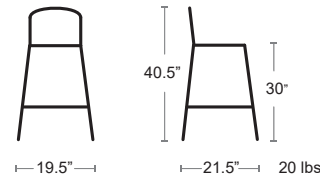

GREEN
164-60

Star Bar or Counter



Tubular steel frame • Solid steel seat and back • E-coated powder coat finish
 MSRP: \$780 EA. SELL PRICE: \$510 EA.
 ADD NET \$40 FOR COUNTER HEIGHT
 Armchair Pg.20, Side Chair Pg.40, Table Pg.75, Lounge Pg.130



BLUE
164-61



BRONZE
164-41

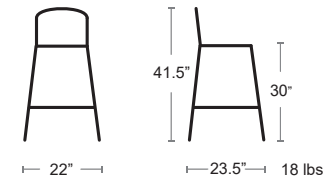

Side Chair Pg.38

Anna Bar



Side Chair Pg.39

Square tubular aluminum frame • Solid aluminum seat and slat back
 Lacquered clear coat
 MSRP: \$780 EA. SELL PRICE: \$510 EA.

CUSTOMIZE YOUR ANNA STOOL
 188 DIFFERENT COLOURS
 Brushed aluminum powder coated in an available RAL colour
 Special Order
 MSRP: \$1090 EA. SELL PRICE: \$710 EA.

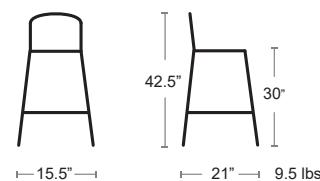

See swatches
Pg.198



1205-RAL

ALUMINUM
1205-00

Sid Wicker



Tubular aluminum frame • All- Weather Wicker seat and back
 MSRP: \$760 EA. SELL PRICE: \$500 EA.
 Armchair Pg.17, Side Chair Pg.58



BLACK + GREY
1230-24-76

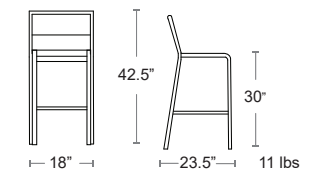

BAR STOOLS

Coupole Bar



Tubular steel frame • Cut design steel seat and back • E-coated powder coat finish

MSRP: \$740 EA. SELL PRICE: **\$480 EA.**

Side Chair Pg.41



CURRY YELLOW
442-62



IRON
442-22



WHITE
442-23

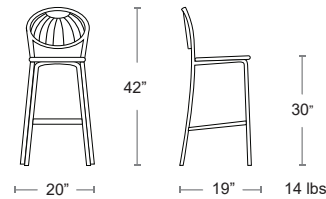

BAR STOOLS

Ronda 2.0 Bar or Counter



Tubular steel frame • Extended steel mesh seat and back • E-coated powder coat finish

MSRP: \$710 EA. SELL PRICE: **\$460 EA.**

ADD NET \$40 FOR COUNTER HEIGHT

Armchair Pg.22, Side Chair Pg.43



WHITE
459-23



MARINE BLUE
459-16



IRON
459-22



MAPLE RED
459-26



BLACK
459-24

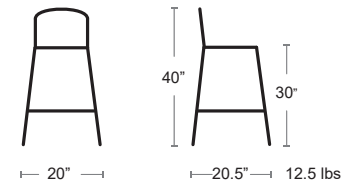

Darwin Bar or Counter



Tubular steel frame • Steel mesh seat and back • E-coated powder coat finish

MSRP: \$710 EA. SELL PRICE: **\$460 EA.**

ADD NET \$40 FOR COUNTER HEIGHT

Armchair Pg.21, Side Chair Pg.41, Table Pg.84/854, Lounge Pg.129



CHERRY
523-50



BLACK
523-24



WHITE
523-23



CEMENT
523-73



BRONZE
523-41

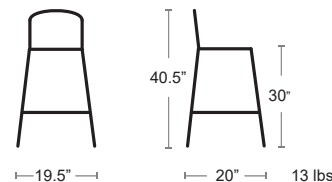

Sid Bar or Counter



Square tubular aluminum frame • Wood look aluminum slat seat and back

MSRP: \$680 EA. SELL PRICE: **\$440 EA.**

ADD NET \$40 FOR COUNTER HEIGHT

Find other Sid products
Armchair Pg.18,
Bench Pg.34,
Side Chair Pg.39,
Backless Bar/Counter Pg.62,
Picnic Tables Pg.70,
Tables Pg.73, Table Tops Pg.97,
Lounge Pg.133



WALNUT WITH IRON
FRAME
1220-22-404



GREY WITH BLACK
FRAME
1220-24-400



OAK WITH BRUSHED
ALUMINUM FRAME
1220-06-401



WENGE WITH BRUSHED
ALUMINUM FRAME
1220-06-402

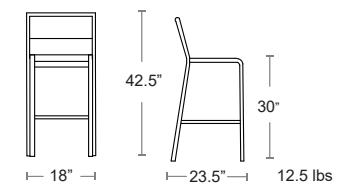

BAR STOOLS



Thor Backless Bar or Counter



Flat steel frame • Solid steel seat • E-coated powder coat finish

MSRP: \$620 EA. SELL PRICE: **\$390 EA.**
 ADD NET \$40 FOR COUNTER HEIGHT
 Side Chair Pg.40

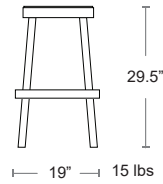

IRON
657-22

BAR STOOLS

Marco Polywood Bar With Arms



Square tubular aluminum powder coated frame • Polywood seat, back and armrests

MSRP: \$530 EA. SELL PRICE: **\$345 EA.**
 Armchair Pg.24 Side Chair Pg.42, Tables Pg.89



ANTRACITE / GREY
516B-PW-GA

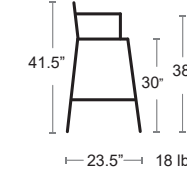

ANTRACITE/TEAK
516B-PW-TA



SILVER / TEAK
516B-PW-TS



SILVER / GREY
516B-PW-GS

Marco Sling Bar With Arms



Square tubular aluminum powder coated frame • Batyline seat and back • Polywood Armrests

MSRP: \$530 EA. SELL PRICE: **\$345 EA.**
 Armchair Pg.23, Side Chair Pg.42, Tables Pg.89



ANTRACITE / BATYLINE
516B-BT-GA

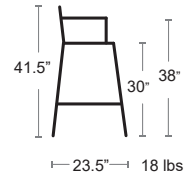

SILVER / BATYLINE
516B-BT-GS

Marco Sling Bar Armless



Square tubular aluminum powder coated frame • Batyline seat and back

MSRP: \$480 EA. SELL PRICE: **\$315 EA.**
 Armchair Pg.23, Side Chair Pg.42, Tables Pg.89



SILVER / BATYLINE
517B-BT-GS

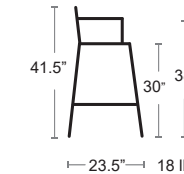

ANTRACITE / BATYLINE
517B-BT-GA

Marco Wicker Bar With Arms



Square tubular aluminum powder coated frame • Viro wicker seat and back • Polywood Armrests

MSRP: \$530 EA. SELL PRICE: **\$345 EA.**
 Armchair Pg.24 Side Chair Pg.42, Tables Pg.89



SILVER / GRAPHITE
516B-SW-BS

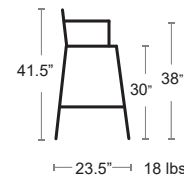

ANTRACITE / GRAPHITE
516B-SW-BA

Marco Wicker Bar Armless



Square tubular aluminum powder coated frame • Viro wicker seat and back

MSRP: \$480 EA. SELL PRICE: **\$315 EA.**
 Armchair Pg.24, Side Chair Pg.42, Tables Pg.89



SILVER / GRAPHITE
517B-SW-BS

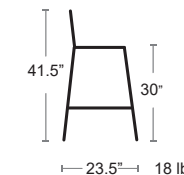

ANTRACITE / GRAPHITE
517B-SW-BA

BAR STOOLS

Marco Polywood Bar Armless

Square tubular aluminum powder coated frame • Polywood seat and back

MSRP: \$480 EA. **SELL PRICE: \$315 EA.**

Armchair Pg.24, Side Chair Pg.42, Tables Pg.89



ANTRACITE / GREY
517B-PW-GA



SILVER / TEAK
517B-PW-TS

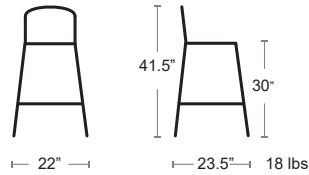

ANTRACITE/TEAK
517B-PW-TA



SILVER / GREY
517B-PW-GS

Find other Sid products
Armchair Pg.18,
Bench Pg.34,
Side Chair Pg.39,
Bar/Counter Stool Pg.59,
Picnic Tables Pg.70,
Tables Pg.73, Table Tops Pg.97,
Lounge Pg.133



WALNUT WITH IRON
FRAME
1221-22-404



OAK WITH BRUSHED
ALUMINUM FRAME
1221-06-401



GREY WITH BLACK
FRAME
1221-24-400

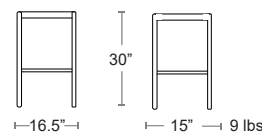

WENGE WITH BRUSHED
ALUMINUM FRAME
1221-06-402

Sid Backless Bar or Counter

Square tubular aluminum frame • Wood look aluminum slat seat and back

MSRP: \$540 EA. **SELL PRICE: \$350 EA.**
ADD NET \$40 FOR COUNTER HEIGHT

BAR STOOLS

Olly Bar or Counter

Outdoor/Indoor stacking stool • Constructed of thermoplastic polymer (PPL)

MSRP: \$520 EA. **SELL PRICE: \$340 EA.**
ADD NET \$40 FOR COUNTER HEIGHT
Side Chair Pg.45



ALUMINUM/GREEN
9208-05-59

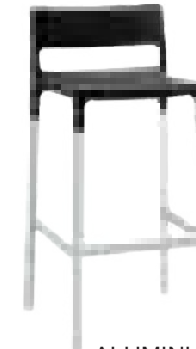

ALUMINUM/ANTRACITE
9208-05-22



ALUMINUM/ORANGE
9208-05-66

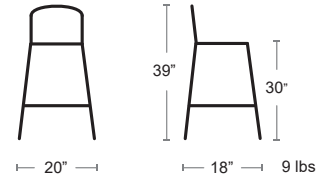

Africa Bar

Tubular resin and fiberglass frame • Solid resin and fiberglass seat and back
UV Protected

MSRP: \$450 EA. **SELL PRICE: \$290 EA.**

Armchair Pg.22, Side Chair Pg.45



WHITE
65029-WHITE

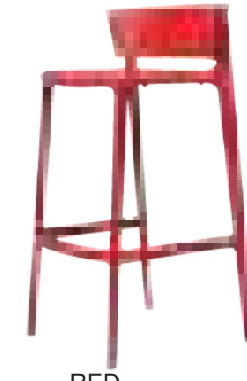
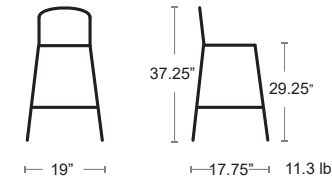

RED
65029-RED



BLACK
65029-BLACK

Brooklyn Backless Bar

Tubular resin and fiberglass frame • Solid resin and fiberglass seat
UV Protected

MSRP: \$390 EA. **SELL PRICE: \$260 EA.**



BLACK
65027-BLACK

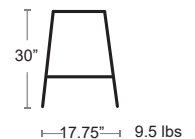

BAR STOOLS

Net Bar   **NARDI CATAS** 
 YOUR OUTDOOR LIVING
 Uniformly colored fiberglass polypropylene resins with UV additives

Matte finish • Non-slip feet • Recyclable resin
 MSRP: \$290 EA. **SELL PRICE: \$210 EA.**

Armchair Pg.25, Bit Side Chair Pg.46, Lounge Pg.140-143



CORALLO
40355.75.000



ANTRACITE
40355.02.000



TORTORA
40355.10.000



SALICE
40355.04.000



SENAPE
40355.56.000



BIANCO
40355.00.000

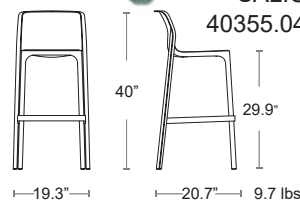

Trill Bar   **NARDI CATAS** 
 YOUR OUTDOOR LIVING
 Uniformly colored fiberglass polypropylene resins with UV additives

Matte finish • Non-slip feet • Recyclable resin
 MSRP: \$280 EA. **SELL PRICE: \$190 EA.**

Armchair Pg.26, Side Chair Pg.47



BIANCO
40350.00.000



ANTRACITE
40350.02.000



SENAPE
40350.56.000



GRIGIO
40350.03.000



TORTORA
40350.10.000



AGAVE
40350.16.000



OTTANIO
40350.49.000

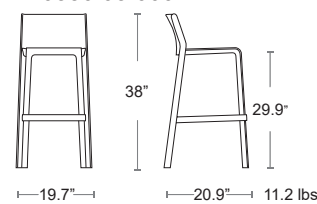

BAR STOOLS

Lido Bar   **NARDI CATAS** 
 YOUR OUTDOOR LIVING

Uniformly colored fiberglass polypropylene resins with UV additives

Matte finish • Non-slip feet • Recyclable resin
 MSRP: \$250 EA. **SELL PRICE: \$170 EA.**

Bora Armchair Pg.28, Bora Side Chair Pg.48



BIANCO
40344.00.000



ROSSO
40344.07.000



ANTRACITE
40344.02.000



AGAVE
40344.16.000

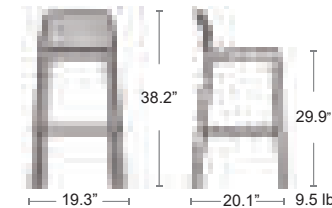

CELESTE
40344.39.000



TORTORA
40344.10.000

Lido Mini   **NARDI CATAS** 
 YOUR OUTDOOR LIVING

Uniformly colored fiberglass polypropylene resins with UV additives

Matte finish • Non-slip feet • Recyclable resin
 MSRP: \$250 EA. **SELL PRICE: \$170 EA.**

Bora Armchair Pg.28, Bora Side Chair Pg.48



ROSSO
40345.07.000



ANTRACITE
40345.02.000

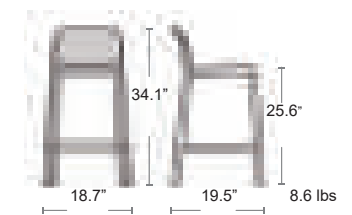

BAR STOOLS

Faro Bar   **NARDI CATAS** 
YOUR OUTDOOR LIVING MADE IN ITALY

Uniformly colored fiberglass polypropylene resins with UV additives •

Matte finish • Non-slip feet • Recyclable resin
MSRP: \$250 EA. SELL PRICE: **\$170 EA.**
Riva Armchair Pg.28, Riva Side Chair Pg.48

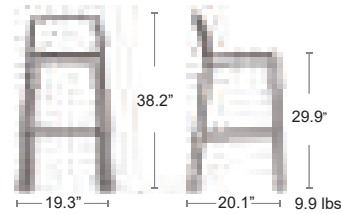

BAR STOOLS

regeneration
REGENERATING PLASTIC PROGRAMME

Regeneration Stack Maxi  

NARDI CATAS 
YOUR OUTDOOR LIVING MADE IN ITALY

The Nardi Regeneration industrial program is creating a line of outdoor furniture specifically dedicated to regenerated plastic products, made of post-industrial and post-consumer polypropylene, which can in turn be recycled. The uneven colour that changes into various shades of brown is not a defect but a specific feature of recycled plastic. We call the color Terra, the natural colour of earth

MSRP: \$250 EA. SELL PRICE: **\$170 EA.**



Stack Mini Pg.50
Combo Tables Pg.93
Sipario Planters Pg.180-182

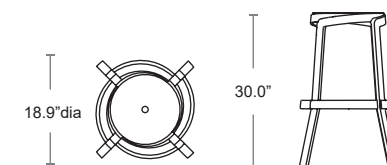

Faro Mini   **NARDI CATAS** 
YOUR OUTDOOR LIVING MADE IN ITALY

Uniformly colored fiberglass polypropylene resins with UV additives

Matte finish • Non-slip feet • Recyclable resin
MSRP: \$250 EA. SELL PRICE: **\$170 EA.**
Riva Armchair Pg.28, Riva Side Chair Pg.48

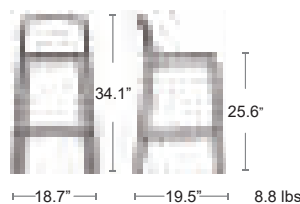



TABLES: DINING & BAR HEIGHT

Sid Picnic Table ADA

Aluminum wood look table top and bench, black aluminum frame and legs

Find other Sid products
 Armchair Pg.18,
 Bench Pg.34,
 Side Chair Pg.39,
 Bar/Counter Stool Pg.59,
 Backless Bar/Counter Pg.62,
 Tables Pg.73, Table Tops Pg.97,
 Lounge Pg.133



MSRP: \$8400 EA. SELL PRICE: **\$5500 EA.**

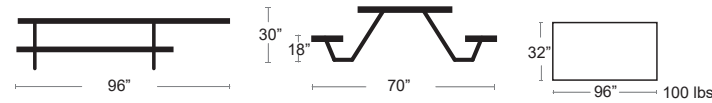

WALNUT WITH IRON FRAME
1821A-22-404

TABLES: DINING & BAR HEIGHT

Plus 4 220 Extension Table

Press-formed steel top and steel legs • E-coated powder coat finish

MSRP: \$4600 EA. SELL PRICE: **\$3000 EA.**



BLACK
3486-24

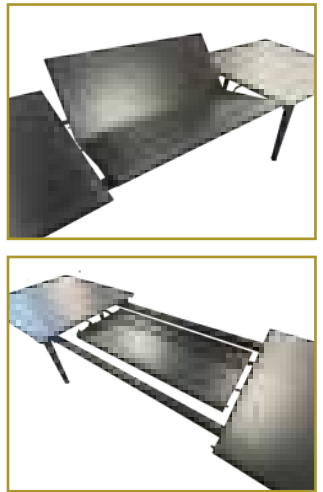
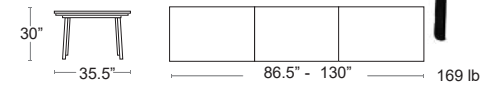

Sid Picnic Table Large & Small

Aluminum wood look table top and bench, black aluminum frame and legs



MSRP: \$8400 EA. SELL PRICE: **\$5500 EA.**
 Large - 1821-22-404

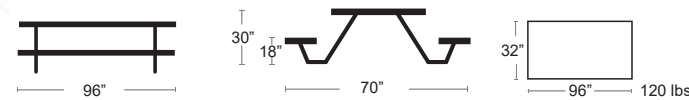

MSRP: \$7300 EA. SELL PRICE: **\$4700 EA.**
 Small - 1820-22-404



WALNUT WITH IRON FRAME

Plus 4 220 Extension Table

Press-formed steel top and steel legs • E-coated powder coat finish

MSRP: \$6800 EA. SELL PRICE: **\$4420 EA.**

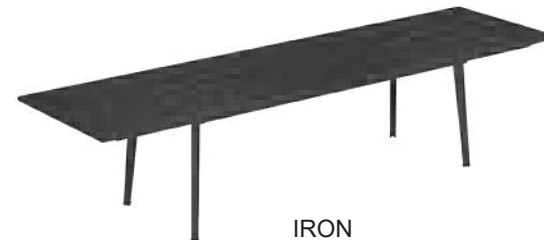

IRON
3486-22

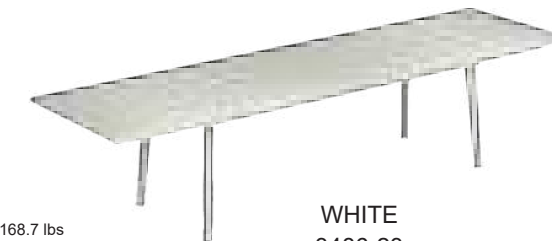
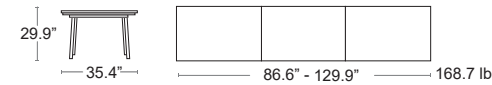

WHITE
3486-23



BRONZE
3486-41



Sid Picnic Table Cluster

Aluminum wood look table top and bench, black aluminum frame and legs



MSRP: \$5800 EA. SELL PRICE: **\$3800 EA.**

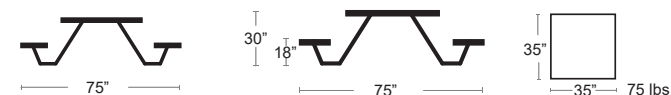

WALNUT WITH IRON FRAME
1830-22-404

Plus 4 160 Extension Table

Press-formed steel top and steel legs • E-coated powder coat finish

MSRP: \$5980 EA. SELL PRICE: **\$3890 EA.**

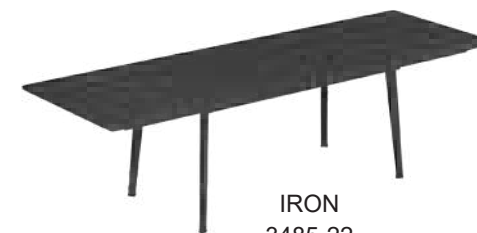

IRON
3485-22







WHITE
3485-23



BRONZE
3485-41



TABLES: DINING & BAR HEIGHT

Rimini     

63" Square Reclaimed Teak Dining Height Table - 8 Seater

Top reclaimed natural teak planks • Frame black powder coated stainless steel • 1.5" umbrella hole

MSRP: \$4200 EA. SELL PRICE: \$2700 EA.

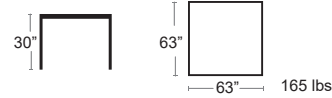

NATURAL
PRT633

TABLES: DINING & BAR HEIGHT

Sid Community Bar Table     

Tubular aluminum frame • Wood look powder coat aluminum slat top

MSRP: \$3300 EA. SELL PRICE: \$2100 EA.



WALNUT WITH IRON
FRAME
1550-22-404

Find other Sid products
Armchair Pg.18,
Bench Pg.34,
Side Chair Pg.39,
Bar/Counter Stool Pg.59,
Backless Bar/Counter Pg.62,
Picnic Tables Pg.70,
Table Tops Pg.97,
Lounge Pg.133



GREY WITH
BLACK FRAME
1550-24-400







WENGE WITH BRUSHED
ALUMINUM FRAME
1550-06-402



OAK WITH BRUSHED
ALUMINUM FRAME
1550-06-401



Yard Bar Table    

Tubular aluminum legs • Solid Aluminum top • E-Coated and Powder Coat Finish

MSRP: \$4080 EA. SELL PRICE: \$2650 EA.



IRON
538-24

BRONZE
538-41



Sid Community Dining Table     

Tubular aluminum frame • Wood look powder coat aluminum slat top

MSRP: \$2800 EA. SELL PRICE: \$1800 EA.



WALNUT WITH
IRON FRAME
1549-22-404



GREY WITH
BLACK FRAME
1549-24-400



OAK WITH BRUSHED
ALUMINUM FRAME
1549-06-401



WENGE WITH BRUSHED
ALUMINUM FRAME
1549-06-402



TABLES: DINING & BAR HEIGHT



Rio Extendable Table Aluminum



Tubular aluminum powder coated frame and legs, aluminum top

Removable leaf with under table storage • No umbrella hole • UV Protected

Replacement panels available

ALUMINUM

RIO 210 - Seats 8-10

MSRP: \$3000 EA. SELL PRICE: **\$2800 EA.**

RIO 140 - Seats 6-8

MSRP: \$2300 EA. SELL PRICE: **\$1900 EA.**



ANTRACITE
Rio 210 • 48852.02.000 Rio
140 • 48652.02.000

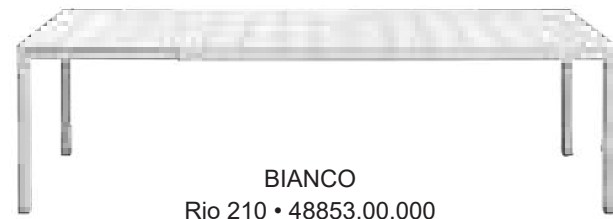

BIANCO
Rio 210 • 48853.00.000
Rio 140 • 48653.00.000



TORTORA
Rio 210 • 48859.10.000
Rio 140 • 48659.10.000

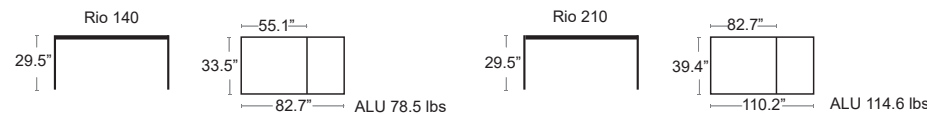

TABLES: DINING & BAR HEIGHT

Star Square 40"



Solid steel top • Tubular Steel legs • E-coated powder coat finish

MSRP: \$2250 EA. SELL PRICE: **\$1460 EA.**

Armchair Pg.20, Side Chair Pg.40, Bar/Counter Stool Pg. 57, Lounge Pg.130



IRON
303-22

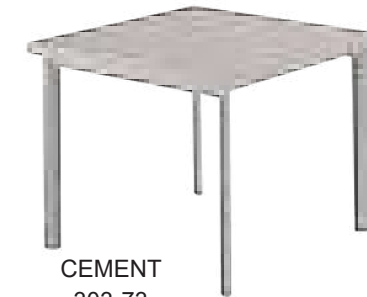

CEMENT
303-73



BRONZE
303-41



BLACK
303-24

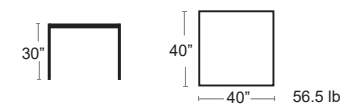

Rio Extendable Table Resin



Tubular aluminum powder coated frame and legs, resin and fiberglass dural top

Removable leaf with under table storage • No umbrella hole • UV Protected

Replacement panels available

RESIN

RIO 210 - Seats 8-10

MSRP: \$2000 EA. SELL PRICE: **\$1700 EA.**

RIO 140 - Seats 6-8

MSRP: \$1600 EA. SELL PRICE: **\$1400 EA.**

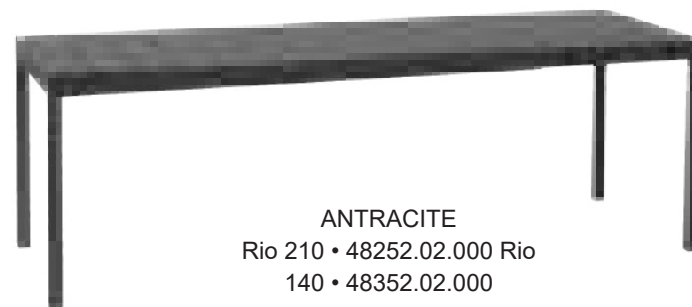

ANTRACITE
Rio 210 • 48252.02.000 Rio
140 • 48352.02.000

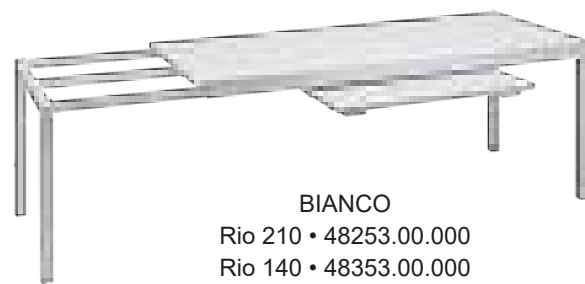

BIANCO
Rio 210 • 48253.00.000
Rio 140 • 48353.00.000



TORTORA
Rio 210 • 48259.10.000
Rio 140 • 48359.10.000

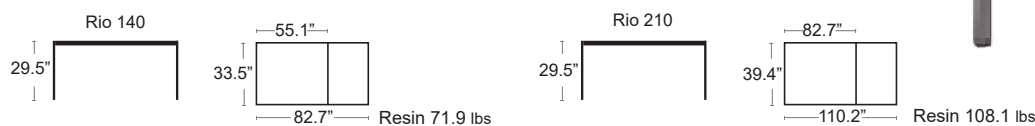

Libeccio Extendable Table



Resin Dural top • Tubular aluminum powder coated frame and legs • Removable leaf with under table storage

UV Protected • Replacement panel available

MSRP: \$1200 EA. SELL PRICE: **\$1000 EA.**



ANTRACITE
47552.02.000



TORTORA
47559.10.000

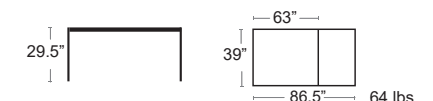

TABLES: DINING & BAR HEIGHT

Table System 48"x32"   

Solid steel top • Tubular steel legs • Tilt top • E-coated powder coat finish • Beveled edge table top

MSRP: \$1800 EA. SELL PRICE: **\$1170 EA.**



IRON
1133-22



BRONZE
1133-41

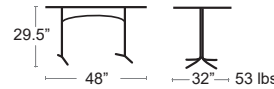

TABLES: DINING & BAR HEIGHT

Lock Square - Bar Height 32"   

Solid steel top • 1.5" Thick • Trumpet steel weighted base • Hole in base to accommodate a lock

E-coated powder coat finish • 68 lbs

MSRP: \$1700 EA. SELL PRICE: **\$1100 EA.**



CEMENT
473KH-73



BRONZE
473KH-41



IRON
473KH-22

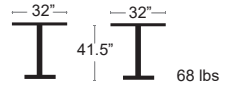





Table System Square 32"   

Solid steel top • Tubular steel legs • Tilt top • E-coated powder coat finish • Beveled edge table top

MSRP: \$1480 EA. SELL PRICE: **\$960 EA.**



BRONZE
1132-41



IRON
1132-22

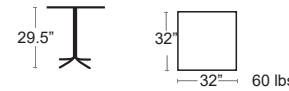

Lock Square 32"   

Solid steel top • 1.5" Thick • Trumpet steel weighted base • Hole in base to accommodate a lock

E-coated powder coat finish • 68 lbs

MSRP: \$1460 EA. SELL PRICE: **\$950 EA.**



IRON
473K-22



BRONZE
473K-41



CEMENT
473K-73

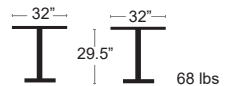





Table System Square 24"   

Solid steel top • Tubular steel legs • Tilt top • E-coated powder coat finish • Beveled edge table top

MSRP: \$1230 EA. SELL PRICE: **\$800 EA.**



IRON
1130-22



BRONZE
1130-41

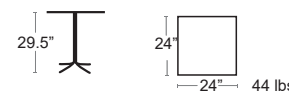

Lock Square 24"   

Solid steel top • 1.5" Thick • Trumpet steel weighted base • Hole in base to accommodate a lock

E-coated powder coat finish

MSRP: \$1200 EA. SELL PRICE: **\$780 EA.**



CEMENT
472K-73



IRON
472K-22



BRONZE
472K-41



TABLES: DINING & BAR HEIGHT

Drink Rectangle 48"x32"   

Steel mesh top • 1 1/4" thick • Tubular Steel legs • 3 levelers and 1 adjustable foot

E-coated powder coat finish

MSRP: \$1320 EA. SELL PRICE: \$860 EA.



TABLES: DINING & BAR HEIGHT

Cambi Round 48"   

Steel mesh top • 1 1/4" Thick • Tubular Steel legs • E-coated powder coat finish

3 levelers and 1 adjustable foot • Umbrella hole is 1.6"

MSRP: \$1400 EA. SELL PRICE: \$910 EA.

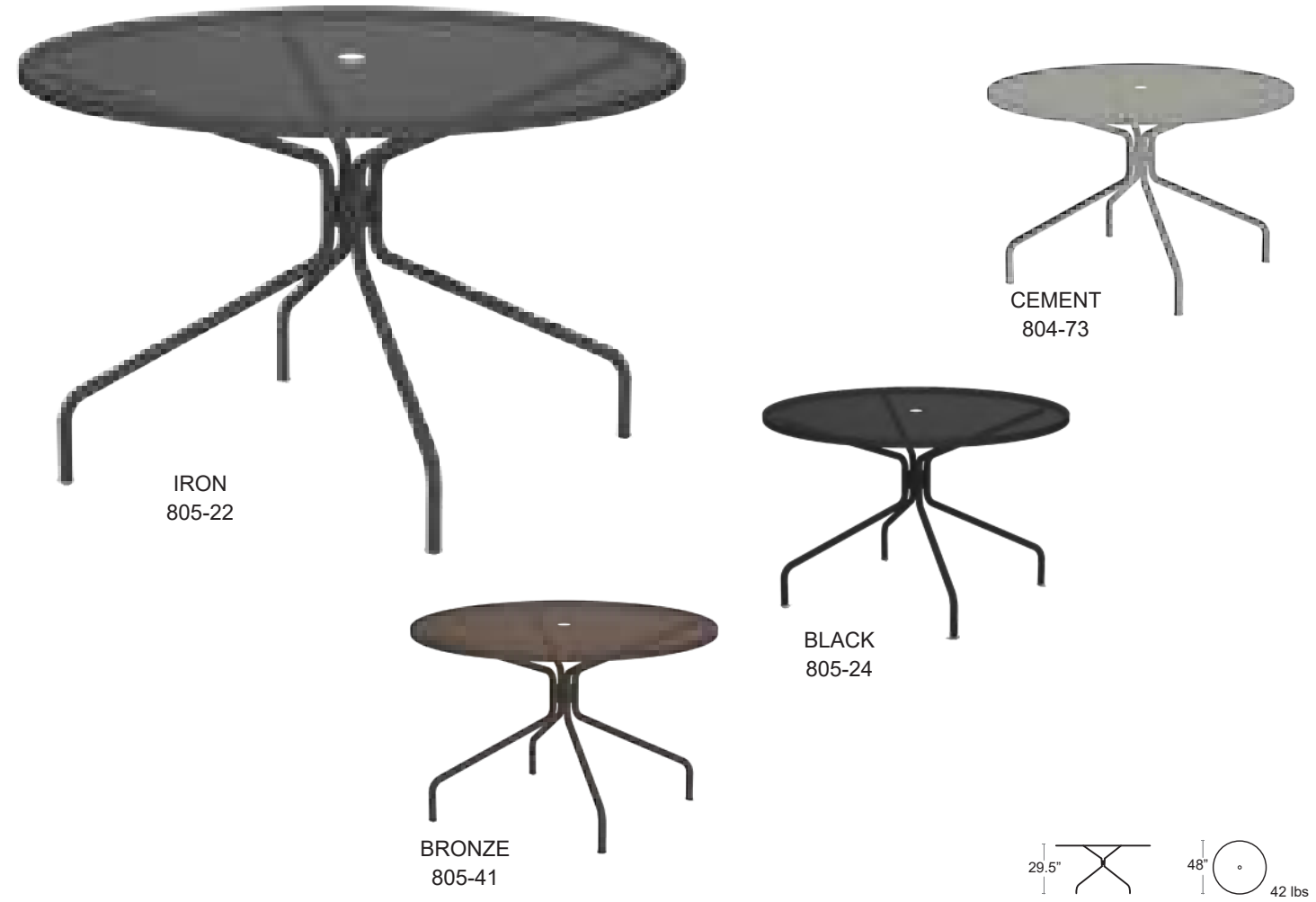

Cambi ADA Rectangle 48"x32"   

Steel mesh top • 1 1/4" Thick • Tubular Steel legs • E-coated powder coat finish

3 levelers and 1 adjustable foot

MSRP: \$1700 EA. SELL PRICE: \$1100 EA.



Cambi Rectangle 24"x32"   

Steel mesh top • 1 1/4" Thick • Tubular Steel legs • E-coated powder coat finish

3 levelers and 1 adjustable foot

MSRP: \$1000 EA. SELL PRICE: \$650 EA.



Cambi Round 42"   

Steel mesh top • 1 1/4" Thick • Tubular Steel legs • E-coated powder coat finish

3 levelers and 1 adjustable foot • Umbrella hole is 1.6"

MSRP: \$1250 EA. SELL PRICE: \$810 EA.



TABLES: DINING & BAR HEIGHT

Cambi Round 36"



Steel mesh top • 1 1/4" Thick • Tubular Steel legs • E-coated powder coat finish
3 levelers and 1 adjustable foot • Umbrella hole is 1.6"

MSRP: \$1180 EA. SELL PRICE: \$770 EA.

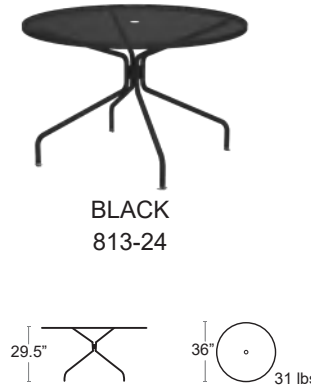
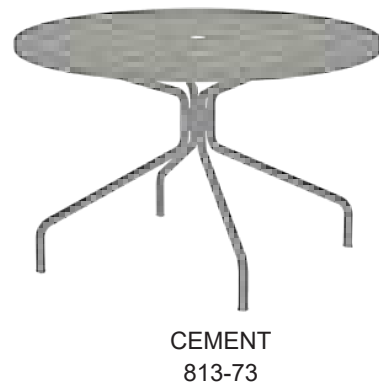

TABLES: DINING & BAR HEIGHT

Cambi Square 36"



Steel mesh top • 1 1/4" Thick • Tubular Steel legs • E-coated powder coat finish
3 levelers and 1 adjustable foot • Umbrella hole is 1.6"

MSRP: \$1110 EA. SELL PRICE: \$720 EA.



Cambi Round 32"



Steel mesh top • 1 1/4" Thick • Tubular Steel legs • E-coated powder coat finish
3 levelers and 1 adjustable foot • Umbrella hole is 1.6"

MSRP: \$940 EA. SELL PRICE: \$610 EA.



Cambi Square 32"



Steel mesh top • 1 1/4" Thick • Tubular Steel legs • E-coated powder coat finish
3 levelers and 1 adjustable foot • Umbrella hole is 1.6"

MSRP: \$1000 EA. SELL PRICE: \$650 EA.



Cambi Round - Bar Height 32"



Steel mesh top • 1 1/4" Thick • Tubular Steel legs • E-coated powder coat finish
3 levelers and 1 adjustable foot • Note no umbrella hole

MSRP: \$1020 EA. SELL PRICE: \$660 EA.

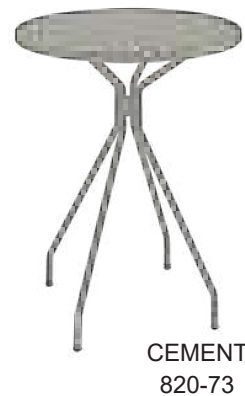

Cambi Square 24"



Steel mesh top • 1 1/4" Thick • Tubular Steel legs • E-coated powder coat finish
3 levelers and 1 adjustable foot • Note no umbrella hole

MSRP: \$780 EA. SELL PRICE: \$500 EA.

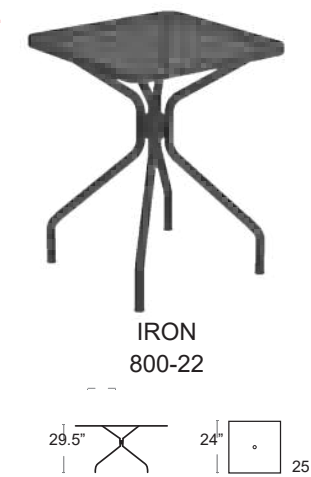

TABLES: DINING & BAR HEIGHT

Solid ADA Rectangle 48"x32"  **emu**  MADE IN ITALY

Solid steel top • 1 1/2" Thick • Tubular Steel legs • E-coated powder coat finish
3 levelers and 1 adjustable foot

MSRP: \$1560 EA. SELL PRICE: **\$1010 EA.**



IRON
837-22





BRONZE
837-41

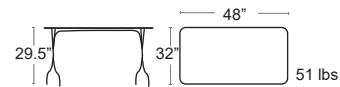

CEMENT
837-73



TABLES: DINING & BAR HEIGHT

Solid Square 32"  **emu**  MADE IN ITALY

Solid steel top • 1 1/2" Thick • Tubular Steel legs • E-coated powder coat finish
3 levelers and 1 adjustable foot • Umbrella hole is 1.6"

MSRP: \$1180 EA. SELL PRICE: **\$770 EA.**



BRONZE
829-41





CEMENT
829-73



IRON
829-22



Solid Rectangle 24"x32"  **emu**  MADE IN ITALY

Solid steel top • 1 1/2" Thick • Tubular Steel legs • E-coated powder coat finish
3 levelers and 1 adjustable foot

MSRP: \$940 EA. SELL PRICE: **\$610 EA.**



BRONZE
847-41

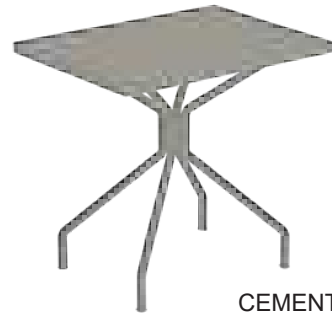

CEMENT
847-73



IRON
847-22

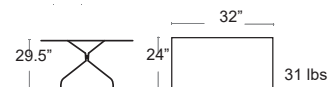

Solid Round 36"  **emu**  MADE IN ITALY

Solid steel top • 1 1/2" Thick • Tubular Steel legs • E-coated powder coat finish
3 levelers and 1 adjustable foot • Umbrella hole is 1.6"

MSRP: \$1180 EA. SELL PRICE: **\$770 EA.**



CEMENT
823-73



BRONZE
823-41



IRON
823-22

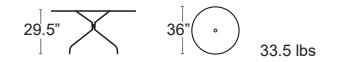

Solid Square 36"  **emu**  MADE IN ITALY

Solid steel top • 1 1/2" Thick • Tubular Steel legs • E-coated powder coat finish
3 levelers and 1 adjustable foot • Umbrella hole is 1.6"

MSRP: \$1280 EA. SELL PRICE: **\$830 EA.**



BRONZE
824-41



IRON
824-22



CEMENT
824-73

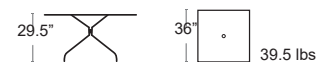

Solid Round 32"  **emu**  MADE IN ITALY

Solid steel top • 1 1/2" Thick • Tubular Steel legs • E-coated powder coat finish
3 levelers and 1 adjustable foot • Umbrella hole is 1.6"

MSRP: \$1110 EA. SELL PRICE: **\$720 EA.**



IRON
828-22





BRONZE
828-41

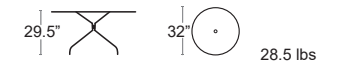

CEMENT
828-73



TABLES: DINING & BAR HEIGHT

Darwin Tilt Square 32"   

Solid steel top • 3/4" thick • Cross steel weighted base • Tilt top •
3 levelers and 1 adjustable foot • E-coated powder coat finish

MSRP: \$1300 EA. SELL PRICE: \$850 EA.





BLACK
529-24

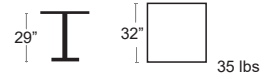

WHITE
529-23



TABLES: DINING & BAR HEIGHT

Darwin Tilt Square 28"   

Solid steel top • 3/4" thick • Cross steel weighted base • Tilt top •
3 levelers and 1 adjustable foot • E-coated powder coat finish

MSRP: \$1090 EA. SELL PRICE: \$710 EA.



BLACK
525-24



WHITE
525-23

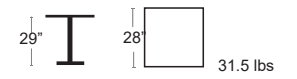

Darwin Tilt Square - Bar 28"   

Solid steel top • 3/4" thick • Cross steel weighted base • Tilt top •
3 levelers and 1 adjustable foot • E-coated powder coat finish

MSRP: \$1170 EA. SELL PRICE: \$760 EA.

Arm Chair Pg. 21, Side Chair Pg.41, Bar/Counter Pg.58, Lounge Pg.129



WHITE
528-23



BLACK
528-24

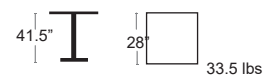

Darwin Tilt Round 32"   

Solid steel top • 3/4" thick • Cross steel weighted base • Tilt top •
3 levelers and 1 adjustable foot • E-coated powder coat finish

MSRP: \$1040 EA. SELL PRICE: \$680 EA.

Arm Chair Pg. 21, Side Chair Pg.41, Bar/Counter Pg.58, Lounge Pg.129





WHITE
849-23

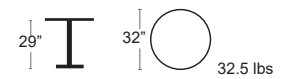

BLACK
849-24



Darwin Tilt Round 24"   

Solid steel top • 3/4" thick • Cross steel weighted base • Tilt top •
3 levelers and 1 adjustable foot • E-coated powder coat finish

MSRP: \$870 EA. SELL PRICE: \$570 EA.





BLACK
848-24



WHITE
848-23



TABLES: DINING & BAR HEIGHT

Nova Tables 48"x32"  

Solid steel top • Square steel legs • E-coated powder coat finish • Self Leveling

48" x 32" Bar

MSRP: \$1910 EA.

SELL PRICE: **\$1240 EA.**



WHITE
894-23

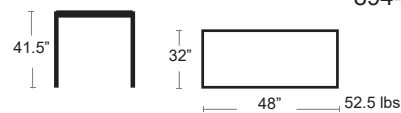

IRON
894-22



BRONZE
894-41



WHITE
854-23



BRONZE
854-41



IRON
854-22

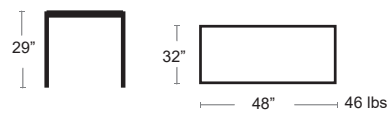

48" x 32" Dining 

MSRP: \$1460 EA.

SELL PRICE: **\$950 EA.**

36" Square Bar

MSRP: \$1910 EA.

SELL PRICE: **\$1240 EA.**



IRON
892-22

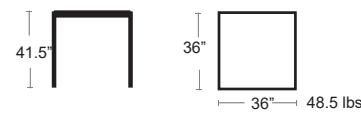

BRONZE
892-41



WHITE
892-23



WHITE
859-23



BRONZE
859-41



IRON
859-22

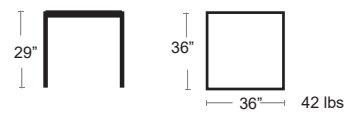

36" Square Dining 

MSRP: \$1400 EA.

SELL PRICE: **\$910 EA.**

Nova Square Tables 36"  

Solid steel top • Square steel legs • E-coated powder coat finish • Self Leveling

TABLES: DINING & BAR HEIGHT

Nova Square Tables 32"  

Solid steel top • Square steel legs • E-coated powder coat finish • Self Leveling

32" Square 

MSRP: \$700 EA.

SELL PRICE: **\$460 EA.**

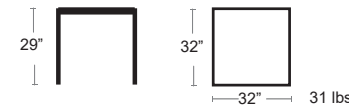

IRON
857-22



WHITE
857-23



BRONZE
857-41



BRONZE
891-41



IRON
891-22



WHITE
891-23

32" Square Bar

MSRP: \$1800 EA.

SELL PRICE: **\$1170 EA.**

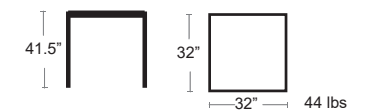

Nova 28" Square 

MSRP: \$680 EA.

SELL PRICE: **\$440 EA.**

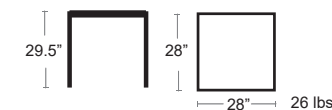

IRON
858-22







BRONZE
858-41



WHITE
858-23

TABLES: DINING & BAR HEIGHT

Bistro Square 30"    

Solid steel top • 3/4" thick • Trumpet steel weighted base • E-coated powder coat finish

MSRP: \$1200 EA. SELL PRICE: \$780 EA.



IRON
901-22



CEMENT
901-73



BRONZE
901-41

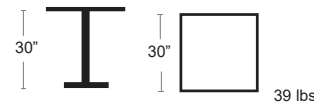

Bistro Round 32"    

Solid steel top • 3/4" thick • Trumpet steel weighted base • E-coated powder coat finish

32" Round Bar

MSRP: \$1130 EA.

SELL PRICE: \$735 EA.



IRON
902H-22



CEMENT
902H-73



BRONZE
902H-41



CEMENT
902-73



BRONZE
902-41



IRON
902-22

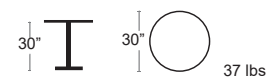

Bistro Round 24"    

Solid steel top • 3/4" thick • Trumpet steel weighted base • E-coated powder coat finish

24" Round Bar

MSRP: \$960 EA.

SELL PRICE: \$625 EA.



BRONZE
900H-41



CEMENT
900H-73



IRON
900H-22



BRONZE
900-41



IRON
900-22



CEMENT
900-73

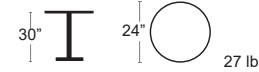
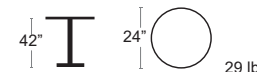

TABLES: DINING & BAR HEIGHT

Marco Polywood Aluminum Tables 



Square tubular aluminum powder coated frame • Polywood tabletop
An extra slat with the umbrella hole is included for tables with that option.



ANTRACITE/GREY



SILVER/GREY



ANTRACITE/TEAK



SILVER/TEAK

TABLE 48"x32"



DT516-48Q-GA • ANTRACITE & GREY
DT516-48Q-GS • SILVER & GREY
DT516-48Q-TA • ANTRACITE & TEAK
DT516-48Q-TS • SILVER & TEAK

MSRP: \$980 EA. SELL PRICE: \$640 EA.

TABLE 24"x32"



DT516-23Q-GA • ANTRACITE & GREY
DT516-23Q-GS • SILVER & GREY
DT516-23Q-TA • ANTRACITE & TEAK
DT516-23Q-TS • SILVER & TEAK

MSRP: \$650 EA. SELL PRICE: \$425 EA.

TABLE 36" SQUARE



DT516-36S-GA • ANTRACITE & GREY
DT516-36S-GS • SILVER & GREY
DT516-36S-TA • ANTRACITE & TEAK
DT516-36S-TS • SILVER & TEAK

MSRP: \$840 EA. SELL PRICE: \$550 EA.

TABLE 32" SQUARE





DT516-32S-GA • ANTRACITE & GREY
DT516-32S-GS • SILVER & GREY
DT516-32S-TA • ANTRACITE & TEAK
DT516-32S-TS • SILVER & TEAK

MSRP: \$800 EA. SELL PRICE: \$520 EA.

Armchair Pg.23/24, Side Chair Pg. 42,

Bar Stool Pg.60-62

TABLES: DINING & BAR HEIGHT

Arc En Ciel 44"x28"   

Solid steel top table and legs • E-coated powder coat finish • Folding

MSRP: \$940 EA. SELL PRICE: \$610 EA.

Side Chair Pg.45, Bistro Set Pg. 159







IRON
331-22

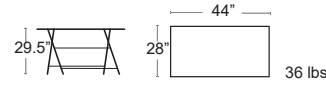

FOLDED



TABLES: DINING & BAR HEIGHT

Wood Textured Table 35"x59"    



Wood textured polypropylene and fiberglass table, requires assembly.
UV Protected with anti-static and antioxidant additives to resist dust and deterioration.

MSRP: \$690 EA. SELL PRICE: \$450 EA.

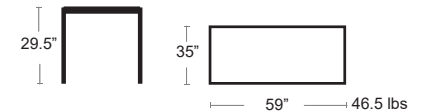

NVS-032-ANTRACITE



Arc En Ciel Round 32"   

Solid steel top table and legs • E-coated powder coat finish • Folding

MSRP: \$640 EA. SELL PRICE: \$415 EA.



IRON
346-22



Wood Textured Table 35" Square    



Wood textured polypropylene and fiberglass table, requires assembly.
UV Protected with anti-static and antioxidant additives to resist dust and deterioration.

MSRP: \$510 EA. SELL PRICE: \$330 EA.

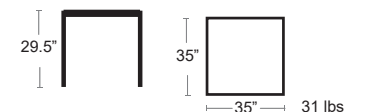

NVS-034-ANTRACITE



Arc En Ciel 20"x28"   

Solid steel top table and legs • E-coated powder coat finish • Folding

MSRP: \$570 EA. SELL PRICE: \$370 EA.



IRON
334-22

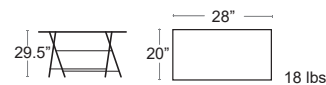

TABLES: DINING & BAR HEIGHT

Cube Rectangle    **NARDI CATAS**  
YOUR OUTDOOR LIVING
Resin and fiberglass slat top • Tubular resin and fiberglass legs • UV Protected

Cube 140
Dining Height
MSRP: \$760 EA.
SELL PRICE: **\$500 EA.**

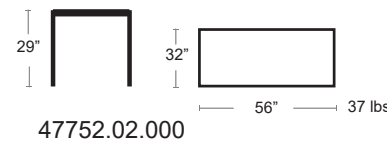

Cube 140
Bar Height

MSRP: \$1000 EA.
SELL PRICE: **\$650 EA.**

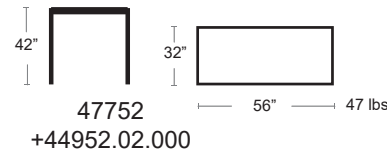

Cube 120
Dining Height
MSRP: \$660 EA.
SELL PRICE: **\$430 EA.**

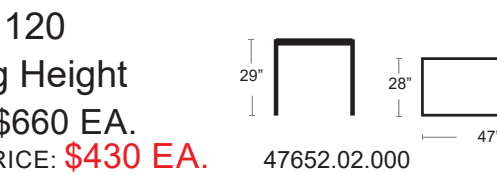
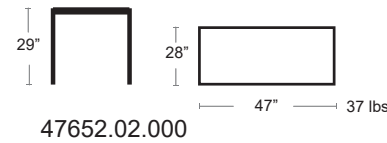

Cube 120
Bar Height

MSRP: \$910 EA.
SELL PRICE: **\$590 EA.**

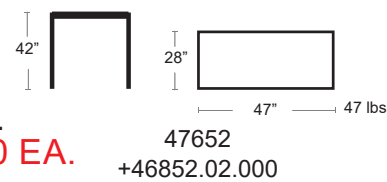

Cube Square    **NARDI CATAS**  
YOUR OUTDOOR LIVING
Resin and fiberglass slat top • Tubular resin and fiberglass legs • UV Protected

Cube 80
Dining Height
MSRP: \$510 EA.
SELL PRICE: **\$330 EA.**

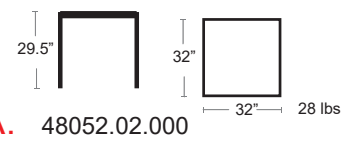

Cube 80
Bar Height

MSRP: \$720 EA.
SELL PRICE: **\$470 EA.**

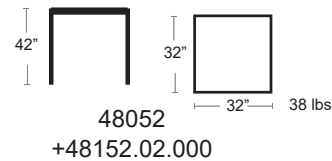

Cube 70
Dining Height
MSRP: \$470 EA.
SELL PRICE: **\$305 EA.**

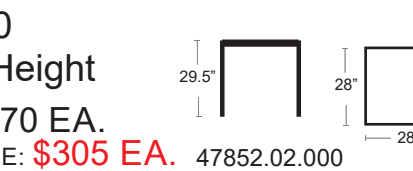
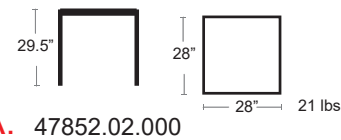



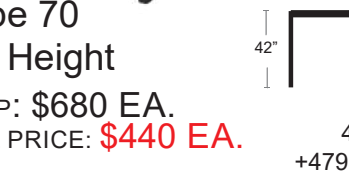
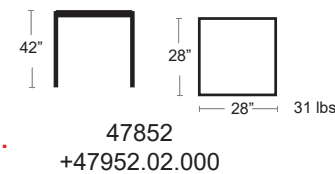

Cube 70
Bar Height

MSRP: \$680 EA.
SELL PRICE: **\$440 EA.**



TABLES: DINING & BAR HEIGHT

regeneration    **Regeneration Combo 70**  
YOUR OUTDOOR LIVING
The Nardi Regeneration industrial program is creating a line of outdoor furniture specifically dedicated to regenerated plastic products, made of post-industrial and post-consumer polypropylene, which can in turn be recycled. The uneven colour that changes into various shades of brown is not a defect but a specific feature of recycled plastic. We call the color Terra, the natural colour of earth



Dining Height
MSRP: \$600 EA.
SELL PRICE: **\$390 EA.**



40032.44.000

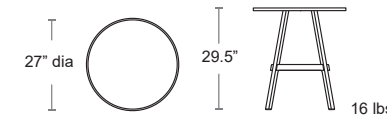





Stack Mini Pg.50
Stack Maxi Pg.67
Sipario Planters Pg.180-182

Bar Height
MSRP: \$670 EA.
SELL PRICE: **\$435 EA.**



40032.44.000
20 lbs +40031.44.000



regeneration    **Regeneration Combo 60**  
YOUR OUTDOOR LIVING



Dining Height
MSRP: \$520 EA.
SELL PRICE: **\$340 EA.**



40030.44.000



Stack Mini Pg.50
Stack Maxi Pg.67
Sipario Planters Pg.180-182

Bar Height
MSRP: \$590 EA.
SELL PRICE: **\$385 EA.**



40030.44.000
28 lbs +40031.44.000



TABLES: DINING & BAR HEIGHT

Clip Dining   **NARDI CATAS** 
YOUR OUTDOOR LIVING MADE IN ITALY

Resin and fiberglass perforated top • Tubular resin and fiberglass legs • UV Protected

Clip 80

MSRP: \$460 EA. **SELL PRICE: \$300 EA.**



ANTRACITE
40082.02.000

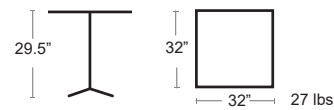

Clip 70

MSRP: \$440 EA. **SELL PRICE: \$285 EA.**



ANTRACITE
40084.02.000

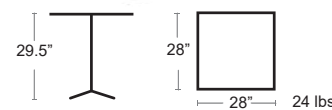

Spritz Table Dining & Lounge Height **NARDI CATAS** YOUR OUTDOOR LIVING MADE IN ITALY

Solid resin and fiberglass top with solid legs • UV Protected • Aluminum weights inside the leg assembly

Removable stem for height variations

MSRP: \$300 EA. **SELL PRICE: \$195 EA.**



DINING

LOUNGE



BIANCO
40058.00.000



ANTRACITE
40058.02.000



TORTORA
40058.10.000



CELESTE
40058.39.000



ROSSO
40058.07.000



AGAVE
40058.16.000

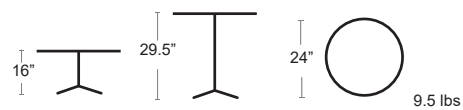



TABLES: TOPS & BASES

Emu Tabletop & Base Fit Guide

			○	○	□	□	□	□	□
		EMU TABLE TOPS	30" #1481	35" #1482	26" #1490	30" #1491	35" #1492	26"x30" #1494	48"x30" #1495
ZAK BASES	DINING	1361	★	★	★	★		★	
	DINING	1362					★		
	DOUBLE DINING	1363							★
	BAR	1364	★		★	★		★	
	DOUBLE BAR	1365							★

BigBaba.com will provide the necessary hardware if both top and base are purchased on the same Purchase Order.

Find other Sid products - Armchair Pg.18, Bench Pg.34, Side Chair Pg.39, Bar/Counter Stool Pg.59, Backless Bar/Counter Pg.62, Picnic Tables Pg.70, Tables Pg.73, Lounge Pg.133

Sid Table Tops emuamericas

Aluminum border tops • Wood look powder coated slats • Pre-drilled stainless steel inserts
1.75" Thick • UV protected

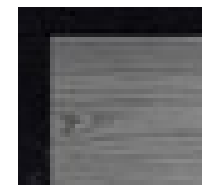

Black+GREY (24-400)

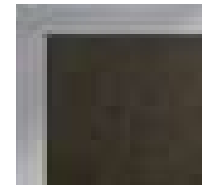

Alum+WENGE (06-402)



Alum+Oak (06-401)



Iron+Walnut (22-404)



SIZE	WEIGHT	MSRP	SELL
#1490 □ 26"	10 lbs	\$680	\$440
#1491 □ 30"	12 lbs	\$820	\$530
#1492 □ 35"	22 lbs	\$1020	\$660
#1494 □ 26"x30"	12 lbs	\$790	\$515
#1495 □ 48"x30"	22 lbs	\$1340	\$870
#1481 ○ 30"	10 lbs	\$670	\$435
#1482 ○ 35"	12 lbs	\$850	\$550

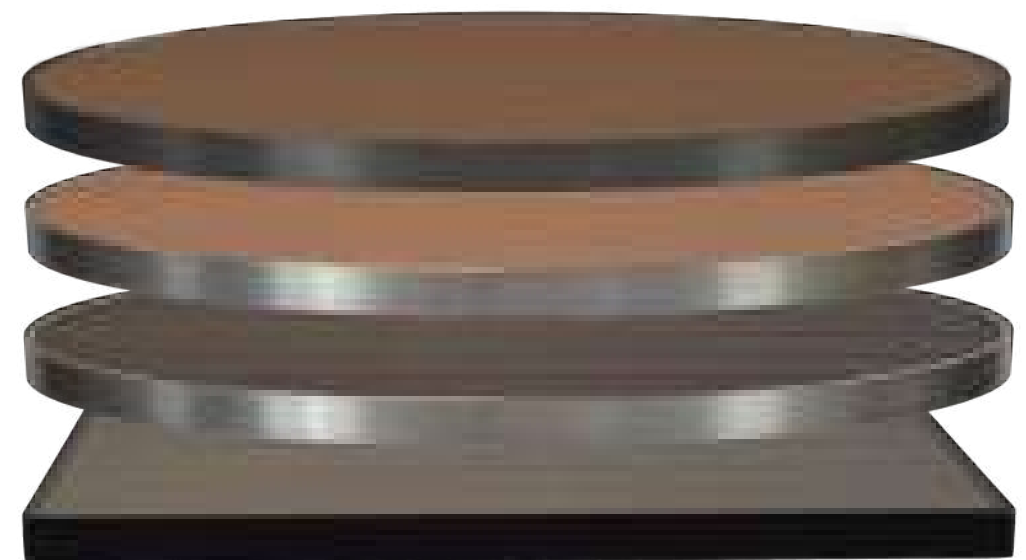

TABLES: TOPS & BASES

Zak Double Bar Height Base emuamericas

See Table Top & Base Fit Guide Pg.97

Cast aluminum weighted base • Powder coated
MSRP: \$640 EA. SELL PRICE: **\$415 EA.**



TABLES: TOPS & BASES

Zak Dining Height 5 Prong Base emuamericas

See Table Top & Base Fit Guide Pg.97

Cast aluminum weighted base • Powder coated
MSRP: \$710 EA. SELL PRICE: **\$460 EA.**

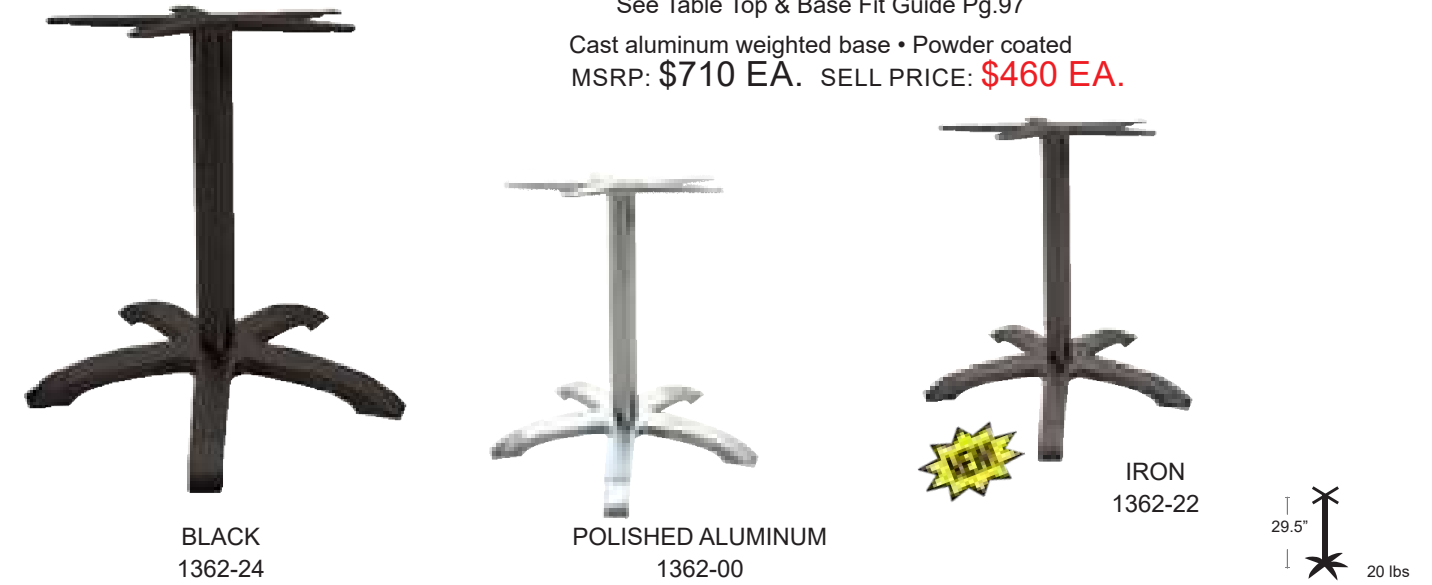

Zak Double Dining Height Base emuamericas

See Table Top & Base Fit Guide Pg.97

Cast aluminum weighted base • Powder coated
MSRP: \$550 EA. SELL PRICE: **\$360 EA.**



Zak Bar Height Base emuamericas

See Table Top & Base Fit Guide Pg.97

Cast aluminum weighted base • Powder coated
MSRP: \$520 EA. SELL PRICE: **\$340 EA.**



Zak Dining Height Base emuamericas

See Table Top & Base Fit Guide Pg.97

Cast aluminum weighted base • Powder coated
MSRP: \$450 EA. SELL PRICE: **\$290 EA.**



TABLES: TOPS & BASES

Nardi Table Top & Base Fit Guide

		24"	32"	36"	24"x32"	48"x32"	32" Dia	30" Dia
SINGLE DINING HEIGHT	ESPLANADE SELF LEVELING	★	★		★		★	★
	FIORE	★	★		★		★	★
	FLUTE TILTING	★					★	★
	FRASCA MAXI		★	★			★	★
	FRASCA MINI	★	★		★		★	★
	IBISCO TILTING	★	★		★		★	★
	TERRACE SELF LEVELING	★	★		★		★	★
	TRAIL 27 SELF LEVELING	★	★		★		★	★
	TRAIL 30 SELF LEVELING			★				
DOUBLE DINING HEIGHT	SCUDO TILTING					★		
	TRAIL SELF LEVELING					★		
SINGLE BAR HEIGHT	FIORE	★			★		★	★
	FRASCA TILTING	★			★		★	★
	IBISCO TILTING	★			★		★	★
	TRAIL 27 SELF LEVELING	★			★		★	★
	TRAIL 30 SELF LEVELING		★	★				
DOUBLE BAR HEIGHT	SCUDO TILTING					★		

BASES CUT DOWN TO COUNTER / LOUNGE HEIGHT FOR \$40 NET

BigBaba.com will provide the necessary hardware if both top and base are purchased on the same Purchase Order.

TABLES: TOPS & BASES



Teak is very durable and has its own natural oils which prevent water and moisture from penetrating the wood. It will develop a warm gray patina over time or it can be oiled annually to maintain the new wood look. Teak requires virtually no maintenance and can be left on the patio during the summer months.

Solid Natural Teak • 8 pre-drilled stainless steel inserts to connect to Nardi table bases • Tops are 1" thick



See Table Top & Base Fit Guide Pg.100

CODE + SIZE	WEIGHT	MSRP	SELL
#MT-TEAK24SQ 24"	13 lbs	\$480	\$310
#MT-TEAK32SQ 32"	23 lbs	\$680	\$440
#MT-TEAK36SQ 36"	30 lbs	\$860	\$560
#MT-TEAK24X32 24"x32"	17 lbs	\$570	\$370
#MT-TEAK48X32 48"x32"	36 lbs	\$940	\$610
#MT-TEAK 30RD 30"	15 lbs	\$540	\$350

Severin Exteriolit Classic



See Table Top & Base Fit Guide Pg.100

Poplar veneer marine grade plywood board with 1/16" HPL coating on both sides •

Moisture resistant

Self tapping screws included • Tops are 1.2" thick • UV protected

ADD NET \$30 FOR UMBRELLA HOLE

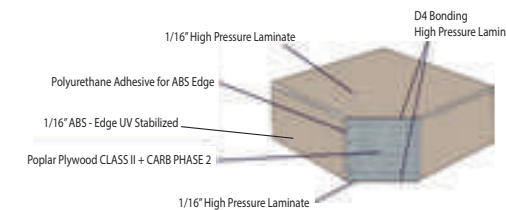

SIZE	WEIGHT	MSRP	SELL
#24SQ	14 lbs	\$350	\$230
#32SQ	25 lbs	\$600	\$390
#36SQ	32 lbs	\$610	\$400
#24x32	19 lbs	\$540	\$350
#48x32	38 lbs	\$860	\$560
#30RND	20 lbs	\$530	\$345

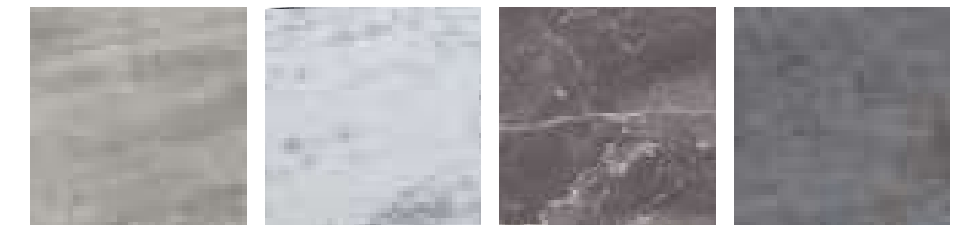

ATRIUM GREY MARBLE CARRARA MARBLE PIETRO SILVER FABRIC

Severin Compact HPL



See Table Top & Base Fit Guide Pg.100

High pressure laminate top • 8 pre-drilled stainless steel inserts to connect to Nardi table bases

Tops are laminate and slightly textured to reduce sliding • Tops are 1/2" thick • UV protected

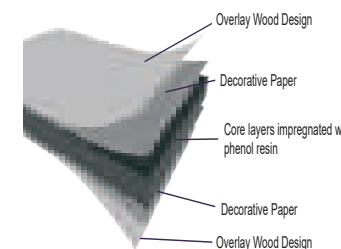

SIZE	WEIGHT	MSRP	SELL
#24SQ	12 lbs	\$350	\$230
#32SQ	22 lbs	\$460	\$260
#36SQ	22 lbs	\$490	\$320
#24x32	15 lbs	\$420	\$275
#48x32	31 lbs	\$660	\$430

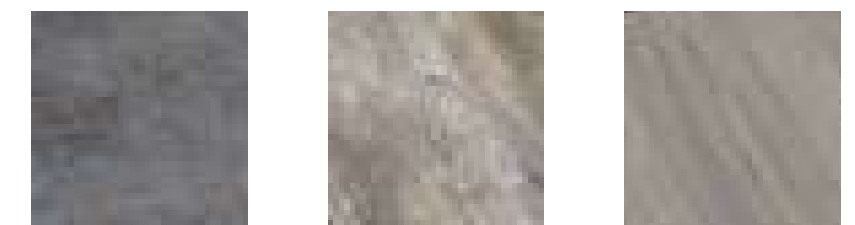

SILVER FABRIC VINTAGE FLEETWOOD VINTAGE PINE

TABLES: TOPS & BASES

Werzalit Classic **werzalit**  MADE IN FRANCE

Molded melamine mixed with redwood • 8 pre-drilled stainless steel inserts to connect to Nardi table bases
Tops are 1" thick • UV protected

SIZE	WEIGHT	MSRP	SELL
#24SQ	13 lbs	\$200	\$130
#32SQ	23 lbs	\$320	\$210
#36SQ	32 lbs	\$400	\$260
#24x32	17 lbs	\$310	\$200
#48x32	36 lbs	\$430	\$280
#32RND	20 lbs	\$270	\$175



ADD NET \$30 FOR UMBRELLA HOLE
See Table Top & Base Fit Guide Pg.100

TABLES: TOPS & BASES

Frasca Tilt Bar Height 

NARDI CATAS  YOUR OUTDOOR LIVING MADE IN ITALY

See Table Top & Base Fit Guide Pg.100
Cast Aluminum – Powder Coated + Specially Treated for High Salinity Environments • Tilt top
MSRP: \$390 EA. SELL PRICE: \$255 EA.

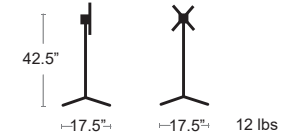
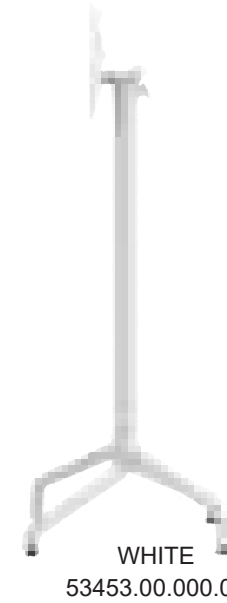

WHITE
53453.00.000.01

ANTRACITE
53452.00.000.01

Scudo Double Tilting Bar Height 

NARDI CATAS  YOUR OUTDOOR LIVING MADE IN ITALY

See Table Top & Base Fit Guide Pg.100
Cast Aluminum – Powder Coated + Specially Treated for High Salinity Environments • Tilt top
MSRP: \$580 EA. SELL PRICE: \$380 EA.

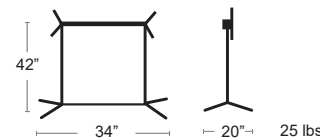
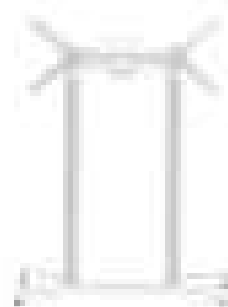

ANTRACITE
54452.00.000.01

SILVER
54454.00.000.01

WHITE
54453.00.000.01

Ibisco Tilt Bar Height 

NARDI CATAS  YOUR OUTDOOR LIVING MADE IN ITALY

See Table Top & Base Fit Guide Pg.100
Cast Aluminum – Powder Coated + Specially Treated for High Salinity Environments • Tilt top
MSRP: \$360 EA. SELL PRICE: \$235 EA.

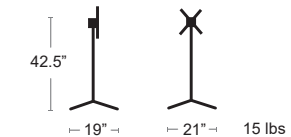
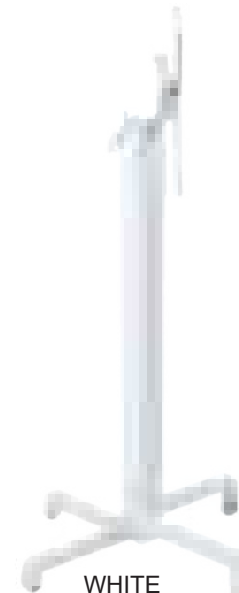

WHITE
54653.00.000.01

SILVER
54654.00.000.01

ANTRACITE
54652.00.000.01

Trail Bar Height 30 

NOROCK  MADE IN CHINA

See Table Top & Base Fit Guide Pg.100
The Trail self-stabilizing table base exemplifies modern simplicity. The linear, clean design and concealed components complement a robust construction for use in any setting. Zinc plated powder coated steel.

MSRP: \$470 EA. SELL PRICE: \$305 EA.



Say goodbye to wobbly tables!
NOROCK's award-winning bases use a simple mechanical system with four pivoting legs that are interconnected in such a way that they must reach an average weight loading on all four feet. When a table is placed on an uneven surface the feet will move until all four feet reach a state of equilibrium or more simply, a state of stability.

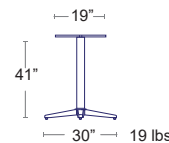

BLACK
TRST30BKB

Trail Bar Height 27 

NOROCK  MADE IN CHINA

See Table Top & Base Fit Guide Pg.100
The Trail self-stabilizing table base exemplifies modern simplicity. The linear, clean design and concealed components complement a robust construction for use in any setting. Zinc plated powder coated steel.

MSRP: \$340 EA. SELL PRICE: \$220 EA.

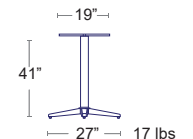

BLACK
TRST27BKB

TABLES: TOPS & BASES



Fiore Bar Height **NARDI CATAS**
YOUR OUTDOOR LIVING **MADE IN ITALY**

See Table Top & Base Fit Guide Pg.100
Cast Aluminum – Powder Coated + Specially Treated for High Salinity Environments
MSRP: \$300 EA. **SELL PRICE: \$200 EA.**



TABLES: TOPS & BASES



Scudo Tilt Double Dining Height **NARDI CATAS**
YOUR OUTDOOR LIVING **MADE IN ITALY**

See Table Top & Base Fit Guide Pg.100
Cast Aluminum – Powder Coated + Specially Treated for High Salinity Environments • Tilt top
MSRP: \$470 EA. **SELL PRICE: \$305 EA.**

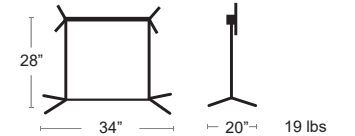

Trail T-Base Double Dining Self Leveling



See Table Top & Base Fit Guide Pg.100
The linear, clean design and concealed components complement a robust construction for use in any setting.
Zinc plated powder coated steel.
MSRP: \$500 EA. **SELL PRICE: \$325 EA.**



Say goodbye to wobbly tables!
NOROCK's award-winning bases use a simple mechanical system with four pivoting legs that are interconnected in such a way that they must reach an average weight loading on all four feet. When a table is placed on an uneven surface the feet will move until all feet reach a state of equilibrium or more simply, a state of stability.

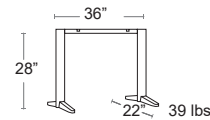

Terrace Dining Height Self Leveling Tilt & Nest



See Table Top & Base Fit Guide Pg.100
Functional and award-winning, the Terrace's hallmark is its iconic nesting feature: Simply fold, then nest. With a special alodine coating offering great corrosion resistance and a high-quality powder coat, Terrace is suitable for both indoor and outdoor applications.
MSRP: \$430 EA. **SELL PRICE: \$280 EA.**

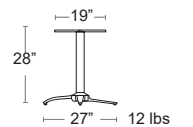

Frasca Maxi Dining Height



See Table Top & Base Fit Guide Pg.100
Cast Aluminum – Powder Coated + Specially Treated for High Salinity Environments
MSRP: \$490 EA. **SELL PRICE: \$320 EA.**

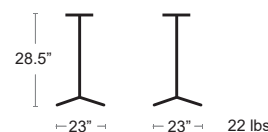
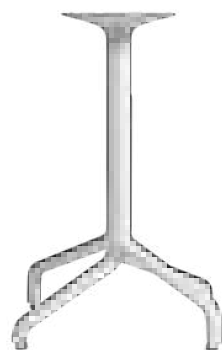

Esplanade Dining Height Self Leveling



See Table Top & Base Fit Guide Pg.100
With a special alodine coating offering great corrosion resistance and a high-quality powder coat, Esplanade is suitable for both indoor and outdoor applications.
MSRP: \$400 EA. **SELL PRICE: \$260 EA.**

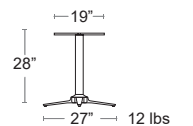

TABLES: TOPS & BASES

Frasca Tilt Dining Height



See Table Top & Base Fit Guide Pg.100

Cast Aluminum – Powder Coated + Specially Treated for High Salinity Environments • Tilt top

MSRP: \$350 EA. SELL PRICE: **\$230 EA.**



ANTRACITE
53252.00.000.01

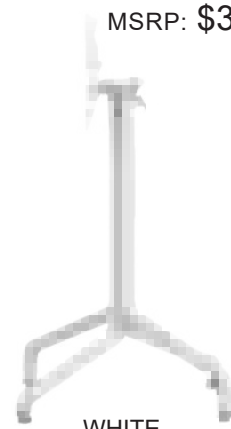

WHITE
53253.00.000.01

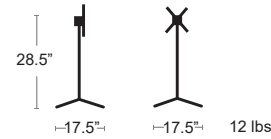

12 lbs

TABLES: TOPS & BASES

Ibisco Tilt Dining Height



See Table Top & Base Fit Guide Pg.100

Cast Aluminum – Powder Coated + Specially Treated for High Salinity Environments • Tilt top

MSRP: \$320 EA. SELL PRICE: **\$210 EA.**



SILVER
54554.00.000.01



ANTRACITE
54552.00.000.01



WHITE
54553.00.000.01

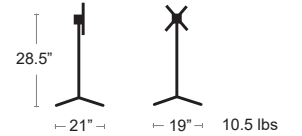

10.5 lbs

Trail Dining 30



See Table Top & Base Fit Guide Pg.100

The Trail self-stabilizing table base exemplifies modern simplicity. The linear, clean design and concealed components complement a robust construction for use in any setting. Zinc plated powder coated steel.

MSRP: \$340 EA. SELL PRICE: **\$220 EA.**



BLACK
TRST30BK



Say goodbye to wobbly tables!
NOROCK's award-winning bases use a simple mechanical system with four pivoting legs that are interconnected in such a way that they must reach an average weight loading on all four feet. When a table is placed on an uneven surface the feet will move until all four feet reach a state of equilibrium or more simply, a state of stability.

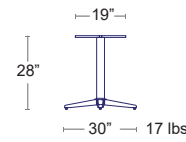

17 lbs

Trail Dining 27



See Table Top & Base Fit Guide Pg.100

The Trail self-stabilizing table base exemplifies modern simplicity. The linear, clean design and concealed components complement a robust construction for use in any setting. Zinc plated powder coated steel.

MSRP: \$280 EA. SELL PRICE: **\$185 EA.**



BLACK
TRST27BK

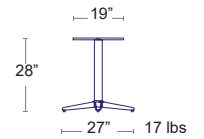

17 lbs

Flute Tilt Dining Height



See Table Top & Base Fit Guide Pg.100

Cast Aluminum – Powder Coated + Specially Treated for High Salinity Environments • Tilt top • Self leveling

MSRP: \$330 EA. SELL PRICE: **\$210 EA.**



WHITE
55653.00.000.01



SILVER
55654.00.000.01



ANTRACITE
55652.00.000.01

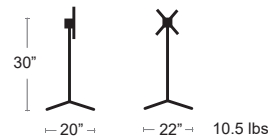

10.5 lbs

Fiore Dining Height



See Table Top & Base Fit Guide Pg.100

Cast Aluminum – Powder Coated + Specially Treated for High Salinity Environments

MSRP: \$260 EA. SELL PRICE: **\$170 EA.**



SILVER
53054.00.001



ANTRACITE
53052.00.001

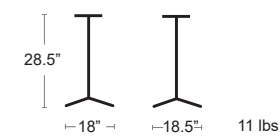

11 lbs





LOUNGE

Throw Pillows MADE IN NORTH AMERICA

Sunbrella 100% Solution dyed acrylic • Zippered removable cover • Washable

Compliments the Net and Deep Seating lounge collections • 0.5 lbs

MSRP: \$80 EA SELL PRICE: **\$40 EA.**

Custom Sunbrella cushions available for a 25% Surcharge
FOR CUSTOM SUNBRELLA COLORS - 3 WEEKS DELIVERY



SPECTRUM CHERRY
TOSS-48096



MILANO CHAR
TOSS-56079



PEYTON GRANITE
TOSS-56075



CABANA CLASSIC
TOSS-58030



CANVAS GRANITE
TOSS-5402



SPECTRUM DAFFODIL
TOSS-48024



VOLT SILVER
TOSS-58020



SPECTRUM CARBON
TOSS-48085



SPECTRUM EGGSHELL
TOSS-48018

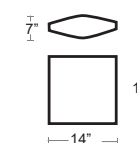

LOUNGE

Cannolè

The Cannolè seating system has a fully MIG welded structure made up of internally and externally galvanized steel tubes with a powder coat finish. The seat is a galvanized rod grid welded on a rod frame. The legs are made of tubular steel. All Cannolè cushions are made of polyurethane rubber with a layer of polyester fiber resin added, all packaged in a waterproof polyamide pillowcase.

Black Frame with Small Weft Grey 900/77 Cushions



1082-24+
1083-24+C900/71

Love Seat
MSRP: \$8200
SELL PRICE: **\$5300**

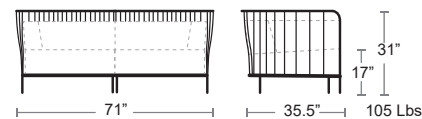

Arm Chair
MSRP: \$4400
SELL PRICE: **\$2900**



1080-24+C900/71

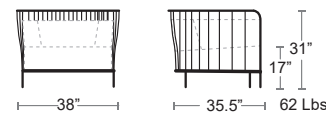

Pouf
MSRP: \$2000
SELL PRICE: **\$1300**



1085-24+C900/71

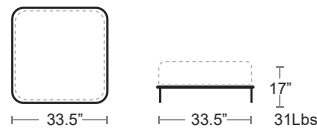

Round Table
MSRP: \$2000
SELL PRICE: **\$1300**



1087-24



Round Side Table
MSRP: \$1400
SELL PRICE: **\$900**



1088-24



LOUNGE

Gatsby Modular **VONDOM**

Inspired by Art Deco Lighting
Made of polyethylene resin by rotational molding. 100% Recyclable. Suitable for indoor and outdoor use.
Cushions Siesta 1812



Circular Armless Module
MSRP: \$6250
SELL PRICE: **\$4070**

ANTRACITE 54407

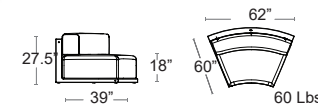

Arm Chair
MSRP: \$5680
SELL PRICE: **\$3700**

ANTRACITE 54403

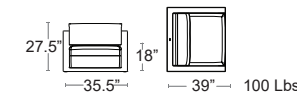

Right Module
MSRP: \$5080
SELL PRICE: **\$3300**



ANTRACITE 54405

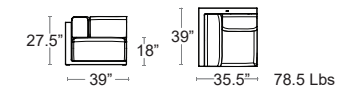

Left Module
MSRP: \$5080
SELL PRICE: **\$3300**



ANTRACITE 54406

Armless Module
MSRP: \$4740
SELL PRICE: **\$3100**

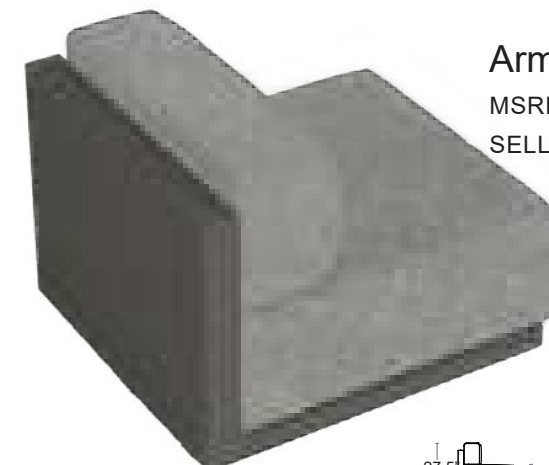

ANTRACITE 54404

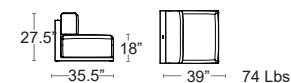

Pouf
MSRP: \$2730
SELL PRICE: **\$1780**

ANTRACITE 54408

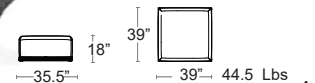

Urban Deep Seating Collection   

Powder coated aluminum frame • Welded • Sling material seat and back for added comfort
Includes Sunbrella cushions • Zippered for easy cleaning
CAST SLATE #40434-0000 • Sunbrella furniture grade fabric • Custom cushion colors available
Sunbrella Furniture Grade fabric • Allow 4-6 weeks for delivery

Urban Sofa

MSRP: \$3800 EA. SELL PRICE: **\$2500 EA.**
Select Custom Color Sunbrella Cushions or Replacement Cast Slate Cushion Set • Sold separately
MSRP: \$2280 EA. SELL PRICE: **\$1140 EA.**



URBAN-581

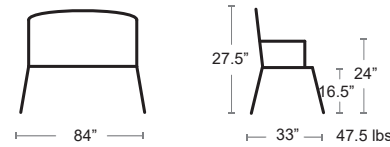

Urban Love Seat

MSRP: \$2600 EA. SELL PRICE: **\$1700 EA.**
Select Custom Color Sunbrella Cushions or Replacement Cast Slate Cushion Set • Sold separately
MSRP: \$1560 EA. SELL PRICE: **\$780 EA.**



URBAN-582

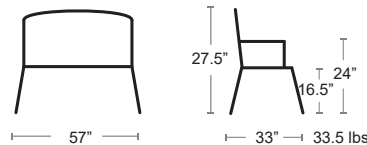

Urban Club Arm Chair

MSRP: \$1600 EA. SELL PRICE: **\$1040 EA.**

Select Custom Color Sunbrella Cushions or Replacement Volt Silver Cushion Set • Sold separately

MSRP: \$960 EA. SELL PRICE: **\$480 EA.**



URBAN-583

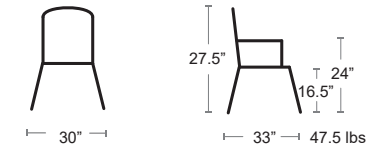

Urban Chaise Lounger

MSRP: \$2050 EA. SELL PRICE: **\$1330 EA.**

Select Custom Color Sunbrella Cushions or Replacement Volt Silver Cushion Set • Sold separately

MSRP: \$1230 EA. SELL PRICE: **\$615 EA.**



URBAN-415

Can be used with or without the cushion

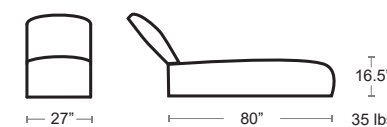

Urban Modular Collection



Powder coated aluminum frame • Welded • Sling material seat and back for added comfort
Includes Sunbrella cushions • Zippered for easy cleaning
Sunbelievable Venus Steel AR442 13K
Custom cushion colors available Furniture Grade fabric • Allow 4-6 weeks for delivery

Urban Long Sofa

MSRP: \$5300 EA. **SELL PRICE: \$3450 EA.**

Select Custom Color Sunbrella Cushions or Replacement Sunbelievable Venus Steel Set Sold Separately
MSRP: \$3180 EA. **SELL PRICE: \$1590 EA.**



URBAN LONG



Urban Left & Right Module

MSRP: \$2800 EA. **SELL PRICE: \$1800 EA.**

Select Custom Color Cushions or Replacement Sunbelievable Venus Steel Set Sold Separately
MSRP: \$1560 EA. **SELL PRICE: \$780 EA.**



URBAN-02R

URBAN-02L



Urban Corner Module

MSRP: \$1800 EA. **SELL PRICE: \$1170 EA.**

Select Custom Color Cushions or Replacement Sunbelievable Venus Steel Set Sold Separately

MSRP: \$1080 EA. **SELL PRICE: \$540 EA.**

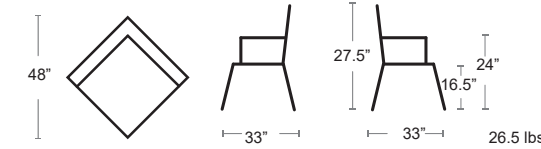

URBAN-00C



URBAN-00A

Urban Armless Module

MSRP: \$1600 EA. **SELL PRICE: \$1040 EA.**

Select Custom Color Cushions or Replacement Sunbelievable Venus Steel Set Sold Separately

MSRP: \$960 EA. **SELL PRICE: \$480 EA.**

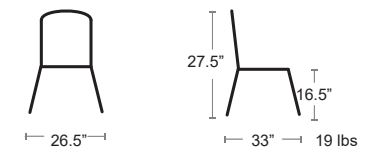

Urban Rectangular Coffee Table

Powder coated aluminum frame and top with slats

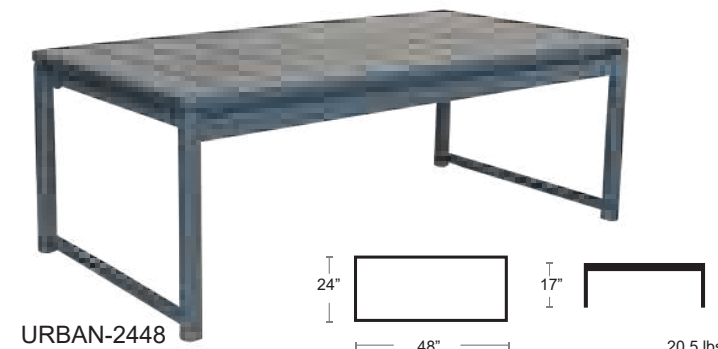

URBAN-2448

MSRP: \$1100 EA. **SELL PRICE: \$715 EA.**

Urban Square Side Table

Powder coated aluminum frame and top with slats



URBAN-22SQ

MSRP: \$700 EA. **SELL PRICE: \$455 EA.**

LOUNGE

Skyline Deep Seating



All weather resin wicker fish-bone weave • Powder coated aluminum frame
Includes Sunbrella cushions •

Zippered for easy cleaning • VOLT SILVER #58020-0000 • Sunbrella furniture grade fabric
Custom cushion colors available • Sunbrella Furniture Grade fabric • Allow 4-6 weeks for delivery

Skyline Sky Box

All weather resin wicker fish-bone weave • Powder coated aluminum frame • Castor wheels • Plastic liner inside box • Lockable handle

MSRP: \$3600 EA. SELL PRICE: **\$2340 EA.**



SKY-BOX

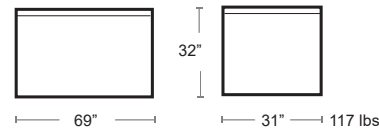

LOUNGE

Skyline Sofa

MSRP: \$3600 EA. SELL PRICE: **\$2340 EA.**

Select Custom Color Sunbrella Cushions or Replacement Volt Silver Cushion Set Sold Separately

MSRP: \$1800 EA. SELL PRICE: **\$900 EA.**



SKY-581

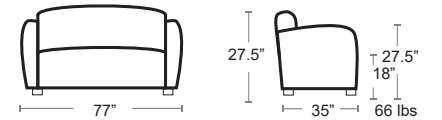

Skyline Long Sofa

MSRP: \$5400 EA. SELL PRICE: **\$3500 EA.**

Select Custom Color Sunbrella Cushions or Replacement Volt Silver Cushion Set Sold Separately

MSRP: \$2700 EA. SELL PRICE: **\$1350 EA.**



SKY-02R-02L-14-SOFA

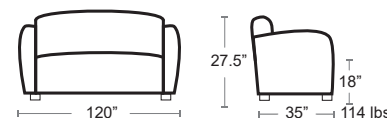

Skyline Love Seat

MSRP: \$2600 EA. SELL PRICE: **\$1690 EA.**

Select Custom Color Sunbrella Cushions or Replacement Volt Silver Cushion Set Sold Separately

MSRP: \$1300 EA. SELL PRICE: **\$650 EA.**



SKY-582

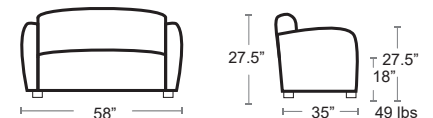

LOUNGE

Skyline Chair Club Arm Chair

MSRP: \$1760 EA. SELL PRICE: **\$1150 EA.**

Select Custom Color Sunbrella Cushions or Replacement Volt Silver Cushion Set Sold Separately

MSRP: \$880 EA. SELL PRICE: **\$440 EA.**



SKY-583

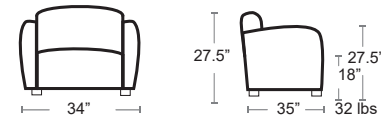

LOUNGE

Skyline Double Armless Module

MSRP: \$2550 EA. SELL PRICE: **\$1620 EA.**

Select Custom Color Sunbrella Cushions or Replacement Volt Silver Cushion Set Sold Separately

MSRP: \$1350 EA. SELL PRICE: **\$675 EA.**



SKY-02A

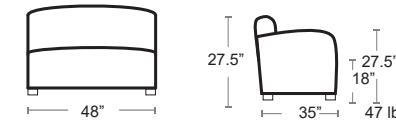

Skyline Right & Left Modules

MSRP: \$2650 EA. SELL PRICE: **\$1700 EA.**

Select Custom Color Sunbrella Cushions or Replacement Volt Silver Cushion Set Sold Separately

MSRP: \$1350 EA. SELL PRICE: **\$675 EA.**



LEFT
SKY-02L-14



RIGHT
SKY-02R-14

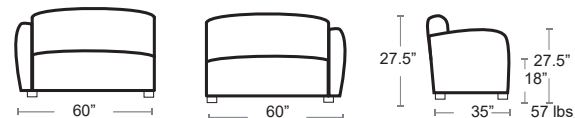

Skyline Corner Module

MSRP: \$1720 EA. SELL PRICE: **\$1110 EA.**

Select Custom Color Sunbrella Cushions or Replacement Volt Silver Cushion Set Sold Separately

MSRP: \$860 EA. SELL PRICE: **\$430 EA.**



SKY-00C

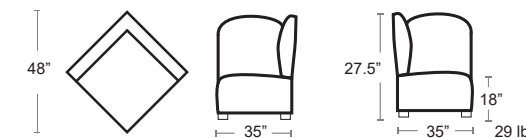

Skyline Slipper Module

MSRP: \$1440 EA. SELL PRICE: **\$940 EA.**

Select Custom Color Sunbrella Cushions or Replacement Volt Silver Cushion Set Sold Separately

MSRP: \$720 EA. SELL PRICE: **\$360 EA.**



SKY-00A

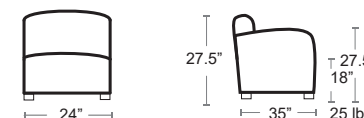

LOUNGE

Skyline Sun Lounger with Cushion

MSRP: \$2700 EA. SELL PRICE: **\$1750 EA.**

Select Custom Color Sunbrella Cushions or Replacement Volt Silver Cushion Set Sold Separately

MSRP: \$1350 EA. SELL PRICE: **\$675 EA.**



SKY-515

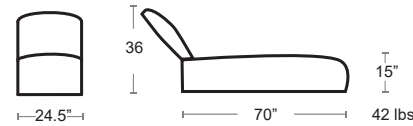

Skyline Rectangular Coffee Table w/ Glass Top

MSRP: \$860 EA. SELL PRICE: **\$560 EA.**



SKY-4222C

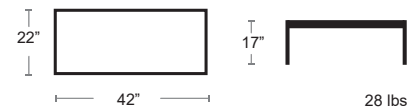

Replaceable Frosted Glass Top

MSRP: \$140 EA. SELL PRICE: **\$120 EA.**

Skyline Square Side Table w/ Glass Top

MSRP: \$730 EA. SELL PRICE: **\$480 EA.**



SKY-22SQ

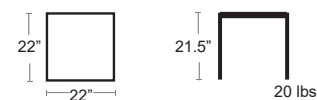

Replaceable Frosted Glass Top

MSRP: \$80 EA. SELL PRICE: **\$50 EA.**

LOUNGE

City View Deep Seating Collection



Welded powder coated aluminum frame

Includes Sunbrella VOLT SILVER #58020-0000 furniture grade fabric upholstered cushions
Zippered for easy cleaning • Sunbrella Custom cushion colors available • Allow 4-6 weeks for delivery

City View Long Sofa

MSRP: \$4800 EA. SELL PRICE: **\$3120 EA.**

Select Custom Color Sunbrella Cushions or Replacement Volt Silver Cushion Set Sold Separately

MSRP: \$2500 EA. SELL PRICE: **\$1250 EA.**



CITYVIEW-02R-02L

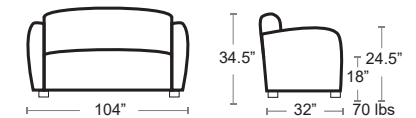

City View Sofa

MSRP: \$3600 EA. SELL PRICE: **\$2340 EA.**

Select Custom Color Sunbrella Cushions or Replacement Volt Silver Cushion Set Sold Separately

MSRP: \$1800 EA. SELL PRICE: **\$900 EA.**



CITYVIEW-581



LOUNGE

City View Love Seat

MSRP: \$2600 EA. SELL PRICE: **\$1690 EA.**

Select Custom Color Sunbrella Cushions or Replacement Volt Silver Cushion Set Sold Separately

MSRP: \$1300 EA. SELL PRICE: **\$650 EA.**



CITYVIEW-582

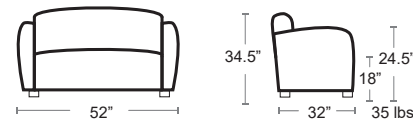

LOUNGE

City View Right & Left Module

MSRP: \$2400 EA. SELL PRICE: **\$1560 EA.**

Select Custom Color Sunbrella Cushions or Replacement Volt Silver Cushion Set Sold Separately

MSRP: \$1200 EA. SELL PRICE: **\$600 EA.**

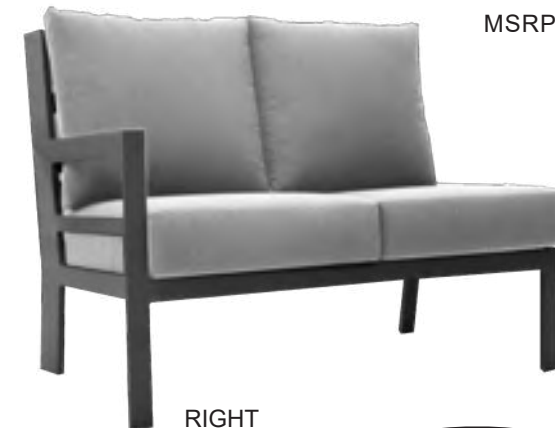

RIGHT
CITYVIEW-02R



LEFT
CITYVIEW-02L

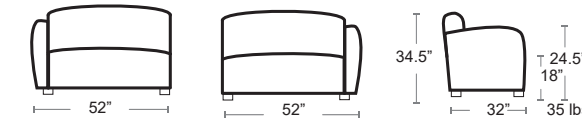

City View Corner Module

MSRP: \$2400 EA. SELL PRICE: **\$1560 EA.**

Select Custom Color Sunbrella Cushions or Replacement Volt Silver Cushion Set Sold Separately

MSRP: \$1200 EA. SELL PRICE: **\$600 EA.**



CITYVIEW-00C

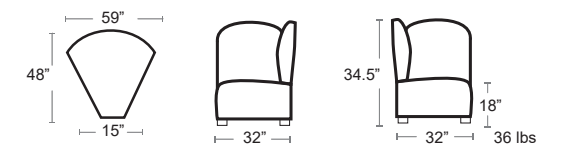

City View Club Arm Chair

MSRP: \$1600 EA. SELL PRICE: **\$1040 EA.**

Select Custom Color Sunbrella Cushions or Replacement Volt Silver Cushion Set Sold Separately

MSRP: \$800 EA. SELL PRICE: **\$400 EA.**



CITYVIEW-583



City View Slipper Module

MSRP: \$1300 EA. SELL PRICE: **\$845 EA.**

Select Custom Color Sunbrella Cushions or Replacement Volt Silver Cushion Set Sold Separately

MSRP: \$650 EA. SELL PRICE: **\$325 EA.**



CITYVIEW-00A

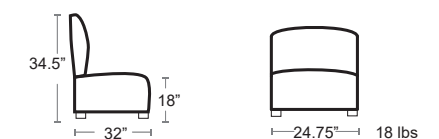

LOUNGE

City View Sun Lounger with Cushion

MSRP: \$2000 EA. SELL PRICE: **\$1300 EA.**

Select Custom Color Sunbrella Cushions or Replacement Volt Silver Cushion Set Sold Separately

MSRP: \$1000 EA. SELL PRICE: **\$500 EA.**



CITYVIEW-415

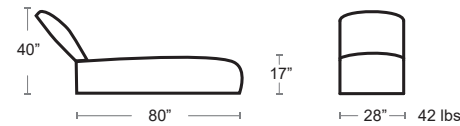

City View Tables

Welded powder coated aluminum frame • Parallel rectangular perforations for drainage

Console Table

MSRP: \$840 EA. SELL PRICE: **\$550 EA.**



CITYVIEW-2050T

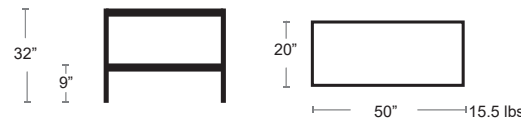

Rectangle Coffee Table

MSRP: \$700 EA. SELL PRICE: **\$455 EA.**



CITYVIEW-2442

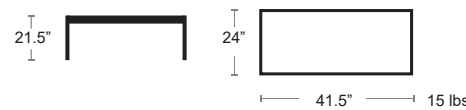

Square Side Table

MSRP: \$400 EA. SELL PRICE: **\$260 EA.**



CITYVIEW-21SQ



LOUNGE

Stone



As its name suggests it appears to be found in nature itself it can fit perfectly into any environment Made of polyethylene resin by rotational molding. 100% Recyclable. Suitable for indoor and outdoor use.



ANTRACITE
55005 - SOFA

Stone Sofa

MSRP: \$4400 EA. SELL PRICE: **\$2850 EA.**

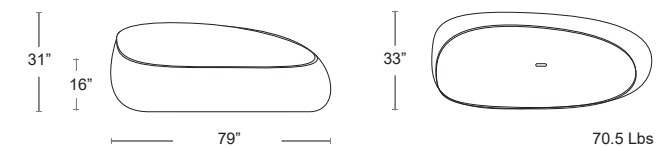

ANTRACITE
55006 - LOUNGE CHAIR

Stone Lounge Chair

MSRP: \$2300 EA. SELL PRICE: **\$1495 EA.**

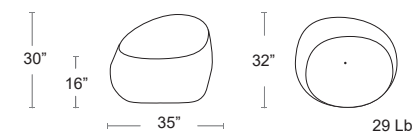

ANTRACITE
55007 - COFFEE TABLE

Stone Coffee Table

MSRP: \$1040 EA. SELL PRICE: **\$680 EA.**

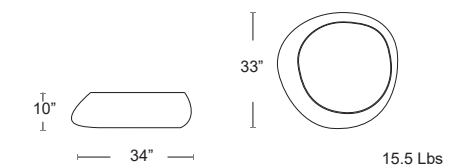

LOUNGE



Como Lounge



Tubular steel frame and seat • Stainless steel lattice back rest • E-coated powder coat finish
Cushion included 900/50 - Black Brown



1205-41

Side Chair Pg.35

Como Love Seat

MSRP: \$5400 EA.

SELL PRICE: \$3510 EA.

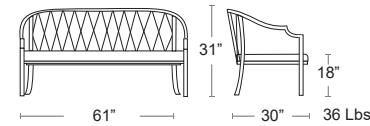

Como Lounge Chair

MSRP: \$2960 EA.

SELL PRICE: \$1920 EA.

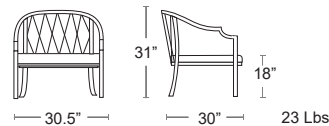

1204-41
900/50 - Black Brown

Como Side Table

Solid steel frame and Top • E-coated powder coat finish

MSRP: \$1200 EA. SELL PRICE: \$780 EA.



WHITE
1208-23



BLACK
1208-24



BRONZE
1208-41

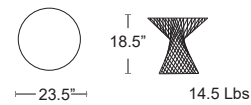

LOUNGE

Darwin Love Seat



Tubular steel frame • Steel mesh seat and back • E- Coated powder coat finish



NEW
BRONZE 527-41

MSRP: \$2550 EA.

SELL PRICE: \$1660 EA.



BLACK
527-24



WHITE
527-23

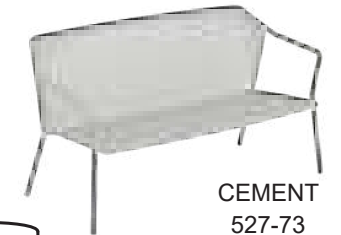

CEMENT
527-73

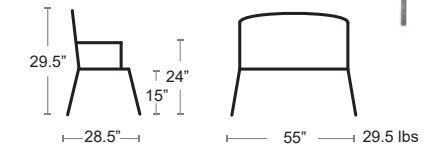

Armchair Pg.21,
Side Chair Pg.14,
Bar/Counter Stool Pg.58,
Tables Pg.84/85

Darwin Lounge



Tubular steel frame • Steel mesh seat and back • E- Coated powder coat finish



BLACK
524-24



NEW
BRONZE
524-41

MSRP: \$1030 EA.

SELL PRICE: \$670 EA.



WHITE
524-23



CEMENT
524-73

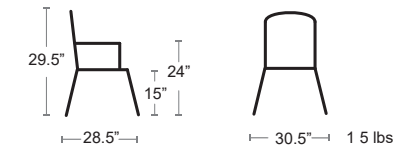

Carousel Lounge



Tubular aluminum frame • Full woven synthetic rope back • E-coated powder coat finish
Cushion included 900/77 Small Weft Weave Grey

MSRP: \$3570 EA. SELL PRICE: \$2320 EA.

Lounge Pg.15



CEMENT 1218-73-18

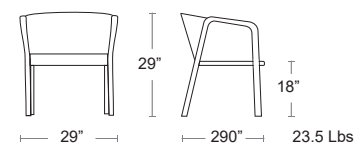

Darwin Side Table



Tubular steel frame • Solid steel Top • E- Coated powder coat finish

MSRP: \$970 EA.

SELL PRICE: \$630 EA.



WHITE
526-23



NEW
BRONZE
526-41



BLACK
526-24



CEMENT
526-73

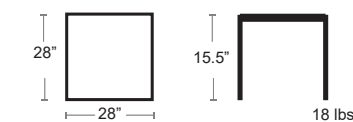

LOUNGE

Star Love Seat

Tubular steel frame • Steel slat seat and back • E-coated powder coat finish

MSRP: \$2300 EA. SELL PRICE: **\$1500 EA.**



DARK GREEN
166-75



BRONZE
166-41

Armchair Pg.20,
Side Chair Pg.40,
Bar/Counter Stool Pg.57,
Tables Pg.75

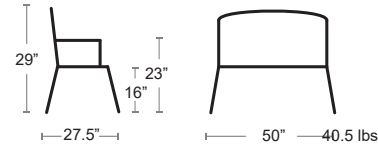

LOUNGE

Lyze Lounge Teak

Tubular aluminum frame • Teak seat • Stainless steel mesh back rest • E-coated powder coat finish

MSRP: \$2230 EA. SELL PRICE: **\$1450 EA.**

Armchair Pg.15,
Side Chair Pg.34,



617T-23-82

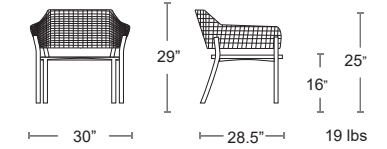

Star Lounge

Tubular steel frame • Steel slat seat and back • E-coated powder coat finish

MSRP: \$1130 EA. SELL PRICE: **\$735 EA.**



BRONZE
165-41



DARK GREEN
165-75

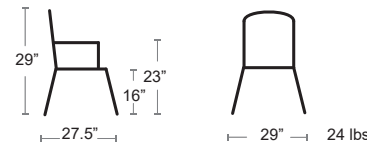

Holly Chaise

Tubular aluminum frame • Hidden wheels • Textilene fabric sea and back • E coated powder coat finish

MSRP: \$2230 EA. SELL PRICE: **\$1450 EA.**

Armchair Pg.16,



195-41-300/86



195-23-300/52

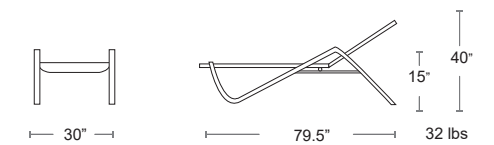

Star Snack Table

Steel construction • E-coated powder coat finish

MSRP: \$1130 EA. SELL PRICE: **\$735 EA.**



BRONZE
482-41



CEMENT 482-73



GREEN
482-75

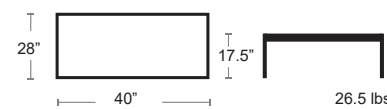

Star Side Table

Steel construction • E-coated powder coat finish

MSRP: \$620 EA. SELL PRICE: **\$400 EA.**



BRONZE 483-41



CEMENT 483-73



GREEN 483-75



WHITE 483-23

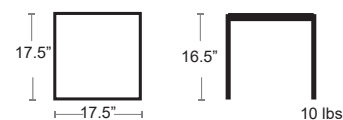

Holly High Table

Aluminum • E-coated powder coat finish

MSRP: \$840 EA. SELL PRICE: **\$545 EA.**



BRONZE 196H-41



WHITE 196H-23

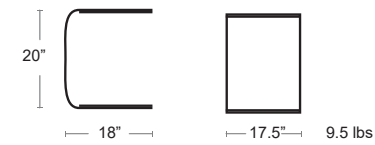

LOUNGE

Riviera Lounge

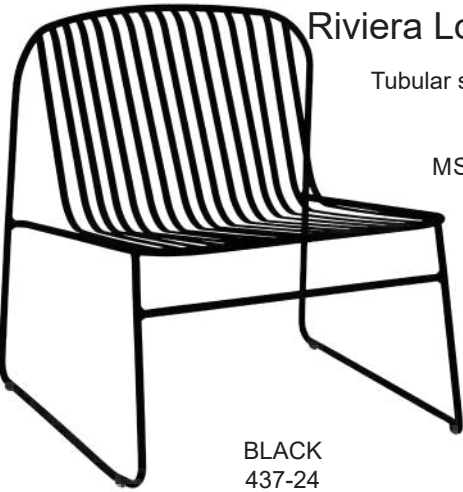

BLACK
437-24

emumadeinitaly
Tubular steel frame • Wrought Iron seat and back • E-coated powder coat finish

MSRP: \$1360 EA. SELL PRICE: \$885 EA.

Side chair Pg.36,
Bar Stool Pg.54

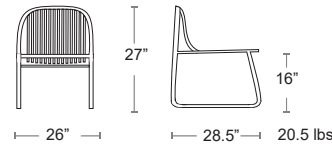

Snooze Chaise

emumadeinitaly
Tubular steel frame with wheels • Textilene fabric sea and back • E coated powder coat finish



207-23-300/42

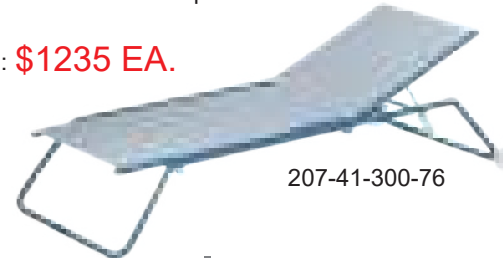

207-41-300-76

MSRP: \$1900 EA. SELL PRICE: \$1235 EA.

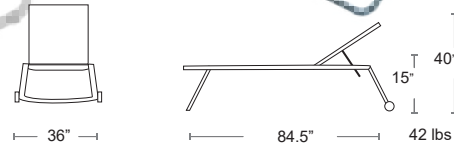

Snooze Folding Lounge Chair

emumadeinitaly
Tubular steel frame • Textilene fabric sea and back • E coated powder coat finish

MSRP: 920 EA. SELL PRICE: \$600 EA.



BRONZE
201-41-300/45



GREEN
201-60-300/43

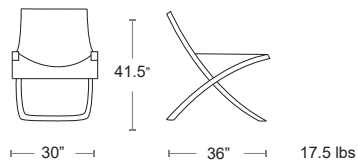

SKY BLUE
201-61-300/76

Snooze Folding Ottoman

emumadeinitaly
Tubular steel frame • Textilene fabric sea • E coated powder coat finish

MSRP: \$320 EA. SELL PRICE: \$210 EA.

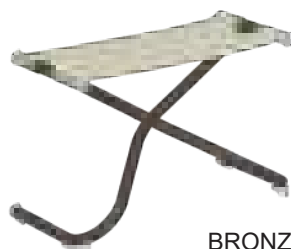

BRONZE
204-41-300/45

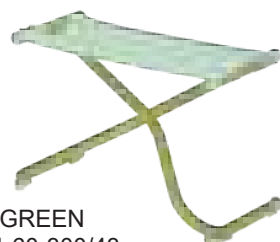

GREEN
204-60-300/43

LOUNGE

Sid Lounge

emuamericasmadeinchina
Square tubular aluminum frame • Wood look aluminum slat seat

MSRP: \$900 EA. SELL PRICE: \$585 EA.



NEW
WALNUT WITH
BLACK FRAME
1720-22-404



WENGE WITH BRUSHED
ALUMINUM FRAME
1720-06-402



OAK WITH BRUSHED
ALUMINUM FRAME
1720-06-401



GREY WITH
BLACK FRAME
1720-24-400

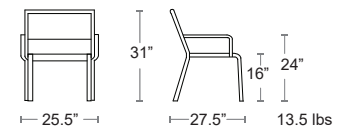

Sid Dining Stool/Side Table

emuamericasmadeinchina
Square tubular aluminum frame • Wood look aluminum slat seat • 6 lbs

MSRP: \$450 EA. SELL PRICE: \$290 EA.



NEW
WALNUT WITH BLACK
FRAME
1021-22-404



OAK WITH BRUSHED
ALUMINUM FRAME
1021-06-401



GREY WITH
BLACK FRAME
1021-24-400



WENGE WITH BRUSHED
ALUMINUM FRAME
1021-06-402

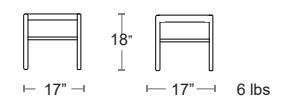

Find other Sid products
Armchair Pg.18,
Bench Pg.34,
Side Chair Pg.39,
Bar/Counter Stool Pg.59,
Backless Bar/Counter Pg.62,
Picnic Tables Pg.70,
Tables Pg.73, Table Tops Pg.97,

LOUNGE

Modern Adirondack Bench

Assembly required • Polyethylene • UV protected
 MSRP: \$1430 EA. **SELL PRICE: \$930 EA.**

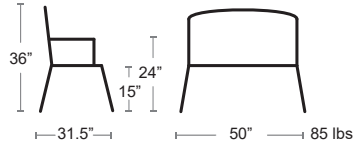
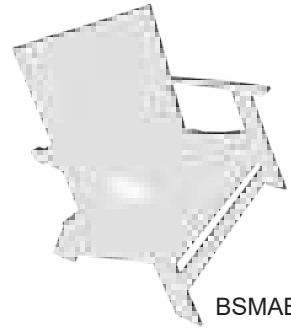

Modern Adirondack Chair

Assembly required • Polyethylene • UV protected
 MSRP: \$780 EA. **SELL PRICE: \$490 EA.**

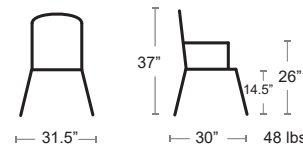

Modern Adirondack Coffee Table

Assembly required • Polyethylene • UV protected
 MSRP: \$860 EA. **SELL PRICE: \$560 EA.**

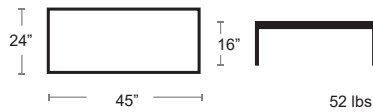
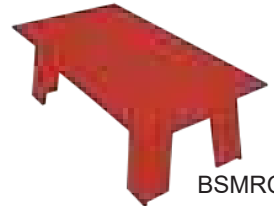

Modern Adirondack Side Table

Assembly required • Polyethylene • UV protected
 MSRP: \$640 EA. **SELL PRICE: \$420 EA.**

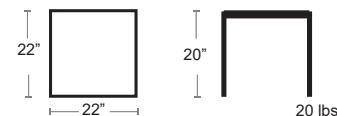
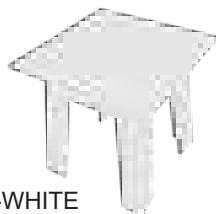

LOUNGE

Autograph Chaise



Enhanced ergonomics and lumbar support allow you to relax and stay engaged with your outdoor scene. Tested to endure 16000 hours of direct sunlight while also withstanding the damaging effects of pool chemicals, chlorine, sand or saltwater for 10+ years of fade resistance in contract locations.

MSRP: \$3200 EA. **SELL PRICE: \$2080 EA.**

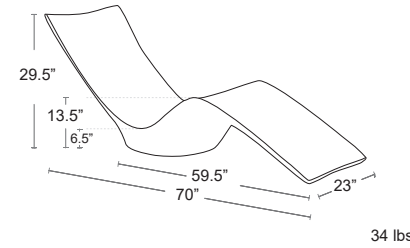

Headrest Pillow



Sunbrella Marine Grade Fabric with cell phone pocket.
 17.5" L X 8.5" W X 4" H
 Available in two colors

MSRP: \$560 EA. **SELL PRICE: \$365 EA.**



WHITE
 AG-C-P-STD-4634



Autograph Chair



One of a kind in style and comfort this one piece architectural and sculptural chair makes a statement indoors or out. Tested to endure 16000 hours of direct sunlight while also withstanding the damaging effects of pool chemicals, chlorine, sand or saltwater for 10+ years of fade resistance in contract locations.

MSRP: \$3240 EA. **SELL PRICE: \$2100 EA.**



AG-CR-GG



AG-CR-WH

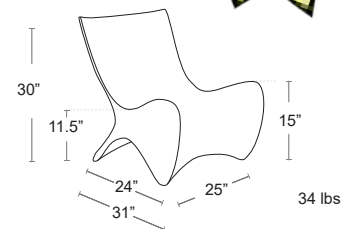

LOUNGE

Autograph Tall Ice Bin/Side Table

EVERYTHING WITHIN ARM'S REACH
Cold storage, up to 12 cans. Designed for up to 12" of water or on-deck.
never have to leave your outdoor oasis • Store your small poolside necessities

MSRP: \$1760 EA. SELL PRICE: **\$1150 EA.**



AG-ST-T-HL-GG



AG-ST-T-HL-WH

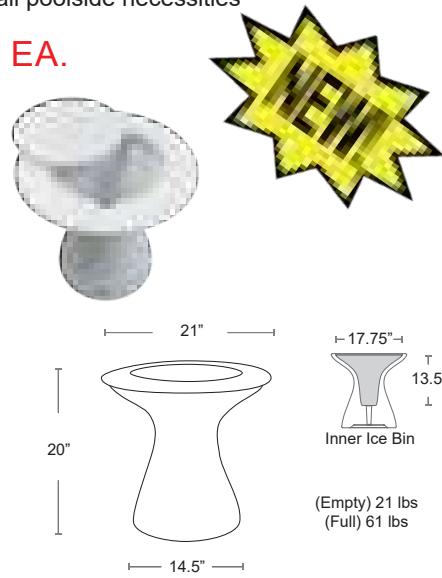

LOUNGE

Square Trash Bin

Stylish outdoor waste receptacle made from extruded UV20 rated high density polyethylene resin, colour stabilized for up to 20,000 hours of direct sunlight.

40 gallon capacity black liner included

MSRP: \$2940 EA. SELL PRICE: **\$1900 EA.**



MS-TB-SQ



Bar/Credenza

STYLISH AND FUNCTIONAL

- Mini-fridge included
 - Multiple electrical and USB outlet options to accommodate outdoor appliances, phone and more
 - Cord access holes for easy cord management
 - Built-in TV mount
 - Ample storage to tuck valuables away
 - Wireless phone charger for a quick and easy boost
 - Routed grips for easy cabinet access • Built-in slots to reduce trapped moisture
- RECOMMENDED TV SIZE: UP TO 55" (50" OPTIMAL)

MSRP: \$11800 EA. SELL PRICE: **\$7600 EA.**



MS-BC-FO

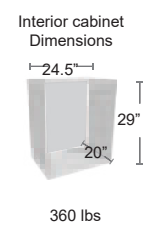
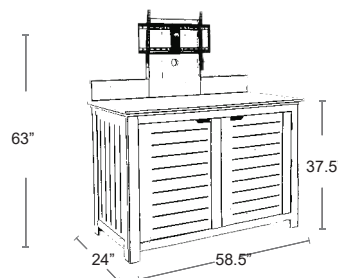

Atlantico

Resin and fiberglass solid frame • UV Protected • 4 position reclining • 2 wheels • Breathable synthetic fabric

MSRP: \$680 EA. SELL PRICE: **\$550 EA.**



ANTRACITE/ANTRACITE
40450.02.057



BIANCO/BIANCO
40450.00.107

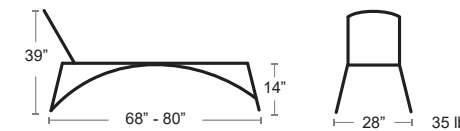

Atlantico Replacement Fabric

Breathable synthetic fabric • UV Protected

MSRP: \$220 EA.

SELL PRICE: **\$150 EA.**

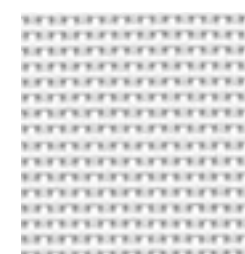

BIANCO
40460.00.107

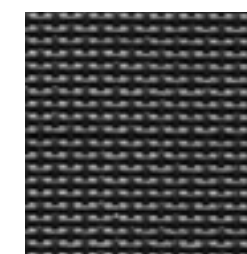

ANTRACITE
40460.01.057

Atlantico Arms

2 arms included • UV Protected • 2.5 lbs
CHAIR SOLD SEPARATELY

MSRP: \$60 EA.

SELL PRICE: **\$50 EA.**



ANTRACITE
40452.02.000



BIANCO
40452.00.000

LOUNGE

Alfa 

NARDI CATAS
YOUR OUTDOOR LIVING 

Resin and fiberglass solid frame • UV Protected
4 position reclining • 2 wheels • Breathable synthetic fabric

MSRP: \$620 EA. SELL PRICE: **\$480 EA.**



CAFFE/CAFFE
40416.05.117



TORTORA/TORTORA
40416.10.124



BIANCO/BLU
40416.00.112



ANTRACITE /ANTRACITE
40416.02.116

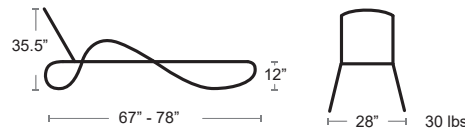

Omega 

NARDI CATAS
YOUR OUTDOOR LIVING 

Resin and fiberglass solid frame • UV Protected
4 position reclining • 2 wheels • Breathable synthetic fabric

MSRP: \$620 EA. SELL PRICE: **\$480 EA.**



ANTRACITE/ANTRACITE
40417.02.116



CAFFE/CAFFE
40417.05.117

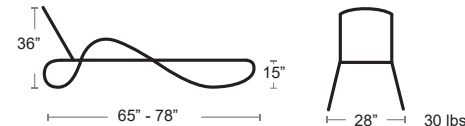

Parasol - Alfa & Omega

Resin and fiberglass solid frame

Breathable synthetic fabric • UV protected • 3 lbs

MSRP: \$110 EA. SELL PRICE: **\$75 EA.**

Replacement Fabric - Alfa & Omega

Breathable synthetic fabric • UV protected

MSRP: \$220 EA. SELL PRICE: **\$140 EA.**



BIANCO/BLU
40418.00.112



TORTORA
40418.10.124

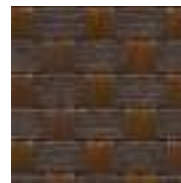

CAFFE/CAFFE
40418.05.117



ANTRACITE
40418.02.116



TORTORA
40424.01.124



CAFFE
40424.00.117



BLU
40424.00.112



ANTRACITE
40424.00.116

LOUNGE

Wave Sun Lounger 

PAPATYA CATAS 

Fiberglass polypropylene and aluminum frame with water-resistant seat material.
Open, light shape and breezy outlines are merged with comfort, the ability to stack, and stability.
The wide backrests are ergonomically designed, hugging the body comfortably.
MSRP: \$600 EA. SELL PRICE: **\$420 EA.**



WAVE-22-05700

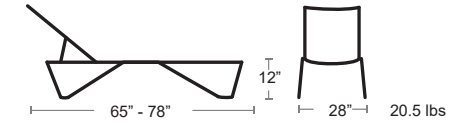

Folio 



NARDI CATAS
YOUR OUTDOOR LIVING 

Tubular resin and fiberglass frame, seat and back • UV Protected • 2 position recline

MSRP: \$550 EA. SELL PRICE: **\$460 EA.**



ANTRACITE FRAME
40300.02.000

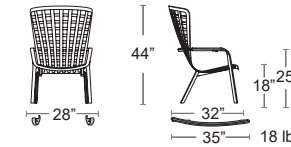

WITH ROCKER KIT

Poggio Stool/Footrest

Tubular fiberglass frame • Polypropylene resin with UV Protection

MSRP: \$150 EA. SELL PRICE: **\$125 EA.**



ANTRACITE 40044.02.000

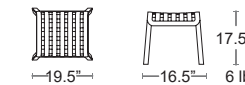

Rocker Kit

Turn your chair into a rocking chair

MSRP: \$100 EA. SELL PRICE: **\$85 EA.**



ANTRACITE 40298.02.000

Cushion

Acrylic yarn dyed fabric with polyurethane foam and Velcro straps

MSRP: \$310 EA. SELL PRICE: **\$210 EA.**



ROSA QUARZO
36300.01.066



FELCE
36300.01.162



ARTIC
36300.01.161

Cushion

Acrylic solution dyed fabric with polyurethane foam and Velcro straps

MSRP: \$400 EA. SELL PRICE: **\$260 EA.**



LINO
36300.01.152

LOUNGE

Net Lounge  

NARDI CATAS
YOUR OUTDOOR LIVING 

Uniformly colored fiberglass polypropylene resins with UV additives •

Matte finish • With non-slip feet and clips for securing a beach towel • Recyclable resin



MSRP: \$560 EA. **SELL PRICE: \$450 EA.**

Arm Chair Pg. 25
Bit Side Chair Pg. 46
Bar Stool Pg.64



BIANCO
40329.00.000

CORALLO
40329.75.000

ANTRACITE
40329.02.000

SENAPE
40329.56.000

SALICE
40329.04.000

TORTORA
40329.10.000

LOUNGE

Net Bench  

NARDI CATAS
YOUR OUTDOOR LIVING 

Uniformly colored fiberglass polypropylene resins with UV additives
Without cushion bench is lounge height
With cushion Bench is dining height

MSRP: \$510 EA. **SELL PRICE: \$410 EA.**



CORALLO
40338.75.000

Arm Chair Pg. 25
Bit Side Chair Pg. 46
Bar Stool Pg.64

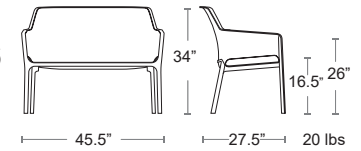

SALICE
40338.04.000

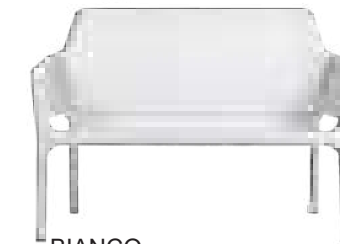

BIANCO
40338.00.000

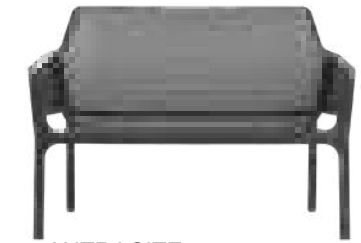

ANTRACITE
40338.02.000



TORTORA
40338.10.000

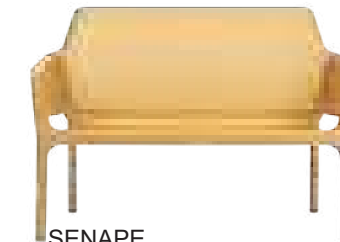

SENAPE
40338.56.000



MILANO CHAR
NET BENCH 56079



PEYTON GRANITE
NET BENCH 56075



SPECTRUM CARBON
NET BENCH 48085

Net Bench Cushion MADE IN NORTH AMERICA

Made in North America

- Sunbrella 100% Solution dyed acrylic • 3.3 lbs
- Zippered removable cover • Washable

Custom Sunbrella cushions available for a 25% Surcharge

MSRP: \$290 EA. **SELL PRICE: \$230 EA.**



CANVAS GRANITE
NET BENCH 5402



SPECTRUM DAFFODIL
NET BENCH 48024



VOLT SILVER
NET BENCH-58020



SPECTRUM EGGHELL
NET BENCH 48018

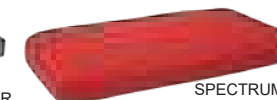

SPECTRUM CHERRY
NET BENCH 48096

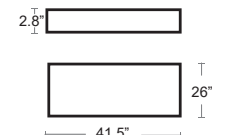

LOUNGE

Net Relax



Uniformly colored fiberglass polypropylene resins with UV additives.
Without cushion chair is lounge height
With cushion chair is dining height

MSRP: \$360 EA. SELL PRICE: **\$290 EA.**

Arm Chair Pg. 25
Bit Side Chair Pg. 46
Bar Stool Pg.64



SALICE
40327.04.000



CORALLO
40327.75.000



BIANCO
40327.00.000

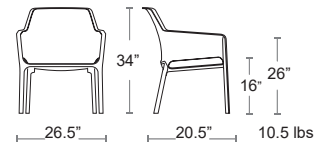

ANTRACITE
40327.02.000



TORTORA
40327.10.000



SENAPE
40327.56.000



PEYTON GRANITE
NET RELAX 56075

Net Relax Cushion MADE IN NORTH AMERICA

Made in North America • Sunbrella 100% Solution dyed acrylic • 1.8 lbs

Zippered removable cover • Washable

Custom Sunbrella cushions available for a 25% Surcharge

MSRP: \$140 EA. SELL PRICE: **\$115 EA.**



SPECTRUM CARBON
NET RELAX 48085



CANVAS GRANITE
NET RELAX 5402



VOLT SILVER
NET RELAX-58020



SPECTRUM CHERRY
NET RELAX 48096



SPECTRUM EGG SHELL
NET RELAX 48018



SPECTRUM DAFFODIL
NET RELAX 48024



MILANO CHAR
NET RELAX 56079

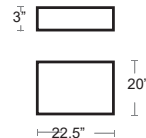

LOUNGE

Net 100



Uniformly colored fiberglass polypropylene resins with UV additives
Perforated top

MSRP: \$250 EA. SELL PRICE: **\$200 EA.**

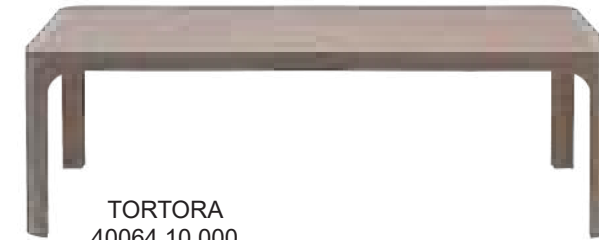

TORTORA
40064.10.000

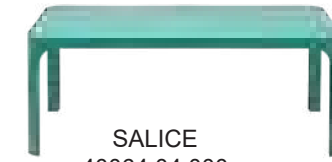

SALICE
40064.04.000

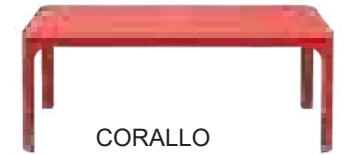

CORALLO
40064.75.000

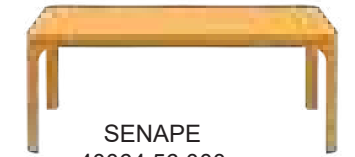

SENAPE
40064.56.000



ANTRACITE
40064.02.000



BIANCO
40064.00.000

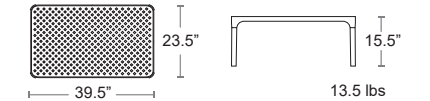

Doga Relax



Uniformly colored fiberglass polypropylene resins with UV additives

• Matte finish

MSRP: \$360 EA. SELL PRICE: **\$290 EA.**

Arm Chair Pg. 26
Side Chair Pg. 47



BIANCO
40256.00.000



PERA
40256.18.000



ANTRACITE
40256.02.000



MARSALA
40256.21.000



AGAVE
40256.16.000

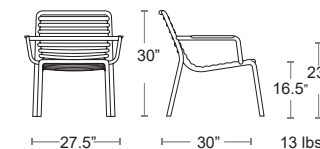

PEYTON GRANITE
DOGA RELAX 56075



SPECTRUM CARBON
DOGA RELAX 48085

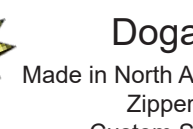

CANVAS GRANITE
DOGA RELAX 5402

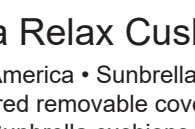

VOLT SILVER
DOGA RELAX 58020

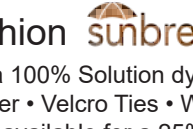

SPECTRUM CHERRY
DOGA RELAX 48096



SPECTRUM DAFFODIL
DOGA RELAX 48024



SPECTRUM EGG SHELL
DOGA RELAX 48018



MILANO CHAR
DOGA RELAX 56079

LOUNGE

Doga Side Table



Uniformly colored fiberglass polypropylene resins with UV additives

• Matte finish
MSRP: \$160 EA. SELL PRICE: **\$130 EA.**



ANTRACITE
40042.02.000

Arm Chair Pg. 26
Side Chair Pg. 47



BIANCO
40042.00.000



AGAVE
40042.16.000



MARSALA
40042.21.000



PERA
40042.18.000

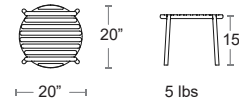

LOUNGE

Adan Table



Resin sculptural table • UV protected • Can handle -40C to +40C

MSRP: \$1570 EA. SELL PRICE: **\$995 EA.**

Adan Large Planter Pg. 177
Adan Small Planter Pg. 179

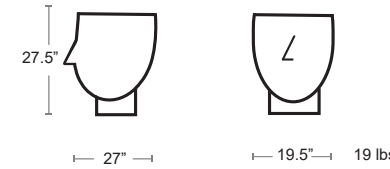

WHITE
49062



BLACK
49062

Delta



Tubular resin and fiberglass frame • Perforated seat and back • UV Protected
5 positions • Folding

MSRP: \$340 EA. SELL PRICE: **\$220 EA.**



ANTRACITE
40310.02.116



FOLDED

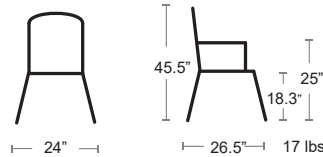

Terramare Smart Table



Aluminum top and base, die cast aluminum connections, height adjustable

Suitable for outdoor or indoor

MSRP: \$960 EA. SELL PRICE: **\$625 EA.**



WHITE
726-23



BLACK
726-24

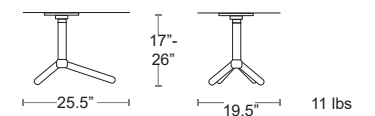

Aquamarina



Tubular resin and fiberglass frame • Perforated seat, back and headrest • UV Protected
4 positions • Folding head rest and chair

MSRP: \$340 EA. SELL PRICE: **\$220 EA.**



ANTRACITE
40314.02.000

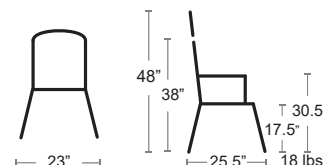

Ruffle Side Table



The "Ruffle" collection expresses the elegance and lightness of fabric in an iconic contemporary silhouette.

MSRP: \$680 EA. SELL PRICE: **\$440 EA.**

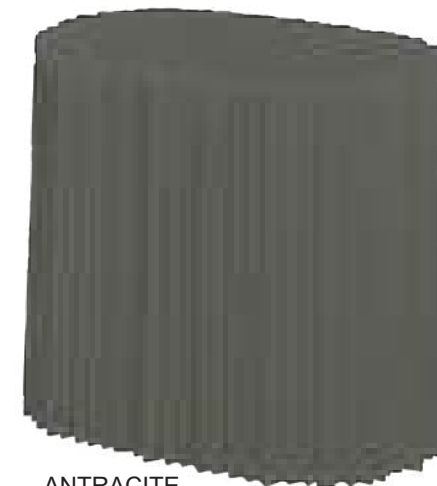

ANTRACITE
RUFFLE-TV

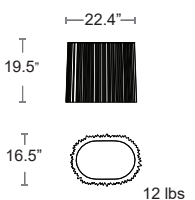

LOUNGE

Juju **SERRALUNGA CATAS** 
 Stool/Side Table • UV Protected • LLDPE (linear low density polyetjelene 100% Recyclable Solution Dyed • Impact resistant • Stable, light and easy to handle

MSRP: \$500 EA. SELL PRICE: **\$325 EA.**





ANTRACITE
JUJU-ANT

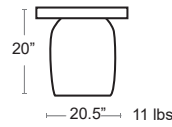

WHITE
JUJU-WH



LOUNGE

Disco Side Table   **SERRALUNGA CATAS** 
 Steel tubular frame and mesh top • E-coated powder coat finish

MSRP: \$340 EA. SELL PRICE: **\$220 EA.**



BLUE
100-61



CEMENT
100-73



BRONZE
100-41



IRON
100-22

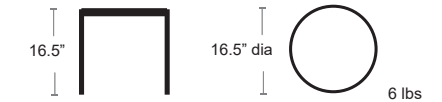

Dado **SERRALUNGA CATAS** 
 Stool/Side Table • UV Protected • LLDPE (linear low density polyetjelene 100% Recyclable Solution Dyed • Impact resistant • Magazine slot has drainage hole for constant outdoor use

MSRP: \$480 EA. SELL PRICE: **\$310 EA.**



WHITE
DADO-WH

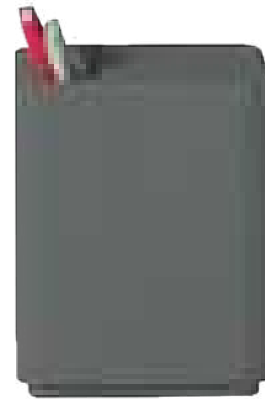

ANTRACITE
DADO-ANT

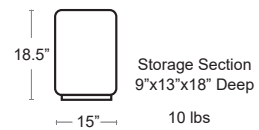

Pop   **NARDI CATAS** 
 Resin and fiberglass • UV protected • Shelf included

MSRP: \$140 EA. SELL PRICE: **\$95 EA.**



ANTRACITE
40048.02.000



BIANCO
40048.00.000



CAFFE
40048.05.000



TORTORA
40048.10.000

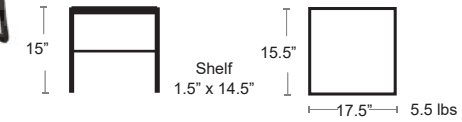

Atlantico Lounger
Pg. 137

Cero **SERRALUNGA CATAS** 
 Sculptural informal seat/foot rest and decorative element • UV Protected • LLDPE (linear low density polyetjelene 100% Recyclable • Solution Dyed • Impact resistant

MSRP: \$420 EA. SELL PRICE: **\$275 EA.**



ANTRACITE
CERO-ANT



WHITE
CERO-WH

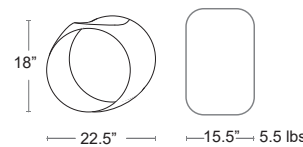

Rodi   **NARDI CATAS** 
 Resin Table • UV protected

MSRP: \$80 EA. SELL PRICE: **\$60 EA.**



GRIGIO
40050.03.000



TORTORA
40050.10.000



ANTRACITE
40050.02.000



BIANCO
40050.00.000



CAFFE
40050.05.000

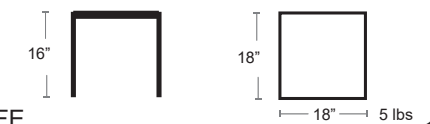

Alfa/Omega Lounger
Pg. 138





COMPLEMENTS

SERRALUNGA **CATAS** 

Lady Jane Floor Lamp

Lacquered surface specially engraved to create an astonishing effect of light and shade that is one of a kind. The Lady Jane floor lamps are over 2 metres high and are awe-inspiring, theatrical objects.

MSRP: \$7100 EA. SELL PRICE: **\$4600 EA.**



Miss Jane Floor Lamp

Lacquered surface specially engraved to create an astonishing effect of light and shade that is one of a kind. Modern lamps for indoor and outdoor use.

MSRP: \$4700 EA. SELL PRICE: **\$3055 EA.**



Ruffle Floor Lamp

The "Ruffle" Lamp expresses the elegance and lightness of fabric in an iconic contemporary silhouette. Combining texture with light the Ruffle floor lamp adds a sensual illumination to both indoor and outdoor surroundings. LLDPE (linear low-density polyethylene) achieved by rotational molding. UV protection. 100% recyclable, solution dyed. High degree of mechanical strength and resistance to impacts.

MSRP: \$3600 EA. SELL PRICE: **\$2340 EA.**



Wireless RGB LED System - 1.2W
 RGB led - 3.7V,
 2200 mAh lithium-ion battery - class III.
 Charging station for indoor use: input
 110/240V - 50/60
 Remote Control Included

COMPLEMENTS

SERRALUNGA **CATAS**  MADE IN ITALY

Bonheur Floor Lamp

White matte polymer spreads the light softly, creating a contrast with the deep grey of the base.
Designed for outdoor use, this floor lamp is made of impact-proof polyethylene and has a wide base for increased stability.
MSRP: \$2340 EA. SELL PRICE: **\$1520 EA.**



Odette Floor Lamp

Lampshade (linear polyethylene) achieved by rotational molding. UV protection. 100% recyclable, solution dyed. High degree of mechanical strength and resistance to impacts. Steel frame lacquered for outdoor usage.
MSRP: \$2240 EA. SELL PRICE: **\$1460 EA.**

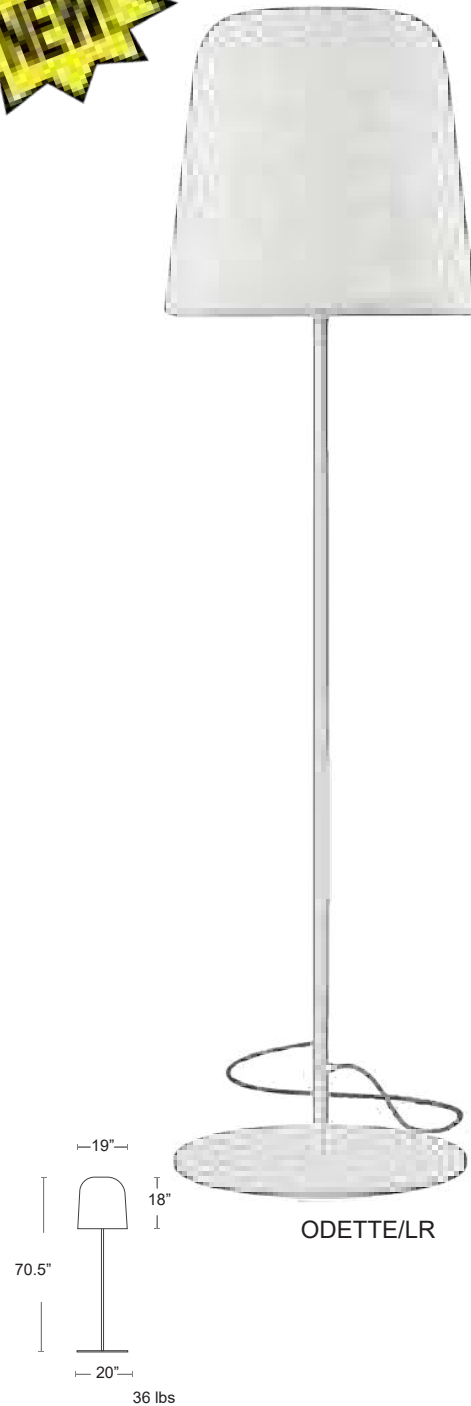

COMPLEMENTS

Fiesta Portable Bar / Host Station / Servery

VONDOM  MADE IN SPAIN

Resin bar, host or server station • Stainless steel upper tier counter top • 2 HPL shelves included • 8 wheels with locks
UV protected • Attach multiple bars, some items are special order, together to create a custom size and shape
MSRP: \$5000 EA. SELL PRICE: **\$3250 EA.**

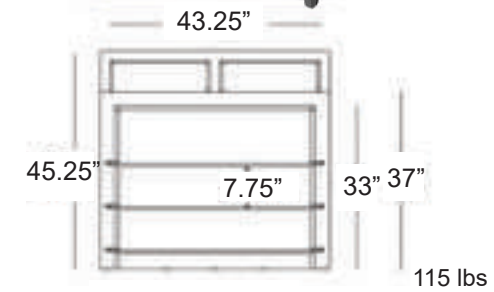

BLACK
56023

Forest LED Light

VONDOM  MADE IN SPAIN

The Forest Collection, a back-lit piece shaped like a geometric abstraction of an evergreen. Made of polyethylene resin by rotational molding.
100% Recyclable. Item suitable for indoor and outdoor use.
Unit with internal lighting with RGBW LED technology and remote control unit for switching colors. Remote Control included



MSRP: \$4000 EA.
SELL PRICE: **\$2600 EA.**
Forest Large
54248L

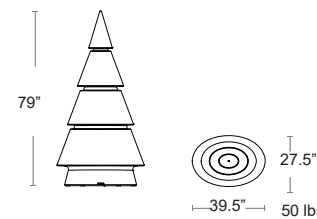

MSRP: \$2400 EA.
SELL PRICE: **\$1560 EA.**
Forest Medium
54249L

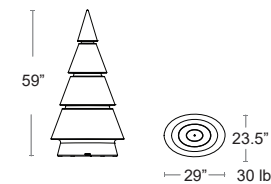

MSRP: \$1550 EA.
SELL PRICE: **\$1000 EA.**
Forest Small
54250L

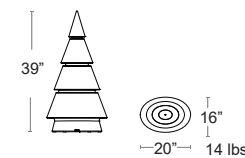

COMPLEMENTS

Doria Recycle Litter Bin



Steel • E-coated powder coat finish • 3 different 20 gallon compartments
Can be bolted down Hardware not included

MSRP: \$5700 EA. SELL PRICE: **\$3700 EA.**

BLACK OXIRON/STAINLESS STEEL
U686

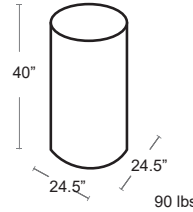

COMPLEMENTS

Dado Litter Bin With Rubbermaid Liner



Steel • E Coated powder coat finish
Can be bolted down • Hardware not included

MSRP: \$3720 EA. SELL PRICE: **\$2420 EA.**

886+OR3567-G

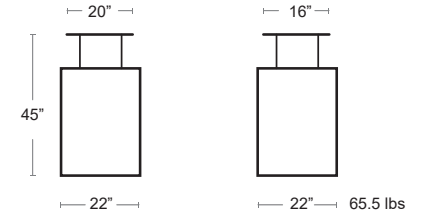

Dara Litter Bin With Ashtray / Snuffer Large



Steel • 51 gal capacity • Can be bolted down • Hardware not included

MSRP: \$5200 EA. SELL PRICE: **\$3380 EA.**

STEEL GREY
U694L

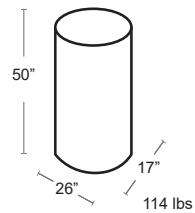

Deployee Litter Bin



Steel top and bottom • Mesh steel sides • E-coated powder coat finish
37 gallon capacity

Can be bolted down • Hardware not included
MSRP: \$3230 EA. SELL PRICE: **\$2100 EA.**

JET BLACK / ALUMINUM
U638

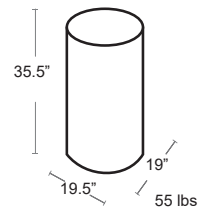

Ecosens Litter Bin



Steel frame with Ferrus treatment,
Silver polyester powder coated finish • 100% Recycled poly planks front
and back.

2 x 20 gallon compartments

MSRP: \$4200 EA. SELL PRICE: **\$2730 EA.**



Bench Pg.157

RECYCLED POLY &
SILVER RAL 9006
U662

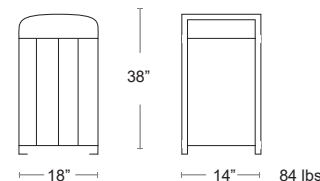

Dara Litter Bin With Ashtray / Snuffer Medium



Steel • 25 gal capacity • Can be bolted down • Hardware not included

MSRP: \$2600 EA. SELL PRICE: **\$1690 EA.**

STEEL GREY
U694S

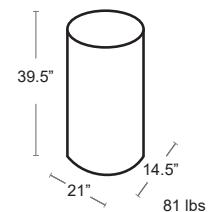

COMPLEMENTS



Hand Sanitizer Dispenser

Steel construction • Hands free foot pump
Can be bolted down • Hardware not included

MSRP: \$1600 EA.

SELL PRICE: **\$1040 EA.**

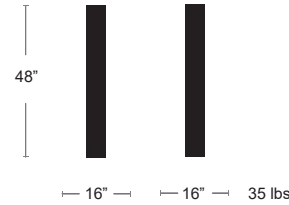
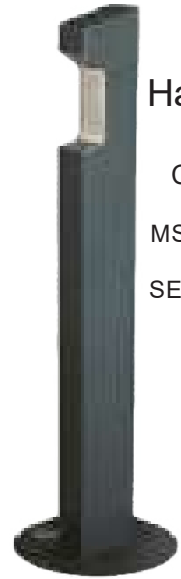

TEXTURED STEEL GREY
UV4



Hand Sanitizer Dispenser

Steel construction • Hands free foot pump
Can be bolted down • Hardware not included

MSRP: \$650 EA.

SELL PRICE: **\$425 EA.**

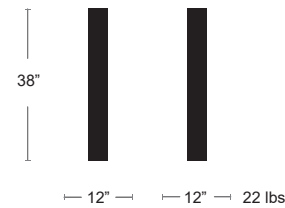
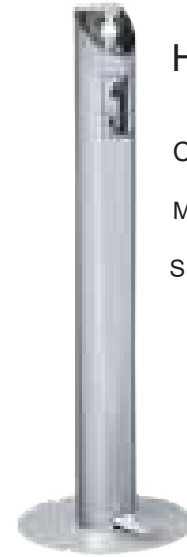

SILVER RAL 9006
UV1

COMPLEMENTS



Valles Bench

Tubular steel frame • Perforated steel mesh seat and back
Electro galvanized steel with powder coat finish
Can be bolted down • Hardware not included

MSRP: \$3710 EA. SELL PRICE: **\$2410 EA.**



GLOSSY SILVER
U340M

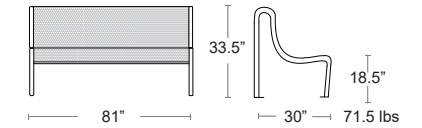

Valles Backless Bench

Tubular steel frame • Perforated mesh seat
Electro galvanized steel with powder coat finish
Can be bolted down • Hardware not included

MSRP: \$3200 EA. SELL PRICE: **\$2080 EA.**



GLOSSY SILVER
U340B

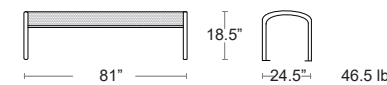

Omega Bike Rack



Steel • Electrolyte zinc plated and powder coat finish
Can be bolted down • Hardware not included

MSRP: \$650 EA. SELL PRICE: **\$425 EA.**

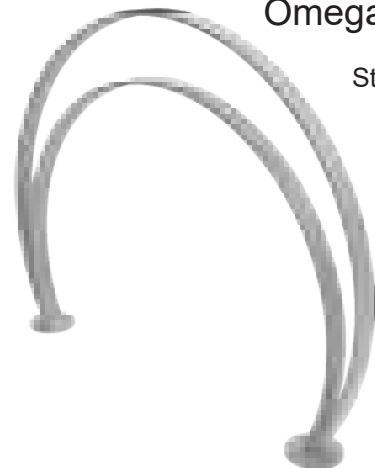

GLOSSY SILVER
U201

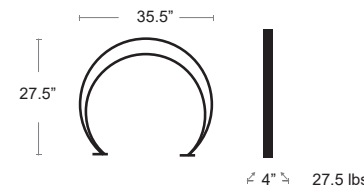

Ecosens Bench



Steel frame • Recycled Poly Plank seat and back
Ferrus treatment and silver polyester powder coat finish
Can be bolted down • Hardware not included

MSRP: \$3240 EA. SELL PRICE: **\$2100 EA.**



RECYCLED POLY/
SILVER U362

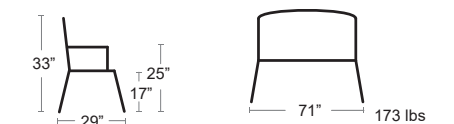

Litter Bin Pg.154



Clash Stand Up Ashtray



Galvanized steel and stainless steel top •
Locking system
Can be bolted down • Hardware not included

MSRP: \$1050 EA.

SELL PRICE: **\$685 EA.**

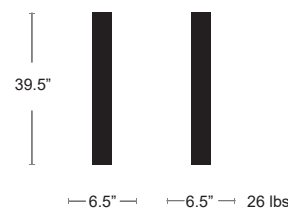

GLOSSY GREY BROWN
RAL 8019
UVC1



Clash Wall Mount Ashtray



Galvanized steel & stainless steel top
Locking system • Wall mount

MSRP: \$730 EA.

SELL PRICE: **\$475 EA.**

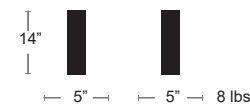

GLOSSY GREY BROWN
RAL 8019
UVC2

COMPLEMENTS

Citizen Bench



Cast iron frame and legs • Tropical wood slats
 Can be bolted down • Hardware not included
 MSRP: \$3200 EA. SELL PRICE: **\$2080 EA.**



TEXTURED CORTEN /TROPICAL WOOD
 (CORTEN STAIN) U301

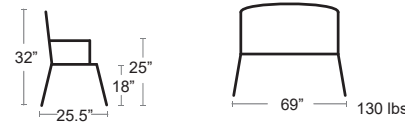

Essen Bench



Solid Cast iron legs • Steel seat and back • Epoxy primer
 Ferrus treatment and powder coat finish
 Can be bolted down • Hardware not included
 MSRP: \$3140 EA. SELL PRICE: **\$2040 EA.**



STEEL GREY
 U397M



Neobarcano Bench



Cast iron frame • Epoxy primer with ferrus treatment and powder coat finish
 Tropical wood with natural stain and lingus fungicide/insecticide
 Can be bolted down • Hardware not included
 MSRP: \$3000 EA. SELL PRICE: **\$1950 EA.**



HAMMERED GREY/TROPICAL WOOD
 (NATURAL STAIN) U304

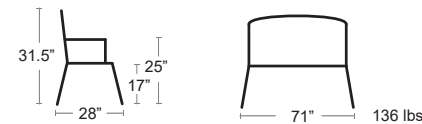

COMPLEMENTS

Segno Bench 2 Sizes



Square tubular steel frame • Steel slat seat and back • E-coated powder coat finish
 Bolt-down kit MSRP: \$80 EA. SELL PRICE: **\$55 EA.**

MSRP: \$1740 EA. SELL PRICE: **\$1100 EA.**

MSRP: \$1530 EA. SELL PRICE: **\$1000 EA.**

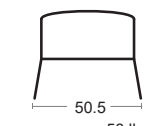
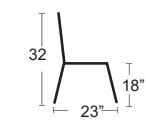
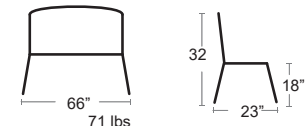
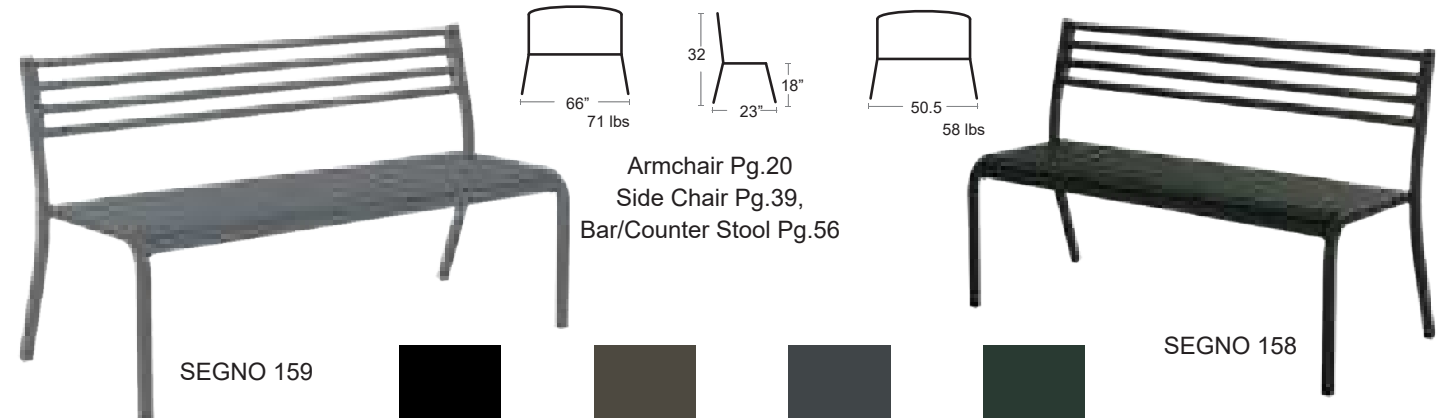

Armchair Pg.20
 Side Chair Pg.39,
 Bar/Counter Stool Pg.56

SEGNO 159



SEGNO 158

Arc En Ciel Bistrot Set



2 Side Chairs - Steel frame • Steel slat seat and back • E-coated powder coat finish • Folding
 1 Table 28" - Solid steel top table and legs • E-coated powder coat finish • Folding
 MSRP: \$880 EA. SELL PRICE: **\$570 EA.**
 Side Chair Pg.45, Tables Pg.90



CHERRY
 3513-50

IRON
 3513-22



WHITE
 3513-23

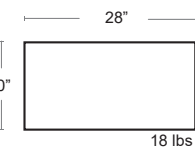
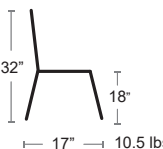

COMPLEMENTS

Afuera Beachcomber

Outdoor / Indoor Area Rug • 100% Fiber Enhanced Polypropylene
Water, Mold/Mildew Resistant • UV Stabilized • Colour Onyx / Shell

MSRP: \$940 EA. SELL PRICE: \$590 EA.

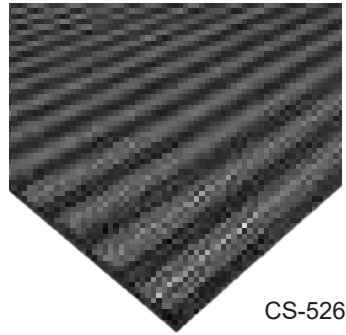

CS-5262/9008

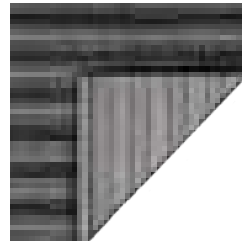

Cape Fayston

Outdoor / Indoor Area Rug • 100% Fiber Enhanced Polypropylene
Water, Mold/Mildew Resistant • UV Stabilized • Colour Silver/Charcoal

MSRP: \$940 EA. SELL PRICE: \$590 EA.



CS-9860/9009

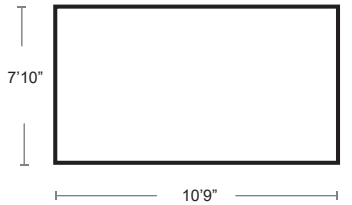

Recife

Outdoor / Indoor Area Rug • 100% Fiber Enhanced Polypropylene
Water, Mold/Mildew Resistant • UV Stabilized • Color Grey/White

MSRP: \$940 EA. SELL PRICE: \$590 EA.



1001/3012

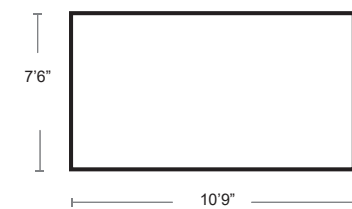
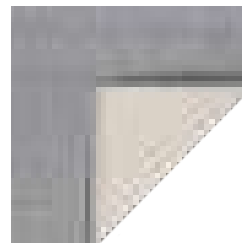

Doggy SERRALUNGA

Resin sculptural structure • UV Protected • -40C +40C
MSRP: \$360 EA. SELL PRICE: \$235 EA.



ANTRACITE
55-ANT



DALMATION
55-DAL

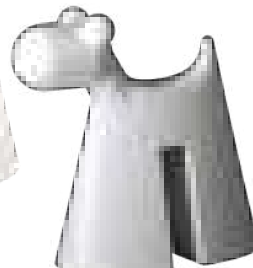

WHITE
55-WH



COFFEE DELAVE
55-ICA

COMPLEMENTS

Selectspace Partitions

Super easy to install! The only components that need assembly are the regular stands, all the other components come ready-to-use right out of the box. The panels and stands connect quickly and easily with spring push-buttons. Temporary or permanent, all the SelectSpace stand bases come with bolt hole knock-outs that can be removed and used to bolt the partitions into the ground.

If you want your system to be easily removable, simply leave the knock-outs in place.

Panels are fabricated from heavy gauge perforated aluminum. Posts are heavy gauge aluminum and stainless steel bases, with leveling legs for uneven ground.

All components are powder coated and rust proofed.

3 Foot Panel

MSRP: \$890 EA.
SELL PRICE: \$580 EA.

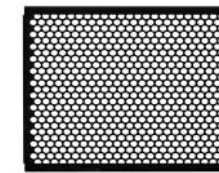
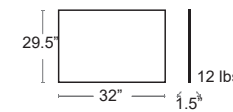

BLACK
PP3000-001

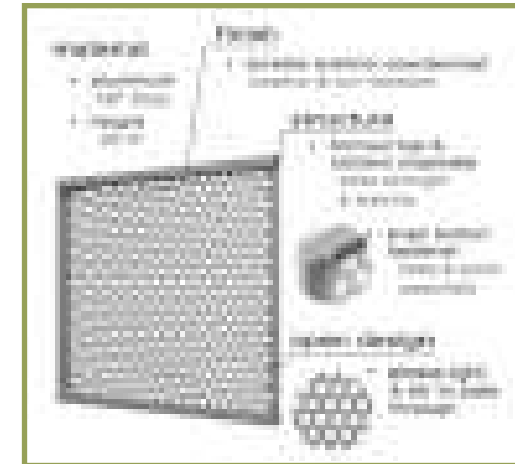

5 Foot Panel

MSRP: \$1240 EA.
SELL PRICE: \$810 EA.

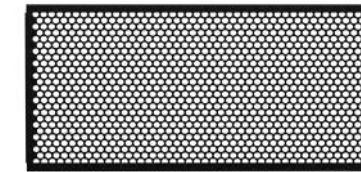
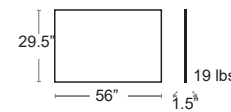

BLACK
PP5000-001



7 Foot Panel

MSRP: \$1540 EA.
SELL PRICE: \$1000 EA.

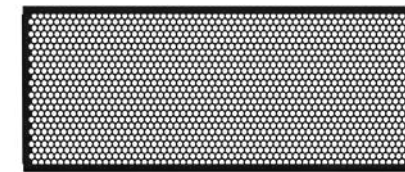
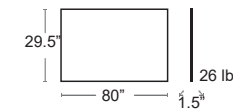

BLACK
PP7000-001

Custom Colors

2-3 weeks delivery • Call for pricing



GREY
RAL7040



ROYAL BLUE
RAL5002



SKY BLUE
RAL5012



PURPLE
RAL4005



TEAL
RAL5018



FOREST GREEN
RAL6029



SELECT SPACE
GREEN
RAL6010



RED
RAL3003



BURNT ORANGE
RAL8023



BROWN
RAL8028



SAND
RAL1001



BRIGHT YELLOW
RAL1023



WHITE
RAL9003

COMPLEMENTS

Custom Cut Panels
6-8 weeks delivery



5 Foot Panel



MSRP: \$1550 EA.
SELL PRICE: **\$1010 EA.**



BLACK SSP-PP5001-001

7 Foot Panel

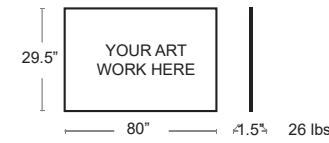

MSRP: \$1830 EA.
SELL PRICE: **\$1190 EA.**



Posts

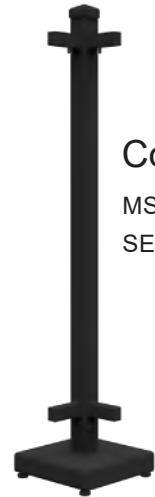

Corner Post • 30 lbs
MSRP: \$880 EA.
SELL PRICE: **\$570 EA.**

BLACK
SSP-P223A-PLUS2-001



End Post • 13 lbs
MSRP: \$880 EA.
SELL PRICE: **\$570 EA.**

BLACK
SSP-P223E-PLUS2-001



Straight Post • 13 lbs
MSRP: \$880 EA.
SELL PRICE: **\$570 EA.**

BLACK
SSP-P223S-PLUS2-001

Gate Set



Heavy gauge perforated aluminum gate panel • Aluminum pole • Powder coated • Rust proof • Stainless steel base • Leg levelers • Gates open 180 degrees • Adjustable spring caster and removable padlock hasp included

Bolt hole knock-outs for permanent mounting if needed

MSRP: \$3200 EA. SELL PRICE: **\$2100 EA.**

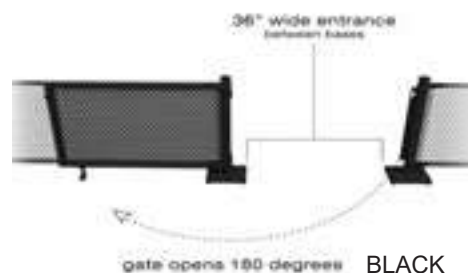

BLACK
GS001-PLUS2-001

Gate Set
Circle Pattern, Straight Stands
included parts

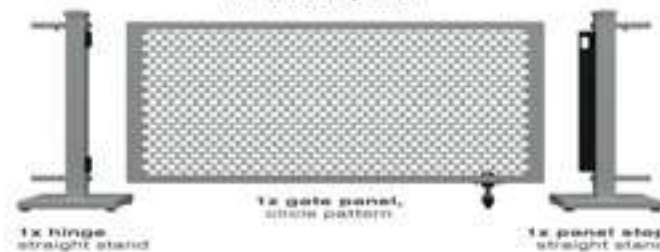



SHADE

ONDA SOLID:   **GIULIO BARBIERI** 

Aluminum and galvanized polyester powder coated steel components • Hand operated retractable roof using concealed magnet system

ONDA STRUCTURE:

4.7" Diameter 1 piece Aluminum posts • 8 included • Cataphoresis-treated and coated with polyester powder • Nuts and bolts are stainless steel • Bolt-down hardware not included • Attach multiple units together

ONDA TOP COVER:

Ferrari Pre-Constraint 502 • Heavy duty • M2 flame retardant PVC fabric • Pre-stressed PVC coated fabric designed for external use

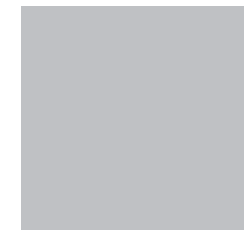

TOP COVER -
SILVER



STRUCTURE -
CHARCOAL

Onda 13'X16' Rectangle

MSRP: \$12880 EA.

SELL PRICE: **\$8400 EA.**

DIMENSIONS: H 99", W 158", D 197", 505 lbs
CODE: ONDA16x13RECT

Onda 10'X16' Rectangle

MSRP: \$11700 EA.

SELL PRICE: **\$7600 EA.**

DIMENSIONS: H 99", W 118", D 197", 455 lbs
CODE: ONDA16x10RECT

Onda 10'X13' Rectangle

MSRP: \$10800 EA.

SELL PRICE: **\$7020 EA.**

DIMENSIONS: H 99", W 118", D 158", 425 lbs
CODE: ONDA13x10RECT

Onda 16' Square

MSRP: \$14000 EA.

SELL PRICE: **\$9100 EA.**

DIMENSIONS: H 99", W 197", D 197", 425 lbs
CODE: ONDA16SQ

Onda 13' Square

MSRP: \$11920 EA.

SELL PRICE: **\$7750 EA.**

DIMENSIONS: H 99", W 158", D 158", 425 lbs
CODE: ONDA13SQ

Onda 10' Square

MSRP: \$10000 EA.

SELL PRICE: **\$6500 EA.**

DIMENSIONS: H 99", W 118", D 118", 395 lbs
CODE: ONDA10SQ

Crank Roller Blind
Mesh Soltis Color-Charcoal
10' • 13' • 16'

16' WALL MSRP: \$2460

SELL: **\$1600**

13' WALL MSRP: \$2140

SELL: **\$1390**

10' WALL MSRP: \$1820

SELL: **\$1185**

SHADE



Ocean Master MAX - Cantilever 10' SQ

Polished aluminum frame • Offset pole • Single vent • Market cut canopy • Sunbrella Marine Grade fabric
Crank telescoping lift system • All parts are replaceable

MSRP: \$21000 EA. SELL PRICE: **\$12870 EA.**

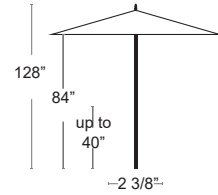

Bay Master MAX 13' Square

Brushed aluminum frame • Center pole and stem • Single vent • Market cut canopy
Sunbrella Marine Grade fabric • Manual lift with easy grip handle
All parts are replaceable

MSRP: \$10600 EA. SELL PRICE: **\$6900 EA.**

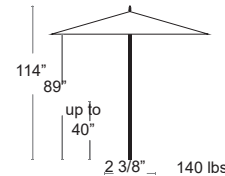

Bay Master MAX 10' Square

Brushed aluminum frame • Center pole and stem • Single vent • Market cut canopy
Sunbrella Marine Grade fabric • Manual lift with easy grip handle
All parts are replaceable

MSRP: \$8300 EA. SELL PRICE: **\$5400 EA.**

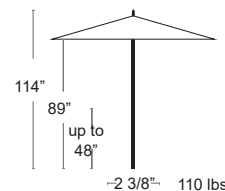

SHADE



MAX G Base fits with MAX collection umbrellas • Galvanized steel plates • Rounded corners
Each single plate is 1/2" Thick
Stem comes with MAX umbrella, not base



QUAD STACK
36" SQUARE, 800 lbs
GV36SQX4 QUAD
MSRP: \$10200 EA.
SELL PRICE: **\$6600**



TRIPLE STACK
36" SQUARE, 600 lbs
GV36SQX3 TRIPLE
MSRP: \$8000 EA.
SELL PRICE: **\$5200**



DOUBLE STACK
36" SQUARE, 400 lbs
GV36SQX2 DOUBLE
MSRP: \$5800 EA.
SELL PRICE: **\$3800**



SINGLE 36" SQUARE,
200 lbs
GV36SQ
MSRP: \$3600 EA.
SELL PRICE: **\$2400**

MAX On Ground Mount



To be used on existing cement surfaces
9"X9" stainless steel • Mounting hardware included
MSRP: \$1800 EA.
SELL PRICE: **\$1170**



MAX In Ground Mount



To be used on new cement only • Stainless steel
MSRP: \$1480 EA.
SELL PRICE: **\$960**



IGSM



Oasis Cantilever 10' SQ



Recasens Recacril 9 oz Marine Grade Solution Dyed Acrylic Fabric • Wind stabilizer kit included • Extruded Aluminum • Stainless steel hardware • Crank lift • Infinity tilt with 360 degree rotation
Protective Cover Included with Purchase

MSRP: \$7800 EA. SELL PRICE: \$5070 EA.



VERMILION
RED R-182



SEASHELL
WHITE R-122



DARK
GREY R-150

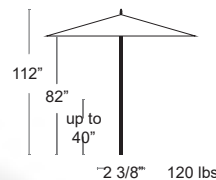

883ECU-SQ-MS

Triple Stack Base with Wheels



Galvanized Steel plate • Silver dacromet coated
Triple stacked • Hardware included • 600 lbs

MSRP: \$5800 EA. SELL PRICE: \$3770 EA.



Galvanized Steel
36G-SQX3+W

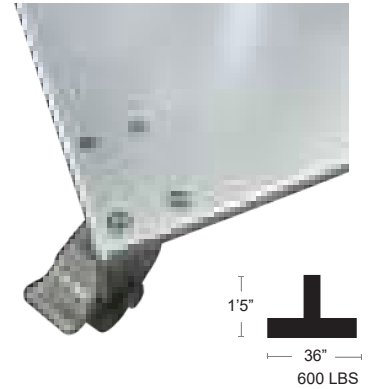
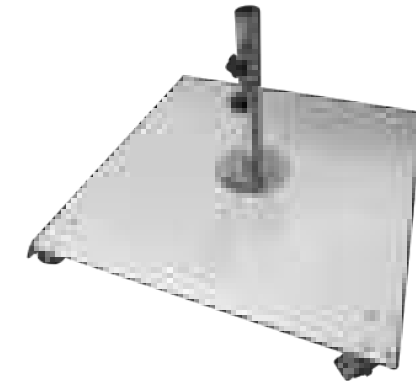

On Ground Direct Surface Mounting Plate



Can be mounted to Concrete or Wood • Use with Frankford Eclipse Cantilever
DIMENSIONS: 12.5" ROUND, 12 lbs

MSRP: \$600 EA. SELL PRICE: \$390 EA.



SILVER MIST
ECU-DP-SS

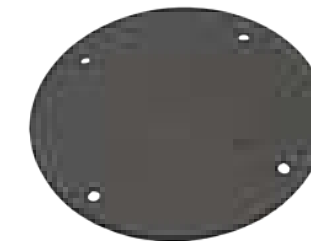

BLACK
ECU-DP

LED Light Stick with Clip



LED light bar system • Light bar attached to rib of umbrella
Natural white light bulb 4000K-5200K • Rechargeable battery
6-8 hours of usage on full brightness • 24 hours of usage on 50% brightness
Each light comes with a specific attachment clip for your specific umbrella

DIMENSIONS: L 12", W 1", D 1.5, 1 lbs
MSRP: \$140 EA. SELL PRICE: \$90 EA.

LED.LIGHT.KIT FF325C



In Ground Mounting Stem For New Concrete



Galvanized Steel • Use with Frankford Eclipse Cantilever • 18 lbs • 8"X 20"

MSRP: \$350 EA. SELL PRICE: \$230 EA.



ECU-IG

SHADE

Bay Master 8.0' and 6.5' Square



Brushed aluminum frame • 1 piece 1.5" brushed aluminum center pole • Single vent • Market cut canopy • Sunbrella furniture grade fabric • Ballistic nylon reinforced pockets • Manual lift with stainless steel pin
All parts are replaceable

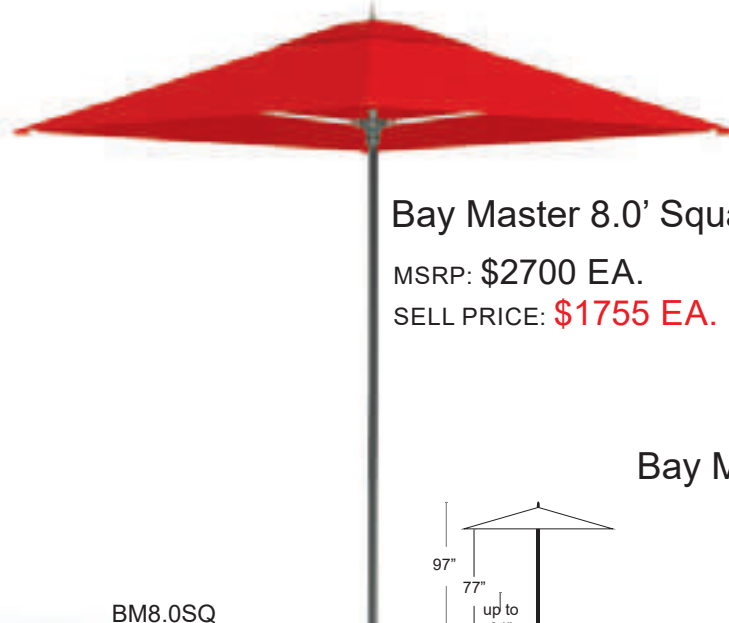

Bay Master 8.0' Square

MSRP: \$2700 EA.
SELL PRICE: **\$1755 EA.**



Bay Master 6.5' Square

MSRP: \$2000 EA.
SELL PRICE: **\$1300 EA.**

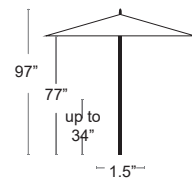

BM8.0SQ

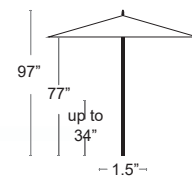

BM6.5SQ

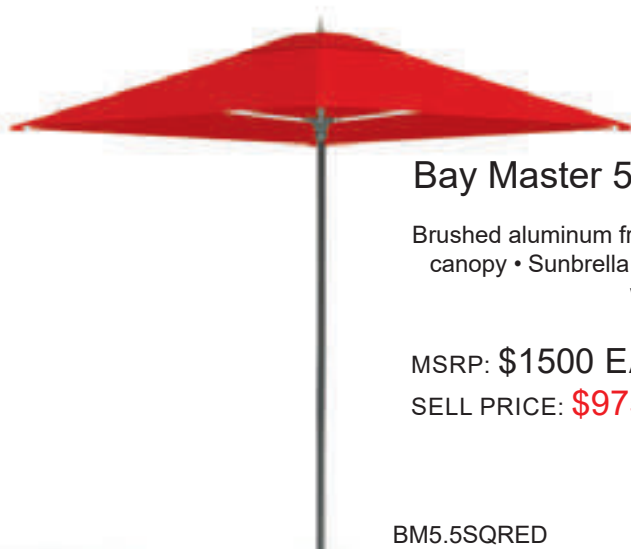
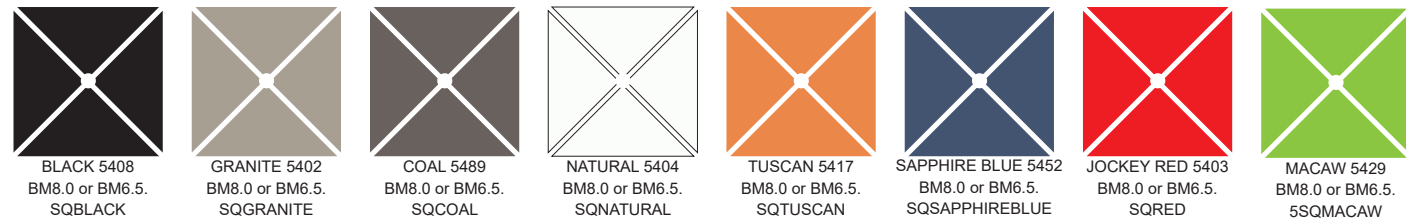

Bay Master 5.5' Square



Brushed aluminum frame • 1 piece brushed aluminum center pole • Single vent • Market cut canopy • Sunbrella furniture grade fabric • Ballistic nylon reinforced pockets • Manual lift with stainless steel pin • All parts are replaceable

MSRP: \$1500 EA.
SELL PRICE: **\$975 EA.**



JOCKEY RED
5403

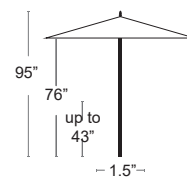

BM5.5SQRED

SHADE

Oasis 7.5 Square



Recasens Recacril 9 oz Marine Grade Solution Dyed Acrylic Fabric
Brushed aluminum frame Single wind vent • 2 piece center pole
Stainless steel hardware • Manuel lift with pin

MSRP: \$1020 EA. SELL PRICE: **\$665 EA.**
Custom colour fabric call for options
MSRP: \$1520 EA. SELL PRICE: **\$990 EA.**



SEASHELL WHITE
OASIS7.5SQ

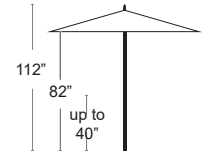

Oasis 9.0 Octagon



Recasens Recacril 9 oz Marine Grade Solution Dyed Acrylic Fabric
Brushed aluminum frame • Single wind vent • 2 piece center pole
Stainless steel hardware • Manuel lift with pin

MSRP: \$980 EA. SELL PRICE: **\$640 EA.**
Custom colour fabric call for options
MSRP: \$1400 EA. SELL PRICE: **\$910 EA.**



DARK GREY
OASIS9.0OCT

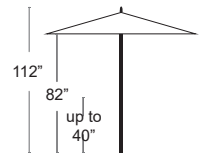
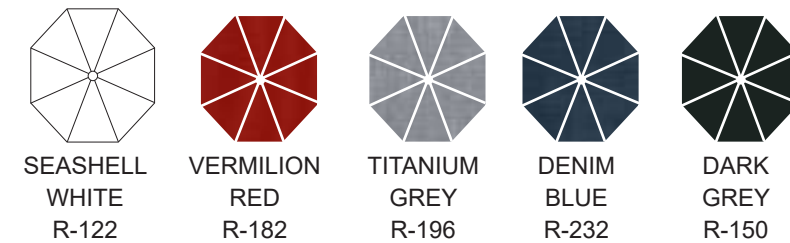

LED Light Stick with Clip



LED light bar system • Light bar attached to rib of umbrella
Natural white light bulb 4000K-5200K • Rechargeable battery
6-8 hours of usage on full brightness • 24 hours of usage on 50% brightness
Each light comes with a specific attachment clip for your specific umbrella

DIMENSIONS: L 12", W 1", D 1.5, 1 lbs
MSRP: \$140 EA. SELL PRICE: **\$90 EA.**

LED.LIGHT.KIT+1835C



SHADE

G Base



G base will fit with all Tuuci umbrellas with a 1.5" thick center pole • Galvanized steel plates • Rounded corners
Each plate is 1/2" Thick • Deck mount and hardware included • Lock hole available on request



30" SQUARE, 140 lbs GV30SQ MSRP: \$1780 EA. SELL PRICE: \$1150 EA.	30" ROUND, 105 lbs GV30RND MSRP: \$1580 EA. SELL PRICE: \$1020 EA.	24" SQUARE, 90 lbs GV24SQ MSRP: \$1300 EA. SELL PRICE: \$845 EA.	24" ROUND, 75 lbs GV24RND MSRP: \$1220 EA. SELL PRICE: \$790 EA.
--	--	--	--

Aluma Crete



Aluma-Crete base • Aluminum shell filled with concrete • Powder coated silver • Stainless steel security sleeve and hardware • Fits up to 1.5" thick center pole umbrellas • Lock hole available on request



28" ROUND WITH WHEELS, 150 lbs SILVER/ACF150W MSRP: \$1660 EA. SELL PRICE: \$1080 EA.	28" ROUND, 150 lbs SILVER/ACF150 MSRP: \$1250 EA. SELL PRICE: \$810 EA.	24" ROUND WITH WHEELS, 95 lbs SILVER/ACF95W MSRP: 1350 EA. SELL PRICE: \$875 EA.
24" ROUND, 95 lbs SILVER/ACF95 MSRP: \$940 EA. SELL PRICE: \$610 EA.	20" ROUND, 65 lbs SILVER/ACF65 MSRP: \$830 EA. SELL PRICE: \$540 EA.	Master Lock MSRP: \$44 EA. SELL PRICE: \$28 EA.

LOCK

SHADE

Oasis Steel Base With Wheels



Powder coated Silver Mist • 2 stationary wheels • 16" threaded stem
Fits 1.5" Umbrella pole • 2 locking points • 4 holes to bolt down if required
75 lbs

MSRP: \$540 EA. SELL PRICE: **\$350 EA**



SILVER MIST
OASIS- 75S-SM

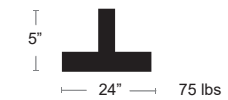

Oasis 80 Coated Concrete Base



Resin coated concrete filled base • 2 locking points
Bottom of base can be bolted to a surface • 80 lbs

MSRP: \$280 EA. SELL PRICE: **\$180 EA**

Additional 35 lb ring
MSRP: \$190 EA. SELL PRICE: **\$125 EA**



MATTE SILVER
OASIS-23-MS

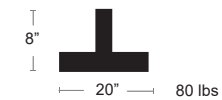

Oasis 50 Coated Concrete Base



Resin coated concrete filled base • 50 lbs

MSRP: \$170 EA. SELL PRICE: **\$110 EA**

USE WITH TABLE ONLY - NOT FREE STANDING



MATTE SILVER
50C-MS

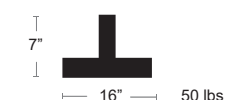

Flush Mount



Stainless steel ground flush mount • Comes with aluminum extension pole
Fits 1.5" thick center pole umbrellas • Mounting hardware included • 6 lbs
Lock hole available on request

MSRP: \$1050 EA. SELL PRICE: **\$680**



FLUSHMT

Deck Mount



Stainless steel • Star knob locking system • 4 lbs
Lock hole available on request

MSRP: \$430 EA. SELL PRICE: **\$280**



DECKMNT





PLANTERS

Adan Large Planter VONDOM® 

Rotational molded resin planter • UV Protected • Can handle -40C to +40C
 Suitable for both outdoor and indoor use • Holds 19 Gallons
 MSRP: \$3340 EA. **SELL PRICE: \$2170 EA.**



WHITE
49074A



BLACK
49074A

Table Pg.145
Adan Small Planter Pg.179

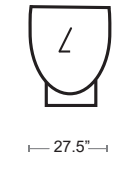
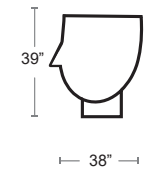

Faz Wall VONDOM® 

Rotational molded resin planter • UV Protected • Can handle -40C to +40C
 • Suitable for both outdoor and indoor use • Holds 38.25 Gallons
 MSRP: \$1900 EA. **SELL PRICE: \$1240 EA.**

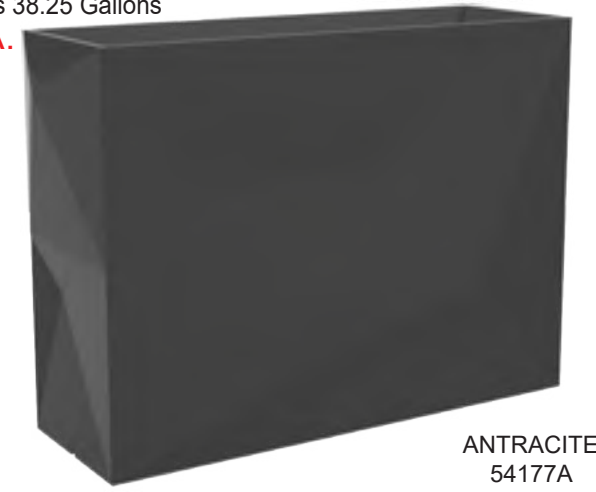

ANTRACITE
54177A

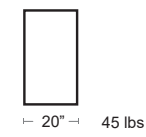
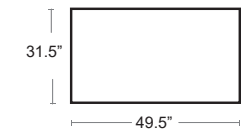

Muro VONDOM® 

Rotational molded resin planter • UV Protected • Can handle -40C to +40C • Suitable for both
 outdoor and indoor use • Holds 24 Gallons
 MSRP: \$1780 EA. **SELL PRICE: \$1160 EA.**



ANTRACITE
42620A

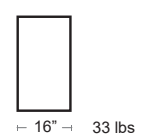
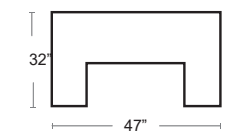

PLANTERS

Gatsby Wall **VONDOM**

Rotational molded resin planter • UV Protected • Can handle -40C to +40C • Suitable for both outdoor and indoor use • Holds 51 Gallons

MSRP: \$1600 EA. SELL PRICE: **\$1040 EA.**



Lounge Pg. 113



ANTRACITE
54436A-ANT

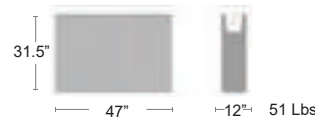

PLANTERS

Adan Small Planter **VONDOM**

Rotational molded resin planter • UV Protected • Can handle -40C to +40C • Suitable for both outdoor and indoor use • Holds 11 Gallons

MSRP: \$1430 EA. SELL PRICE: **\$930 EA.**



BLACK
49060A



WHITE
49060A

Table Pg. 145
Adan Large Planter Pg. 177

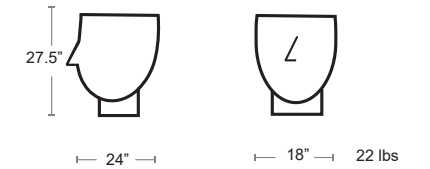

Wall **VONDOM**

Rotational molded resin planter • UV Protected • Can handle -40C to +40C
• Suitable for both outdoor and indoor use • Holds 23. Gallons

MSRP: \$1540 EA. SELL PRICE: **\$1000 EA.**

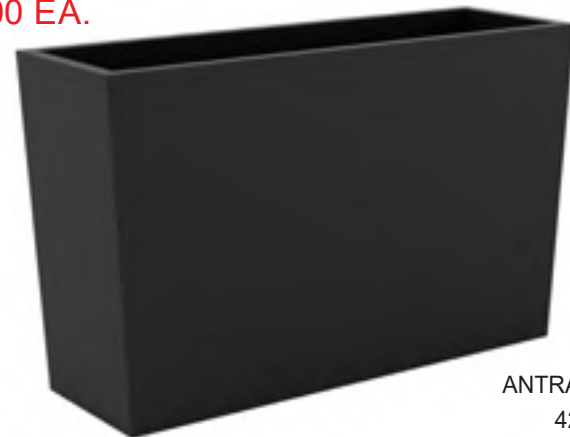

ANTRACITE
42430A

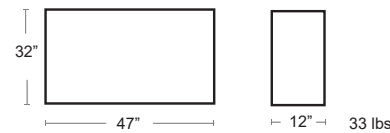

Jardinera **VONDOM**

Rotational molded resin planter • UV Protected • Can handle -40C to +40C • Suitable for both outdoor and indoor use • Holds 79 Gallons

MSRP: \$1280 EA. SELL PRICE: **\$830 EA.**



ANTRACITE
41650-ANT

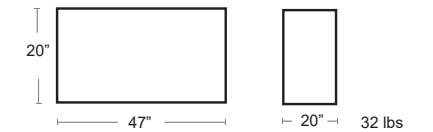

Maceta 32" Round **VONDOM**

Rotational molded resin planter • UV Protected • Can handle -40C to +40C
• Suitable for both outdoor and indoor use • Holds 58 Gallons

MSRP: \$1540 EA. SELL PRICE: **\$1000 EA.**



ANTRACITE
40180A-ANT

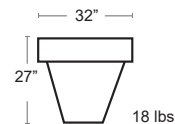

Cubo High **VONDOM**

Rotational molded resin planter • UV Protected • Can handle -40C to +40C
• Suitable for both outdoor and indoor use • Holds 66 Gallons

MSRP: \$1240 EA. SELL PRICE: **\$800 EA.**



ANTRACITE
41451A

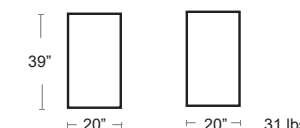

PLANTERS



Sipario 3

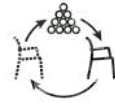

NARDI **CATAS**
YOUR OUTDOOR LIVING



Modular Partition wall system • Polypropylene resin • Self watering planter • UV Protected
GREEN GOOD DESIGN AWARD 2021

MSRP: \$750 EA. SELL PRICE: **\$490 EA.**

Stack Mini Pg.50
Stack Maxi Pg.67
Combo Tables Pg.93
Sipario 2 Pg.181
Sipario Vaso Pg.182



The Nardi Regeneration industrial program is creating a line of outdoor furniture specifically dedicated to regenerated plastic products, made of post-industrial and post-consumer polypropylene, which can in turn be recycled.
The uneven colour that changes into various shades of brown is not a defect but a specific feature of recycled plastic.
We call the color Terra, the natural colour of earth

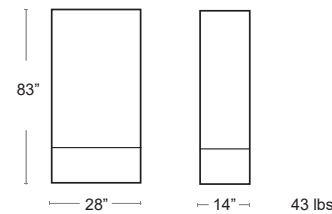

TERRA
40395.44.000

PLANTERS

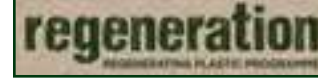

Sipario 2



NARDI **CATAS**
YOUR OUTDOOR LIVING



Modular Partition wall system • Polypropylene resin • Self watering planter • UV Protected
GREEN GOOD DESIGN AWARD 2021

MSRP: \$580 EA. SELL PRICE: **\$380 EA.**

The Nardi Regeneration industrial program is creating a line of outdoor furniture specifically dedicated to regenerated plastic products, made of post-industrial and post-consumer polypropylene, which can in turn be recycled.
The uneven colour that changes into various shades of brown is not a defect but a specific feature of recycled plastic.
We call the color Terra, the natural colour of earth

Stack Mini Pg.50
Stack Maxi Pg.67
Combo Tables Pg.93
Sipario 1 Pg.180
Sipario Vaso Pg.182

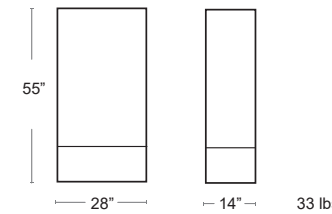

TERRA
40394.44.000



Newpot 60 SERRALUNGA

Rotational molded resin planter • UV Protected • Can handle -40C to +40C
• Suitable for both outdoor and indoor use

MSRP: \$500 EA. SELL PRICE: **\$325 EA.**



WHITE
NEWPOT60-WH



ANTRACITE
NEWPOT60-ANT



Newpot 70 SERRALUNGA

Rotational molded resin planter • UV Protected • Can handle -40C to +40C
• Suitable for both outdoor and indoor use

MSRP: \$650 EA. SELL PRICE: **\$425 EA.**



ANTRACITE
NEWPOT70-ANT



WHITE
NEWPOT70-WH

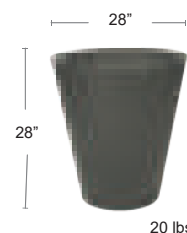

Vaso Rectangallore SERRALUNGA

Rotational molded resin planter • UV Protected • Can handle -40C to +40C
• Suitable for both outdoor and indoor use

MSRP: \$500 EA. SELL PRICE: **\$325 EA.**

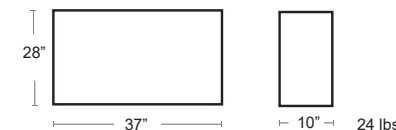

722-ANT

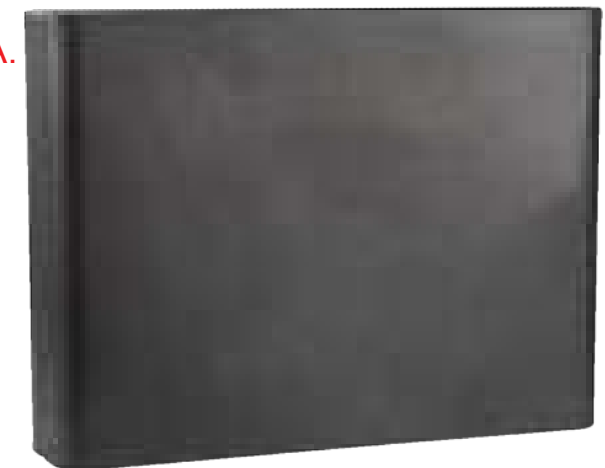

PLANTERS

Cubotti SERRALUNGA

Rotational molded resin planter • UV Protected • Can handle -40C to +40C
 • Suitable for both outdoor and indoor use
 MSRP: \$450 EA. SELL PRICE: **\$290 EA.**

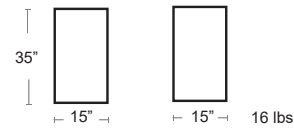

335-HIGH-ANT



Newpot 50 SERRALUNGA

Rotational molded resin planter • UV Protected • Can handle -40C to +40C
 • Suitable for both outdoor and indoor use
 MSRP: \$400 EA. SELL PRICE: **\$260 EA.**

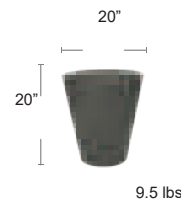

ANTRACITE
NEWPOT50-ANT

WHITE
NEWPOT50-WH

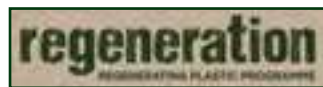

Sipario Vaso 



NARDI CATAS 
YOUR OUTDOOR LIVING

Modular Partition wall system • Polypropylene resin • Self watering planter • UV Protected
 GREEN GOOD DESIGN AWARD 2021

MSRP: \$230 EA. SELL PRICE: **\$150 EA.**

The Nardi Regeneration industrial program is creating a line of outdoor furniture specifically dedicated to regenerated plastic products, made of post-industrial and post-consumer polypropylene, which can in turn be recycled.

The uneven colour that changes into various shades of brown is not a defect but a specific feature of recycled plastic.

We call the color Terra, the natural colour of earth

Stack Mini Pg.50
 Stack Maxi Pg.67
 Combo Tables Pg.93
 Sipario 1 Pg.180
 Sipario 2 Pg.181

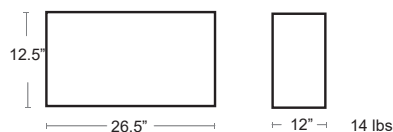

TERRA
40382.44.000



FLAME

Moderne Fire Table • Propane    

Fiberglass reinforced cast concrete • Stainless steel burner • Electronic Ignition
60,000 BTU professional burner system • Auto flame out for safety • Includes levelers for stability

SOLD AS A COMPLETE SET

Aluminum burner cover • Tempered Glass Wind Screen 38"x24" • 10' propane hose
Propane tank cover • All weather cover • Natural Bali rocks

MSRP: \$7790 EA. **SELL PRICE: \$5060 EA.**



Propane tank cover/side table or seat
Fiberglass reinforced cast concrete

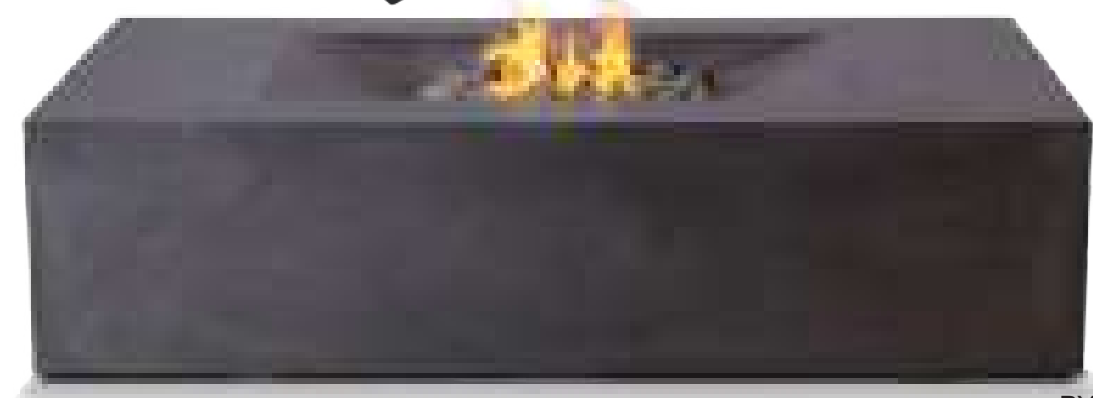

CHARCOAL
PYRO-C-MO-CH-LP 210 lbs



Moderne Fire Table • Natural Gas    

Fiberglass reinforced cast concrete • Stainless steel burner • Electronic Ignition
60,000 BTU professional burner system • Auto flame out for safety • Includes levelers for stability

SOLD AS A COMPLETE SET

Aluminum burner cover • Tempered Glass Wind Screen 38"x24"
All weather cover • Natural Bali rocks

MSRP: \$7070 EA. **SELL PRICE: \$4600 EA.**



CHARCOAL
PYRO-C-MO-CH-NG 374 lbs

FLAME

Tao Fire Table • Natural Gas

Fiberglass reinforced cast concrete • Stainless steel burner • Electronic Ignition
60,000 BTU professional burner system • Auto flame out for safety • Includes levelers for stability



SOLD AS A COMPLETE SET

Aluminum burner cover • Tempered Glass Wind Screen 30" Diameter
All weather cover • Natural Bali rocks

MSRP: \$6710 EA. **SELL PRICE: \$4400 EA.**



SLATE GREY
TA-SL-NG



FLAME

NEXUS Flame Table 56"

Cast aluminum construction that looks like formed concrete.
Premium stainless steel burner with lava rock media • Cover included • 53,000 BTU's

SOLD AS A COMPLETE SET

Aluminum burner cover • Tempered Glass Wind Screen • 10' propane hose
Propane tank cover • All weather cover • Natural Bali rocks

COMPLETE SET PRICE \$2049

Natural Gas Conversion Kit available
- Sold separately **\$150 EA.**

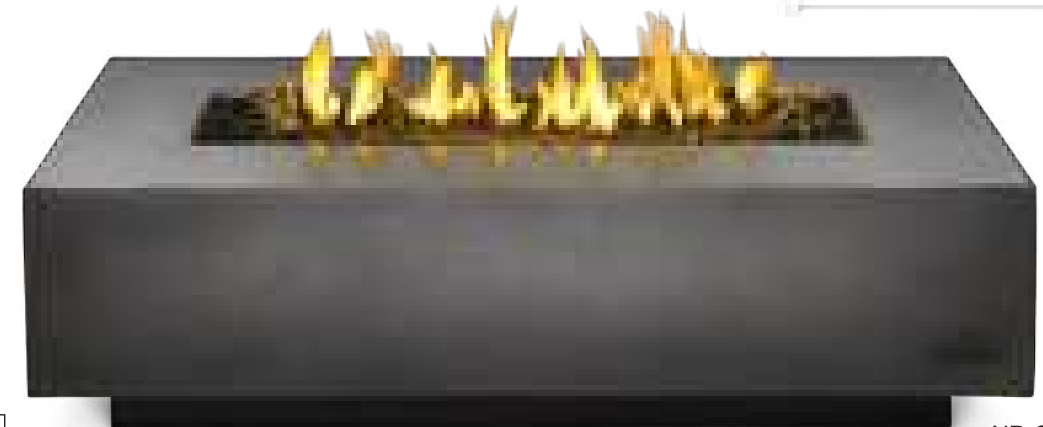

NP-GPFRCN56

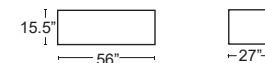

NEXUS Flame Table 72"

Cast aluminum construction that looks like formed concrete.
Premium stainless steel burner with lava rock media • Cover included • 53,000 BTU's

SOLD AS A COMPLETE SET

Aluminum burner cover • Tempered Glass Wind Screen • 10' propane hose
Propane tank cover • All weather cover • Natural Bali rocks

COMPLETE SET PRICE \$2749

Natural Gas Conversion Kit available
- Sold separately **\$150 EA.**

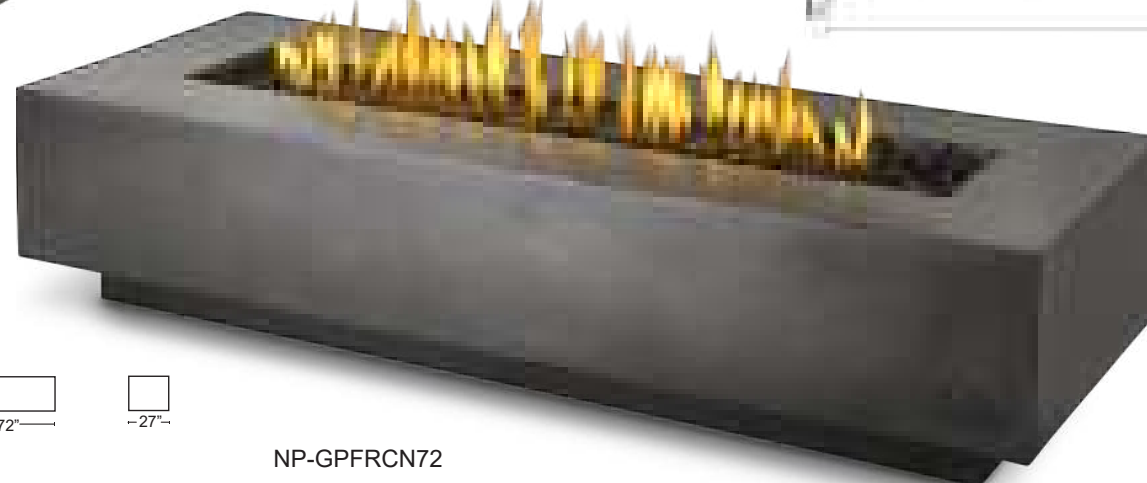

NP-GPFRCN72

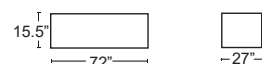

NEXUS Flame Table 36"

Cast aluminum construction that looks like formed concrete.
Premium stainless steel burner with lava rock media • Cover included • 53,000 BTU's

SOLD AS A COMPLETE SET

Aluminum burner cover • Tempered Glass Wind Screen • 10' propane hose
Propane tank cover • All weather cover • Natural Bali rocks

COMPLETE SET PRICE \$1449

Natural Gas Conversion Kit available
- Sold separately **\$150 EA.**



NP-GPFCCN36

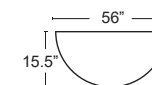

FLAME

St. Tropez  

Rectangular and Square Linear Design Patio Flame Tables
 All aluminum construction • Propane tank can be hidden inside the table
 Stylish glass ember bed • Easy start electronic ignition • 60,000 BTU of Heat
 Thermo-couple valve shuts off gas supply if flame is extinguished
 Stainless steel 10"x 30" pan burner Comes complete with lid for burner and natural gas conversion kit
COVER AND GLASS WINDSCREEN INCLUDED WITH TABLE

COMPLETE SET PRICE \$1847



RECTANGLE
Rustic bronze
STTR1-BZ-SET

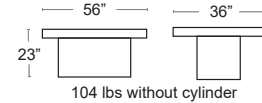

SQUARE
Rustic bronze
STTR2-BZ-SET

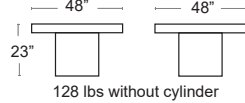

FLAME

Tower Heater  

The Quartz Tube Tower Heater brings a new look to outdoor heating. Made to withstand all commercial applications, its strengthened stainless steel (304) construction provides the durability needed all year round. • 42,000 BTU
 • Heat range of up to 10' diameter • Piezo Push -button ignition
 • Variable gas control valve • Standard 20 Lb and 30 Lb propane tank compatible
 • 304 stainless steel body, wire mesh and hardware
 • Fused tempered quartz glass • Aluminum Frame
 • Larger steel reflector • Flame height adjustment control knob
 • Wheels designed for easy mobility

SPECIAL SELL PRICE: \$978 EA.



2660-SS



WHEEL DETAIL

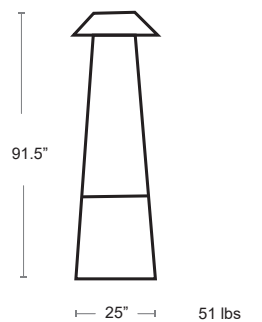

Hampton  

Rectangular and Square Linear Design Patio Flame Tables
 Rust proof aluminum • Lightweight • Weather resistant • Easy start electronic ignition
 Thermo-couple valve shuts off gas supply if flame extinguished • Propane tank can be hidden inside the table Comes complete with lid for burner and natural gas conversion kit • All marine grade stainless steel pan burner with topaz glass media
COVER AND GLASS WINDSCREEN INCLUDED WITH TABLE

COMPLETE SET PRICE \$1547



RECTANGLE
HAMP1-GY-SET

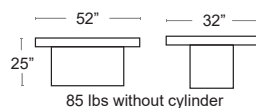

SQUARE
HAMP2-GY-SET

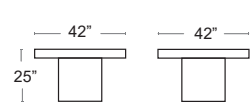

Commercial Patio Heater  

Heavy duty stainless steel body • Weather resistant • Holds 20 or 30lb propane tanks
 10+ Hours of burn time on High • Wheel kit included • Hose and regulator included
 Easy on/off tank access • High output and fuel efficient burner • 45,000 BTHY

SPECIAL SELL PRICE: \$519 EA.



2620-SS

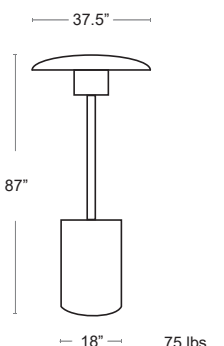

Aura ComfortPlus Infrared Heater

Provides up to 64 square feet of radiant warmth •
 Its advanced heating technology is designed to warm people and objects without heating the air in between • 90% efficiency in converting energy into directional, virtually wind-proof heat.
 Weatherproof, stainless steel construction • can be left outside year-round
 Operate safely in all weather conditions • On/Off switch and an integrated safety tip-over switch.

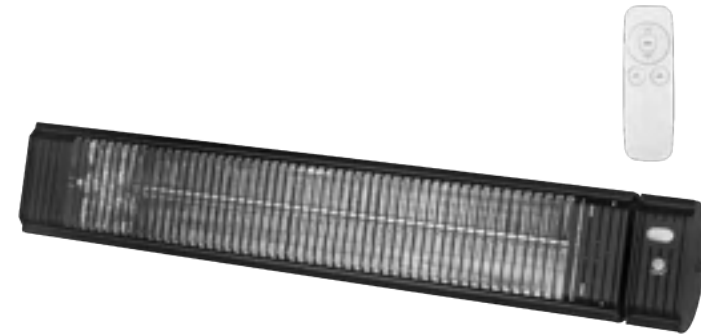

AURA 3000W BLACK -
 208/240V - WALL MOUNT
 CF30240B
 SPECIAL SELL PRICE: **\$590 EA.**



AURA 1500W BLACK -
 120V - WALL MOUNT
 CF15120B
 SPECIAL SELL PRICE: **\$460 EA.**

AURA 1500W SS - 120V
 - WITH STAND AU-
 RAPP15120SS-R
 SELL PRICE: **\$598 EA.**





Top Hub - BM

Top hub replacement for Bay Master • Specify umbrella size
NET: **\$50 EA.**

TU-K100506



Bottom Hub - BM

Bottom hub replacement for Bay Master • Specify umbrella size
NET: **\$70 EA.**

TU-K101001



Center Pole Crank - OMX 3/8"

Center pole crank replacement for Ocean Master MAX 2 3/8"
• Specify umbrella size
NET: **\$2300 EA.**

TU-K102005-crank

Center Pole Crank - OMX 7/8"

Center pole crank replacement for Ocean Master MAX 2 7/8"
• Specify umbrella size
NET: **\$2300 EA.**

TU-K102006-crank

Venice Finial - OM

Top finial for Ocean Master • Brushed aluminum
NET: **\$15 EA.**

TU-10299



Rib Replacement - OM

Rib Replacement for Ocean Master • Specify umbrella size
NET: **\$100 EA.**

TU-K100002



Top Hub - MAX

Top Hub replacement for all MAX umbrellas • Specify umbrella size
NET: **\$150 EA.**

TU-K100502

Middle Hub - MAX

Middle Hub replacement for all MAX umbrellas • Specify umbrella size
NET: **\$155 EA.**

TU-K100504

Center Pole - OM

Center pole replacement for Ocean Master • Specify umbrella size
NET: **\$190 EA.**
TU-K102003

Bottom Hub - OM

Bottom hub replacement for Ocean Master • Specify umbrella size
NET: **\$95 EA.**

TU-K101002

Bottom Hub - BMX & OMX

Bottom Hub replacement for all Bay Master MAX umbrellas
• Specify umbrella size
NET: **\$175 EA.**

BMX
TU-K101003

OMX
TU-K101006



Crank Handle - MAX

Crank Handle replacement for all MAX umbrellas • Specify umbrella size
NET: **\$120 EA.**

TU-K110410



Top Hub - OM

Top hub replacement for Ocean Master • Specify umbrella size
NET: **\$70 EA.**

TU-K101506

Finial - MAX

finial replacement for all MAX umbrellas • Specify umbrella size
NET: **\$35 EA.**



VENICETU-10256



SAIL TU-10396



ACORNTU-PARTJ

Rib Replacement - OMX

Rib replacement for Ocean Master MAX • Specify umbrella size
NET: **\$200 EA.**

TU-K100005



Cam Locking Handle - MAX Cantilever

Cam locking handle replacement for all MAX Cantilever umbrellas • Specify umbrella size
NET: **\$140 EA.**

TU-110420

Rib Replacement - FF

Rib Replacement for Fiber Flex • Specify umbrella size
NET: **\$95 EA.**

TU-K100003

Rib Replacement - BMX

Rib replacement for Bay Master MAX • Specify umbrella size
NET: **\$230 EA.**

TU-K100010



Bottom Hub Plate - Cantilever

Bottom hub plate replacement for MAX Cantilever umbrellas • Specify umbrella size
NET: **\$20 EA.**

TU-13425



Rib Replacement - BMX Cantilever

Rib replacement for all Bay Master MAX Cantilever umbrellas • Specify umbrella size
NET: **\$90 EA.**

TU-K100001



Center Pole - BMX

Center pole replacement for Bay Master MAX • Specify umbrella size • Includes top and middle hub
NET: **\$1750 EA.**

TU-K102018

Center Pole Pulley - OMX

Center pole pulley replacement for Ocean Master MAX 2 3/8" • Specify umbrella size
NET: **\$1750 EA.**

TU-K102005-pulley

Rib Replacement - OMX Cantilever

Rib replacement for all Ocean Master MAX Cantilever umbrellas • Specify umbrella size
NET: **\$200 EA.**

TU-K100005

Mast Replacement - BMX Cantilever

Mast replacement for all Bay Master MAX Cantilever umbrellas • Specify umbrella size
NET: **\$1730 EA.**

TU-K102012

Mast Replacement - OMX Cantilever - Auto Lift

Mast replacement for all Ocean Master MAX Cantilever Auto Lift umbrellas • Specify umbrella size

NET: **\$1730 EA.**

TU-K102009-AUTO-LIFT

Mast Replacement - OMX Cantilever - Crank

Mast replacement for all Ocean Master MAX Cantilever Crank umbrellas • Specify umbrella size

NET: **\$2550 EA.**

TU-K102009-CRANK

Mast Replacement - OMX Dual Cantilever - Auto Lift

Mast replacement for all Ocean Master MAX Dual Cantilever

Auto Lift umbrellas • Specify umbrella size

NET: **\$2015 EA.**

TU-K102010-AUTO-LIFT

Mast Replacement - OMX Dual Cantilever - Crank

Mast replacement for all Ocean Master MAX Dual Cantilever crank umbrellas • Specify umbrella size

NET: **\$2900 EA.**

TU-K102010-CRANK

Lower Finial - Cantilever

Lower Finial replacement for all MAX Cantilever umbrellas Specify umbrella size

NET: **\$20 EA.**

TU-13424



Top Hub - MAX Cantilever

Top hub replacement for all MAX Cantilever umbrellas • Specify umbrella size

NET: **\$140 EA.**

TU-K100503

Scissor Assembly - MAX Cantilever

Scissor assembly replacement for all MAX Cantilever umbrellas • Specify umbrella size

NET: **\$610 EA.**

TU-K103001

Bottom Hub - MAX Cantilever

Bottom hub replacement for all MAX Cantilever umbrellas • Specify umbrella size

NET: **\$175 EA.**

TU-K101004

High Wind Connector - OMX Cantilever

High wind Connector replacement for all OMX Cantilever umbrellas • Specify umbrella size

NET: **\$50 EA.**

TU-K110530

High Wind Stabilizer - OMX Cantilever

High wind stabilizer replacement for all OMX Cantilever umbrellas • Specify umbrella size

NET: **\$320 EA.**

TU-K103100

Car Assembly - MAX Cantilever

Car assembly replacement for all MAX Cantilever umbrellas Specify umbrella size

NET: **\$145 EA.**

TU-K110330



Extendable Table Panel Replacements

Specify model name and code • Specify extension or end panel

Rio 210 Aluminum

MSRP: \$440 EA. SELL PRICE: **\$280 EA.**

Rio 210 Resin / Libeccio 220 / Maestrale 220

MSRP: \$200 EA. SELL PRICE: **\$130 EA.**

Rio 140 Aluminum

MSRP: \$400 EA. SELL PRICE: **\$300 EA.**

Rio 140 Resin

MSRP: \$190 EA. SELL PRICE: **\$120 EA.**



Single Leg Replacement

Leg replacement for all extendable tables • Specify model name and code : **\$60 EA.**

NAR-LEG

Chair/Stool Feet

Foot pads for all Nardi chairs and stools • Specify model name and code

NET: **\$5/set of 4**

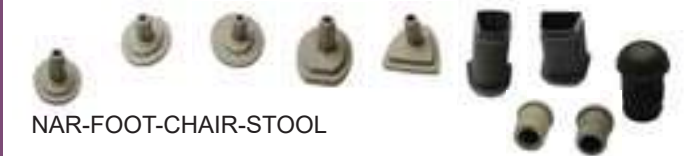

NAR-FOOT-CHAIR-STOOL

Base Feet

Adjustable foot pads for all Nardi bases • Specify model name and code **\$10/set of 4.**



NAR-ADJUST-FOOT-BASE



Base Feet

Base feet replacement for all EMU bases • Specify model name and code • Adjustable feet depending on base type

NET: **\$10/set of 4**



EMU-ADJUST-FOOT-BASE

Table Feet

Table feet replacement • Specify model name and code • 3 pads and 1 adjustable leveler • Sold as a set

NET: **\$15/set**



EMU-TABLE-FOOT-SET

Chair/Stool Feet

Chair/Stool feet replacement • Specify model name and code

NET: **\$10/set of 4**



EMU-FOOT-CHAIR-STOOL

Touch Up Paint

Metal finish touch up paint • .04 oz bottle • Specify model colour

NET: **\$18 EA.**



EMU-TOUCH-UP-PAINT

SWATCHES

RAL Colours emuamericas



RAL 1000 49/15200	RAL 1019 49/13660 • 38/15019	RAL 2008 49/24340	RAL 3014 49/31080	RAL 4008 49/32280	RAL 5014 49/42320
RAL 1001 49/15190 • 38/15001	RAL 1020 49/22500 • 38/20020	RAL 2009 49/24360	RAL 3015 49/33670	RAL 4009 49/34740	RAL 5015 49/42330
RAL 1002 49/22590 • 38/20002	RAL 1021 49/22280	RAL 2010 49/24520	RAL 3016 49/31980	RAL 4010 49/40490	RAL 5017 49/40760 • 38/40017
RAL 1003 49/22580	RAL 1023 49/22490 • 38/20023	RAL 2011 49/24580	RAL 3017 49/31060	RAL 5000 49/42200	RAL 5018 49/41140 • 38/40020
RAL 1004 49/22570	RAL 1024 49/22480 • 38/20024	RAL 2012 49/24690	RAL 3018 49/31050	RAL 5001 49/42210	RAL 5019 49/42360 • 38/40019
RAL 1005 49/22560	RAL 1027 49/22470	RAL 3000 49/33120	RAL 3020 49/31040	RAL 5002 49/42220	RAL 5020 49/44270 • 38/40018
RAL 1006 49/22550	RAL 1028 49/22460	RAL 3001 49/31120	RAL 3022 49/33700	RAL 5003 49/42230	RAL 5021 49/41190 • 38/40021
RAL 1007 49/22540	RAL 1032 49/22450	RAL 3002 49/31110	RAL 3027 49/33660	RAL 5004 49/42240 • 38/40004	RAL 5022 49/42390
RAL 1011 49/15180	RAL 1033 49/22240	RAL 3003 49/31100	RAL 3031 49/34730	RAL 5005 49/43190	RAL 5023 49/44650
RAL 1012 49/22530	RAL 1034 49/23910	RAL 3004 49/33900	RAL 4001 49/43160	RAL 5007 49/42250 • 38/40007	RAL 5024 49/44660
RAL 1013 49/11280 • 38/10013	RAL 1037 49/20096	RAL 3005 49/31900	RAL 4002 49/31030	RAL 5008 49/42260 • 38/40008	RAL 6000 49/53160 • 38/50000
RAL 1014 49/15170 • 38/15014	RAL 2000 49/24570	RAL 3007 49/31910	RAL 4003 49/32270	RAL 5009 49/42270	RAL 6001 49/52900 • 38/50005
RAL 1015 49/15320 • 38/15015	RAL 2001 49/24560	RAL 3009 49/31920	RAL 4004 49/31020	RAL 5010 49/42280	RAL 6002 49/52890
RAL 1016 49/22520 • 38/20016	RAL 2002 49/24550	RAL 3011 49/31090	RAL 4005 49/42780	RAL 5011 49/43180 • 38/40011	RAL 6003 49/52880 • 38/50003
RAL 1017 49/22510	RAL 2003 49/24540	RAL 3012 49/31940 • 38/30012	RAL 4006 49/32090	RAL 5012 49/43170	RAL 6004 49/50980 • 38/50004
RAL 1018 49/21830	RAL 2004 49/24530	RAL 3013 49/31950	RAL 4007 49/32540	RAL 5013 49/42310 • 38/40013	RAL 6005 49/50670 • 38/50002

Swatches

SWATCHES

RAL 6006 49/52870 • 38/50006	RAL 6022 49/52690 • 38/50022	RAL 7006 49/72580 • 38/70006	RAL 7030 49/72890 • 38/70027	RAL 7045 49/77890 • 38/70045	RAL 8019 49/65490 • 38/60019
RAL 6007 49/52860 • 38/50007	RAL 6024 49/52680	RAL 7008 49/72570	RAL 7031 49/72520 • 38/70031	RAL 7046 49/72010 • 38/70002	RAL 8022 49/63080 • 38/60022
RAL 6008 49/53240 • 38/50008	RAL 6025 49/52670	RAL 7009 49/72770 • 38/70009	RAL 7032 49/72910 • 38/70001	RAL 7047 49/72020 • 38/70047	RAL 8023 49/66070 • 38/60023
RAL 6009 49/52840 • 38/50009	RAL 6026 49/52660 • 38/50026	RAL 7010 49/72560 • 38/70014	RAL 7033 49/72510 • 38/70033	RAL 8000 49/66170	RAL 8024 49/66060 • 38/60024
RAL 6010 49/52830 • 38/50031	RAL 6027 49/50990 • 38/50027	RAL 7011 49/72790 • 38/70011	RAL 7034 49/72500	RAL 8001 49/66160 • 38/60005	RAL 8025 49/66050 • 38/60025
RAL 6011 49/52820 • 38/50011	RAL 6028 49/52650 • 38/50028	RAL 7012 49/71180 • 38/70012	RAL 7035 49/73510 • 38/70035	RAL 8002 49/66150 • 38/60002	RAL 8028 49/66500 • 38/60028
RAL 6012 49/51540 • 38/50012	RAL 6029 49/52640 • 38/50029	RAL 7013 49/72550 • 38/70013	RAL 7036 49/72950 • 38/70036	RAL 8003 49/66140 • 38/60003	RAL 9001 49/10016 • 38/10001
RAL 6013 49/52810 • 38/50013	RAL 6032 49/52630 • 38/50032	RAL 7015 49/72820 • 38/70015	RAL 7037 49/72480 • 38/70037	RAL 8004 49/66130 • 38/60004	RAL 9002 49/70520 • 38/10002
RAL 6014 49/52800	RAL 6033 49/55010 • 38/50033	RAL 7016 49/72830 • 38/70016	RAL 7038 49/72470 • 38/70038	RAL 8007 49/66120 • 38/60007	RAL 9003 49/11400 • 38/10003
RAL 6015 49/52790	RAL 6034 49/55020 • 38/50034	RAL 7021 49/72540 • 38/70021	RAL 7039 49/71020 • 38/70039	RAL 8008 49/66110 • 38/60008	RAL 9004 49/81950 • 38/80004
RAL 6016 49/51020 • 38/50016	RAL 7000 49/72700 • 38/70000	RAL 7022 49/72850 • 38/70022	RAL 7040 49/75470 • 38/70046	RAL 8011 49/66100 • 38/60011	RAL 9005 49/82830 • 38/80010
RAL 6017 49/52780 • 38/50017	RAL 7001 49/72710	RAL 7023 49/72530 • 38/70023	RAL 7042 49/73250 • 38/70042	RAL 8012 49/66090 • 38/60012	RAL 9010 49/11500 • 38/10004
RAL 6018 49/52720 • 38/50018	RAL 7002 49/72720 • 38/70007	RAL 7024 49/72870 • 38/70024	RAL 7043 49/72460 • 38/70043	RAL 8014 49/65230 • 38/60010	RAL 9011 49/80540
RAL 6019 49/51000 • 38/50019	RAL 7003 49/72600	RAL 7026 49/72880 • 38/70026	RAL 7044 49/75480 • 38/70044	RAL 8015 49/63040	RAL 9016 49/11340 • 38/10010
RAL 6020 49/52710 • 38/50020	RAL 7004 49/73300 • 38/70004			RAL 8016 49/66080 • 38/60016	RAL 9017 49/80550 • 38/80017
RAL 6021 49/52700 • 38/50021	RAL 7005 49/72590 • 38/70005			RAL 8017 49/65220 • 38/60017	RAL 9018 49/72490 • 38/10018



SWATCHES

Resin Finishes **NARDI** YOUR OUTDOOR LIVING



Sling Fabric

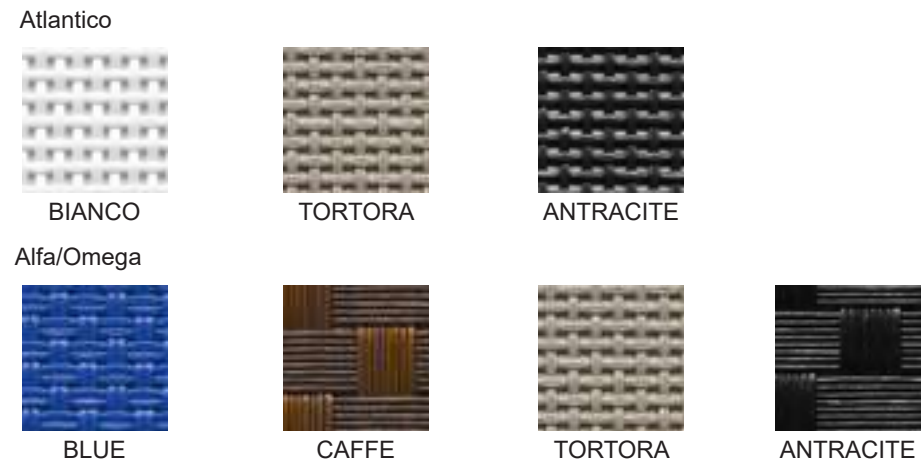

Seat Cushions & Toss Pillows



Folio Cushions

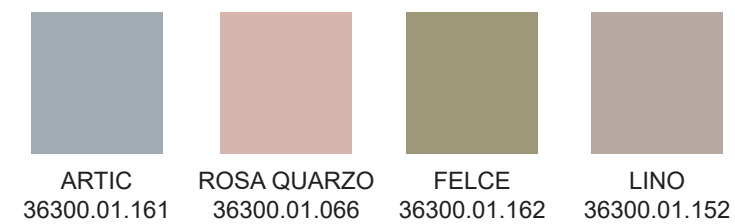

Table Bases



SWATCHES

Table Top Finish



NATURAL TEAK

werzalit Table Top Finishes *Werzalit Of America, Inc.*



SEVERIN Table Top Finishes



SWATCHES

emu  **Metal Finishes**
MADE IN ITALY

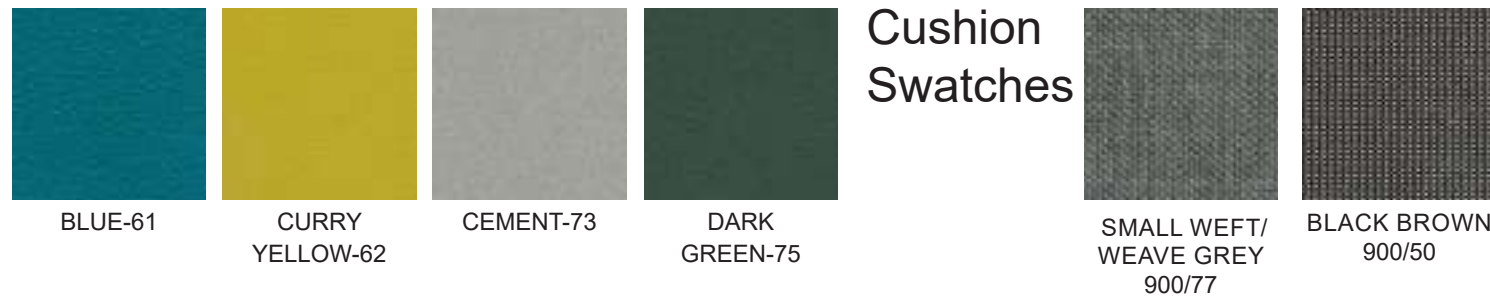

VOYDOM Resin Finishes

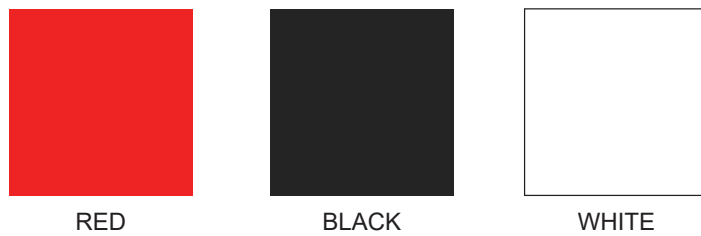

SERRALUNGA Resin Finishes

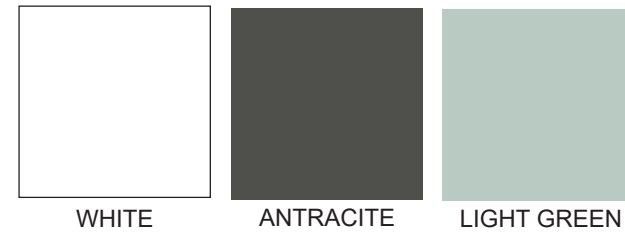

Modern Adirondack

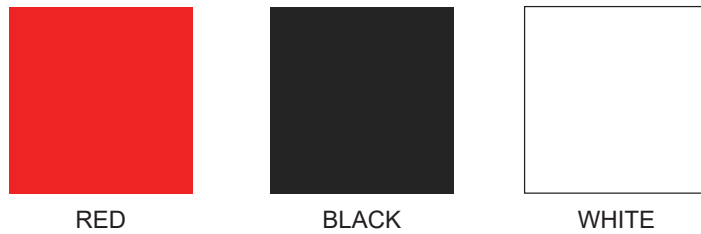

Lounge Cushions

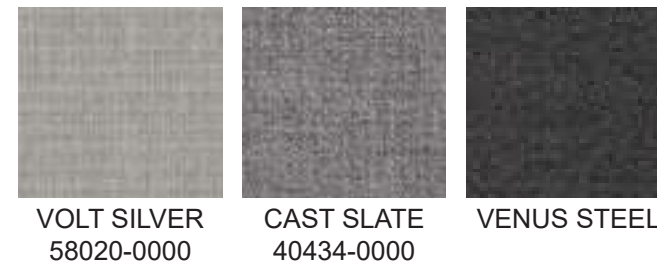

NAPOLEON



PYROMANIA
FIRE FEATURES

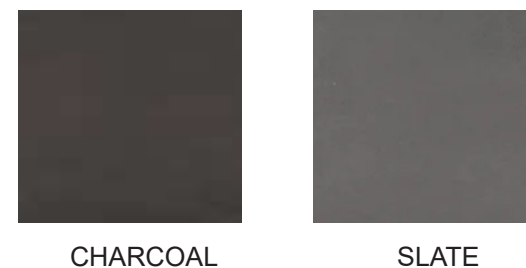

WARRANTY & CARE

This warranty is applicable for 3 years for; all chairs, bar stools, table bases, metal tables, lounge furniture (excluding cushions), umbrellas and bases, planters, benches and litter bins.

The warranty is applicable for 2 years for all table tops.

Manufacturer defect is a defect in which a product has departed from its intended design and has not performed in such a way guaranteed by the manufacturer. The warranty does not cover normal wear and tear over time, nor improper use.

The warranty applies to the original purchaser at the date of purchase. BigBaba.com will, at its discretion, replace or repair said defective product.

What the manufacturer warranty does not cover:

- Damage caused in shipping. If damage is caused in shipping, that damage **MUST** be noted on proof of delivery and reported to BigBaba.com immediately
- Normal wear and tear
- Discoloration due to prolonged exposure to ultra-violet rays. Body care products such as sunscreen, and body lotion can cause discoloration

Care and Maintenance:

- Clean products with a soft bristle brush and mild detergent such as DAWN
- Tighten all loose hardware and replace anything that is missing
 - Replace all worn out foot caps regularly with new ones
 - Touch up scrapes and exposed metal with touch up paint
 - Teak tops need to be cleaned with mild detergents. Specific outdoor oil may be applied to ensure longevity

To file a claim:

Email sales@bigbaba.com with:

- Original bill of sale (invoice or sales order)
- Pictures illustrating the issue and reasons for the claim
- Proof of care and maintenance performed

Nardi Cleaning Products

Specially formulated products for maintenance and cleaning of your Nardi furniture.

CLEAN AND DISINFECT
Suitable for Nardi polypropylene and aluminum outdoor furniture.

MSRP: \$14 EA. **SELL PRICE: \$7 EA.**



Nardi Detergent Magic Cleaner
(Nar-39102.00.010)

- Spray the detergent directly on the Nardi polypropylene (PP) and aluminum (AL) outdoor furniture to be treated. Let it work for some minutes, then remove with a wet sponge or a microfiber cloth.
- Rinse thoroughly with plenty of water.
 - Finally dry with a soft cloth.

REUSABLE CLEANING SPONGE
Removes marks and stubborn dirt from polypropylene (PP) and aluminum (AL) outdoor furniture

MSRP: \$8 EA. **SELL PRICE: \$4 EA.**



Nardi Magic Sponge
(Nar-39102.00.020)

- Gently rub the slightly damp Nardi Magic Sponge** on the area where there are micro-scratches.

NARDI'S COMMITMENT TO ENVIRONMENTAL SUSTAINABILITY

Working to make processes increasingly sustainable is a core part of the Nardi philosophy and investment.

RAW MATERIALS

All products are the result of a production chain that is entirely Made in Italy and eco-friendly. All products, made of 100% recyclable polypropylene have a long life cycle and because it is pure and free from other materials it can be reprocessed and reused again and again.

OEKO-TEX STANDARD 100

All synthetic fabrics used by Nardi are certified according to Oeko-Tex standard 100 confirming the manufacturer is certified eco-friendly and no harmful substances are in the manufacturing process.

ZERO WASTE

Swarf, the fine shavings from machining, and larger scraps from processing polypropylene are fed back into the production cycle. Large silos are used for storing virgin polypropylene and allow zero waste during transition between processes.

THE REGENERATION INDUSTRIAL PROGRAM

Nardi launched this in 2019 to make products from recycled plastic which in turn can be recycled. These include Sipario the outdoor partition system which received the prestigious international Green Good Design Award in 2021.

Regeneration is more than recycled plastic products. Nardi continues to experiment with solutions that can be applied on a large scale to the entire production cycle, from concept creation to production and packaging.

LIFE CYCLE ASSESSMENT

Nardi is committed to making products with high added value that are sustainable for the environment and are doing Life Cycle Assessments on several products.

CARDBOARD PACKAGING AND LDPE

All cardboard for packaging contains about 75% recycled fibres and corn starch is used for adhesive. LDPE caps/bags are made of post-industrial materials

GREEN DOT ECO CERTIFICATE

Nardi is a member of Der Grüne Punkt an internationally protected trademark and the first system for recycling packaging in line with the circular economy. Nardi is certified annually receiving the Green Dot Certificate which provides scientific proof of savings in terms of CO2 emissions, greenhouse effect and fossil resources based on the volume of packaging handled and recycled.

REACH

The Nardi S.p.A. supply chain complies with Regulation (EC) No.1907/2006 (REACH)

MATERIALS

Our furniture is made of various materials (resin, aluminum, laminate and glass), which have different features and problems.

Before cleaning the product, you need to check the material of the part to be treated by consulting the instruction sheet provided at the time of purchase.

We accept no liability for incorrect maintenance procedures.

Most of our products are made of resin (also known as polypropylene - PP). It is a lightweight, long-lasting, non-toxic and anti-static, weatherproof material. It is also treated with anti-UV agents and is uniformly colored with non-toxic pigments.

RESIN

The resin is 100% recyclable and easy to sanitize.

For effective cleaning:

- Wash the product with water to remove any surface dirt and dust.
- Spray the surface with Magic Cleaner Nardi* or a non-aggressive universal detergent.
- Leave the detergent to work for a few minutes, then wipe with a damp cloth or sponge.
- To remove stubborn dirt and surface marks, we recommend using the Magic Sponge Nardi** melamine resin sponge.
- Use a toothbrush to remove dirt from small spaces.
- Rinse with plenty of water and dry with a dry cloth.

When cleaning, do not use aggressive detergents and/or abrasive materials that may scratch the surface.

ALUMINUM

Aluminum is a very hard-wearing material, used for large table frames and contract table bases. It is versatile, easily sanitized and can be 100% recycled countless times while maintaining its structural properties.

- Remove any dust from the surface with a cloth.
- Spray with Magic Cleaner Nardi* (or alternatively with neutral soap dissolved in water) and spread it over the surface.
- Leave it to work for a few minutes.
- Rinse and dry the product with a sponge or dry cloth

LAMINATE

Laminate is a compact, uniform, non-porous and easily sanitized multilayer material that is usually used for contract tabletops.

- Remove any dust with a damp cloth and warm water or with a mild detergent (non-abrasive and not highly alkaline) to avoid scratching the surface.
- To remove more stubborn stains, use nonabrasive household detergents.
- To remove dry or crusty stains, we recommend using the Magic Sponge Nardi** or a soft cloth.

- Rinse thoroughly with clean lukewarm water to remove the detergent.

WARNING

- Do not use abrasive sponges.
- Do not use highly acidic, highly alkaline or corrosive detergents.
- If solvents are used, the cloth used must be thoroughly clean in order to avoid leaving any marks on the surface. Any marks can be removed by rinsing with warm water and drying quickly.
- Avoid using furniture polish and wax-based detergents.

In the Nardi catalogue, fabrics are divided into 3 categories:

- Synthetic fabric (sun-loungers)
- Fabric (cushions)

All our fabrics are washable, but different washing instructions must be followed depending on the type of fabric.

Fabric is made of polyester fibre, with a PVC coating.

Used for sun-loungers.

For effective cleaning:

- Wash the product with water to remove any surface dirt and dust.
- Spray the surface with a non-aggressive universal cleaner.
- Leave the product to work for a few minutes, then wipe it with a damp cloth or sponge.
- Use a toothbrush to remove dirt from small spaces.
- Rinse with plenty of water and dry it with a dry cloth.



Hand wash in cold water



Not to be bleached



The fabric can be machine washed at a maximum temperature of 30 °C



The fabric can be dried in a tumble dryer. The dot indicates the maximum temperature at which the garment can be dried: one dot means low temperatures



The fabric can be machine washed at a maximum temperature of 40 °C



The fabric cannot be dried in a tumble dryer



The fabric cannot be dry cleaned



Dry vertically outdoors without wringing or spinning



The fabric can be dry cleaned with Perchloroethylene, a commonly used solvent



The fabric can be ironed. The dots indicate the temperature: one dot means that you must not exceed 110 °C, and do not use steam



The fabric cannot be dry cleaned and Perchloroethylene solvent cannot be used



The fabric cannot be ironed



The fabric can be bleached with any type of bleach