

jura®



GIGA X7 Professional Instructions for Use



For your safety: read and understand manual before use.

Your GIGA X7 Professional

IMPORTANT SAFEGUARDS	4
Control elements	8
1 Preparing and using for the first time	10
JURA on the Internet.....	10
Settings by the JURA service technician.....	10
Setting up the machine.....	10
Filling the water tank.....	10
Filling the bean container.....	11
First-time use.....	11
Determining the water hardness.....	15
Connecting milk.....	16
2 Preparation	17
Coffee, latte macchiato etc. – options for preparation.....	17
Preparation at the touch of a button.....	18
Preparation using the product selector.....	19
Ground coffee.....	20
Barista recipes at a glance.....	21
Preparing barista recipes.....	21
Permanently setting amounts for the cup size.....	22
Activating the grinder selection.....	23
Hot water.....	24
3 Daily operation	25
Switching on.....	25
Daily maintenance.....	25
Switching off.....	26
4 Permanent settings in programming mode	27
Possible settings in programming mode.....	27
Product settings.....	28
Setting the consistency of grind.....	30
Maintenance settings.....	31
Setting the water hardness.....	32
Energy-saving mode.....	33
Time and date.....	33
Timer.....	34
Automatic switch-off.....	35
Units.....	36
Restore factory settings.....	36
Language.....	37
Display settings.....	38
Background.....	38
Deactivating barista recipes.....	39
Querying information.....	39

5	Maintenance	41
	Rinsing the coffee system	42
	Rinsing the milk system.....	42
	Cleaning the milk system	42
	Dismantling and rinsing the dual spout.....	44
	Inserting and activating the filter.....	46
	Changing the filter	47
	Cleaning the machine	48
	Descaling the machine	49
	Cleaning the bean container.....	52
	Descaling the water tank	52
6	Display messages	53
7	Troubleshooting	55
8	Transport and environmentally friendly disposal	57
	Transport / Emptying the system.....	57
	Disposal.....	57
9	Technical data	58
10	Index	59
11	JURA contact details / Legal information	64

Symbol description

Warnings



This is the safety alert symbol. It is used to alert you to potential personal injury hazards. Obey all safety messages that follow this symbol to avoid possible injury or death.



DANGER indicates a hazardous situation which, if not avoided, will result in death or serious injury.



WARNING indicates a hazardous situation which, if not avoided, could result in death or serious injury.



CAUTION, used with the safety alert symbol, indicates a hazardous situation which, if not avoided, could result in minor or moderate injury.



NOTICE is used to address practices not related to personal injury.

Symbols used



Prompt to take action. This symbol means that you are being prompted to perform some action.



Information and tips to make it even easier to use your GIGA.



Display message

IMPORTANT SAFEGUARDS

Follow the basic safety precautions

When using electrical appliances, basic safety precautions shall always be followed, to reduce the risk of fire, electric shock, and/or injury to persons, including the following:

- Read all instructions.
- Do not touch hot surfaces. Use handles or knobs.
- To protect against fire, electric shock and injury to persons, do not immerse power cord, plugs, or body of machine in water or other liquid.
- Close supervision is necessary when any appliance is used by or near children.
- Unplug from outlet when not in use and before cleaning. Allow to cool before putting on or taking off parts, and before cleaning the appliance.
- Do not operate any appliance with a damaged cord or plug or after the appliance malfunctions, or has been damaged in any manner. Return appliance to the nearest authorized service facility for examination, repair or adjustment.
- The use of an accessory attachment not recommended by the appliance manufacturer may result in fire, electric shock, or injury to persons.
- Do not use outdoors.
- Do not let the cord hang over the edge of a table or counter, or touch hot surfaces.
- Do not place on or near a hot gas or electric burner, or in a heated oven.
- Always attach plug to appliance first, then plug cord into the wall outlet. To disconnect, turn any control to 'OFF' then remove plug from wall outlet.
- Do not use appliance for other than intended use.
- Use extreme caution when dispensing hot steam, hot water or hot coffee.

SAVE THESE INSTRUCTIONS.

Pass them on to any subsequent user.

Intended use This machine is intended for use by specialist or trained staff in businesses, light industry and agricultural facilities or for commercial use by non-professionals. It shall only be used for coffee preparation and to heat milk and water, according to these instructions. Use for any other purpose will be deemed improper. JURA Elektroapparate AG cannot accept any responsibility for the consequences of improper use.

People, including children, who

- do not have the physical, sensory or mental capabilities to use the appliance safely or
- are inexperienced or lack knowledge in how to use the appliance safely

must be supervised by a responsible person when using it, or must be instructed in how to use it correctly.

Special power cord set instructions

- The power cord is provided to reduce the risk resulting from becoming entangled in or tripping over a long cord.
- The cord shall be arranged so that it will not drape over the counter top or table top where it can be pulled on by children or tripped over.
- This appliance has a 3-pin grounded plug.
- Do not modify the plug in any way.

Do NOT use extension cords.

If the user chooses to use an extension cord,

- the marked electrical rating of the extension cord shall be at least as great as the electrical rating of the appliance, and
- if the appliance is of the grounded type, the extension cord shall be a grounding type 3-wire cord, and
- the longer cord shall be arranged so that it will not drape over the counter top or tabletop where it can be pulled on by children or tripped over.

 WARNING



To reduce the risk of fire or electric shock, DO NOT remove any service covers. DO NOT modify the appliance in any way that is not described in these instructions. NO user serviceable parts included. Repair MUST be done by authorized personnel only.

In the event of signs of damage, for example if there is a smell of burning, unplug the machine immediately from outlet and contact JURA customer service.

IMPORTANT SAFEGUARDS

⚠ CAUTION

This appliance is for household use. Any servicing other than cleaning and user maintenance shall be performed by an authorized service representative:

- Do not immerse base in water or try to disassemble.
- Do not put the appliance or any individual parts in the dishwasher.
- Check voltage to be sure that the voltage indicated on the name plate complies with your voltage.
- Never use warm or hot water to fill the water container. Use cold water only.
- Keep your hands and the cord away from hot parts of the appliance during operation.

There is a risk of scalds or burns on the spouts and the cappuccino frother / nozzle.

- Keep children away.
- Do not touch any hot parts. Use the handles or knobs provided.
- Ensure that the cappuccino frother / nozzle is correctly fitted and clean. If incorrectly fitted or if they become blocked, the cappuccino frother or its parts might come off.

NOTICE



**NEVER DO
(or you will void your
warranty protection):**

- Never clean with scouring powders or hard implements.
- Ensure that the ventilation slats are not covered.
- Never pull out the drip tray during the brewing process. Only pull the drip tray when the display instructs you or when the appliance is ready for use.
- Never fill instant coffee, chocolate mix etc. into the bean container or ground coffee funnel (filler funnel for ground coffee). It will damage the functioning of the brewing chamber.
- Never fill sugar coated coffee beans into the bean container. In case of doubt, call your dealer.
- Never fill anything other than coffee beans into the bean container (no chocolate, no rice, no nuts, no spices, nothing other than roasted coffee beans).

IMPORTANT SAFEGUARDS

- Never fill frozen beans into the bean container. If you store beans in the freezer, let them thaw 3 to 4 hours before filling them into the bean container.
- Never fill anything but fresh, cold and clean water into the water tank, except when decalcifying.
- Never use mineral or carbonated water. You can use tap water, bottled water, spring water and reverse osmosis water.
- Never do anything with the machine which is not described in these instructions. In case of doubt, call your dealer.

Control elements

Control elements

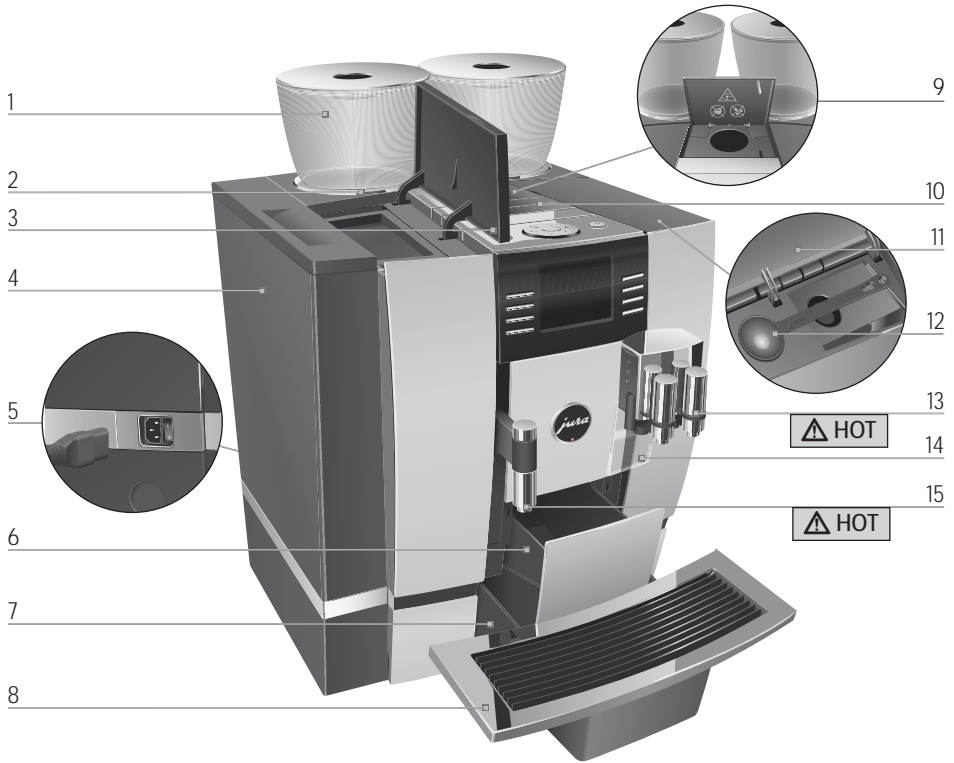



- 1 Bean container with aroma preservation cover
- 2 Bean container status indicator
- 3 Water tank cover
- 4 Water tank
- 5 Power switch and plug-in power cord (back of the machine)
- 6 Coffee grounds container
- 7 Drip tray
- 8 Cup platform

- 9 Filler funnel for ground coffee
- 10 Ventilation slats (Venti Ports)
- 11 Storage compartment cover
- 12 Measuring spoon for ground coffee
- 13 Height- and width-adjustable dual spout
- 14 Splash guard
- 15 Height-adjustable hot-water spout



Top of the machine

- 1  On/Off button
- 2  Rotary Switch
- 3  P button (programming)

Front

- 4 Display
- 5 Multi-function buttons (button function depends on what is shown in the display)

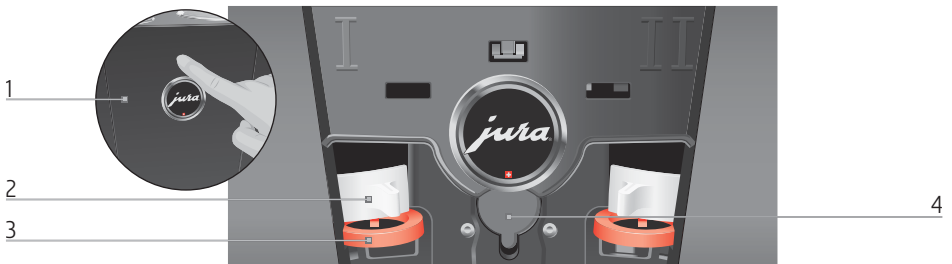

Back of the machine

- 1 Service cover (open by pressing with your finger)
- 2 Locking device
- 3 Sliding catch
- 4 Service socket (underneath cover)

1 Preparing and using for the first time

JURA on the Internet

Visit us on the Internet.

On the JURA website (www.jura.com) you will find interesting and up-to-date information on your GIGA and on every aspect of coffee.

Settings by the JURA service technician

The following settings can only be made by the JURA service technician:

- Customised layout of the products on the start screen (display) or in the product selector
- Disabling the product selector view (see Chapter 2 ‘Preparation – Preparation using the product selector’)
- Setting the filter capacity
- Codes: Four codes can be assigned. For each code, you can define which program items are available or disabled. Each code corresponds to different authorisations. For instance, you can define that initiation of the maintenance programs is disabled using a code.

You can also obtain the following optional accessories for your GIGA from your JURA service partner:

- Set for direct draining of the residual water
- Set for automatic discharging of coffee grounds

Setting up the machine

When setting up your GIGA, please note the following:

- Place the GIGA on a horizontal surface that is not sensitive to water.
- Choose a spot for your GIGA which protects the machine against overheating. Ensure that the ventilation slats are not covered.

Filling the water tank

Daily maintenance of the machine and hygiene when handling milk, coffee and water are key to a perfect coffee result in the cup every time. You should therefore change the water **daily**.

NOTICE

Milk, sparkling mineral water or other liquids can damage the water tank or the machine.

- ▶ Only fill the water tank with fresh, cold water.
-



- ▶ Open the water tank cover.
- ▶ Remove the water tank and rinse it with cold water.
- ▶ Fill the water tank with fresh, cold water and reinsert the tank.
- ▶ Close the water tank cover.

Filling the bean container

The bean containers have an aroma preservation cover. This will ensure that your coffee beans retain their aroma for longer.

NOTICE

Coffee beans which have been treated with additives (e.g. sugar), ground coffee or freeze-dried coffee will damage the grinder.

- ▶ Only use roasted, untreated coffee beans to fill the bean container.
-
- ▶ Remove the aroma preservation cover.
 - ▶ Remove any dirt or foreign objects from inside the bean container.
 - ▶ Fill the bean container with coffee beans and close the aroma preservation cover.

First-time use

WARNING

If the machine is operated with a defective power cord, there is a danger of potentially fatal electric shock.

- ▶ Never use a machine which is damaged.
- ▶ Never use a machine which has a defective power cord.

i The water volume is given as standard in 'oz'. You can change this setting to 'ml' in programming mode (see Chapter 4 'Permanent settings in programming mode – Unit for amount of water').

During first-time use, you can choose between the 'Quick installation' and the 'Standard installation'.

- 'Quick installation': After setting the time and date, your GIGA is ready for use.
- 'Standard installation': Here, you can also decide whether you want to operate your GIGA **with** or **without** a CLEARYL Pro

1 Preparing and using for the first time

Blue filter cartridge. If the water hardness is 10 °dH or more, we recommend using the filter cartridge. If you do not know the hardness of your water, you can find this out first (see Chapter 1 'Preparing and using for the first time – Determining the water hardness').

- **'Use filter' / 'Active':** Here, you can fit the CLEARYL Pro Blue filter cartridge. Descaling will no longer be necessary.
- **'Use filter' / 'Inactive':** Here, you can set the water hardness of the water used. This setting influences when your GIGA prompts you to perform descaling.

⚠ WARNING

If the machine is operated with a defective power cord, there is a danger of potentially fatal electric shock.

- ▶ Never use a machine which is damaged or has a defective power cord.



Precondition: The water tank and bean containers have been filled.

- ▶ Connect the power cord to the machine.
- ▶ Insert the power plug into a power socket.
- ▶ Switch on the GIGA using the power switch on the back of the machine.
- ▶ Press the On/Off button to switch the GIGA on.
'Welcome to JURA' appears on the display. The display then shows the languages you can choose from.

i To display more languages, press the **'Next'** button (bottom right).

- ▶ Press the button that corresponds to the language you want, e.g. **'English'**.
'Saved' appears briefly on the display to confirm the setting.
'First-time use'

i Now choose between **'Quick installation'** and **'Standard installation'**.

Quick installation

- ▶ Press the **'Quick installation'** button.
'Time'
- ▶ Press the **'+' or '-'** button to set the hours.
- ▶ Press the **'Save'** button.

- ▶ Press the '+' or '-' button to set the minutes.
- ▶ Press the 'Save' button.
'Saved' appears briefly on the display.
'Date'
- ▶ Press the '+' or '-' button to set the day.
- ▶ Press the 'Save' button.
- ▶ Press the '+' or '-' button to set the month.
- ▶ Press the 'Save' button.
- ▶ Press the '+' or '-' button to set the year.
- ▶ Press the 'Save' button.

'Saved' appears briefly on the display.
'Press the Rotary Switch.', the Rotary Switch lights up.

- ▶ Place a receptacle under the dual spout.



- ▶ Press the Rotary Switch.

'System is filling.', the system fills up with water. The operation stops automatically. 'Welcome to JURA', 'Machine is heating.', 'Press the Rotary Switch.' appears on the display.



- ▶ Press the Rotary Switch.

'Machine is rinsing.', the machine rinses. The operation stops automatically. 'Please select product.' appears on the display. Your GIGA is ready for use.



Standard installation

- ▶ Press the 'Standard installation' button.
'Time'
- ▶ Press the '+' or '-' button to set the hours.
- ▶ Press the 'Save' button.
- ▶ Press the '+' or '-' button to set the minutes.
- ▶ Press the 'Save' button.

'Saved' appears briefly on the display.
'Date'

- ▶ Press the '+' or '-' button to set the day.
- ▶ Press the 'Save' button.
- ▶ Press the '+' or '-' button to set the month.
- ▶ Press the 'Save' button.
- ▶ Press the '+' or '-' button to set the year.
- ▶ Press the 'Save' button.

'Saved' appears briefly on the display.
'Use filter'

1 Preparing and using for the first time

Activating the filter



i Now decide whether you want to operate your GIGA **with** or **without** a CLEARYL Pro Blue filter cartridge.

- ▶ Press the **'Active'** button.
- ▶ Press the **'Save'** button.
- ▶ **'Press the Rotary Switch.'**, the Rotary Switch lights up.



- ▶ Press the Rotary Switch.
- ▶ **'System is filling.'**, the system fills up with water. The operation stops automatically.

'Insert filter./ 'Press the Rotary Switch.'

- ▶ Remove and empty the water tank.
- ▶ Open the filter holder and insert the filter cartridge into the water tank, exerting slight pressure.
- ▶ Close the filter holder. It will click into place audibly.
- ▶ Fill the water tank with fresh, cold water and reinsert the tank.



- ▶ Press the Rotary Switch.
- ▶ **'Filter is being rinsed.'**, the filter is rinsed. Rinsing of the filter stops automatically. **'Empty drip tray.'** appears on the display.

- ▶ Empty the drip tray and coffee grounds container and put them back into the machine.

'Filter' / 'Filter rinsing complete.'

'Welcome to JURA', 'Machine is heating.', 'Press the Rotary Switch.'



- ▶ Press the Rotary Switch.
- ▶ **'Machine is rinsing.'**, the machine rinses. The operation stops automatically. **'Please select product:'** appears on the display. Your GIGA is ready for use.

Deactivating the filter

- ▶ Press the **'Inactive'** button.
- ▶ Press the **'Save'** button.
- ▶ **'Press the Rotary Switch.'**, the Rotary Switch lights up.



- ▶ Press the Rotary Switch.
- ▶ **'System is filling.'**, the system fills up with water. The operation stops automatically.

'Water hardness'

i If you do not know the hardness of your water, you must find this out first (see Chapter 1 ‘Preparing and using for the first time – Determining the water hardness’).

- ▶ Press the ‘+’ or ‘-’ button to adjust the water hardness.
- ▶ Press the ‘Save’ button.
 ‘Saved’ appears briefly on the display.
 ‘Welcome to JURA’, ‘Machine is heating.’, ‘Press the Rotary Switch.’
- ▶ Place a receptacle under the dual spout.
- ▶ Press the Rotary Switch.
 ‘Machine is rinsing.’, the machine rinses. The operation stops automatically. ‘Please select product.’ appears on the display. Your GIGA is ready for use.



Determining the water hardness

You can find out what the water hardness is by using the Aquadur® test strip supplied as standard.

- ▶ Hold the test strip briefly (for 1 second) under flowing water. Shake off the water.
- ▶ Wait for about 1 minute.
- ▶ You will then be able to read the degree of water hardness from the discoloration of the Aquadur® test strip and the description on the packaging.

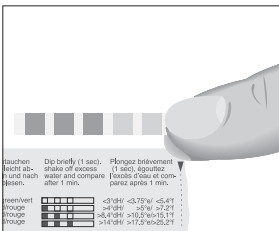

Level	Display German Degree (°dGH)	Degrees of general hardness (°dGH)	Parts per million (ppm)	Indicator Strip number of ‘reddish’ fields
Not active	–	–	–	–
Very soft water	<3	<3	< 53.4	None
Soft water	> 4	> 4	> 71	1
Hard water	> 8.4	> 8.4	> 150	2
Very hard water	> 14	> 14	> 250	3

Connecting milk

Your GIGA creates fine, creamy, feather-light milk foam with a perfect consistency. The most important requirement for frothing milk is a milk temperature of 39–46 °F (4–8 °C). We would therefore recommend using a milk cooler (e.g. the JURA Compressor Cooler Pro, which is available as an option).

- ▶ Connect the milk pipe to the dual spout. To do this, attach the end of the milk pipe to the connector on the right-hand side of the dual spout.
- ▶ Connect the other end of the milk pipe to a milk cooler.

2 Preparation

WARNING

Hot coffee, hot steam and hot water can cause scalding. Scalding is a serious burn.

- ▶ Use extreme care when handling hot liquid or steam.
- ▶ Allow liquid to cool down before drinking.
- ▶ In the event of scalding, rinse affected area with cold water and seek medical attention.
- ▶ Keep children AWAY.

i While a product is being prepared, you can stop preparation at any time. To do this, press the Rotary Switch  or the 'L' button.

i During preparation, you can change the preset **amounts** (e.g. amount of milk foam or water) by turning the Rotary Switch .

i You can follow the current status of preparation on the display.

i The water volume is given as standard in 'oz'. You can change this setting to 'ml' in programming mode (see Chapter 4 'Permanent settings in programming mode – Unit for amount of water').

Coffee tastes best served hot. A cold porcelain cup cools the beverage – and impairs the taste. We therefore recommend pre-warming the cups. The full coffee aroma can develop only in pre-warmed cups. You can purchase a JURA cup warmer from your specialized dealer.

You can make **permanent settings** for all products in programming mode (see Chapter 4 'Permanent settings in programming mode – Product settings').

Coffee, latte macchiato etc. – options for preparation

The GIGA provides you with two options for preparing a specialty coffee, milk or hot water.

- **Preparation at the touch of a button:** Simply press the corresponding preparation button for the product shown on the display (start screen) that you want.

■ **Preparation using the product selector (Rotary Selection):**

Only some of the products you can prepare are shown on the start screen. As soon as you turn the Rotary Switch, more products are displayed in a **product selector**.

■ Turn the Rotary Switch to bring the product you want into focus. Start preparation by pressing the Rotary Switch or the 'Prepare' button.

■ The product selector view disappears automatically after 5 seconds if no preparation is started.

The two preparation options will now be described in more detail in the following sections.

Preparation at the touch of a button

On the display (start screen), you will see eight different products, which you can prepare by simply pressing the corresponding button.

Specialty coffees at the touch of a button

A specialty coffee displayed on the start screen is always prepared in the same way.



Example: Proceed as follows to prepare one coffee.

Precondition: 'Please select product:' is displayed.

▶ Place a cup under the dual spout.

▶ Press the 'Coffee' button.

Preparation starts. 'Coffee' and the fill volume are displayed.

The preset amount of water for coffee flows into the cup.

Preparation stops automatically. 'Please select product:' appears on the display.

Two specialty coffees at the touch of a button

Two specialty coffees can always be prepared in the same way: Press the preparation button you want **twice within two seconds**.

Specialty coffees with milk at the touch of a button

Your GIGA prepares latte macchiato, cappuccino and other specialty coffees with milk at the touch of a button. There is no need to move the glass or cup.

Example: Proceed as follows to prepare one latte macchiato.

Precondition: 'Please select product:' is displayed, milk is connected to the dual spout.

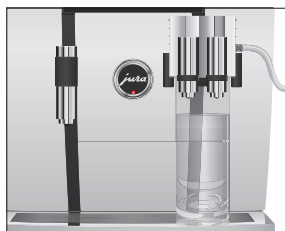

- ▶ Place a glass under the dual spout.
- ▶ Press the 'Latte macchiato' button.
 'Latte macchiato' and the various amounts are displayed.
 'Latte macchiato', the preset amounts of milk and milk foam flow into the glass.
 Coffee preparation starts. The preset amount of water for espresso flows into the glass. Preparation stops automatically. 'Please select product:' appears on the display.

To ensure that the milk system in the dual spout always works properly, you must clean it **daily** (see Chapter 5 'Maintenance – Cleaning the milk system').

Preparation using the product selector

As soon as you turn the Rotary Switch, more products are displayed in a **product selector**.

- i** The product selector view disappears automatically after 5 seconds if no preparation is started.

Preparation of a specialty coffee using the product selector

Example: Proceed as follows to prepare a milky coffee using the product selector.

Precondition: 'Please select product:' is displayed, milk is connected to the dual spout.

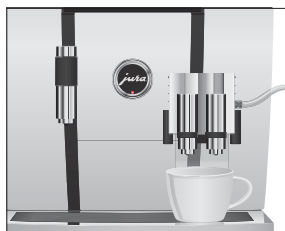

- ▶ Place a cup under the dual spout.
- ▶ Turn the Rotary Switch to view the product selector.
- ▶ Turn the Rotary Switch until the 'Caffè latte' product is in focus.
- ▶ Press the Rotary Switch to start preparation.
 The milky coffee is prepared.
 Preparation stops automatically. 'Please select product:' appears on the display.

2 Preparation

Ground coffee

You can choose to use a second coffee variety, for example decaffeinated coffee, with the filter funnel for ground coffee.

- i** Never add more than two level measuring spoons of ground coffee.
- i** Use ground coffee which is not ground too finely. Very fine coffee can block up the system so that the coffee only comes out in drips.
- i** If you did not fill the machine with a sufficient amount of ground coffee, 'Not enough ground coffee.' is displayed and the GIGA stops the operation.
- i** The desired specialty coffee must be prepared within approximately one minute after filling with the ground coffee. Otherwise the GIGA stops the operation and is once more ready for use.

All specialty coffees with ground coffee are prepared following this model.

Example: Proceed as follows to prepare one coffee using ground coffee.

Precondition: 'Please select product:' is displayed.

- ▶ Place a cup under the dual spout.
- ▶ Open the cover of the filler funnel for ground coffee.
'Please add ground coffee.'
- ▶ Place one level measuring spoon of ground coffee into the filler funnel.
- ▶ Close the cover of the filler funnel.
'Please select product:', the specialty coffees you can prepare with ground coffee are displayed.
- ▶ Press the 'Coffee' button.
Preparation starts. 'Coffee' and the fill volume are displayed. The preset amount of water for coffee flows into the cup. Preparation stops automatically. 'Please select product:' appears on the display.



Barista recipes at a glance

Now you too can be a professional barista! You can select the recipes for 12 delicious coffee creations from the product selector using the Rotary Switch. The GIGA will guide you through each step of the preparation process with easy-to-follow text and pictures. Choose from:

- Marocchino
- Pepresso
- White Cool
- Flavoured latte macchiato
- Irish coffee*
- Café mélange
- Viennese coffee
- Winter Magic
- Shakerato
- Mango Lassi
- Red Cool*
- Summer Fire

Designed to please the eye as well as the taste buds!
(Recipes marked * contain alcohol.)



Preparing barista recipes

All barista recipes are prepared following this model.

- i** The product selector view disappears automatically after 5 seconds if no preparation is started.

Example: Proceed as follows to prepare a White Cool.

Precondition: 'Please select product:' is displayed.

-  ▶ Turn the Rotary Switch to view the product selector.
-  ▶ Turn the Rotary Switch until the product 'White Cool' is in focus.
-  ▶ Press the Rotary Switch to start preparation.
 - ▶ Follow the instructions on the display and confirm by pressing the 'Next' button.

- i** You can stop preparation at any time by pressing the 'L' button.

- i** Just before preparation starts, you are asked which grinder and therefore which beans you want to use.

- i** You cannot make any permanent settings for barista recipes. During preparation, you can however change the coffee strength and quantities by turning the Rotary Switch .

Permanently setting amounts for the cup size

It is easy to make permanent settings for the amounts (amount of water, amount of milk etc.) according to the cup size for all products except caffè latte. Adjust the amount once as shown in the following example. Every time you prepare a drink in the future, this amount of water will be dispensed.

The permanent settings for adapting the amounts to the cup size for all products (apart from caffè latte) follow this model.

Example: Proceed as follows to **permanently** set the amount of water for one coffee.

Precondition: 'Please select product:' is displayed.



- ▶ Place a cup under the dual spout.
- ▶ Press and **hold** the 'Coffee' button.
'Coffee' and the fill volume are displayed.
- ▶ **Hold** the 'Coffee' button down until 'Enough coffee? Press button.' appears.
- ▶ Release the 'Coffee' button.
Preparation starts and the coffee flows into the cup.
- ▶ Press any button as soon as there is sufficient coffee in the cup.
Preparation stops. 'Saved' appears briefly on the display. The set amount of water for one coffee is permanently stored. 'Please select product:' appears on the display.

- i** You can alter this setting at any time by repeating the above procedure.
- i** The amount can be permanently adjusted to the cup size for the products shown in the product selector too. To do this, press and hold the Rotary Switch  until 'Enough coffee? Press button.' appears.
- i** You can also permanently set the amount for all specialty coffees, milk and hot water in programming mode (see Chapter 4 'Permanent settings in programming mode – Product settings').

Activating the grinder selection

You have the option of configuring the start screen such that the grinder selection ('beans à la carte') is always displayed. Before each preparation, you can select which grinder is to be used and therefore which coffee beans are to be used.

- i** If the grinder selection is activated, you can no longer set the grinder for the individual products in programming mode (in the 'Product settings (2/5)' program item).

Example: Proceed as follows to activate 'beans à la carte' mode.

Precondition: 'Please select product:' is displayed.

- P** ▶ Press the P button.
'Maintenance status (1/5)'
-  ▶ Turn the Rotary Switch until the program item 'Machine settings (4/5)' is displayed.
▶ Press the 'Café à la carte' button.
▶ Press the 'Active' button.
▶ Press the 'Saved' button.
'Saved' appears briefly on the display.
'Machine settings (4/5)'
- P** ▶ Press the P button to exit programming mode.
'Please select product:'

Preparation of a specialty coffee with grinder selection



Example: Proceed as follows to prepare a coffee with coffee beans from the **grinder on the left**.

Precondition: 'Please select product:' is displayed. 'Beans à la carte' mode is activated.

- ▶ Place a cup under the dual spout.
- ▶ Press the '+' button on the left-hand side several times until the value is set to '100%'.
- i** The grinder selection remains active until the setting is changed by you, even if the GIGA is switched off in the meantime.
- ▶ Press the 'Coffee' button.
Preparation starts. 'Coffee' and the fill volume are displayed. The preset amount of water for coffee flows into the cup. Preparation stops automatically. 'Please select product:' appears on the display.

2 Preparation

Hot water

CAUTION

The following temperatures can be selected for preparing hot water: 'Low', 'Normal', 'High'.

There is a danger of scalding from hot water splashes.

- ▶ Avoid direct contact with the skin.
-

Precondition: 'Please select product:' is displayed.

- ▶ Place a cup under the hot-water spout.
- ▶ Press the 'Hot water' button.
'Hot water' and the temperature are displayed.

i By pressing the '+' or '-' button (**within approximately 2 seconds**) you can set the temperature to your individual preference. This setting is not saved.

'Hot water', hot water flows into the cup. Preparation stops automatically when the preset amount of water is reached. 'Please select product:' appears on the display.





3 Daily operation

Switching on



When the GIGA is switched on, it automatically prompts you to perform the rinse operation. Start the rinse operation by pressing the Rotary Switch . In programming mode you can change this setting so that the machine starts the switch-on rinse automatically (see Chapter 4 'Permanent settings in programming mode – Maintenance settings').

Precondition: Your GIGA is switched on at the power switch.

- ▶ Place a receptacle under the dual spout.
-  ▶ Press the On/Off button to switch the GIGA on.
'Welcome to JURA' appears on the display. The machine heats up.
'Press the Rotary Switch.'
-  ▶ Press the Rotary Switch.
'Machine is rinsing.', the machine rinses. The operation stops automatically. 'Please select product:' appears on the display.

Daily maintenance

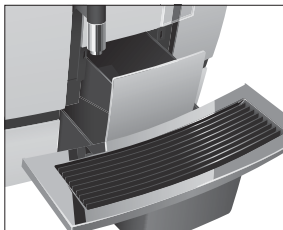

To ensure that you get many years of reliable service out of your GIGA and to guarantee the optimum coffee quality, the machine requires daily maintenance.

- ▶ Pull out the drip tray.
 - ▶ Empty the coffee grounds container and the drip tray. Rinse them both with warm water.
 - ▶ Dry the metal contacts on the back of the drip tray.
 - ▶ Refit the coffee grounds container and the drip tray.
 - ▶ Rinse the water tank with clean water.
 - ▶ Dismantle and rinse the dual spout (see Chapter 5 'Maintenance – Dismantling and rinsing the dual spout').
 - ▶ Wipe the surface of the machine with a clean, soft, damp cloth (e.g. microfiber cloth).
- i** In the interests of hygiene, we recommend changing the milk pipe on a regular basis (approx. every 3 months). Replacement pipes are available from specialized dealers.

3 Daily operation

Switching off



When you switch off your GIGA, the dual spout is rinsed automatically.

Precondition: 'Please select product:' is displayed.

- ▶ Place a receptacle under the dual spout.
- ▶ Press the On/Off button.



'Machine is rinsing.', 'Milk system is being rinsed.' (if you have prepared a specialty coffee with milk). The system rinses itself. The operation stops automatically. Your GIGA is switched off.



When the GIGA is switched off with the On/Off button, the machine consumes less than 0.1 W of standby energy. The machine can be completely disconnected from the power grid using the power switch.

4 Permanent settings in programming mode

WARNING

Hot coffee, hot steam and hot water can cause scalding. Scalding is a serious burn.

- ▶ Use extreme care when handling hot liquid or steam.
- ▶ Allow liquid to cool down before drinking.
- ▶ In the event of scalding, rinse affected area with cold water and seek medical attention.
- ▶ Keep children AWAY.

Possible settings in programming mode

Press the P button to enter programming mode. You can navigate through the program items and permanently save the required settings simply by turning the Rotary Switch and using the multi-function buttons. The following settings can be made:

Program item	Sub-item	Explanation
'Maintenance status (1/5)	'Clean', 'Change the filter', 'Descal' (only if filter is not activated), 'Rinse the milk system', 'Rinse the coffee system', 'Clean the milk system'	▶ Start the required maintenance program here.
'Product settings (2/5)	'Expert mode', 'Set consistency of grind'	▶ Select your settings for specialty coffees, milk and hot water. ▶ Adjust the consistency of grind for both grinders to the coffee beans used.
'Machine settings (3/5)	'Maintenance settings' (filter, water hardness, switch-on rinse, milk system rinsing), 'Time / date', 'Timer', 'Save energy', 'Units', 'Factory setting'	▶ Set the water hardness or activate the filter. ▶ Change the settings for the switch-on rinse and milk system rinse. ▶ Set the time after which the GIGA should switch off automatically. ▶ Select an energy-saving mode. ▶ Select the unit for the amount of water. ▶ Reset the machine or the permanently set values of all products to the factory settings.

4 Permanent settings in programming mode

Program item	Sub-item	Explanation
'Machine settings (4/5)'	'Choose language', 'Display', 'Colour scheme', 'Café à la carte', 'Barista recipes'	▶ Select your language. ▶ Change the display settings. ▶ Activate the grinder selection.
'Information (5/5)'	'Product counter', 'Day counter', 'Maintenance counter', 'Version'	▶ Keep track of all products prepared and view the number of maintenance programs performed.

Product settings

In the program item 'Product settings (2/5)' you can make individual settings for all specialty coffees, milk and hot water.



WARNING

Hot coffee, hot steam and hot water can cause scalding. Scalding is a serious burn.

- ▶ Use extreme care when handling hot liquid or steam.
- ▶ Allow liquid to cool down before drinking.
- ▶ In the event of scalding, rinse affected area with cold water and seek medical attention.
- ▶ Keep children AWAY.

Expert mode The following settings can be made in the 'Expert mode':

Product	Coffee strength	Amount	More settings
Ristretto, espresso, coffee	● (extra-mild), ●● (mild), ●●● (normal), ●●●● (strong), ●●●●● (extra-strong)	Water: 0.5 oz – 8.0 oz (25 ml – 240 ml)	Temperature (low, normal, high), grinder on the left and/or right (as %)
Two ristretti, two espressi, two coffees	–	Water: 0.5 oz – 8.0 oz (25 ml – 240 ml) (per cup)	Temperature (low, normal, high), grinder on the left and/or right (as %)
Cappuccino, caffè latte, espresso macchiato, latte macchiato	● (extra-mild), ●● (mild), ●●● (normal), ●●●● (strong), ●●●●● (extra-strong)	Water: 0.5 oz – 8.0 oz (25 ml – 240 ml) Milk: 0 sec. – 120 sec. Milk foam: 0 sec. – 120 sec.	Temperature (low, normal, high), grinder on the left and/or right (as %)

Product	Coffee strength	Amount	More settings
Two cappuccini, two caffè lattes, two espressi macchiati, two latte macchiati	–	Water: 0.5 oz – 8.0 oz (25 ml – 240 ml) Milk: 0 sec. – 120 sec. Milk foam: 0 sec. – 120 sec. (per cup)	Temperature (low, normal, high), grinder on the left and/or right (as %)
Portion of milk foam, portion of milk	–	Milk: 0 sec. – 120 sec. Milk foam: 0 sec. – 120 sec.	–
Two portions of milk foam, two portions of milk	–	Milk: 0 sec. – 120 sec. Milk foam: 0 sec. – 120 sec. (per cup)	–
Pot	☉ (extra-mild), ☉☉ (mild), ☉☉☉ (normal), ☉☉☉☉ (strong), ☉☉☉☉☉ (extra-strong)	Water: 0.5 oz – 8.0 oz (25 ml – 240 ml) (per stroke)	Temperature (low, normal, high), grinder on the left and/or right (as %), number of strokes (1 – 5; set number is displayed during preparation)
Hot water	–	Water: 0.5 oz – 15.0 oz (25 ml – 450 ml)	Temperature (low, normal, high)

i In addition to the settings listed, you can **reset the values for all products to the factory settings.**

Example: Proceed as follows in the ‘Expert mode’ to change the amount of milk for a latte macchiato from ‘4 sec.’ to ‘6 sec.’, the amount of milk foam from ‘12 sec.’ to ‘14 sec.’ and the amount of water from ‘1.5 oz’ (45 ml) to ‘1.0 oz’ (40 ml).

Precondition: ‘Please select product:’ is displayed.

P ▶ Press the P button.

‘Maintenance status (1/5)’

☉ ▶ Turn the Rotary Switch until the program item ‘Product settings (2/5)’ is displayed.

▶ Press the ‘Expert mode’ button.

‘Expert mode’

4 Permanent settings in programming mode

- i** Next select the button of the product for which you would like to make settings. No product is prepared at this point.
- i** You can also select the products in the product selector. To do this, turn the Rotary Switch to view the product selector.
 - ▶ Press the **'Latte macchiato'** button.
 - ▶ Press the **'Amount of milk'** button.
 - ▶ Press the **'+'** or **'–'** button to change setting for the amount of milk to **'6 sec.'**
 - ▶ Press the **'Save'** button.
 - ▶ Press the **'Amount of milk foam'** button.
 - ▶ Press the **'+'** or **'–'** button to change setting for the amount of milk foam to **'14 sec.'**
 - ▶ Press the **'Save'** button.
 - ▶ Press the **'Volume'** button.
 - ▶ Press the **'+'** or **'–'** button to change setting for the fill volume to **'1.0 oz'** (40 ml).
 - ▶ Press the **'Save'** button.
- P** ▶ Press the P button to exit programming mode.
'Please select product:'

Setting the consistency of grind

In the program item **'Product settings (2/5) | 'Set consistency of grind'** you can adjust both grinders separately to the degree of roast of your coffee.

The consistency of grind setting is correct if the coffee flows regularly from the dual spout. In addition a fine, thick crema forms.

Example: Proceed as follows to change the consistency of grind for the grinder on the **right**.

Precondition: **'Please select product:'** is displayed.

- P** ▶ Press the P button.
'Maintenance status (1/5)'
-  ▶ Turn the Rotary Switch until the program item **'Product settings (2/5)'** is displayed.
 - ▶ Press the **'Set consistency of grind'** button.
'Set consistency of grind'
 - ▶ Press the **'Right grinder'** button.
'Right grinder'
 - ▶ Press the **'+'** or **'–'** button to change the setting for the consistency of grind.

- ▶ Press the 'Save' button.
'Saved' appears briefly on the display.
'Set consistency of grind'
- P ▶ Press the P button to exit programming mode.
'Please select product:'

Maintenance settings

In the program item 'Machine settings (3/5)' / 'Maintenance settings' you can make the following settings:

- 'Filter'
 - Activate the CLEARYL Pro Blue filter cartridge (see Chapter 5 'Maintenance – Inserting and activating the filter').
- 'Water hardness'
 - If you do not have a filter cartridge, you will need to set the water hardness (see Chapter 4 'Permanent settings in programming mode – Setting the water hardness').
- 'Switch-on rinse' / 'Manual'
 - The switch-on rinse must be started manually.
- 'Switch-on rinse' / 'Automatic'
 - The switch-on rinse is started automatically.
- 'Rinse the milk system' / 'Manual after 10 min.'
 - You are prompted to rinse the milk system 10 minutes after preparation of a specialty coffee with milk.
- 'Rinse the milk system' / 'Manual immediate'
 - You are prompted to rinse the milk system immediately after preparation of a specialty coffee with milk.
- 'Rinse the milk system' / 'Automatic after 10 min.'
 - Milk system rinsing is automatically initiated 10 minutes after preparation of a specialty coffee with milk.
- 'Rinse the milk system' / 'Automatic immediate'
 - Milk system rinsing is automatically initiated approx. 30 seconds after preparation of a specialty coffee with milk.

Example: Proceed as follows to make the machine prompt you to rinse the milk system **immediately** after preparing a specialty coffee with milk.

Precondition: 'Please select product:' is displayed.

- P ▶ Press the P button.
'Maintenance status (1/5)'

4 Permanent settings in programming mode

- ◉ ▶ Turn the Rotary Switch until the program item 'Machine settings (3/5)' is displayed.
- ▶ Press the 'Maintenance settings' button.
'Maintenance settings'
- ▶ Press the 'Rinse the milk system' button.
'Rinse the milk system'
- ▶ Press the 'Manual immediate' button.
- ▶ Press the 'Save' button.
'Saved' appears briefly on the display.
'Maintenance settings'
- P ▶ Press the P button to exit programming mode.
'Please select product:'

Setting the water hardness

The harder the water is, the more frequently the GIGA needs to be descaled. It is therefore important to adjust the water hardness.

The water hardness can be adjusted on a continuous scale between 1 °dH and 30 °dH.

Precondition: 'Please select product:' is displayed.

- P ▶ Press the P button.
'Maintenance status (1/5)'
- ◉ ▶ Turn the Rotary Switch until the program item 'Machine settings (3/5)' is displayed.
- ▶ Press the 'Maintenance settings' button.
'Maintenance settings'
- ▶ Press the 'Water hardness' button.
'Water hardness'
- ▶ Press the '+' or '-' button to set the water hardness.
- ▶ Press the 'Save' button.
'Saved' appears briefly on the display.
'Maintenance settings'
- P ▶ Press the P button to exit programming mode.
'Please select product:'

Energy-saving mode

In the program item **'Machine settings (3/5) / 'Save energy'** you can permanently set an energy-saving mode (Energy Save Mode, E.S.M.®):

- **'Save No'**
 - All specialty coffees, specialty coffees with milk and hot water can be prepared without having to wait.
- **'Save Level 1'**
 - Your GIGA is only constantly ready for use for specialty coffees and hot water.
 - Before you can prepare a specialty coffee with milk, the machine must heat up.
- **'Save Level 2'**
 - Soon after the last preparation, the GIGA stops heating up. After about 5 minutes the message **'Energy Save'** is displayed.
 - Before you can prepare a specialty coffee, specialty coffee with milk, or hot water, the machine must heat up.

Example: Proceed as follows to change the energy-saving mode from **'Save Level 1'** to **'Save Level 2'**.

Precondition: **'Please select product:'** is displayed.

- P ▶ Press the P button.
'Maintenance status (1/5)'
- ⊙ ▶ Turn the Rotary Switch until the program item **'Machine settings (3/5)'** is displayed.
 - ▶ Press the **'Save energy'** button.
'Save energy'
 - ▶ Press the **'Save Level 2'** button.
 - ▶ Press the **'Save'** button.
'Saved' appears briefly on the display.
'Machine settings (3/5)'
- P ▶ Press the P button to exit programming mode.
'Please select product:'

Time and date

You already set the time and date during first-time use. You can change this setting.

- i** For the time format, you can choose between **'24 hrs'** and **'AM / PM'** (see Chapter 4 **'Permanent settings in programming mode – Units'**).

Example: Proceed as follows to change the time.

Precondition: 'Please select product:' is displayed.

- P ▶ Press the P button.
'Maintenance status (1/5)'
- ⊖ ▶ Turn the Rotary Switch until the program item 'Machine settings (3/5)' is displayed.
 - ▶ Press the 'Time / date' button.
'Time / date'
 - ▶ Press the 'Time' button.
'Time'
 - ▶ Press the '+' or '-' button to set the hours.
 - ▶ Press the 'Save' button.
 - ▶ Press the '+' or '-' button to set the minutes.
 - ▶ Press the 'Save' button.
'Saved' appears briefly on the display.
'Time / date'
- P ▶ Press the P button to exit programming mode.
'Please select product:'

Timer

In the program item 'Machine settings (3/5)' / 'Timer' you can set an individual switch-on and switch-off time for every day of the week.

- i** Automatic switch-on only works when the machine is switched on at the power switch.
- i** For the time format, you can choose between '24 hrs' and 'AM / PM' (see Chapter 4 'Permanent settings in programming mode – Units').

Example: Proceed as follows to set your GIGA to switch on and off at a time defined by you **every day of the week**.

Precondition: 'Please select product:' is displayed.

- P ▶ Press the P button.
'Maintenance status (1/5)'
- ⊖ ▶ Turn the Rotary Switch until the program item 'Machine settings (3/5)' is displayed.
 - ▶ Press the 'Timer' button.
'Timer'
 - ▶ Press the 'Monday' button (example).
'Monday'

- ▶ Press the '+' or '-' button to set the hours (for 'Switch machine on').
 - ▶ Press the '←' button.
 - ▶ Press the '+' or '-' button to set the minutes (for 'Switch machine on').
 - ▶ Press the '←' button.
 - ▶ Press the '+' or '-' button to set the hours (for 'Switch machine off').
 - ▶ Press the '←' button.
 - ▶ Press the '+' or '-' button to set the minutes (for 'Switch machine off').
 - ▶ Press the 'Every weekday' button.
- 'Saved' appears briefly on the display. The switch-on and switch-off times you just set are adopted for every day of the week.
- 'Timer'
- P ▶ Press the P button to exit programming mode.
- 'Please select product:'

Automatic switch-off

By instructing your GIGA to automatically switch itself off, you can cut down your energy consumption. If this function is activated, your GIGA switches off automatically after the preset time following the last action on the machine.

You can set the automatic switch-off time to 15 minutes or 0.5 – 15 hours.

Precondition: 'Please select product:' is displayed.

- P ▶ Press the P button.
- 'Maintenance status (1/5)'
- ⊙ ▶ Turn the Rotary Switch until the program item 'Machine settings (3/5)' is displayed.
- ▶ Press the 'Timer' button.
 - ▶ Press the 'Next' button.
 - ▶ Press the 'Switch off after' button.
- 'Switch off after'
- ▶ Press the '+' or '-' button to change the setting.
 - ▶ Press the 'Save' button.
- 'Saved' appears briefly on the display.
- 'Timer'

4 Permanent settings in programming mode

- P ▶ Press the P button to exit programming mode.
‘Please select product:’

Units

In the program item ‘Machine settings (3/5)’ / ‘Units’ you can make the following settings:

- Unit for amount of water: ‘ml’ or ‘oz’
- Time format: ‘24 hrs.’ or ‘AM / PM’

Example: Proceed as follows to change the unit for the amount of water from ‘ml’ to ‘oz’.

Precondition: ‘Please select product:’ is displayed.

- P ▶ Press the P button.
‘Maintenance status (1/5)’
-  ▶ Turn the Rotary Switch until the program item ‘Machine settings (3/5)’ is displayed.
- ▶ Press the ‘Units’ button.
‘Units’
- ▶ Press the ‘oz’ button.
- ▶ Press the ‘Save’ button.
‘Saved’ appears briefly on the display.
‘Machine settings (3/5)’
- P ▶ Press the P button to exit programming mode.
‘Please select product:’

Restore factory settings

In the program item ‘Machine settings (3/5)’ / ‘Factory setting’ you can reset various settings to their factory settings:

- ‘All products’
 - The settings (amount of water, coffee strength, temperature etc.) for **all products** are reset to the factory settings.
- ‘Machine’
 - **All user settings** (apart from the ‘filter’, ‘water hardness’ and time and date settings) are reset to the factory settings. The GIGA then switches off.
- ‘Empty system’
 - The system is emptied. Your GIGA then switches off.

Example: Proceed as follows to reset the values for **all products** to the factory settings.

Precondition: ‘Please select product:’ is displayed.

- P ▶ Press the P button.
'Maintenance status (1/5)'
- ⊙ ▶ Turn the Rotary Switch until the program item 'Machine settings (3/5)' is displayed.
 - ▶ Press the 'Factory setting' button.
'Factory setting'
 - ▶ Press the 'All products' button.
'All products' / 'Reset all products to the factory settings?'
 - ▶ Press the 'Yes' button.
'Saved' appears briefly on the display.
'Factory setting'
- P ▶ Press the P button to exit programming mode.
'Please select product:'

Language

In this program item you can set the language used by your GIGA.

Example: Proceed as follows to change the language from 'English' to 'Deutsch'.

Precondition: 'Please select product:' is displayed.

- P ▶ Press the P button.
'Maintenance status (1/5)'
- ⊙ ▶ Turn the Rotary Switch until the program item 'Machine settings (4/5)' is displayed.
 - ▶ Press the 'Choose language' button.
'Choose language'
- i** To display more languages, press the 'Next' button (bottom right).
 - ▶ Press the 'Deutsch' button.
'Gespeichert' appears briefly on the display.
'Geräteeinstellungen (4/5)'
- P ▶ Press the P button to exit programming mode.
'Bitte wählen Sie Ihr Produkt:'

Display settings

In the program item **'Machine settings (4/5)'** / **'Display'** you can make the following settings:

- **'Brightness'** (as percentages)
- **'Contrast'** (high, normal, low)
- **'Backlight'** (backlighting; as percentages)

Example: Proceed as follows to change the brightness of the display.

Precondition: **'Please select product:'** is displayed.

- P ▶ Press the P button.
'Maintenance status (1/5)'
- ⊗ ▶ Turn the Rotary Switch until the program item **'Machine settings (4/5)'** is displayed.
 - ▶ Press the **'Display'** button.
 - ▶ Press the **'Brightness'** button.
 - ▶ Press the **'+'** or **'-'** button to change the setting.
 - ▶ Press the **'Save'** button.
'Saved' appears briefly on the display.
- P ▶ Press the P button to exit programming mode.
'Please select product:'

Background

In this program item you can set the background for the display of your GIGA.

- i The set background is only displayed on the start screen.

Precondition: **'Please select product:'** is displayed.

- P ▶ Press the P button.
'Maintenance status (1/5)'
- ⊗ ▶ Turn the Rotary Switch until the program item **'Machine settings (4/5)'** is displayed.
 - ▶ Press the **'Colour scheme'** button.
'Colour scheme'
 - ▶ Press the **'+'** or **'-'** button to change the setting.
 - ▶ Press the **'Save'** button.
'Saved' appears briefly on the display.
- P ▶ Press the P button to exit programming mode.
'Please select product:'

Deactivating barista recipes

In the program item **'Machine settings (4/5)'** you can activate or deactivate the barista recipes. When the barista recipes are deactivated they no longer appear in the product selector.

Example: Proceed as follows to deactivate barista recipes.

Precondition: **'Please select product:'** is displayed.

- P ▶ Press the P button.
'Maintenance status (1/5)'
- ⊖ ▶ Turn the Rotary Switch until **'Machine settings (4/5)'** is displayed.
 - ▶ Press the **'Barista recipes'** button.
'Barista recipes'
 - ▶ Press the **'Inactive'** button.
 - ▶ Press the **'Save'** button.
'Saved' appears briefly on the display.
 - 'Machine settings (4/5)'**
- P ▶ Press the P button to exit programming mode.
'Please select product:'

Querying information

In the program item **'Information (5/5)'** you can view the following information:

- **'Product counter':** Number of prepared coffee specialty coffees, specialty coffees with milk and hot water
- **'Day counter':** Number of prepared coffee specialty coffees, specialty coffees with milk and hot water. This counter can be reset to zero.
- **'Maintenance counter':** Number of maintenance programs performed (cleaning, descaling etc.)
- **'Version':** Software version

Precondition: **'Please select product:'** is displayed.

- P ▶ Press the P button.
'Maintenance status (1/5)'
- ⊖ ▶ Turn the Rotary Switch until the program item **'Information (5/5)'** is displayed.
 - ▶ Press the **'Product counter'** button.
'Product counter' and the number of products prepared is displayed.

4 Permanent settings in programming mode

- i** You can also view the number of products prepared in the product selector. To do this, turn the Rotary Switch.
 - ▶ Press any button or the Rotary Switch to exit the program item.
'Information (5/5)'
- P** ▶ Press the P button to exit programming mode.
'Please select product:'

5 Maintenance

WARNING

Use of maintenance products that are harmful to health and discharge of liquids during maintenance program. Harmful if swallowed. Irritating to eyes and skin.

- ▶ Keep children AWAY.
- ▶ Keep children away from the machine while it is performing a maintenance program.
- ▶ Avoid contact with skin and eyes.
- ▶ Avoid generation of dust. Do not inhale dust.
- ▶ When using do not eat or drink.
- ▶ Keep maintenance products away from food, drink and animal food.
- ▶ Keep container tightly closed and dry. Keep in a cool place.

Your GIGA has the following integrated maintenance programs:

- Rinsing the coffee system ('**Rinse the coffee system**')
- Rinsing the milk system in the dual spout ('**Rinse the milk system**')
- Cleaning the milk system in the dual spout ('**Clean the milk system**')
- Changing the filter ('**Change the filter**')
- Cleaning the machine ('**Clean**')
- Descaling the machine ('**Descale**') (only if filter is not activated)

i Clean or descale the machine, rinse the milk system or change the filter when you are prompted to do so.

i Press the P button to view a list of the maintenance programs ('**Maintenance status (1/5)**'). By referring to the bar you can see how soon each maintenance program is due. When the bar is completely filled with red, your GIGA will prompt you to perform the maintenance program.

i The GIGA will not prompt you to clean the milk system. In the interests of hygiene, you should clean the milk system **daily** when you have been preparing milk.

Rinsing the coffee system

You can perform coffee system rinsing at any time.



Precondition: 'Please select product:' is displayed.

- ▶ Place a receptacle under the dual spout.

P ▶ Press the P button.

'Maintenance status (1/5)'

- ▶ Press the 'Rinse the coffee system' button.

'Machine is rinsing.', water flows out of the dual spout.

The rinse stops automatically. 'Please select product:' appears on the display.

Rinsing the milk system

Depending on the setting in programming mode, the GIGA prompts you to rinse the milk system or automatically performs rinsing following milk preparation.

Example: Proceed as follows to rinse the milk system when prompted to do so.

Precondition: 'Rinse the milk system.' and the ☼ symbol are displayed.



- ▶ Place a receptacle under the dual spout.

P ▶ Press the P button.

'Maintenance status (1/5)'

- ▶ Press the 'Rinse the milk system' button.

'Milk system is being rinsed.', water flows out of the dual spout.

The rinse stops automatically. 'Please select product:' appears on the display.

Cleaning the milk system

To ensure that the milk system in the dual spout always works properly, you must clean it **daily** when you have been preparing milk. The GIGA will **not** prompt you to clean the milk system.

⚠ WARNING

Non-recommended cleaning agents will not optimally remove milk residues. This may cause the cappuccino frother to become blocked and fly off the machine. Discharge of hot steam.

- ▶ Use only original JURA milk system cleaner.

⚠ WARNING

Harmful and irritating cleaning agent. Harmful if swallowed. Irritating to eyes and skin.

- ▶ Keep children AWAY.
- ▶ Avoid contact with skin and eyes.
- ▶ After contact with skin, wash immediately with plenty of water. In case of skin irritation, seek medical advice.
- ▶ After eye contact, immediately flush eyes with plenty of water and seek medical advice.
- ▶ If swallowed, rinse mouth immediately and drink large quantities of water. Do not induce vomiting. Seek medical advice immediately and show label.

i JURA milk system cleaner is available from specialized dealers.

Precondition: 'Please select product:' is displayed.

- P**
- ▶ Press the P button.
 - 'Maintenance status (1/5)'
 - ▶ Press the 'Clean the milk system' button.
 - ▶ Press the 'Start' button.
 - ▶ Press the 'Start' button again.
 - 'Cleaning agent for milk system.'
 - ▶ Pour 8.5 oz (250 ml) of fresh water into a receptacle and add one capful (max. 0.5 oz (15 ml)) of milk system cleaner.
 - ▶ Immerse the milk pipe in the receptacle.
 - ▶ Place another receptacle under the dual spout.
 - ▶ Press the 'Next' button.
 - 'Milk system is being cleaned.', water flows out of the dual spout.
 - 'Water for cleaning milk system.'
 - ▶ Rinse the receptacle thoroughly, fill it with 8.5 oz (250 ml) of fresh water and immerse the milk pipe in the water.
 - ▶ Empty the other receptacle and place it under the dual spout again.
 - ▶ Press the 'Next' button.
 - 'Milk system is being cleaned.', the dual spout and the pipe are rinsed with fresh water.
 - The operation stops automatically. 'Milk system cleaning complete.' appears briefly on the display.
 - 'Please select product:'



Dismantling and rinsing the dual spout

The dual spout must be dismantled and rinsed **daily** if milk has been prepared to make sure it functions perfectly and also in the interests of hygiene.

▶ Remove the milk pipe and rinse it thoroughly under running water.

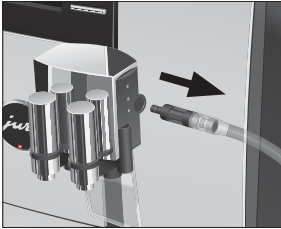

▶ Press the releasing devices and pull the cover of the dual spout up and off.

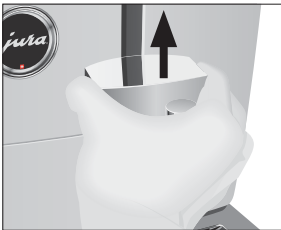

▶ Carefully pull the bottom part of the milk system down and off.

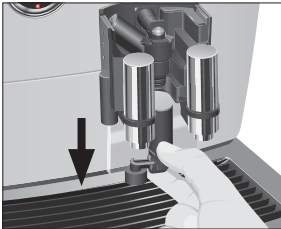

▶ Remove the milk system from the dual spout.

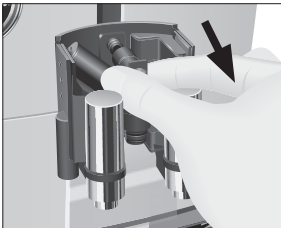

▶ Remove the air intake pipe.

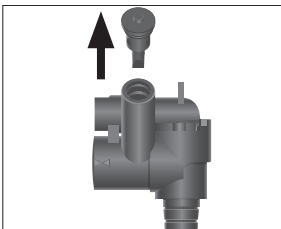

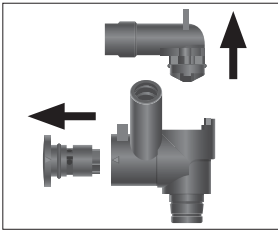

- ▶ Dismantle the milk system into its individual parts.
- ▶ Rinse all the parts under running water. If there are severely dried-on milk residues, firstly immerse the individual parts in JURA milk system cleaner and then rinse them thoroughly.

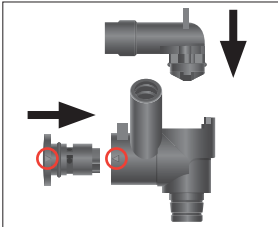

- ▶ Reassemble the milk system. When doing this, note the arrows (circled in red in the picture) on the individual parts.

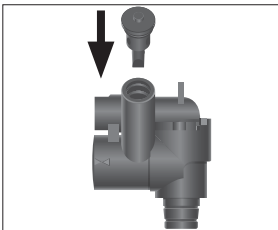

- ▶ Fit the air intake pipe.

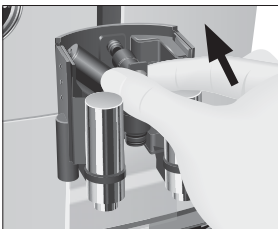

- ▶ Fit the assembled individual parts back in the dual spout and press it firmly.

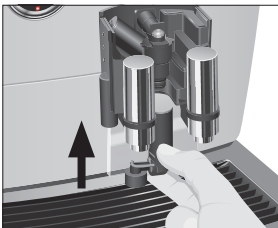

- ▶ Attach the bottom part of the milk system to the part already inserted from below.

5 Maintenance

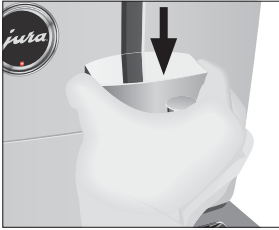

- ▶ Fit the cover of the dual spout. It will click into place audibly.

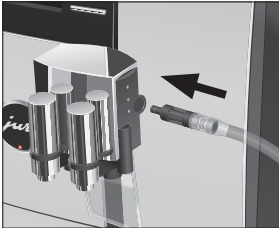

- ▶ Insert the milk pipe into the dual spout.

Inserting and activating the filter

Your GIGA no longer has to be descaled if you are using the CLEARYL Pro Blue filter cartridge. If the water hardness is 10 °dH or more, we recommend using the filter cartridge. If you do not know the hardness of your water, you can find this out first (see Chapter 1 'Preparing and using for the first time – Determining the water hardness').

If you did not activate the filter cartridge the first time you used the machine, you can do this now as follows.

- i** Perform the 'inserting the filter' operation without any interruptions. This will ensure that your GIGA always produces its best.

Precondition: 'Please select product:' is displayed.



- ▶ Press the P button.

'Maintenance status (1/5)'



- ▶ Turn the Rotary Switch until the program item 'Machine settings (3/5)' is displayed.

- ▶ Press the 'Maintenance settings' button.

- ▶ Press the 'Filter' button.

'Filter'

- ▶ Press the 'Active' button.

- ▶ Press the 'Save' button.

'Saved' appears briefly on the display.

'Insert filter.' / 'Press the Rotary Switch.'



- ▶ Remove and empty the water tank.
- ▶ Open the filter holder and insert the filter cartridge into the water tank, exerting slight pressure.
- ▶ Close the filter holder. It will click into place audibly.
- ▶ Fill the water tank with fresh, cold water and reinsert the tank.
- ▶ Press the Rotary Switch.

'Filter is being rinsed.', the filter is rinsed. Rinsing of the filter stops automatically. 'Empty drip tray.' appears on the display.

- ▶ Empty the drip tray and coffee grounds container and put them back into the machine.

'Filter' / 'Filter rinsing complete.'

The machine heats up. 'Please select product:' appears on the display. Your GIGA is once more ready for use.

Changing the filter

- i** After 4060 oz (120 liters) of water have flowed through or after two months, the filter will cease to work. Your GIGA will automatically prompt you to change the filter.
- i** If the CLEARYL Pro Blue filter cartridge is not activated in programming mode, you will not be prompted to change the filter.

Example: Proceed as follows to change the filter when prompted to do so.

Precondition: 'Change the filter' and the ♁ symbol are displayed.

P

- ▶ Press the P button.
- 'Maintenance status (1/5)'
- ▶ Press the 'Change the filter' button.
- ▶ Press the 'Start' button.
- ▶ Press the 'Start' button again.
- 'Change filter.' / 'Press the Rotary Switch.'
- ▶ Remove and empty the water tank.
- ▶ Open the filter holder and remove the old CLEARYL Pro Blue filter cartridge.
- ▶ Insert the new filter cartridge into the water tank, exerting slight pressure.
- ▶ Close the filter holder. It will click into place audibly.
- ▶ Fill the water tank with fresh, cold water and reinsert the tank.
- ▶ Press the Rotary Switch.



- ▶ Empty the drip tray and coffee grounds container and put them back into the machine.

'Change the filter' / 'Filter rinsing complete.'

The machine heats up. 'Please select product:' appears on the display.

Cleaning the machine

After 220 preparations or 80 switch-on rinses, the GIGA will prompt you to clean it.

WARNING

Non-recommended (e.g. liquid) cleaning agents may contain substances that could damage the machine or leave residues.

- ▶ Use only original JURA cleaning tablets. These are specially formulated for your machine.

WARNING

Harmful and irritating cleaning agent. Harmful if swallowed. Irritating to eyes and skin.

- ▶ Keep children AWAY.
- ▶ Avoid contact with skin and eyes.
- ▶ Avoid generation of dust. Do not inhale dust.
- ▶ After contact with skin, wash immediately with plenty of water. In case of skin irritation, seek medical advice.
- ▶ After eye contact, immediately flush eyes with plenty of water and seek medical advice.
- ▶ If swallowed, rinse mouth immediately and drink large quantities of water. Do not induce vomiting. Seek medical advice immediately and show label.

 The cleaning program lasts approximately 20 minutes.

 Do not interrupt the cleaning program. The quality of cleaning will be impaired if you do so.

 JURA cleaning tablets are available from specialized dealers.

Example: Proceed as follows to clean when prompted to do so.

Precondition: 'Clean machine.' and the ☼ symbol are displayed.

P ▶ Press the P button.

'Maintenance status (1/5)'

▶ Press the 'Clean' button.

▶ Press the 'Start' button.

▶ Press the 'Start' button again.

'Empty coffee grounds container.'



- ▶ Empty the drip tray and coffee grounds container and put them back into the machine.

'Press the Rotary Switch.'

- ▶ Place a receptacle under the dual spout.



- ▶ Press the Rotary Switch.

'Machine is being cleaned.', water flows out of the dual spout.

The operation is interrupted, 'Add cleaning tablet.'

- ▶ Open the cover of the filler funnel for ground coffee.

- ▶ Insert a JURA cleaning tablet into the filler funnel.

- ▶ Close the cover of the filler funnel.

'Press the Rotary Switch.'



- ▶ Press the Rotary Switch.

'Machine is being cleaned.', water flows out of the dual spout repeatedly.

The operation is interrupted, 'Empty coffee grounds container.'

- ▶ Empty the drip tray and coffee grounds container and put them back into the machine.

'Clean' / 'Cleaning complete.'

Cleaning is now complete. Your GIGA is once more ready for use.

Descaling the machine



WARNING

The GIGA builds up deposits of limescale over time and automatically prompts you to descale it when necessary. The degree of calcification depends on the hardness of your water.

Non-recommended descaling agents (e.g. vinegar) may contain substances that could damage the machine or leave residues.

- ▶ Use only original JURA descaling tablets. These are specially formulated for your machine.
-

⚠ WARNING

Harmful and irritating descaling agent. Harmful if swallowed. Irritating to eyes and skin.

- ▶ Keep children AWAY.
- ▶ Avoid contact with skin and eyes.
- ▶ Avoid generation of dust. Do not inhale dust.
- ▶ After contact with skin, wash immediately with plenty of water. In case of skin irritation, seek medical advice.
- ▶ After eye contact, immediately flush eyes with plenty of water. Remove contact lenses. Seek medical advice.
- ▶ If swallowed, rinse mouth immediately and drink large quantities of water. Do not induce vomiting. Seek medical advice immediately and show label.

NOTICE

If the descaling operation is interrupted, there may be damage to the machine.

- ▶ Allow the descaling program to run to the end.

-
- i** The descaling program lasts approximately 50 minutes.
 - i** JURA descaling tablets are available from specialized dealers.
 - i** If you use a CLEARYL Pro Blue filter cartridge and this is activated, you will not be prompted to descale.
 - i** If the descaling agent comes into contact with sensitive surfaces (e.g. marble), damage cannot be ruled out. Clean up any splashes immediately.

Example: Proceed as follows to perform descaling when prompted to do so.

Precondition: 'Decalcify machine.' and the ☼ symbol are displayed.

- P**
- ▶ Press the P button.
'Maintenance status (1/5)'
 - ▶ Press the 'Descale' button.
 - ▶ Press the 'Start' button.
 - ▶ Press the 'Start' button again.
'Empty drip tray.'
 - ▶ Empty the drip tray and coffee grounds container and put them back into the machine.
'Pour descaling agent into water tank.'
 - ▶ Remove and empty the water tank.

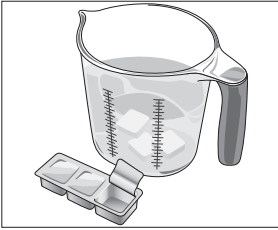

- ▶ Completely dissolve 4 JURA descaling tablets in a receptacle holding 27 oz (800 ml) of water. This may take several minutes.
- ▶ Pour the solution into the empty water tank and insert it into the machine.
'Press the Rotary Switch.'



- ▶ Place one receptacle under the dual spout and another under the hot-water spout.
- ▶ Press the Rotary Switch.
'Machine is being descaled.', water flows repeatedly out of the dual spout and the hot-water spout.
The operation stops automatically. **'Empty drip tray.'** appears on the display.
- ▶ Empty both receptacles.
- ▶ Empty the drip tray and coffee grounds container and put them back into the machine.
'Fill water tank.'



- ▶ Remove the water tank and rinse it thoroughly.
- ▶ Fill the water tank with fresh, cold water and reinsert the tank.
'Press the Rotary Switch.'
- ▶ Place the receptacles back under the dual spout and the hot-water spout.
- ▶ Press the Rotary Switch.
'Machine is being descaled.', water flows out of the dual spout and the hot-water spout.
The operation stops automatically. **'Empty drip tray.'** appears on the display.
- ▶ Empty the drip tray and coffee grounds container and put them back into the machine.
'Descal' / 'Descaling complete.'
Descaling is now complete. Your GIGA is once more ready for use.

i If the descaling operation stops unexpectedly, rinse the water tank thoroughly.

Cleaning the bean container

Coffee beans may be covered with a slight oil film which remains on the walls of the bean containers. These traces may negatively affect the coffee result. For this reason clean the bean containers from time to time.

Precondition: 'Fill bean container.' is displayed.

- ▶ Switch the machine off with the On/Off button.
- ▶ Switch the machine off at the power switch.
- ▶ Open the service cover on the back of the machine by pressing above the JURA logo.
- ▶ Push the red sliding catch completely to the rear to close the bean container.

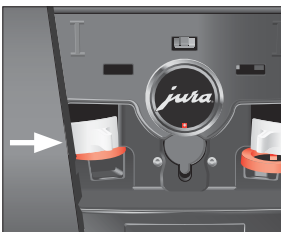
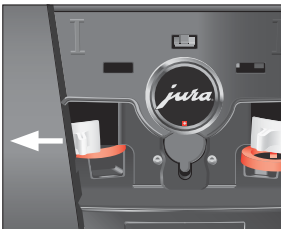
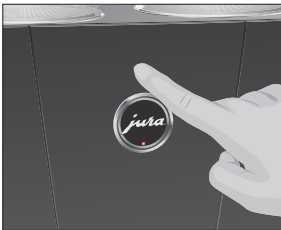

- ▶ Turn the blue locking device outwards.
- ▶ Remove the bean container.
- ▶ Remove the aroma preservation cover.
- ▶ Empty the bean container.
- ▶ Clean the bean container with a soft, dry cloth.
- ▶ Fit the bean container.
- ▶ Turn the blue locking device inwards.
- ▶ Pull the red sliding catch completely forwards.
- ▶ Refit the service cover and fix it by pressing above the JURA logo. It will click into place audibly.
- ▶ Fill the bean container with coffee beans and close the aroma preservation cover.

Descaling the water tank

Limescale deposits may form in the water tank. To ensure correct function of the machine, descale the water tank from time to time.

- ▶ Remove the water tank.
- ▶ If you use a CLEARYL Pro Blue filter cartridge, remove this.
- ▶ Descale the tank with a mild conventional descaling agent in accordance with the manufacturer's instructions.
- ▶ Rinse out the water tank thoroughly.
- ▶ If you use a CLEARYL Pro Blue filter cartridge, insert this again.
- ▶ Fill the water tank with fresh, cold water and reinsert the tank.

6 Display messages

Message	Cause/Result	Action
'Fill water tank.'	The water tank is empty. You cannot prepare any products.	▶ Fill the water tank (see Chapter 1 'Preparing and using for the first time – Filling the water tank').
'Empty coffee grounds container.'	The coffee grounds container is full. You cannot prepare any products.	▶ Empty the coffee grounds container and the drip tray (see Chapter 3 'Daily operation – Daily maintenance').
'Coffee grounds container not fitted.'	The coffee grounds container is not fitted. You cannot prepare any products.	▶ Fit the coffee grounds container.
'Empty drip tray.'	The drip tray is full. You cannot prepare any products.	▶ Empty the drip tray. ▶ Clean and dry the metal contacts on the back of the drip tray.
'Drip tray not fitted.'	The drip tray is not inserted correctly or is not inserted at all. You cannot prepare any products.	▶ Fit the drip tray.
'Press the Rotary Switch.'	The system must be filled with water or the GIGA prompts you to continue a started maintenance program.	▶ Turn the Rotary Switch to continue with the maintenance program or to fill the system.
'Fill bean container.', the bean container status indicator flashes.	One of the bean containers is empty. You cannot prepare any specialty coffees for which coffee beans are required from this bean container. You can prepare hot water or milk.	▶ Fill the bean container (see Chapter 1 'Preparing and using for the first time – Filling the bean container').
'Rinse the milk system.'	The GIGA is prompting you to rinse the milk system.	▶ Press the P button and then the 'Rinse the milk system' button to initiate milk system rinsing.
'Clean machine.'	The GIGA is prompting you to clean it.	▶ Perform cleaning (see Chapter 5 'Maintenance – Cleaning the machine').
'Decalcify machine.'	The GIGA is prompting you to descale it.	▶ Perform descaling (see Chapter 5 'Maintenance – Descaling the machine').

6 Display messages

Message	Cause/Result	Action
'Change filter.'	After 4060 oz (120 liters) of water have flowed through the CLEARYL Pro Blue filter cartridge or after two months, it will cease to work.	► Replace the CLEARYL Pro Blue filter cartridge (see Chapter 5 'Maintenance – Changing the filter').
'Spout is not fitted.'	The dual spout or the cover of the dual spout is not fitted correctly.	► Fit the cover of the dual spout or the dual spout correctly.
'Not enough ground coffee.'	There is insufficient ground coffee in the machine; the GIGA stops the operation.	► The next time you prepare a beverage, add more ground coffee (see Chapter 2 'Preparation – Ground coffee').
'Service cover is not fitted.'	The service cover on the back of the machine is not fitted. You cannot prepare any products.	► Fit the service cover.
'Please check the ventilation slats.'	The ventilation slats on the surface of the machine cannot be opened. You cannot prepare any products.	► Contact customer support in your country (see Chapter 11 'JURA contact details / Legal information').

7 Troubleshooting

Problem	Cause/Result	Action
Insufficient foam is produced when the milk is frothed, or milk sprays from the dual spout.	The dual spout is dirty.	▶ Rinse and clean the dual spout (see Chapter 5 'Maintenance – Cleaning the milk system').
Coffee only comes out in drips when it is being prepared.	Coffee or ground coffee has been ground too finely and is blocking the system. The same filter cartridge may have been used several times or the water hardness set incorrectly in the programming mode.	▶ Put the grinder on a coarser setting or use coarser ground coffee (see Chapter 4 'Permanent settings in programming mode – Setting the consistency of grind'). ▶ Perform descaling (see Chapter 5 'Maintenance – Descaling the machine').
'Fill bean container.' is not displayed although the bean container is empty.	The bean monitor is dirty.	▶ Clean the bean container (see Chapter 5 'Maintenance – Cleaning the bean container').
Preparation stops, 'Fill bean container.' is briefly displayed although the bean container has been filled.	The sliding catch for the bean container has not been pulled out or has not been pulled out completely.	▶ Open the service cover on the back of the machine and pull the sliding catch all the way out (see Chapter 5 'Maintenance – Cleaning the bean container').
'Empty drip tray.' is always displayed.	The metal contacts of the drip tray are dirty or wet.	▶ Clean and dry the metal contacts on the back of the drip tray.
'Fill water tank.' is displayed although the water tank is full.	The water tank float is trapped.	▶ Descale the water tank (see Chapter 5 'Maintenance – Descaling the water tank').
'Error 2' is displayed.	If the machine was exposed to the cold for a long period of time, heating is disabled for safety reasons.	▶ Warm the machine at room temperature.

7 Troubleshooting

Problem	Cause/Result	Action
Other 'Error' messages are displayed.	–	▶ Switch the GiGA off at the power switch. Contact customer support in your country (see Chapter 11 'JURA contact details / Legal information').

- i** If you were unable to solve the problem, contact customer support in your country (see Chapter 11 'JURA contact details / Legal information').



8 Transport and environmentally friendly disposal

Transport / Emptying the system



In order to protect the GIGA from frost during transport, the system must be emptied.

Precondition: 'Please select product:' is displayed.

- ▶ Place one receptacle under the dual spout and another under the hot-water spout.
- P** ▶ Press the P button.
'Maintenance status (1/5)'
-  ▶ Turn the Rotary Switch until the program item 'Machine settings (3/5)' is displayed.
- ▶ Press the 'Factory setting' button.
'Factory setting'
- ▶ Press the 'Empty system' button.
'Empty system' / 'Remove the water tank.'
- ▶ Remove and empty the water tank.
'Press the Rotary Switch.'
-  ▶ Press the Rotary Switch.
'System is emptying.', water flows out of the dual spout and the hot-water spout.
The operation stops automatically. Your GIGA is switched off.

Disposal

Please dispose of old machines in an environmentally neutral way.



9 Technical data

Voltage	120 V ~, 60 Hz
Power	1250 W
Airborne noise emitted	L _p < 70 dB (A)
Ambient conditions	Humidity max. 80 % Ambient temperature 50 – 95 °F (10 – 35 °C)
Conformity mark	
Energy consumption 'Save energy' / 'Save No'	Approx. 30 Wh
Energy consumption 'Save energy' / 'Save Level 1'	Approx. 12 Wh
Energy consumption 'Save energy' / 'Save Level 2'	Approx. 15 Wh
Pump pressure	Static, max. 15 bar
Holding capacity of water tank	169 oz (5 l)
Holding capacity of bean container	2 × 23 oz (2 × 650 g)
Holding capacity of coffee grounds container	Max. 40 portions
Cord length	Approx. 59 in. (Approx. 1.5 m)
Weight	Approx. 40 lb (Approx. 18.9 kg)
Dimensions (W × H × D)	14.6 × 22.2 × 19.6 in. (37 × 57 × 48 cm)

Directives

The machine complies with the following directives:

- Standard UL 1082
- Canadian Standard CSA C22.2 No. 64

Information for testers (repeat test in accordance with DIN VDE 0701-0702): The central grounding point (CGP) is located on the front of the machine below the JURA logo (turn JURA logo anti-clockwise).

10 Index

A

- Addresses 64
- Aroma preservation cover
 - Bean container with aroma preservation cover 8
- Automatic switch-off 34, 35
- Automatic switch-on 34

B

- Background 38
- Bean container
 - Bean container with aroma preservation cover 8
 - Cleaning 52
 - Filling 11
 - Status indicator 8
- Bean container status indicator 8
- Beans à la carte
 - Activating the grinder selection 23
- Bus bar
 - Technical data 58
- Button
 - On/Off button 9
 - P button (programming) 9

C

- Cappuccino 17
- Cappuccino frother cleaning
 - Cleaning the milk system 42
- Cappuccino frother rinsing
 - Rinsing the milk system 42
- Cleaning
 - Bean container 52
 - Machine 48
- CLEARYL Pro Blue filter cartridge
 - Changing 47
 - Inserting and activating the filter 46
- Coffee 17
- Coffee à la carte 17
- Coffee grounds container 8
- Consistency of grind
 - Setting the consistency of grind 30
- Contact details 64
- Cover
 - Service cover 9
 - Water tank 8

- Cup platform 8
- Customer support 64

D

- Date 33
- Descaling
 - Machine 49
 - Water tank 52
- Display 9
- Display messages 53
- Display settings 38
- Disposal 57
- Double product 18
- Drip tray 8
- Dual spout
 - Dismantling and cleaning 44
 - Height- and width-adjustable dual spout 8

E

- Emptying the system 57
- Energy-saving mode 33
- Errors
 - Troubleshooting 55
- Espresso 17
- Expert mode 28

F

- Factory settings
 - Restore factory settings 36
- Filler funnel
 - Filler funnel for ground coffee 8
- Filling
 - Bean container 11
 - Water tank 10
- Filter
 - Changing 47
 - Inserting and activating the filter 46
 - First-time use 11

G

- Grinder
 - Activating the grinder selection 23
 - Setting the consistency of grind 30
- Ground coffee 20

H

- Hotline 64
- Hot water 24
- Hot-water spout
 - Height-adjustable hot-water spout 8

I

- Important safeguards
 - Safety 4
- Instant coffee
 - Ground coffee 20
- Internet 10

J

- JURA
 - Contact details 64
 - Internet 10

L

- Language 37
- Latte macchiato 17
- Locking device 9

M

- Machine
 - Cleaning 48
 - Descaling 49
 - Rinsing the coffee system 42
 - Setting up 10
 - Switching off 26
 - Switching on 25
- Maintenance
 - Daily maintenance 25
- Maintenance 41
- Maintenance settings 31
- Messages, display 53
- Milk
 - Connecting milk 16
- Milk system
 - Cleaning 42
 - Rinsing 42

P

- Permanently setting amounts for the cup size 22
- Permanent settings in programming mode 27
- Power cord 8
- Power switch 8

Preparation 17

- At the touch of a button 18
- Cappuccino 17
- Coffee 17
- Espresso 17
- Ground coffee 20
- Hot water 24
- Latte macchiato 17
- Ristretto 17
- Two specialty coffees 18
- Using the product selector 19

Preparation options 17

- At the touch of a button 18
- Using the product selector 19

Problems

- Troubleshooting 55
- Product selector 17, 19
- Product settings 28
 - Expert mode 28
- Programming mode 27
 - Automatic switch-off 35
 - Background 38
 - Display settings 38
 - Energy-saving mode 33
 - Language 37
 - Maintenance settings 31
 - Product settings 28
 - Querying information 39
 - Restore factory settings 36
 - Setting the consistency of grind 30
 - Setting the water hardness 32
 - Time and date 33
 - Timer 34
 - Units 36

Q

- Querying information 39
- Quick installation 12
- Quick mode 28

R

- Rinsing the coffee system 42
- Ristretto 17
- Rotary Selection 17
 - Product selector 19
- Rotary Switch 9

S

- Safety
 - Important safeguards 4
- Service cover 9
- Service socket 9
- Settings
 - Maintenance settings 31
 - Permanent settings in programming mode 27
- Setting up
 - Setting up the machine 10
- Sliding catch 9
- Splash guard 8
- Spout
 - Height-adjustable hot-water spout 8
 - Height- and width-adjustable dual spout 8
- Standard installation 13
- Switching off
 - Machine 26
- Switching on
 - Machine 25
- Switch-off
 - Automatic switch-off 34, 35
- Switch-off time 34
- Switch-on
 - Automatic switch-on 34
- Switch-on time 34
- Symbol description 3

T

- Technical data 58
- Tel 64
- Time 33
- Time format
 - Programming mode 36
- Timer 34
- Transport 57
- Troubleshooting 55
- Two products 18

U

- Units 36
- Use, First-time 11

V

- Ventilation slats 8
- Venti Ports
 - Ventilation slats 8

W

- Water hardness
 - Determining the water hardness 15
 - Setting the water hardness 32
- Water tank 8
 - Descaling 52
 - Filling 10
- Website 10

– intentionally blank –

– intentionally blank –

11 JURA contact details / Legal information

11 JURA contact details / Legal information

Headquarters JURA Elektroapparate AG
Kaffeeweltstrasse 10
CH-4626 Niederbuchsiten
Switzerland

	USA: JURA Inc.	Canada: FAEMA
Customer Service		
Phone	1-800-220-5701	1-(855)-544-8600
E-Mail	info@us.jura.com	info@juracanada.ca
Opening Hours (EST)	Mon – Thu 9 am – 9 pm, Fri 9 am – 8 pm, Sat 9 am – 5 pm	
Distributor Address	20 Craig Road Montvale, NJ 07645	115 Matheson Boulevard East Mississauga, Ontario, L4Z 1X8
Phone	001 (201) 767-3999	1-(905)-501-8600
Fax	001 (201) 767-9684	
Internet	www.us.jura.com	www.ca.jura.com

@ You will find additional contact details for your country at www.jura.com.

Technical changes We reserve the right to make technical changes. The diagrams used in these instructions for use are for illustration purposes only and do not represent the original colors of the machine. Some details of your GIGA may vary.

Feedback Your opinion is important to us! Use the contact details at www.jura.com.

Copyright The instructions for use contain information which is protected by copyright. It is not permitted to photocopy these instructions for use or translate them into another language without the prior written consent of JURA Elektroapparate AG.