



pro-line™

Chamber Vacuum Sealer

DOMESTIC

VS-CHD1

User Manual





Congratulations on your purchase of a Pro-line Chamber Vacuum Sealer.



Note: Please read through the instructions carefully before using or installing the product and ensure that the manual is kept in a safe place for future reference.

The system must be properly installed and located in accordance with the installation instructions before it is used.

During the set up of this product if you have any questions / comments / issues **DO NOT RETURN TO STORE.**
FOR SERVICE AND TECHNICAL ADVICE VISIT WWW.PROLINEAUSTRALIA.COM.AU/CONTACT

Pro-line Australia
PO Box 4187
Norwood South LPO
South Australia 5067

Email: info@prolineaustralia.com.au
Web: www.prolineaustralia.com.au

Find us
 [/prolineaustralia](https://www.facebook.com/prolineaustralia)
 [@proline_australia](https://www.instagram.com/proline_australia)



Electrical Requirements:
Australia / New Zealand 220-240V 50/60Hz
Due to manufacturing alterations product
may vary slightly from that pictured.

OPERATION CONDITIONS & SAFETY PRECAUTIONS

- All components need to be installed in accordance with the user manual instructions for correct performance of the unit.

READ ALL INSTRUCTIONS CAREFULLY BEFORE OPERATION OF THE UNIT

- This appliance is not intended for use by persons (including children) with reduced physical, sensory or mental capabilities, or lack of experience and knowledge, unless they have been given supervision or instruction concerning use of the appliance by a person responsible for their safety.
- Children should be supervised to ensure that they do not play with the appliance.
- Remove and safely discard any packaging material and promotional labels before using the Vacuum Sealer for the first time.
- Do not operate appliance with a damaged cord or plug or after the appliance malfunctions, or has been damaged in any manner.
- If the cord is damaged, it must be replaced by the manufacturer, its' service agent or similarly qualified persons in order to avoid a hazard.
- Do not use appliance for other than intended use.
- Do not pull or carry the Vacuum Sealer by the cord.
- This appliance should be used in conjunction with a safety switch.
- To protect against risk of fire, electric shock and personal injury, do not immerse cord, plugs, or appliance in water or other liquid.
- Fully unwind the power cord before use. Connect only to 220V/240V power outlet.
- Position the appliance at a minimum distance of 20cm away from walls, curtains and other heat or steam sensitive materials and provide adequate space above and on all sides for air circulation.
- Switch unit off and unplug from wall outlet when not in use and before cleaning.
- Do not use attachments not recommended or sold by the manufacturer as it may lead to fire, electric shock or injury.
- Operate unit on a stable level flat surface, keep away from moving parts. Ensure surface is clean and free from water etc.
- Do not place the unit near the edge of a bench or table during operation.
- Do not place the unit near an oven, heater, direct sunlight or any other heat source.
- If an extension cord is used with this unit, the extension cord must have a rating equal to the rating of this appliance.
- When disconnecting cord, to avoid injury, unplug by grasping the plug and not the cord and ensure your hands are dry.
- Appliance does not require or use any lubricants, such as lubricating oils or water.
- Do not use outdoors or on wet surfaces.
- Do not use appliance for other than intended purpose.



- Clean the gasket and vacuum chamber regularly. Also ensure these parts are cleaned immediately after handling raw meat, poultry or fish.
- Do not reuse vacuum sealer bags after using with raw meat, fish or poultry or after the bag has been heated, i.e. microwave or simmer.
- Keep the vacuum sealer bags away from babies and children to eliminate a choking and suffocation hazard.
- Do not leave the Vacuum Sealer unattended when in use.
- Keep the appliance clean. Follow the cleaning instructions provided in this instruction manual.
- Before cleaning, always turn the appliance OFF. Switch off at the power outlet, unplug at the power outlet and remove the power cord, if detachable, from the appliance and allow all parts to cool.

- After use of the Vacuum Sealer, leave the machine cover open for unit to cool down before closing.
- Use only vacuum sealer bags and rolls or specially designed vacuum bags with this appliance.
- Do not wash marinate bowl lids. Wipe it clean with a soft damp cloth.

WARNING: BURN HAZARD. Heat seal bar will be hot after use, allow to cool before touching.

System Specifications	Pro-line Chamber Vacuum Sealer
Model Code	VS-CHD1
Product Dimensions	305 (L) X 310 (W) X 155 (H) mm
Product Weight	6.1KG
Power	220-240V ~ 50/60Hz, 280W
Max Vacuum Pressure	-0.95 Bar Max.
Air Extraction Volume	40 Litres / MIN

VS-CHD1 PARTS IDENTIFICATION

1. Power Switch (located at rear, not shown)
2. Control Panel
3. Bag Clip
4. Sealing Strip
5. Gasket
6. Heat Seal Bar*
7. Carry Handles
8. Air Extraction Port

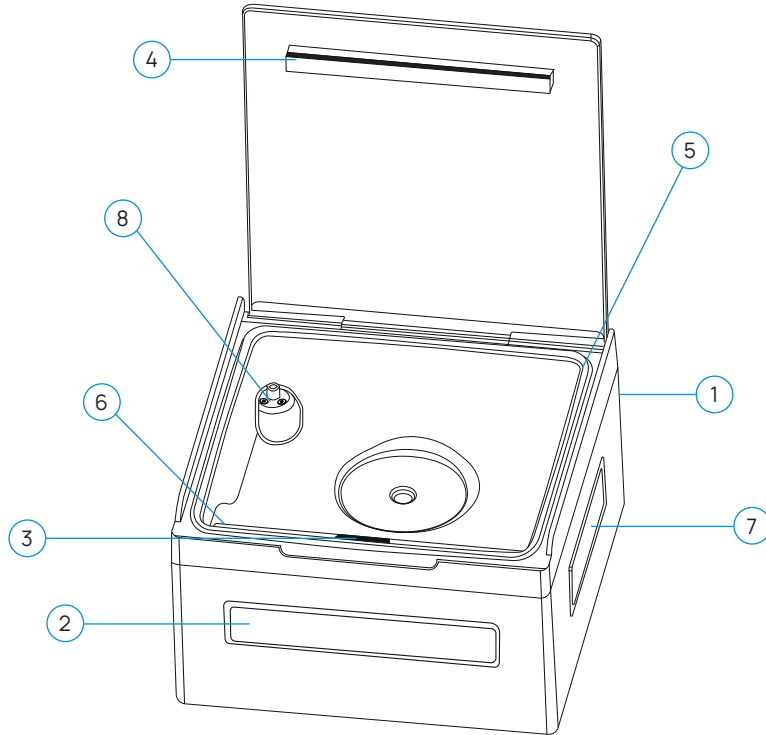

*Do not remove non-stick tape
from heat seal bar

VS-CHD1 CONTROL PANEL

1. Vacuum Pressure
2. Sealing Time
3. Progress LED
4. Auto Vacuum/Cancel
5. Manual Seal
6. Marinate

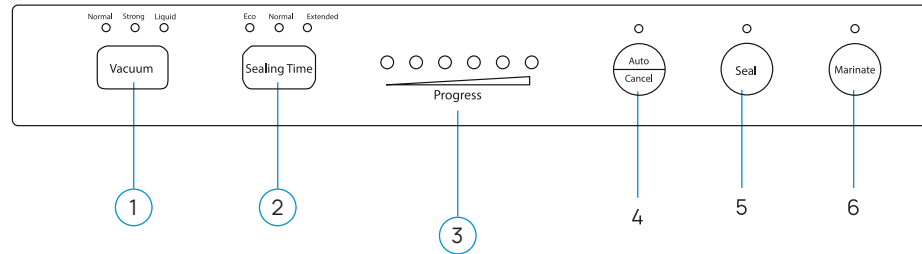

VS-CHD1 CONTROL PANEL DESCRIPTION

Ref	Description
-----	-------------

1.	Vacuum Pressure
----	------------------------

Choose from 3 vacuum pressure settings.

Liquid: For liquid items such as soup.

Normal: For regular items requiring normal vacuum pressure.

Strong: For items where strong vacuum pressure is desired.

Default setting is Normal.

2.	Sealing Time
----	---------------------

Choose from 3 bag sealing time options

Eco: For thin bags or a short heat sealing time.

Normal: For normal items without moisture - shorter seal time.

Extended: For moist/wet items - extended heat sealing time.

Default setting is Normal.

3.	Progress LED
----	---------------------

Shows the progress of the vacuum and sealing process.

4.	Auto Vacuum/Cancel
----	---------------------------

In stand-by mode: Pressing this button automatically starts the vacuum operation then automatically seals the bag when vacuum is complete.

Ref	Description
-----	-------------

While in operation: Pressing this button stops the vacuuming or sealing function.

5.	Manual Seal
----	--------------------

This button provides two functions:

1. To seal the open end of a bag, used to make a bag from a roll.

NOTE: The machine will vacuum for several seconds to raise the heat seal bar, pressing the bag onto the sealing strip ensuring a positive heat seal.

2. When the 'Auto/Cancel' function is in operation, pressing the 'seal' button stops the vacuum pump and immediately starts to seal the bag. This is useful for avoiding crushing of delicate items.

6.	Marinate
----	-----------------

Starts the marinating process. Vacuums for 60 seconds and does not seal.

STORING FOOD IN VACUUM BAGS

1. Place items to be vacuum sealed into a bag. Clean and straighten the open end of the bag.

NOTE: Do not overload the bag, always allow enough space at the open end of the bag to be properly placed over the heat seal bar.

2. Open the top cover of the unit and lift up the bag clip.
3. Lay the bag into the chamber, ensuring the open end is fully covering the heat seal bar.
4. Ensure the bag clip is situated inside the bag. Use your hands to gently expel any extra air inside the bag, this will ensure a better result.

NOTE: Ensure no items or food is covering the heat seal bar and that the bag has no wrinkles as it will inhibit the seal.

5. Lower the bag clip to hold the bottom of the bag in place. See Fig 1.
6. Shut the cover and check the vacuum pressure and sealing time suits the type of food and bag you are using. Adjust if necessary.
7. Press the Auto/Cancel button. The unit will start to vacuum and will seal the bag automatically. The Progress lights will show the progress of the process.
8. When the Progress LED lights switch off the process is complete and the cover can be opened.

WARNING: BURN HAZARD. Heat seal bar may be hot after sealing, allow to cool.

9. Before repeating the process, wipe out any excess liquid or food residue from the chamber.

NOTE: This appliance reaches a high vacuum pressure. If you want to interrupt the vacuum process before its end time press the manual seal button. It will stop the vacuum process and switch to sealing.

NOTE: For best sealing results do not seal one bag after another continuously, to avoid overheating of the heat seal element. The process should follow as packing a bag and then vacuum sealing the bag and repeat.

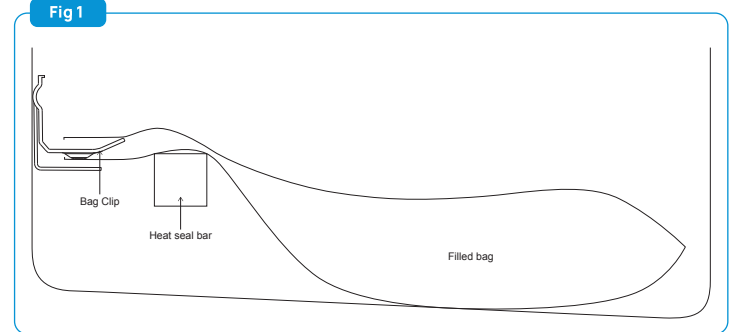

USING THE MARINATE FUNCTION

1. Place items to be marinated and marinate into a bag or open tray. Clean and straighten the open end of the bag. Reminder the bag does not seal under the Marinate function.

NOTE: Do not overload the bag, always allow enough space at the open end of the bag to be properly placed over the heat seal bar.

2. Open the top cover of the unit and lift up the bag clip.
3. Lay the bag into the chamber, ensuring the open end is fully covering the heat seal bar.
4. Ensure the bag clip is situated inside the bag. Use your hands to gently expel any extra air inside the bag, this will ensure a better result.
5. Lower the bag clip to hold the bottom of the bag in place. See Fig 1.
6. Shut the cover and press the marinate button. The LED progress lights will show the progress of the process.
7. Leave the lid closed and repeat step 6, two more times.
8. Open the cover and remove the marinated food.

USING THE MANUAL SEAL BUTTON TO MAKE A BAG

1. Cut the length required for a bag from a roll. Ensure cut is straight.
2. Lift up the bag clip and lay the bag into the chamber with one end of the bag laying flat over the heat seal bar.

NOTE: Ensure that the bag has no wrinkles as it will inhibit the seal.

4. Lower the bag clip making sure the entire opening of the bag is fully covering the heat seal bar. See Fig 2.
5. Shut the cover and press seal button. Pump will work for a few seconds. Sealing LED indicator will flash when finished.
6. Open the cover and remove the finished bag.

WARNING: BURN HAZARD. Heat seal bar may be hot after sealing, allow to cool.

NOTE: For best sealing results do not seal one bag after another continuously, to avoid overheating of the heat seal element.

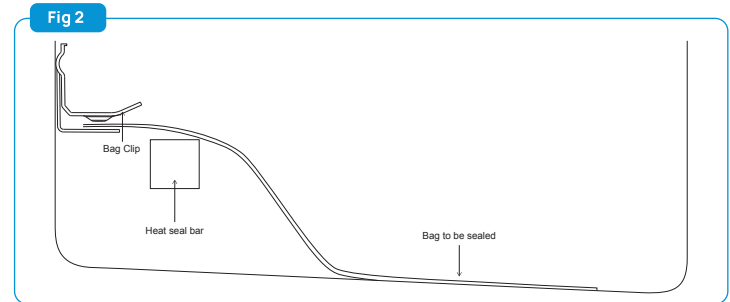



HINTS FOR BEST VACUUMING PERFORMANCE

1. Do not overload the bag; leave enough space at the open end of the bag so that the bag can be easily placed over the heat seal bar.
2. To avoid overfilling, always leave at least 5cm of bag material between bag contents and top of bag. Then leave at least one additional 2cm of bag material for each time you plan to reuse bag.
3. Clean and straighten the open end of the bag before sealing. Make sure nothing is left on the open area of the bag and bag has no wrinkles or creased lines. Foreign objects or creased bag may cause difficulty in sealing the bag tightly.
4. Always insert the bag clip when sealing contents in a bag.
5. Do not vacuum package objects with sharp points like fish bones and hard shells. Sharp points may penetrate and tear the bag.
6. Allow appliance to cool down for one minute between each sealing operation.
7. Clean the chamber, heat seal bar and sealing strip after each vacuuming operation.

IMPORTANT: Do not reuse vacuum sealer bags after using with raw meat, fish or poultry or after the bag has been heated, i.e. microwaved or simmered.

FOOD STORAGE/PRESERVATION GUIDELINES

The Vacuum Sealer will change the way you purchase and store food. The Vacuum Sealer removes air from the specially designed vacuum sealer bags to create a commercial quality vacuum.

The ease and convenience of preserving and extending the freshness of your food with the Vacuum Sealer will become an indispensable part of your food preparation.

The Vacuum Sealer removes air from specially designed bags to extend food freshness up to 5 times longer than conventional storage methods.

Oxygen and moisture in air causes food to degrade over time, by removing the air before sealing items airtight the Vacuum Sealer extends the life of food naturally.

Vacuum sealing is not intended to replace the refrigeration or freezing of foods, food should still be refrigerated or frozen if normally required.

IMPORTANT: It is best to vacuum seal fresh food, vacuum sealing will not restore or revive food past its prime. Do not consume food that has gone bad.

FOOD PRESERVATION CHART

NOTE: Storage preservation chart are estimates only and should be used as a guide only. The storage life will depend on the original quality of the foods and the integrity of the packages seal.

Fridge	Conventional Storage	Pro-line Vacuum Sealer
Semi Hard Cheeses (Swiss, Cheddar)	1-2 weeks	4-8 months
Hard Cheeses (Parmesan)	1-2 weeks	4-8 months
Lettuce, Spinach	3-6 days	2 weeks
Avocado (cut)	1-2 days	5-6 days
Blueberries	3-6 days	2 weeks
Other berries (Blackberries, Strawberries, Raspberries)	1-3 days	1 week

Freezer	Conventional Storage	Pro-line Vacuum Sealer
Beef, Pork or Lamb	6 months	2-3 years
Minced Meat	4 months	1 year
Poultry	6 months	2-3 years
Soups, Stews, Sauces	3-6 months	1-2 years
Vegetables	8 months	2-3 years
Berries	1-2 months	6-8 months

Pantry	Conventional Storage	Pro-line Vacuum Sealer
Nuts	6 months	2 years
Coffee Beans	6 months	1 year
Rice	6 months	2 years
Flour	6 months	1-2 years
Sugar	6 months	1-2 years
Chips	1-2 weeks	3-6 weeks
Cookies, Crackers	1-2 weeks	3-6 weeks



HINTS & TIPS

- Before vacuum sealing, it is necessary to clean your hands and all utensils and surfaces to be used for cutting and vacuum sealing foods.
- Refrigerate or freeze perishable foods immediately, if they have been vacuum sealed do not leave them sitting at room temperature.

NOTE: It may be harmful if you consume foods which have been left out at room temperature.

- Store dry foods such as nuts, biscuits or cereals, in a cool, dark dry place.
- Vacuum sealed bags prevent freezer burn. Foods that thaw easily should be placed at the back of the freezer where the temperature is more constant. When thawing foods it is best to thaw foods in the refrigerator. Never thaw meats, poultry, fish or dairy at room temperature or in hot water. If thawing food by microwave, foods should be cooked immediately after processing to prevent bacteria growth.
- Pro-line vacuum sealer bags and rolls are microwave safe. To microwave cut off one corner of the bag so that steam can escape and place in the microwave.
- Pro-line vacuum sealer bags and rolls are simmer/boil safe. Place bag into a pot of boiling water with the top of the bag above the water for easy removal.

NOTE: Bags or rolls are not reusable if they have been microwaved or simmered/boiled.

- Vacuum sealing fruits, for best results pre-freeze cut soft fruit prior to vacuum sealing. This helps prevent the fruit from being crushed during the vacuum process.
- Vegetables, for best results blanch vegetables in hot water otherwise they may turn black. Blanch so that vegetables are still crunchy, then transfer immediately into icy cold water to cool. Drain and separate into convenient portions then vacuum seal in bags.
- Vacuum sealing poultry and whole fish, for best results wash poultry and pat dry with a paper towel. Then place foods between two paper towels inside bag before vacuum sealing. The paper towels helps to absorb excess moisture and juices.
- Vacuum sealing red meats and fish fillets - for best results pat dry with a paper towel. Then place foods between two paper towels inside bag before vacuum sealing. The paper towels helps to absorb excess moisture and juices.

HINTS & TIPS

NOTE: Vacuum sealing may cause meat to darken. This is due to the removal of oxygen and does not indicate spoilage.

- Pro-line Vacuum Sealer's can also protect non-food items from oxidation, corrosion and moisture. Simply store and seal items in a Pro-line vacuum bag and follow the "Storing food in a vacuum bag" instructions.
- Vacuum seal items to help keep them dry, and take up less room for storage e.g. camping, batteries, important documents, travelling and emergency equipment.
- Vacuum seal wet paint brushes between paint jobs without cleaning, it keeps them moist and saves on clean up time.
- The marinate function is a great solution for marinating meats in minutes, not hours, as vacuum sealing opens the pores in foods such as meat, poultry and seafood's allowing foods to absorb marinades in a fraction of the time.
- For the busy family, on-the-go meals can be prepared ahead and vacuum sealed in individual servings, ready to heat any time.
- Prepare foods in advance for picnics and camping trips or barbecues.
- To make an ice pack, pour water into a bag, allowing at least 8cm of space at the top of the bag (this allows space for expansion of liquid when frozen and sealing space for the bag). Do not seal at this point. Place the filled liquid bag upright into a freezer, when liquid is frozen, remove bag from freezer and vacuum seal. Use for ice in the cooler, or ice packs for sports injuries.
- Primarily the vacuum sealer is used for vacuum sealing, however you are able to reseal foil based bags such as chip and biscuit bags using the manual seal function.



CLEANING AND MAINTENANCE

It is important to ensure that all parts of your Vacuum Sealer sealing system is cleaned on a regular basis.

Follow the care and cleaning guidelines below:

1. Always unplug the unit before cleaning.
2. Do not immerse appliance in water or any other liquid.
3. Do not use abrasive cleaners to clean the unit.
4. Wipe the outside of the unit with a damp cloth, sponge or mild dish soap.
5. Wipe away food residue and water inside or around component with a paper towel.
6. Dry thoroughly before use.

Cleaning Gasket and Sealing Strip:

Remove gasket from its indentation location and the sealing strip from the lid and wash with warm soapy water then rinse thoroughly. Ensure both are completely dry before installing back into their respective locations.

IT IS IMPORTANT that the gaskets are not out of shape or damaged in any manner otherwise air tight seal will not be formed when cover is closed.

Cleaning Vacuum Bags:

NOTE: Do not reuse the vacuum sealer bags after using with raw meat, fish or poultry or after the bag has been heated, i.e. microwaved or simmered.

1. Wash bag material in warm water with a mild dishwashing soap.
2. Alternatively, bags can be washed on the top rack in your dishwasher by turning the bag inside out. Stand bags up so that the washing water can rinse the entire surface.

Consumables and spare parts can be purchased on the Pro-line Australia online shop at: www.prolineaustralia.com.au

These include:

A range of different sized Chamber Vacuum Sealer bags.
A range of spare parts that include gaskets and Heat Seal Strips.

TROUBLE SHOOTING: BEFORE YOU EMAIL FOR SERVICE PLEASE REVIEW THE TROUBLE SHOOTING TIPS FIRST.

Problem	Possible Cause	Solution
Nothing happens when I press the vacuum sealer.	<ol style="list-style-type: none">1. Power cord is not plugged in.2. Power cord is damaged.3. Power switch at rear of unit is not turned on.	<ol style="list-style-type: none">1. Make sure the power cord is correctly plugged into the electrical outlet, and in the "on" position.2. Check power cord and plug, and make sure they are not damaged in any way. If damaged, do not use the vacuum sealer.3. Turn rear power switch to on position.
Air is not removed from the bag completely.	<ol style="list-style-type: none">1. The bag has not been placed correctly inside the chamber.2. Debris covering sealing strip or gasket. Sealing strip may be out of place.3. Bag may have a hole.4. Unit cover has not been closed properly.	<ol style="list-style-type: none">1. To seal properly, the bag clip should be situated inside the bag.2. Check sealing strip and gasket for debris and wipe clean and smooth them back into place.3. To test, seal the bag with some air in it, submerge in water and apply pressure. If there are bubbles present, it indicates a leak and a new bag should be used.4. Open cover and re-close the cover. You may need to press down on the cover for a few seconds at the start of the vacuuming process.
Liquids are bubbling during the vacuum process.	<ol style="list-style-type: none">1. The boiling point of liquids reduce when atmospheric pressure is reduced.	<ol style="list-style-type: none">1a. Always vacuum items when they are cold or slightly chilled.1b. Minimise the effect by stopping the vacuum process when the pressure gauge reaches -0.95 Bar, by activating the seal button.



TROUBLE SHOOTING: BEFORE YOU EMAIL FOR SERVICE PLEASE REVIEW THE TROUBLE SHOOTING TIPS FIRST.

Problem	Possible Cause	Solution
Vacuum sealer bag loses vacuum after being sealed.	<ol style="list-style-type: none">1. Bag not sealed properly.2. Moisture or juices from foods.3. Bag has a hole.	<ol style="list-style-type: none">1. Wrinkles, crumbs, grease or liquids may cause leaks along the seal. Re-open the bag, wipe inside the top of the bag and smooth it out along the heat seal bar before re-sealing.2. Check if there is moisture or juices from the food present within the bag, if yes you may need to cut open the bag and reseal it, or use a new bag.3. Items with sharp edges may have punctured the bag, releasing the vacuum. Cushion sharp edges in the contents of the bag with paper towels.
Engine is running but pressure gauge is not moving.	<ol style="list-style-type: none">1. There is gasket debris.2. Gasket has not sealed.	<ol style="list-style-type: none">1. Check gasket for debris and clean if there is any.2a. Place hand on the lid press down at the beginning of the vacuum cycle.2b. Replace gasket, parts available from www.prolineaustralia.com.au
Vacuum sealer not sealing bag properly.	<ol style="list-style-type: none">1. Heat seal bar is too hot.2. The seal only function is still active or needs to reset.3. The Heat Seal tape has been removed or is worn/uneven.	<ol style="list-style-type: none">1. If the heat seal bar overheats and melts the bag, lift the lid and allow to cool for a few minutes.2. Before re-pressing the seal only button, allow the unit to resume for 15 secs.3. Replace the heat seal tape. Spare parts available from www.prolineaustralia.com.au

Your Pro-line Australian 12 Month Domestic Repair or Replacement Warranty

Pro-line warrants this appliance to the first purchaser and subject to the stated conditions:

Warranty covers any defects in material or workmanship in the manufactured product within the first 12 months of warranty, from the date of purchase.

To make a warranty claim you must visit Pro-line online at www.prolineaustralia.com.au/warrantyclaim

If a product is found to be faulty there is a 90 day return policy from the date of purchase. Products returned to store MUST be accompanied by a valid proof of purchase.

For warranty claims outside of 90 days from date of purchase, product will be repaired or replaced at our discretion. Repair or replacement costs of the product will be covered under warranty by Pro-line.

Goods presented for repair may be replaced by refurbished goods of the same type rather than being repaired. Refurbished parts may be used to repair the goods.

The benefits given to you by this warranty are in addition to other rights and remedies of the consumer law in relation to the goods or services to which this warranty relates.

Our goods come with guarantees that cannot be excluded under the Australian Consumer Law. You are entitled to a replacement or refund for a major failure and compensation for any other reasonably foreseeable loss or damage. You are also entitled to have the goods repaired or replaced if goods fail to be of acceptable quality and the failure does not amount to a major failure.



Conditions Of This Warranty:

1. This product has been fully installed in accordance with the user manual installation instructions.
2. The warranty extends only to repairing or replacing any component that proves to be defective in material or workmanship.
3. The warranty does not cover defects occasioned by misuse, alterations, accidents, or used for other than the intended purpose.
4. The warranty does not cover damage to the product caused by accident, fire, or floods, power surges or blackouts.
5. The warranty does not cover consumables.
6. Proof of purchase is required for warranty claims.

Please keep purchase receipt in a safe place.

Pro-line Australia

PO Box 4187

Norwood South LPO

South Australia 5067

info@prolineaustralia.com.au



www.prolineaustralia.com.au



Pro-line Australia
PO Box 4187
Norwood South LPO
South Australia 5067

Email: info@prolineaustralia.com.au
Web: www.prolineaustralia.com.au

Find us

 [/prolineaustralia](https://www.facebook.com/prolineaustralia)
 [@proline_australia](https://twitter.com/proline_australia)