



pro-line™

Vacuum Sealer

INDUSTRIAL

VS-I30-1

VS-I40-1

User Manual





Congratulations on your purchase of a Pro-line Industrial Vacuum Sealer.



Note: Please read through the instructions carefully before using or installing the product and ensure that the manual is kept in a safe place for future reference.

The system must be properly installed and located in accordance with the installation instructions before it is used.

During the set up of this product if you have any questions / comments / issues **DO NOT RETURN TO STORE.**
FOR SERVICE AND TECHNICAL ADVICE VISIT WWW.PROLINEAUSTRALIA.COM.AU/CONTACT

Pro-line Australia
PO Box 4187
Norwood South LPO
South Australia 5067

Email: info@prolineaustralia.com.au
Web: www.prolineaustralia.com.au

Find us
 [/prolineaustralia](https://www.facebook.com/prolineaustralia)
 [@proline_australia](https://www.instagram.com/proline_australia)



Electrical Requirements:
Australia / New Zealand 220-240V 50Hz
Due to manufacturing alterations product
may vary slightly from that pictured.

OPERATION CONDITIONS & SAFETY PRECAUTIONS

- All components need to be installed in accordance with the user manual instructions for correct performance of the unit.

READ ALL INSTRUCTIONS CAREFULLY BEFORE OPERATION OF THE UNIT

- This appliance is not intended for use by persons (including children) with reduced physical, sensory or mental capabilities, or lack of experience and knowledge, unless they have been given supervision or instruction concerning use of the appliance by a person responsible for their safety.
- Children should be supervised to ensure that they do not play with the appliance.
- Remove and safely discard any packaging material and promotional labels before using the Vacuum Sealer for the first time.
- Do not operate appliance with a damaged cord or plug or after the appliance malfunctions, or has been damaged in any manner.
- If the cord is damaged, it must be replaced by the manufacturer, its' service agent or similarly qualified persons in order to avoid a hazard.
- Do not use appliance for other than intended use.
- Do not pull or carry the Vacuum Sealer by the cord.
- This appliance should be used in conjunction with a safety switch.
- To protect against risk of fire, electric shock and personal injury, do not immerse cord, plugs, or appliance in water or other liquid.
- Fully unwind the power cord before use. Connect only to 220V/240V power outlet.
- Position the appliance at a minimum distance of 20cm away from walls, curtains and other heat or steam sensitive materials and provide adequate space above and on all sides for air circulation.
- Switch unit off and unplug from wall outlet when not in use and before cleaning.
- Do not use attachments not recommended or sold by the manufacturer as it may lead to fire, electric shock or injury.
- Operate unit on a stable level flat surface, keep away from moving parts. Ensure surface is clean and free from water etc.
- Do not place the unit near the edge of a bench or table during operation.
- Do not place the unit near an oven, heater, direct sunlight or any other heat source.
- If an extension cord is used with this unit, the extension cord must have a rating equal to the rating of this appliance.
- When disconnecting the cord, to avoid injury, unplug by grasping the plug and not the cord and ensure your hands are dry.
- Appliance does not require or use any lubricants, such as lubricating oils or water.
- Do not use outdoors or on wet surfaces.
- Do not use appliance for other than intended purpose.



- Clean the vacuum sealer upper and lower gaskets and vacuum chamber regularly. Also ensure these parts are cleaned immediately after handling raw meat, poultry or fish.
- Do not reuse vacuum sealer bags after using with raw meat, fish or poultry or after the bag has been heated, i.e. microwave or simmer.
- Keep the vacuum sealer bags away from babies and children to eliminate a choking and suffocation hazard.
- Do not leave the Vacuum Sealer unattended when in use.
- Keep the appliance clean. Follow the cleaning instructions provided in this Instruction manual.
- Before cleaning, always turn the appliance OFF. Switch off at the power outlet, unplug at the power outlet and remove the power cord, if detachable, from the appliance and allow all parts to cool.
- After use of the Vacuum Sealer, leave the machine cover open for unit to cool down before closing.

- Use only vacuum sealer bags and rolls or specially designed vacuum bags with this appliance.
- Do not wash canister or marinate bowl lids. Wipe it clean with a soft damp cloth.

IMPORTANT: Do not store or leave appliance for extended periods with the cover closed and locked into position. It will cause the gaskets and sealing strip to become compressed and compromise the sealing ability of the unit. To store the unit, start with the lid in the open position, close the lid but do not lock the lid down.

WARNING: BURN HAZARD. Heat seal bar will be hot after use, allow to cool before touching.

System Specifications	Pro-line Industrial Vacuum Sealer	
Model code	VS-I30-1	VS-I40-1
Product dimensions	400 (L) X 380 (W) X 135 (H) mm	500 (L) X 380 (W) X 135 (H) mm
Product weight	5.1KG	5.9KG
Power	220-240V ~ 50/60Hz, 220W	220-240V ~ 50/60Hz, 360W
Noise	< 78 dB	< 78 dB
Max vacuum pressure	-0.95 Bar Max.	-0.95 Bar Max.
Air extraction volume	20 Litres / MIN	25 Litres / MIN

VS-130-1 & VS-140-1 PARTS IDENTIFICATION

1. Cover Lock Handle
2. Control Panel
3. Roll Holder & Cutter
4. Power Switch
5. Sealing Strip
6. Upper & Lower Gaskets
7. Heat Seal Bar*
8. Vacuum Chamber
9. Bag Locators
10. Air Intake
11. Cord Storage
12. Accessory Hose Storage Compartment

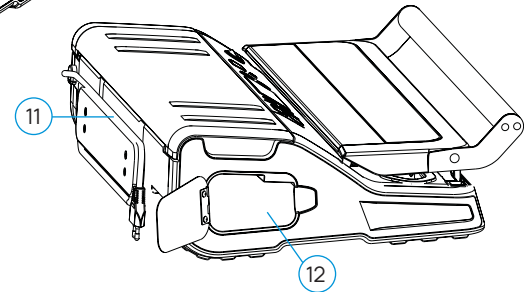
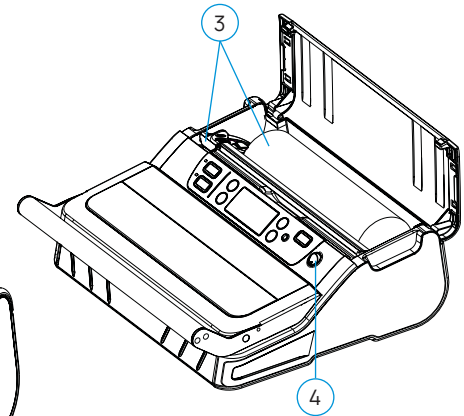
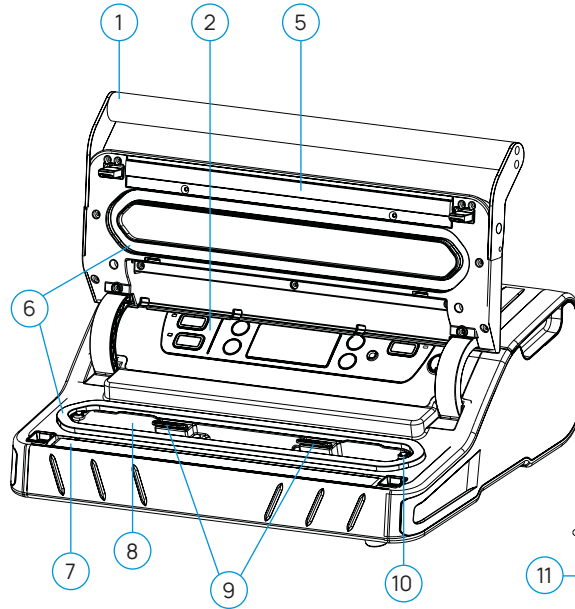

*Do not remove Teflon tape from the heat seal bar

VS-130-1 & VS-140-1 CONTROL PANEL

1. Auto Vac & Seal - Dry
2. Auto Vac & Seal - Moist
3. Pulse
4. Manual Seal
5. Progress Display
6. Marinate
7. Canister
8. Cancel
9. Accessory Port

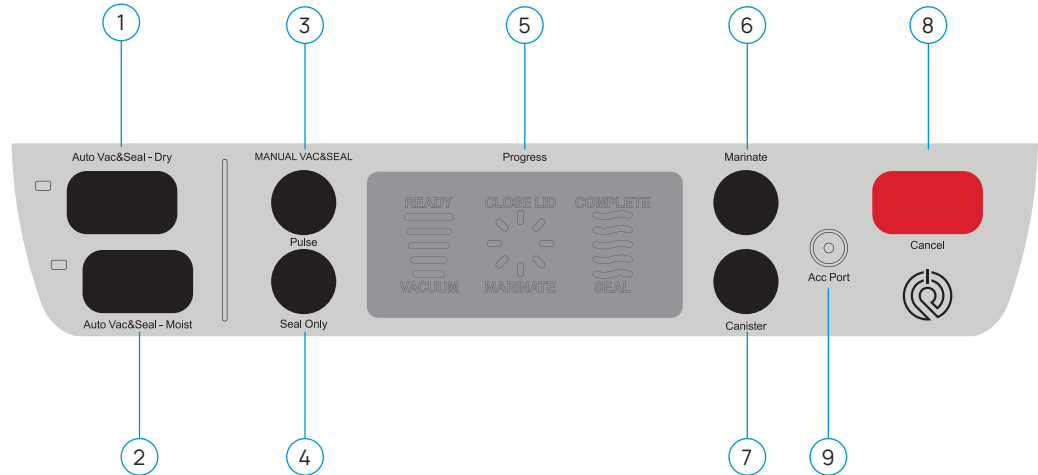

VS-I30-1 & VS-I40-1 CONTROL PANEL DESCRIPTION

Ref	Description	Ref	Description
1.	Auto Vac & Seal - Dry In stand-by mode, pressing the vacuum & seal button starts the automatic vacuum operation then automatically seals the bag when vacuum is complete. For dry items without moisture - shorter heat sealing time.	5.	Progress Display LED Display that shows the working progress when the unit is either vacuuming, marinating or sealing. Also indicates when the unit is ready to use, a process is complete or the lid needs to be properly closed.
2.	Auto Vac & Seal - Moist In stand-by mode, pressing the Vacuum & Seal button starts the automatic vacuum operation then automatically seals the bag when vacuum is complete. Moist: For moist items with little liquid - longer heat sealing time.	6.	Marinate To marinate using the marinate bowl. See 'marinating food with marinate bowl' section.
3.	Pulse Press and hold and the unit will start vacuuming; release the button and the vacuuming stops. Used when better control of the vacuum process is required to prevent the crushing of delicate foods and avoid very wet items drawing moisture into the machine.	7.	Canister To vacuum canisters. See 'storing food in canisters' section.
4.	Manual Seal For sealing the open end of a bag without vacuuming - useful for making a bag from a roll.	8.	Cancel While in operation pressing this button stops the vacuuming or sealing function.
		9.	Accessory Port For use with the accessory hose and consumables.

NOTE: The engine does run for a short time to activate the piston to raise the heat seal bar.

Pro-line Vacuum Rolls

For VS-I30-1, buy VS-283
3 x 28cm wide and 5.4m long



For VS-I40-1, buy VS-402
2 x 40cm wide and 6m long



Pro-line Vacuum Rolls and Bags lock in the freshness and are BPA free, boil, freezer and microwave safe.

These premium quality rolls and bags use dual cross venting technology to provide you with superior consistent results.

Head to our website to view our full range of Vacuum Sealer accessories at:
www.prolineaustralia.com.au/shop

MAKING A BAG FROM A VACUUM ROLL

NOTE: Refer to the diagrams on the next page.

1. Place a vacuum roll into the roll storage compartment.
2. Lift the roll cutter to the back.
3. Unroll the roll to the desired length.

NOTE: You will require at least 5cm of bag material more than the item to be vacuum sealed, as the extra 5cm will form the dual seal.

4. Lower the cutter rack back down and slide the cutter from one end to the other to cut the roll.
5. Put one end of the bag on top of the heat seal bar, but not fully into the vacuum chamber. Refer to diagram 5.1
6. Lower the lid and press down on either side of the handle until you hear two clicks, which indicates the handle is locked into place. 2 LED lights in the view-in window will also illuminate and the LED display screen will show 'ready'.
7. Press the 'seal only' button to start sealing the bag. The sealing indicator on the LED display will show the progress of the sealing.

NOTE: The engine does run for a short time to activate the piston to raise the heat seal bar.

8. The process is done when the LED display indicates 'complete'. Press the handle to open the cover and take the sealed bag out of the machine. The bag is then ready for vacuum sealing.

WARNING: BURN HAZARD. Heat seal bar may be hot after sealing, do not touch.

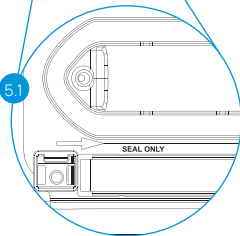
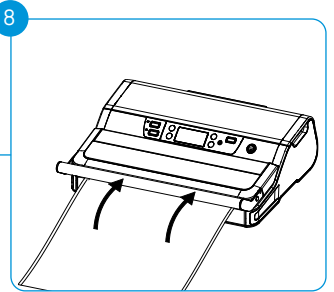
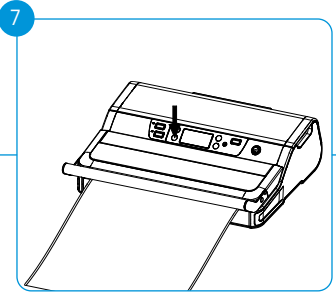
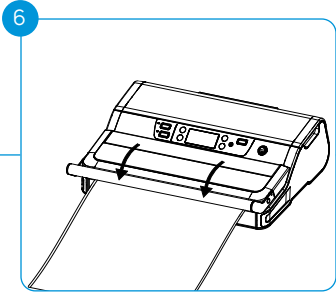
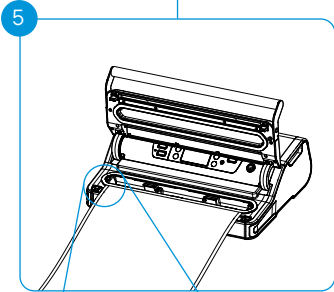
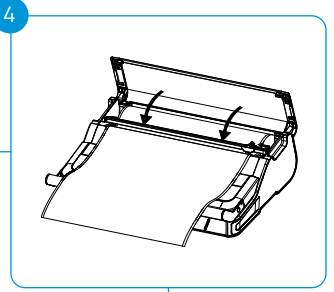
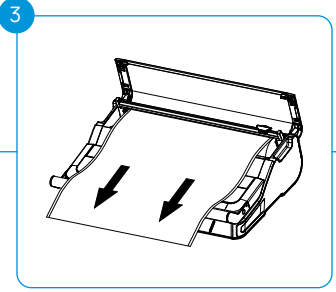
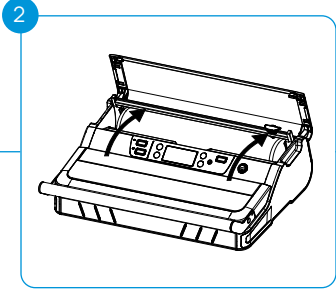
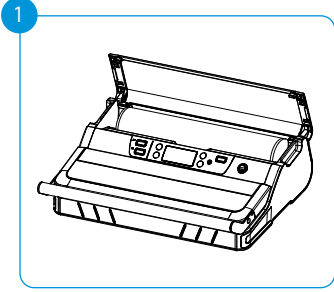



STORING FOOD IN VACUUM BAGS

NOTE: Refer to the diagrams on the next page.

1. Prepare a bag to be vacuum sealed.

NOTE: Do not overload the bag. Always allow enough space at the open end of the bag to be adequately placed into the vacuum chamber.

2. Open the unit and insert open end of the filled bag over the heat seal bar and into the vacuum chamber, stopping at the bag locators.

NOTE: Ensure no items or food is covering the heat seal bar and that the bag has no wrinkles or ripples that will inhibit the seal.

NOTE: The vacuum chamber draws air out of the bag and catches any liquid overflow in the chamber. The lower gasket and vacuum chamber should be cleaned regularly. Always ensure these parts are cleaned immediately after handling raw meat, poultry or fish.

3. Lower the lid and press down on either side of the handle until you hear two clicks, which indicates the handle is locked into place. The two LED lights inside the view-in window and the 'ready' indicator on the LED display will also indicate when the unit can be used.
4. There are two pre-programmed vacuum and sealing options, for dry or moist items. You can perform these actions manually with the pulse and seal only buttons, this is useful for items you do not want to crush such as potato chips.

5. The process is done when the LED display indicates 'complete'. Lift the handle to open the cover and take the sealed bag out of the machine.
6. Refrigerate or freeze sealed food if needed.
7. Before repeating with a new bag and food contents, always wipe away any excess liquid or food residue in the vacuum chamber.

IMPORTANT: Do not store or leave appliance for extended periods with the cover closed and locked into position. It will cause the gaskets and sealing strip to become compressed and compromise the sealing ability of the unit. To store the unit, start with the lid in the open position, close the lid but do not lock the lid down.

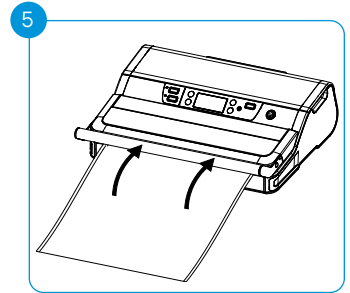
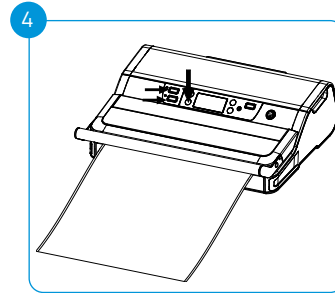
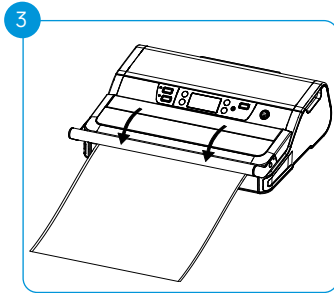
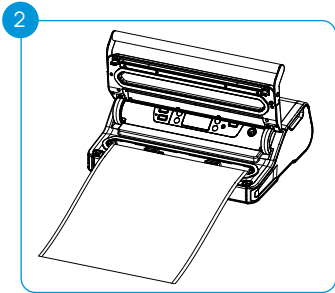

STORING FOOD IN CANISTERS

1. Ensure canisters are clean and dry.

NOTE: Do not immerse canister lids in water, clean with a damp cloth only.

2. Fill canister with the item to be stored and secure lid onto the canister.

NOTE: Leave at least 2cm from canister cover rim, and make sure upper lid is securely on before vacuuming.

3. Turn canister lid dial arrow to SEAL.
4. Connect one end of the accessory hose to the accessory port, located on the right hand side of the control panel, and the other end to the canister lid. Ensure both connections are pushed in tightly. See Fig 1
5. Press the canister button on the control panel to draw out air from canister. Vacuum action will stop automatically when all air has been drawn out from canister.

NOTE: Press down on the lid at the beginning of the vacuum process to assist with forming an air tight seal.

6. Remove accessory hose connection to the canister.
7. To open canister after vacuum packaging, first turn the canister lid dial arrow to OPEN. Wait several seconds for the lid to be released before removing.

NOTE: Canister lids are not to be used in microwaves or in freezers.

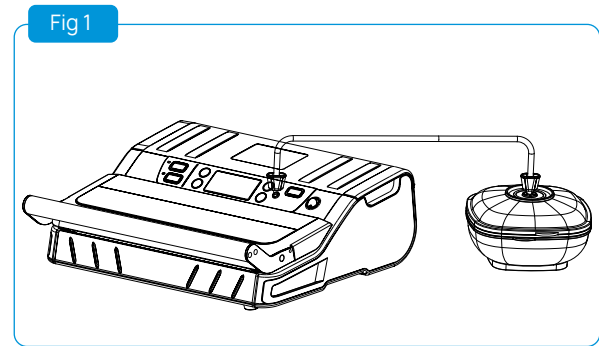

MARINATING MEAT WITH THE MARINATE BOWL

1. Place the food and marinade into the marinate bowl.
2. Secure the lid onto the marinate bowl.

NOTE: Leave at least 2cm from the top.

3. Turn the marinate bowl lid dial arrow to SEAL.
4. Connect one end of the accessory hose to the accessory port and the other end to the marinate bowl lid. Ensure both connections are pushed in tightly.
5. Press the marinate button on the control panel to begin the vacuum process. It will take approximately 6 minutes to complete the process.
6. The pump will activate applying a vacuum to the marinate bowl, opening the pores in foods such as meat, chicken and seafood allowing absorption of marinates in minutes not hours. It will hold the vacuum and then release the vacuum, counting as 1 cycle. This cycle will be repeated 5 times.
7. When the 'complete' indicator light turns on, the process is complete.
8. Remove accessory hose connection to the marinate bowl.
9. To open the marinate bowl turn the lid dial arrow to OPEN. Wait several seconds for the lid to be released before removing.

NOTE: Marinate bowl is not to be used in a microwave, freezer or oven.

USING PULSE VACUUM FUNCTION

1. Press and hold the Pulse button to start vacuuming, releasing the button will stop the vacuum function. Continue as needed - observing carefully to ensure delicate food is not being crushed and to avoid very wet items drawing moisture into the machine.
2. Once the desired pressure is achieved, press the seal only button to seal the bag.



HINTS FOR BEST VACUUMING PERFORMANCE

1. Do not overload the bag; leave enough space at the open end of the bag so that the bag can be easily placed over the heat seal bar and in the vacuum chamber.
2. To avoid overfilling, always leave at least 5cm of bag material between bag contents and top of the bag. Then leave at least an additional 2cm of material for each time you plan to reuse the bag.
3. Clean and straighten the open end of the bag before sealing. Make sure nothing is left on the open area of the bag and the bag has no wrinkles or creased lines. Foreign objects or a creased bag may cause difficulty in sealing the bag tightly.
4. Do not vacuum package objects with sharp points like fish bones and hard shells. Sharp points may penetrate and tear the bag. You will want to cover any sharp points with an additional piece of film, or use a canister instead of a bag.
5. Allow the appliance to cool down for one minute between each sealing operation.
6. Clean the vacuum chamber and gaskets after each vacuuming operation.
7. When using a canister, remember to leave 2cm from the canister cover rim, and make sure the upper lid is already locked and in the 'seal' position before vacuuming.

IMPORTANT: Do not reuse vacuum sealer bags after using with raw meat, fish or poultry or after the bag has been heated, i.e. microwave or simmer.

FOOD STORAGE/PRESERVATION GUIDELINES

The Vacuum Sealer will change the way you purchase and store food. The Vacuum Sealer removes air from the specially designed Vacuum Sealer bags and canisters to create a commercial quality vacuum.

The ease and convenience of preserving and extending the freshness of your food with the Vacuum Sealer will become an indispensable part of your food preparation.

The Vacuum Sealer removes air from specially designed bags and canisters to extend food freshness up to 5 times longer than conventional storage methods.

Oxygen and moisture in air causes food to degrade over time, so removing the air before sealing items airtight with the Vacuum Sealer extends the life of food naturally.

Vacuum sealing is not intended to replace the refrigeration or freezing of foods, food should still be refrigerated or frozen if normally required.

IMPORTANT: It is best to vacuum seal fresh food as vacuum sealing will not restore or revive food past its prime. Do not consume food that has gone bad.

FOOD PRESERVATION CHART

NOTE: Storage preservation chart are estimates only and should be used as a guide only. The storage life will depend on the original quality of the foods and the integrity of the packages seal.

Fridge	Conventional Storage	Pro-line Vacuum Sealer
Semi Hard Cheeses (Swiss, Cheddar)	1-2 weeks	4-8 months
Hard Cheeses (Parmesan)	1-2 weeks	4-8 months
Lettuce, Spinach	3-6 days	2 weeks
Avocado (cut)	1-2 days	5-6 days
Blueberries	3-6 days	2 weeks
Other berries (Blackberries, Strawberries, Raspberries)	1-3 days	1 week

Freezer	Conventional Storage	Pro-line Vacuum Sealer
Beef, Pork or Lamb	6 months	2-3 years
Minced Meat	4 months	1 year
Poultry	6 months	2-3 years
Soups, Stews, Sauces	3-6 months	1-2 years
Vegetables	8 months	2-3 years
Berries	1-2 months	6-8 months

Pantry	Conventional Storage	Pro-line Vacuum Sealer
Nuts	6 months	2 years
Coffee Beans	6 months	1 year
Rice	6 months	2 years
Flour	6 months	1-2 years
Sugar	6 months	1-2 years
Chips	1-2 weeks	3-6 weeks
Cookies, Crackers	1-2 weeks	3-6 weeks



HINTS & TIPS

- Before vacuum sealing, it is necessary to clean your hands and all utensils and surfaces to be used for cutting and vacuum sealing foods.
- Refrigerate or freeze perishable foods immediately, if they have been vacuum sealed do not leave them sitting at room temperature.

NOTE: It may be harmful if you consume foods which have been left out at room temperature.

- Store dry foods such as nuts, biscuits or cereals, in a cool, dark dry place.
- Vacuum sealed bags prevent freezer burn. Foods that thaw easily should be placed at the back of the freezer where the temperature is more constant. When thawing foods it is best to thaw foods in the refrigerator. Never thaw meats, poultry, fish or dairy at room temperature or in hot water. If thawing food by microwave, foods should be cooked immediately after processing to prevent bacteria growth.
- Pro-line vacuum sealer bags and rolls are microwave safe. To microwave cut off one corner of the bag so that steam can escape and place in the microwave.
- Pro-line vacuum sealer bags and rolls are simmer/boil safe. Place bag into a pot of boiling water with the top of the bag above the water for easy removal.

NOTE: Bags or rolls are not reusable if they have been microwaved or simmered/boiled.

- To freeze soups and sauces pour liquid into a bag, allowing at least 8cm of space at the top of the bag (this allows space for expansion of liquid when frozen and sealing space for the bag). Do not seal at this point. Place the filled liquid bag upright into a freezer, when liquid is frozen, remove bag from freezer and vacuum seal.
- Vacuum sealing fruits, for best results pre-freeze cut soft fruit prior to vacuum sealing. This helps prevent the fruit from being crushed during the vacuum process.
- Vegetables, for best results blanch vegetables in hot water otherwise they may turn black. Blanch so that vegetables are still crunchy, then transfer immediately into icy cold water to cool. Drain and separate into convenient portions then vacuum seal in bags.
- Vacuum sealing poultry and whole fish, for best results wash poultry and pat dry with a paper towel. Then place foods between two paper towels inside bag before vacuum sealing. The paper towels helps to absorb excess moisture and juices.
- Vacuum sealing red meats and fish fillets - for best results pat dry with a paper towel. Then place foods between two paper towels inside bag before vacuum sealing. The paper towels helps to absorb excess moisture and juices.

HINTS & TIPS

NOTE: Vacuum sealing may cause meat to darken. This is due to the removal of oxygen and does not indicate spoilage.

- Pro-line Vacuum Sealer's can also protect non-food items from oxidation, corrosion and moisture. Simply store and seal items in a Pro-line vacuum bag and follow the "Storing food in a vacuum bag" instructions.
- Vacuum seal items to help keep them dry, and take up less room for storage e.g. camping, batteries, important documents, travelling and emergency equipment.
- Vacuum seal wet paint brushes between paint jobs without cleaning, it keeps them moist and saves on clean up time.
- Use the canisters to store delicate items such as berries, biscuits and salad leaves or use to store sauces or soups.
- The marinate bowl is a great solution for marinating meats in minutes, not hours, as vacuum sealing opens the pores in foods such as meat, poultry and seafood's allowing foods to absorb marinades in a fraction of the time.
- For the busy family, on-the-go meals can be prepared ahead and vacuum sealed in individual servings, ready to heat any time.
- Prepare foods in advance for picnics and camping trips or barbecues.
- To make an ice pack, pour water into a bag, allowing at least 8cm of space at the top of the bag (this allows space for expansion of liquid when frozen and sealing space for the bag). Do not seal at this point. Place the filled liquid bag upright into a freezer, when liquid is frozen, remove bag from freezer and vacuum seal. Use for ice in the cooler, or ice packs for sports injuries.
- Primarily the vacuum sealer is used for vacuum sealing, however you are able to reseal foil based bags such as chip and biscuit bags using the manual seal function.



STORING YOUR VACUUM PRESERVATION SYSTEM

The condition of the upper gasket and lower gasket parts on your Vacuum Sealer are critical to the forming of an air tight seal around the bag when the cover is locked in position.

Food debris or deformation of the gaskets due to the machine being stored in the locked position can affect the ability of the machine to evacuate air from the bag successfully.

To prevent this:

- Start with the lid in the open position, close the lid but do not lock the lid down.
- Regularly inspect the upper and lower gaskets to ensure they are clean, in good condition and not deformed (compressed).

If your machine is failing to remove air from the bag, it may be due to the gaskets. If this happens:

1. Inspect upper and lower gasket and ensure they are clean and in good condition and that they sealed correctly.
2. If no damage is apparent, the gaskets may be deformed (compressed).
3. Remove the gaskets, turn upside down and replace back into the machine.
4. If these steps fail then replace the gaskets with a replacement kit from Pro-line Australia's online store, code VS-GASKET-I30 or VS-GASKET-I40.

Keep the unit in a flat and safe place, out of the reach of children.

CLEANING AND MAINTENANCE

It is important to ensure that all parts of your Vacuum Sealer sealing system is cleaned on a regular basis.

Follow the care and cleaning guidelines below:

1. Always unplug the unit before cleaning.
2. Do not immerse appliance in water or any other liquid.
3. Do not use abrasive cleaners to clean the unit.
4. Wipe the outside of the unit with a damp cloth, sponge or mild dish soap.
5. Wipe away food residue and water inside or around component with a paper towel.
6. Dry thoroughly before use.

Cleaning Vacuum Bags:

NOTE: Do not reuse the vacuum sealer bags after using with raw meat, fish or poultry or after the bag has been heated, i.e. microwaved or simmered.

1. Wash bag material in warm water with a mild dishwashing soap.
2. Alternatively, bags can be washed on the top rack in your dishwasher by turning the bag inside out. Stand bags up so that the washing water can rinse the entire surface.

Cleaning Gaskets:

Remove lower and upper gasket from its indentation location and wash with warm soapy water then rinse thoroughly. Ensure gaskets are completely dry before installing back into indentation location.

IT IS IMPORTANT that the gaskets are not out of shape or damaged in any manner otherwise air tight seal will not be formed when cover is closed.

Cleaning Accessories:

(Including canister base and hose accessories.)

1. Wash all vacuum accessories in warm water with a mild dishwashing soap (except canister lids.)
2. Canisters (not lids) are top rack dishwasher safe. Canister and marinate bowl lids should be wiped down with a damp cloth and must not be immersed in water.
3. Ensure all accessories are thoroughly dried before use.

NOTE: Canister lids are not to be used in microwaves or in freezers.

Consumables and spare parts can be purchased on the Pro-line Australia online shop at: www.prolineaustralia.com.au

These include:

Upper & lower gaskets - VS-GASKET-I30, VS-GASKET-I40
Teflon tape strip or roll - VS-TAPE, VS-TAPE-I40



TROUBLE SHOOTING: BEFORE YOU EMAIL FOR SERVICE PLEASE REVIEW THE TROUBLE SHOOTING TIPS FIRST.

Problem	Possible Cause	Solution
Nothing happens when I press the vacuum sealer.	<ol style="list-style-type: none"> 1. Power cord is not plugged in. 2. Power cord is damaged. 	<ol style="list-style-type: none"> 1. Make sure the power cord is correctly plugged into the electrical outlet, and in the "on" position. 2. Check power cord and plug, and make sure they are not damaged in any way. If damaged, do not use the vacuum sealer.
Air is not removed from the bag completely.	<ol style="list-style-type: none"> 1. The bag has not been placed correctly inside the vacuum chamber. 2. Debris covering sealing strip or upper and lower gaskets. Sealing strip gaskets may be out of place. 3. Bag may have a hole. 4. Unit cover has not been closed properly. 	<ol style="list-style-type: none"> 1. To seal properly, open end of bag should be resting entirely inside the vacuum chamber. 2. Check sealing strip and upper & lower gasket for debris. Ensure gaskets are correctly sealed and not compressed. See page 18 for more info on gaskets. 3. To test, seal the bag with some air in it, submerge in water, and apply pressure. If there are bubbles present, it indicates a leak and a new bag should be used. 4. Open cover and re-close the cover. Push down firmly on the cover until you hear it 'click' indicating the cover is now fully closed and locked in.
Poor suction or vacuum sealer does not seal when on auto vac/seal function.	<ol style="list-style-type: none"> 1. Gaskets are deformed causing air leak. 2. Air leaking via accessory port. 	<ol style="list-style-type: none"> 1a. Pull out lower & upper gaskets, turn over and reinstall. 1b. Replace gaskets via Pro-line online shop, product code VS-GASKET-I30 or VS-GASKET-I40. 2a. Lock down lid without a bag, press vac & seal button while holding index finger over accessory port, allow machine to complete cycle. 2b. Insert and remove accessory hose 3 times via twisting motion.

Problem	Possible Cause	Solution
Vacuum sealer bag loses vacuum after being sealed.	<ol style="list-style-type: none"> 1. Bag not sealed properly. 2. Moisture or juices from foods. 3. Bag has a hole. 	<ol style="list-style-type: none"> 1. Wrinkles, crumbs, grease or liquids may cause leaks along the seal. Reopen bag, wipe the top inside of the bag and smooth it out along the sealing strip before resealing. 2. Check if there is moisture or juices from the food present within the bag, if yes, you may need to cut open the bag and reseal it, or use an entirely new bag. Foods with excess liquids should be frozen before vacuum sealing. 3. Items with sharp edges may have punctured the bag, releasing the vacuum. Cushion sharp edges in the contents of the bag with paper towels.
Vacuum sealer not sealing bag properly.	<ol style="list-style-type: none"> 1. Sealing strip is too hot. 2. Seal only function still active or needs to reset. 	<ol style="list-style-type: none"> 1. The sealing strip may have overheated and melted the bag. Lift the lid and allow sealing strip to cool for a few minutes. 2. Before re-pressing the "seal only" button, allow the unit to cool for 15 seconds.
The canisters and bowl will not vacuum.	<ol style="list-style-type: none"> 1. Upper & lower gaskets are not forming an air tight seal. 2. Canister lid dial not in SEAL position. 3. Accessory hose not correctly attached to accessory port or canister lid. 4. Lid not secure. 	<ol style="list-style-type: none"> 1. Ensure gaskets are correctly sealed and are not compressed. See page 20 for further information on gaskets. 2. Gently turn the canister lid dial arrow to SEAL position. 3. Make sure accessory hose is firmly pushed in all the way into the accessory port on appliance and canister lid. 4. Push down on lid at the beginning of the vacuum process to assist in forming the air tight seal.



Your Pro-line Australian 12 Month Commercial Repair or Replacement Warranty

Pro-line warrants this appliance to the first purchaser and subject to the stated conditions:

- The term "Commercial" when referring to our warranty is defined as use in a commercial setting or using the product on a commercial scale regardless of where the product is stored.

Warranty covers any defects in material or workmanship in the manufactured product within the first 12 months of a Commercial warranty.

To make a warranty claim you must visit Pro-line online at www.prolineaustralia.com.au/warrantyclaim

If a product is found to be faulty there is a 90 day return policy from the date of purchase. Products returned to store **MUST** be accompanied by a valid proof of purchase.

For warranty claims outside of 90 days from date of purchase, product will be repaired or replaced at our discretion. Repair or replacement costs of the product will be covered under warranty by Pro-line.

Goods presented for repair may be replaced by refurbished goods of the same type rather than being repaired. Refurbished parts may be used to repair the goods.

The benefits given to you by this warranty are in addition to other rights and remedies of the consumer law in relation to the goods or services to which this warranty relates.

Our goods come with guarantees that cannot be excluded under the Australian Consumer Law. You are entitled to a replacement or refund for a major failure and compensation for any other reasonably foreseeable loss or damage. You are also entitled to have the goods repaired or replaced if goods fail to be of acceptable quality and the failure does not amount to a major failure.

Conditions Of This Warranty:

1. This product has been fully installed in accordance with the user manual installation instructions.
2. The warranty extends only to repairing or replacing any component that proves to be defective in material or workmanship.
3. The warranty does not cover defects occasioned by misuse, alterations, accidents, or used for other than the intended purpose.
4. The warranty does not cover damage to the product caused by accident, fire, or floods, power surges or blackouts.
5. The warranty does not cover consumables.
6. Proof of purchase is required for warranty claims.

Please keep purchase receipt in a safe place.

Pro-line Australia

PO Box 4187

Norwood South LPO

South Australia 5067

info@prolineaustralia.com.au



www.prolineaustralia.com.au



Pro-line Australia
PO Box 4187
Norwood South LPO
South Australia 5067

Email: info@prolineaustralia.com.au
Web: www.prolineaustralia.com.au

Find us

 [/prolineaustralia](https://www.facebook.com/prolineaustralia)
 [@/proline_australia](https://twitter.com/proline_australia)