

TURBO BOOST CONTROLLER USER GUIDE

GM GEN 4 (GEN5 CAMARO, CTS-V2, C6 CORVETTE, ETC – E38, E67 PCMS)

(PART NUMBERS: KAI-5517, KAI-5518)

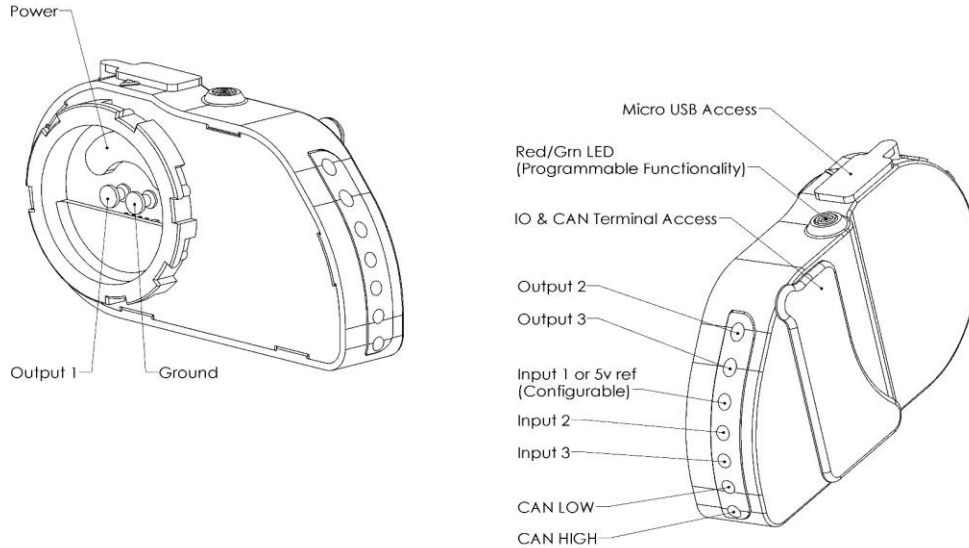

The Kaizen Relay Boost Controller interfaces with the factory powertrain CANbus using a Kaizen Relay and Control Module. We use parameters such as Front and Rear Wheel Speed, Throttle Position, Engine RPM and others to providing varying duty cycle outputs to get your car hooked up and down the track as quickly as possible.

INSTALLATION:

1. Locate the 2-pin CANbus termination resistor and unplug it. The wires leading into the plug will be tan & tan/blk.

CTSV Sedan: Trunk (passenger side in front of the fuse box)

CTSV Coupe/Wagon: Trunk (driver side in front of the fuse box)

Gen5 Camaro: Behind the interior trim plastic on the passenger side rear quarter panel.

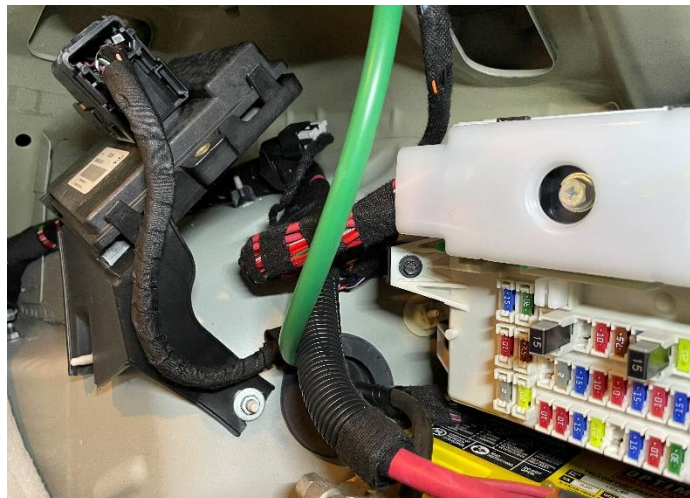

2. Plug in the provided connector in place of the term resistor

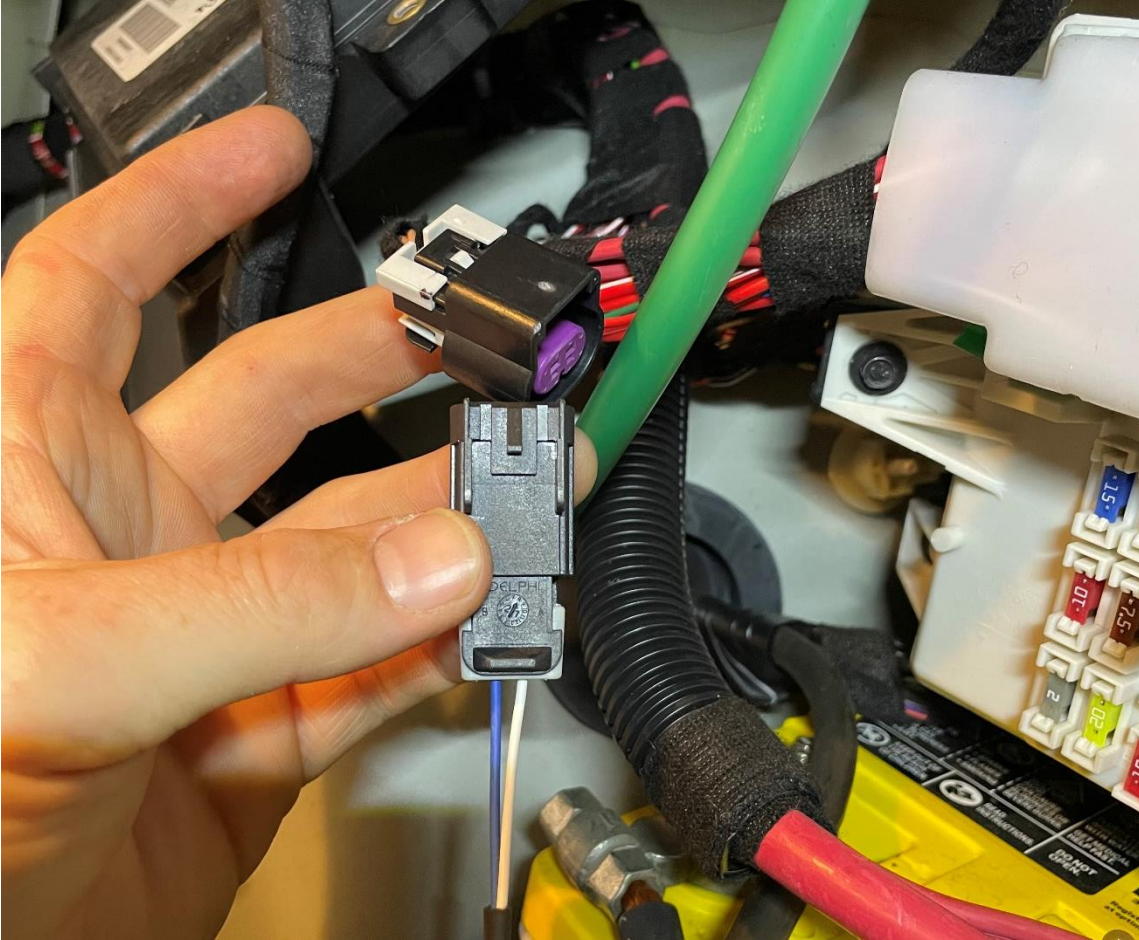

3. Remove the positive battery cable and detach the red plastic cover using a small screwdriver. Attach the provided ring terminal to the battery positive post.



4. Attach the chassis ground loop to the chassis and mount the Kaizen Relay assembly.



5. Run the wiring for the 12-position switch into the driver compartment and mount it where you'd like.
6. Run the wiring for the smoothboost to the front of the vehicle and connect it to the smoothboost PWM (-) input
7. That's it!

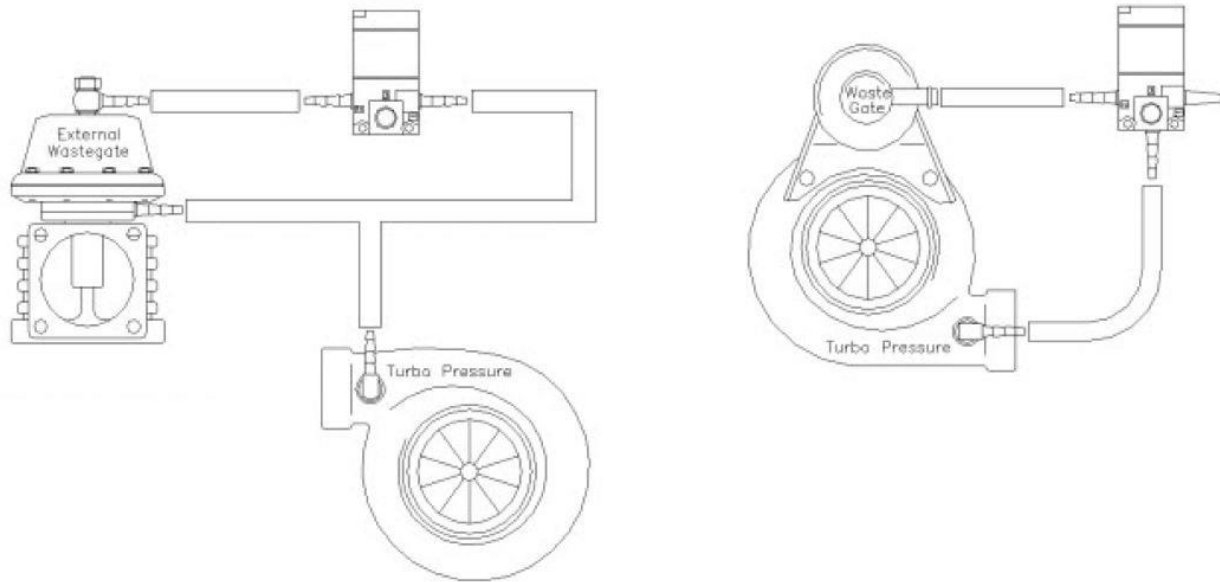

0% DC is MINIMUM BOOST (100% is MAXIMUM BOOST)

Output 2 is pre-wired to the solenoid so the tuner can apply fixed duty cycle positions and determine what DC% equals what boost. This will depend on a number of factors mainly wastegate spring pressure. Once boost is determined per switch position, the user may opt to use Output 3 (move wire from Output 2 to Output 3) in order to take advantage of boost ramps (listed below). If you wish to change the DC% in the boost ramps, contact us. (instructional video soon)

Output 1: On when TPS > 60% (commonly used for aux fuel pump control)

* Output 1 is the only output that does not exit the front of the Control Module. Output 1 is a pogo pin connection directly to the Kaizen Relay it's attached to.

Output 2: Dependent on Switch Position (Duty Cycle = %DC)

These outputs apply a fixed duty cycle to help in initial setup and tuning. Try each duty cycle and do WOT pulls to determine how duty cycle % affects boost pressure.

Sw Pos 0: 0%DC

Sw Pos 1: 10%DC

Sw Pos 2: 20%DC

Sw Pos 3: 30%DC

Sw Pos 4: 40%DC

Sw Pos 5: 50%DC

Sw Pos 6: 60%DC

Sw Pos 7: 70%DC

Sw Pos 8: 80%DC

Sw Pos 9: 90%DC

Sw Pos 10: 100%DC

Sw Pos 11: 100%DC

Output 3: Dependent on Switch Position (Duty Cycle = %DC)

These outputs apply a variable duty cycle depending on vehicle conditions such as TPS, Front and Rear Wheel Speed, Gear, etc.

REAR Wheel Speed + Timer Based (Switch Position 0-6): Minimum boost until TPS>50% then a boost ramp timer starts once REAR Wheel Speed>5mph

- Rear speed boost ramp makes burnouts easy
- Doesn't overboost if TPS is exceeded before launching
- Ramp doesn't start until rear wheels are spinning
- Works for drag and roll racing

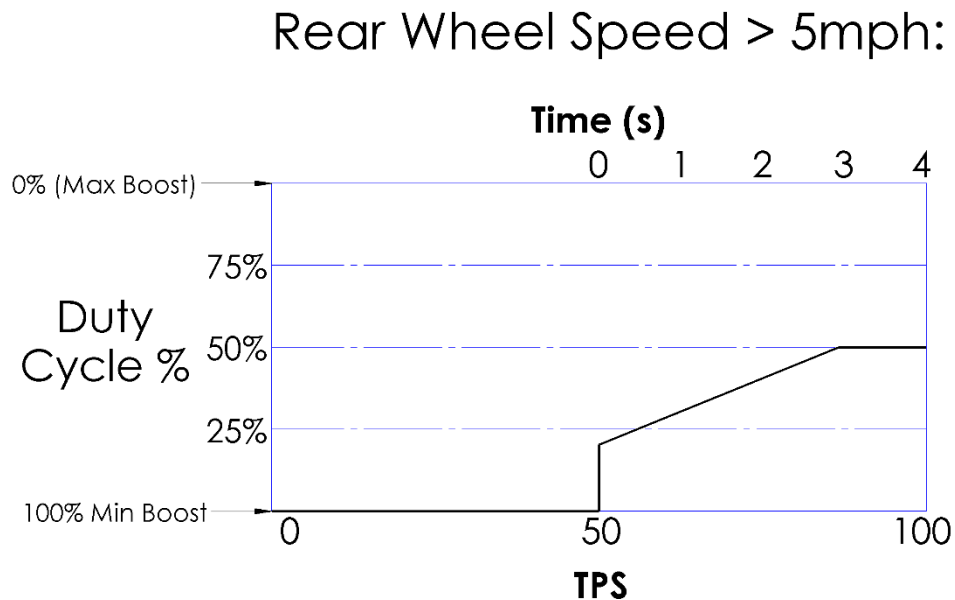

Sw Pos 0: Min. boost until TPS > 50% and Rear Wheel Speed > 5mph then immediately 20%DC ramping to 50%DC over 3 seconds.

Sw Pos 1: Min. boost until TPS > 50% and Rear Wheel Speed > 5mph then immediately 20%DC, ramping to 50%DC over 2 seconds.

Sw Pos 2: Min. boost until TPS > 50% and Rear Wheel Speed > 5mph then immediately 30%DC, ramping to 65%DC over 3 seconds.

Sw Pos 3: Min. boost until TPS > 50% and Rear Wheel Speed > 5mph then immediately 30%DC, ramping to 65%DC over 2 seconds.

Sw Pos 4: Min. boost until TPS > 50% and Rear Wheel Speed > 5mph then immediately 35%DC, ramping to 75%DC over 4 seconds.

Sw Pos 5: Min. boost until TPS > 50% and Rear Wheel Speed > 5mph then immediately 35%DC, ramping to 75%DC over 3 seconds.

Sw Pos 6: Min. boost until TPS > 50% and Rear Wheel Speed > 5mph then immediately 35%DC, ramping to 75%DC over 2 seconds.

FRONT Wheel Speed Based (Switch Position 7-9):

- Doesn't increase boost if wheelspin occurs
- Doesn't overboost if TPS is exceeded before launching
- Ramp doesn't start until front wheels are spinning
- Works for drag and roll racing

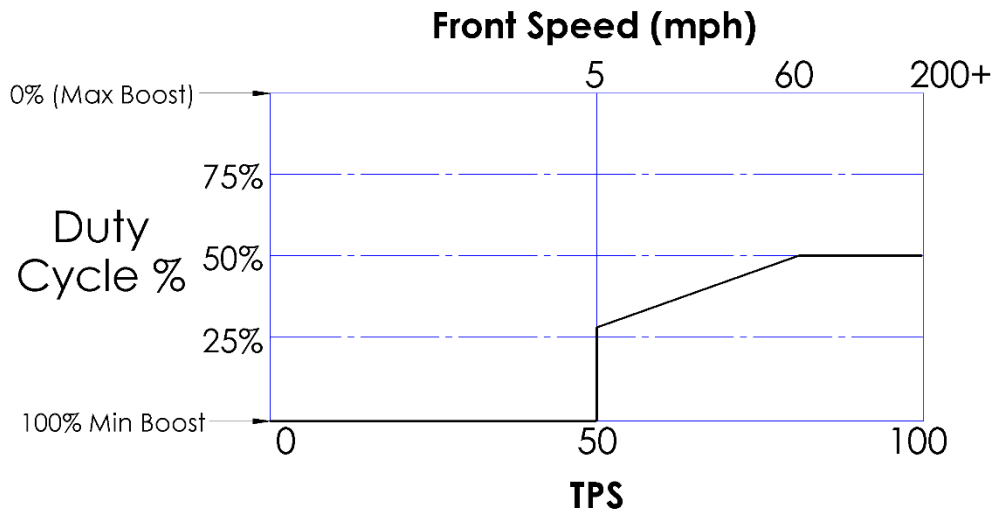

Sw Pos 7: Min. boost until TPS > 50% and Front Wheel Speed > 5mph then immediately 30%, ramping to 50%DC when Front Speed > 60mph.

Sw Pos 8: Min. boost until TPS > 50% and Front Wheel Speed > 5mph then immediately 30%, ramping to 60%DC when Front Speed > 60mph.

Sw Pos 9: Min. boost until TPS > 50% and Front Wheel Speed > 5mph then immediately 30%, ramping to 60%DC when Front Speed > 40mph (more boost sooner).

Gear Based (Switch Position 10-11):

- Automatically increases boost with each upshift
- Works for drag and roll racing

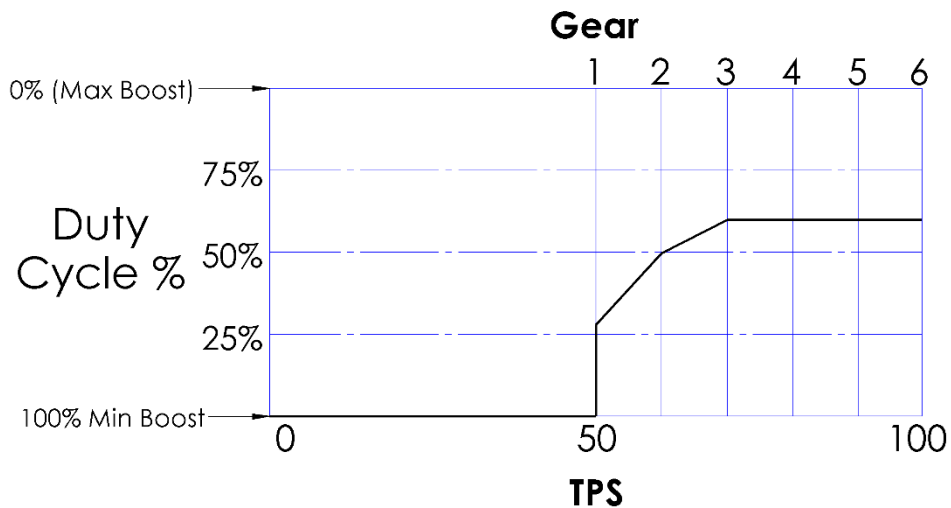

Sw Pos 10: Min. boost until TPS > 50% then: Gear 1 = 30%, Gear 2 = 50%, Gear 3+ = 60%

Sw Pos 11: Min. boost until TPS > 50% then: Gear 1 = 35%, Gear 2 = 55%, Gear 3+ = 60%

Troubleshooting:

Download Kaizen Relay Manager from Kaizenspeed.com (Kaizenspeed.com>Help>Downloads & Programming Guides)

Plug in to the Control Module using the supplied USB cable and navigate to the Firmware tab. Here you can see vehicle data, timer status and output duty cycles over time. The monitor tab shows the instantaneous input and output status.

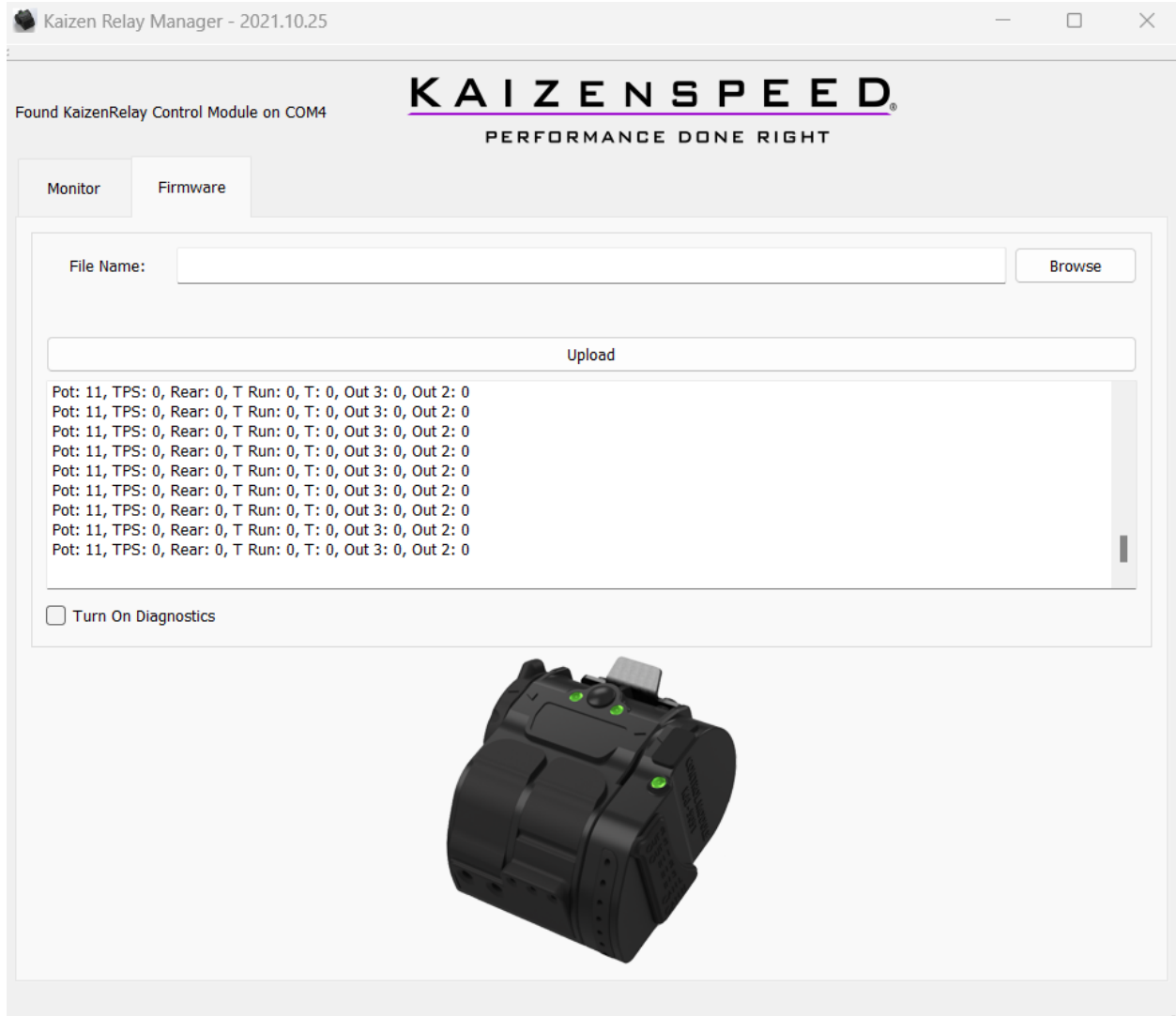

The screenshot displays the Kaizen Relay Manager software interface. The window title is "Kaizen Relay Manager - 2021.10.25". The main header features the "KAIZENSPEED" logo with the tagline "PERFORMANCE DONE RIGHT". Below the logo, it states "Found KaizenRelay Control Module on COM4". The interface has two tabs: "Monitor" and "Firmware", with "Firmware" currently selected. In the Firmware tab, there is a "File Name:" input field and a "Browse" button. Below this is an "Upload" button. A text area displays the following data: Pot: 11, TPS: 0, Rear: 0, T Run: 0, T: 0, Out 3: 0, Out 2: 0. This data is repeated ten times. At the bottom of the Firmware tab, there is a checkbox labeled "Turn On Diagnostics" which is currently unchecked. Below the Firmware tab, there is a 3D rendering of the Kaizen Relay Manager control module, a black rectangular device with several green indicator lights.