



BIG TURTLE SHELL[®]

RUGGED WIRELESS BOOMBOX

By Outdoor Tech[®]

• HI-FI SOUND •
• BUILT IN POWERBANK •

Welcome to total sonic freedom.

outdoortech.com

CONTENTS

SHELL ANATOMY	1
POWER UP	4
PAIR	5
WIRED	7
POWERBANK	8
LISTEN & TALK	9
SPECIFICATIONS	12
FAQ	13

ANATOMY

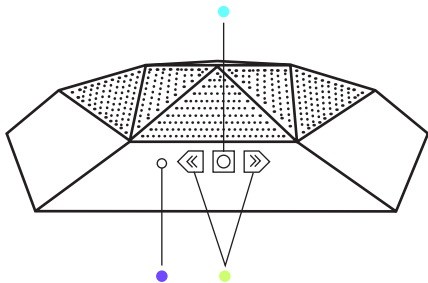

- **Power Button**

- **Multifunction Button (MFB)**

Press once to Play/Pause OR Answer/Hang up.
Hold down for 4 seconds to enter pairing mode.

- **Volume/Track Control**

Raise volume by pressing >>

Lower volume by pressing <<

Skip forward by holding >> for 2 seconds

Skip backward by holding << for 2 seconds

ANATOMY

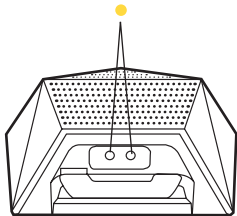

- 3.5mm Audio Input/Output
- Big Turtle Shell® Charge Port
- USB Device Charge Port
- Built in Microphone

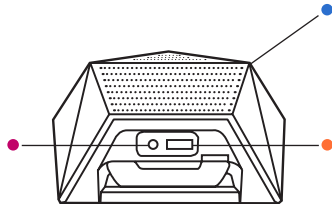

ANATOMY

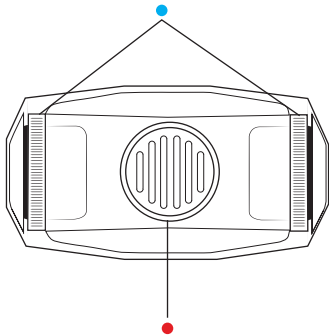

- **Grab Handles/ Mounting Bars**

Strap them to your bike and them on a stroll or hold two on each hand and have them play anywhere!

- **Passive Bass Port**

For best audio experience, fully charge your Big Turtle Shell® before use.

*NOTE: It takes about 3 hours to fully charge the Big Turtle Shell.

Power On: Press & hold the power button.

Indicator Light	Status
Flashes RED	Low Battery*
RED Light	Charging
No Light	Charged

*The speaker will prompt "Charge me."

Double click the power button to hear battery prompt.

The Big Turtle Shell® will power off when idle and not connected to any devices.

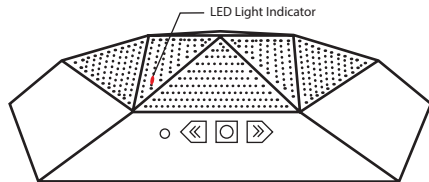

PAIR



Pair the first device

Power on Big Turtle Shell® then it will in the pairing mode.

Use your device to search for the "ODT Big Turtle Shell®."

when successfully paired the Big Turtle Shell® will prompt "Successful"

Pair the second device

Press << and >> simultaneously for 3 seconds - prompting "pairing."

after successfully pairing with second device, reconnect the first device by hand then the second device will be successfully paired simultaneously.

*NOTE: The Big Turtle Shell® may be connected to 2 Bluetooth enabled devices simultaneously.



Pairing by NFC*

Place the NFC device over the NFC logo on the Big Turtle Shell®.

It will connect your device via bluetooth automatically.

*When bluetooth is turned off



Plug & Play - 3.5mm stereo line in

No Bluetooth? The Big Turtle Shell® also connects via 3.5mm stereo input.

Play audio from any device with a headphone jack or audio output.

WIRED

Connect via 3.5mm stereo input.

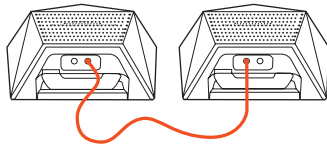
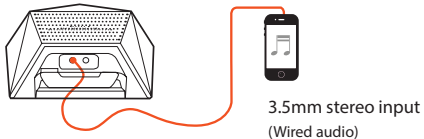

When using the Big Turtle Shell® as a speaker-phone, please note that the built-in microphone only works while connected via Bluetooth.

Your Big Turtle Shell® can wirelessly stream audio from any Bluetooth device up to 32 feet away.

Power Out:

The Big Turtle Shell® supports POWER OUT (5V 1A) and can be used as a power bank. Use your cable and charge your device via power out port.

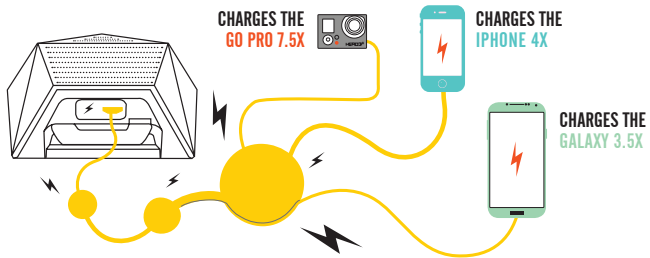

LISTEN

YOU CHOOSE

TRADITIONAL DIRECTIONAL SOUND

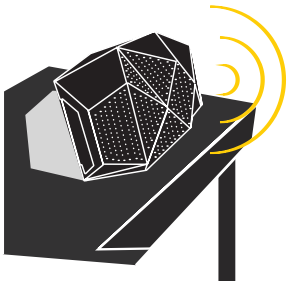

OR

360° ROOM FILLING SOUND

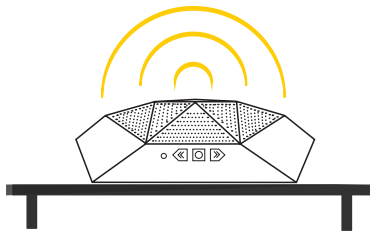

The Big Turtle Shell® is built to go anywhere, but for optimal sound quality follow the steps below:

- Make sure the Big Turtle Shell® is resting on its base and facing upwards.
- When connected wirelessly via Bluetooth, it's best to turn the volume on your phone/device fully up and when you use the volume control (<</>>) on the Big Turtle Shell®.
- When connected via 3.5mm stereo input, your phone/device may distort the audio signal if turned up too loud, turn down the volume on your phone/device before adjusting the volume on the Big Turtle Shell®.

*NOTE: 3.5mm audio input/output to another Big Turtle Shell® is supported.

TALK

The built in microphone means that the Big Turtle Shell® can be used as a wireless speaker-phone. Just speak in direction of the top grill.

*NOTE: The built-in microphone only works when connected via Bluetooth.

Answer or End Call: Press the MFB  to answer or end a call.

Decline Call: Press and hold the MFB  button for 2 seconds.

Make a Call: Use your phone to dial as usual. Listen and talk through the Big Turtle Shell®.

Redial Last Number: Press << button and MFB  simultaneously.

Mute: Hold the >> and << buttons for 2 seconds, or until you hear "mute on."

Battery Life: Music playing for 16 hours/
Standby time about 325 hours

*Battery life varies subject to different playing circumstances such as music type or volume.

Speaker: 4Ω, rated power 3W/maz power 5W x2

Input: DC14.5V 2.48A

Output: 5V/1000mA

Weight: About 2.2lbs (1020 grams)

Bluetooth Range: Up to 32 feet from device

Troubleshooting

Distortion

- Lower the volume on your Big Turtle Shell® and/or phone/device.
- Make sure its charged up. Check for low battery, then charge if necessary.

Not Loud Enough

- Turn up the volume on your phone/device or your Big Turtle Shell®.
- Make sure it's charged up.
- Plug the Big Turtle Shell® in to your phone/device via 3.5mm stereo cable.

Troubleshooting (cont.)

Unable to Pair

- Confirm your phone/device is Bluetooth compatible.
- Re-pair: Follow pairing instructions in this guide.

Signal Loss or Dropouts via Bluetooth

- Move Big Turtle Shell® closer to your phone/device.
- Make sure it's charged up.
- Turn off your Big Turtle Shell® and phone/device, then power up and reconnect.

DON'T BE SO ANTISOCIAL



Facebook.com/outdoortech
Twitter & Instagram: @outdoortech

Questions, comments, complaints, secret desires,
or just to say what's up: email info@outdoortech.com

K bye.



outdoortech.com

