

8186 SIP Horn Speaker FW Version 1.5 **Installation & Configuration**



Order Codes

8186 SIP Horn Speaker

Table of Contents

ABOUT THE ALGO 8186 SIP HORN SPEAKER.....	9
GETTING STARTED - QUICK INSTALL & TEST	10
INSTALLATION & MOUNTING	11
WEB INTERFACE.....	12
SIP PAGING: ONE SPEAKER	12
SIP PAGING: MULTIPLE SPEAKERS (USING MULTICAST)	13
SIP PAGING: MULTIPLE SPEAKERS (USING INDIVIDUAL SIP EXTENSIONS)	14
MULTICAST PAGE ZONES	15
POLYCOM™ GROUP PAGING	16
SIP RING EVENT	17
SIP ACTIVATED NOTIFICATION ALERTS.....	17
WIRING CONNECTIONS.....	17
CONNECTING INPUT DEVICES TO 8186	17
NETWORK CONNECTION	18
TERMINAL BLOCK RELAY IN	18
TERMINAL BLOCK RELAY OUT.....	18
TERMINAL BLOCK RESET	19
BLUE LED INDICATOR	19
WEB INTERFACE LOGIN	20
STATUS.....	20
BASIC SETTINGS TAB – SIP.....	21
SIP DOMAIN (PROXY SERVER).....	21
RING/ALERT MODE.....	22
RING EXTENSION	22
PAGE EXTENSION	22
AUTHENTICATION ID	22
AUTHENTICATION PASSWORD.....	22
BASIC SETTINGS TAB – FEATURES	23
RING/ALERT TONE.....	23
RING/ALERT VOLUME.....	23
RING LIMIT.....	24
PAGE SPEAKER VOLUME.....	24
PAGE MODE	24
PAGE TIMEOUT	24
PAGE TONE	24
G.722 SUPPORT.....	25
AMBIENT NOISE COMPENSATION	25
AUTOMATIC GAIN CONTROL (AGC).....	25

MULTICAST IP ADDRESSES	26
BASIC SETTINGS TAB - MULTICAST (MASTER SETTINGS)	27
MULTICAST MODE (MASTER/SENDER SELECTED)	27
NUMBER OF ZONES	28
MULTICAST TYPE	28
POLYCOM GROUP SELECTION MODE.....	28
ZONE SELECTION MODE	28
MASTER SINGLE ZONE	29
SPEAKER PLAYBACK ZONES.....	29
BASIC SETTINGS TAB - MULTICAST (SLAVE SETTINGS).....	30
MULTICAST MODE (SLAVE SELECTED).....	30
NUMBER OF ZONES	30
MULTICAST TYPE - REGULAR	31
SLAVE ZONES	31
MULTICAST TYPE – POLYCOM GROUP PAGING/PUSH-TO-TALK.....	31
ADDITIONAL FEATURES TAB – INPUT/OUTPUT	33
ALGO 1202 CALL BUTTON.....	33
ALGO 1203 CALL SWITCH.....	33
ACTION – PLAY TONE	34
ACTION - MAKE SIP VOICE CALL	35
ACTION - MAKE A SIP CALL WITH TONE.....	35
ACTION WHEN TAMPER DETECTED (SUPERVISION).....	35
SPEAKER VOLUME/MUTE	36
CALL BUTTON	36
DIALING EXTENSION	36
INTERVAL BETWEEN TONES	36
MAXIMUM TONE DURATION.....	36
CALL MODE.....	36
OUTBOUND RING LIMIT	37
RINGBACK TONE	37
MAXIMUM CALL DURATION.....	37
OUTPUT LIGHT	37
HEARTBEAT LIGHT.....	37
OUTPUT RELAY.....	37
ADDITIONAL FEATURES TAB – EMERGENCY ALERTS	38
ADDITIONAL FEATURES TAB – MORE PAGE EXTENSIONS.....	40
ADDITIONAL FEATURES TAB – MORE RING EXTENSIONS	42
ADVANCED SETTINGS TAB - NETWORK.....	43
PROTOCOL	43
VLAN MODE.....	43
VLAN ID	44
VLAN PRIORITY	44
DIFFERENTIATED SERVICES (6-BIT DSCP VALUE)	44

ADVANCED SETTINGS TAB – ADMIN	45
PASSWORD.....	45
CONFIRMATION	46
DEVICE NAME (HOSTNAME).....	46
INTRODUCTION SECTION ON STATUS PAGE	46
WEB INTERFACE SESSION TIMEOUT.....	46
PLAY TONE AT STARTUP	46
LOG LEVEL.....	46
LOG SIZE	46
LOG METHOD	46
LOG SERVER	46
WEB INTERFACE PROTOCOL	47
FORCE STRONG PASSWORD.....	47
ALLOW SECURE SIP PASSWORD	47
SNMP SUPPORT (v1 GET ONLY)	47
SA-ANNOUNCE SUPPORT	47
SA-ANNOUNCE SERVER	48
LOCAL MANAGEMENT PORT.....	48
ADVANCED SETTINGS TAB – TIME	49
TIME ZONE	49
NTP TIME SERVERS 1/2/3/4.....	49
NTP TIME SERVER SOURCE	49
DEVICE DATE/TIME	49
ADVANCED SETTINGS TAB – PROVISIONING	51
MD5 CHECKSUM.....	52
GENERATING A GENERIC CONFIGURATION FILE	52
ADVANCED SETTINGS TAB – TONES	54
UPLOADING CUSTOM AUDIO FILES	54
TONE FILES INCLUDED IN MEMORY	55
ADVANCED SETTINGS TAB – ADVANCED AUDIO	56
DYNAMIC RANGE COMPRESSION (DRC)	56
DYNAMIC RANGE COMPRESSION GAIN	56
ALWAYS SEND RTP MEDIA	56
SPEAKER FILTER G.711	57
MICROPHONE FILTER G.711	57
SPEAKER FILTER G.722	57
MICROPHONE FILTER G.722	57
SPEAKER NOISE FILTER	57
MICROPHONE NOISE FILTER	57
ADVANCED SETTINGS TAB – ADVANCED SIP	58
OUTBOUND PROXY	58
STUN SERVER	58
REGISTER PERIOD (SECONDS).....	58
KEEP-ALIVE METHOD	59

DIFFERENT PORTS FOR EXTENSIONS	59
SERVER REDUNDANCY FEATURE	59
BACKUP SERVER #1.....	59
BACKUP SERVER #2.....	59
POLLING INTERVALS (SECONDS).....	59
POLL ACTIVE SERVER	59
AUTOMATIC FAILBACK	60
POLLING METHOD	60
ADVANCED SETTINGS TAB – ADVANCED MULTICAST.....	61
AUDIO SYNC (SLAVE MODE)	61
MASTER OUTPUT CODEC (MASTER MODE)	62
MASTER OUTPUT PACKETIZATION TIME (MASTER MODE)	62
ZONE DEFINITION	62
PAGE TONE AND PAGE VOLUME.....	62
POLYCOM SLAVE TONES	63
SYSTEM TAB - MAINTENANCE.....	64
DOWNLOAD CONFIGURATION FILE.....	64
RESTORE CONFIGURATION FILE	64
RESTORE CONFIGURATION TO DEFAULTS	64
REBOOT THE DEVICE	64
METHOD.....	65
FIRMWARE IMAGE	65
MD5 CHECKSUM.....	65
SYSTEM – SYSTEM LOG	65
SPECIFICATIONS	66
FCC COMPLIANCE STATEMENT	68

Important Safety Information

This product is powered by a certified limited power source (LPS), Power over Ethernet (PoE); through CAT5 or CAT6 connection wiring to an IEEE 802.3af compliant network PoE switch. The product is intended for installation indoors or on outdoor perimeter of a building. If used in an outdoor environment, additional protective measures must be taken according to the installation manual. All wiring connections to the product must be in the same building. If the product is installed beyond the building perimeter or used in an inter-building application, the wiring connections must be protected against overvoltage / transient. Algo recommends that this product be installed by a qualified electrician.

If you are unable to understand the English language safety information then please contact Algo by email for assistance before attempting an installation support@algosolutions.com.

Consignes de Sécurité Importantes

Ce produit est alimenté par une source d'alimentation limitée certifiée (alimentation par Ethernet); des câbles de catégorie 5 et 6 joignent un commutateur réseau à alimentation par Ethernet homologué IEEE 802.3af. Le produit est conçu pour être installé à l'intérieur ou dans une zone adjacente à un édifice; selon le manuel d'installation, des mesures de sécurité additionnelles s'avèrent alors nécessaires. Tout le câblage rattaché au produit doit se trouver dans le même édifice. Si le produit est installé au-delà du périmètre de l'édifice ou utilisé pour plusieurs édifices, le câblage doit être protégé des surtensions transitoires. Algo recommande qu'un électricien qualifié se charge de l'installation de ce produit.

Si vous ne pouvez comprendre les consignes de sécurité en anglais, veuillez communiquer avec Algo par courriel avant d'entreprendre l'installation au support@algosolutions.com.

Información de Seguridad Importante

Este producto funciona con una fuente de alimentación limitada (Limited Power Source, LPS) certificada, Alimentación a través de Ethernet (Power over Ethernet, PoE); mediante un cable de conexión CAT5 o CAT6 a un conmutador de red con PoE en cumplimiento con IEEE 802.3af. El producto se debe instalar en lugares cerrados o en el perímetro de un edificio al aire libre. Si se utiliza en un ambiente al aire libre, se deben tomar medidas de protección adicionales de acuerdo con el manual de instalación. Todas las conexiones cableadas al producto deben estar en el mismo edificio. Si el

producto se instala fuera del perímetro del edificio o se utiliza en una aplicación en varios edificios, las conexiones cableadas se deben proteger contra sobretensión o corriente transitoria. Algo recomienda que la instalación de este producto la realice un electricista calificado.

Si usted no puede comprender la información de seguridad en inglés, comuníquese con Algo por correo electrónico para obtener asistencia antes de intentar instalarlo: support@algosolutions.com.

Wichtige Sicherheitsinformationen

Dieses Produkt wird durch eine zertifizierte Stromquelle mit begrenzter Leistung (LPS – Limited Power Source) betrieben. Die Stromversorgung erfolgt über Ethernet (PoE – Power over Ethernet). Dies geschieht durch eine Cat-5-Verbindung oder eine Cat-6-Verbindung zu einer IEEE 802.3af-konformen Ethernet-Netzwerkweiche. Das Produkt wurde konzipiert für die Installation innerhalb eines Gebäudes oder außerhalb eines Gebäudes. Bei der Anwendung außerhalb eines Gebäudes müssen zusätzliche Schutzmaßnahmen gemäß der Gebrauchsanweisung durchgeführt werden. Alle Kabelverbindungen zum Produkt müssen im selben Gebäude bestehen. Wenn das Produkt jenseits des Gebäudes oder für mehrere Gebäude genutzt wird, müssen die Kabelverbindungen vor Überspannung und Spannungssprüngen geschützt werden. Algo empfiehlt das Produkt von einem qualifizierten Elektriker installieren zu lassen.

Sollten Sie die englischen Sicherheitsinformationen nicht verstehen, kontaktieren Sie bitte Algo per Email bevor Sie mit der Installation beginnen, um Unterstützung zu erhalten. Algo kann unter der folgenden E-Mail-Adresse erreicht werden: support@algosolutions.com.

安全须知

本产品由认证的受限电源（LPS），以太网供电（PoE），通过CAT5或CAT6线路联接至IEEE 802.3af兼容的PoE网络交换机供电。本产品适用于室内或建筑物周边安装。如用于室外环境，必须按照安装手册采用附加的保护措施。所有联接本产品的线路必须源自同一建筑物。本产品如需用于超出建筑物周边范围或跨建筑物的安装，线路联接部分必须有过压和瞬态保护。Algo建议本产品由专业电工安装。

如果您对理解英文版安全须知有问题，安装前请通过电子邮件和Algo联系，support@algosolutions.com。

Important Safety Information

CAUTION

The 8186 Horn Speaker is capable of output levels in excess of 120dB at 1 meter. Ensure nobody is in close proximity to the horn, especially during installation and testing of the product.

INSTALLATION

The 8186 Horn Speaker should only be installed by a qualified electrician. An improperly installed 8186 could fall from the wall or ceiling and cause serious injury or death.

Local building codes may require one or more additional safety measures, particularly in earthquake prone regions.

EMERGENCY COMMUNICATION

If used in an emergency communication application, the 8186 Horn Speaker should be routinely tested. SNMP supervision is recommended for assurance of proper operation. Contact Algo for other methods of operational assurance including the use of the integrated microphone for automated "sound to air" acoustic testing.

WET OR OUTDOOR ENVIRONMENTS

The 8186 Horn Speaker is intended for indoor or outdoor locations and may be subjected to spray or weather provided the rear wiring cavity is properly sealed to prevent water ingress.

Gaskets included with the 8186 Horn Speaker may be effective against water ingress on some, but not all surfaces in which case additional protective measures must be taken such as a perimeter sealant.

CAT5 or CAT6 connection wiring to an IEEE 802.3af compliant network PoE switch must not leave the building perimeter without adequate lightning protection.

Relay input and output connections must not leave the building perimeter without adequate lightning protection.

About the Algo 8186 SIP Horn Speaker

The 8186 SIP Horn Speaker is a SIP compliant and multicast capable IP speaker suitable for voice paging, loud ringing, and alert/notification applications, particularly wide-area and/or high noise environments (e.g. warehouse, factory). When installed properly, the 8186 can be used for outdoor applications.

An integrated microphone provides talkback capability and ambient noise detection for automatic level control.

Dual SIP extensions provide both voice paging and notification (ring) capability. One or both extensions can be registered with any Communication Server (hosted or enterprise) that supports 3rd party SIP Endpoints.

Multiple speakers in a SIP environment require only one speaker to register as a SIP extension. Multicasting capabilities allow the SIP registered speaker to ring/page and simultaneously stream multicast audio to the other speakers. Any number and variety of Algo speakers, paging adapters, and strobes can be configured in a multicast.

The 8186 SIP Horn Speaker is configured using central provisioning features or by accessing a web interface using browsers such as Google Chrome, Firefox, or Internet Explorer.

What is Included

- 8186 SIP Horn Speaker
- Mounting bracket
- Gaskets

What is not Included

- Optional Call Button/Wall Switch (Algo 1202 or 1203)
- This Installation Guide (www.algosolutions.com/8186/guide)

Getting Started - Quick Install & Test



This guide provides important safety information which should be read thoroughly before permanently installing the speaker.

1. Connect the 8186 SIP Horn Speaker to an IEEE 802.3af compliant PoE network switch. The blue LED will remain on until boot up is completed – about 30 seconds.
2. After the blue light turns off, connect the reset terminals on the back of the unit to hear the IP address over the speaker. The IP address may also be discovered by downloading the Algo locator tool to find Algo devices on your network: www.algosolutions.com/locator
3. Mount the speaker per the instructions in this guide.
4. Access the 8186 SIP Horn Speaker web page by entering the IP address into a browser (Chrome, IE, Firefox etc.) and login using the default password **algo**.
5. Enter the IP address for the SIP server into the SIP Domain field under the **BASIC SETTINGS > SIP** tab.
6. Enter the page SIP extension and password. (Note the speaker supports two types of SIP extensions. The page extension auto-answers for voice page announcements. The ring extension plays an audio WAV file over the speaker without answering.)
7. Make a call to the speaker by dialling the page SIP extension from a telephone. The speaker should auto-answer, play the default pre-announce audio file, and open a speech path.

Installation & Mounting

The 8186 SIP Horn Speaker can be wall or ceiling mounted. Concealed wiring may enter from the wall into the wiring cavity. Alternatively, surface wiring may enter through a channel from the bottom edge. The channel is intended for cabling 0.2" or 5mm in diameter and is intentionally snug to protect against moisture ingress.

The 8186 SIP Horn Speaker can be mounted in any orientation but both the bracket and housing identify TOP. This keeps the bracket wiring channel on the bottom and the RJ45 jack on the top side.

The mounting plate may be used to mount over flush or surface mounted electrical boxes or mud rings and fits securely to a 2 gang electrical box (not included) for installation with wiring conduit.

The 8186 SIP Horn Speaker is rated IP65 for wet locations however care must be taken to ensure that water does not enter the wiring cavity. The supplied gaskets or sealant must be used to protect the wiring cavity in wet environments. In dry indoor environments the gaskets are not required. If the wall gasket is used with surface wiring then the gasket should be attached after placing the cable into the wiring channel.

The 8186 SIP Horn Speaker should not be installed beyond a building perimeter without adequately protecting the building wiring from lightning surges.

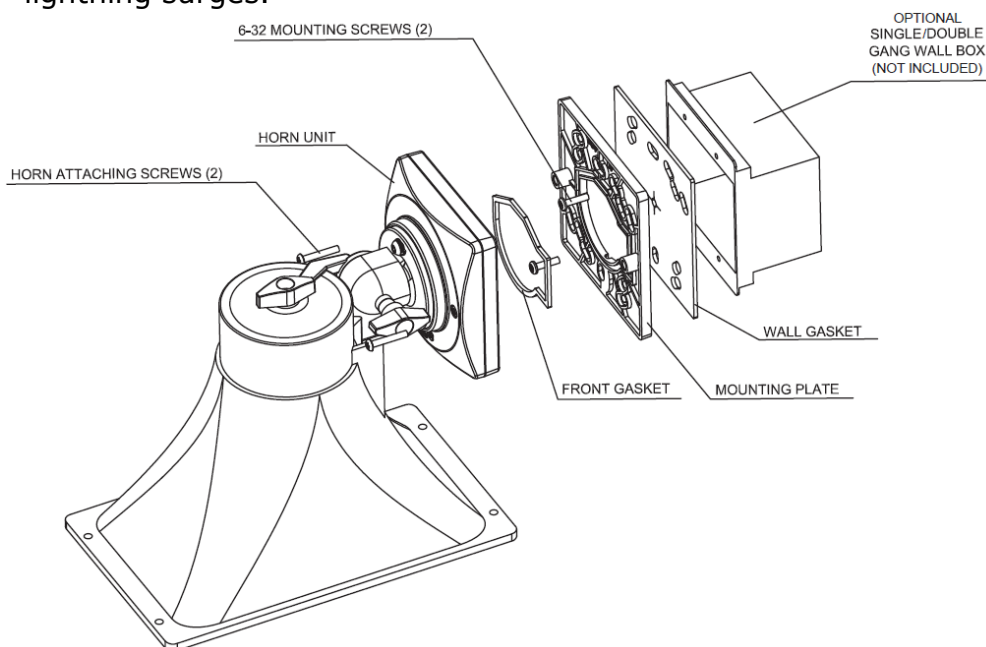

Web Interface

The 8186 SIP Horn Speaker is configurable using the web interface or provisioning features.

After boot up the blue light will turn off and the speaker will have obtained an IP address. If there is no DHCP server the 8186 SIP Horn Speaker will default to the static IP address **192.168.1.111**.

Connect and hold the reset terminals (on the back of the unit) to hear the IP address over the speaker. The reset terminals will not cause a reset unless connected during power up.

The IP address may also be discovered by downloading the Algo locator tool to find Algo devices on your network:

www.algosolutions.com/locator

Enter the IP address (e.g. 192.168.1.111) into a browser such as Google Chrome, Firefox, or Internet Explorer (other than IE9). The web interface should be visible and the default password will be **algo** in lower case letters.

SIP Paging: One Speaker

The 8186 SIP Horn Speaker can be registered as a third party SIP extension with a hosted or enterprise Communications Server supporting 3rd party SIP endpoints.

To register the speaker with the SIP server, use the **Basic Settings → SIP** tab in the web interface to enter the Communication Server IP address, extension, username, and password. This information will be available from the IT Administrator.

If VLAN is used, navigate to the **Advanced Settings → Network** tab to set VLAN options.

(Note, once the speaker is using VLAN you will need to be on the same VLAN to access the web interface.)

The speaker may now be accessed by dialling its assigned extension from a telephone, device, or client. The speaker will auto-answer, play the default WAV pre-announce tone, and allow voice paging until disconnected.

There are a number of configurable speaker options:

- Increase or Decrease Speaker Volume
- Enable AGC (automatic gain control)
- Enable Ambient Noise Monitoring (speaker volume adapts to background noise)
- Enable Talkback
- Customize pre-announce tone WAV file

The best voice paging quality and intelligibility will be obtained using the G.722 wideband audio codec. Most current IP telephones support G.722 which is sometimes referred to as "HD" voice or audio.

SIP Paging: Multiple Speakers (Using Multicast)

Multicast features in the 8186 SIP Horn Speaker require that only ONE of the speakers be registered as a SIP extension. Additional speakers may be added as multicast Slaves receiving a stream from the SIP registered Master speaker. Please note that any number and combination of Algo speakers, paging adapters and strobes can be part of a multicast.

The Master speaker will page normally while simultaneously streaming audio to the Slave speakers. The Slave speakers do not require SIP extensions and do not need to register with the SIP Communication Server.

To enable multicast streaming from the SIP speaker, go to its web interface and navigate to the **Basic Settings → Multicast** tab. Choose multicast mode "**Master/Sender**" and zone "**All Call**". The multicast addresses pre-populated in the table will work in most cases.

To enable multicast monitoring in the other speakers, go to the web interface for each speaker and again navigate to the **Basic Settings → Multicast** tab. This time though, choose multicast mode "**Slave/Receiver**". There is no need to select a zone as the speaker will automatically monitor the "**All Call**" zone IP address.

The page pre-announce tone is generated from the Master. The following options are valid for each multicast Slave speaker:

- Increase or Decrease Speaker Volume
- Enable Ambient Noise Monitoring (speaker volume adapts to background noise)

Talkback can only be used for the SIP registered Master speaker. When paging with talkback enabled, only the area near the Master speaker is covered for talkback. The microphones in the multicast/Slave speakers are disabled except for ambient noise monitoring.

SIP Paging: Multiple Speakers (Using Individual SIP extensions)

In some cases it may be desirable for every speaker to have a SIP extension. Multicast may still be used to page multiple speakers but each speaker can also be called individually or generate a call when appropriately configured.

A speaker configured as a SIP Multicast Slave will give its highest priority to a page using its SIP extension.

Communication Servers with the capability of dialling many SIP extensions simultaneously for paging may be able to create zones by calling "page groups" in order to page telephone speakers in conjunction with overhead speakers.

Multicast Page Zones

The 8186 SIP Horn Speaker supports nine “basic” multicast zones. These zones are defined by the multicast IP addresses.

Somewhat arbitrarily, these zones are defined below but may be used in other ways. The important consideration is that there is a priority hierarchy – streaming activity on a zone higher on the list will be treated as a higher priority than a zone lower on the list – with music being the lowest priority.

- Priority
- All Call
- Zone 1
- Zone 2
- Zone 3
- Zone 4
- Zone 5
- Zone 6
- Music

There are two options for Paging to multiple zones: “DTMF Selectable Mode” or via multiple page extensions.

The “DTMF Selectable Mode” offers a dynamic page zone selection and requires only the master device to have a registered SIP Extension. To page, dial the SIP extension of the master device and then dial the desired DTMF page zone (e.g. 1, 2, etc.) on the keypad.

Note: DTMF codes for zones 10 and higher start with an “”.*

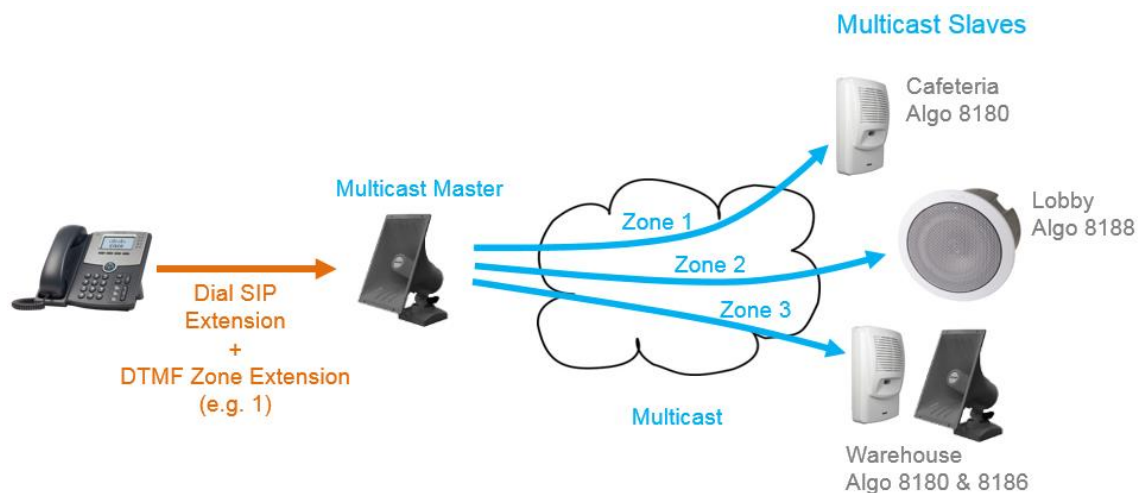

Alternatively, multiple SIP extensions can be registered on the master device. Each extension is mapped to a unique zone, allowing zones to be called directly (for instance from speed-dial keys) without the use of DTMF. See "Additional Features > More Page Extensions".

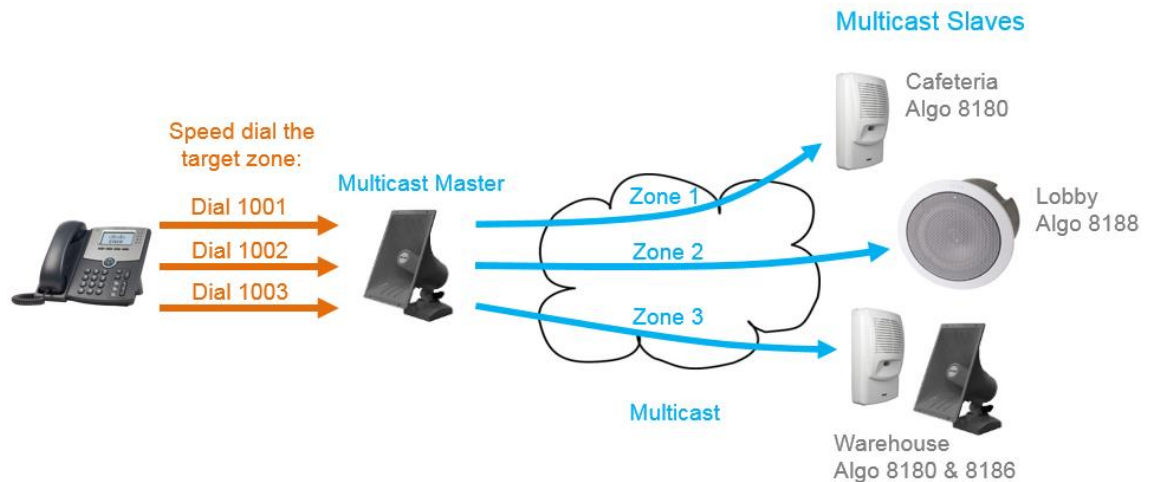

"Expanded" zones can also be enabled in the "Basic Settings > Multicast" tab, allowing up to 50 zones in total. These have the same behaviours as the basic zones, but are hidden by default to simplify the interface.

Polycom™ Group Paging

The 8186 SIP Horn Speaker has been designed to support Polycom Group Paging.

The 8186 SIP Horn Speaker can be added to a Polycom Group Page so that voice paging is heard over Polycom telephone speakers and overhead paging simultaneously.

Polycom Group Paging can be configured on the **Basic Settings** → **Multicast** tab.



The 8186 SIP Horn Speaker may be accessed remotely via SIP and may generate a multicast page within the LAN sending voice page to both Algo paging speakers and Polycom telephones. Audio delay may be added to the 8186 SIP Horn Speaker to synchronize with voice page over the Polycom telephone speakers.

SIP Ring Event

Set Monitoring Mode to "Monitor Ring". When a call is made to the SIP extension the 8186 SIP Horn Speaker will play the selected WAV file from memory. Often, the 8186 SIP Horn Speaker will be part of a hunt group or ring group to ring in conjunction with a telephone.

SIP Activated Notification Alerts

In addition to voice paging, the 8186 SIP Horn Speaker can play audio files for emergency, safety, and security announcements, customer service, shift changes, etc.

Audio WAV files can be stored in speaker memory and played over the speaker in response to ring or input relay, and also multicast to other Algo SIP endpoints on the network. See "Additional Features > Emergency Alerts" and "Additional Features > Input/Output" for more details.

Wiring Connections

Connecting Input Devices to 8186

The input relay to the 8186 SIP Horn Speaker can be prompted by any normally open or normally closed switch, as well as the Algo 1202 Call Button or Algo 1203 Call Switch. The input switches can be connected to the back of the 8186 SIP Horn Speaker via a Terminal Block Relay In.

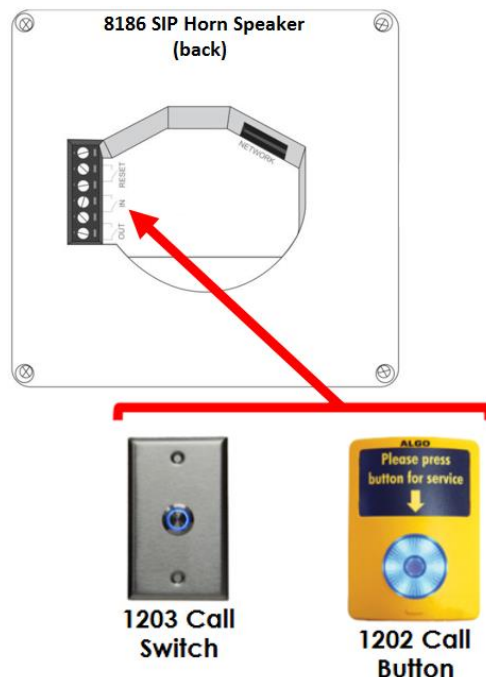

1202 Call Button: A pair of wires from the terminal block on the back of the 8186 SIP Horn Speaker can connect to the **centre pair** of the modular connector at the back of the Call Button.

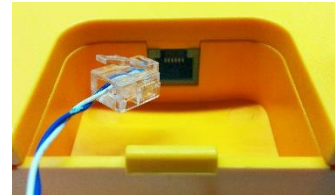

1203 Call Switch: A pair of wires can be run from the back of the device via a screw output connector to the 8186 SIP Horn Speaker via the Relay In.



Network Connection

Connect RJ45 jack from PoE network switch or non-PoE network and 48V 350 mA IEEE 802.3af compliant power injector.

There are two lights on the Ethernet jack:

Green light: On when Ethernet is working, flickers off to indicate activity on the port.

Amber light: Off when successful 100Mbps link is established. Typically on only briefly at power up.

Under normal conditions, the Amber light will turn on immediately after the Ethernet cable is first connected. This indicates that PoE power has been successfully applied. Once the device connects to the network, it will switch to the Green light instead, which will typically flicker indicating traffic on the network.

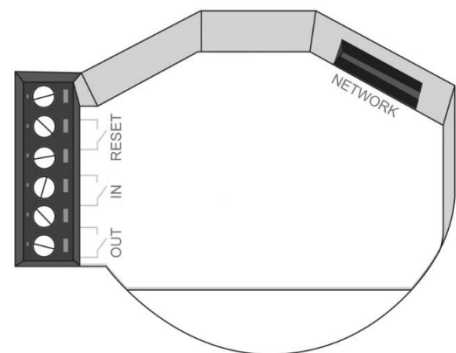

Terminal Block Relay In

By default, these terminals are inactive. Connection options are a normally closed switch, normally open switch, 1202 Call Button, 1203 Call Switch, or EOL resistor termination.

Terminal Block Relay Out

By default these terminals provide a contact closure when the 8186 SIP Horn Speaker is active.

Terminal Block Reset

A terminal block reset on the back of the unit can only be used to reset the 8186 SIP Horn Speaker at time of power up. To reset, reboot or power cycle the 8186 SIP Horn Speaker. Wait until the blue LED flashes, then connect the reset terminals and hold until the blue LED begins a double flash pattern. Release the reset connection and allow the unit to complete its boot process. **Do not connect the reset terminals until the blue LED begins flashing.**

A reset will set all configuration options to factory default including the password.

Once booting has completed, connecting the reset terminals will cause the speaker to announce its IP address over the speaker.

Blue LED Indicator

The blue LED by default will be on when the speaker is active. The blue LED will also be on during power up and boot process.

The blue LED can also provide a heartbeat with a flash every 60 seconds to indicate that the speaker is powered and connected to the network.

If the 8186 SIP Horn Speaker is in talkback mode the blue LED will be flashing.

Web Interface Login

The web interface requires a password which is "**algo**" by default. This password can be changed using the *Admin* tab after logging in the first time.



Status

The device's Status page will be available before and after log on. The section can be used to check 8186's SIP Registration status of the Ring/Page extensions, Call Status, Multicast Mode (Slave/Master), Relay Input Status, Proxy Status, and general MAC, IP, Netmask, Date/Time, and Timezone information.

Basic Settings Tab – SIP

SIP Server information and Credentials should be obtained from your telephone system administrator or hosted account provider. After saving the settings, see the Status tab to confirm the registration was successful.

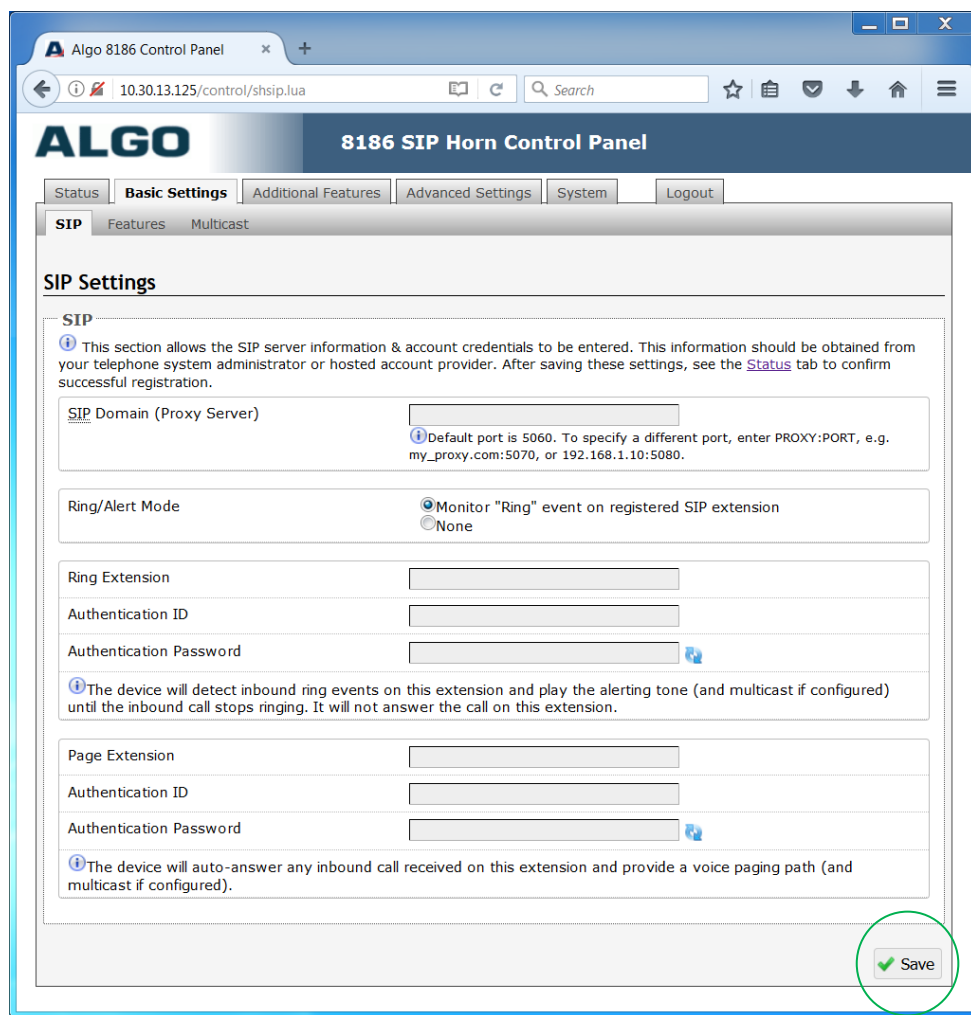

Note: Any time changes are made to settings in the Web Interface the "Save" key must be clicked to save the changes

SIP Domain (Proxy Server)

SIP Server Name or IP Address.

Ring/Alert Mode

Option for adding a second SIP extension for ring detection and playing WAV file. If activated, screen expands to enter second SIP extension parameters.

Ring Extension

This is the SIP extension for the 8186 SIP Horn Speaker's Ring parameter. The device will detect inbound ring events on this extension and play the alerting tone (and multicast if configured) until the inbound call stops ringing. It will not answer the call on this extension.

Page Extension

This is the SIP extension for the 8186 SIP Horn Speaker's Page parameter. The device will auto-answer any inbound call received on this extension and provide a voice paging path (and multicast if configured).

Authentication ID

May also be called Username for some SIP servers and in some cases may be the same as the SIP extension used for the associated Ring and/or Page parameter.

Authentication Password

SIP password provided by the system administrator for the SIP account used for the associated Ring and/or Page parameter.

Basic Settings Tab – Features

Status	Basic Settings	Additional Features	Advanced Settings	System	Logout
SIP	Features	Multicast			
Features					
Inbound Ring Settings					
<small>ⓘ These settings apply to events triggered by the Ring Extension(s) & Emergency Alerts sections. The Play/Loop/Stop buttons can also be used to test the device and set the appropriate volume level.</small>					
Ring/Alert Tone	warble2-med.wav	Play	Loop	Stop	
Ring/Alert Volume	4	Apply	<small>⚠ Caution: The 8186 Horn Speaker is capable of output levels in excess of 120dB at 1 meter. Ensure nobody is in close proximity to the horn, especially during installation and testing of the product.</small>		
Ring Limit	No limit	<small>ⓘ 1 ring = 6 seconds.</small>			
Inbound Page Settings					
Page Speaker Volume	4	Apply			
Page Mode	<input checked="" type="radio"/> One-way <input type="radio"/> Two-way <input type="radio"/> Delayed <small>ⓘ "Delayed" mode stores the page audio temporarily, and then broadcasts it after the call is hung-up. This can help avoid feedback.</small>				
Page Timeout	5 minutes	<small>ⓘ Maximum page timeout in Delayed mode is 5 minutes.</small>			
Page Tone	<Default> <small>ⓘ Use only Default, or custom uploaded file. The other pre-installed tone files all contain silence at the end in order to generate ring "cadence" of 6 seconds. This silence will block the voice path for several seconds at the start of a page.</small>				
G.722 Support	<input checked="" type="radio"/> Enabled <input type="radio"/> Disabled				
Audio Processing					
Ambient Noise Compensation	<input type="radio"/> Enabled <input checked="" type="radio"/> Disabled <small>ⓘ Automatically adjust speaker level in response to ambient noise level detected at the device prior to start of each call.</small>				
Automatic Gain Control (AGC)	<input checked="" type="radio"/> Enabled <input type="radio"/> Disabled <small>ⓘ Automatically maximize level of voice received from calling phone in order to make page volume more consistent.</small>				
<input checked="" type="checkbox"/> Save					

Ring/Alert Tone

Select WAV file to play when a ring event is detected on the ring SIP extension. The WAV file may be played immediately to an associated speaker from the web interface for test purposes using the Play, Loop, and Stop buttons. During multicast, the device will broadcast an audio stream using the master's selected ring tone.

Note: This is the "Default" tone that will be played if selected for Multicast, Additional Ring Extension settings.

Ring/Alert Volume

Set speaker volume for SIP ring event. This setting is an amplifier gain control and the output level will also depend on the levels

recorded into the source WAV file played from memory. This setting is only used for local tones, and not when receiving multicast (see Page Speaker Volume below).

Caution: The 8186 SIP Horn Speaker is capable of output levels in excess of 120dB at 1 meter. Ensure nobody is in close proximity to the horn, especially during installation and testing of the product.

Ring Limit

Typically set to no limit, this feature can be used to set a limit on how long the speaker will ring before timing out. A new ring event is required before the speaker will play the WAV file again.

Page Speaker Volume

Speaker page volume control for SIP or multicast paging. This setting is an amplifier gain control and output level will depend on streaming level. This setting will apply to all multicast, regardless of content.

Page Mode

A call to the SIP page extension can be one way, two way using the integrated microphone, or delayed. In delay mode, the speaker will store the page into memory and then play after disconnect.

In delay mode, press "" to cancel a page while the recording state is in process to prevent it from being sent after hanging up.*

Page Timeout

A time limit may be set for an active page.

Page Tone

Select pre-announce tone for paging. Use only Default, or custom uploaded file. The other pre-installed tone files all contain silence at the end in order to generate ring "cadence" of 6 seconds. This silence will block the voice path for several seconds at the start of a page. The "Default" tone will play the page-notif.wav file.

Note: The "Default Page Tone", in Advanced Multicast, will play the tone set here.

G.722 Support

Enable or disable the G.722 codec.

Ambient Noise Compensation

To configure, set the volume to an appropriate level for a quiet environment and enable the Ambient Noise Compensation. The integrated microphone will measure the ambient noise during idle periods and automatically increment the speaker volume, if any increase in background noise is detected. Ambient noise level is averaged over 10 seconds. The noise compensation will not be functional when playing background music.

Automatic Gain Control (AGC)

Normalizes the audio level. Automatically maximize level of voice received from calling phone in order to make page volume more consistent.

Multicast IP Addresses

Each 8186 SIP Horn Speaker has its own IP address, and shares a common multicast IP and port number (multicast zone) for multicast packets. The master speaker transmits to a configurable multicast zone, and the slave units listen to all the multicast zones assigned to them.

The network switches and router see the packet and deliver it to all the members of the group. The multicast IP and port number must be the same on all the master and slave units of one group. The user may define multiple zones by picking different multicast IP addresses and/or port numbers.

1. Multicast IP addresses range: 224.0.0.0/4
(from 224.0.0.0 to 239.255.255.255)
2. Port numbers range: 1 to 65535
3. By default, the 8186 SIP Horn Speaker is set to use the multicast IP address 224.0.2.60 and the port numbers 50000-50008

Make sure that the multicast IP address and port number do not conflict with other services and devices on the same network

Basic Settings Tab - Multicast (Master Settings)

Status
Basic Settings
Additional Features
Advanced Settings
System
Logout

SIP
Features
Multicast

Multicast Settings

Multicast Mode

Multicast Mode None Master/Sender Slave/Receiver
Enter Multicast Zone Definitions can be found in 'Advanced Settings > Advanced Multicast'.

Number of Zones Basic Zones Only Basic and Expanded Zones

Polycom Group Paging/Push-to-Talk

Multicast Type Regular (RTP) Polycom Group Page Polycom Push-to-Talk Regular RTP + Polycom Group Page Regular RTP + Polycom Push-to-Talk
Regular mode uses RTP audio packets compatible with all Algo SIP endpoints, and most multicast-enabled phones.

Polycom Zone
Enter the same Multicast IP Address & Port number as configured on the Polycom phones.

Polycom Group Selection Mode DTMF Selectable Group Single Group

Polycom Default Channel

Master/Sender Zone Settings

Zone Selection Mode DTMF Selectable Zone Single Zone
For additional capabilities allowing unique SIP extensions per zone, see 'Additional Features > More Page Extensions'.

Zone Selection Tone

Master Single Zone
If 'DTMF Selectable Zone' is selected above, then this single zone setting will not apply to Paging (since the zone can now be dynamically selected per call using DTMF), but it will still apply to the Ring Extension and Relay triggered events.

Speaker Playback Zones Priority Call All Call Music
 Zone 1 Zone 2 Zone 3
 Zone 4 Zone 5 Zone 6
Allows master device to play audio for selected zones only. This is useful if using DTMF Selectable Zone mode (or More Page Extensions per zone) and wishing to make the Master unit a member of only certain zones.

Expanded Speaker Playback Zones
 Zone *10 Zone *11 Zone *12 Zone *13 Zone *14
 Zone *15 Zone *16 Zone *17 Zone *18 Zone *19
 Zone *20 Zone *21 Zone *22 Zone *23 Zone *24
 Zone *25 Zone *26 Zone *27 Zone *28 Zone *29
 Zone *30 Zone *31 Zone *32 Zone *33 Zone *34
 Zone *35 Zone *36 Zone *37 Zone *38 Zone *39
 Zone *40 Zone *41 Zone *42 Zone *43 Zone *44
 Zone *45 Zone *46 Zone *47 Zone *48 Zone *49
 Zone *50

Save

Multicast Mode (Master/Sender Selected)

If master is enabled the 8186 SIP Horn Speaker will broadcast an IP stream when activated in addition to playing the audio over its own speaker. (Note that the 8186 SIP Horn Speaker cannot be both a multicast Master and Slave simultaneously).

Number of Zones

Select "basic" zones if configuring nine or fewer multicast zones or "expanded" to configure up to 50 zones. The expanded zones have the same behaviour as the basic Slave zones, but are hidden by default to simplify the interface.

Multicast Type

The 8186 SIP Horn Speaker may broadcast multicast paging, compatible with Polycom "**on premise group paging**" protocol and most multicast-enabled phones that use RTP audio packets.

Select "Regular" if solely multicasting to Algo SIP endpoints and/or multicast-enabled phones.

To multicast page announcements solely to Polycom phones, select "Polycom Group Page" or "Push-to-Talk". Then, configure the 8186 with "Polycom Zone" (IP Address and Port) and "Polycom Default Channel". *Always ensure that the multicast settings on all Slaves match those of the Master.*

Select "Regular RTP + Polycom Group Page/Push-to-Talk" to multicast page audio to both Polycom phones, Algo SIP endpoints, and multicast-enabled phones.

Polycom Group Selection Mode

"Single Zone" always broadcasts on one pre-configured Polycom Group. In "DTMF Selectable Zone" mode, the group is determined by the DTMF selection between 1 and 25.

Note: DTMF codes for groups 10 and higher start with an "".*

Zone Selection Mode

"Single Zone" always broadcasts on one IP address. In "DTMF Selectable Zone" mode, the IP address is determined by the zone selected. The DTMF zone definitions can be found in the "Advanced Settings > Advanced Multicast" tab. For more information see pages 15-16.

Note: DTMF codes for zones 10 and higher start with an "".*

Master Single Zone

IP address for multicast broadcast. If “DTMF Selectable Zone” is chosen above, this setting will not apply to Paging, since the zone can now be dynamically selected per call via DTMF. However, the specified “Master Single Zone” setting is still used for any multicast events triggered by the Ring, analog input, or the relay input.

Speaker Playback Zones

Allows Master device to play audio for selected zones only. This is useful if using DTMF Selectable Zone mode (or More Page Extensions per zone) and wishing to make the Master unit a member of only certain zones.

Basic Settings Tab - Multicast (Slave Settings)

The screenshot displays the 'Multicast Settings' configuration page. At the top, there are navigation tabs: Status, Basic Settings (selected), Additional Features, Advanced Settings, System, and Logout. Below these are sub-tabs: SIP, Features, and Multicast (selected). The main content area is titled 'Multicast Settings' and is divided into several sections:

- Multicast Mode:** Includes radio buttons for 'None', 'Master/Sender', and 'Slave/Receiver' (selected). A help icon indicates that Multicast Zone Definitions can be found in 'Advanced Settings > Advanced Multicast'.
- Number of Zones:** Includes radio buttons for 'Basic Zones Only' and 'Basic and Expanded Zones' (selected).
- RTP Extension Header:** Includes radio buttons for 'Enabled' and 'Disabled' (selected).
- Polycom Group Paging/Push-to-Talk:** Includes radio buttons for 'Regular (RTP)' (selected), 'Polycom Group Page', and 'Polycom Push-to-Talk'. A help icon notes that Regular mode uses RTP audio packets compatible with all Algo SIP endpoints, and most multicast-enabled phones.
- Slave/Receiver Zone Settings:**
 - Basic Slave Zones:** Includes checkboxes for 'Priority Call' (checked), 'All Call' (checked), and 'Music'. Below are checkboxes for 'Zone 1' through 'Zone 6', with 'Zone 1' checked.
 - Expanded Slave Zones:** A grid of checkboxes for zones *10 through *50, all currently unchecked.
 - Buttons for 'Select All' and 'Clear All' are located below the grid.

A 'Save' button with a green checkmark is located at the bottom right of the form.

Multicast Mode (Slave Selected)

If slave is enabled the 8186 SIP Horn Speaker will activate when receiving a multicast message. Will mimic Master audio stream, but use local volume settings ("Page Speaker Volume" in "Basic Settings > Features").

Number of Zones

Select "basic" zones if configuring nine or fewer multicast zones or "expanded" to configure up to 50 zones. The expanded zones have the same behaviour as the basic slave zones, but are hidden by default to simplify the interface.

Multicast Type - Regular

Select "Regular" if solely multicasting to Algo SIP endpoint(s) and/or multicast-enabled phone(s) that use RTP audio packets.

Slave Zones

Select one or more multicast zones for the 8186 SIP Horn Speaker to monitor. Note that multicast zone priority is based on the zone definition list order (top to bottom).

Multicast Type – Polycom Group Paging/ Push-to-Talk

The 8186 SIP Horn Speaker may receive multicast paging compatible with Polycom **"on premise group paging"** protocol.

To configure the 8186 as a slave to play Polycom page announcements, select "Group Page" or "Push-to-Talk". Then enter the Polycom Zone (IP Address and Port) that matches the configuration of the Polycom phones and Channels. The "Default Channel" is the target group in a Polycom paging environment.

The Polycom phone used as page audio source for the 8186 SIP Horn Speaker(s) must be configured to use either the G.711 or G.722

audio codec. **The Polycom phone(s) must also be configured with the "Compatibility" setting ("ptt.compatibilityMode") disabled** in order for this codec setting to be applied.

If using a Polycom phone as the Multicast master, a tone may be set for any of the 25 Polycom Groups configured on the Algo device. If an Algo device is used as a Multicast master, a tone does not have to be set as the Algo master will provide its own tone. Polycom Group Tones can be set in Advanced Settings > Advanced Multicast tab.

Additional Features Tab – Input/Output

When triggered by an input relay, 8186 SIP Horn Speaker can perform actions such as playing a pre-recorded announcement over the speaker(s), sending the announcement as a private message to a phone, or initiating a two-way conversation between the speaker and a phone.

The input relay to the 8186 SIP Horn Speaker(s) can be prompted by any normally open or normally closed switch. Algo offers the 1202 Call Button or the 1203 Call Switch with supervision. Via supervision settings, notification actions can also be triggered if the input switch is disconnected.

The 8186 SIP Horn Speaker can execute the following actions when triggered by an input relay:

- Play Tone
- Make SIP Voice Call
- Make SIP Call with Tone

Algo 1202 Call Button



The Algo 1202 Call Button is a one-touch button for event notification and response. It can be used with the 8186 for improved customer service, emergency notification, and non-emergency alerting. The Call Button's one-touch button can trigger a single or continuous action, which can be halted via the small cancel/reset button located below the main call button.

Algo 1203 Call Switch



The Algo 1203 Call Switch is a simple contact closure switch with an illuminated button and supervision capabilities. When used in conjunction with the 8186, the 1203 can prompt a single action with one-touch, or a continuous action if the button is held.

Status Basic Settings **Additional Features** Advanced Settings System Logout

Input/Output Emergency Alerts More Page Extensions More Ring Extensions

Input/Output

General

Relay Input Mode Disabled
 Relay Normally Open
 Relay Normally Open with Supervision (e.g. Algo 1203 Call Switch)
 Relay Normally Closed
 Relay Normally Closed with Supervision
 Speaker Volume/Mute
 Algo 1202 Call Button

Action When Input Triggered

Action Play Tone Make SIP Voice Call Make SIP Call with Tone
**Play Tone* will play sound on a local speaker as well as multicast if configured.*

Extension to Dial
SIP account required in Page Extension fields in order to make a call.

Allow 2nd Button Press Disabled End and Restart Call End Call

Tone/Pre-recorded Announcement

Interval Between Tones (seconds)

Maximum Tone Duration

Action When Tamper Detected

Action Play Tone Make SIP Voice Call Make SIP Call with Tone
**Play Tone* will play sound on a local speaker as well as multicast if configured.*

Extension to Dial
SIP account required in Page Extension fields in order to make a call.

Outbound SIP Call Settings

Outbound Ring Limit
1 ring = 6 seconds

Ringback Tone

Maximum Call Duration

Output

Output Light Enabled Disabled
Disable the blue light on the speaker entirely (keep the light off even when the speaker is active)

Heartbeat Light Enabled Disabled
Flash the blue light every 30 seconds to indicate that the speaker is powered and running.

Output Relay Enabled Disabled
Disable the relay output on the speaker

Action – Play Tone

When the 8186 receives input, a tone or a pre-recorded WAV file will play over the local speaker, or multicast if enabled. This function can be used to call support/assistance in service or retail environments, notify about an emergency at a specific location in medical/educational facilities, or sound an alarm during an intrusion.

- Action When Input Triggered:
 - Tone/Pre-recorded Announcement
 - Tone Duration

Action - Make SIP Voice Call

Upon receiving input, a voice path will open for an intercom-like call via the 8186 SIP Horn Speaker's microphone to a pre-configured phone extension. This option can be used when a call needs to be made from a public place where a phone would not be practical to use.

- Action When Input Triggered:
 - Extension to Dial
 - Call Mode
 - Allow 2nd Button Press
- Outbound SIP Call Settings:
 - Outbound Ring Limit
 - Ringback Tone
 - Maximum Call Duration

Action - Make a SIP Call with Tone

An input can also generate a private call to a pre-configured phone extension with a pre-recorded message. For instance, a call to a supervisor's phone notifying about an emergency or intrusion at some location.

- Action When Input Triggered:
 - Extension to Dial
 - Allow 2nd Button Press
 - Tone/Pre-recorded Announcement
 - Interval Between Tone (seconds)
 - Maximum Tone Duration
- Outbound SIP Call Settings:
 - Outbound Ring Limit
 - Ringback Tone

Action When Tamper Detected (Supervision)

In addition to the main events, the device can be configured with supervision to also execute one of the above three actions in case the input switch is disconnected due to wiring failure or after being tampered with. For example, a tone could sound over the speaker(s), or a private pre-recorded message could be sent to a specified phone extension. The supervision configuration options will appear once a relay option with supervision is selected. See the Electrical Specification section for details on supervision detection circuit.

Speaker Volume/Mute

Apply an external switch (short-circuit) across the Relay Input terminals in order to mute the speaker. This allows a temporary "disable" switch to control the device if desired, for example in a boardroom to block paging during important meetings.

If volume control is desired, instead use a 5k-ohm (or 10k-ohm) logarithmic potentiometer (rated for 1 Watt) to set the current across the Relay Input terminals. Volume steps are applied at 4mA intervals based on a nominal 13V source voltage (40mA current-limited). 0mA = regular (full) volume, down to mute at 40mA.

Leave the Relay Input terminals open (no-connect) for regular full-volume operation when in this mode.

Call Button

While the 8186 can be configured to play the WAV file only once, it can also be enabled to play it continuously with just one touch on the 1202 Call Button. The action can then be stopped via the smaller oval cancel button located below the main call button on the 1202.

Dialing Extension

SIP account required in Page Extension fields in order to make a call.

Interval Between Tones

Specify the time delay (seconds) between tones.

Maximum Tone Duration

Select the maximum tone duration. The tone will be terminated once the maximum time is reached.

Call Mode

This setting is available when the "Make SIP Voice Call" option is enabled. If the "Regular Two-Way Call" setting is chosen, a relay closure will prompt an intercom-like call via the speaker and its microphone to a pre-configured extension. When the "Silent Microphone Monitoring" is enabled, the relay will prompt only the audio from the 8186's microphone to be heard at the pre-configured extension, while the speaker remains silent. This setting is ideal in

settings where silent emergency calls to a pre-configured extension may be needed with a single press of a button.

Outbound Ring Limit

Typically set to ensure that a call will not reach voicemail. This feature can be used to set a limit on how long the speaker will ring before timing out.

Ringback Tone

If enabled, a ringback tone will play over the speaker during an outbound SIP call, while waiting for the far-end party to answer.

Maximum Call Duration

Select the maximum call length. The call will be terminated once the maximum time is reached. In the event that a call inadvertently reaches voicemail or gets accidentally left on hold, this setting ensures that the 8186 returns onhook.

Output Light

Enable/Disable the blue light on the speaker entirely (keep the light off even when the speaker is active).

Heartbeat Light

If enabled the blue indicator will flash every 30 seconds as visual confirmation that the 8186 is powered and running.

Output Relay

Enable/Disable the relay output on the speaker.

Additional Features Tab – Emergency Alerts

Status Basic Settings **Additional Features** Advanced Settings System Logout

Input/Output **Emergency Alerts** More Page Extensions More Ring Extensions

Emergency Alerts

i This section allows pre-recorded announcements to be triggered & latched by calling an extension and hanging up. The announcement will continue to play until a different "Cancel" extension is called to clear the announcement (or a pre-defined timeout is reached). This can be useful for emergency notifications (e.g. "Evacuation Alert"), allowing staff to quickly dial a pre-configured number and then exit the building. Audio files can be easily uploaded to create custom announcements.

i Up to 10 extensions can be registered allowing up to 10 different announcements. A single "Cancel" extension also needs to be registered; calling this number will cancel the currently active announcement.

i Note: Some SIP phone systems may not support this feature if they limit the number of extensions that can be registered on a single device.

Settings

Announcement Duration Play Once Play Until Cancelled

Maximum Announcement Time

Answer Inbound Call Enabled Disabled

i This option selects how the Announcement calls are handled. In both cases, the Emergency Announcement is started when the appropriate extension is called and continues until the Cancel Extension is called.

i Select "Enabled" to answer the inbound call and provide the option to play a confirmation tone before starting the alert, then automatically release the call.

i Select "Disabled" to detect just the inbound Ring signal, but not actually answer the call

Call-to-Cancel

Extension

Authentication ID

Authentication Password

Confirmation Tone

Announcements

Announcement 1 Enabled Disabled

Extension

Authentication ID

Authentication Password

Tone/Pre-recorded Announcement

Confirmation Tone

Multicast Zone

Announcement 2 Enabled Disabled

Announcement 3 Enabled Disabled

Announcement 4 Enabled Disabled

Announcement 5 Enabled Disabled

Announcement 6 Enabled Disabled

Announcement 7 Enabled Disabled

Announcement 8 Enabled Disabled

Announcement 9 Enabled Disabled

Announcement 10 Enabled Disabled

Save

Emergency Alerts allow for an announcement to be triggered & latched by calling a pre-configured Emergency extension and hanging up. The announcement will continue to play until a different "Cancel" extension is called to clear the announcement (or a pre-defined timeout is reached). The Emergency Alerts are useful for emergency notifications (e.g. evacuation, lockdown, medical emergency, etc.), allowing staff to quickly dial a pre-configured number under such circumstances.

If the "Answer Inbound Call" option is "Enabled" the call is auto-answered and a confirmation tone is played before starting the alert. If "Disabled", the alert is triggered just by the inbound ring, without answering the call. (In both instances, the announcement will play until the time limit is reached or the "Cancel Extension" is called). The auto-answering option can be useful when the caller cannot hear announcement from their location. However, in instances where the call might go to a group/multiple extensions (including this device), the auto-answer may intercept that call and prevent it from ringing on other devices.

Up to 10 extensions can be registered allowing up to 10 different announcements. Audio files can also be easily uploaded to create custom announcements.

Note: Some SIP phone systems may not support this feature if they limit the number of extensions that can be registered on a single device.

Additional Features Tab – More Page Extensions

More Page Extensions

This section allows dedicated extensions to be registered for each paging zone. This provides an alternative to the "DTMF Selectable Zone" option, thus allowing any zone to be called directly without the need to enter DTMF. Depending on the features available in your SIP phone system, this can provide benefits in allowing speed-dial keys to be programmed on user phones for paging a particular zone more easily, or dialing restrictions could potentially be used to allow only selected phones to access certain zones. This feature requires several SIP extensions to be registered with the SIP phone system of course.

- The 8186 will auto-answer any inbound calls received on these numbers and provide a voice paging path and multicast if configured. Note that only a single call can be active at a time.
- Note: Some SIP phone systems may not support this feature if they limit the number of extensions that can be registered on a single device.
- Multicast Zone Definitions can be found in "Advanced Settings > [Advanced Multicast](#)".

Basic Extensions

Priority Call Page Extension	<input checked="" type="radio"/> Enabled <input type="radio"/> Disabled
Extension	<input type="text"/>
Authentication ID	<input type="text"/>
Authentication Password	<input type="password"/>
All Call Page Extension	<input type="radio"/> Enabled <input checked="" type="radio"/> Disabled
Zone 1 Page Extension	<input type="radio"/> Enabled <input checked="" type="radio"/> Disabled
Zone 2 Page Extension	<input type="radio"/> Enabled <input checked="" type="radio"/> Disabled
↓	
Zone 50 Page Extension	<input type="radio"/> Enabled <input checked="" type="radio"/> Disabled

Save

Additional SIP extensions can be registered for each multicast zone that will be used. This allows the advantage of dialing directly to a zone without needing to enter DMTF (e.g. speed-dial keys can be used), but may require additional SIP licenses depending on the SIP provider.

To configure additional page extensions (up to 50) click "Enable" beside the target extension and enter the Extension, Authentication ID, and Authentication password.

The 8186 will auto-answer any inbound calls received on these numbers and provide a voice paging path and multicast if configured. Note that only a single call can be active at a time.

Note: Some SIP phone systems may not support this feature if they limit the number of extensions that can be registered on a single device.

Multicast Zone Definitions can be found in "Advanced Settings > Advanced Multicast".

Additional Features Tab – More Ring Extensions

More Ring Extensions

i This section allows additional extensions to be registered for the purpose of providing loud ringing alerts for more than one line. Unique ring tones can be selected for each line to allow them to be easily distinguished - for example a "Sales" line could have a different ring tone from a personal line. Appropriate call routing must be configured on your SIP phone system of course in order to trigger it to send calls to these different numbers.

i The 8186 will detect inbound ring events on these numbers and play the alerting tone until the inbound call stops ringing. It will not answer the calls in this mode.

i Note: Some SIP phone systems may not support this feature if they limit the number of extensions that can be registered on a single device.

Ring Extension 2	<input checked="" type="radio"/> Enabled <input type="radio"/> Disabled
Extension	<input type="text"/>
Authentication ID	<input type="text"/>
Authentication Password	<input type="password"/>
Ring Tone	<input type="text" value="<Use Default Ring Tone>"/>
Multicast Zone	<input type="text" value="<Use Default Multicast Zone>"/>
Ring Extension 3	<input type="radio"/> Enabled <input checked="" type="radio"/> Disabled
Ring Extension 4	<input type="radio"/> Enabled <input checked="" type="radio"/> Disabled
Ring Extension 5	<input type="radio"/> Enabled <input checked="" type="radio"/> Disabled
Ring Extension 6	<input type="radio"/> Enabled <input checked="" type="radio"/> Disabled
Ring Extension 7	<input type="radio"/> Enabled <input checked="" type="radio"/> Disabled
Ring Extension 8	<input type="radio"/> Enabled <input checked="" type="radio"/> Disabled
Ring Extension 9	<input type="radio"/> Enabled <input checked="" type="radio"/> Disabled
Ring Extension 10	<input type="radio"/> Enabled <input checked="" type="radio"/> Disabled

Save

Up to 10 SIP Ring extensions can be registered. To configure additional ring extensions click "Enable" beside the target extension and enter the Extension, Authentication ID, and Authentication password.

A unique Ring Tone can be assigned to each extension if desired.

Advanced Settings Tab - Network

Protocol

DHCP is an IP standard designed to make administration of IP addresses simpler. When selected, DHCP will automatically configure IP addresses for each 8186 SIP Horn Speaker on the network. Alternatively the 8186 SIP Horn Speaker can be set to a static IP address.

VLAN Mode

Enables or Disables VLAN Tagging. VLAN Tagging is the networking standard that supports Virtual LANs (VLANs) on an Ethernet network. The standard defines a system of VLAN tagging for Ethernet frames and the accompanying procedures to be used by bridges and switches in handling such frames. The standard also provides provisions for a quality of service prioritization scheme commonly known as IEEE 802.1p and defines the Generic Attribute Registration Protocol.

VLAN ID

Specifies the VLAN to which the Ethernet frame belongs. A 12-bit field specifying the VLAN to which the Ethernet frame belongs. The hexadecimal values of 0x000 and 0xFFF are reserved. All other values may be used as VLAN identifiers, allowing up to 4094 VLANs. The reserved value 0x000 indicates that the frame does not belong to any VLAN; in this case, the 802.1Q tag specifies only a priority and is referred to as a priority tag. On bridges, VLAN 1 (the default VLAN ID) is often reserved for a management VLAN; this is vendor specific.

VLAN Priority

Sets the frame priority level. Otherwise known as Priority Code Point (PCP), VLAN Priority is a 3-bit field which refers to the IEEE 802.1p priority. It indicates the frame priority level. Values are from 0 (lowest) to 7 (highest).

Differentiated Services (6-bit DSCP value)

Provides quality of service if the DSCP protocol is supported on your network. Can be specified independently for SIP control packets versus RTP audio packets.

Advanced Settings Tab – Admin

Status	Basic Settings	Additional Features	Advanced Settings	System	Logout		
Network	Admin	Time	Provisioning	Tones	Advanced Audio	Advanced SIP	Advanced Multicast

Admin Settings

Admin Password

Password

Confirmation

General

Device Name (Hostname)

Introduction Section on Status Page On Off

Web Interface Session Timeout
Automatically log out web interface after period of inactivity.

Play Tone at Startup Enabled Disabled
A tone can be played at startup to confirm that the device has booted.

Log Settings

Log Level Error (Lowest) Notice ("Event") Info ("SIP") Debug (Highest)

Log Method Local Network Both

Log Server

Management

Web Interface Protocol Both HTTP and HTTPS HTTPS Only

Force Strong Password Enabled Disabled

Allow Secure SIP Passwords Enabled Disabled
After enabling this option, it is recommended to re-enter SIP passwords and their corresponding realm to store the passwords securely.

SNMP Support (v1 get only) Enabled Disabled

Syn-Apps

SA-Announce Support Enabled Disabled

SA-Announce Server
Leave this field blank to use the server provided by DHCP Option 72.

Local Management Port

Save

Password

Password to log into the 8186 SIP Horn Speaker web interface. You should change the default password **algo** in order to secure the device on the network. If you have forgotten your password, you will need to perform a reset in order to restore the password (as well as all other settings) back to the original factory default conditions (For details, see "Terminal Block Reset" on page 18).

For additional password security see "Force Strong Password" below.

Confirmation

Re-enter network admin password

Device Name (Hostname)

Name to identify the device in the Algo Network Device Locator Tool.

Introduction Section on Status Page

Allows the introduction text to be hidden from the login screen.

Web Interface Session Timeout

Set the maximum period of inactivity after which the web interface will log out automatically.

Play Tone at Startup

A tone can be played at startup to confirm that the device has booted. This can be useful when testing or configuring a device, but might not be desirable if the device is connected to an external amplifier and paging system.

Log Level

Use on the advice of Algo technical support only.

Log Size

Consult Algo technical support.

Log Method

Allows the 8186 SIP Horn Speaker to write to external Syslog server if the option for external (or both) is selected.

Log Server

If external (or both) is selected this is the address of the Syslog server on the network.

Web Interface Protocol

HTTPS is always enabled on the device. Use this setting to disable HTTP. When HTTP is disabled, requests will be automatically redirected to HTTPS. Also note that since the device can have any address on the local network, no security certificate exists, and thus most browsers will provide a warning when using HTTPS.

Force Strong Password

When enabled, ensures that a secure password is provided for the device's web interface for additional protection. The password requirements are:

- Must contain at least 10 characters
- Must contain at least 1 uppercase character
- Must contain at least 1 digit (0 – 9)
- Must contain at least 1 special character

Allow Secure SIP Password

Allows SIP passwords to be stored in the configuration file in an encrypted format, to prevent viewing and recovery. Once enabled, the SIP "Realm" field should be entered and all the configured Authentication Password(s) must be re-entered in the Basic Settings > SIP tab, and any other locations where SIP extension have been configured, to save the encrypted password(s).

If the Realm is changed at a later time, all the passwords will also need to be re-entered again to save the passwords with the new encryption.

To obtain your SIP Realm information, contact your SIP Server administrator (or check the SIP log file for a registration attempt). The Realms may be the same or different for all the extensions used.

SNMP Support (v1 get only)

Additional SNMP support is anticipated for future, but the 8186 SIP Horn Speaker will respond to a simple status query for automated supervision. Contact Algo technical support for more information.

SA-Announce Support

Syn-Apps' SA-Announce paging application converts unicast streams to multicast and delivers them to the target endpoints. The feature

can only be used on the 8186 when Multicast Master Mode is disabled (set to 'None') in the Basic Settings > Multicast tab.

SA-Announce Server

Enter the SA-Announce Server to use the Syn-Apps paging feature. To use the server provided by the DHCP Option 72, leave the field blank.

Local Management Port

Enter the local management port.

Advanced Settings Tab – Time

The screenshot shows the 'Time Settings' configuration page in the ALGO web interface. The page is under the 'Advanced Settings' tab and includes the following sections:

- General:**
 - Timezone: UTC (dropdown menu)
- NTP Time Servers:**
 - NTP Time Server 1: 0.debian.pool.ntp.org
 - NTP Time Server 2: 1.debian.pool.ntp.org
 - NTP Time Server 3: 2.debian.pool.ntp.org
 - NTP Time Server 4: 3.debian.pool.ntp.org
- NTP Time Server Source:**
 - Use DHCP Option 42 (selected)
 - Ignore DHCP Option 42
 - By default, if an NTP Server address is provided via DHCP Option 42, this will be used instead of the options above.
- Device Date/Time:**
 - Thu Apr 20 21:33:49 2017
 - Sync with browser button
 - Manual time and date are intended for testing purpose only. Time will be lost upon power down.

A 'Save' button is located at the bottom right of the form.

Network time is used for logging events into memory for troubleshooting.

Time Zone

Select time zone.

NTP Time Servers 1/2/3/4

The speaker will attempt to use Timer Server 1 and work down the list if one or more of the time servers become unresponsive.

NTP Time Server Source

When "Use DHCP Option 42" is chosen, if an NTP Server address is provided via the DHCP Option 42, that NTP Server will be used instead of the 4 mentioned above. Alternatively, "Ignore DHCP Option 42" can be chosen to only use servers mentioned above.

Device Date/Time

This field shows the current time and date as set on the device. If testing the device on a lab network that may not have access to an

external NTP server, the "Sync with browser" button can be used to temporarily set the time on the device.

Note, this time value will be lost at power down, or overwritten if NTP is currently active. Time and date are used only for logging purposes and are not typically required.

Advanced Settings Tab – Provisioning

The screenshot shows the 'Advanced Settings' tab with the 'Provisioning' sub-tab selected. The 'Provisioning Settings' section includes:

- Mode:** Provisioning Mode is set to Enabled and Disabled.
- Settings:**
 - Server Method:** Radio buttons for Auto (DHCP Option 66/160/150), DHCP Option 66 only, DHCP Option 160 only, DHCP Option 150 only, and Static. A note below states: "Auto mode automatically checks all 3 DHCP options for an active provisioning server, in the order listed."
 - Static Server:** An empty text input field.
 - Download Method:** Radio buttons for TFTP, FTP, HTTP, and HTTPS.
 - Validate Server Certificate:** Radio buttons for Enabled and Disabled.
 - Auth User Name:** An empty text input field.
 - Auth Password:** An empty text input field with a blue eye icon for toggling visibility.
 - Config Download Path:** An empty text input field.
 - Firmware Download Path:** An empty text input field.

A green 'Save' button is located at the bottom right of the settings area.

Note: It is recommended that Provisioning Mode be set to Disabled if this feature is not in use. This will prevent unauthorized re-configuration of the device if DHCP is used.

Provisioning allows installers to pre-configure 8186 SIP Horn Speaker units prior to installation on a network. It is typically used for large deployments to save time and ensure consistent setups.

The device can be provisioned via the Auto mode (where all three DHCP options (Option 66/160/150) will be automatically checked for an active provisioning server), just one of the three specified DHCP options, or a Static Server. In addition, there are four different ways to download provisioning files from a "Provisioning Server": TFTP (Trivial File Transfer Protocol), FTP, HTTP, or HTTPS.

For example, 8186 configuration files can be automatically downloaded from a TFTP server using DHCP Option 66.

This option code (when set) supplies a TFTP boot server address to the DHCP client to boot from.

DHCP must be enabled if using DHCP Option 66/160/150, in order for Provisioning to work.

One of two files can be uploaded on the Provisioning Server (for access via TFTP, FTP, HTTP, or HTTPS):

Generic (for all Algo 8186 Speakers)	algop8186.conf
Specific (for a specific MAC address)	algom[MAC].conf

Both protocol and path is supported for Option 66, allowing for <http://myserver.com/config-path> to be used.

MD5 Checksum

In addition to the .conf file, an .md5 checksum file must also be uploaded to the Provisioning server. This checksum file is used to verify that the .conf file is transferred correctly without error.

A tool such as can be found at the website address below may be used to generate this file:

<http://www.fourmilab.ch/md5>

The application doesn't need an installation. To use the tool, simply unzip and run the application (md5) from a command prompt. The proper .md5 file will be generated in the same directory.

If using the above tool, be sure to use the "-l" parameter to generate lower case letters.

Generating a generic configuration file

1. Connect 8186 to the network
2. Access the 8186 Web Interface Control Panel
3. Configure the 8186 with desired options
4. Click on the System tab and then Maintenance.
5. Click "Download" to download the current configuration file
6. Save the file settings.txt
7. Rename file settings.txt to algop8186.conf
8. File algop8186.conf can now be uploaded onto the Provisioning server

If using a generic configuration file, extensions and credentials have to be entered manually once the 8186 SIP Horn Speaker has automatically downloaded the configuration file.

Generating a specific configuration file

1. Follow steps 1 to 6 as listed in the section "Generating a generic configuration file".
2. Rename file settings.txt to algom[MAC address].conf (e.g. algom0022EE020009.conf)
3. File algom[MAC address].conf can now be uploaded on the Provisioning server.

The specific configuration file will only be downloaded by the 8186 SIP Horn Speaker with the MAC address specified in the configuration file name. Since all the necessary settings can be included in this file, the 8186 will be ready to work immediately after the configuration file is downloaded. The MAC address of each 8186 SIP Horn Speaker can be found on the back label of the unit.

For more Algo SIP endpoint provisioning information, see:
www.algosolutions.com/provision

Advanced Settings Tab – Tones

The screenshot shows the 'Tone Management' interface. At the top, there are tabs for 'Status', 'Basic Settings', 'Additional Features', 'Advanced Settings', 'System', and 'Logout'. Under 'Advanced Settings', there are sub-tabs for 'Network', 'Admin', 'Time', 'Provisioning', 'Tones', 'Advanced Audio', 'Advanced SIP', and 'Advanced Multicast'. The 'Tones' sub-tab is active.

Tone Management

Upload

New Tone File No file selected.

8kHz/16kHz, 16-bit, Mono, PCM/u-law WAV File, or such files in zip format. Please limit the file name to 32 characters, and no spaces.

Tone Files

Functions

Please select a file from the list below to use these functions.

Name	Size	Modification Date/Time
<input checked="" type="radio"/> bell-na.wav	187 kB	Jul 17, 2013 21:44
<input type="radio"/> bell-uk.wav	100 kB	Jul 17, 2013 21:44
<input type="radio"/> buzzer.wav	187 kB	Jul 17, 2013 21:44
<input type="radio"/> chime.wav	187 kB	Jul 17, 2013 21:44
<input type="radio"/> dogs.wav	357 kB	Jul 17, 2013 21:44
<input type="radio"/> gong.wav	187 kB	Jul 17, 2013 21:44
<input type="radio"/> page-notif.wav	23 kB	Jul 17, 2013 21:44
<input type="radio"/> warble1-low.wav	187 kB	Jul 17, 2013 21:44
<input type="radio"/> warble2-med.wav	187 kB	Jul 17, 2013 21:44
<input type="radio"/> warble3-high.wav	187 kB	Jul 17, 2013 21:44
<input type="radio"/> warble4-trill.wav	187 kB	Jul 17, 2013 21:44

If you wish to copy a tone file to your local computer, right click the name to download.

Number of Files 11
Total Size 1981 kB

Uploading Custom Audio Files

Custom audio files (WAV format) may be uploaded into memory (1 GB) to play for notification applications.

An existing file may also be modified by downloading the original via the links in the web interface, making the desired changes, and then uploading the new version with a different name. Audio files must be in the following format:

- WAV format
- 8kHz or 16kHz sampling rate
- 16-bit PCM, or u-law
- Mono

A zip files containing one or more audio files may also be uploaded. File names must be limited to 32 characters, with no spaces.

Tone Files Included in Memory

The 8186 SIP Horn Speaker includes several pre-loaded WAV files that can be selected to play for various events. The web interface allows selection of the WAV file and also the ability to play the WAV file immediately over the speaker for testing. Files may also be deleted or renamed.

Advanced Settings Tab – Advanced Audio

The screenshot shows the 'Advanced Audio Functions' configuration page. At the top, there are navigation tabs: Status, Basic Settings, Additional Features, **Advanced Settings**, System, and Logout. Below these are sub-tabs: Network, Admin, Time, Provisioning, Tones, **Advanced Audio**, Advanced SIP, and Advanced Multicast. The main content area is titled 'Advanced Audio Functions' and contains two sections:

- Functions:**
 - Dynamic Range Compression (DRC):** Radio buttons for 'Enabled' (selected) and 'Disabled'. Description: 'Compress the dynamic range of page audio to increase loudness.'
 - Dynamic Range Compression Gain:** A dropdown menu set to '6'. Description: 'Specify the amount of compression gain. More gain increases distortion.'
 - Jitter Buffer Range (milliseconds, 10 ~ 500):** A text input field set to '100'. Description: 'Adds more buffering if necessary to correct for inconsistent delays on the network. Use of the lowest value generally is recommended.'
 - Always Send RTP Media:** Radio buttons for 'Enabled' and 'Disabled' (selected).
- Audio Filters:**
 - Speaker Filter G.711:** A dropdown menu set to '300Hz High-Pass'. Description: 'Bandwidth also limited by audio codecs.'
 - Microphone Filter G.711:** A dropdown menu set to '300Hz High-Pass'.
 - Speaker Filter G.722:** A dropdown menu set to '150Hz High-Pass'.
 - Microphone Filter G.722:** A dropdown menu set to '150Hz High-Pass'.
 - Speaker Noise Filter:** Radio buttons for 'Enabled' and 'Disabled' (selected). Description: 'Heavy filtering below 150Hz to reduce mains induced noise (fans).'
 - Microphone Noise Filter:** Radio buttons for 'Enabled' and 'Disabled' (selected). Description: 'Heavy filtering below 150Hz to reduce mains induced noise (fans).'

A 'Save' button with a green checkmark is located at the bottom right of the form.

Dynamic Range Compression (DRC)

If enabled, compresses the dynamic range of page audio to increase loudness.

Dynamic Range Compression Gain

Higher compression gain increases distortion.

Jitter Buffer Range

The jitter buffer removes the jitter in arriving network packets by temporarily storing them. This process corrects the inconsistent delays on the network. It is recommended to use the lowest value.

Always Send RTP Media

If enabled, audio packets will be sent at all times, even during one way paging mode. This option is needed in cases when the server expects to see audio packets at all times.

Speaker Filter G.711

G.711 speaker filter.

Microphone Filter G.711

G.711 microphone filter.

Speaker Filter G.722

G.722 speaker filter.

Microphone Filter G.722

G.722 microphone filter.

Speaker Noise Filter

Enables heavy filtering below 150Hz to reduce mains induced noise (fans).

Microphone Noise Filter

Enables heavy filtering below 150Hz to reduce mains induced noise (fans).

Advanced Settings Tab – Advanced SIP

The screenshot displays the 'Advanced SIP Settings' configuration page. At the top, there are navigation tabs: Status, Basic Settings, Additional Features, **Advanced Settings**, System, and Logout. Below these are sub-tabs: Network, Admin, Time, Provisioning, Tones, Advanced Audio, **Advanced SIP**, and Advanced Multicast. The main content area is titled 'Advanced SIP Settings' and is divided into two sections: 'SIP' and 'Server Redundancy'. The 'SIP' section includes fields for Outbound Proxy, STUN Server, Register Period (3600), Keep-alive Method (Double CRLF), Keep-alive Period (30), and Different Ports for Extensions (Disabled). The 'Server Redundancy' section includes Server Redundancy Feature (Enabled), Backup Server #1 and #2, Polling Interval (120 seconds), Poll Active Server (Disabled), Automatic Failback (Enabled), and Polling Method (SIP NOTIFY).

Outbound Proxy

IP address for outbound proxy. A proxy (server) stands between a private network and the internet.

STUN Server

IP address for STUN server if present.

Register Period (seconds)

Maximum requested period of time where the 8186 SIP Horn Speaker will re-register with the SIP server. Default setting is 3600 seconds (1 hour). Only change if instructed otherwise.

Keep-alive Method

If Double CRLF is selected the 8186 SIP Horn Speaker will send a packet every 30 seconds (unless changed) to maintain connection with the SIP Server if behind NAT.

Different Ports for Extensions

Enable the feature for certain proxies, like Cisco Communication Manager 7, to send ring and page SIP requests through different port numbers.

Server Redundancy Feature

Two secondary SIP servers may be configured. The 8186 SIP Horn Speaker will attempt to register with the primary server but switch to a secondary server when necessary. The configuration allows re-registration to the primary server upon availability or to stay with a server until unresponsive.

Backup Server #1

If primary server is unreachable the 8186 SIP Horn Speaker will attempt to register with the backup servers. If enabled the 8186 SIP Horn Speaker will always attempt to register with the highest priority server.

Backup Server #2

If backup server #1 is unreachable the 8186 SIP Horn Speaker will attempt to register with the 2nd backup server. If enabled the 8186 SIP Horn Speaker will always attempt to register with the highest priority server.

Polling Intervals (seconds)

Time period between sending monitoring packets to each server. Non-active servers are always polled, and active server may optionally be polled (see below).

Poll Active Server

Explicitly poll current server to monitor availability. May also be handled automatically by other regular events, so can be disabled to reduce network traffic.

Automatic Failback

Reconnect with higher priority server once available, even if backup connection still fine.

Polling Method

SIP message used to poll servers to monitor availability.

Advanced Settings Tab – Advanced Multicast

Status Basic Settings Additional Features Advanced Settings System Logout

Network Admin Time Provisioning Tones Advanced Audio Advanced SIP Advanced Multicast

Advanced Multicast Settings

Current multicast mode: Slave
Multicast mode can be set in "Basic Settings > Multicast"

Slave Settings

Audio Sync (milliseconds, 0 ~ 1000) When using multicast with other third-party devices that have a delay in their audio path, the audio on the 8186 may be heard slightly earlier than on these other devices. Use this feature to add a small delay to the audio output on the 8186 in order to synchronize with these other devices. Applies to Multicast Slave mode only.

Basic Zone Definition

When an Algo device is the multicast master, a page tone will play on the slave device, so it is recommended to set the slave tone to "None".

Zone	IP Address and Port	Page Tone	Page Volume
Priority Call (DTMF:9)	224.0.2.60:50000	<None>	<Use Default Page Volume>
All Call (DTMF:0)	224.0.2.60:50001	<None>	<Use Default Page Volume>
Zone 1 (DTMF:1)	224.0.2.60:50002	<None>	<Use Default Page Volume>
Zone 2 (DTMF:2)	224.0.2.60:50003	<None>	<Use Default Page Volume>
Zone 3 (DTMF:3)	224.0.2.60:50004	<None>	<Use Default Page Volume>
Zone 4 (DTMF:4)	224.0.2.60:50005	<None>	<Use Default Page Volume>
Zone 5 (DTMF:5)	224.0.2.60:50006	<None>	<Use Default Page Volume>
Zone 6 (DTMF:6)	224.0.2.60:50007	<None>	<Use Default Page Volume>
Music (DTMF:7)	224.0.2.60:50008	<None>	<Use Default Page Volume>

Expanded Zone Definition

Zone	IP Address and Port	Page Tone	Page Volume
Zone 10 (DTMF: *10)	224.0.2.110:50000	<None>	<Use Default Page Volume>
Zone 11 (DTMF: *11)	224.0.2.111:50000	<None>	<Use Default Page Volume>

↓

Zone 50 (DTMF: *50)	224.0.2.150:50000	<None>	<Use Default Page Volume>
---------------------	-------------------	--------	---------------------------

Audio Sync (Slave Mode)

When paging to the 8186 SIP Horn Speaker as well as other third party devices, the low latency of the 8186 SIP Horn Speaker may lead other devices. By adding audio delay up to one second, the 8186 SIP Horn Speaker may be synchronized with other speakers or telephones that have greater latency.

Master Output Codec (Master Mode)

Audio encoding format used by the master device when sending output to the slaves.

Master Output Packetization Time (Master Mode)

The size of the audio packets sent by the Master to the Slaves. The default of 20ms is recommended, unless a different value is specifically required for compatibility with other devices.

Zone Definition

The “Expanded” Slave or Master zones can be enabled/disabled in Basic Settings > Multicast. Default IP addresses and ports may be revised for any given zone in the table.

Ensure that the Address and Port settings are the same for all master and slave devices.

Page Tone and Page Volume

Master Mode: By default, the same tone can be set for all Slave zones in the Basic Settings > Features tab. Unique paging tones may be revised for any given Slave zone in the table above.

Slave Mode: When an Algo device is the multicast Master, a page tone will play on the Slave device, so it is recommended to set the Slave tone to “None”. If a page is received from a non-Algo device that doesn’t send a tone, a tone can be inserted on the Slaves (above) each time they detect page audio starting, allowing them to play a tone.

By default, the same page volume can be set for all Slave zones in the Basic Settings > Features tab. Unique page volumes may be revised on a per-zone basis in the table above. For instance, emergency pages can be louder on certain Slave speakers.

Status Basic Settings Additional Features **Advanced Settings** System Logout

Network Admin Time Provisioning Tones Advanced Audio Advanced SIP **Advanced Multicast**

Advanced Multicast Settings

Current multicast mode: Slave
Multicast mode can be set in "Basic Settings > Multicast"

Slave Settings

Audio Sync (milliseconds, 0 ~ 1000)

When using multicast with other third-party devices that have a delay in their audio path, the audio on the 8186 may be heard slightly earlier than on these other devices. Use this feature to add a small delay to the audio output on the 8186 in order to synchronize with these other devices. Applies to Multicast Slave mode only.

Polycom Slave Tones

When an Algo device is the multicast master, a page tone will play on the slave device, so it is recommended to set the slave tone to "None".

Group 1	<input type="text" value="beep.wav"/>
Group 2	<input type="text" value="<None>"/>
Group 3	<input type="text" value="<None>"/>

↓

Group 25	<input type="text" value="<None>"/>
----------	---

Polycom Slave Tones

A tone may be set for any of the 25 Polycom Groups. If using an Algo device as a Multicast master, it is recommended to set the slave tones to "None" to avoid conflicts, as the Algo devices already multicast a tone by default.

These settings are available only if the 8186 is set as a Multicast Slave and "Polycom Group Page" or "Polycom Push-to-Talk" are selected in the Basic Settings > Multicast tab.

System Tab - Maintenance

The screenshot shows a web interface for system maintenance. At the top, there are navigation tabs: Status, Basic Settings, Additional Features, Advanced Settings, System (selected), and Logout. Below these, there are sub-tabs: Maintenance (selected), System Log, and About. The main content area is titled "System Maintenance" and contains three sections:

- Backup / Restore Configuration:** Includes a "Download Configuration File" button with a download icon, a "Restore Configuration File" section with a "Browse..." button, a "No file selected." status, and a "Restore" button with an upload icon, and a "Restore Configuration to Defaults" button with a refresh icon.
- Reboot:** Includes a "Reboot the device" button with a refresh icon.
- Upgrade to New Firmware:** Includes a "Method" section with radio buttons for "From Local Files" (selected) and "From URL", a "Firmware Image" section with a "Browse..." button, a "No file selected." status, and an "MD5 Checksum" section with a "Browse..." button, a "No file selected." status, and an "Upgrade" button with an upload icon.

Download Configuration File

Save the device settings to a text file for backup or to setup a provisioning configuration file.

Restore Configuration File

Restore settings from a backup file.

Restore Configuration to Defaults

Resets all 8186 SIP Horn Speaker device settings to factory default values.

Reboot the Device

Reboots the device.

Method

Specify whether the firmware files will be downloaded from a Local Files or a URL.

Firmware Image

Point to the firmware image provided by Algo

MD5 Checksum

Point to the checksum file provided by Algo

Upgrade 8186 SIP Horn Speaker Firmware

1. From the top menu, click on System, then Maintenance.
2. In the Upgrade section, click on Choose File and select the 8186 SIP Horn Speaker firmware file to upload. Note that both the FW firmware and MD5 checksum files must be loaded.
3. Click Upgrade
4. After the upgrade is complete, confirm that the firmware version has changed (refer to top right of Control Panel).

System – System Log

System log files are automatically created and assist with troubleshooting in the event the 8186 SIP Horn Speaker does not behave as expected.

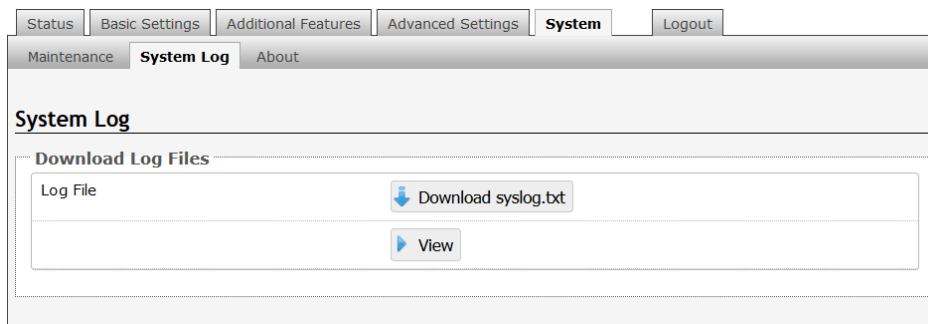

Specifications

Power Input:	48 V PoE IEEE 802.3af Class 0 (Max 13W - Idle nominal 2W)
Dimensions:	11.8" x 6.6" x 10.2" (30cm x 16.8cm x 25.8cm)
Mounting:	Wall, ceiling, or double gang electrical box
Weight:	6 lb (2.7 Kg)
Speaker:	Double re-entrant horn speaker, 11" x 6 5/8" (30cm x 16.8cm) rectangular
Dispersion Angle:	76H x 51V (2 kHz -6dB) Oriented Vertically 11" tall x 6 5/8" Wide
Aim Adjustment:	Three axis
Sensitivity:	110 dBA 1m/1W (1 kHz)
Audio Codecs:	G.711 A-law, G.711 u-law, G.722, Polycom Group Page
Frequency Response:	350 – 9,000 Hz (- 10 dB)
Microphone:	Electret omnidirectional wideband
Audio Delay:	10 to 1000 ms selectable for synchronization
Audio Memory:	1 GByte
Multicast:	Receive or transmit
Relay Output:	Normally open or normally closed. Max rating 30 V 50 mA.
Relay Input:	Normally open or normally closed dry contact supervision. Algo 1202 Button, Algo 1203 Switch, EOL resistor termination

Relay Input Current Draw Detection Thresholds:

	Active	Idle	Tamper
Normally Open	>4mA	<4mA	N/A
Normally Open with Supervision	>20mA	4-20mA	<4mA
Normally Closed	<4mA	>4mA	N/A
Normally Closed with Supervision	4-20mA	>20mA	<4mA

Nominal 12V source, current limited to 40mA.
Typical supervision resistor value = 1k ohm.

- Configuration:** Web interface or auto-provisioning server
- Provisioning:** TFTP, FTP, or HTTP
- Supervision:** SNMP
- NAT:** STUN, CRLF Keep Alive
- Processor:** Linux OS ARM Cortex-A8 32-Bit RISC Processor
- Server Redundancy:** Primary, secondary, tertiary
- Environmental:** -40 to +122 deg F (-40 to +50 deg C);
Suitable for outdoor and wet environments when properly installed.
- Compliance:** EN60950:2001, IEEE 802.3-2008, RFC3261,
RoHS, CE, FCC Class A, CISPR 22 Class A, CISPR 24, CSA/UL (USA & Canada)

FCC Compliance Statement

This equipment has been tested and found to comply with the limits for a Class A digital device, pursuant to Part 15 of the FCC Rules. These limits are designed to provide reasonable protection against harmful interference when the equipment is operated in a commercial environment. This equipment generates, uses, and can radiate radio frequency energy, and if it is not installed and used in accordance with the instruction manual, it may cause harmful interference to radio communications. Operation of this equipment in a residential area is likely to cause harmful interference, in which case the user will be required to correct the interference at his own expense.