

INOX

8", 12" and 16" Round Shower Heads & 8", 12" and 16" Square Shower Heads

Installation Guide - Guida D'installazione - Guia de Instalacion - Guide D'installation

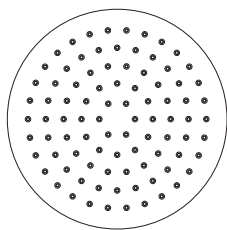

TOX330-S

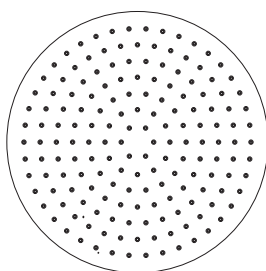

TOX334-S

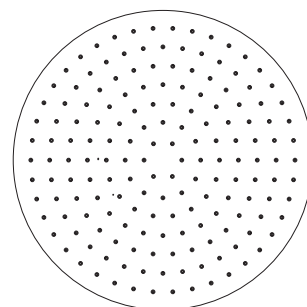

TOX340-S

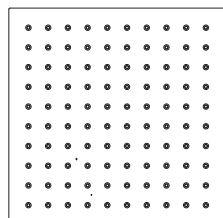

TOX420-S

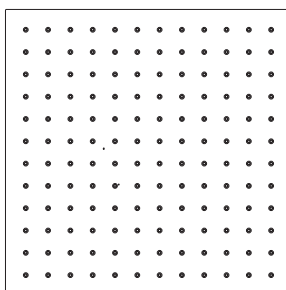

TOX430-S

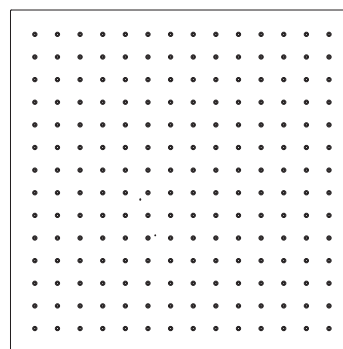

TOX440-S

Attention – Before Installation

1. Inspect this product to ensure you have all parts as shown that are required for proper installation.
2. The shower head has been factory tested – DO NOT TAKE THE SHOWER HEAD APART.
Taking the shower head apart will void the warranty.
3. Ensure that shower head is properly connected to the shower arm.
4. This product must be installed by a professional contractor.
5. Refer to the specification and assembly drawings attached for installation directions.
6. Flow Pressure – Min. 25 PSI, Max. 80 PSI. Recommended pressure – 50 to 60 PSI.

Installation Requirements

Please read the instructions carefully so as to avoid any damage to the fixture.

1. To ensure this product is installed properly, you must read and follow these guidelines.
2. The owner/user of the shower head must keep this information for future reference.
3. Be sure your installation conforms to local codes.
4. Refer to the specification and assembly drawings attached. Shower head is sold partially assembled but shown fully disassembled for illustrative and service purposes only.
5. Inspect this product to ensure you have all parts required for proper installation.
6. Use only a strap wrench or protected/smooth-jaw wrench on any finished surface.
7. Do NOT use putty during this installation.

Cleaners For Fittings And Accessories

To avoid damaging the surface and working components of the fittings, certain precautions must be taken in terms of usage and subsequent cleaning as many cleaning agents contain acids for general cleaning and removing calcium deposits. When caring for your fittings and accessories, please note the following:

- Only apply cleaners which are expressly intended for the use
- Never use any cleaner containing hydrochloric acid, formic acid or acetic acid on or near the fitting, as they can cause considerable damage
- Do not use cleaners containing phosphoric acid
- Do not use cleaners containing chlorine bleach solutions
- Never mix or combine cleaning agents
- Do not use abrasive cleaners and unsuitable scouring agents such as scouring pads
- It is advisable to use specific products for stainless steel, such as Flitz stainless steel & chrome cleaner

Technical Support Assistance

If further assistance is required, please contact: Product support at 1.866.907.0122 (09:00 - 17:00hrs PST) or email technical@blubathworks.com

North America
Blu Bathworks Inc.
188 Smithe Street, Vancouver BC, Canada, V6B 6A9
T+1.604.299.0122 F+1.604.299.0125

Please refer to blubathworks.com for warranty, terms & conditions under warranty & procedure for warranty service.

TOX330-S

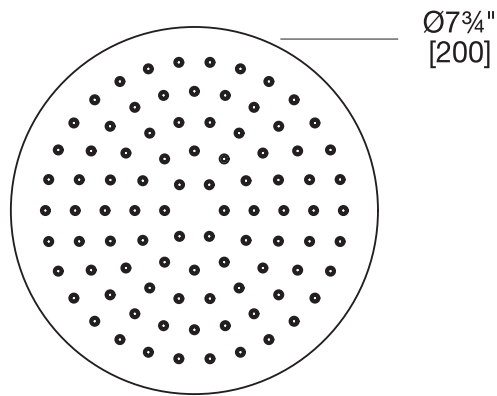
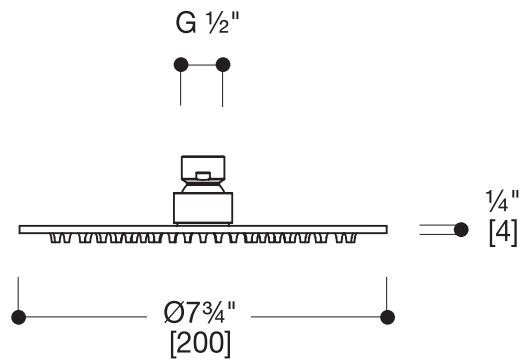

TOX330-S

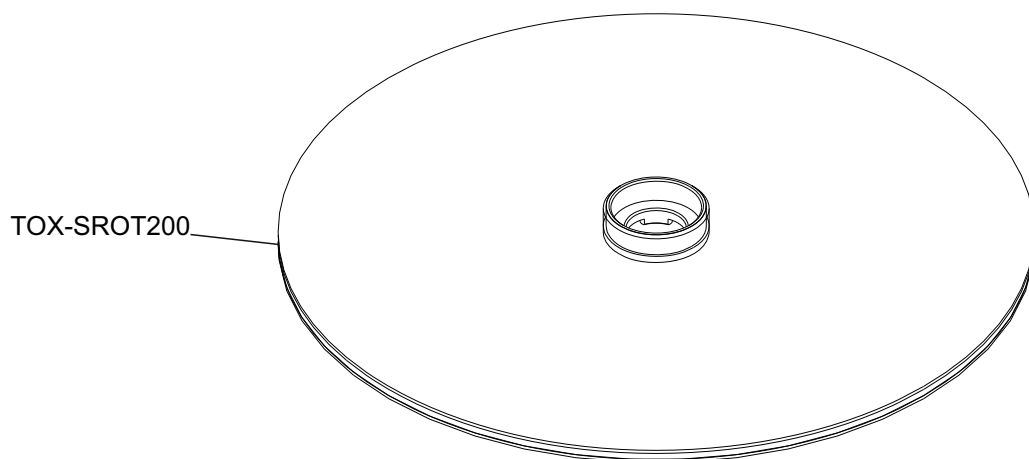
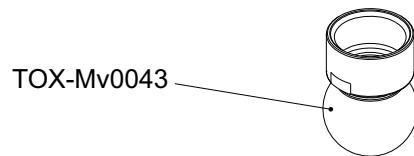
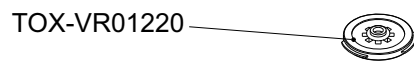
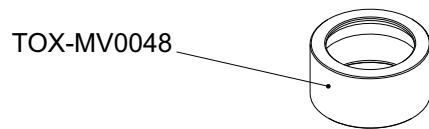
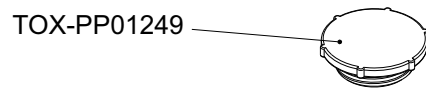

TOX334-S

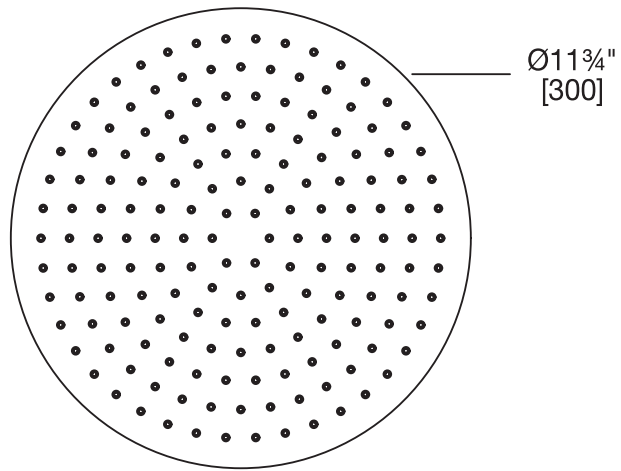
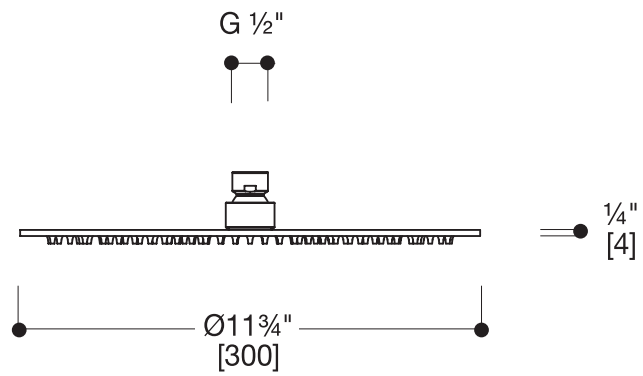

TOX334-S

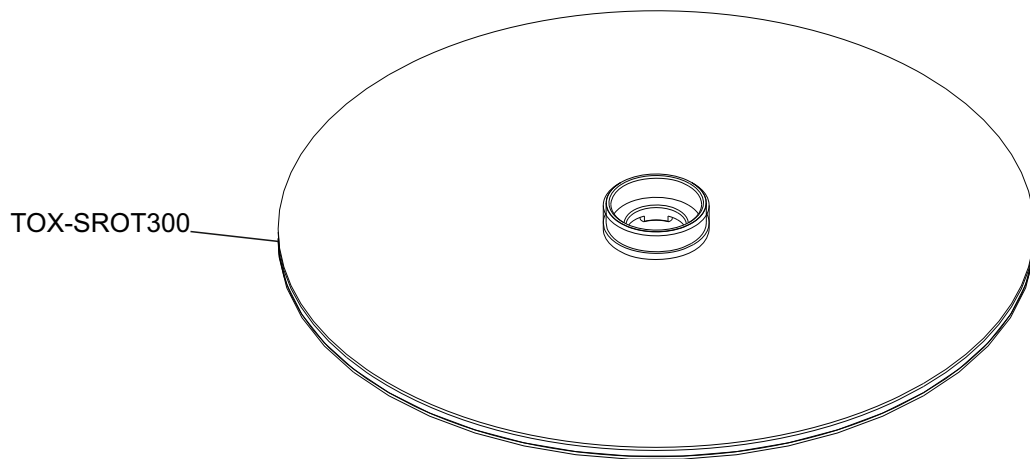
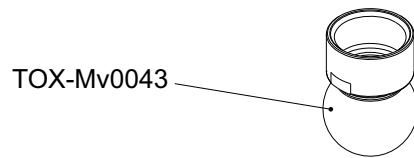
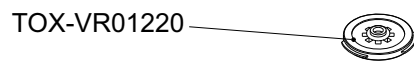
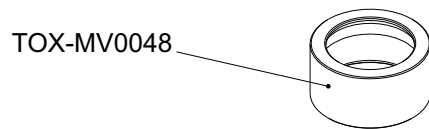
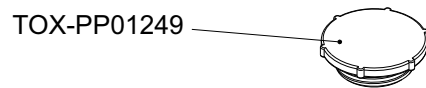

TOX340-S

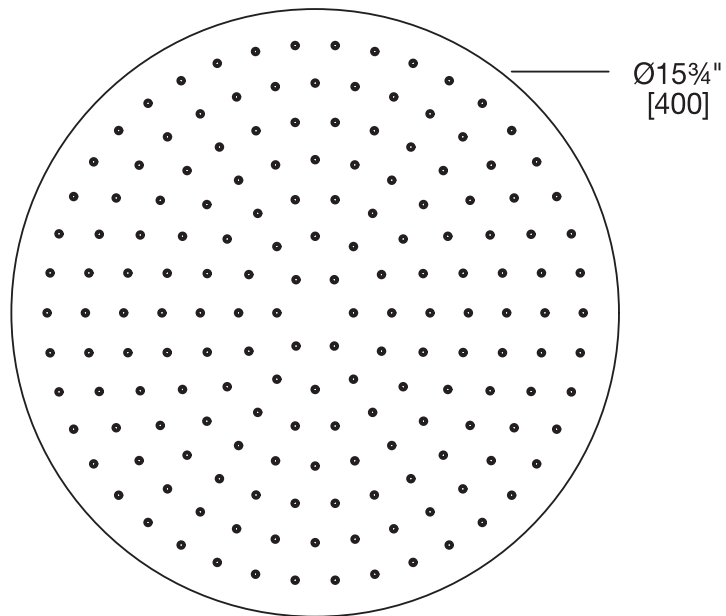
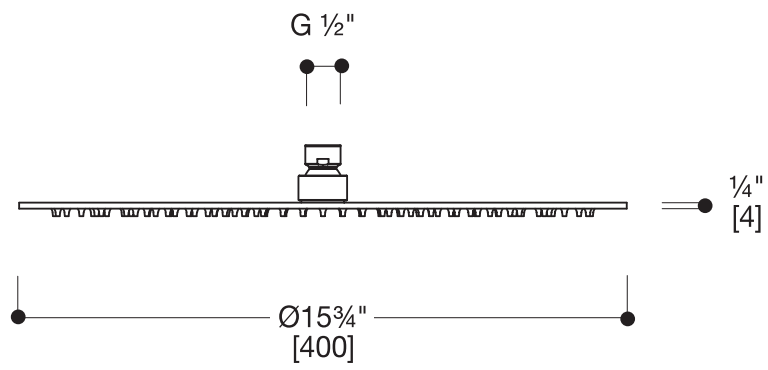

TOX340-S

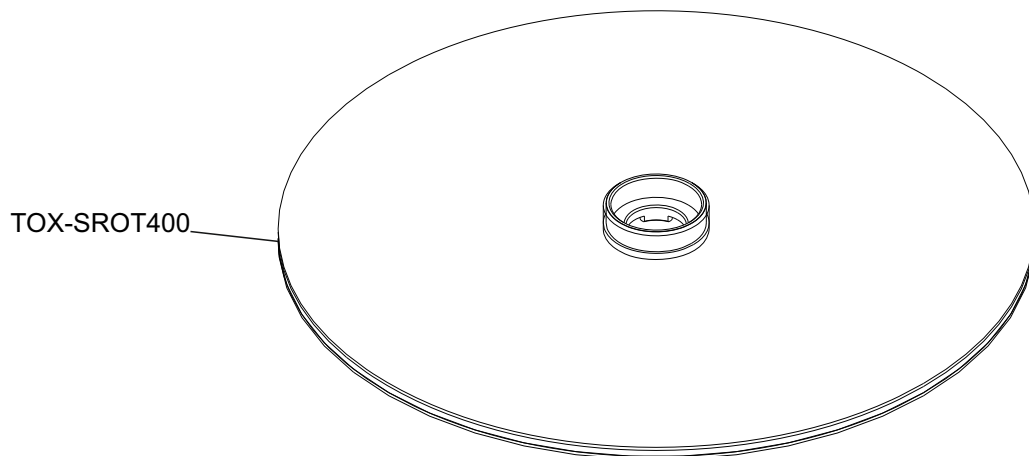
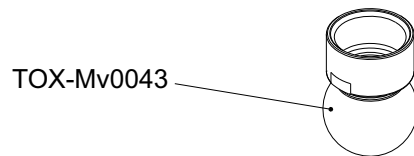
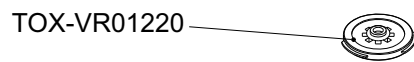
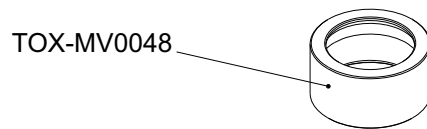
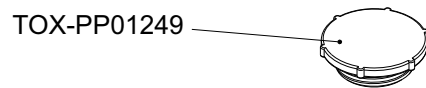

TOX420-S

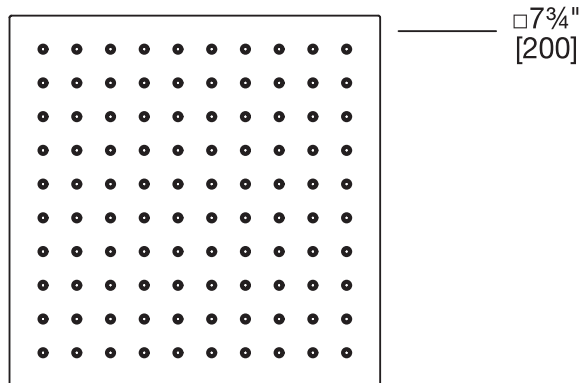
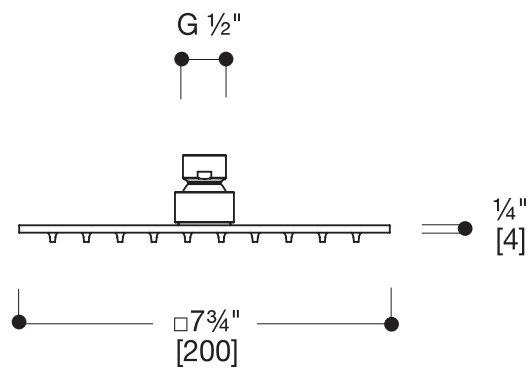

TOX420-S

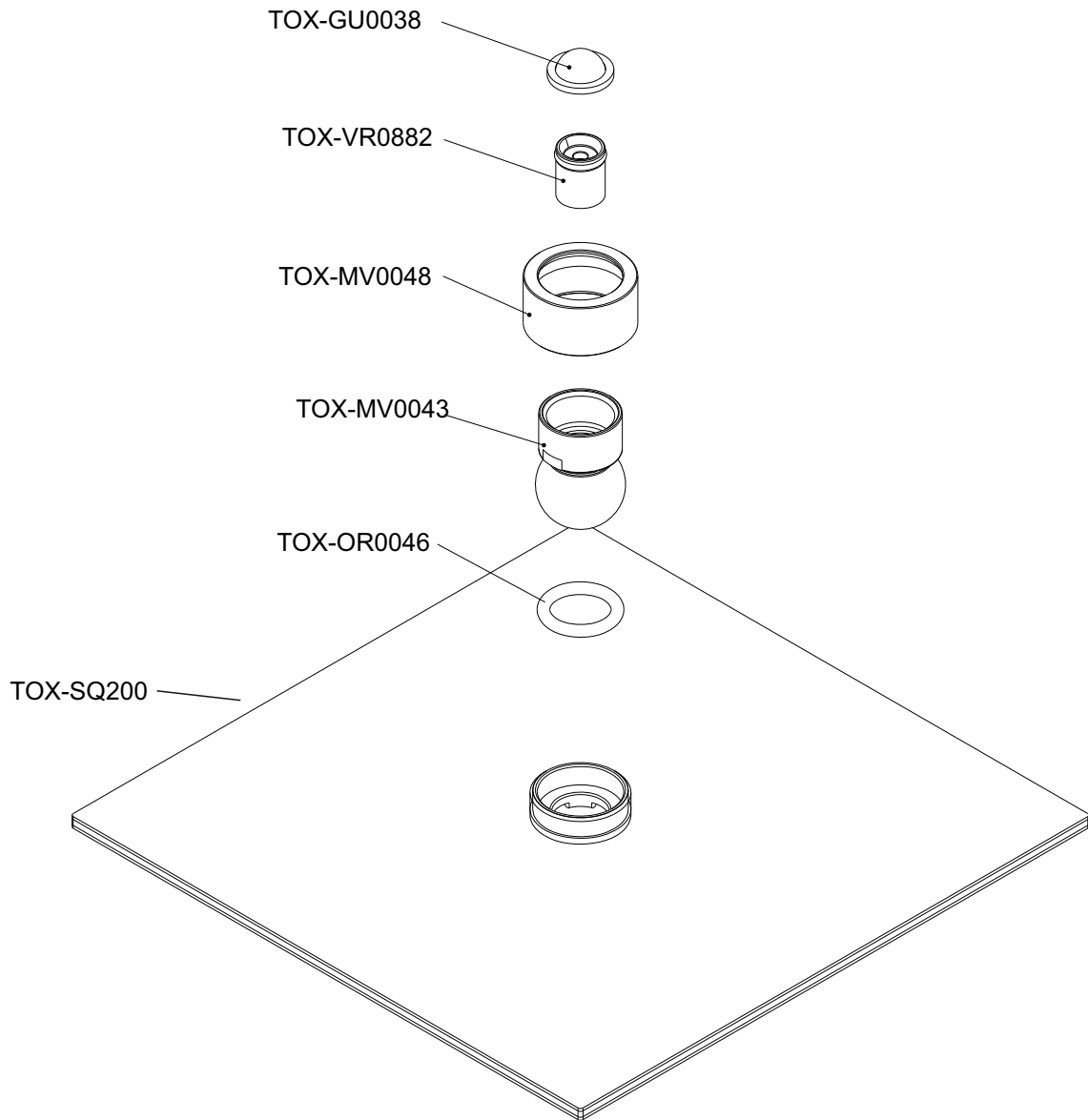

TOX430-S

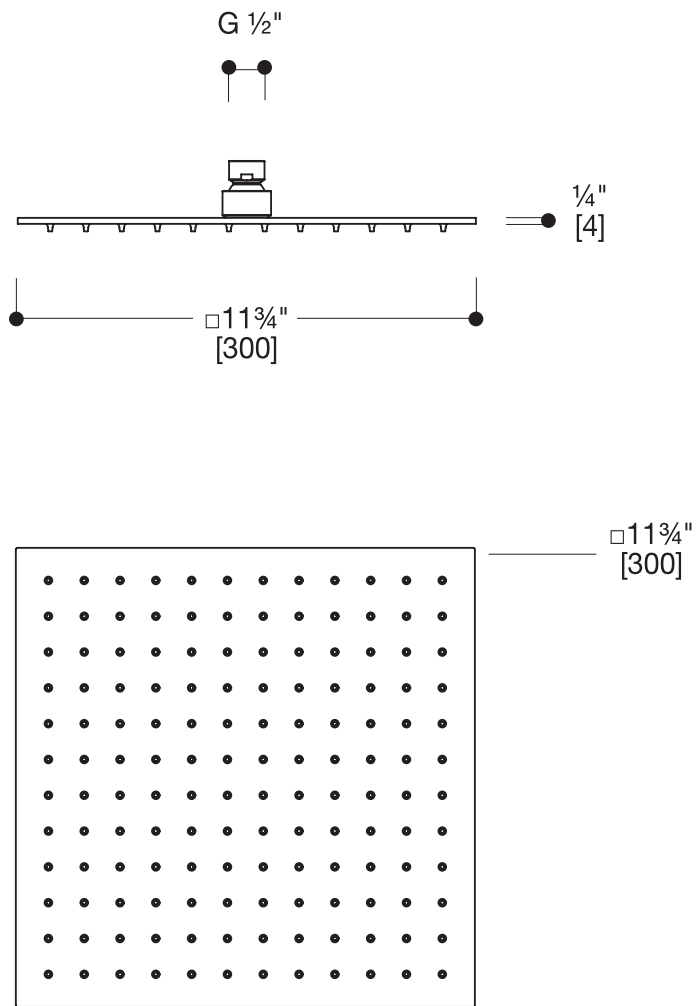

TOX430-S

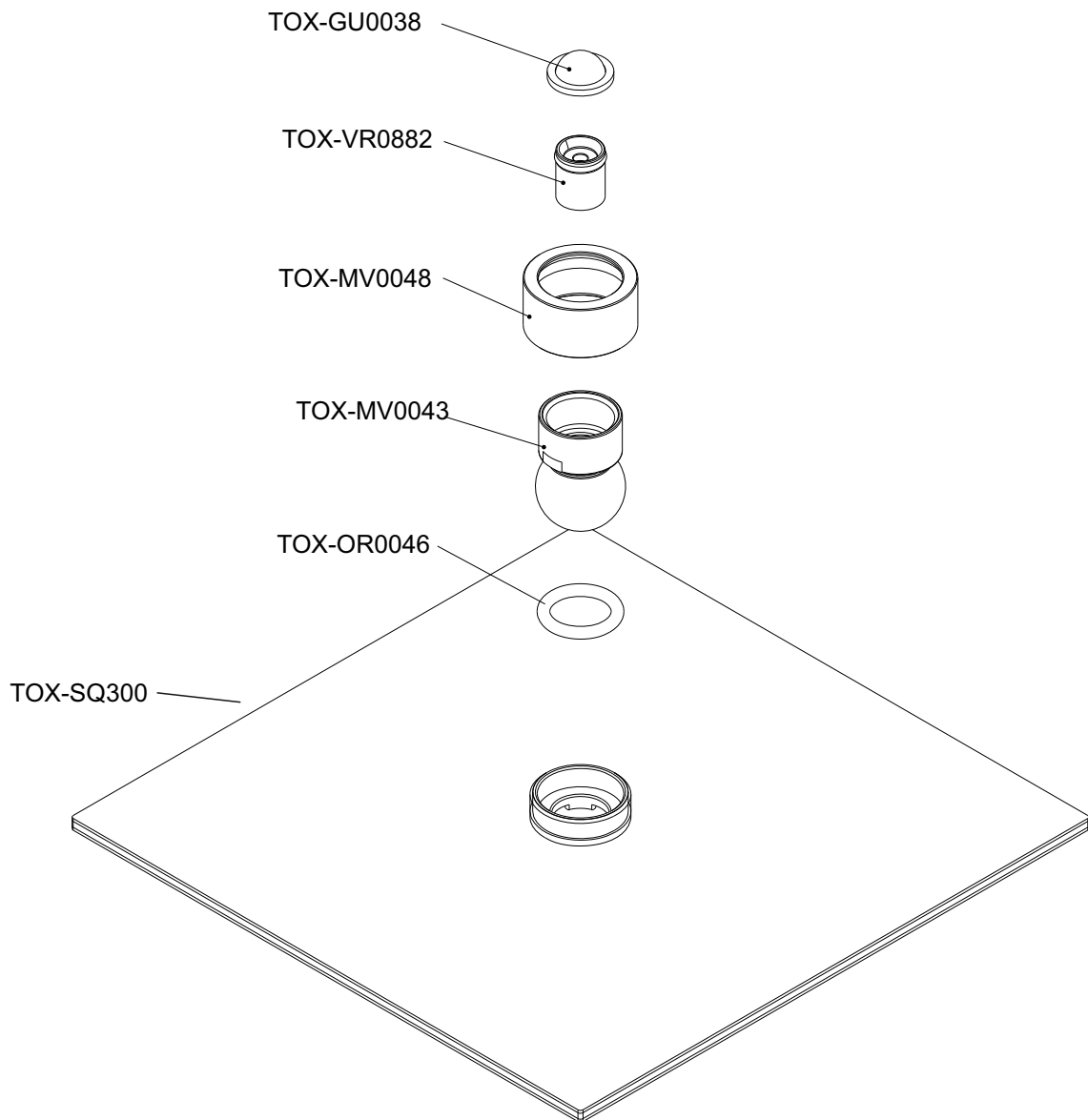

TOX440-S

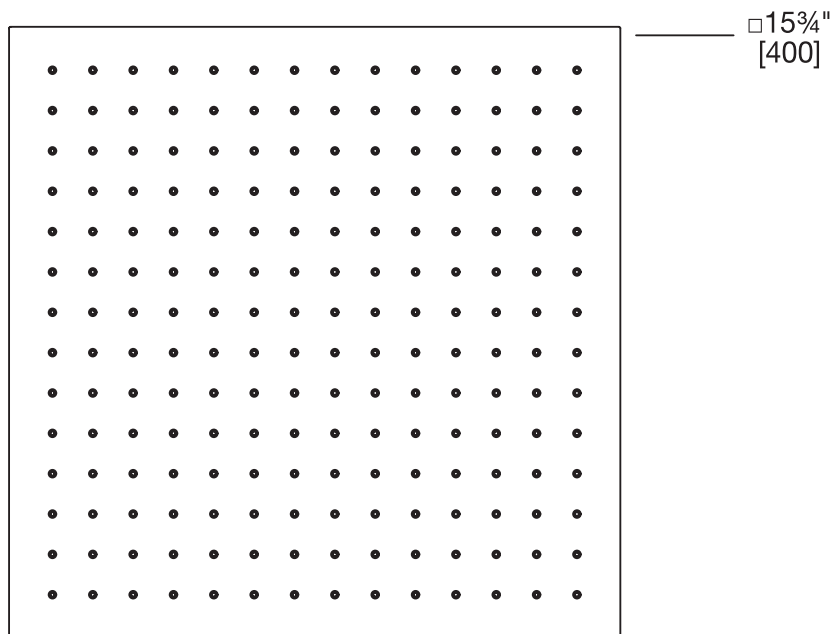
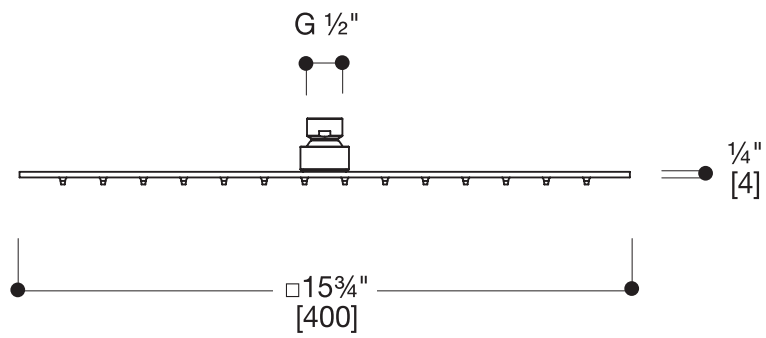

TOX440-S

