

Master Tailgaters

Rear View Mirror with HD DVR Recording and In Cabin Facing Camera

USER MANUAL



Model: MR-43-E2DVR3



This device complies with Part 15 of the FCC Rules. Operation is subject to the following two conditions:

- (1) this device may not cause harmful interference,
 - (2) this device must accept any interference received, including interference that may cause undesired operation.
- changes or modifications not expressly approved by the party responsible for compliance could avoid the user's authority to operate the equipment.

NOTE: This equipment has been tested and found to comply with the limits for a Class B digital device, pursuant to Part 15 of the FCC Rules. These limits are designed to provide reasonable protection against harmful interference in a residential installation. This equipment generates, uses and can radiate radio frequency energy and, if not installed and used in accordance with the instructions, may cause harmful interference to radio communications. However, there is no guarantee that interference will not occur in a particular installation.

If this equipment does cause harmful interference to radio or television reception, which can be determined by turning the equipment off and on, the user is encouraged to try to correct the interference by one or more of the following measures:

- Reorient or relocate the receiving antenna.
- Increase the separation between the equipment and receiver.
- Connect the equipment into an outlet on a circuit different from that to which the receiver is connected.
- Consult the dealer or an experienced radio/TV technician for help.

To maintain compliance with FCC's RF Exposure guidelines, This equipment should be installed and operated with minimum distance between 20cm the radiator your body: Use only the supplied antenna.



Caution

Entertainment video is not permitted when driving except for the navigation and backup camera display!

*** This manual is only for your reference.**

*** This DVR mirror can stop recording at any time, do not solely rely on the DVR mirror.**

TABLE OF CONTENTS

01 PACKAGE	- - - - - 1
02 FEATURES	- - - - - 2
03 SPECIFICATIONS	- - - - - 2
04 BASIC OPERATING INSTRUCTIONS	- - - - - 4
05 HOW TO WIRE	- - - - - 6
06 HOW TO INSTALL MIRROR MONITOR	- - - - - 7
07 BACK UP CAMERA DISPLAY	- - - - - 9
08 AUTOMATIC BRIGHTNESS ADJUSTMENT	- - - - - 9
09 CABIN AND DASH CAMERA LIVE VIEW MODES	- - - - - 10
10 MOBILE PHONE APP CONNECTION and OPERATION	- - - - - 11

PACKAGE

The package contains the following:

- 01 Full HD DVR rear view mirror
- 02 Wire harness
- 03 User manual

- 04 Wire cover
- 05 Extension cable
- 06 SD card (option)

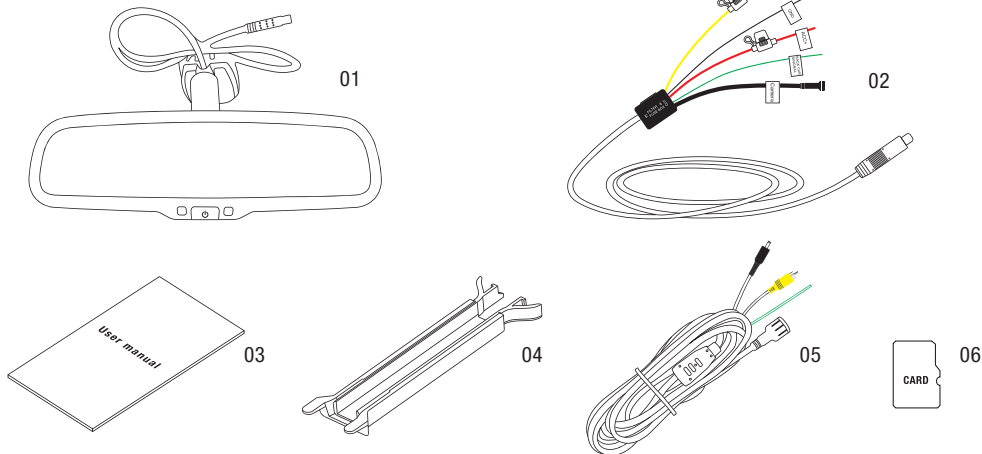

For the items listed above, please check your packing contents. If any damage, please contact the distributor or the agent as soon as possible.

FEATURES

- High brightness display screen
- Dual way recording
- Front camera recording 1080P
- G-sensor
- Auto screen off
- Auto record when car is on
- Parking mode recording
- Motion detection recording
- Loop recording
- Back up camera display
- Automatically brightness adjustment
- Auto-dimming (optional)

SPECIFICATIONS

main control chip	Taiwan Novatek 96658	Video signal	NTSC/PAL (defaulted as NTSC)
Screen size	4.3 inch	MIC	Support (default as ON)
Definition	1920*1080P	Memory card	2-32GB, over class 10
Recording angle	140 degree wide angle	Power supply mode	ACC
Video format	.MOV	Video mode	Seamless recording
Video footage	1 minutes (defaulted)	Temperature range	-31°F~167°F
Video resolution	HD, 1080P, 30F/S	Battery	None

Note: For the best performance and durability of video recording, we recommend to use C10 U1 level SD card or better.

1. SD cards can be made by several different ways using different memory types and formatting types. In general, two types are commonly found, MLC and TLC. TLC type cards are generally used in phones or other equipment that does mostly reading only, such as playing back ground music. MLC type cards are designed for devices that read and write often such as DVR's or video cameras. TLC type memory will often fail more often under heavy recording of this type.

2. We only recommend brand name, high quality SD (or TF) cards using MLC technology for this HD DVR mirror. Also only use cards with a 2K or higher (4k) recording speed. Using lower quality memory or incorrect speed memory will affect the recording quality and may cause system errors.

3. Most SD Cards have a working life of about 2 years. Heat, amount of recording time, and overall usage, as well as the quality of the card may vary as will the life of the card. Memory cards do need to be re-formatted from time to time and should be replaced at least once per year to insure your DVR performing as expected. Remember your DVR is always recording when it is on, this is not the same as a normal camera that only records when a picture is taken. We suggest using a 32GB MLC type SD memory card with a minimum speed of 90mb/s for the best recording quality and reliability.

4. This DVR uses new technology and relies heavily on the SD Card memory. If the mirror or SD card fail to operate correctly and fail to record an incident, the manufacturer or re-seller cannot be held responsible. We recommend you check your SD card regularly to insure the system is operating correctly. This device is designed for entertainment purposes only and you should check all local laws that may relate to using such a device in your vehicle. Always use carefully when driving as safety is always the drivers first responsibility.



BASIC OPERATING INSTRUCTIONS

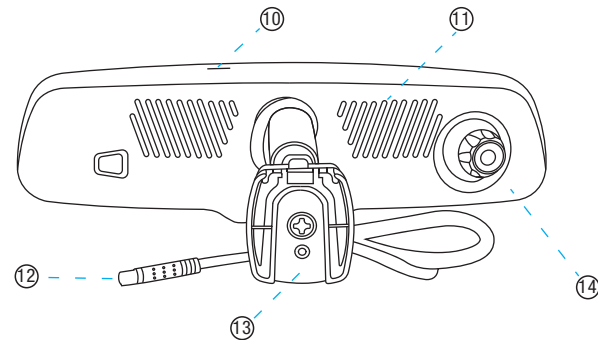
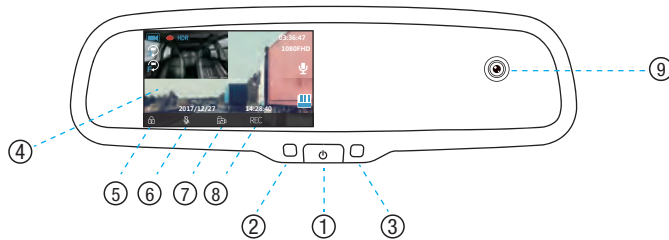

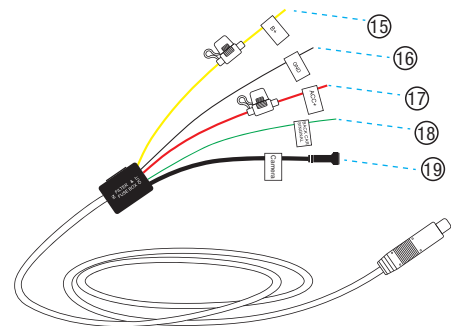

1	Power button: turn on/ off the screen off
2	Light sensor
3	Indicator
4	4.3 inch high brightness monitor
5	Lock the current video
6	Turn on/ off the mic

7	Short press: switch front and rear video screen Long press: open the Wi-Fi.
8	In recording/stop recording state: start/stop recording In the Wi-Fi interface: turn off Wi-Fi
9	Cabin camera
10	SD card slot (max 32GB)
11	Speaker
12	Cable connector
13	Windshield Bracket
14	Camera Lens
15	Yellow to battery
16	Black to Ground
17	Red to ignition +12V
18	Green to back up signal
19	To back up camera

HOW TO WIRE

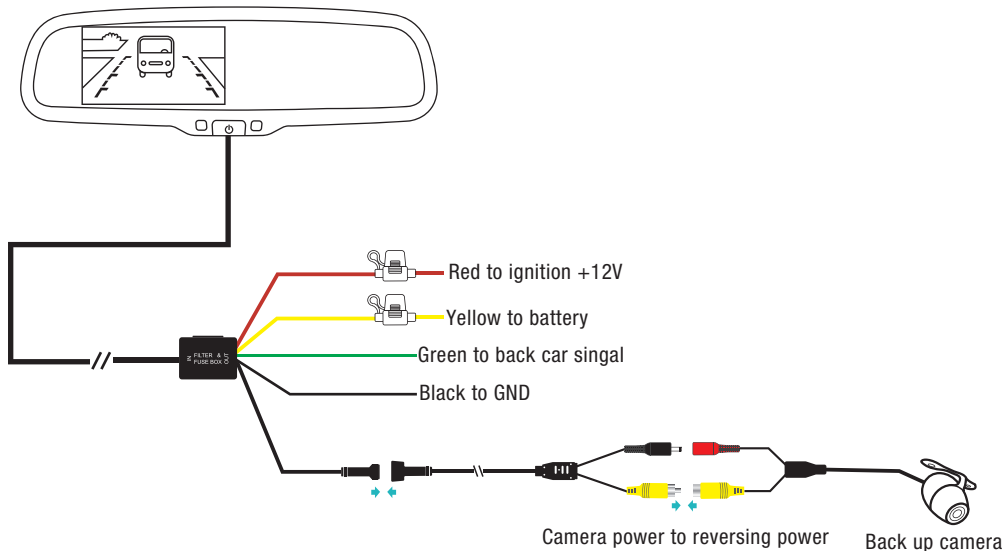

HOW TO INSTALL MIRROR MONITOR

Remove the original mirror

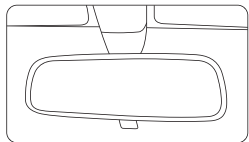

Car factory original mirror

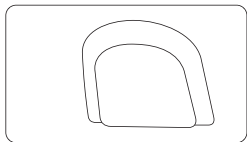

The plate on the windshield

Different cars have different brackets. It depends on your vehicle maker and manufacturer. There are many methods to remove the original rear view mirror, however, please don't force the mirror off the bracket.

Master Tailgaters will not be responsible for damage caused to your car by faulty installation of the mirror.

Install mirror monitor on the plate

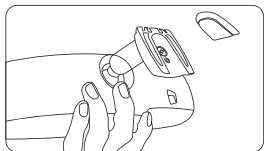

Take down your original mirror, and make the mirror monitor ready

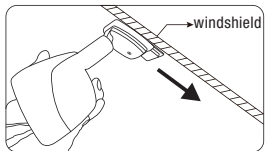

Install rear view mirror along this direction

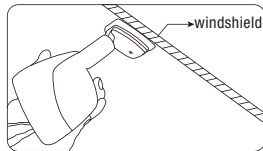

Please make sure to install the mirror to the end of the bottom without any loose

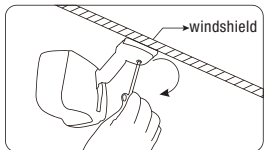

Contrarotate the fixed rear view mirror
Torque is about 0.8-1.3 N.m

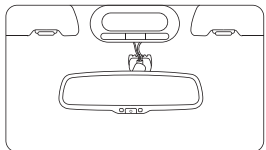

NOTE: Always use caution, DO NOT force the mount. Master Tailgaters not be responsible for broken windshields. If you are not sure how to remove or re-install the mirror seek trained, professional help.

CAUTION!

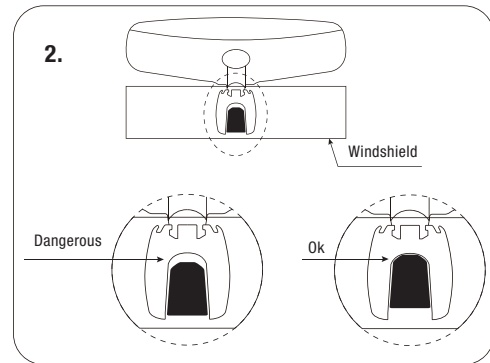
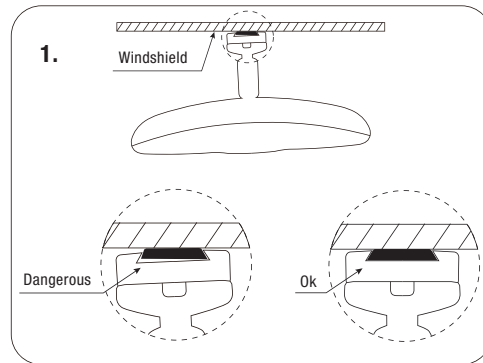

BACK UP CAMERA DISPLAY

When the car is reversing, the monitor will automatically display back up camera image.

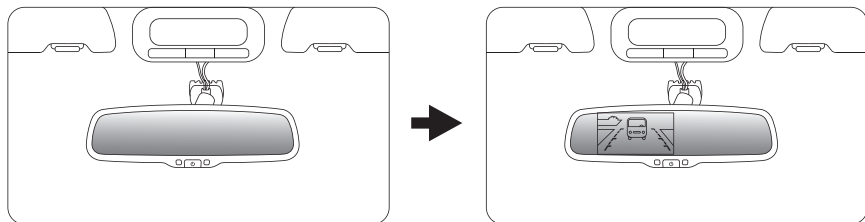

AUTOMATIC BRIGHTNESS ADJUSTMENT

Monitor brightness will change with the ambient light.

LOW LIGHT When ambient light is low, the screen will automatically reduce the brightness.

STRONG LIGHT When ambient light is bright, the screen will automatically increase the brightness and get better vision.

CABIN AND DASH CAMERA LIVE VIEW MODES

The cabin and dash cameras record automatically. The files are split into two separate files for each camera. A live view of each camera can be displayed on the LCD screen. To switch between the four display modes press the “” button.

The first press of “” will display the dashcam. The second press will display the dashcam view with a picture in picture display of the cabin camera. The third press will display the cabin camera with a picture in picture view of the dashcam. The fourth press will show the cabin camera view only.

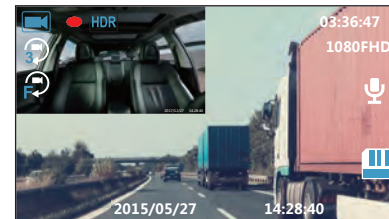

MOBILE PHONE APP CONNECTION and OPERATION

Built-in WiFi module system allows to connect mobile phone through Android or IOS APP, please check below for its setup.

1. Open APP store, search “RoadCam” to install or use quick search by scan QR code.

2. Long press “” button to turn on mirror’s Wi-Fi function.

3. Enter mobile phone interface, turn on Wi-Fi and connect Wi-Fi ID (default name CARDV-Wi-Fi*, “*” is system MAC address, please see figure 1), enter initial password: 12345678, then connect.

4. open mobile phone APP, click the button “” at top right corner (please see figure 2), add the device.

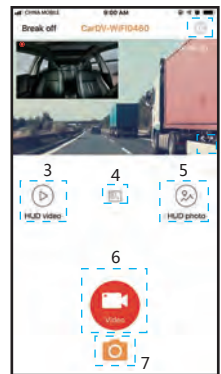

figure 1



figure 2

5. Once the device is connected successfully, user can check the recording video and operate accordingly.



Recording interface

1. Setting
2. Full Screen Switch
3. HUD video
4. Video Switch
5. HUD photo
6. video
7. photo

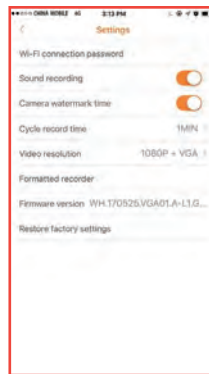

Click to enter the settings interface



Click to enter the settings interface
Choose cycle record time to set the cycle record time

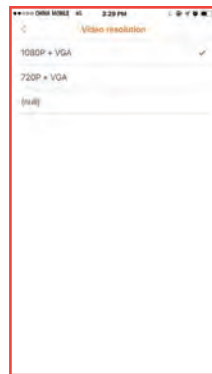

Click to enter the settings interface
Choose video resolution to set the size of video resolution

INDICATOR LIGHT

Mirror indicator light has two status: green indicator light and red indicator light (when Wi-Fi is on, indicator light is green). If light is flickering, it means mirror is recording, no matter it's green or red light.

If indicator light keeps lighting, it means DVR stop recording; If indicator light is off, it means mirror has no power.

FILES LOCK

The mirror can save max 15 locked emergency video files (recording time can be set as 1min, 2mins, 3mins by users). The sixteenth video will automatically replace the first one and will be saved as lock files.

AUDIO RECORDING

Whether it is front video or rear view video, the video recordings will have no voice unless user turns on the microphone. If the voice button is in mute state, all videos won't have voice.

TROUBLE SHOOTING

Q: Indicator lights up and mirror is a little hot, but the LCD screen is off.

A: Indicator lights up, it means mirror is powered on. The power button is pressed unconsciously by users to make LCD screen is turned off. Short press power button to open screen display.

Q: After installation, mirror keeps beeping sound.

A: Beeping sound shows mirror isn't recording. This reason is that no SD card inside the mirror or SD card format is incompatible. (Factory recommends 32GB, FAT32, C10, U1-U3, see SD card sticker near the card slot.)

Q: Mirror is frozen and can't normally work.

A: To restart the mirror by removing the buttcock line of the rear view mirror.

IMPORTANT FUNCTION INTRODUCTION

PARKING MODE

Parking mode needs to work together with G-sensor. G-sensor is default open and the sensitivity is middle. After connecting with APP, user can set the G-sensor sensitivity from the menu through cellphone APP. After driver parks the car and leaves, the mirror will start to record 1/2/3 minutes (user can set this from cellphone APP) if the car feels shake, then lock and keep the video automatically.

Mirror will stop recording if there is no shake; Mirror will keep recording if it feels shake.

NOTE:

1. There is no Motion Detection function.
2. Android cellphone can't set G-sensor sensitivity through cellphone APP.
3. If driver leaves car for a long time, the Parking Mode function may cause the car's battery to lose electricity, even lead to the car can't start. User should connect the yellow wire to ACC if don't want to use parking mode function.

User should connect the yellow wire to ACC if don't want to use parking mode function.

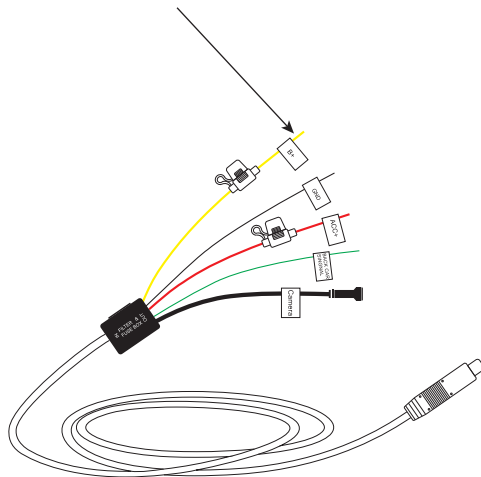

WI-FI CONNECT

1. Download “ RoadCam” APP.

The boot screen is Wi-Fi interface after mirror power on, and Wi-Fi is default open, the Wi-Fi name and password is displayed on the screen (Picture 1).

Now user can connect mirror's Wi-Fi through cellphone (picture 2).

2. Open APP, short press the button  to choose and add recorder (picture 3).

The display mode is “picture in picture” (front and car interior videos will be displayed at the same time) when first connection, user can choose the display mode on cellphone APP (picture 4).

There will be an indication “Press OK to Disconnect” (picture 5) on screen after mirror connect to cellphone's Wi-Fi successfully. “OK” refer to the touch button  .

Now user can only do one operation: turn off Wi-Fi through short press button  .

Under this status, other operation is unavailable.

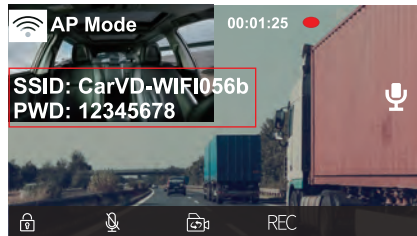

Picture 1



Picture 2



Picture 3

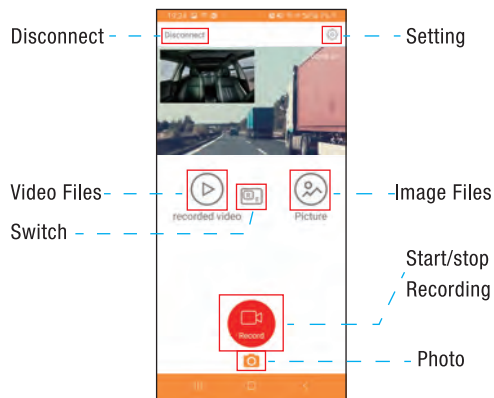



Picture 4



Picture 5

NOTE:

1. When connecting cell phone and car rear view mirror via Wi-Fi, the video can't be uploaded in the APP. Please check your Wi-Fi connection in the setting of the phone if it is mirror's Wi-Fi. Because some cell phones will automatically switch to other strong signal Wi-Fi which can support Internet. If failed Wi-Fi connection, the video can't be uploaded in the APP interface.

2. Disconnect Wi-Fi, the connection between cell phone and mirror is disconnected. Long press the button  to open Wi-Fi again, short press  to turn off Wi-Fi.

3. In order to protect the driver's privacy and safety, Wi-Fi should be connected again after driver restart the car.