

This device complies with Part 15 of the FCC Rules. Operation is subject to the following two conditions:

- (1) this device may not cause harmful interference,
  - (2) this device must accept any interference received, including interference that may cause undesired operation.
- changes or modifications not expressly approved by the party responsible for compliance could avoid the user's authority to operate the equipment.

NOTE: This equipment has been tested and found to comply with the limits for a Class B digital device, pursuant to Part 15 of the FCC Rules. These limits are designed to provide reasonable protection against harmful interference in a residential installation. This equipment generates, uses and can radiate radio frequency energy and, if not installed and used in accordance with the instructions, may cause harmful interference to radio communications. However, there is no guarantee that interference will not occur in a particular installation.

If this equipment does cause harmful interference to radio or television reception, which can be determined by turning the equipment off and on, the user is encouraged to try to correct the interference by one or more of the following measures:

- Reorient or relocate the receiving antenna.
- Increase the separation between the equipment and receiver.
- Connect the equipment into an outlet on a circuit different from that to which the receiver is connected.
- Consult the dealer or an experienced radio/TV technician for help.

To maintain compliance with FCC's RF Exposure guidelines, This equipment should be installed and operated with minimum distance between 20cm the radiator your body: Use only the supplied antenna.



**Entertainment video is not permitted when driving except for the navigation and backup camera display!**

\* **This manual is only for your reference.**

Serial No.: 2018EK043LAP0326

*Master  
Tailgaters*

## 4.3 inch Rear View Mirror Monitor with Parking Sensor

USER MANUAL



Model: MR-43-P2



# 1 CONTENTS

The package contains the following:

- |                             |                               |
|-----------------------------|-------------------------------|
| 01 Rear view mirror monitor | 06 Parking sensor accessories |
| 02 Wire harness             | 07 Drill                      |
| 03 Parking sensor           | 08 User manual                |
| 04 Extension cable 1        | 09 Wire cover                 |
| 05 Extension cable 2        | 10 Remote control             |

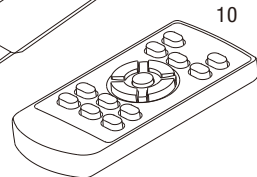
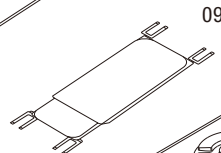
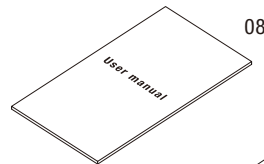
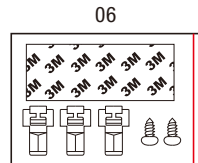
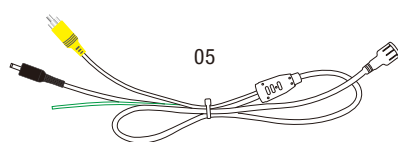
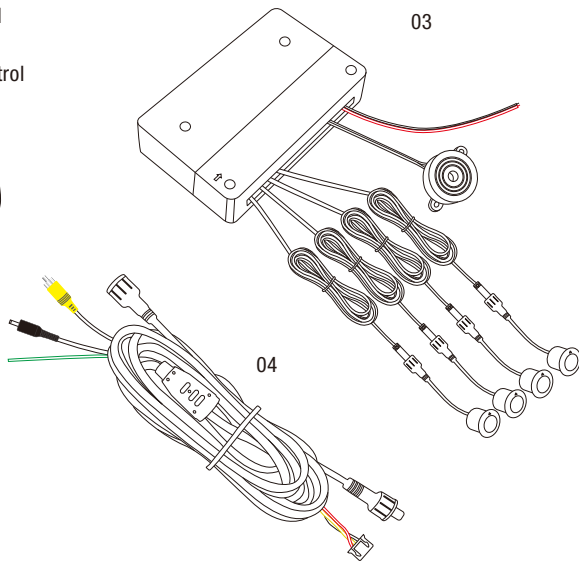
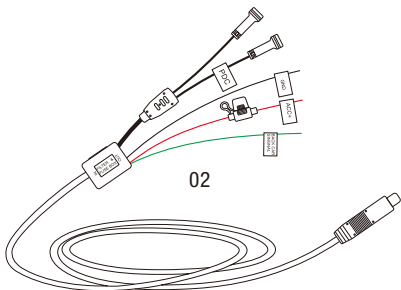
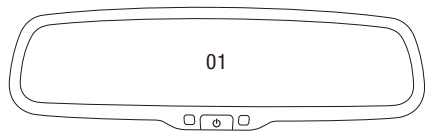

## 2 FEATURES

- 4.3 inch ultra high brightness display screen
- Automatic brightness adjustment
- Adjustable back up guide line
- Parking sensor
- Back up camera display
- 4.0 mm glass and car factory OEM bracket
- 2-way video inputs

## 3 SPECIFICATIONS

- Display Type: TFT-LCD
- Compatible Systems: PAL / Auto / NTSC
- Working Voltage: 12V DC
- Screen Size: 4.3 inch
- Resolution: 480(H) X 272(V)

## 4 HOW TO INSTALL MIRROR MONITOR

### Remove the original mirror

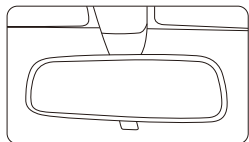

Car factory original mirror

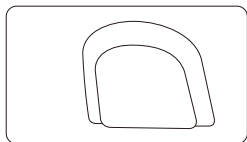

The plate on the windshield

Different cars have different brackets. It depends on your vehicle maker and manufacturer. There are many methods to remove the original rear view mirror, however, please don't force the mirror off the bracket.

Master Tailgaters is not responsible for damage caused to your car by faulty installation of the mirror.

### Install mirror monitor on the plate

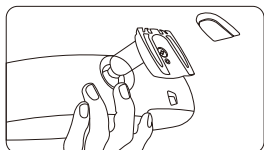

Take down your original mirror, and make the mirror monitor ready

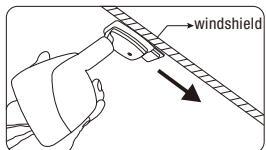

Install rear view mirror along this direction

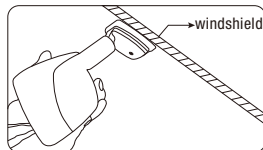

Please make sure to install the mirror to the end of the bottom without any loose

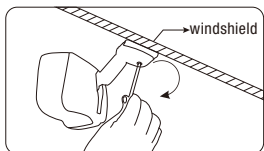

Contrarotate the fixed rear view mirror  
Torque is about 0.8-1.3 N.m

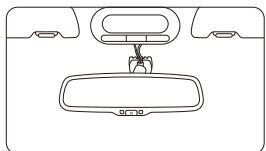

**NOTE: Always use caution, DO NOT force the mount. Master Tailgaters not be responsible for broken windshields. If you are not sure how to remove or re-install the mirror seek trained, professional help.**

### CAUTION!

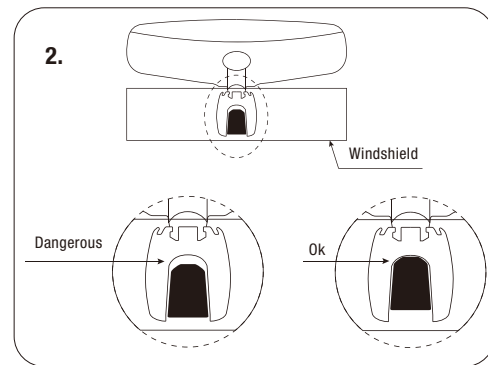
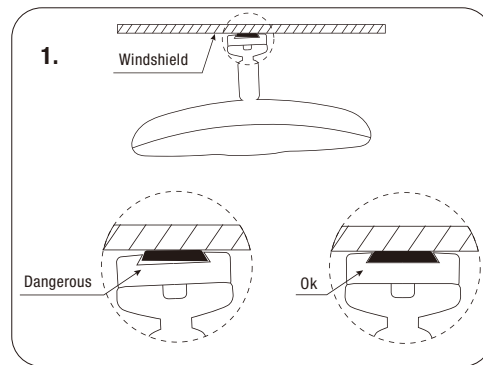

## 5 HOW TO WIRE

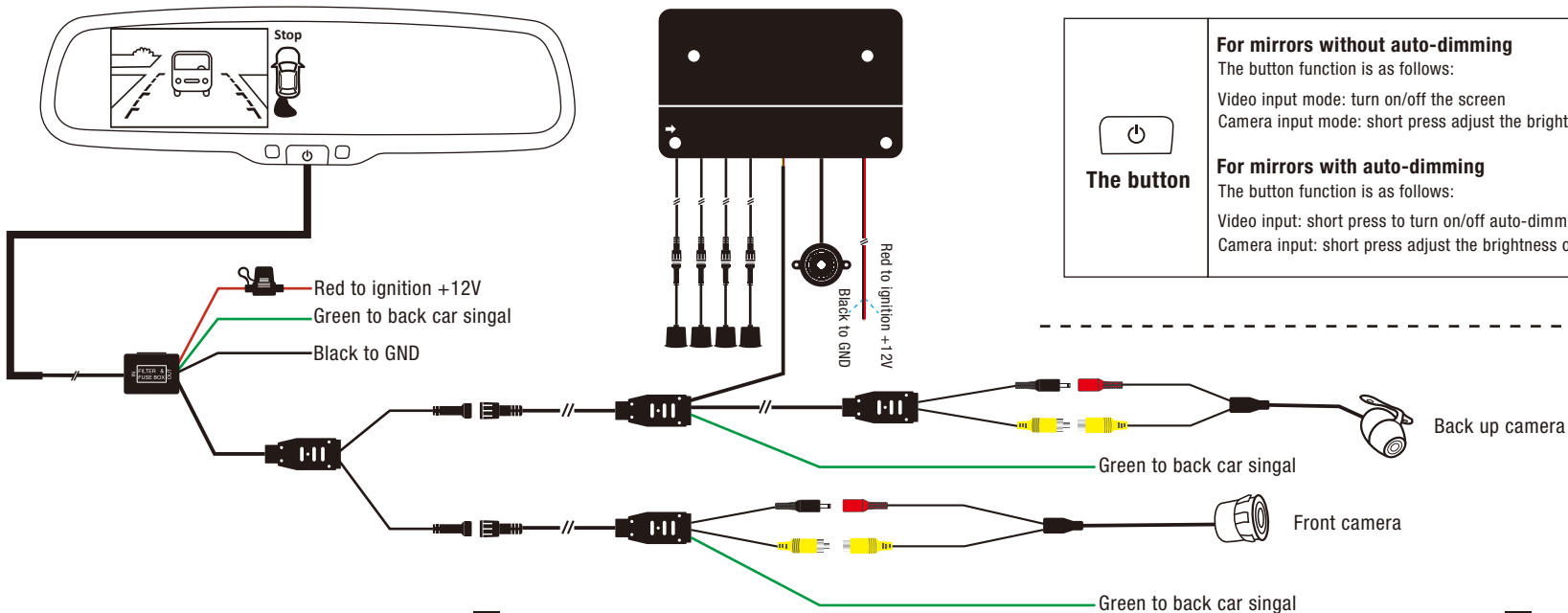

5

## 6 FUNCTION OF BUTTON



The button

### For mirrors without auto-dimming

The button function is as follows:

Video input mode: turn on/off the screen

Camera input mode: short press adjust the brightness of the screen; long press to turn on/off.

### For mirrors with auto-dimming

The button function is as follows:

Video input: short press to turn on/off auto-dimming; long press to turn on/off the screen.

Camera input: short press adjust the brightness of the screen; long press to turn on/off.

The three green trigger lines are interlinked. When installing, users can connect any of them according to the actual situation.

6

## 7 BACK UP CAMERA DISPLAY

When the car is in reverse, the monitor will automatically display back up camera.

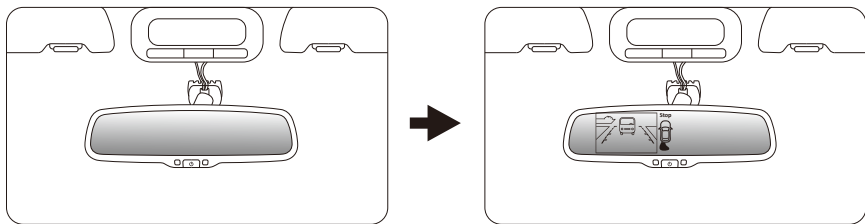

## 8 AUTOMATIC BRIGHTNESS ADJUSTMENT

Monitor brightness will change with the ambient light.

**LOW LIGHT** When ambient light is low, the screen will automatically reduce the brightness.

**BRIGHT LIGHT** When ambient light is bright, the screen will automatically increase the brightness.

## 9 MENU SETTING

The menu can only be set by remote control.

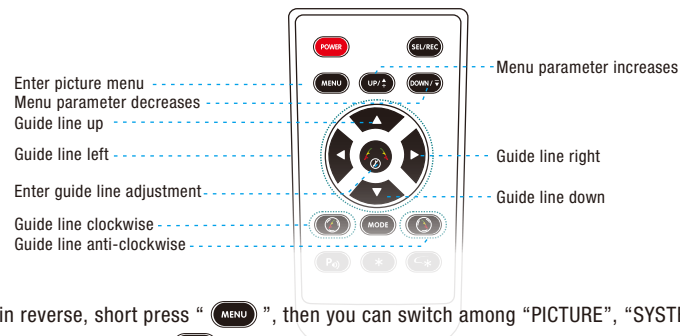

When the car is in reverse, short press “MENU”, then you can switch among “PICTURE”, “SYSTEM”, or enter out.

When you enter “PICTURE”, press “SEL/REC” to switch among the items.

“UP/↑” and “DOWN/↓” Are for changing the figure of each setting. “SYSTEM” setting is same as explanation above.

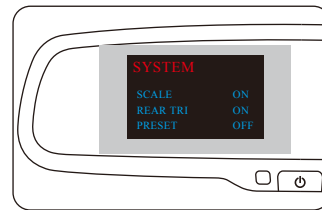
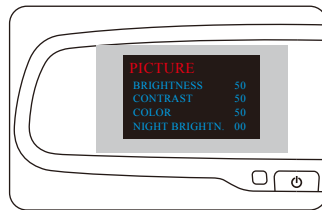

## 10 ADJUSTABLE GUIDE LINE

### About guide lines

To help drivers estimate the distance from obstacles, there are three lines for reference: red, yellow, and green. The lines are displayed on the monitor when reversing. The green line is 3 meters away from the back of the car and the yellow is 2 meters. The distant red line is 1 meter away from the backside of the car and the close red line is 0.4 meters away. Both reference lines on the left and right should leave 0.2 meters away from the car.

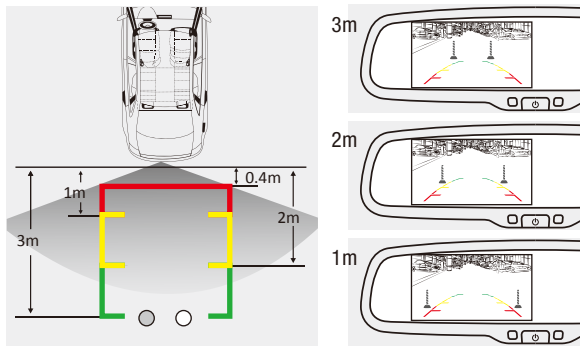

### What the regular guide line is



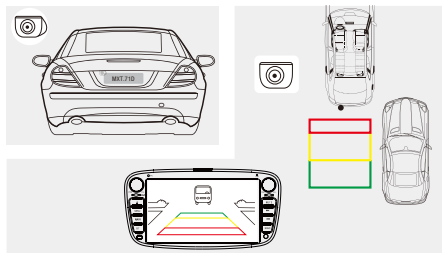



Regular guide line is fixed. But installation sites of cameras are different as well as car size. The fixed guide line is not accurate enough for drivers. There is a great difference among regular and fixed guide lines and car's real guide lines, especially when camera is mounted on the left or right side of car backside.



### How to adjust the guide lines

According to the site of standard reference line, we can put references such as desks in the back side of the car. Compared with the marked references, we can adjust the sites and angles of two guide lines displayed on the monitor. You will get the accurate and safety guide lines once it coincides with the references.

Press setting button  to enter "guide line adjustment" mode. The system is defaulted to adjust left guide line first. Press the button again to switch to adjust the right guide line.

The up , down , left  and right  buttons are to adjust the corresponding location of guide lines. The clockwise rotation  and contra rotating  buttons are to adjust the angles of guide lines. It is easy to operate and calibrate. calibration finished, switch the reverse gear to save the information.

**Caution: keep the remote control 0.5m-1.0m from rearview mirror when you use the remote to adjust the parking lines.**

