

## POP™ MODE ALERTS



### POP™ Mode Alerts





Because POP™ Mode radar utilizes the same K or Ka band frequencies, POP™ Mode Alerts will be displayed as regular radar alerts.

## OPTION SELECT MODE

### Option Select Mode

Press the Menu button to enter Option Select Mode. Each press of the Menu button changes to the next selectable feature. The Dark (D) button and the Quiet (Q) button turns the feature ON/OFF or Blinking for example. A decimal point on model Z-15R will indicate a feature is ON; Model Z-11R will illuminate the “III” icon. When the feature is off these indicators will not be shown. A button must be pressed within 20 seconds or Option Select Mode will automatically be exited.

Z-11R FEATURE:	OPTION:
VG-2 (default = OFF) 	D for ON, Q for OFF
Alert Periscopes (default = Blinking with alert)	D or Q for ON, OFF, BLINKING
POP™ Mode (default = OFF) 	D for ON, Q for OFF

Z-15R FEATURE:	OPTION:
VG-2 (default = OFF) 	D for ON, Q for OFF
Alert Periscopes (default = Blinking with alert)	D or Q for ON, OFF, BLINKING
POP™ Mode (default = OFF) 	D for ON, Q for OFF
SWS™ (default = OFF) 	D for ON, Q for OFF
TFSR (default = OFF) 	D for ON, Q for OFF

**Note:** To exit Option Select Mode press and hold the menu button.

15

16

## WARRANTY INFORMATION

### Consumer Warranty

This Whistler Laser/Radar detector is warranted to the original purchaser for a period of two years from the date of original purchase against all defects in materials and workmanship. This limited warranty is void if the unit is abused, modified, installed improperly, if the housing has been removed, or if the serial number is missing. There are no express warranties covering this product other than those set forth in this warranty. All express or implied warranties for this product are limited to the above time. Whistler is not liable for damages arising from the use, misuse, or operation of this product.

**Note:** Units that cannot be repaired will be replaced with the same or similar model. Replacement unit’s warranty will be based on the original unit’s purchase date.

22

## OPTION SELECT MODE

### Reset Features

All user features can be reset to factory settings.

### Factory Reset

1. Unplug Power Cord from unit
2. Press and hold Quiet
3. Plug the Power Cord into the unit (Power switch turned on)
4. Wait for 2 beeps
5. Release the Quiet button

**Unit is now reset.**

### Factory Settings are:

- Highway Mode
- Dim/Dark Mode to full illumination of display
- Auto Quiet Mode OFF
- VG-2 Detection Mode OFF
- Self Test Mute OFF
- Voice™ ON (Z-15R Only)
- Alert Periscope to Flash
- POP™ Mode OFF
- SWS™ OFF
- TFSR OFF (Z-15R Only)

## TROUBLESHOOTING GUIDE

Your Whistler detector is expertly engineered and designed to exacting quality standards to provide you with reliable, trouble-free operation. If your unit has been correctly installed following the guidelines in this manual, but is not operating optimally, please refer to the troubleshooting guide below.

**PROBLEM:** No display or audio. Check fuse in plug; replace if necessary with a 2 amp, 3AG type. Check fuse for lighter socket; replace if necessary. Make sure the lighter socket is clean.

16

## WARRANTY INFORMATION

### Service Under Warranty

During the warranty period, defective units will be repaired without charge when returned with a dated store receipt to the address below. Units returned without dated store receipt will be handled as described in section “**Service Out Of Warranty.**” Due to the specialized equipment necessary for testing a laser/radar receiver, there are no authorized service stations for Whistler brand detectors other than Whistler.

When returning a unit for service, please follow these instructions:

1. Ship the unit in the original carton or in a suitable sturdy equivalent, fully insured, with return receipt requested to:

**Whistler Repair Dept.**  
551 N. 13th St.  
Rogers, AR. 72756

**Please allow 3 weeks for turn around time.**

**IMPORTANT:** Whistler will not assume responsibility for loss or damage incurred in shipping. Therefore, please ship your unit insured with return receipt requested. **COD’s will not be accepted!**

2. Include with your unit the following information, clearly printed:

- Your name and street address (for shipping via UPS), a daytime telephone number and an e-mail address, if applicable.
- A detailed description of the problem (e.g., “Unit performs self-test but does not respond to radar”).
- A copy of your dated store receipt or bill of sale.

23

## TROUBLESHOOTING GUIDE

Cancel Auto Quiet Mode or City Mode. Check audio level setting (see pg.7-9).

**PROBLEM:** Unit alarms when vehicle hits bumps. Check for loose lighter socket; tighten and clean. Check connections at both ends of power cord. Substitute another cord to determine if the cord is defective. Return the defective cord to the factory.

If difficulties occur which cannot be solved by information in this Troubleshooting Guide, please call Whistler Customer Service at **1-800-531-0004** or visit our FAQ page at [www.whistlergroup.com](http://www.whistlergroup.com) before returning your unit for service.

## Care & Maintenance

During the summer months, avoid prolonged exposure to direct sunlight by removing your unit from the dash when your vehicle is parked for an extended period of time. Do not spray water, cleaners, or polishes directly onto the unit. The spray may penetrate through the openings and damage the unit. Also, do not use any abrasive cleaners on the unit’s exterior.

17

## WARRANTY INFORMATION

3. Be certain your unit is returned with its serial number. For reference, please write your unit’s serial number in the space provided on page 27 of this manual.

**Units without serial numbers are not covered under warranty.**

**IMPORTANT:** To validate that your unit is within the warranty period, make sure you keep a copy of your dated store receipt. You may register your product online at [www.whistlergroup.com](http://www.whistlergroup.com), however, for warranty verification purposes, a copy of your dated store receipt must accompany any unit sent in for warranty work.

### Service Out of Warranty

Units will be repaired at “out of warranty” service rates when:

- The units original warranty has expired.
- A dated store receipt is not supplied.
- The unit has been returned without its serial number.
- The unit has been abused, modified, installed improperly, or had its housing removed.

24

## ARE DETECTORS LEGAL?

### In Most States YES!

Laser-Radar detectors are legal in every state for automobiles and light trucks (under 10,000 lbs.) except Virginia and Washington, D.C., which have local regulations restricting the use of radar receivers in any vehicle.

The Federal Highway Administration (FHWA) passed a nationwide regulation, effective January 1994, which prohibited radar and laser detector use in vehicles over 10,000 lbs.

### FCC Information

**FCC ID: HSXWH10 - Z-11R/Z-15R**

This device complies with part 15 of the FCC Rules. Operation is subject to the following two conditions:

(1) this device may not cause harmful interference.

(2) this device must accept any interference received, including interference that may cause undesired operation.

**IMPORTANT:** FCC requirements state that changes or modifications not expressly approved by Whistler could void the user’s authority to operate the equipment.

18

## WARRANTY INFORMATION

### Service Out of Warranty (Continued)

The minimum out of warranty service fee for your Whistler Z-11R detector is \$35.00 (U.S.) and \$40 (U.S.) for the Z-15R detector. If you require out of warranty service, please return your unit as outlined in the section “Service Under Warranty” along with a certified check or money order in the amount of \$35.00 for the Z-11R detector and \$40 for the Z-15R detector. Payment may also be made by MasterCard, VISA or American Express; **personal checks are not accepted.**

**In the event repairs cannot be covered by the minimum service fee, you will be contacted by a Whistler technical service specialist who will outline options available to you.**

If you elect not to have your unit repaired, it will be returned to you along with your certified check or money order.

**IMPORTANT:** When returning your unit for service, be certain to include a daytime telephone number and an email address (if applicable).

### Customer Service

If you have questions concerning the operation of your Whistler detector, or require service during or after the warranty period, please call Customer Service at:

**1-800-531-0004**

Representatives are available to answer your questions Monday - Friday from 8:00 a.m. to 5:00 p.m. (CT).

[www.whistlergroup.com](http://www.whistlergroup.com)



25

## SPEED MONITORING

### Radar Facts

A radar gun operates by transmitting radio waves at certain frequencies which reflect off objects and are then picked up by the radar gun’s receiving section. When a radar beam reflects off a moving target, a measurable frequency shift occurs. The radar unit converts this shift into miles per hour to determine your vehicle’s speed. Currently, the FCC (Federal Communications Commission) permits operation of traffic radar guns at X Band (10.500 - 10.550 GHz), K Band (24.050 - 24.250 GHz), and Ka Band (33.400 - 36.000 GHz).

**Note:** A radar detector will only alarm if an officer is transmitting on any one of the above radar bands.

### Laser Facts

It’s well documented that many radar guns cannot reliably provide the speed of a targeted vehicle that is traveling in a group of vehicles. In contrast, a laser gun can target a specific vehicle out of a line of traffic and determine its speed. The advantage of laser over radar in terms of target identification is the result of the laser gun’s narrow beam. A radar transmission can cover more than a four-lane highway at a distance of 1,000 feet, compared with a laser transmission which covers about 3 feet at the same distance. For best protection, keep these points, listed on the following section, in mind:

19

## SPECIFICATIONS

### Laser Wavelength:

905 ± 50 nanometers (nm)

### Radar Frequencies:

10.500 - 10.550 GHz (X Band)  
24.050 - 24.250 GHz (K Band )  
33.400 - 36.000 GHz (Ka Superwideband)

### Operating Temperature Range:

-10 C to +70 C (14 F to +158 F)

### Power Requirements:

Operational 12 to 15 volts DC, 250mA nominal  
Vehicle Battery Saver, 30mA nominal.

One or more U.S. patents may apply:  
#5,666,120, #7,215,276

POP™ Mode is a trademark of MPH Industries, Inc.

SWS® is a trademark of Safety Warning System L.C.

Specifications are subject to change without notice.

26

## SPEED MONITORING

### Laser Facts (Continued)

- Because the vehicle’s license plate or headlights are the laser gun’s primary targets, mounting the Whistler detector on the dashboard can improve laser detection at short range.
- Do not follow closely behind any vehicle. If you can’t see past a vehicle ahead of you, chances are your detector won’t either.
- The receiving range of laser signals will not be the same as radar signals. Laser guns are most often used at short range.
- Whistler Laser-Radar detectors receive all current laser guns which operate at a laser wavelength of 905 ± 50 nm including but not limited to the following:

- Ultra Lyte
- LTI 20-20
- LTI TruSpeed® S
- Pro Laser™ I II III
- Laser Ally
- Laser Atlanta® Stealth Mode

### Other Speed Detection Systems

Several techniques other than radar or laser are used to measure vehicle speeds. When these methods are being used, no detector can provide a warning.

These techniques include:

- **Pacing** - A patrol car drives behind you and matches your driving speed.
- **Vascar/Aircraft** - The time it takes a vehicle to travel a known distance is measured.

20

## ACCESSORIES

These and other accessories can be ordered directly from Whistler by calling **1-800-531-0004** or visiting our online store at [www.whistlergroup.com](http://www.whistlergroup.com).

Order#	Description	Price
202138	Visor Bracket	\$ 6.95
202151	Windshield Bracket Kit	\$ 9.95
206552	Power Cord (5')	\$14.95
206880	Hardwire Kit (10' ) (for wiring to fuse box)	\$ 9.95
206666	Modular* Cord Package (includes coiled and straight cords, and power adapter)	\$17.95
159032	Package of 8 Suction Cups	\$ 2.95
402080	Non Skid Dash Pad	\$ 6.95

**\*Modular: Interconnecting pieces cord and plug. Shipping and handling (per order) \$5.00. Prices are subject to change without notice.**

## SPEED MONITORING

### Radar Detector Detectors (VG-2) Spectre

The Interceptor VG-2, or simply VG-2, is a microwave receiver used by police to detect signals radiated by the local oscillator of a radar detector. Because its purpose is to identify persons driving with radar detectors, the VG-2 is known as a “radar detector detector”. The VG-2 is a tool used by the police to identify radar detector equipped vehicles. If caught, in a state where detectors are illegal, (see page 18), drivers risk losing their radar detector and receiving a fine. In addition, instant-on radar is almost always used in combination with a VG-2, leaving unsuspecting motorists vulnerable to receiving two tickets—one potentially for speeding, the other for possession of a detector. Having a radar detector capable of detecting the VG-2 may alert you to the presence of a speed trap.

For more information on speed monitoring technologies, please visit our F.A.Q. page on our website: [www.whistlergroup.com](http://www.whistlergroup.com)

**It is the responsibility of the individual radar detector operator to know and understand the laws in your area regarding the legality of the use of radar detectors.**

**NOTE:** Having a radar detector capable of detecting the VG-2 may alert you to the presence of a speed trap. The newest tool Police have to detect radar detectors is called Spectre. Spectre can detect the majority of undetectable (VG-2) laser/radar detectors on the market.

21

## OWNER’S MANUAL

# Z-11R/Z-15R

# LASER-RADAR DETECTOR

### The Whistler Group Corporate Headquarters

3604 NW Frontage Rd. • Bentonville, AR 72712  
Tel 479.273.6012 • Fax 479.273.2927

### Whistler Customer Return Center

551 N. 13th St. • Rogers, AR 72756  
Customer Service Tel 800.531.0004

[www.whistlergroup.com](http://www.whistlergroup.com)

P/N 260037 © 2013 The Whistler Group, Inc.



# WHISTLER

27



Dear Whistler Customer,

If you have questions concerning the operation of this Whistler product please call:

**Customer Service**  
1-800-531-0004

Monday - Friday • 8:00 am - 5:00 pm CT  
or visit our website  
[www.whistlergroup.com](http://www.whistlergroup.com)

Please keep the receipt in a safe place. You may register your product online at [www.whistlergroup.com](http://www.whistlergroup.com). For warranty verification purposes, a copy of your dated store receipt must still accompany any unit sent in for warranty work. If the unit is returned without a dated store receipt, an out of warranty service charge applies. Note: Your warranty period begins at the time of purchase. The warranty is validated only by the dated store receipt! Please record the serial number of the unit in the space provided in the warranty section of the manual.

To fully acquaint yourself with the operation of your Whistler detector and to better understand the differences between detecting radar, laser, and safety radar signals, we recommend reading this entire manual or visiting our F.A.Q. page on our website [www.whistlergroup.com](http://www.whistlergroup.com)

Enjoy your Whistler detector and please drive safely.

Sincerely,  
The Whistler Group, Inc.

## TABLE OF CONTENTS

Model Features Summary.....	3 - 5
Installation.....	5-6
• Mounting Guidelines	5
• Windshield Mounting	5-6
• Power Connection	6
• Fuse Replacement	6
Operation.....	7 - 12
• Power On Self Test & Volume	7
• Integrated Real Voice® (Z-15R Only)	7
• Feature Engaged Confirmation	7
• Self Test Mute	8
• Setting Saver	8
• Auto Quiet Mode	8
• Quiet Mode	8
• City /City 1/ City 2 Modes	9
• Highway Mode	9
• TFSR - Traffic Flow Signal Rejection (Z-15R Only)	10
• Alert Periscopes	10
• Dim /Dark Mode	11
• Engaging /Disengaging VG-2 Detection	11
• Vehicle Battery Saver Mode	12
• Stay Alert (Z-15R Only)	12
Laser & Radar Alerts.....	13 - 14
• Laser Audio / Visual Alerts	13
• Laser Tips	13
• Pulse Protection®	13
• Safety Warning System™	14
VG-2 Alerts.....	14
POP™ Mode.....	15
Option Select Mode.....	15 - 16
• Reset Features	16
Troubleshooting Guide.....	16 - 17
• Care & Maintenance	17
Are Detectors Legal?.....	18
• FCC Information	18
Speed Monitoring.....	19 - 21
• Radar Facts	19
• Laser Facts	19 - 20
• Other Speed Detection Systems	20 - 21
Warranty Information.....	22 - 25
Specifications.....	26
Accessories.....	27

## FEATURES

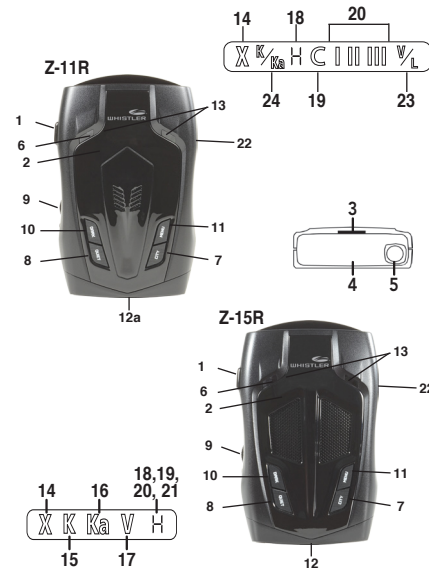

### Features

- Total Band Protection™
- Numeric Icon Display
- Detects POP™ Mode
- 360° Maxx Coverage
- Real Voice® (Z-15R only)
- VG-2 Cloaking
- 3 City Modes/Highway Mode
- Quiet/Auto Quiet Mode
- Dim/Dark Mode
- High Gain Lens
- Stay Alert
- Setting Saver
- Vehicle Battery Saver™
- Safety Warning System™
- Alert Priority
- Alert Periscopes
- Total Laser Detection
- Traffic Flow Signal Rejection (Z-15R Only)

3

4

## FEATURE DESCRIPTIONS

- Bracket Release Button** - provides quick and easy release of the mounting bracket.
- Speaker** - provides distinct audio warnings for X, K, Ka band radar, safety warning system, laser and VG-2.
- Mounting Bracket Location** - slot holds mounting bracket firmly.
- Radar Antenna** - compact, high-efficiency antenna receives radar signals.
- Front Laser** - high gain optical lens provides increased sensitivity and field of view for leading-edge laser detection.
- Rear Laser** - an integrated optical waveguide provides superior detection of laser signals transmitted from behind.
- City Button** - reduces the annoyance of false alerts typically encountered in urban driving areas.
- Quiet Button** - pressing QUIET before a radar signal is detected engages Auto Quiet Mode which provides "reduced tone" sounds after the initial warning. Pressing QUIET during a radar encounter silences audio alerts, while allowing visual alerts to keep you informed.
- Power / Volume Control** - turns unit on/off and adjusts audio level.
- Dim / Dark Mode** - engages Dim/Dark modes.
- Menu Button** - enters option select mode.
- Numeric Icon Display** - combines icon display with a 7 segment digital display that shows signal strength indication and band identification.
- Icon Display** - offers easy-to-read display to indicate power, city mode, radar band identification, and signal strength.
- Alert Periscopes** - provide an additional attention getting visual alert.
- X-band Icon** - indicates the unit is receiving a X-band signal.
- K-band Icon** - indicates the unit is receiving a K-band signal.
- Ka-band Icon** - indicates the unit is receiving a Ka-band signal.
- V** - indicates that the unit is receiving a VG-2 signal. Indicates that VG-2 is engaged.
- H** - indicates unit is in Highway mode.

## OPERATION

### Traffic Flow Signal Rejection (TFSR) (Z-15R Only)

Recently, many new products operate on X or K band causing nuisance alerts to radar detectors. Some of these are radar based Traffic Monitoring Systems mounted to poles alongside the highway and others are K Band Lane Change Assistants and Blind Spot Detectors found on some automobiles. When turned on in option mode, helps eliminate excessive alerts from erroneous X and K-band sources. Traffic flow monitoring systems are getting more common. Many of these systems generate radar signals to measure the flow of traffic across multiple lanes. Most detectors will alert you to it unnecessarily. This rejection feature examines the incoming signal and will aid in reducing the alerts to such sources.

We suggest you turn TFSR on if you are experiencing excessive X or K band false alerts every half mile or so along stretches of roadway that contain these traffic flow sensors.

### Alert Periscopes

Whistler's Alert Periscopes provide an added attention getting visual alert. The two extra LED's flash on and off when the unit alarms to provide a unique visual alert. This alert can be programmed through the Option Select Mode to be: ON, OFF, or FLASHING during alerts.

10

## OPERATION

### Dim/Dark Mode

Dim/Dark Mode reduces the illumination of the display.

- Press and release the Dark button to reduce illumination to a dim setting.
- Press and release the Dark button a second time to engage Dark Mode. The display illumination is further reduced.

Dim or Dark can be engaged during an alert. In Dark Mode, the display goes dark for as long as a signal is being detected and 20 seconds after, then the display returns to the dimmer setting.

- Press and release the Dark button a third time to restore the display to full illumination.

### Engaging/Disengaging VG-2

See Option Select Mode to turn this feature on.

### Vehicle Battery Saver Mode

The Vehicle Battery Saver Mode automatically shuts off your detector within 6 hours. The timer is reset if the detector is turned off, unplugged or any button is pressed before the time has expired. The detector will alert you with an audible and visual warning before it shuts off. During this warning, you can momentarily reset the unit by pressing any button. This will reset the timer. If the unit has automatically turned itself off, press any button to turn the unit back on.

**NEVER OPERATE A VEHICLE IF YOU ARE DROWSY!**

11

## FEATURE DESCRIPTIONS

- C** - indicates that the unit is operating in city mode.
- Signal Strength Icon** - indicates the strength of the signal being detected.
- L** - indicates that the unit is receiving a laser signal.
- Power Jack** - provides connection for the power cord.
- VG-2/Laser Icon** - indicates that the unit is receiving either VG2 or laser signal.
- K/Ka-band Icon** - shows the unit is receiving a K or Ka band signal. K/Ka indicator will flash for Ka band.

## INSTALLATION

### Mounting Guidelines

- Mount the unit as low as possible near the center of the windshield.
- Do not mount the unit behind wipers, ornaments, mirrored sunscreens, etc. These obstructions have metal surfaces which can affect radar and laser signals and reduce critical warning time. (Regular tinted glass does not affect reception.)
- Some windshields have an Instaclear™ or Electriclear™ type coating, which affects radar signals. Consult your dealer or the owner's manual to determine if your windshield has this coating.
- Avoid placing unit in direct contact with the wind shield.
- To reduce the possibility of theft, conceal the unit when not in use.



5

## OPERATION

### Stay Alert Feature (Z-15R Only)

The Stay Alert Feature is designed to test a driver's alertness. To engage (when the unit is not alarming) :

- Press and hold the City button for approximately 2 seconds. Release button during or immediately after the alert is given.

The "H" or "C" will flash indicating Stay Alert is activated. Within 30-60 seconds, two beeps are sounded; to show alertness, the driver must press either the City, Menu, or Quiet buttons within 3-5 seconds. If a button is pressed within 3-5 seconds, the cycle is repeated.

If a button is not pressed within 3-5 seconds, an alarm sounds and the display flashes all the LEDs.

- Press the Dark button to exit the Stay Alert feature.

**WARNING!!!** Stay Alert is NOT intended as a substitute for adequate rest. You should NOT operate a vehicle if you are drowsy. During extended periods of vehicle operation, you should take frequent breaks. Improper reliance on the Stay Alert feature may result in vehicle damage, personal injury or death.

12

## INSTALLATION

### Windshield Mounting

- Install the two suction cups and rubber bumper onto the bracket by fitting them into their holes.
- Press the suction cups onto the windshield at the location you have chosen.

**IMPORTANT:** Make sure the unit is level.



**Note:** Some newer cars have a plastic safety coating on the inside of the windshield. The windshield bracket may leave permanent marks on this type of surface.

To find out if your vehicle has this type of windshield, check the owner's manual or ask your dealer. We recommend that you do not leave the suction cup bracket on the windshield in direct sunlight. If the detector is removed, this may cause blistering of the dash in some vehicles.

### Power Connection

- Plug the small end of the power cord into the unit's power jack.
- Plug the large end into the vehicle's cigarette lighter.

### Fuse Replacement

The lighter socket plug is equipped with a replaceable 2 amp, 3AG fuse located behind the silver tip. To replace the fuse, carefully unscrew the tip of the plug.



**IMPORTANT:** Unscrew slowly. The tip contains a spring which may fly out when disassembling. Insert the new fuse with the spring and screw on the tip. With use, the screw cap on the plug may loosen. Retighten it occasionally.

6

## LASER/RADAR ALERTS

### Laser Audio / Visual Alerts

When a laser signal is detected, model Z-11R display indicates alert by illuminating the "V/L" and scrolling the signal strength indicators from right to left. Model Z-15R display indicates an "L" on the display. The audio alert is continuous for a minimum of 3 seconds.

### Laser Tips

If you are the targeted vehicle, a laser gun can often determine your speed within a few seconds after you receive an alert. In this situation there is generally no time to safely adjust your speed. However, if you are traveling near or behind the targeted vehicle and receive an alert, response time should be sufficient. Any laser alert, regardless of duration, requires immediate action!

### Pulse Protection®

Pulse (or instant-on) radar is more difficult to detect than conventional radar because it remains "off" until activated to measure the speed of a targeted vehicle. When a pulse type transmission is detected, your Whistler detector sounds an urgent 3-second audio warning. Model Z-11R will flash the alert strength indicators at their fastest rate; on model Z-15R a "P" will be displayed. After the 3-second pulse alert, the standard alert pattern continues for as long as the signal is present. It is important to respond promptly to a pulse alert, since warning time may be minimal.

13

## OPERATION

### Power On Self Test & Volume

Each time your Whistler detector is turned on, an automatic self-test sequence confirms that the speaker and visual displays are functional. To increase the volume, continue turning the volume knob.

### Integrated Real Voice® (Z-15R Only)

When selected, Real Voice® will be used to articulate the following:

1. Band Identification
2. Safety Warning System messages
3. Feature Selection

Voice OFF/ON is selected by holding quiet button for approximately 2 seconds. Voice ON will announce "caution", Voice OFF will give a double beep.

### Feature Engaged Confirmation

Each time a button is pressed, one beep confirms the feature is "on", two beeps confirm feature "off".

### Self Test Mute

Press the Quiet button during the self-test sequence to cancel the Self-Test audio. This will not affect radar/laser alerts. To restore the Self-Test audio, press the Quiet button during the next Self-Test.

7

## LASER/RADAR ALERTS

### Safety Warning System/Audio/Visual Alerts

When your Whistler detector detects a safety warning system, it provides a distinctive audio tone and; Model Z-11R illuminates the first and last alert LED; Model Z-15R display shows an "S." and a decimal point when a Safety warning system is detected.



**Note:** You will not be able to receive SWS™ alerts if transmitters are not located in your area.

## VG-2 ALERTS

### VG-2 Detection Mode

The VG-2, also known as a "radar detector detector," is a special receiver used by police to detect signals radiated by a radar detector. See page 21 for more information on VG-2.

When a VG-2 signal is detected, the VG-2 alert is sounded. After 3 seconds, the audio is cancelled and the VG-2 indicator flashes at a slower rate. Every 30 seconds, the detector checks for a VG-2 signal. This cycle is repeated if the VG-2 signal is detected again. If no signal is detected, two beeps are provided indicating an "all clear" condition.

During the period a VG-2 signal is detected, a radar signal cannot be detected. However, because the VG-2 alert has confirmed that a patrol car is nearby, you are already aware of the potential for speed monitoring and can adjust your speed accordingly. Laser detection is not affected while a VG-2 signal is detected.

14

8

9