

OPERATIONS

Setting Saver

Setting Saver stores your personalized settings so that when the detector is turned off and then on again, you do not have to re-enter them.

VG-2 Mode

See Option Select Mode to turn this feature on/off. When a VG-2 signal is detected, the VG-2 alert is sounded and the display flashes "VG-2". After 3 seconds the audio is canceled and the display no longer flashes. This cycle is repeated if the VG-2 signal is detected again.

During the period a VG-2 signal is detected, a radar signal cannot be detected.

However, because the VG-2 alert has confirmed that a patrol car is nearby, you are already aware of the potential for speed monitoring and can adjust your speed accordingly. Laser detection is not affected while a VG-2 signal is detected. (See page 24 for more information)

Laser Signature ID (LSID)

Identify the Laser gun's pulse rate or PPS (Pulses per Second) that is transmitted by the speed laser gun. LSID may also be used to identify other forms of laser sources such as LACC (Laser Assisted Cruise Control) systems found in some high end vehicles. If the Laser PPS information displayed is due to another source such as local airports or LACC, LSID allows you to Lock Out this rate from giving you the continuous audio alert during this and any new encounter of the same rate.

To lock out a PPS, press the Quiet button during the Laser alert. This will place an * on the screen beside the PPS rate and Lock Out this signature ID. Any new encounter with the same Laser Signature ID will provide the display information and two quick beeps.

Caution: Do not lock out a PPS rate if it is close to known speed laser guns.

15

SPEED MONITORING

ARE DETECTORS LEGAL?

Check with your local laws regarding radar detector ownership and use.

It is the responsibility of the individual radar detector user to know and understand the laws in your area regarding the legality of the use of radar detectors.

POP™ Mode

POP™ Mode is a feature on some radar guns operating on K and Ka bands. When the gun is in POP™ Mode and activated, a brief burst of energy, less than 1/15 of a second, is transmitted and the vehicle's speed is quickly acquired. A detector without POP™ Mode detection capability cannot respond to this brief transmission.

Laser Facts

It's well documented that many radar guns cannot reliably provide the speed of a targeted vehicle that is traveling in a group of vehicles. In contrast, a laser gun can target a specific vehicle out of a line of traffic and determine its speed. The advantage of laser over radar in terms of target identification is the result of the laser gun's narrow beam. A radar gun's transmission can cover more than a four-lane highway at a distance of 1,000 feet, compared with a laser gun's transmission which covers about 3 feet at the same distance.

For best protection, keep these points in mind:

- Because the vehicle's license plate or headlights are the laser gun's primary targets, mounting the Whistler detector on the dashboard can improve laser detection at short range.

22

OPERATIONS

Segmented Selectable Laser Receiver

If these alerts are bothersome, you may wish to make note of the PPS rate for these occurrences. The laser validation windows are separated into segments allowing for customization.

Segment Pulse Rate

Laser Area 1: 20Hz to 950Hz
Laser Area 2: 2600Hz to 3200Hz
Laser Area 3: 3800Hz to 4200Hz

Laser Area 1 covers the traditional laser guns used in North America. Laser Area 2 and 3 cover laser guns recently approved for use in North America. You can change the selection from yes to no individually in option mode.

If laser within a group is not used in your area, you may shut off that group (change the selection from Y to N while in Option Select Mode) by pressing the DARK or QUIET buttons.

POP™ Mode Alerts

Because POP™ Mode radar utilizes the same K or Ka band frequencies, POP™ Mode Alerts will initially be displayed as POP K or POP Ka then switch to band and signal strength.

Alert Priority

When two or more signals are received at the same time, the alert priority is:

- Laser
- VG-2
- Speed Radar

Example: If X band is alerting, then suddenly a laser signal is detected, the laser warning will override the X band alert.

Option Select Mode

Press the Menu button to enter Option Select Mode. Press the Menu button again will step thru in an ascending order while pressing the City button will step thru in a descending order. Press and hold the Menu button to exit. Option mode will automatically exit if no buttons are pressed within 20 seconds.

16

SPEED MONITORING

- Do not follow closely behind any vehicle you cannot see through. If you can't see past a vehicle ahead of you, chances are your detector can't either. The receiving range of your laser detector will not be the same as a radar detector. Laser guns are most often used at short range.
- Whistler Laser-Radar detectors receive all current laser guns which operate at a laser wave length of 905nm +/- 50nm.

Laser Tips

If you are the targeted vehicle, a laser gun can often determine your speed within a few seconds after you receive an alert. In this situation, there is generally no time to safely adjust your speed. However, if you are traveling near or behind the targeted vehicle and receive an alert, response time should be sufficient. Any laser alert, regardless of duration, requires immediate action.

Radar Facts

A radar gun operates by transmitting radio waves at certain frequencies which reflect off objects and are picked up by the radar gun's receiving section. When a radar beam reflects off a moving target, a measurable frequency shift occurs. The radar unit converts this shift into miles per hour to determine your vehicle's speed. This laser/radar detector receives signals from traffic radar guns at X Band (10.500 - 10.550 GHz), K Band (24.050 - 24.250 GHz), and Ka Band (33.400 - 36.000 GHz).

Note: Your radar detector is designed to alarm if an officer is transmitting on any one of the above radar bands.

23

OPTION SELECT MODE

Feature	Display Shows	To Change: D=Dark Q=Quiet	Option
CHANGE TONES	ZONE 3	D or Q to select	Tone 1, 2, 3 (Different Tone Patterns)
SELF TEST	TEST YES	D = YES Q = NO	YES = X, K, Ka Audio Tones OFF = One Beep During Power Up
LASER PULSE RATE	LSID YES	D = YES Q = NO	LSID YES (default) LSID NO
LASER AREA 1	.02-95 Y	D or Q to select	Laser Area 1 ON (default) Laser Area 1 OFF
LASER AREA 2	2.6-3.2 Y	D or Q to select	Laser Area 2 ON (default) Laser Area 2 OFF
LASER AREA 3	3.8-4.2 Y	D or Q to select	Laser Area 3 ON (default) Laser Area 3 OFF
VG-2 Mode	VG-2 OFF	D = YES Q = NO	VG-2 ON VG-2 OFF (default)
SWS™	SWS OFF	D = ON Q = OFF	SWS ON SWS OFF (default)
POP™	POP OFF	D = ON Q = OFF	POP ON POP OFF (default)
BATTERY SAVER Mode	B SVR ON	D = ON Q = OFF	Battery Saver ON (default) Battery Saver OFF
FILTER Mode	FILTER	D = ON Q = OFF	Filter (default) Filter 1
ALERT PERISCOPES	LEDBLNK	D or Q to select	Alert Periscopes ON (ON, OFF or Blinking)
TFSR	TFSR OFF	D = ON Q = OFF	TFSR ON TFSR OFF (default)
GPS Mode	GPS Y	D = ON Q = OFF	GPS Mode ON (default) GPS Mode OFF
LOCAL TIME	GMT -5	D or Q to select	Change Time Zone
DAYLIGHT SAVINGS	DST N	D = YES Q = NO	Daylight Savings YES Daylight Savings NO (default)
CLOCK	CLOCK Y	D = YES Q = NO	Clock Display YES (default) Clock Display NO
COMPASS Mode	COMPAS Y	D = YES Q = NO	Compass Mode ON (default) Compass Mode OFF
UNIT OF MEASURE	SPD MPH	D or Q to select	English / Metric
AUTO QUIET SPEED	AQSPD 0	D or Q to select	Select low speed limit for Auto Quiet to engage
ALARM RADIUS	RAD 400	D or Q to select	Select 200, 400, 600
DELETE RADIUS	D-RAD 400	D or Q to select D and Q to execute	Select delete waypoint radius
DELETE WAYPOINTS	ALL DEL	Press D and Q	Delete all manual waypoints

17

SPEED MONITORING

Other Speed Detection Systems

Several techniques other than radar or laser are used to measure vehicle speeds. When these methods are being used, no detector can provide a warning. These techniques include:

- Pacing** - A patrol car drives behind you and matches your driving speed.
- Vascor/Aircraft** - The police measure the time it takes your vehicle to travel a known distance.

Radar Detector Detectors: VG-2, Spectre

The Interceptor VG-2 or simply VG-2, is one type of microwave receiver used by Police to detect signals radiated by the local oscillator of a radar detector. Because its purpose is to identify persons driving with radar detectors, these devices are known as a "radar detector detector" (RDD). An RDD is the primary tool used by the police to identify radar detector equipped vehicles. If caught in a state or country where detectors are illegal, drivers risk losing their radar detector and receiving a fine. In addition, instant-on radar is almost always used in combination with an RDD, leaving unsuspecting motorists vulnerable to receive two tickets; one potential for speeding, and the other for possession of a detector.

Note: The newest tool Police have to detect radar detectors is called Spectre. Spectre can detect the majority of undetectable (VG-2) laser/radar detectors on the market.

It is the responsibility of the individual radar detector user to know and understand the laws in your area regarding the legality of the use of radar detectors.

OPERATIONS

Stay Alert Feature

The Stay Alert Feature is designed to test a driver's alertness. To engage (when the unit is not alarming):

- Press and hold the City button for approximately 2 seconds. Release the button during or immediately after the alert is given.

Display shows: **RU ALERT**

Within 30-60 seconds, two beeps are sounded; to show alertness, the driver must press either the City, Menu, or Quiet buttons within 3-5 seconds. If a button is pressed within 3-5 seconds, the cycle is repeated.

If a button is not pressed within 3-5 seconds, an alarm sounds

Display shows: **GET REST**

- Press the DARK button to exit during the Stay Alert feature.

WARNING!!! Stay Alert is NOT intended as a substitute for adequate rest. You should NOT operate a vehicle if you are drowsy. During extended periods of vehicle operation, you should take frequent breaks. Improper reliance on the Stay Alert feature may result in vehicle damage, personal injury or death.

NEVER OPERATE A VEHICLE IF YOU ARE DROWSY!

18

WARRANTY INFORMATION

Consumer Warranty

This Whistler product is warranted to the original purchaser for a period of one (1) year from the date of original purchase against all defects in materials and workmanship, when purchased from an authorized Whistler retailer. This limited warranty is void if the unit is abused, misused, modified, installed improperly, or if the housing and/or serial numbers have been removed. There are no express warranties covering this product other than those set forth in this warranty. All express or implied warranties for this product are limited to one (1) year. Whistler is not liable for damages arising from the use, misuse, or operation of this product including but not limited to loss of time, inconvenience, loss of use of your product or property damage caused by your product or its failure to work, or any other incidental or consequential damages including personal injury.

DO NOT RETURN ITEM TO STORE WHERE PURCHASED FOR WARRANTY INFORMATION. CONTACT WHISTLER CUSTOMER SERVICE AT 1-800-531-0004.

Representatives are available to answer your questions
Monday - Friday
from 8:00 a.m. to 5:00 p.m. CT

Service Under Warranty

During the warranty period, defective units will be repaired or replaced (with the same or a comparable model), at Whistler's option, without charge to the purchaser when returned prepaid, with dated proof of purchase to the address below. Units returned without dated proof of purchase will be considered out of warranty and therefore are not covered by the described Limited Warranty. (Refer to Service Out of Warranty section.) Due to the specialized equipment necessary for testing Whistler products, there are no authorized service centers other than Whistler. When returning a unit for service under warranty, please follow these instructions:

- Ship the unit in the original carton or in a suitable sturdy equivalent, fully insured, with return receipt requested to:

Whistler Repair Dept.
1412 South 1st St.
Rogers, AR. 72756

Please allow 3 weeks turnaround time.

IMPORTANT: Whistler will not assume responsibility for loss or damage incurred in shipping. Therefore, please ship your unit insured with return receipt requested. CODs will not be accepted!

25

RADAR/LASER ALERTS

LASER/RADAR ALERTS

Speed Radar Audio/Visual Alerts when X, K or Ka is detected, the band ID and signal strength are displayed. The audio alert is continuous and has a Geiger counter-like pattern. The faster the beep, the closer or stronger the radar source.

Laser Audio/Visual Alerts

When a laser signal is detected the word "LSR" and the corresponding laser pulse rate is displayed, the audio alert is continuous for a minimum of 3 seconds. "LSR 238"

Pulse Protection®

Pulse (or instant-on) radar is more of a threat than conventional radar because it remains "off" until activated to measure the speed of a targeted vehicle. When a pulse type transmission is detected, your Whistler detector sounds an urgent 3-second audio warning and the display shows:

PULSE

After the 3-second pulse alert, the standard alert pattern continues for as long as the signal is present. It is important to respond promptly to a pulse alert, since warning time may be minimal.

Reset Features

All user features can be reset to factory settings.

- Remove Power from the unit.
- Press and hold the Quiet button.
- Restore Power to the unit. (power switch turned on)
- Wait for 2 beeps.
- Release the Quiet button.

Unit is now reset to the following features and settings.

19

WARRANTY INFORMATION

2. Include with your unit the following information, clearly printed:
 - Your name and physical street address for shipping (no PO Boxes), a daytime telephone number, and an email address (if applicable).
 - A detailed description of the problem (e.g., "device will not Power ON").
 - A copy of your dated proof of purchase or bill of sale.

3. Be certain your unit is returned with its serial number. Units without serial numbers are not covered under warranty.

IMPORTANT: To validate that your unit is within the warranty period, make sure you keep a copy of your dated proof of purchase. For warranty verification purposes, a copy of your dated store receipt must accompany any Whistler product sent in for warranty work.

Service Out of Warranty

Units will be repaired at "out of warranty" service rates when:

- The unit's original warranty has expired.
- A dated proof of purchase is not supplied.
- The unit has been returned without its serial number.
- The unit has been misused, abused, modified, installed improperly, or had its housing removed.

The minimum out of warranty service fee for your Whistler detector is \$75.00 (U.S.). If you require out of warranty service, please return your unit as outlined in the section "Service Under Warranty" along with a cashier's check or money order in the amount of \$75.00. Payment may also be made by MasterCard, VISA or American Express. **Personal checks are not accepted.**

In the event repairs cannot be covered by the minimum service fee, you will be contacted by a Whistler technical service specialist who will outline options available to you.

IMPORTANT: When returning your unit for service, be certain to include a daytime telephone number and an email address (if applicable).

Customer Service

If you have questions concerning the operation of your Whistler product, or require service during or after the warranty period, please call Customer Service at 1-800-531-0004.

Representatives are available to answer your questions Monday - Friday from 8:00 a.m. to 5:00 p.m. (CT) or visit the F.A.Q.'s at www.whistlergroup.com.

26

RADAR/LASER ALERTS

Reset Features(cont'd)

- City/Highway to Highway Mode
- Dim/Dark Mode - to full illumination of display
- Auto Quiet OFF
- Vehicle Battery Saver ON
- Full Power Up sequence
- Default TONE 3
- Laser LSID YES
- SWS™ OFF
- POP™ OFF
- LED Periscopes to BLNK
- TFSR OFF
- Filter
- Laser Segments ON
- VG-2 OFF
- GPS YES - GPS RELATED FEATURES
- DST NO
- GMT -5
- Clock YES
- Compass YES
- Speed MPH
- Auto Quiet SPD 0
- Alarm Radius: 400
- Delete Radius: 400

TROUBLESHOOTING

Care and Maintenance

Do not spray water, cleaners or polishes directly onto the unit. The spray may penetrate through the openings and damage the unit. Also, do not use any abrasive cleaners on the unit's exterior.

Troubleshooting

Your Whistler detector is expertly engineered and designed to exacting quality standards to provide you with reliable, trouble-free operation. If your unit has been correctly installed following the guidelines in this manual, but is not operating optimally, please refer to the troubleshooting guide below.

20

SPECIFICATIONS

SPECIFICATIONS

Radar Frequencies:

10.500 - 10.550 GHz (X Band)
24.050 - 24.250 GHz (K Band)
33.400 - 36.000 GHz (Ka Superwideband)

Laser Wavelength: 905nm +/- 50nm

Operating Temperature Range:

-10 C to +70 C (+14 F to +158 F)

Power Requirements:

Operational 12 to 15 volts DC, 250mA nominal (2 amp fuse) Vehicle Battery Saver, 30mA nominal.

These U.S. patents apply:

#5,666,120, #7,215,276

Specifications are subject to change without notice.

CE

ROHS

write serial number in the space provided

27

TROUBLESHOOTING

PROBLEM: No display or audio.

- Check fuse in power cable, replace if necessary.
- Check fuse in fuse box, replace if necessary

PROBLEM: Unit alarms when vehicle equipment or electrical accessories (brakes, power mirrors/windows, directionals, horn, etc.)

- Check conditions of vehicle's electrical system, including battery and alternator.

PROBLEM: Audio alerts are not loud enough.

- Cancel Auto Quiet Mode or City Mode.
- Check audio level setting.
- Check Speed Selective Auto Quiet setting in Option Mode.

PROBLEM: Unit alarms when vehicle hits bumps.

- Check for loose lighter socket; tighten and clean.
- Check connections at both ends of the power cord. Substitute another cord to determine if the cord is defective. Return defective cord to the factory.

PROBLEM: Unit falses too much.

- If alarms are POP™ Ka, switch POP™ Mode to off.
- If the above option doesn't help, use a higher Filter setting or if Ka is not used turn Ka band off.
- If alarms are X or K band and due to radar based traffic flow sensors or radar based vehicle blind spot detectors, turn TFSR to ON.

If difficulties occur which cannot be solved by information in this Troubleshooting Guide, please call Whistler Customer Service at 1-800-531-0004 or visit our FAQ page at www.whistlergroup.com, before returning your unit for service.

21

OWNER'S MANUAL

LR-300GP/ LR-300GPX

LASER-RADAR DETECTOR WITH GPS

The Whistler Group Corporate Headquarters

1716 SW Commerce Dr. Ste. 8
PO Box 1760 Bentonville, AR 72712
Toll Free (800) 531-0004
TEL (479) 273-6012 FX (479) 273-2927

Customer Return Center

1412 South 1st St. Rogers, AR 72756
Customer Service Tel (800) 531-0004
Email: info@whistlergroup.com
www.whistlergroup.com

P/N 270306 08A14 © 2014 The Whistler Group, Inc.

WHISTLER

WHISTLER

22

24

25

26

27

If you have questions concerning the operation of this Whistler product please call:

CUSTOMER SERVICE 1-800-531-0004

Monday - Friday • 8:00 am - 5:00 pm CT
USA

or visit our website

www.whistlergroup.com

Please keep the receipt in a safe place. You may register your product online at www.whistlergroup.com. For warranty verification purposes, a copy of your dated store receipt must still accompany any unit sent in for warranty work. If the unit is returned without a dated store receipt an out of warranty service charge applies.

Note: Your warranty period begins at the time of purchase. The warranty is validated **only** by the dated store receipt! Now is the time to record the serial number of the unit in the space provided on page 27 of this manual.

Model Features Summary	3-4
Installation	5-7
• Mounting Guidelines	
• Windshield Mounting	
• Power Cord Connection	
• Fuse Replacement	
Operation	8-18
• Power On and Self-Test	
• Memory/Beep Confirmation	
• Auto Level Adjustment	
• Auto Quiet/Quiet Modes	
• City/City 1/City2 Modes	
• Highway Mode	
• Understanding the Display	
• Signal Strength Display	
• Alert Periscopes	
• Redlight / Speed Camera Detection	
• Getting a Satellite Lock	
• Camera Alerts	
• Manual Entry	
• Updating the Database	
• Dim/Dark Modes	
• Vehicle Battery Saver Mode	
• Teach/Tutorial Mode	
• TFSR	
• Filter Mode	
• Setting Saver	
• VG-2 Mode	
• Laser Signature ID (LSID)	
• Selectable Laser	
• POP™ Mode Detection	
• Alert Priority	
• Option Select Mode	
• Stay Alert™	
Radar/Laser Alerts	19-20
• Radar Alerts	
• Laser Audio/Visual Alerts	
• Pulse Protection®	
• Reset Features	
Troubleshooting Guide	20-21

Speed Monitoring Technologies	22-24
• Are Detectors Legal?	
• POP™ Mode	
• Laser Facts	
• Laser Tips	
• Radar Facts	
• Other Speed Detection Systems	
• Radar Detector Detectors	
Warranty Information	25-27
Specifications	27

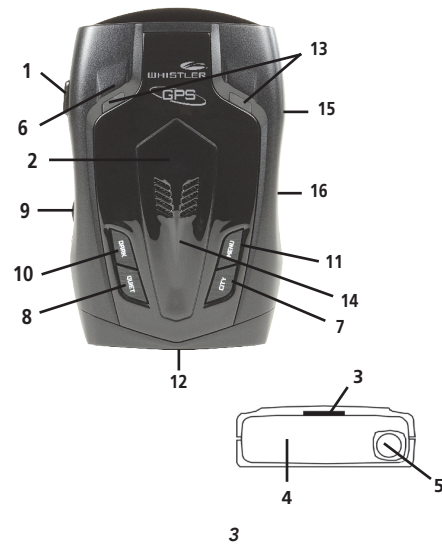

FEATURE DESCRIPTIONS

- Bracket Release Button** – provides quick and easy release of the mounting bracket.
- Speaker** – provides distinct audio warnings.
- Mounting Bracket Location** – slot holds mounting bracket firmly.
- Radar Antenna** – compact, high-efficiency antenna receives radar signals.
- Front Laser** – high gain optical lens provides increased sensitivity and field of view for leading-edge laser detection.
- Rear Laser** – an integrated optical waveguide provides superior detection of laser signals transmitted from behind.
- City Button** - reduces the annoyance of false alerts typically encountered in urban driving areas.
- Quiet Button** - pressing QUIET before a signal is detected engages Auto Quiet Mode which automatically reduces the audio level after the initial warning to a low audio level setting. Pressing QUIET during a radar/laser encounter silences audio alerts, while allowing visual alerts to keep you informed.
- Power / Volume Control** – turns the unit on/off and adjusts the audio level.
- Dim / Dark** - engages Dim/Dark modes.
- Menu Button** - enters Option Select Mode.
- OLED Text Display** – provides better contrast, brightness and color/shows alerts detected, signal strength, and indicates engaged modes of operation.
- Alert Periscopes** - provide an additional attention getting visual alert.
- GPS Antenna** - provides Traffic Camera alerts as well as other speed selective settings.
- Power Jack** – provides connection for the power cord.
- USB Jack** - provides connection to a PC for data updates.

INSTALLATION

Mounting Guidelines

- Mount the unit as low as possible near the center of the windshield.
- Do not mount your unit behind wipers, ornaments, mirrored sunscreens, etc. These obstructions have metal surfaces which can affect radar and laser signals and reduce critical warning time. (Regular tinted glass does not affect reception.)
- Some windshields have an Instaclear™ or Electriclear™ type coating, which affects radar signals. Consult your dealer or the vehicle's owner's manual to determine if your windshield has this coating.
- Avoid placing unit in direct contact with windshield.
- To reduce the possibility of theft, conceal your unit when not in use.

Windshield Mounting

- Install the two suction cups and rubber bumper onto the bracket by fitting them into their holes.
- Press the suction cups onto the windshield at the location you have chosen.

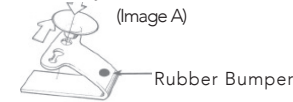

Important: Some newer cars have a plastic safety coating on the inside of the windshield. The windshield bracket may leave permanent marks on this type of surface. To find out if your vehicle has this type of windshield, check the vehicle's owner's manual or ask your dealer.

INSTALLATION

We recommend that you do not leave the suction cup bracket on the windshield in direct sunlight. If the detector is removed, this may cause blistering of the dash in some vehicles.

- Slide the detector onto the bracket until it locks into place.



Important: Make sure unit is level.

- If necessary, the unit may be leveled by bending the windshield bracket. Press the bracket release button and remove the detector before bending.

Power Cord Connection

- Plug the small end of the power cord into the unit's power jack.
- Plug the large end into the vehicle's cigarette lighter socket.

Note: Cord fits tightly into detector. When installing the cord, expect some resistance.

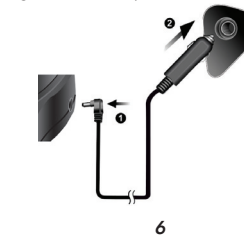

OPERATION

Power On and Self-Test

Each time your Whistler detector is turned on, an automatic self-test sequence confirms that the speaker, visual displays are functional along with many of the saved settings. To increase the volume, continue turning the volume knob.

Memory/Beep Confirmation

All features selected (except Stay Alert and Quiet) are retained in memory. Each time a button is pressed one beep confirms feature "on", two beeps confirm feature "off".

Audio Level Adjustment

- To change the audio level:
- Move Power/Volume knob back to increase audio level.
 - Move Power/Volume knob forward to decrease audio level.

Quiet Mode

Quiet cancels audio during an alert and any new alert within 20 seconds. After 20 seconds of no alerts, the audio is restored for any new alerts.

- Press Quiet to cancel the audio.
- Press Quiet a second time during an alert to restore the standard audio alert pattern; or turn the unit off, then on.

Auto Quiet Mode

Auto Quiet mode reduces the selected audio level approximately 5 seconds after a radar signal is detected followed by a reduced tone. The reduced tone will continue for as long as the detected signal is present and for any new signal within 20 seconds. Auto Quiet mode does not affect laser alerts. Press Quiet (before a signal is detected) to engage Auto Quiet mode.

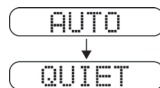

OPERATION

Auto Quiet Mode (cont'd)

- Once the Auto Quiet mode is engaged, you may cancel the audio alarm by pressing Quiet.
- Press Quiet (when the unit is not alarming) to cancel Auto Quiet mode.

Note: Speed selectable Auto Quiet is selectable in Option Mode.

City/City 1/City 2 Modes

Whistler's City Modes are designed to reduce the annoyance of automatic door openers, intrusion alarms and other devices which share frequencies with police radar. Generally, X band is used for these devices.

- Press City to cancel Highway Mode and engage City Mode.



- Press City again to enter City 1 Mode.

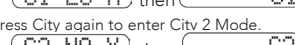

- Press City again to enter City 2 Mode.
- Press City a fourth time to cancel City 2 Mode and returns the unit to Highway Mode.



In City Mode, weak radar signals give an initial alarm of two beeps, and then remain quiet until the signal becomes very strong. When the signal strength increases, two additional beeps are provided. City 1 and City 2 Modes operate the same as Highway Mode, but in City 1 Mode, only the X band is lowered. In City 2 Mode, X-band is not detected.

Caution: Some towns/small cities may still be using X band radar. City Modes do not change the audio alert for laser.

OPERATION

Highway Mode

Highway mode provides full audio warnings any time radar (X, K and Ka) or laser signals are detected, and is recommended for open road driving.

For more information on City and Highway modes, please visit our FAQ page on our website: www.whistlergroup.com

Understanding the Display

The unit's display can be set up to indicate Heading, Mode of Operation (Highway and City modes) and Clock.



Signal Strength Display

When a radar signal is detected the audio alerts have a geiger counter-like pattern to help you determine the strength of the radar source; the faster the beeping the stronger the radar signal. At the same time the audio is reporting, the display illuminates the band identification icon and relative signal strength from 1 to 9.



1 = weak signal, 9 = strong signal

Alert Periscopes

Whistler's Alert Periscopes provide an added attention getting visual alert. The two extra LEDs flash on and off when the unit alarms to provide a unique visual alert. This alert can be programmed, through the Option Select Mode to:

- flash for all alarms
- remain on
- turn LED's off completely

OPERATION

Red Light/SpeedCamera Detection

This unit is capable of alerting to these locations with the updatable database.

Getting a Satellite Lock

Powering up, the unit will begin its search for satellites. During this time, the unit will flash the satellite icon on the display. Please allow several minutes for the unit to lock onto the satellites. This delay is normal when the unit is turned on at least 500 kilometers from when the unit last received a satellite lock or if several days have passed since its last usage.

NOTE: Driving while initially searching for satellites will take longer than if you are stationary. Acquiring satellites takes much longer the first time.

Camera Alerts

When approaching a known camera, the unit will provide the type of alert (Red Light Camera, Traffic Camera, Speed Camera, or User Location). Example: the display will show TRF CAM then count down the distance to the camera. Once past the camera location, the unit will provide a beep-beep audio tone and the word PASS will be shown on the display.

Manual Entry (Waypoint)

The unit will save a special location (i.e., a new red light camera or even a "trap") if you enter it manually. The unit will store 1000 user locations. **NOTE:** Manual entries must be approximately 100 meters apart to prevent overlapping locations. To manually enter a location, simply press and hold the QUIET button and the unit will beep to confirm. Manual entries can be deleted within a certain radius (selected in Option Select Mode). Once a radius is selected the data can be deleted within the selected Radius or they all can be deleted completely from memory.

OPERATION

Updating the Database

Follow the steps below to update the Laser-Radar Detector.

Step 1: Remove the Laser-Radar Detector from the vehicle and bring it to your PC.

Note: You do not need to power the Laser-Radar Detector to update it.

Step 2: Download the update program and install it on your PC

Note: Program is not MAC compatible

Step 3: Download and save the .msc file downloaded to your PC. Create a folder for the unit so you can store future updates and save this file into the newly created folder.

DO NOT RENAME THE .msc FILE OR TRY TO OPEN IT!

Step 4: Open the update program and plug the USB cable into the Laser-Radar Detector.

Step 5: Click the "Open File" button on the update program and locate the saved file from Step 3. Click the "DB Update" button to install the file.

Step 6: When update is complete, close the update program, unplug the USB cable and the Laser-Radar Detector is ready with the new updates.

Dim/Dark Modes

- Dim/Dark Mode reduces the illumination of the display.
- Briefly press and release the Dark button to reduce illumination to a Dim setting.

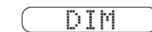

- Briefly press and release the Dark button a second time engages Dark Mode. In Dark Mode, the display goes dark for as long as a signal is being detected and for 20 seconds after, then the display returns to the dim setting. Dim Modes can be engaged during an alert.

OPERATION

Dim/Dark Modes (cont'd)



- Briefly press and release the Dark button a third time to restore full illumination to the display.

Vehicle Battery Saver Mode

The Vehicle Battery Saver Mode automatically shuts off the detector after 3 hours if the unit has constant power.

The timer is reset:

- Each time the detector is turned off.
- The power cord is disconnected or power is removed to the unit.
- Any button is pressed before the timer has expired. The detector will alert you with an audible and visual warning before it shuts off

During this warning you can reset the timer by pressing any button. If the unit has automatically turned itself off, press any button to turn the unit back on.

Refer to "Option Select Mode" for instructions for changing the battery saver mode option.

Teach/Tutorial Mode

- Provides simulated alerts for each type of signal.
- Press City and Quiet simultaneously and release.

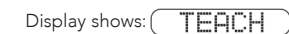

- Press Dark to cancel.

INSTALLATION

Fuse Replacement

The lighter socket plug is equipped with a replaceable 2 amp, 3AG fuse located behind the silver tip. To replace the fuse, carefully unscrew the tip of the plug.

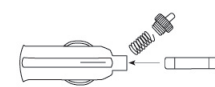

Important: Unscrew slowly. The tip contains a spring which may fly out when disassembling. Insert the new fuse with the spring and screw on the tip. With use, screw cap on plug may loosen. **Retighten occasionally.**

OPERATION

Traffic Flow Signal Rejection (TFSR)

Recently, many new products operate on X or K band causing nuisance alerts to radar detectors. Some of these are radar based Traffic Monitoring Systems mounted to poles alongside the highway and others are K Band Lane Change Assistants and Blind Spot Detectors found on some automobiles. When turned on in option mode, helps eliminate excessive alerts from erroneous X and K-band sources. Traffic flow monitoring systems are getting more common. Many of these systems generate radar signals to measure the flow of traffic across multiple lanes. Most detectors will alert you to it unnecessarily. This rejection feature examines the incoming signal and will aid in reducing the alerts to such sources.

We suggest you turn TFSR on if you are experiencing excessive X or K band false alerts every half mile or so along stretches of roadway that contain these traffic flow sensors.

Filter Modes

There are times when a radar detector in another vehicle, can emit a frequency which can cause your detector to falsely alert. The Filter Modes allow you to select the level needed for your area to minimize the occurrences of these false alerts.

Filter Mode is the factory default setting and should provide adequate filtering for most conditions. If you experience excessive alerts due to radar detectors in other vehicles, increase the Filter level. See Option Select Mode chart to change the filter settings.