

OWNER'S MANUAL

1655

LASER/RADAR DETECTOR



WHISTLER

If you have questions concerning the operation of this Whistler product please call consumer relations:

1-800-531-0004

Hours:

Monday - Friday
8:00 am - 5:00 pm CST

Please keep the receipt in a safe place. If the unit is returned without a dated proof of purchase an out of warranty service charge applies. **Note:** Your warranty period begins at the time of purchase. The warranty is validated only by return of the Warranty Validation card.

Now is the time to record the serial number of the unit in the space provided in the warranty section of the manual.

INTRODUCTION

Dear Whistler Owner,

For many of us, a vehicle is more than just transportation. It can be a mobile office, communications or entertainment center, or simply an expression of our personality. Whistler products are designed to make the time you spend in your vehicle more productive, more fulfilling, safer, or just simply more fun. Our mission is to provide products that improve your driving experience.

Your new Whistler 1655 laser/radar detector detects all radar, laser and safety radar systems, plus offers Whistler's exclusive Real Voice™ technology .

To fully acquaint yourself with the operation of the Whistler 1655 and to better understand the differences between detecting radar, laser and safety radar signals, we recommend reading this entire manual.

Enjoy the Whistler 1655 and please drive safely.

Sincerely,

THE WHISTLER GROUP

TABLE OF CONTENTS

Topic	Page
Model Features Summary	3 - 5
Installation	6 - 8
• Mounting Guidelines	
• Dash/Visor/Windshield Mounting	
• Power Connection And Fuse Replacement	
Operation	9 - 12
• Power On And Self-Test	
• Feature Engaged Confirmation	
• Integrated Real Voice™	
• Auto Quiet/Quiet Modes	
• City Mode	
• Highway Mode	
• Engaging/Disengaging VG-2 Detection	
• Vehicle Battery Saver Mode	
Radar, Laser And VG-2 Alerts	13 - 16
• Speed Radar Audio/Visual Alerts	
• Pulse Protection®	
• Safety Radar Audio/Visual Alerts	
• Laser Audio/Visual Alerts	
• VG-2 Audio/Visual Alerts	
• Alert Priority	
• Care and Maintenance	
Troubleshooting Guide.....	17
Are Detectors Legal?	18
Speed Monitoring Technologies	19 - 20
• Radar Facts	
• Laser Facts	
• Other Speed Detection Systems	
• Radar Detector Detectors	
Warranty Information.....	21 - 23
Specifications.....	24
Accessories	25

WHISTLER FEATURES

Whistler 1655



Whistler's ergonomic and user-friendly design provides a new level of operating convenience. Special features include:

- 1. Bracket Release Button** – Provides quick and easy release of the mounting bracket.
- 2. Power Jack** – Provides connection for the power cord.
- 3. Speaker** – Provides distinct audio and Real Voice™ warnings for X, K, Ka band radar, safety radar, laser and the VG-2.
- 4. Power/Volume Control** – Turns unit on/off and adjusts audio level.
- 5. High Visibility Display** – Provides distinct visual confirmation of signals detected, signal strength, and indicates engaged modes of operation.

WHISTLER FEATURES

6. CITY Button – Reduces the annoyance of false alerts typically encountered in urban driving areas.

7. VG-2 Button – Press and hold (for two seconds) to engage or disengage VG-2.

8. QUIET/Auto Quiet Button – Pressing QUIET before a signal is detected engages Auto Quiet Mode. Pressing QUIET during a radar/laser encounter silences audio alerts, while allowing visual alerts to keep you informed.

9. Laser Antenna (Rear) – An integrated optical waveguide provides superior detection of laser signals transmitted from behind.

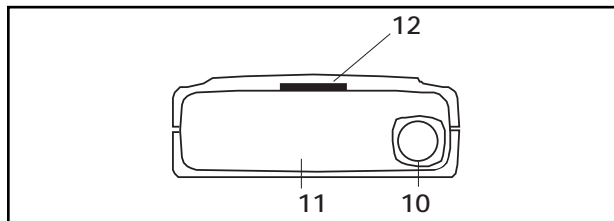

10. Laser Antenna (Front) – High gain optical lens array provides increased sensitivity and field of view for leading-edge laser detection.

11. Radar Antenna – Compact, high-efficiency antenna receives radar signals.

12. Mounting Bracket Location – Slot holds mounting bracket firmly.

WHISTLER FEATURES

Accessories

Accessories included are highly functional and easy to use.

Power Cord - Connects to the unit's power jack and your vehicle's lighter socket.

Windshield Bracket - Allows installation of unit on your vehicle's windshield.

Hook & Loop Fasteners - Designed to secure the unit on a level dashboard.

INSTALLATION

Mounting Guidelines

- Mount the unit as low as possible near the center of the windshield.
- Do not mount your unit behind wipers, ornaments, mirrored sunscreens, etc. These obstructions have metal surfaces which can affect radar and laser signals and reduce critical warning time. (Regular tinted glass does not affect reception.)
- Some newer windshields have an Instaclear™ or Electriclear™ type coating, which affect radar signals. Consult your dealer or the owner's manual supplied with your vehicle to determine if your windshield has this coating.
- Avoid placing unit in direct contact with windshield.
- To reduce the possibility of theft, conceal your unit when not in use.

Windshield Mounting

- Install the two suction cups and rubber bumper onto the bracket by fitting them into their holes.
- Press the suction cups onto the windshield at the location you have chosen. **IMPORTANT: Some newer cars have a plastic safety coating on the inside of the windshield. The windshield bracket may leave permanent marks on this type of surface. To find out if your vehicle has this type of windshield, check the owner's manual or ask your dealer. We recommend that you do not leave the suction cup bracket on the window in direct sunlight. If the detector is removed, this may cause blistering of the dash in some vehicles.**
- Slide the detector onto the bracket until it locks into place.
- If necessary, the unit may be leveled by bending the wind-

INSTALLATION

shield bracket. Press the bracket release button and remove the detector before bending.

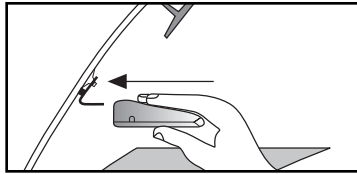

Dash Mounting

- Make sure the mounting location you have chosen is relatively level and is clean and dry. Clean with isopropyl alcohol if necessary to remove any waxes or polishes.
- Separate the fastener strips. Peel the paper backing off each strip and adhere one piece to the dash and the other piece to the bottom of the unit, taking care **not to cover the serial number**.

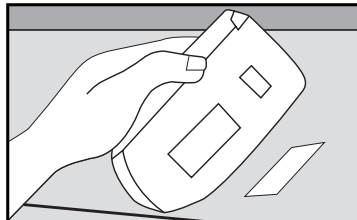

Be careful not to place the fastener strip over the unit's serial number. If the fastener strip is removed, the serial number may be pulled off the unit. Units without serial numbers are not covered under warranty.

INSTALLATION

Visor Mounting (optional accessory)

- Slide the visor bracket into the bracket mounting slot.
- Clip the visor bracket onto the visor making sure it is relatively level and has a clear view of the road.

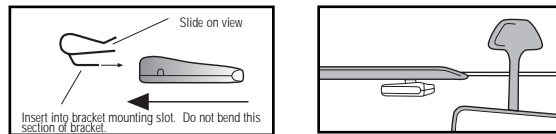

Power Connection

- Plug the small end of the power cord into the unit's power jack.
- Plug the large end into the vehicle's cigarette lighter.

Fuse Replacement

The lighter socket plug is equipped with a replaceable 2 amp 3AG fuse located behind the silver tip. To replace the fuse, carefully unscrew the tip of the plug. (**IMPORTANT:** Unscrew slowly. The tip contains a spring which may fly out when disassembling.) Insert the new fuse with the spring and screw on the tip. **With use, screw cap on plug may loosen. Retighten occasionally.**

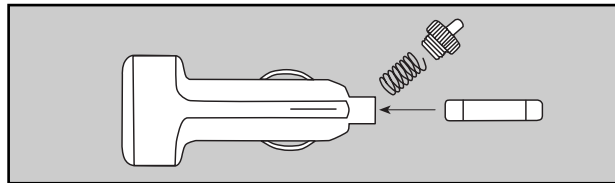

Unscrew the tip of the lighter socket plug carefully when replacing the 2 amp fuse.

OPERATION

Power On And Self-Test

Each time your Whistler detector is turned on, an automatic self-test sequence confirms that the speaker and visual displays are functional.

- Turn Power/Volume control clockwise. Display shows:

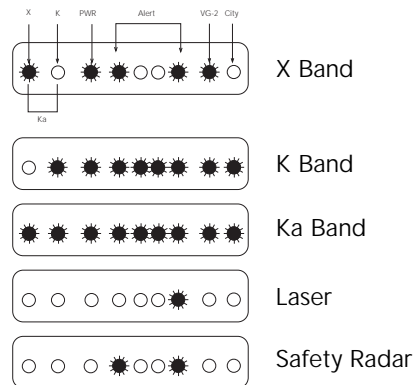

Feature Engaged Confirmation

Each time a button is pressed one beep confirms feature "on", two beeps confirm feature "off".

Integrated Real Voice™

Real Voice™ is used along with audio tones to articulate band identification and Safety Warning System™ messages.

OPERATION

Auto Quiet Mode

Auto Quiet shortens the tone for the selected audio approximately 3 seconds after a radar or safety radar signal is detected. The shorter tone will resume for any new signal within 20 seconds. Auto Quiet does not affect VG-2 or laser alerts.

- Press Quiet (before a signal is detected) to engage Auto Quiet. Display reads:

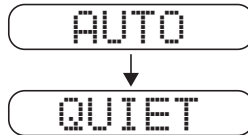

- Once the Auto Quiet mode is engaged, you may cancel the audio alarm by pressing Quiet.
- Press Quiet (when the unit is not alarming) to cancel Auto Quiet mode.

Quiet Mode

Quiet cancels audio during an alert and any new alert within 20 seconds. After 20 seconds, 2 beeps are provided on any new alert and the unit then remains quiet.

- Press Quiet to cancel the audio.
- Press Quiet a second time while unit is alarming to restore the standard audio alert pattern.

OPERATION

City Mode

Whistler's City Mode is designed to reduce the annoyance of automatic door openers, intrusion alarms and other devices which share frequencies with police radar.

- Press City to engage City. Display shows:

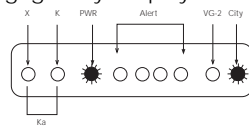

- Pressing City a second time cancels City. Display shows:



In City Mode, weak speed/safety radar signals give an initial alarm of two beeps, and then remains quiet unless the signal becomes very strong. When the signal strength increases, two additional beeps are provided.

Highway Mode

Highway mode provides full audio warnings any time radar (X, K, Ka, Safety) or laser signals are detected, and is recommended for open road driving. Highway mode is automatically engaged after the unit is turned on and completes the self-test.

OPERATION

Engaging VG-2

To engage or disengage VG-2 Detection:

- Press and hold the VG-2 button. Display shows:

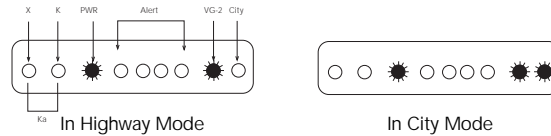

- Pressing VG-2 a second time disengages VG2.

VG-2 must be engaged each time your detector is turned on.

Vehicle Battery Saver Mode

The Vehicle Battery Saver Mode automatically shuts off your detector within 3 hours if you forget to turn it off. The timer is reset if the detector is turned off, unplugged or any button is pressed before the 3 hours have expired. The detector will alert you with an audible and visual warning before it shuts off. Display shows:

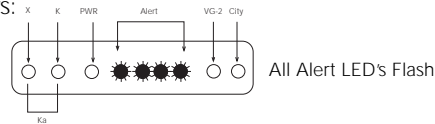

During this warning you can momentarily reset the unit by pressing any button. This will reset the timer.

If the unit has automatically turned itself off, press any button to turn the unit back on. You can manually engage the Vehicle Battery Saver Mode by pressing and holding the City button until one beep is heard. The auto shutoff function will initiate after several seconds.

RADAR/LASER ALERTS

Speed Radar Audio/Visual Alerts

When X, K or Ka is detected the band ID and signal strength is displayed. The audio alert is continuous and has a geiger counter-like pattern. The faster the beep the closer or stronger the radar source. Example:

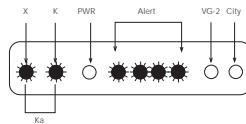

1 Alert LED = weak signal, 4 Alert LED's = strong signal

Pulse Protection®

When a pulse type signal (instant on strong signal) is detected an urgent 3 second audio warning is sounded and the display shows:



After 3 seconds standard alert pattern continues.

SAFETY RADAR ALERTS

In communities where transmitters are located, the Safety Warning System displays over 60 voice messages. When Safety Radar is detected the audio alert is geiger counter-like.

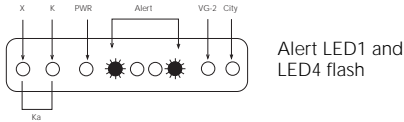

Note: Not all areas have Safety Warning System transmitters.

Laser Audio/Visual Alerts

When a laser signal is detected the alert LED's illuminate from right to left in a rolling pattern. The audio alert is continuous for a minimum of 3 seconds. Example:

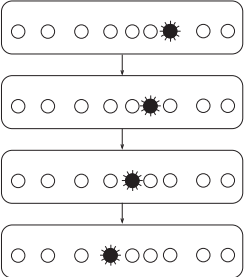

LASER ALERTS / VG-2 ALERTS

VG-2 Audio/Visual Alerts

When a VG-2 signal is detected, the detector “hides” its own radiated signal and becomes undetectable by the VG-2.

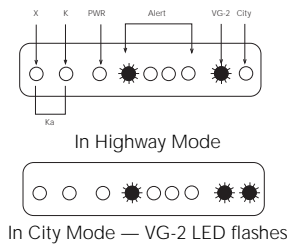

Every 30 seconds, the detector checks for a VG-2 signal. If a VG-2 signal is still present, the unit continues to hide and repeats the VG-2 alert. If no signal is detected, two beeps are provided, indicating an “all clear” condition. During VG-2 Alert X, K, and Ka band signals cannot be received. Note: VG-2 must be turned on to receive VG-2 alerts.

Alert Priority

When two or more signals are received at the same time, the alert priority is:

1. Laser
2. VG-2
3. Speed Radar
4. Safety Radar

Example:

If X band is alerting, then suddenly VG-2 is detected, the VG-2 warning will override the X band alert.

CARE & MAINTENANCE

Care And Maintenance

During the summer months, avoid prolonged exposure to direct sunlight by removing your unit from the dash when your vehicle is parked for an extended period of time.

Do not spray water, cleaners or polishes directly onto the unit. The spray may penetrate through the openings and damage the unit. Also, do not use any abrasive cleaners on the unit's exterior.

TROUBLESHOOTING GUIDE

Your Whistler detector is expertly engineered and designed to exacting quality standards to provide you with reliable, trouble-free operation. If your unit has been correctly installed following the guidelines in this manual, but is not operating optimally, please refer to the troubleshooting guide below.

PROBLEM: No display or audio.

- Check fuse in Whistler plug; replace if necessary with a 2 amp 3AG type.
- Check fuse for lighter socket; replace if necessary.
- Make sure lighter socket is clean.

PROBLEM: Unit alarms when vehicle hits bumps.

- Check for loose lighter socket; tighten and clean.
- Check connections at both ends of power cord. Substitute another cord to determine if cord is defective. Return defective cord to the factory.

PROBLEM: Unit alarms when using vehicle equipment, electrical accessories (brakes, power mirrors/windows, directionals, horn, etc.), or when accelerating.

- Vehicle's electrical system, including battery and alternator, may have electrical noise. Install a filter capacitor (470mfd. 25 volt or larger capacitance value) on the back of the lighter socket.

PROBLEM: Audio alerts are not loud enough.

- Cancel Auto Quiet Mode or City Mode.

PROBLEM: Unit gives laser alert when accelerating.

- Possible bad or low quality distributor cap. Replace with factory quality cap.

If difficulties occur which cannot be solved by information in this Troubleshooting Guide, please call Whistler Consumer Relations at 1-800-531-0004 before returning your unit for service.

ARE DETECTORS LEGAL?

In Most States YES!

Laser detectors are completely legal in every state when used in automobiles or light trucks (under 10,000 lbs.). Similarly, when used in automobiles or light trucks, radar detectors are legal in almost every state. Exceptions are Virginia and Washington, D.C., which have local regulations restricting the use of radar receivers in any vehicle.

Concerning trucks over 10,000 lbs., the Federal Highway Administration (FHWA) issued a regulation, effective January, 1994 which prohibits radar and laser detector use in these types of vehicles nationally.

Prior to the FHWA regulation, laws existed in the state of New York restricting the use of radar detectors in trucks over 18,000 lbs. and in the state of Illinois in trucks over 26,000 lbs.

SPEED MONITORING TECHNOLOGIES

Radar Facts

A radar gun operates by transmitting radio waves at certain frequencies which reflect off objects and are then picked up by the radar gun's receiving section. When a radar beam reflects off a moving target, a measurable frequency shift occurs. The radar unit converts this shift into miles per hour to determine your vehicle's speed.

Currently, the FCC (Federal Communications Commission) permits operation of traffic radar guns at X Band (10.500 - 10.550 GHz), K Band (24.050 - 24.250 GHz), and Ka Band (33.400 - 36.000 GHz).

Laser Facts

It's well documented that many radar guns cannot reliably provide the speed of a targeted vehicle that is traveling in a group of vehicles. In contrast, a laser gun can target a specific vehicle out of a line of traffic and determine its speed.

The advantage of laser over radar in terms of target identification is the result of the laser gun's narrow beam. A radar transmission can cover more than a four-lane highway at a distance of 1,000 feet, compared with a laser transmission which covers about 6 feet at the same distance.

For best protection, keep these points in mind:

- Because your vehicle's license plate or headlights are the laser gun's primary targets, mounting your Whistler detector on the dashboard can improve laser detection at short range.
- Do not follow closely behind any vehicle you cannot see through. If you can't see past a vehicle ahead of you, chances are your detector won't either.
- The receiving range of your laser detector will not be the same as a radar detector. Laser guns are most often used at short range.

SPEED MONITORING TECHNOLOGIES

Other Speed Detection Systems

Several techniques other than radar or laser are used to measure vehicle speeds. When these methods are being used, no detector can provide a warning. These techniques include:

- Pacing - A patrol car drives behind you and matches your driving speed.
- Vascar/Aircraft - The time it takes a vehicle to travel a known distance is measured.

Radar Detector Detectors

The Interceptor VG-2, or simply VG-2, is a microwave receiver used by police to detect signals radiated by the local oscillator of a radar detector. Because its purpose is to identify persons driving with radar detectors, the VG-2 is known as a "radar detector detector".

The VG-2 is the primary tool used by the police to identify radar detector equipped vehicles. If caught in a state where detectors are illegal (see pg. 18), drivers risk losing their radar detector and receiving a fine. In addition, instant-on radar is almost always used in combination with a VG-2, leaving unsuspecting motorists vulnerable to receiving two tickets — one potentially for speeding, the other for possession of a detector.

Having a radar detector capable of detecting the VG-2 may alert you to the presence of a speed trap.

WARRANTY INFORMATION

Consumer Warranty

The 1655 Whistler detector is warranted to the original purchaser for a period of one year from the date of original purchase against all defects in materials and workmanship. **This limited warranty is void if the unit is abused, modified, installed improperly, if the housing has been removed, or if the serial number is missing.** There are no express warranties covering this product other than those set forth in this warranty. All express or implied warranties for this product are limited to one year. Whistler is not liable for damages arising from the use, misuse, or operation of this product.

Service Under Warranty

During the warranty period, defective units will be repaired or replaced (with the same or a comparable model), at Whistler's option, without charge to the purchaser when returned prepaid, with dated proof of purchase to the address below. Units returned without dated proof of purchase will be handled as described in section "Service Out Of Warranty." Due to the specialized equipment necessary for testing a radar/laser receiver, there are no authorized service stations for Whistler brand detectors other than the factory.

When returning a unit for service under warranty, please follow these instructions:

1. Ship the unit in the original carton or in a suitable sturdy equivalent, fully insured, with return receipt requested, and shipping charges prepaid to:

Whistler Repair Dept.
1201 North Dixieland Rd.
Rogers, AR. 72756

WARRANTY INFORMATION

IMPORTANT: Whistler will not assume responsibility for loss or damage incurred in shipping. Therefore, please ship your unit insured with return receipt requested.

2. Include with your unit the following information, clearly printed:
 - Your name and street address (for shipping via UPS), and a daytime telephone number. (No P.O. Box please.)
 - A detailed description of the problem (e.g., "Unit performs self-test but does not respond to radar").
 - A copy of your dated proof of purchase or bill of sale.
3. Be certain your unit is returned with its serial number. For reference, please write your unit's serial number in the following space: s/n _____.

Units without serial numbers are not covered under warranty.

IMPORTANT: To validate that your unit is within the warranty period, make sure you keep a copy of your dated proof of purchase and return the Warranty Validation card.

WARRANTY INFORMATION

Service Out Of Warranty

Units will be repaired at "out of warranty" service rates when:

- The unit's original warranty has expired.
- Dated proof of purchase is not supplied.
- The unit has been returned without its serial number.
- The unit has been abused, modified, installed improperly, or had its housing removed.

The minimum out of warranty service fee for your Whistler detector is \$55.00 (U.S.). If you require out of warranty service, please return your unit as outlined in the section "Service Under Warranty" along with a certified check or money order for \$55.00. Payment may also be made by MasterCard or VISA; personal checks are not accepted. In the event repairs cannot be covered by the minimum \$55.00 service fee, you will be contacted by a Whistler technical service specialist who will outline options available to you. If you elect not to have your unit repaired/replaced, it will be returned to you along with your certified check or money order.

IMPORTANT: When returning your unit for service, be certain to include a daytime telephone number.

Consumer Relations

If you have questions concerning the operation of your Whistler detector, or require service during or after the warranty period, please call Consumer Relations at 1-800-531-0004. Representatives are available to answer your questions Monday - Friday from 8:00 a.m. to 5:00 p.m. (CST).

SPECIFICATIONS

- **Dimensions:** 1.6" H x 2.9" W x 4.5" L
- **Weight:** 7.5 oz.
- **Laser Wavelength:**
905 ± 50 nanometers (nm)
- **Radar Frequencies:**
10.500 - 10.550 GHz (X Band)
24.050 - 24.250 GHz (K Band)
33.400 - 36.000 GHz (Ka Superwideband)
- **Operating Temperature Range:**
-20° C to +80° C (-4° F to +176° F)
- **Power Requirements:**
Operational 12 to 15 volts DC, 250mA nominal
Vehicle Battery Saver, 30mA nominal.

One or more U.S. patents apply: #4,315,261; #5,146,227; #5,379,456; #5,666,120. Other patents pending.

Specifications are subject to change without notice.

ACCESSORIES

The following accessories can be ordered directly from Whistler by calling 1-800-531-0004.

Order Code	Description	Price
202138	Visor Bracket	\$ 6.95
202140	Windshield Bracket Kit	\$ 9.95
206294	*Modular Lighter Plug (Requires 206550 or 206551)	\$ 7.95
206550	*Modular Straight Power Cord (5') (Requires 206294)	\$ 6.95
206551	*Modular Coiled Power Cord (7') (Requires 206294)	\$ 7.95
206552	Straight Power Cord (5')	\$ 14.95
206553	Coiled Power Cord (7')	\$ 15.95
206879	Hook & Loop	\$ 1.95
206880	Hardwire Kit (10') (for wiring to fuse box)	\$ 9.95

*Modular: interconnecting pieces cord and plug.

Shipping and handling (per order) \$5.00

Prices are subject to change without notice.



THE WHISTLER GROUP
CORPORATE HEADQUARTERS
13016 N. Walton Blvd.
Bentonville, AR 72712
TEL (501) 273-6012 FX (501) 273-2927

PRODUCT DEVELOPMENT CENTER
25 Industrial Ave.
Chelmsford, MA 01824
TEL (978) 244-1400 FX (978) 244-1492

CUSTOMER RETURN CENTER
1201 N. Dixieland Rd.
Rogers, AR 72756
Consumer Relations Tel (800) 531-0004