

GOODSON

Tools and Supplies for Engine Builders

2024

www.goodson.com • 1-800-533-8010

From The President's Desk

Business is all about relationships. In fact, life is all about relationships.

My wife and I recently celebrated our 30th wedding anniversary. No small feat but it pales in comparison to my uncle and aunt's 70th wedding anniversary celebration just a few months later. My son and his fiancé will begin their married life together in 2024. Whether it's 30 years, 70 years or year one, the same elements necessary for a long, happy marriage are also key to a long, successful business relationship: respect, trust, ownership, and responsiveness. These ideals need to be present each and every day, not just once in a while.

At GOODSON our decades long commitment to our customer has not waived:

- Top notch customer service
- Same-day shipping
- Iron-Clad Guarantee
- Goodson Techxperts at your service
- Full Service ... Fast!

These bullet points aren't new at GOODSON. They embody our core values and, whether you have been our customer for one year, 30 years, or 70 years,



*Roger Schumacher,
Goodson President*

they represent our respect, trust, ownership, and responsiveness in our relationship with you.

GOODSON is closing in on a big anniversary next year, but it will be meaningless if we lose our focus on what is important today. At GOODSON, year 79 is no less important than year 80. Our goal is to make every transaction you have with GOODSON a pleasant experience and one that will make you value your relationship with us. We certainly value our relationship with you!

Thank you for your business!

Do You Have An Idea For The Next Great Product?

Many of the ideas for our most successful new products come directly from you, the guys in the shop. You work in this industry and have come up with some creative solutions to everyday problems. A great case in point is the Bucket Lifter Grinder you'll find over on page 45.

Contact me, Richard Orlikowski, and give me a call to learn more about how you can have Goodson produce and market your new product idea.



*Richard Orlikowski,
Goodson Product Manager*

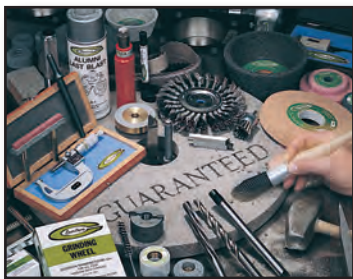

GOODSON Ironclad Guarantee

Goodson won't risk losing your business for any reason. If you're not 100% satisfied with

your purchase, we'll fix it, exchange it or credit your account for the purchase price.

To send an item back, just include a note detailing the reason for the return and ship it back, freight pre-paid within 30 days. The only time we can't honor this guarantee is if a tool has been damaged through misuse or modification. All abrasives have a shelf life so we can only guarantee them for one year from the original purchase date.

Contact Us

Goodson offices are open from 8:00am to 5:00pm, Monday through Friday (Central time).

Phone: 1-800-533-8010 (US & Canada)
1-507-452-1830 (International)

Fax: 1-888-466-3909 (US & Canada)
1-507-452-2907 (International)

Please note that the Goodson offices will be closed in observance of these 2024 holidays: New Year's Day (January 1), Easter (March 29), Memorial Day (May 27), Independence Day (July 4), Labor Day (September 2), Thanksgiving (November 28 & 29), Christmas (December 24 & 25) and New Year's Eve (December 31).

We're always open on the web!

Web: www.goodson.com

Email: orderdesk@goodson.com

New for 2024!

Rimac® Valve Spring Testers

new

Rimac® Valve Spring Testers

- Specifically designed for quick, easy testing of multiple valve springs
- High-torque, lever-actuated compression is key to repeatable precision
- The vertical design ensures stability on the workbench
- Ideal for use in the shop, but portable enough to take to the racetrack
- Calibrated spring set includes two springs with different ranges that can be combined for a range of 10 to 640 lbs.

Description	Jobber	Order No.
0-500 lb. Tester (reads in 5 lb. increments)	\$899.99	VST-69
0 to 1000 lb. Tester (reads in 2 lb. increments)	899.99	VST-70
Calibrated Test Spring Set (2 pc.set)	79.95	VST-SPRINGS

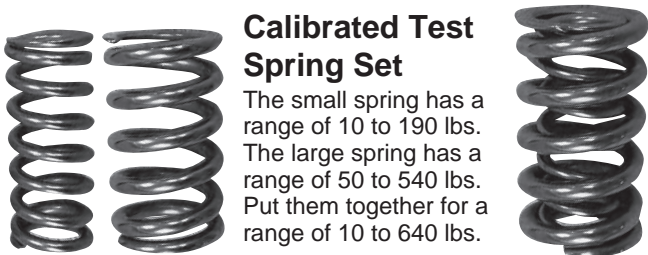

Calibrated Test Spring Set

The small spring has a range of 10 to 190 lbs. The large spring has a range of 50 to 540 lbs. Put them together for a range of 10 to 640 lbs.



made in America

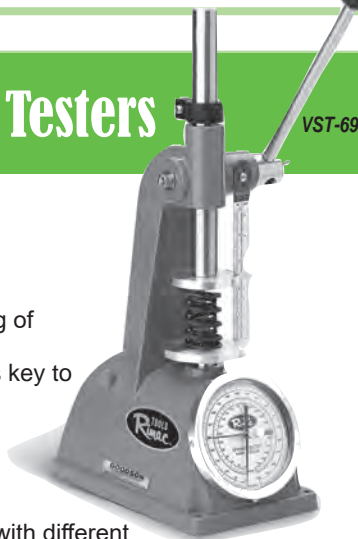

VST-69

Positive stop for checking repeatability

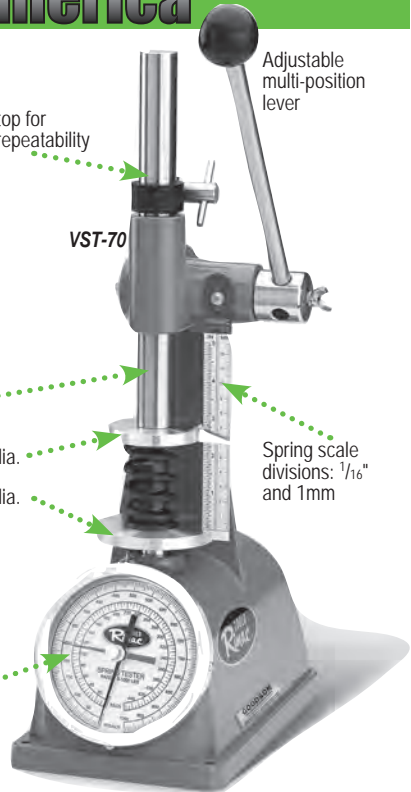

VST-70

Adjustable multi-position lever

Ram travels 4⁵/₈"

Upper Platform measures 2¹/₄" dia.

Lower Platform measures 3¹/₄" dia.

Spring scale divisions: 1/16" and 1mm

Easy to read dial shows both pounds and kilograms

MORE NEW PRODUCTS TO COME!

Stay up to date on new products by visiting our website (goodson.com) or signing up to receive our email newsletter, This Week at Goodson.



3M™ Trizact™ Crankshaft Polishing Belts

- X-Weight cloth belt • A45 micron – equivalent to 400 grit
- Structured abrasive grains are perfectly shaped pyramids bonded at equal spacing to a high-strength polyester backing • Uniform wear for better performance and long life • Produce a high-luster finish • 5 per box

Size	Jobber	Order No.
64"L x 1"W	\$58.99	GSA-64x1
72"L x 1"W	63.99	GSA-72x1

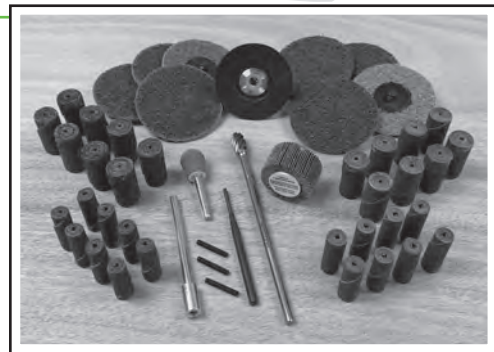

David Vizard Porting Kit

Industry legend, David Vizard asked Goodson to put together a porting kit for a project he was working on. This kit is packed in a plastic carrying case and contains:

Description	Grit	Kit Qty.	Jobber	Order No.	Incl.
David Vizard Porting Kit			\$179.99	DVP-KIT	▼
Open Fluted Carbide Rotary File		1	89.99	LAFR-70	x
Ball Mounted Point	40	1	9.99	GM-25	x
4" Long Roll Mandrel		1	12.99	CR-40	x
3/4" Straight Cartridge Rolls	40	8	66.99	SCR-750-40	x
3/4" Straight Cartridge Rolls	80	8	66.99	SCR-750-80	x
1/2" Straight Cartridge Rolls	60	8	34.99	SCR-500-60	x
1/2" Straight Cartridge Rolls	80	8	34.99	SCR-500-80	x
4" Cross-Buff/Flap Wheel Mandrel		1	14.99	CB-MANDREL	x
1 ⁵ / ₈ " dia., Flapwheel	80	1	14.99	APK-7	x
3" Disc Holder		1	19.99	RLH-3	x
3" Roll Lock Discs	Medium	4	20.99	RSCD-3M	x
3" Roll Lock Discs	Coarse	4	24.99	RSCD-3C	x

CYLINDER HEAD REBUILDING
CLEANING, ASSEMBLY & SAFETY
SHORT BLOCK REBUILDING
FLYWHEEL, GRINDING
CRANKSHAFT/
MISCELLANEOUS TOOLS & SUPPLIES
BRAKE SERVICE TOOLING
MEASURING TOOLS
V-TWIN & METRIC HARD PARTS

RAPIDEX

A rapid-use index of product categories

Cylinder Head Rebuilding

Pilots.....	3-5
Valve Seat Work.....	6-24
Valve Refacing.....	25-29
Reamers.....	30-31
Valve Guide Resizing.....	32-34
Valve Guide Replacement.....	35-39
Valve Seal Work.....	40
Valve Spring Work.....	41-46
Cylinder Head Resurfacing.....	48-51
Crack Detection & Repair.....	52-55
Porting & Polishing.....	58-60

Cleaning, Assembly & Safety

Parts Storage & Organizers.....	61-63
Parts Baskets.....	63
Wire Wheels & Brushes.....	64-65
Cleaning.....	66-69
Last Blast Paint & Metal Markers.....	70
Assembly Lubes.....	71
Coolants & Lubricants.....	72-74

Index	75-82
Flex-Hones®.....	83

Short Block Rebuilding

Boring Bar Tooling & Supplies.....	84-85
Cylinder Honing.....	86-91
Rod Honing.....	92
Rod & Piston Work.....	93-97
Lifter Bore Tooling.....	99
Camshaft Work.....	100-101

Crankshaft/Flywheel Grinding

Crankshaft Grinding Wheels.....	102-103
Crankshaft Grinding & Polishing.....	105-109
Flywheel Grinding.....	110-113

Miscellaneous Tools

Diamond Dresser Tools.....	114-115
Miscellaneous.....	116

Brake Service Tooling

Brake Tips & Holders.....	117-118
Brake Lathe Silencers.....	119
Brake Lathe Replacement Parts.....	120-122

Measuring Tools

Straight Edges.....	123
Dial Bore Gauges.....	125-126
Calipers & Dial Indicators.....	127
Micrometers.....	129

V-Twin Hard Parts

Valve Springs.....	130-132
Seats & Seat Inserts.....	133
Valve Guides.....	134
Replacement Valves.....	135

© Copyright 2024, Goodson Mfg. Co., Inc. All copy and illustrations are copyrighted. Absolutely no mechanical or electronic reproduction or use of any part is allowed without our prior written permission. Goodson reserves the right to correct printing errors. Prices are subject to change without notice.

Policies

See page 84 for more information about these policies.

Pricing:

Prices are subject to change without notice. There is no minimum order. Orders are billed at the prices in effect at the time of shipping. Discounts are not available on select items including Sunnen®, UltraSonic, LLC and QualCast Products.

Shipping:

Goodson typically ships orders the same day they are received. Orders received after 2:00pm (central), on weekends or holidays are shipped the next business day. If your order is lost in shipping, Goodson works with the shipper to provide tracking service. Please inspect all shipments upon receipt and report damage or errors within 48 hours.

Freight:

For orders shipped ground within the USA, you may deduct the freight charges on any **JOBBER** net invoice of \$800 or more if you pay within 30 days of the invoice date. Glass Beads, Steel Shot, Tumbler Media, Machines, Equipment, Bulk Liquids, Cleaning Detergents and Crankwheels are not included. Hazardous Materials, Dangerous Goods & Dimensional Shipping fees may apply on some items.

Terms:

- 1) A 1% discount is given on merchandise if payment is made within 15 days from **invoice** date. This discount applies only to the merchandise amount (not the total amount) on the **invoice** (not a statement). The discount amount is shown in the lower left hand corner of the invoice. This discount does not apply to statement payments and does not apply to credit card orders.
- 2) Balances not paid in full within 30 days are subject to a finance charge of 1.5% per month (18% per year).

Credit & Debit Card Orders:

Goodson accepts MasterCard, Visa, American Express, Discover Card and PayPal. For your security, credit card numbers are **NOT** kept on file. Credit Card and PayPal orders do not qualify for the 1% quick-pay discount.

Check Acceptance:

In the unlikely event that your check is returned for insufficient or held funds, we will debit your checking account electronically for the face amount of the check plus the service fee allowed by your state's law. This allows us to resolve the problem without turning you over to a collection agency and harming your credit rating. The transaction will appear on your bank statement and no one will have to contact you about payment.

Returns:

You may return any item, except special orders, within 60 days. We will do our best to correct any problems or to send a replacement. If an item was damaged through mis-use or modification, Goodson will not accept it as a return. Credits will only be issued after it is determined that the part is resellable or it is deemed defective.

Some Hazardous Materials are Non-returnable due to shipping regulations. See our policies on the last page of the index for more details or call us toll-free at 1-800-533-8010.

ABRASIVES WARRANTY: Abrasives have a shelf life, therefore, all abrasives are warranted against manufacturing defects for 1 year from the date of original purchase.

RESETTING/RESHARPENING SERVICE: Premium Diamonds can be reset and many of our cutting tools, including CBN inserts, FT/VSA cutters and VN-65C can be resharpened. Send your resets and resharps to **GOODSON Tools & Supplies**, ATTN: Resharps, 156 Galewski Dr. Winona, MN 55987. Be sure to include your customer number.



Solid Tapered Pilots

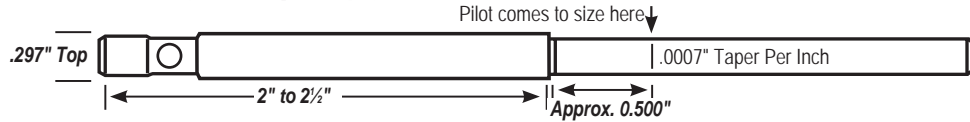

.297" Solid-Tapered High Speed Steel Pilots

Inch	mm	OAL	Order No.	Inch	mm	OAL	Order No.	Inch	mm	OAL	Order No.	Inch	mm	OAL	Order No.
.1574"	4.00	4.50"	P-1158N	.1779"	4.52	4.50"	P-1178N	.2165"	5.50	4.50"	P-1216N	.2500"	6.35	4.50"	P-1250N
.1582"	4.02	4.50"	P-1159N	.1968"	5.00	4.50"	P-1197N	.2362"	6.00	4.50"	P-1236N	.2510"	6.37	4.50"	P-1251N
.1771"	4.50	4.50"	P-1177N	.1976"	5.02	4.50"	P-1198N	.2370"	6.02	4.50"	P-1237N	.2598"	6.60	4.50"	P-1260N
Jobber			\$28.99	Jobber			\$28.99	Jobber			\$28.99	Jobber			\$28.99

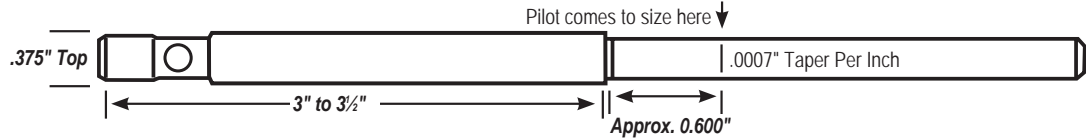

.375" Solid-Tapered High Speed Steel Pilots

Inch	mm	OAL	Order No.	Inch	mm	OAL	Order No.	Inch	mm	OAL	Order No.	Inch	mm	OAL	Order No.
.1771"	4.50	6.00"	P-5177N	.2490"	6.32	6.00"	P-5249N	.2952"	7.50	6.00"	P-5295N	.3417"	8.67	6.50"	P-5341N
.1960"	4.98	6.00"	P-5196N	.2500"	6.35	6.00"	P-5250N	.3095"	7.86	6.00"	P-5309N	.3427"	8.70	6.50"	P-5342N
.1968"	5.00	6.00"	P-5197N	.2559"	6.50	6.00"	P-5256N	.3105"	7.88	6.00"	P-5310N	.3437"	8.72	6.50"	P-5343N
.1976"	5.02	6.00"	P-5198N	.2566"	6.52	6.00"	P-5257N	.3115"	7.91	6.00"	P-5311N	.3447"	8.75	6.50"	P-5344N
.2165"	5.50	6.00"	P-5216N	.2598"	6.60	6.00"	P-5260N	.3125"	7.93	6.00"	P-5312N	.3457"	8.78	6.50"	P-5345N
.2173"	5.52	6.00"	P-5217N	.2748"	6.98	6.00"	P-5274N	.3135"	7.96	6.00"	P-5313N	.3543"	9.00	6.50"	P-5354N
.2185"	5.55	6.00"	P-5218N	.2756"	7.00	6.00"	P-5275N	.3145"	7.98	6.00"	P-5314N	.3551"	9.02	6.50"	P-5355N
.2354"	5.98	6.00"	P-5235N	.2763"	7.02	6.00"	P-5277N	.3149"	8.00	6.00"	P-5315N	.3587"	9.11	6.50"	P-5358N
.2362"	6.00	6.00"	P-5236N	.2775"	7.05	6.00"	P-5278N	.3165"	8.03	6.00"	P-5316N	.3730"	9.47	7.00"	P-5373N
.2370"	6.02	6.00"	P-5237N	.2792"	7.09	6.00"	P-5279N	.3407"	8.65	6.50"	P-5340N	.3740"	9.49	7.00"	P-5374N
Jobber			\$38.99	Jobber			\$38.99	Jobber			\$38.99	Jobber			\$38.99

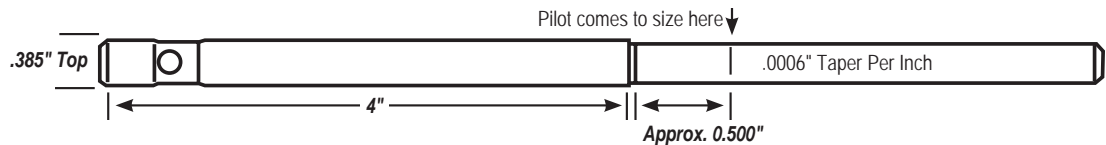

.385" Solid-Tapered High Speed Steel Pilots

Inch	mm	OAL	Order No.	Inch	mm	OAL	Order No.	Inch	mm	OAL	Order No.	Inch	mm	OAL	Order No.
.2165"	5.50	7.50"	P-5216S	.2598"	6.60	7.50"	P-5260S	.3125"	7.94	7.50"	P-5312S	.3420"	8.68	7.50"	P-5342S
.2173"	5.52	7.50"	P-5217S	.2744"	6.97	7.50"	P-5274S	.3130"	7.95	7.50"	P-5313S	.3430"	8.71	7.50"	P-5343S
.2350"	5.97	7.50"	P-5235S	.2755"	7.00	7.50"	P-5275S	.3141"	7.98	7.50"	P-5314S	.3440"	8.73	7.50"	P-5344S
.2362"	6.00	7.50"	P-5236S	.2763"	7.02	7.50"	P-5276S	.3149"	8.00	7.50"	P-5315S	.3450"	8.76	7.50"	P-5345S
.2370"	6.02	7.50"	P-5237S	.2771"	7.04	7.50"	P-5277S	.3161"	8.03	7.50"	P-5316S	.3543"	9.00	7.50"	P-5354S
.2381"	6.05	7.50"	P-5238S	.2779"	7.06	7.50"	P-5278S	.3170"	8.05	7.50"	P-5317S	.3550"	9.02	7.50"	P-5355S
.2500"	6.35	7.50"	P-5250S	.3100"	7.87	7.50"	P-5310S	.3410"	8.66	7.50"	P-5341S	.3560"	9.04	7.50"	P-5356S
Jobber			\$51.99	Jobber			\$51.99	Jobber			\$51.99	Jobber			\$51.99

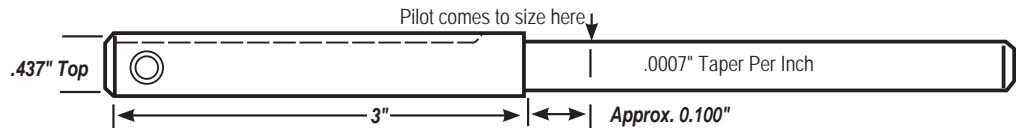

.437" Solid-Tapered High Speed Steel Pilots

Inch	mm	OAL	Order No.	Inch	mm	OAL	Order No.	Inch	mm	OAL	Order No.	Inch	mm	OAL	Order No.
.2165"	5.50	6.75"	P-5216K	.2381"	6.05	6.75"	P-5238K	.3115"	7.90	6.75"	P-5311K	.3150"	8.00	6.75"	P-5315K
.2185"	5.55	6.75"	P-5218K	.2755"	7.00	6.75"	P-5275K	.3125"	7.94	6.75"	P-5312K	.3157"	8.02	6.75"	P-5316K
.2362"	6.00	6.75"	P-5236K	.2763"	7.02	6.75"	P-5276K	.3135"	7.96	6.75"	P-5313K	.3169"	8.05	6.75"	P-5317K
.2370"	6.02	6.75"	P-5237K	.2775"	7.05	6.75"	P-5277K	.3145"	7.98	6.75"	P-5314K	.3427"	8.70	6.75"	P-5342K
Jobber			\$63.99	Jobber			\$63.99	Jobber			\$63.99	Jobber			\$63.99

CYLINDER HEAD REBUILDING
CLEANING, ASSEMBLY & SAFETY
SHORT BLOCK REBUILDING
FLYWHEEL GRINDING
CRANKSHAFT/ TOOLS & SUPPLIES
MISCELLANEOUS
BRAKE SERVICE TOOLS
MEASURING TOOLS
V-TWIN & METRIC HARD PARTS



Every Expanding Pilot Comes Complete With A Collet & Expander

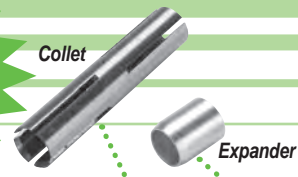

CYLINDER HEAD REBUILDING

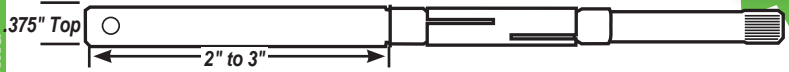

.375" Top Expanding Pilots

- Includes Collet & Expander • Expand up to .020" (.51mm)
- High Speed Steel

Size	mm	Range	OAL	Pilot	Collet	Expander
.216"	5.50	.213"-.233"	5.875"	P-5.5MMNX	P-216-COLLET	P-1216-EXP
.236"	6.00	.233"-.253"	5.813"	P-6MMNX	P-6MM-COLLET	P-1236-EXP
.256"	6.50	.253"-.273"	5.875"	P-6.5MMNX	P-6.5MM-COLLET	P-6.5MM-EXP
.275"	7.00	.272"-.292"	6.250"	P-7MMNX	P-7MM-COLLET	P-7MM-EXP
.312"	7.92	.309"-.329"	6.500"	P-312NX	P-312-COLLET	P-343-EXP
.335"	8.50	.330"-.350"	6.500"	P-8.5MMNX	P-343-COLLET	P-343-EXP
.343"	8.70	.340"-.360"	7.063"	P-343NX	P-343-COLLET	P-343-EXP
.375"	9.50	.372"-.392"	7.000"	P-375NX	P-375-COLLET	P-375-EXP
.393"	10.00	.390"-.410"	6.875"	P-10MMNX	P-10MM-COLLET	P-10MM-EXP
.437"	11.00	.430"-.450"			P-11MM-COLLET	P-11MM-EXP
.472"	12.00	.469"-.489"			P-12MM-COLLET	P-12MM-EXP
Jobber				\$59.99	\$19.99	\$11.99

CLEANING, ASSEMBLY & SAFETY



.375" Extended Length Expanding Pilots

- Includes Collet & Expander • Expand up to .020" (.51mm)
- High Speed Steel

Size	mm	Range	OAL	Pilot	Collet	Expander
.3120"	7.92	.309"-.329"	7.750"	P-312NXL	P-312L-COL	P-343-EXP
.3430"	8.71	.340"-.360"	7.750"	P-343NXL	P-343L-COL	P-343-EXP
.3750"	9.52	.372"-.392"	7.813"	P-375NXL	P-375L-COL	P-375-EXP
Jobber				\$63.99	\$19.99	\$11.99

SHORT BLOCK REBUILDING



.437" Top Expanding Pilots

- Includes Collet & Expander • Expand up to .020" (.51mm)
- High Speed Steel

Size	mm	Range	OAL	Pilot	Collet	Expander
.236"	6.00	.233"-.253"	6.750"	P-6MMKX	P-6MM-COLLET	P-1236-EXP
.275"	7.00	.272"-.292"	7.250"	P-7MMKX	P-7MM-COLLET	P-7MM-EXP
.312"	7.92	.309"-.329"	7.500"	P-312KX	P-312-COLLET	P-343-EXP
.343"	8.70	.340"-.360"	7.563"	P-343KX	P-343-COLLET	P-343-EXP
.375"	9.50	.372"-.392"	7.500"	P-375KX	P-375-COLLET	P-375-EXP
.453"	11.50	.450"-.470"	7.875"	P-453KX	P-11.5MM-COLLET	P-11MM-EXP
Jobber				\$72.99	\$19.99	\$11.99

CRANKSHAFT/ FLYWHEEL GRINDING



.385" Top Expanding Pilots

- Includes Collet & Expander • Expand up to .020" (.51mm)
- High Speed Steel

Size	mm	Range	OAL	Pilot	Collet	Expander
.236"	6.00	.233"-.253"	7.375"	P-6MMSX	P-6MM-COLLET	P-1236-EXP
.256"	6.50	.253"-.273"			P-65MM-COLLET	P-6.5MM-EXP
.275"	7.00	.272"-.292"	7.750"	P-7MMSX	P-7MM-COLLET	P-7MM-EXP
.312"	7.92	.309"-.329"	8.000"	P-312SX	P-312-COLLET	P-343-EXP
.343"	8.70	.340"-.360"	8.000"	P-343SX	P-343-COLLET	P-343-EXP
.375"	9.50	.372"-.392"	8.000"	P-375SX	P-375-COLLET	P-375-EXP
.393"	10.00	.390"-.410"	7.875"	P-10MMSX	P-10MM-COLLET	P-10MM-EXP
.406"	10.30	.403"-.423"	8.000"	P-406SX	P-10MM-COLLET	P-10MM-EXP
.437"	11.00	.430"-.450"	8.000"	P-11MMSX	P-11MM-COLLET	P-11MM-EXP
.453"	11.50	.450"-.470"	7.875"	P-453SX	P-12MM-COLLET	P-11MM-EXP
.472"	12.00	.469"-.489"	8.500"	P-12MMSX	P-12MM-COLLET	P-12MM-EXP
.500"	12.70	.497"-.517"	8.438"	P-500SX	P-12MM-COLLET	P-12MM-EXP
Jobber				\$99.99	\$19.99	\$11.99

MISCELLANEOUS TOOLS & SUPPLIES

.0007" taper per inch

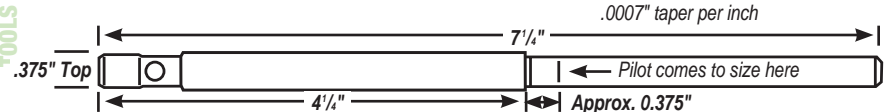

Extended Length (7 1/4") .375" Top Solid-Tapered High Speed Steel Pilots

Inch	mm	OAL	Order No.	Inch	mm	OAL	Order No.
.2755"	7.00	7.25"	P-5275NL	.3437"	8.73	7.75"	P-5343NL
.2756"	7.01	7.25"	P-5276NL	.3447"	8.75	7.75"	P-5344NL
.3145"	7.98	7.25"	P-5314NL	.3457"	8.78	7.75"	P-5345NL
.3150"	8.00	7.25"	P-5315NL	.3740"	9.50	7.75"	P-5374NL
.3417"	8.68	7.75"	P-5341NL	.3750"	9.52	7.75"	P-5375NL
.3427"	8.70	7.75"	P-5342NL	Jobber			\$53.99
Jobber			\$65.99				

BRAKE SERVICE TOOLING

MEASURING TOOLS

V-TWIN & METRIC HARD PARTS

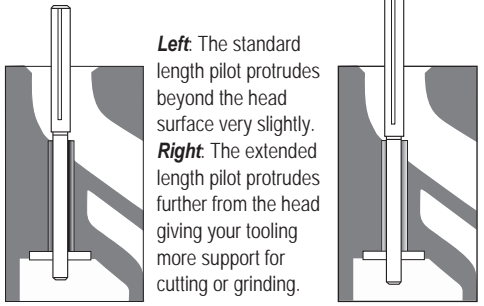

Left: The standard length pilot protrudes beyond the head surface very slightly.
Right: The extended length pilot protrudes further from the head giving your tooling more support for cutting or grinding.

Setting your expanding pilot

tech tips from the techxperts™

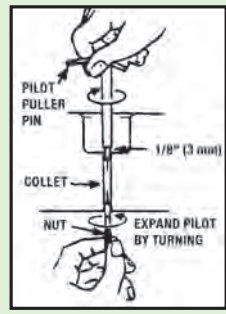

- 1 Select an expanding pilot that is the same diameter as the valve guide ID.
- 2 Insert the pilot into the valve guide making sure that the expanding section of the pilot (collet) is completely within the valve guide. The pilot will not center properly and may be damaged if the collet extends outside of the valve guide.
- 3 Pilot shoulder should be about 1/8" above the valve guide.
- 4 Hold the pilot while turning the nut at the opposite end. This will expand the collet and secure the pilot into position.

NOTE: DO NOT use Expanding Pilots with multi-angle valve seat cutting systems (ie: 3-D Fast Cut)

Carbide, Dresser & Specialty Pilots

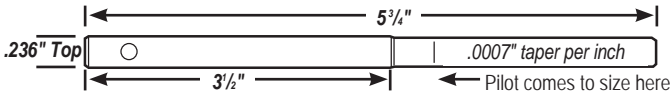

.236" Top Tapered Carbide Pilots

- Less deflection under stress • Due to the brittle nature of carbide we can only warranty carbide pilots for size

Inch	mm	Order No.	Inch	mm	Order No.	Inch	mm	Order No.
.1559"	3.96	PCT-1560M	.1759"	4.47	PCT-1760M	.2560"	6.50	PCT-2560M
.1566"	3.98	PCT-1570M	.1771"	4.50	PCT-1770M	.2570"	6.53	PCT-2570M
.1575"	4.00	PCT-1575M	.1968"	5.00	PCT-1970M	.2578"	6.55	PCT-2580M
.1578"	4.01	PCT-1580M	.2161"	5.49	PCT-2160M	.2763"	7.02	PCT-2765M
Jobber		\$259.99	Jobber		\$259.99	Jobber		\$259.99

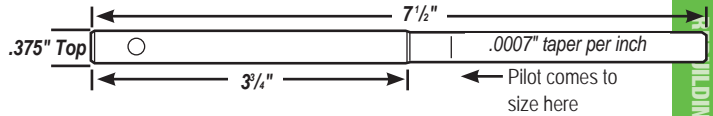

.375" Top Tapered Carbide Pilots

- Less deflection under stress • Due to the brittle nature of carbide we can only warranty carbide pilots for size

Inch	mm	Order No.	Inch	mm	Order No.	Inch	mm	Order No.
.1968"	5.00	PCT-1970	.2756"	7.00	PCT-2756	.3150"	8.00	PCT-3150
.2165"	5.50	PCT-2165	.2759"	7.01	PCT-2760	.3433"	8.72	PCT-3430
.2173"	5.52	PCT-2170	.2763"	7.02	PCT-2765	.3440"	8.73	PCT-3440
.2362"	6.00	PCT-2362	.2771"	7.04	PCT-2770	.3740"	9.50	PCT-3740
.2370"	6.02	PCT-2370	.3122"	7.93	PCT-3120			
Jobber		\$259.99	Jobber		\$259.99			



Valve Seat Wheel Dresser Pilots for Universal & Heavy Duty Wheel Dressing Stands

- All pilots have a .625" bottom • Dressing stands, page 24

Dresser Pilots (select based on stone holder type)			
Fits Stone Holder Type	OAL	Jobber	Order No.
A .437" Hex Stone Holder	5 1/2"	\$164.99	031-1102-89
B .437" Hex or Flex Stone Holder	7 1/4"	164.99	031-0202-80
C .385" Top Stone Holder	6"	164.99	031-0202-55
D .375" Top Stone Holder	6 3/4"	164.99	031-0202-47

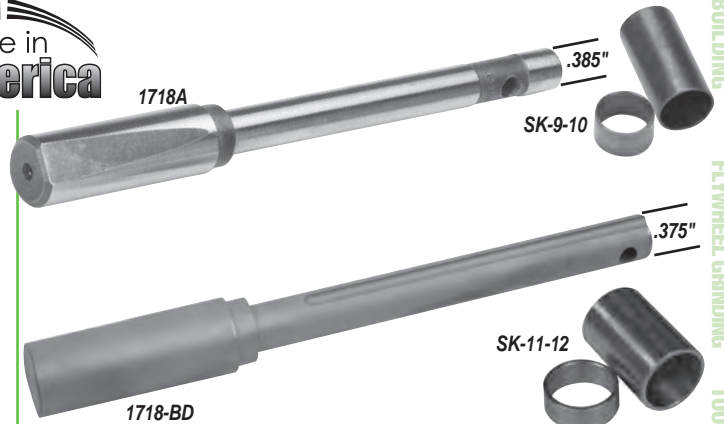

Sioux-Style Dresser Stand Pilots & Bushings

- Replacement parts for the popular 1716 Seat Wheel Dresser no longer available from Sioux™
- .375" top pilot features a groove to fit Black & Decker holders • .600" bottom size

Description	Jobber	Order No.
.385" Top Pilot, .600" Bottom Size	\$94.99	1718A
.375" Top Pilot, .600" Bottom Size	94.99	1718-BD
Dressing Stand Bushings (2) for .375" & .385" Pilots	12.49	SK-9-10
Dressing Stand Bushings (2) for .572" Pilots	12.49	SK-11-12

Specialty Pilots



3/16" Shank Pilots for Valve Guide Top Cutters

Size	Jobber	Order No.
.312" (7.93mm)	\$20.99	GFP-312
.343" (8.73mm)	20.99	GFP-343
.375" (9.53mm)	20.99	GFP-375
.437" (11.11mm)	20.99	GFP-437
.500" (12.70mm)	20.99	GFP-500

See page 33 for Valve Guide Top Cutters



Valve Guide Pilots for Seal & Seat Cutting

Hardened & Ground Pilots			
Guide ID	Jobber	Order No.	
.275"	7.0	\$42.99	VP-7MM
.312"	7.9	42.99	VP-312
.343"	8.7	42.99	VP-343
.375"	9.5	42.99	VP-375

See pages 36 and 46 for Applications

Replaceable Pilots for Adjustable Valve Guide Driver

Diameter	Jobber	Order No.
.312"	\$26.99	AVG-312
.343"	26.99	AVG-343
.372"	26.99	AVG-372
.437"	26.99	AVG-437
5.0mm	26.99	AVG-5MM
5.5mm	26.99	AVG-55MM

See page 36 for More Sizes & Tooling

CYLINDER HEAD BILDING
CLEANING, ASSEMBLY & SAFETY
SHORT BLOCK REBUILDING
CRANKSHAFT/ FLYWHEEL GRINDING
MISCELLANEOUS TOOLS & SUPPLIES
BRAKE SERVICE TOOLING
MEASURING TOOLS
V-TWIN & METRIC HARD PARTS

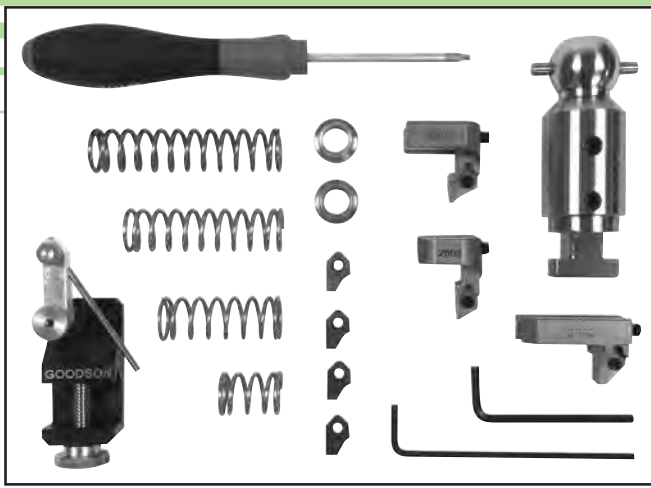

3-D Fast Cut™ Starter Kits

- Can be used with your existing solid taper pilots
- Ball heads are available to fit most common seat grinder pilots
- Choose from over 100 3-angle blade profiles on pages 8-11
- Fully compatible with most popular 3-angle cutting systems including Kwik-Way®, Peterson, Rottler, Serdi, Sunnen®, T&S, Winona Van Norman®, Newen®, etc. • Use between 50 and 100 RPM • Goodson recommends starting at 60 RPM

Description	Fits Pilot	Jobber	Order No.	Includes
Complete Starter Kits	.375" / 9.53mm	\$1299.99	3D-375-KIT	
(See page 3 & 5 for pilots)	.385" / 9.78mm	1299.99	3D-385-KIT	
Ball Head Standard	.375" / 9.53mm Use with 3D tip holders	299.99	3D-BH375	x
3.346" long	.385" / 9.78mm Use with 3D tip holders	299.99	3D-BH385	x
	.390" / 9.90mm Use with 3D tip holders	299.99	3D-BH390	
	.375" / 9.53mm Use with SGM tip holders	399.99	3D-BH-SUN375	
Ball Head Extended	.375" / 9.53mm Use with 3D tip holders	339.99	3D-BH375L	
Length 3.80" long				
Ball Head Wide Body	.375" / 9.53mm Use with 3D tip holders	499.99	3D-BH375W	
4.0625" long				
Serdi-Style Tool Bodies	Use with Serdi-style pilots			
4" long	Standard .375" / 9.53mm	\$429.99	SER-5100	
	Large Body .375" / 9.53mm	534.99	SER-5300	
Sunnen Style Drive Adaptor for VGS-20		469.99	3D-SUN	
Tip Holders	.709" - 1.181" / 18-30mm Range	234.99	3D-2000	x x
(Includes FT-SCREW)	1.02" - 1.653" / 26-42mm Range	234.99	3D-2001	x x
	1.575" - 2.362" / 40-60mm Range	234.99	3D-2002	x x
Tip Holders-Wide Body	1.575" - 2.362" / 40-60mm Range	319.99	3D-2003	
	2.385" - 3.150" / 58-80mm Range	339.99	3D-2004	
Cutters	45°/1.0mm	49.99	FT-45039V1	x x
	45°/1.3mm	49.99	FT-45051V1	x x
more on pages 8-11	45°/1.5mm	49.99	FT-45059V1	x x
	45°/1.9mm	49.99	FT-45075V1	x x
Tool Setting Fixture - All Steel Construction		167.99	3D-TSFA	x x
Cutter Blade Mounting Screw		5.99	FT-SCREW	
Blade Wrench		14.99	FT-WRENCH	x x
Automotive Bounce Spring Set (4 Pc.)		28.99	3D-SS4	x x
Bushing Set (1 pair)	.375"	10.99	3D-DB7	x
	.385"	10.99	3D-DB6	x
Ball Head Driver	#3 Morse Taper Driver	479.99	3D-CM3	
	Bridgeport & DCM Driver	419.99	3D-3/4SS	
3-D Fast Cut™ Accessories				
Lift Clip for Enhanced Control, especially on Spring Pad Cutters (pg. 12)		\$25.99	3D-CLIP	
Replacement 3.0mm Allen Key		1.99	3D-3.0	x x
Replacement 2.5mm Allen Key		1.99	3D-2.5	x x
Replacement Screws for NWN Ball Head Base (5 Pack) - metric		2.29	MGA-4X5MM	
Replacement Base Screw for Standard Ball Heads M5x6MM		1.99	3D-56	
Replacement Base Screw for Wide Body Ball Heads M6x6MM		1.99	3D-66	
Replacement Side Screw for Standard Ball Heads M6x8MM, Brass Tip		5.99	3D-68	
Replacement Side Screw for Wide Body Ball Heads M6x16MM, Brass Tip		5.99	3D-615	
Adjusting Screw for Tip Holder #3D-2000, OAL: .395" /10mm		8.49	3D-2000-S	
Adjusting Screw for Tip Holder #3D-2001, OAL: .475" /12mm		8.49	3D-2001-S	
Adjusting Screw for Tip Holder #3D-2002, OAL: .625" /15.9mm		8.49	3D-2002-S	

See page 7 for Valve Seat Removal Tooling for the 3-D Fast Cut™ System

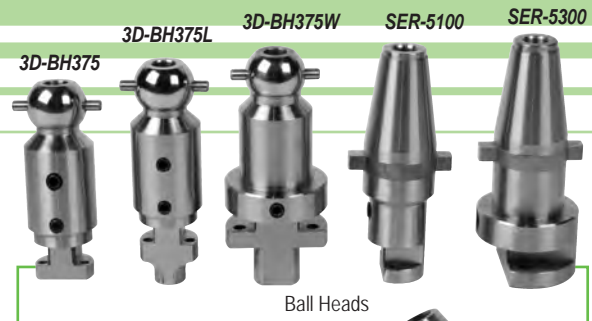

Ball Heads



Watch an overview of the 3-D Fast Cut™ System in our Tech Lab Tuesday video. Scan the code below with your smart phone for quick access.

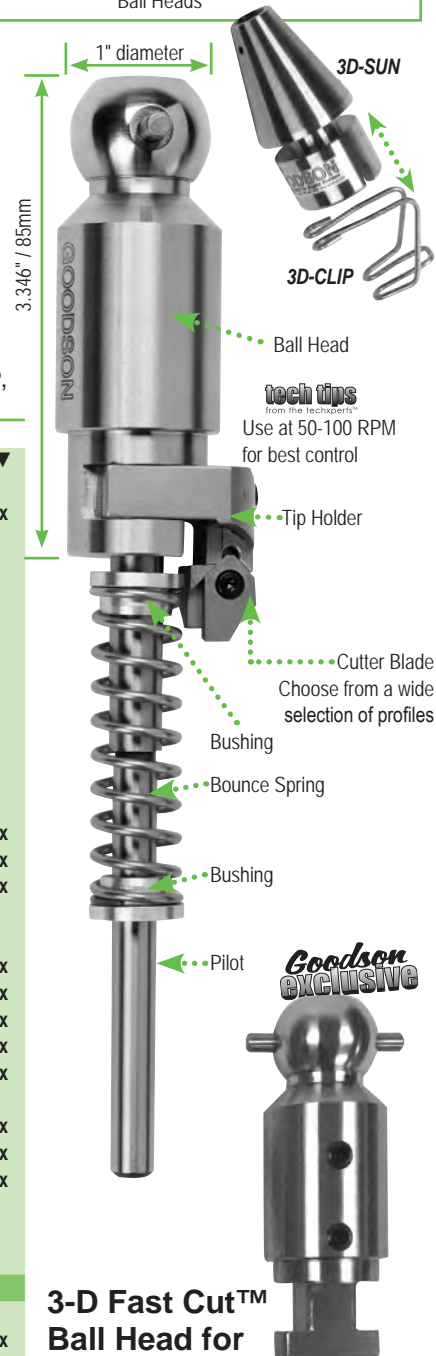

3-D Fast Cut™ Ball Head for Sunnen® Tool Holders

- Fits .375" Top pilots
- Channel measures .500"
- Use with insert holders SGM-1045, SGM-1055, SGM-1090 and SGM-1115
- 3.350" long x 1.162" diameter
- Order No. **3D-BH-SUN375** Jobber \$399.99

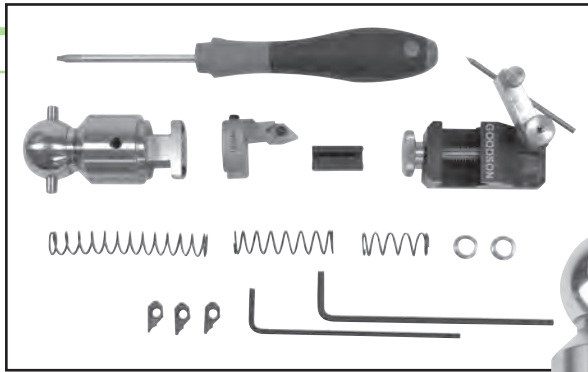

Holders (3DH-1995 & 3DH-1999M) have been modified to provide support to cutters without interfering with the bowl diameter.

Micro Tips FTM-190 and FTM-82R6B-HP only fit Tip Holder 3DH-1995

3-D Fast Cut™ System Micro Ball Head Tooling

- Fits the same 1" ball head driver as the original 3-D Fast Cut tooling
- See page 5 for .236" Top Pilots

Description	Jobber	Order No.	
Micro Ball Head Starter Kit	\$1019.99	3D-236-KIT	▼
3D Ball Head for .236"/6mm Pilot (2.56"L)	287.99	3D-BH236	x
Micro Cutter Tips 45°/1.0mm	66.99	FTM-185	x
See pg. 9 45°/1.0mm	66.99	FTM-187	x
for profiles 39°/1.0mm	66.99	FTM-188	x
90° (For counterboring)	66.99	FTM-190	x
82° Radius Cutter	66.99	FTM-82R6B-HP	x
Tip Holders .550"-.984" Range	249.99	3DH-1999M	x
(incl. FT-SCREW) .551"-.850" Range	269.99	3DH-1995	x
Bounce Springs Short 1.050" / 26.7mm	17.49	3D-BS1	x
.340" ID Medium 1.540" / 39.2 mm	17.49	3D-BS3	x
.420" OD Long 2.550" / 64.8 mm	17.49	3D-BS2	x
Bounce Spring Bushing (1 pair)	29.99	3D-BB1	x
Bounce Spring Spacer 22mm long	42.99	3D-BB2	x
3-D Fast Cut™ Accessories			
Replacement 2.5mm Hex Key	\$1.99	3D-2.5	x
Replacement Side Screw M5x8MM	5.99	3D-58	
Replacement Base Screw M5x5MM	1.99	3D-55	
Cutter Blade Mounting Screw	5.99	FT-SCREW	
Blade Wrench	14.99	FT-WRENCH	x
Tool Setting Fixture	167.99	3D-TSFA	x
Bridgeport / DCM Ball Head Driver	419.99	3D-3/4SS	

More levels on page 48



VGL-100
(use with your pilot or find a pilot on page 3)

Valve Guide Level

- Graduated vials with satin-chromed, brass protective covers that rotate to close tightly
- Base castings are seasoned, then precision machined and finished on a bearing surface • Replaceable vials
- Adjustable for precise calibration
- 1 division equals .0005" per inch
- Fits pilots from 6mm to .437"

Description	Jobber	Order No.	Replacement Vial
4" Valve Guide Level (3" vial)	\$309.99	VGL-100	VGL-101

See www.goodson.com for level calibration instructions



Valve Seat Removal Tooling

- Fits most popular 3-angle cutting tools including our popular 3-D Fast Cut™ System, Kwik-Way, Peterson, Rottler, Serdi, T&S, Winona Van Norman, Newen, etc.
- Use to relieve press fit for easier seat removal
- Requires a minimum of 2 cuts
- For precise set up use the **MGA-MIC** (below)

- Tip Holders include one cutting tip and mounting screw (see chart below) • Replacements sold separately
- Ball Head and Drive Tools sold separately (see page 6)

Description	Replacement Tip	Jobber	Order No.	
Tip Holders	3DB-1999i	\$299.99	3D-1999C	
	3DB-250	289.99	3D-2000C	
	3DB-250	299.99	3D-2001C	
	3DB-250	299.99	3D-2002C	
Wide Body Tip Holders	3DB-250	409.99	3D-2003C	
	3DB-250	409.99	3D-2004C	
Replacement Tip	fits 3DB-1999C	63.99	3DB-1999i	
	fits all BUT 3DB-1999C	63.99	3DB-250	
Replacement Screw	for 3DB-1999i	19.99	3DB-1999S	
	for 3DB-250	17.99	3DS-SCREW	
Cutting Range with Pilot Size				
Holder	.236" Top	.375" Top	.385" Top	.437" Top
3D-1999C	0.960"-1.225"	1.095"-1.360"	1.105"-1.360"	1.157"-1.360"
3D-2000C	1.056"-1.480"	1.194"-1.480"	1.206"-1.480"	1.264"-1.480"
3D-2001C	_____	1.376"-2.000"	1.386"-2.000"	1.450"-2.000"
3D-2002C	_____	1.524"-2.460"	1.544"-2.460"	1.610"-2.460"
3D-2003C	_____	1.680"-2.400"	1.680"-2.400"	_____
3D-2004C	_____	2.280"-3.200"	2.280"-3.200"	_____

.375" Precision Drill Bushing for standard or pilot

MGA-MIC-1S
Precision ground and micro polished stabilized tool steel



MGA-MIC

3-D Fast Cut Setting Micrometer

- Direct reading micrometer accurate to .001"
- Uses tapered .375" Pilot to match your ball head (sold separately)
- Use to set cutting diameter of 90° carbide cutters when modifying counterbores
- Use the optional calibration standard to ensure your micrometer is reading correctly

Description	Cutting Range	Jobber	Order No.
Standard Micrometer	0.800" - 2.800"	\$514.99	MGA-MIC
Calibration Standard		89.99	MGA-MIC-1S

CYLINDER HEAD
REBUILDING

CLEANING,
ASSEMBLY & SAFETY

SHORT BLOCK
REBUILDING

FLYWHEEL GRINDING/
CRANKSHAFT/

TOOLS & SUPPLIES
MISCELLANEOUS

TOOLING
BRAKE SERVICE

MEASURING
TOOLS

V-TWIN & METRIC
HARD PARTS



**SABER TOOTH
SERIES CUTTER BLADES**

**Cutter
Key:**

- I** Intake
- E** Exhaust
- S** Specialty

**High Performance Cutter Blades
Add 10 to 20 CFM to Cylinder Heads**

Designed to increase airflow by as much as 20 CFM, these cutters are intended for certain applications. Generally you should use intake cutters on intakes and exhaust on exhausts, but as with most things, there's always an exception. Experiment to find the right combination for you and your customers.

All Cutters This Page Jobber \$59.99 each



<p>I IFT-30B-HP</p>	<p>I IFT-4560B-HP</p>	<p>I IFT-4539B-HP</p>
<p>E IFT-4524-HD</p>	<p>E IFT-4524A-HD</p>	<p>I IFT-4560-HD</p>
<p>I IFT-4560A-HD</p>	<p>E IFT-4556B-HP</p>	<p>I EFT-5060B-HP</p>
<p>I EFT-5061B-HP</p>	<p>I IFT-5065B-HP</p>	<p>I EFT-5046B-HP</p>
<p>E IFT-5025B-HP</p>	<p>I EFT-5567B-HP</p>	<p>E EFT-5557B-HP</p>
<p>I EFT-5550B-HP</p>	<p>I EFT-5565B-HP</p>	<p>S IFT-1056-HD</p>

<p>S IFT-1556-HD</p>	<p>S IFT-1043-HD</p>	<p>I IFT-45B-HP</p>
-----------------------------	-----------------------------	----------------------------

**SABER TOOTH
SERIES CUTTER BLADES**

Increase Flow & Improve Horsepower

<p>S IFT-86RB-HP</p>	<p>S IFT-82R6B-HP</p>
-----------------------------	------------------------------

Enlarged to show details

<p>IFT-4539B-HP Intake</p>	<p>IFT-75R6B-HP Follow up Intake</p>	<p>IFT-4524-HD Exhaust</p>
---------------------------------------	---	---------------------------------------

<p>S IFT-75R6B-HP</p>	<p>E RBP-RR4</p>
------------------------------	-------------------------

3-Pc. Set High Performance Valve Seat Cutters

- Increase flow & improve horsepower with this set
- Machine your intake seat with IFT-4539B-HP then use cutter IFT-75R6B-HP to machine below the seat and blend into the port
- On exhaust, machine with IFT-4524-HD
- Order No. IFT-HP-SET Jobber \$159.99





SABER TOOTH
SERIES CUTTER BLADES

3-D Radius Profile Seat Cutter Blades

3-D Fast Cut Tool Holder

- Use when sharpening cutter blades to keep the cutter in the correct position
- Order No. **3D-HOLDER**
Jobber \$49.99



Cutter Key:

- I** Intake
- E** Exhaust
- S** Specialty



Diamond Hand Files

- Use for fine touch-up on your Seat Cutter Blades
- Set includes 1-360 grit and 1-600 grit file
- Order No. **DFS-2**
Jobber \$89.99

Custom Cutter Blades Are Easy!



- 1 Download the **Goodson Custom Formtool Profile Form** from our website (scan the code at right with the camera on your smart phone or other smart device) or call to have us send a copy.
- 2 Complete the form, including a drawing of the cutter you need. Be sure to include all angles, radii, seat widths, etc. Missing information will delay your cutter or result in an incorrect profile.
- 3 Send the completed form to Goodson.
Fax: 888-466-3909 or
E-mail: orderdesk@goodson.com. We'll get a blueprint made which you must approve before we start production.

Saber Tooth Alloy Custom Cutters Start at \$149.99

Turn the Page for More Valve Seat Cutter Blades

Cutter Blades This Page
Jobber \$59.99
Micro Cutter Blades
Jobber \$66.99

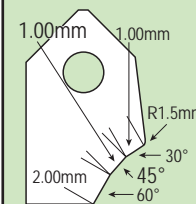

I FT-5043A-HD

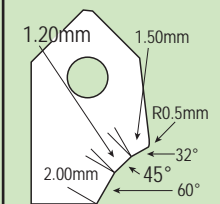

I FT-4247A-HD

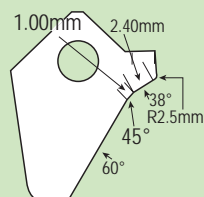

I FT-068B-HP

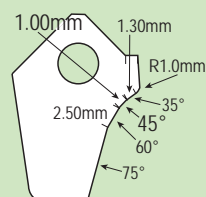

I FT-069B-HP

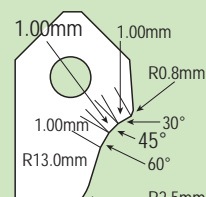

I FT-5118A-HP

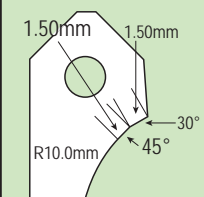

I FT-5119A-HP

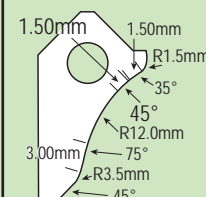

E FT-003B-HP

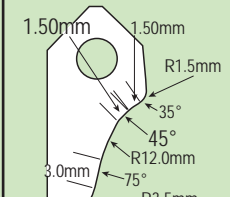

E FT-004B-HP

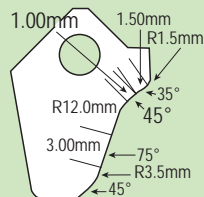

E FT-005B-HP

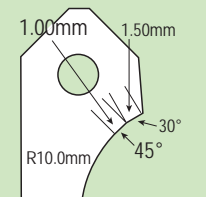

E FT-5120A-HP

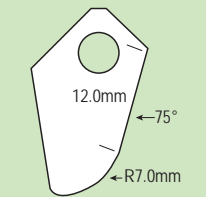

S FT-002B-HP

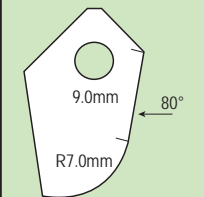

S FT-033B-HP

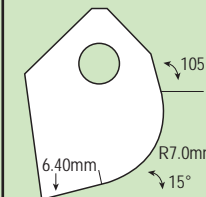

S FT-077B-HP

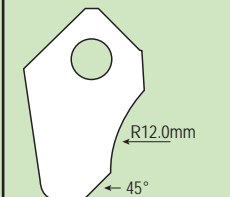

S FT-084B-HP

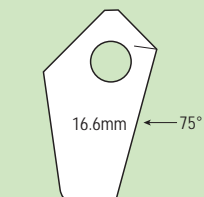

S FT-085B-HP

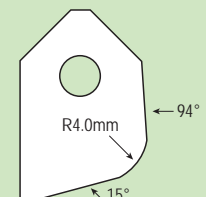

S FT-5121A-HP

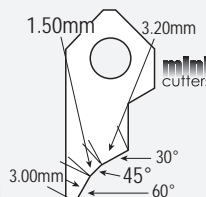

S FT-213B-HP

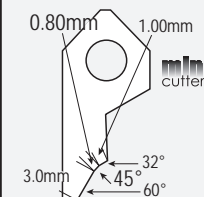

S FT-215B-HP

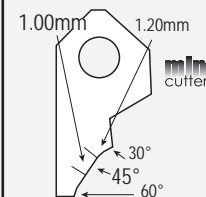

S FT-4028B-HP

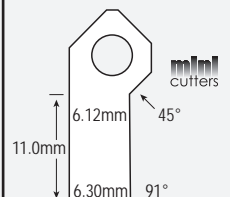

S FT-9020B-HP

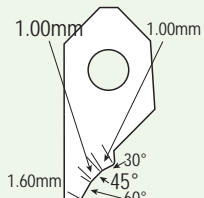

S FTM-185

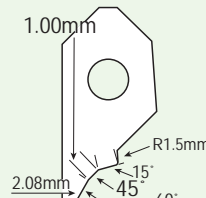

S FTM-187

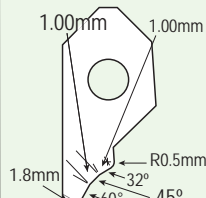

S FTM-188

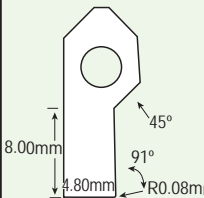

S FTM-190

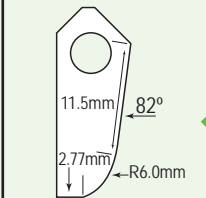

S FTM-82R6B-HP

Micro Blades

Work with holders on pages 7 & 12
Jobber \$66.99 ea.

CYLINDER HEAD REBUILDING
CLEANING, ASSEMBLY & SAFETY
SHORT BLOCK REBUILDING
FLYWHEEL GRINDING
CRANKSHAFT/ MISCELLANEOUS TOOLS & SUPPLIES
BRAKE SERVICE TOOLING
MEASURING TOOLS
V-TWIN & METRIC HARD PARTS



3-D Multi-Angle Seat Cutter Blades

All Valve Seat Cutter Blades This Page Jobber \$49.99 ea.

CYLINDER HEAD REBUILDING

CLEANING, ASSEMBLY & SAFETY

SHORT BLOCK REBUILDING

CRANKSHAFT/ FLYWHEEL GRINDING

MISCELLANEOUS TOOLS & SUPPLIES

BRAKE SERVICE

TOOLING

MEASURING TOOLS

V-TWIN & METRIC HARD PARTS

45° Seat Angle Cutter Blades \$49.99 each

30° Seat Angle Cutter Blades \$49.99 each

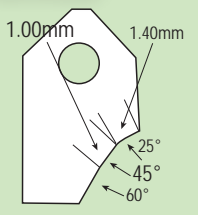

FT-45039U1

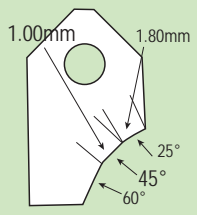

FT-45039U2

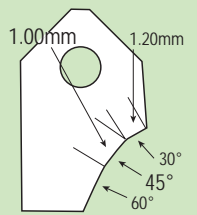

FT-45039V1

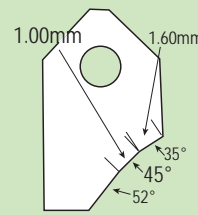

FT-45039W1

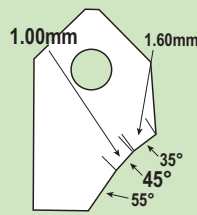

FT-45039W2

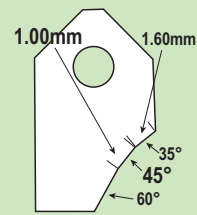

FT-45039W3

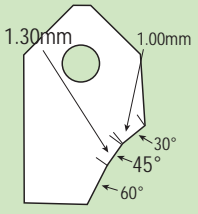

FT-45051V2

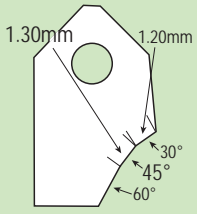

FT-45051V4

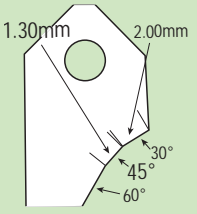

FT-45051V1

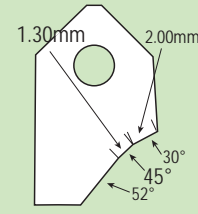

FT-45051V3

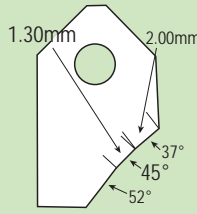

FT-45051X1

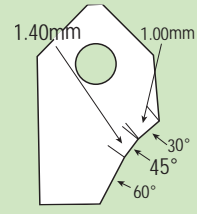

FT-45055V1

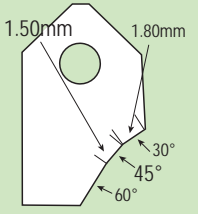

FT-45059V1

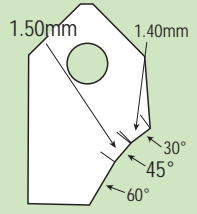

FT-45059V2

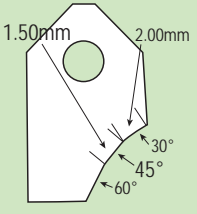

FT-45059V3

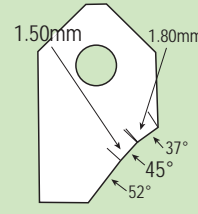

FT-45059X1

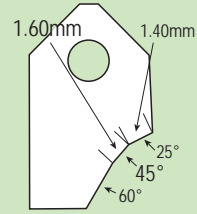

FT-45063U1

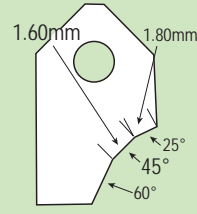

FT-45063U2

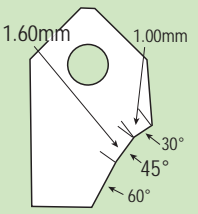

FT-45063V1

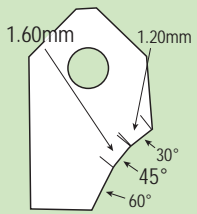

FT-45063V3

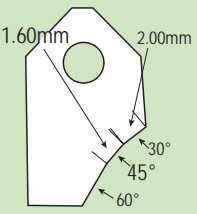

FT-45063V2

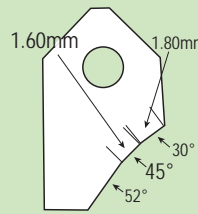

FT-45063W1

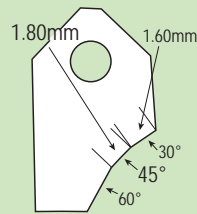

FT-45071V1

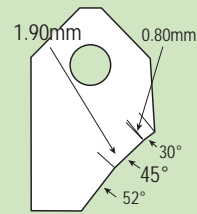

FT-45075V2

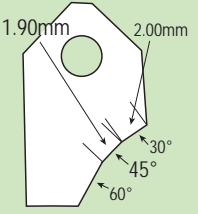

FT-45075V1

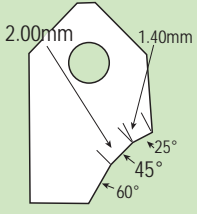

FT-45079U1

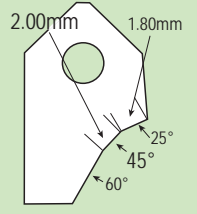

FT-45079U2

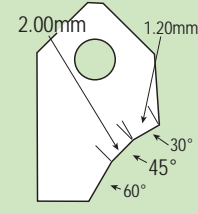

FT-45079V1

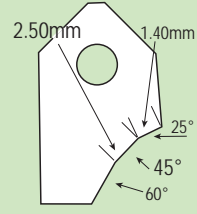

FT-45098U1

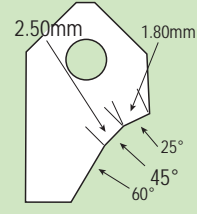

FT-45098U2

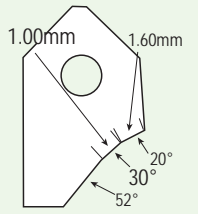

FT-30039T1

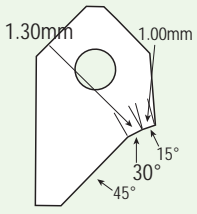

FT-30051S1

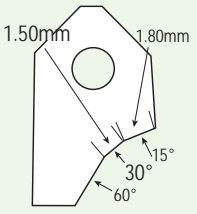

FT-30059S1

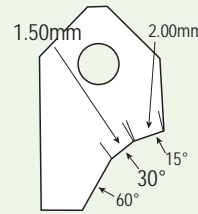

FT-30059S3

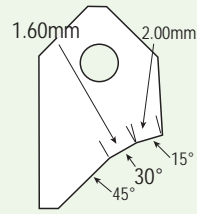

FT-30063S1

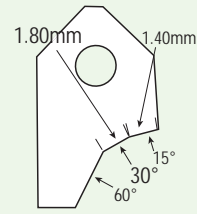

FT-30071S1

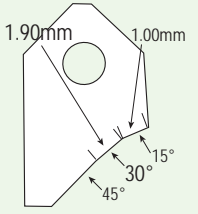

FT-30075S1

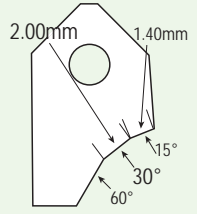

FT-30079S1

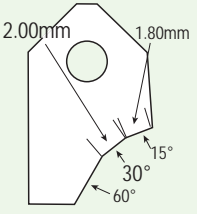

FT-30079S2

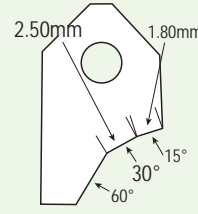

FT-30098S1

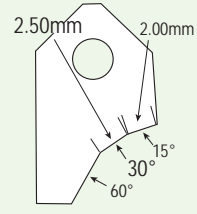

FT-30098S2

resharpening available

Have Goodson Resharpen Your Valve Seat Cutter Blades

Single Angle Valve Seat Cutter Blades Jobber \$49.99 ea.



**SABER TOOTH
SERIES CUTTER BLADES**

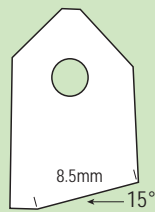

FT-15

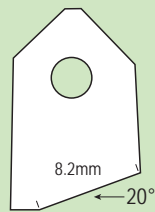

FT-20

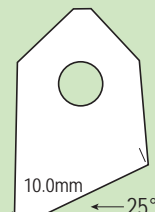

FT-25

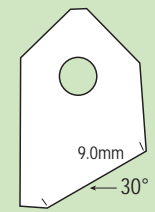

FT-30

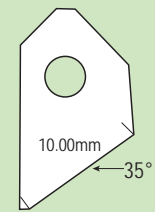

FT-35

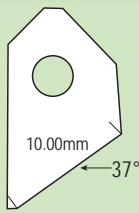

FT-37

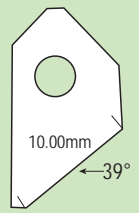

FT-39

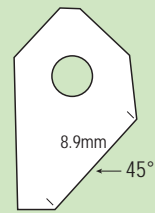

FT-45

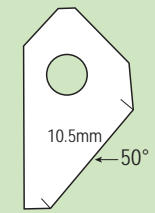

FT-50

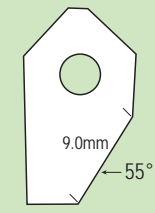

FT-55

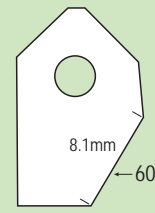

FT-60

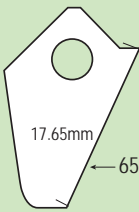

FT-65

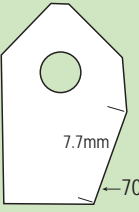

FT-70

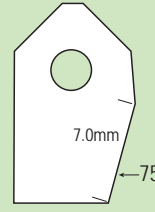

FT-75

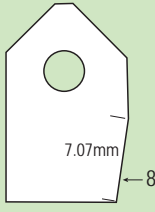

FT-82

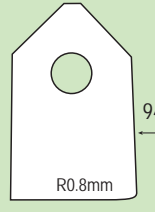

FT-90

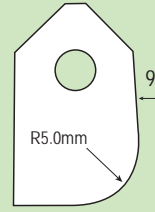

FT-R5

sized for **diesel**
Diesel Blades
Jobber \$59.99

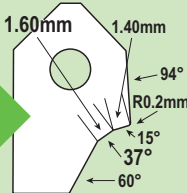

FT-37063S60

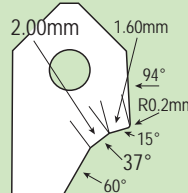

FT-37079S60

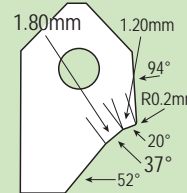

FT-37071S52

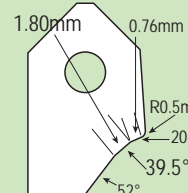

FT-39570T1

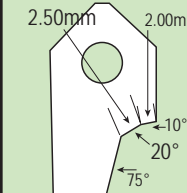

FT-20098S1

CYLINDER HEAD
REBUILDING

CLEANING,
ASSEMBLY & SAFETY

SHORT BLOCK
REBUILDING

CRANKSHAFT/
FLYWHEEL GRINDING

MISCELLANEOUS
TOOLS & SUPPLIES

BRAKE SERVICE
TOOLING

MEASURING
TOOLS

V-TWIN & METRIC
HARD PARTS

- Increase Low Lift Air Flow
- Increase Torque
- Increase Horsepower

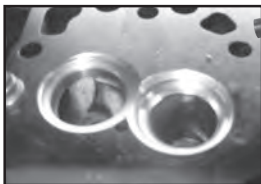

Diesel Relief Tooling

- Use with your seat and guide machine or Bridgeport Mill equipped with a multi-angle seat cutting system
- Developed for Goodson by Joe Mondello Racing Engines
- Use for 6.0L & 7.3L Ford, 12 Valve, 5.9L Cummins & 6.6L Duramax diesel engines
- For 2-Valve & 4-Valve heads • Complete kit includes the Mounting Fixture, .375" Top Offset Pilot, Indexing Pin & Radius Cutter
- This tool is only for use with radius cutters BSS-20CC and BSS-45CC

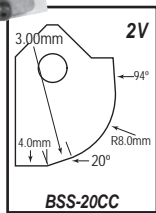

BSS-20CC

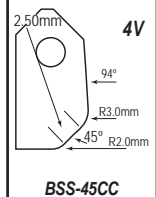

BSS-45CC

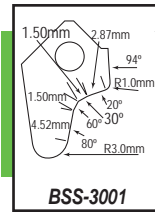

BSS-3001

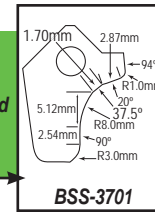

BSS-3701

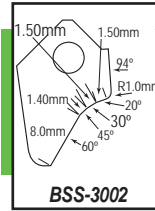

BSS-3002

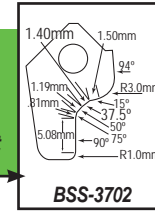

BSS-3702

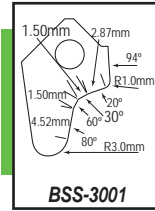

BSS-3001

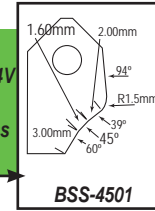

BSS-4501

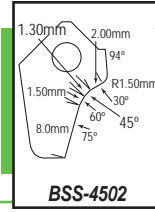

BSS-4502

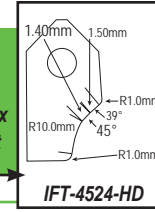

IFT-4524-HD

black smoke
series cutters
for High Performance Diesel Engines

Developed for Goodson by Joe Mondello Racing Engines. These cutters are designed to be used with your 3-D Fast Cut or other multi-angle tooling. Jobber \$59.99 ea.



See How to Use the Diesel Relief Tooling on YouTube! Search for Diesel Valve Relief Tool.

Description	Jobber	Order No.	Incl.
7mm Diesel Relief Tool Kit	\$194.99	DVRT-7MM-KIT	▼
8mm Diesel Relief Tool Kit	194.99	DVRT-8MM-KIT	▼
20CC Radius Cutter for 2-Valve Heads	59.99	BSS-20CC	x
45CC Radius Cutter for 4-Valve Heads	59.99	BSS-45CC	x

... another satisfied customer

"I appreciate what you guys do and I appreciate you being of service to me for over 30 years. Thanks for all the great products. Looking forward to many more years."
 - Anthony Milano, A N M Auto Machine, Paris, OH, Goodson customer since 1992

CYLINDER HEAD REBUILDING

CLEANING, ASSEMBLY & SAFETY

SHORT BLOCK REBUILDING

CRANKSHAFT/ FLYWHEEL GRINDING

MISCELLANEOUS TOOLS & SUPPLIES

BRAKE SERVICE TOOLING

MEASURING TOOLS

V-TWIN & METRIC HARD PARTS

3-D FAST CUT™ SYSTEM

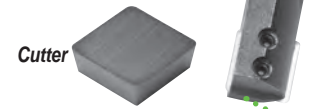

3-D Fast Cut Adjustable Spring Pad Cutters

- No need to change tooling, just change the tool holder and start cutting spring pads
- Works with all popular 3-angle cutting systems
- Square blades are indexable and replaceable
- Tool holder includes one blade



Tool Holders			
Blade Size	Application	Jobber	Order No.
3/8" / 9.53mm	All except Sunnen®	\$244.99	SPC-375
1/2" / 12.70mm	All except Sunnen®	264.99	SPC-500
Replacement Carbide Cutters (for all holder styles above)			
3/8" / 9.53mm		\$24.99	SPCI-375
1/2" / 12.70mm		26.99	SPCI-500
Accessories			
Lift Clip for Enhanced Control		\$25.99	3D-CLIP

Valve Spring Seat Cutters on Page 46



Minnesota Fast Freeze

- Instantly chills seats & guides to -50°F (-45.5°C)
- Creates interference fit with heated aluminum heads
- Finish seat and guide work faster than ever
- Aerosol*
- Use on tight bushings, pins, shafts, etc.
- 10 oz. can

Description	Jobber 1+	Jobber 6+	Order No.
Minnesota Fast Freeze	\$49.99	\$44.99	MFF-8

Order 6 or more to Save 10% off Jobber

*Hazardous Goods Fees Apply When Shipped by Air

Press Fit Lubricants

- A light coat eases press fit
- Ideal for valve guides, piston pins, cylinder sleeves, etc.
- Eliminates the scoring, gouging and galling of parts during press fitting

Description	Jobber 1+	Jobber 6+	Order No.
Goodson Aerosol 6 oz. (170 g)	\$14.99	\$13.49	PFL-200*
Sunnen® Aerosol 7 oz. (198 g)	27.09		B-200*
Sunnen® Brush Applicator 200 mL	36.86		B-200L*

*Hazardous Goods Fees Apply When Shipped By Air
 Save 10% by buying 6 or more cans of PFL-200

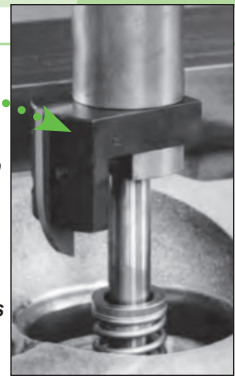

3-D Fast Cut™ Bowl Profiler

- Machine seats & bowls on a pair of V8 heads in about 40 minutes
- Remove material to contour cylinder head bowl areas and unshroud valves in combustion chambers
- Will not work with Sunnen® Ball Heads

Holder Diameter Range	Jobber	Order No.
1.25"-1.87" / 32-48mm	\$217.99	NBN-1
1.57"-2.13" / 40-54mm	217.99	NBN-2

Blades sold separately

NBN-5	NBN-6	NBN-12	NBN-14	NBN-15
\$114.99	\$114.99	\$154.99	\$154.99	\$154.99

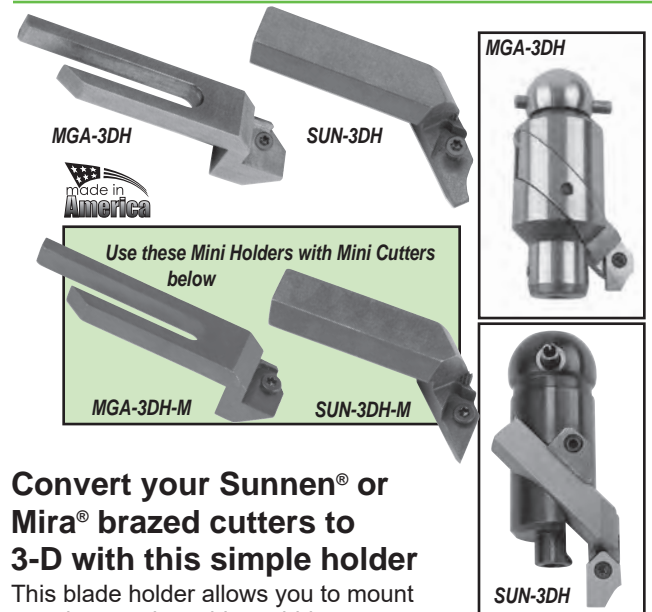

Convert your Sunnen® or Mira® brazed cutters to 3-D with this simple holder

This blade holder allows you to mount premium, replaceable carbide cutters on your existing MIRA® and Sunnen® ball-type tool holders. Choose from our wide selection of replaceable cutters, previously only available for 3-D Fast Cut™ or similar seat cutting systems.

Description	Jobber	Order No.
Standard Cutter	\$199.99	MGA-3DH
Holders	204.99	SUN-3DH
Mini Cutter	199.99	MGA-3DH-M
Holders	204.99	SUN-3DH-M
Mini Cutters	59.99	FT-213B-HP
	59.99	FT-215B-HP
view profiles	59.99	FT-4028B-HP
on page 9	59.99	FT-9020B-HP
Replacement Screw	5.99	FT-SCREW

Valve Seat Work

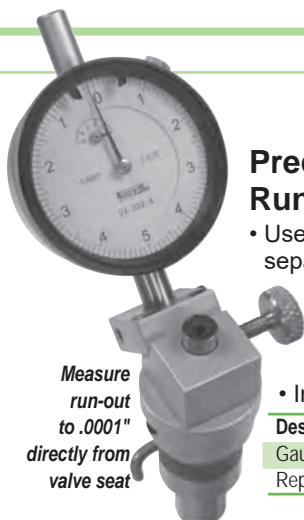

Measure run-out to .0001" directly from valve seat

Precision Valve Seat Run-Out Gauge

- Use with your .375" Top Pilot (sold separately) • Measure run-out to .0001" directly from the seat • Locked to the pilot • Dial indicator remains stationary while rotating contact pointer • .800" - 2.500" dia. range • Includes 2" dia. dial indicator

Description	Jobber	Order No.
Gauge Assembly	\$749.99	SCG-375
Replacement Indicator	179.99	SCG-IND

Easy-To-Read Gauge



Premium Valve Seat Run-Out Gauges



- Hardened guide bushings & contact pilot
- Quick thumb screw set-up
- Jeweled bearing indicator reads to $\pm .050"$ with .001" precision
- Range: 1.00"-2.50"
- Measures concentricity

Pilot Size	OAL	Jobber	Order No.
.375"	5"	\$274.99	VSG-375
.385"	5"	274.99	VSG-385
Replacement Indicator		84.99	VSG-IND



Valve Seat Machining Aid

- Machine valve seats to a mirror-like finish
- Universal - works with any type of cylinder head machining center
- Use full strength
- Safe for metal surfaces
- Works with mineral-based cutting oils, not water based
- Quart (946mL)
- Order No. **PF-2020** Jobber \$43.99



Valve Seat Scribe Tool

- Tool body fits over .375" Top pilot
- Use valve to set point then scribe seat with inner and outer radii
- We recommend using Layout Fluid so you can see the scribe mark more clearly
- Grind seat top and throat to match face precisely
- Replaces ST-30-BD Scribe Tool
- Order No. **SST-375** Jobber \$39.99

Layout Fluids

- Choose from blue and red
- Toluene-free • Dries in minutes
- Provides a thin film without cracking or chipping • Prevents glare with a uniform, deep color
- 2 oz. markers feature felt tip applicator
- 4 oz. containers includes brush in cap



Description	Color	Jobber	Order No.
2 oz. Layout Fluid Markers	Blue	\$14.99	VBF-2
	Red	14.99	VRF-2
4 oz. Layout Fluid	Blue	15.99	VBF-4
	Red	15.99	VRF-4

Cutting & Tapping Fluid

- Cut through even the hardest metals
- Spray clings to the surface of the tool to prolong tool life
- Ideal for stainless steel, high nickel alloys, titanium and more
- Use for reaming, seat cutting and CBN cutting
- Aerosol*
- Order No. **CTF-14*** Jobber 1+ \$14.99 ea., Jobber 6+ \$13.49 ea.

*Hazardous Goods Fees Apply When Shipped by Air
Order 6 or more CTF-14, save 10% off jobber



Spray Bluing Fluid

- Fast drying • Will not rub off
- Good adhesion to all metals and glass
- Non-corrosive • Resists heat
- No flaking or peeling
- Scribes clean lines for precision work
- Eliminates rags, daubers, spilled bottles
- Dries to a smooth level coating
- Aerosol*
- Order No. **SBF-16*** Jobber 1+ \$12.49 ea. Jobber 6+ \$11.24 ea.



*Hazardous Goods Fees Apply When Shipped by Air



Prussian Blue Oil Based Paste

- Aids precision fitting of machined surfaces
- Locates high spots on bearings, valves, gears and other close-tolerance components
- Non-drying, easy clean-up
- Coat parts with a uniform film of Prussian Blue; assemble in working position and turn shaft; improper fit will show up as easy-to-see bright blue streaks
- 0.75 fl. oz. tube
- Order No. **PB-75** Jobber \$12.59

CYLINDER HEAD
REBUILDING

CLEANING,
ASSEMBLY & SAFETY

SHORT BLOCK
REBUILDING

CRANKSHAFT/
FLYWHEEL GRINDING

MISCELLANEOUS
TOOLS & SUPPLIES

BRAKE SERVICE
TOOLING

MEASURING
TOOLS

V-TWIN & METRIC
HARD PARTS

Counterboring Tools

GOODSON Counterbore Cutters CUT TRUE TO SIZE!

Other cutters may cut as much as .005" smaller

tech tips

from the techxperts™

Goodson recommends using
Indexable Counterbore Cutters
at 40 to 60 RPM.



Indexable Counterbore Cutters

These indexable counterbore cutters eliminate down time from having brazed cutters reset or sharpened. You can service them right in your own shop! Each cutter body includes 2 carbide cutter tips with 4 cutting edges. When one edge wears, simply rotate the tip to a new cutting edge. You'll also get a wrench with every cutter body.



DWI-SERIES

- Fits DCM Tech, Sunnen, and Winona Van Norman
- $\frac{9}{16}$ " / 14.3mm arbor



Counterbore Cutter Drive Adaptors

Cutter Drivers	Jobber	Order No.
#3 MT Driver	\$469.99	CD-MT3
Fits .750" Bridgeport Collet		
$\frac{9}{16}$ " arbor, .375" pilot	\$185.99	DCW-60-375
$\frac{9}{16}$ " arbor, .385" pilot	185.99	DCW-60-385

Size	mm	Repl. Insert	Jobber	Order No.
1.062"	26.97	SCI-250-B	\$283.99	DWI-1062
1.125"	28.57	SCI-250-B	283.99	DWI-1125
1.187"	30.15	SCI-250-B	283.99	DWI-1187
1.250"	31.75	SCI-250-B	283.99	DWI-1250
1.312"	33.32	SCI-250-B	283.99	DWI-1312
1.375"	34.93	SCI-250-B	283.99	DWI-1375
1.437"	36.50	SCI-250-B	283.99	DWI-1437
$\frac{1}{4}$ " Replacement Cutting Insert			47.99	SCI-250-B
Replacement Screw for SCI-250-B			8.99	SCS-T7
Allen Wrench for SCS-T7			10.49	SCW-T7

Size	mm	Repl. Insert	Jobber	Order No.
1.500"	38.10	SCI-375-B	\$283.99	DWI-1500
1.562"	39.67	SCI-375-B	283.99	DWI-1562
1.625"	41.28	SCI-375-B	283.99	DWI-1625
1.687"	42.85	SCI-375-B	283.99	DWI-1687
1.750"	42.85	SCI-375-B	283.99	DWI-1750
1.812"	44.45	SCI-375-B	283.99	DWI-1812
1.875"	47.63	SCI-375-B	283.99	DWI-1875
1.937"	49.20	SCI-375-B	283.99	DWI-1937
2.000"	50.80	SCI-375-B	283.99	DWI-2000
2.062"	52.37	SCI-375-B	283.99	DWI-2062
2.125"	53.98	SCI-375-B	283.99	DWI-2125
$\frac{3}{8}$ " Replacement Cutting Insert			69.99	SCI-375-B
Replacement Screw for SCI-375-B			2.19	SCS-T15
Torx Wrench for SCS-T15			6.99	SCW-T15



SABER TOOTH Cutter Inserts

1.25" Precision Ground
Setting Standard

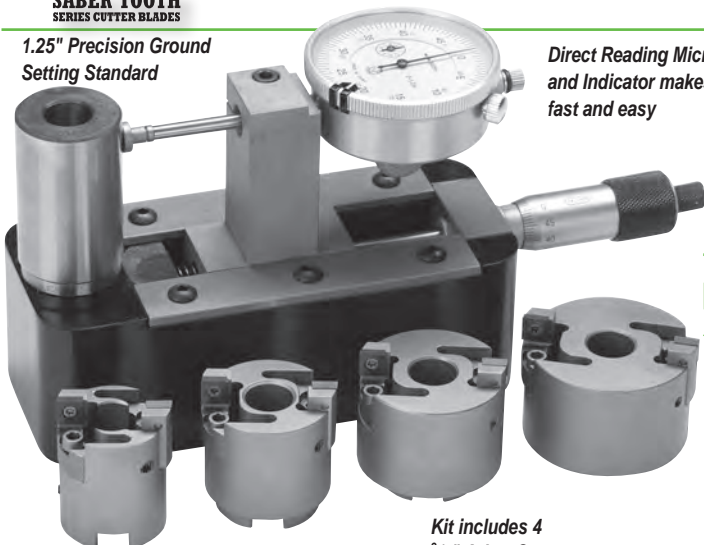

Direct Reading Micrometer
and Indicator makes setting
fast and easy

Kit includes 4
 $\frac{9}{16}$ " Arbor Cutters

GOODSON Adjustable Counterbore Cutter Kit

- Cutter assemblies feature positive stop adjusting screws to prevent cutters from changing dimensions when in use
- Direct reading micrometer and dial indicator for fast, accurate set-up • 7 cutter assemblies to choose from, covering a range from 1.25" to 2.75" diameter
- Kit substitutions are available, call to inquire
- Heavy duty billet steel construction

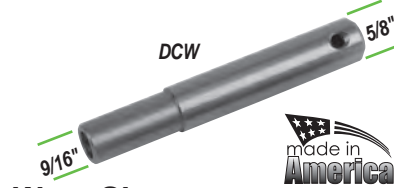

Wear Sleeves for DWA & DWI Counter Bore Cutters

- Wear sleeves fit CD-MT3 Driver

Pilot Top Size	Jobber	Order No.
.375" (9.53mm)	\$91.99	DCW-375
.385" (9.78mm)	91.99	DCW-385



SABER TOOTH
SERIES CUTTER BLADES



Scan with your smart
phone or other device
to view



Description	Jobber	Order No.	Incl.
Complete Kit ($\frac{9}{16}$ " / 14.3mm Arbor)	\$2199.99	DWA-300	
Cutter Assemblies (in/mm) complete with cutting inserts installed			
$\frac{9}{16}$ " Arbor	1.250"-1.375" / 31.8-34.9	\$569.99	DWA-250 x
	1.375"-1.500" / 34.9-38.1	569.99	DWA-375 x
	1.500"-1.750" / 38.1-44.5	569.99	DWA-302 x
	1.750"-2.000" / 44.5-50.8	569.99	DWA-303 x
	2.000"-2.250" / 50.8-57.2	569.99	DWA-304
	2.250"-2.500" / 57.2-63.5	569.99	DWA-305
	2.500"-2.750" / 63.5-69.9	569.99	DWA-306
Replacement Cutting Insert	61.99	DKB-7	
Replacement Insert Screw	18.99	DKS-7	
Wrench	14.99	FT-WRENCH	x
Hex Keys	$\frac{5}{32}$ "	1.99	DWA-5/32 x
	$\frac{5}{64}$ "	1.99	DWA-5/64 x
	$\frac{9}{64}$ "	1.99	DWA-5/32 x
Wear Sleeves (see note below)			
	For .375" Top Pilot	\$91.99	DCW-375
	For .385" Top Pilot	91.99	DCW-385

To use the Counterbore Cutter Kit with Kwik-Way & Peterson Machines you will need to adapt the $\frac{9}{16}$ " cutter to fit the $\frac{5}{8}$ " drive. Use a DCW wear sleeve.

CYLINDER HEAD
REBUILDING

CLEANING,
ASSEMBLY & SAFETY

SHORT BLOCK
REBUILDING

FLYWHEEL GRINDING

CRANKSHAFT/
TOOLS & SUPPLIES

MISCELLANEOUS
TOOLING

BRASS SERVICE
TOOLING

MEASURING
HARD PARTS

full service
...fast



"At Goodson, we're trained to know your business. Regular training sessions are held for our entire staff to help us better understand your work so we can provide you with the best possible service."

- Anne, Goodson Accounting - 20 years of service

CYLINDER HEAD
REBUILDING

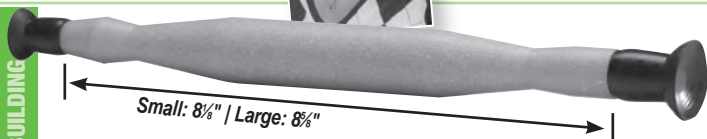

Traditional Valve Lapping Sticks

- Oil resistant polyethylene handles
- Locking tabs eliminate cup slippage

Description	Cup ID	Jobber	Order No.
Small Lapping Stick 8 1/2" Long		\$9.99	VLS-15
Replacement Cups	15.9mm / 0.625" dia.	.156"	6.99 VLS-5/8
	20.6mm / 0.813" dia.	.230"	7.99 VLS-13/16
Large Lapping Stick 8 3/4" Long		10.99	VLS-30
Replacement Cups	28.6mm / 1.125" dia.	.380"	6.99 VLS-1 1/8
	34.9mm / 1.375" dia.	.380"	7.99 VLS-1 3/8

CLEANING,
ASSEMBLY & SAFETY

LOCK
REBUILDING

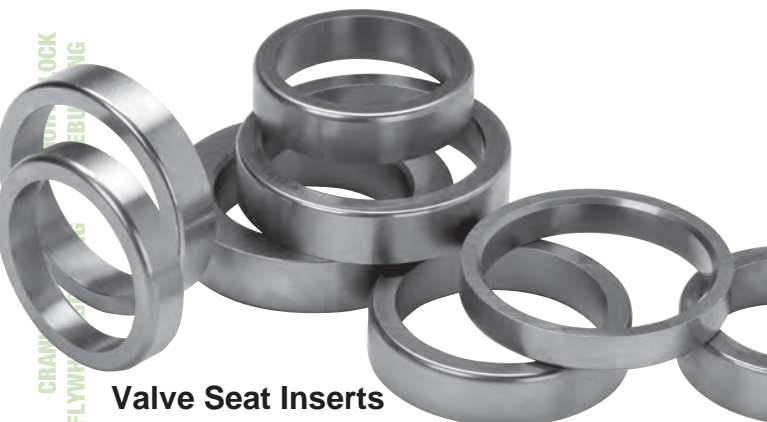

Valve Seat Inserts

- For Harley-Davidson®
- Easy to machine
- Effectively dissipate heat for consistent valve sealing
- Hardness increases during engine break-in
- Radiused for easy installation



Replacement Valve Seats For Shovel Head 1200 & 1340

Application	OD	ID	Thick	MSRP	Jobber	Order No.	Supersedes
Exhaust	1.944"	1.575"	.400"	\$14.47	\$10.29	10-HC493	HVS-1944
Intake	2.135"	1.750"	.400"	14.47	10.29	10-HC542	HVS-2135

Oversize Seats For Shovel, Evolution, Twin Cam & M8 - machining required

Fits M8	OD	ID	Thick	MSRP	Jobber	Order No.	Supersedes
	1.630"	1.180"	.385"	\$14.47	\$10.29	10-HC414	HVS-1630
	1.757"	1.410"	.430"	14.47	10.29	10-HC447	HVS-1757
	1.882"	1.520"	.410"	14.47	10.29	10-HC478	HVS-1882
	2.008"	1.610"	.440"	14.47	10.29	10-HC510	HVS-2008
	2.040"	1.700"	.425"	14.47	10.29	10-HC518	HVS-2040
	2.070"	1.610"	.460"	14.47	10.29	10-HC526	HVS-2070
	2.132"	1.800"	.460"	14.47	10.29	10-HC541	HVS-2132
	2.163"	1.750"	.455"	14.47	10.29	10-HC549	HVS-2163

For Iron Head Sportster

Application	OD	ID	Thick	MSRP	Jobber	Order No.	Supersedes
Exhaust	1.757"	1.371"	.315"	\$14.47	\$10.29	10-HC446	HVS-1757S
Intake	2.068"	1.750"	.315"	14.47	10.29	10-HC525	HVS-2068

Universal Repair Seat

	OD	ID	Thick	MSRP	Jobber	Order No.	Supersedes
Powdered	1.339"	1.024"	.375"	\$ 8.98	\$ 10.29	10-SC340	MVS-42
Metal	1.693"	1.299"	.434"	10.55	10.29	10-SC430	MVS-58
	1.819"	1.375"	.450"	14.47	10.29	10-HC462	HVS-1820
	1.945"	1.500"	.450"	14.47	10.29	10-HC494	HVS-1945
	2.257"	1.870"	.450"	14.47	10.29	10-HC573	HVS-2257

BRAKE SERVICE
TOOLING

MEASURING
TOOLS

V-TWIN & METRIC
HARD PARTS

tech tips When installing seats preheat head to 400° and freeze the seat for from the techxperts™ easier installation. Press fit .006" to .008".

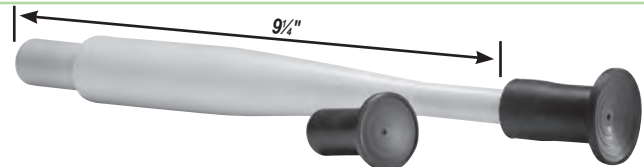

Vacuum Style Lapping Stick

- Press the spring-loaded vacuum pump for a firm hold - stays on until you release the vacuum
- Includes 3 cup sizes (also sold separately)

Description	Cup ID	Jobber	Order No.
Vacuum Lapping Stick 9 1/2" Long		\$39.99	VLV-50
Replacement Cups	19.1mm / 0.750" dia.	.415"	9.79 VLV-3/4
	25.4mm / 1.000" dia.	.415"	9.79 VLV-1
	31.8mm / 1.250" dia.	.415"	10.99 VLV-1 1/4

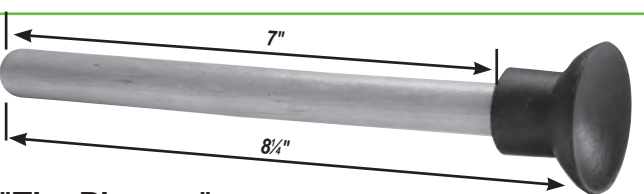

"The Plunger" Hand Valve Lapping Stick

- Large diameter for sure grip
- For 2" and larger valves



Description	Cup ID	Jobber	Order No.
Hand Valve Lapping Stick 8 1/2" Long		\$13.99	VLS-75
Replacement Cup 44.5mm / 1.750" dia.	.313"	7.99	VLS-1 3/4

Buy 12 or more (any combo),
Save 10% off Jobber



Nickel-Chrome Valve Seats



WARNING: This product can expose you to chemicals, including Nickel which are known to the state of California to cause cancer

OD	ID	Depth	Order No.	OD	ID	Depth	Order No.
1.250"	0.812"	1/4"	VS-1250	1.625"	1.375"	3/32"	VS-1625A
1.312"	1.000"	1/4"	VS-1312	1.687"	1.375"	1/4"	VS-1687
1.375"	1.062"	1/4"	VS-1375	1.750"	1.500"	1/4"	VS-1750
1.437"	1.125"	1/4"	VS-1437	1.812"	1.500"	1/4"	VS-1812
1.500"	1.187"	1/4"	VS-1500	1.875"	1.562"	1/4"	VS-1875
1.562"	1.250"	1/4"	VS-1562	1.937"	1.625"	1/4"	VS-1937
1.562"	1.312"	3/32"	VS-1562A	2.000"	1.625"	1/4"	VS-2000
1.625"	1.312"	1/4"	VS-1625	Jobber 1+ each			\$10.49
			Jobber 1+ each				\$10.49
			Jobber 12+ each				9.44

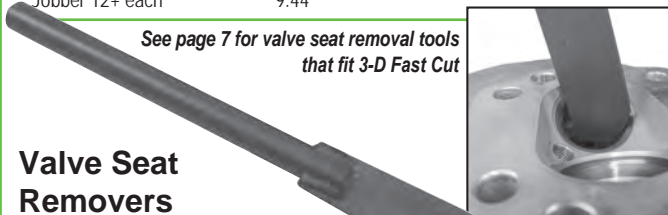

See page 7 for valve seat removal tools that fit 3-D Fast Cut

Valve Seat Removers

- Use to pry out valve seat inserts or stubborn grease seals
- Choose from 90°, 100° and 120°, or buy the set
- **Not** recommended for use on aluminum heads
- Set includes one of each angle
- 13 7/8" overall length



Description	Jobber	Order No.
3-Pc. Set	\$139.99	VSP-SET ▼
90°	52.99	VSP-90 x
100°	52.99	VSP-100 x
120°	52.99	VSP-120 x



Petroleum Based Valve Lapping Compound

- Silicon-carbide, grease-based compound
- Petroleum based valve lapping compound facilitates precise mating between valve seats and valves
- Use with any powered or manual valve lapping tools • The higher the number the finer the grit

Size	Grit	Jobber	Order No.
2 oz. / 56.7g	400 Grit	\$16.99	VLC-2-400
	600 Grit	20.99	VLC-2-600
	800 Grit	20.99	VLC-2-800
	1200 Grit	22.99	VLC-2-1200
2 oz. / 56.7g ea. Combo	120 Grit & 280 Grit	43.99	VLC-4
	120 Grit	85.99	VLC-120
1 lb. / 453.6g	180 Grit	77.99	VLC-180
	280 Grit	81.99	VLC-280



VSD-HD

Valve Seat Drivers For Fast Seat Installation

- Pneumatic Drivers install seats faster, easier and without galling • Driver Head ID is .75" / 19.05mm

Description	Jobber	Order No.
Manual Drivers		
.375" / 9.53mm & .385" / 9.78mm ID	\$42.99	VSD-202-G
Driver Heads (Blackened for Rust Resistance)		
1.000" to 1.125" Seats / 25.4 - 28.6mm	\$37.99	VSD-203-G
1.250" to 1.375" Seats / 31.8 - 34.9mm	37.99	VSD-204-G
1.500" to 1.625" Seats / 38.1 - 41.3mm	37.99	VSD-205-G
1.750" to 1.875" Seats / 44.5 - 47.6mm	37.99	VSD-206-G
2.000" to 2.125" Seats / 50.8 - 54.0mm	37.99	VSD-207-G
Driver Heads (Not Blackened)		
1.750" to 2.000" Seats / 44.5 - 50.8mm	\$37.99	VSD-HD
Pneumatic Drivers		
.375" / 9.53mm & .385" / 9.78mm ID	\$38.99	PSD-385
.437" / 11.10mm ID	38.99	PSD-437

Watch an overview of Valve Lapping Tools including live demonstrations in our Tech Lab Tuesday Video Library. Scan the code below with your smart phone or other device for instant access.



Air Powered Valve Lapping Tool

- Operates on 90psi
- Includes air tool and 3 replacement cups • Air actuated ... no electricity needed • Cups also sold separately
- Air supply pressure: 89 psi
- Sound pressure: 77dB
- Sound power: 88 dB
- Hand/arm weighted vibration: 5.43 m/s²
- Use a light touch when operating - no pressure required!



Replacement Cups Also Available

Description	Cup ID	Jobber	Order No.
Air Powered Valve Lapping Tool		\$469.99	AVLP-300
Replacement Cups	21mm / 0.827" dia.	.230"	11.99 AVLP-301
	33mm / 1.299" dia.	.380"	12.49 AVLP-302
	38mm / 1.496" dia.	.380"	12.99 AVLP-303

Powered Lapping Tool

- Change rotary action into an effective oscillating motion
- Drive with a power drill
- Makes lapping faster and easier
- Includes 2 cup sizes



Description	Cup ID	Jobber	Order No.
Complete Tool		\$299.99	VLP-100
Replacement Cups	22.2mm / 0.875" dia.	.460"	16.49 VLP-10
	25.4mm / 1.000" dia.	.460"	16.49 VLP-20



Minnesota Fast Freeze



- Instantly chills seats & guides to -50°F (-45.5°C) • Creates interference fit with heated aluminum heads • Finish seat and guide work faster than ever • 10 oz. Aerosol*
- Use on tight bushings, pins, shafts, etc.
- Order No. **MFF-8***
- Jobber 1+ \$49.99 ea., Jobber 6+ \$44.99 ea.

Order 6 or more to Save 10% off Jobber

*Hazardous Goods Fees Apply When Shipped by Air

CYLINDER HEAD REBUILDING
CLEANING, ASSEMBLY & SAFETY
SHORT BLOCK REBUILDING
CRANKSHAFT/ FLYWHEEL GRINDING
MISCELLANEOUS TOOLS & SUPPLIES
BRAKE SERVICE TOOLING
MEASURING TOOLS
V-TWIN & METRIC HARD PARTS

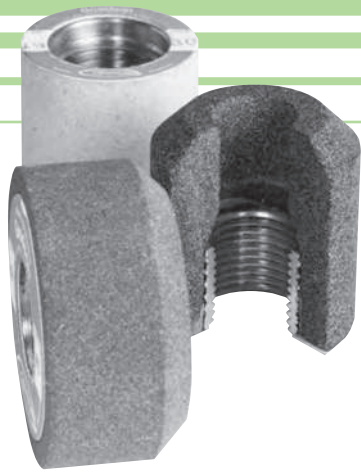

Goodson seat wheels are built to grind accurately & outlast the competition

- Brass bushings resist galling or seizing to the holder
- Heat-cured, permanent epoxy bonding prevents loose bushings
- Bushings are set deep to expose the most abrasive for long life
- Each wheel is trued and checked to assure accurate, vibration-free grinding
- **Custom sizes and angles are available in-house – Call for more information**

**GP**

General Purpose
Removes material from cast-iron seats or inserts.

**CB**

Cool Blue
Pure Aluminum-Oxide stone. Superior general purpose stone for high performance Beryllium seats. Very sharp.

**S**

Stellite
Specially formulated to grind Stellite and other types of hardened seat.

**F**

Finish
Final polishing stone gives an ideal final finish with minimal stock removal. Removes chatter marks.

**NC**

Nickel Chrome
For aluminum heads with chrom-alloy seat inserts. Soft abrasive stone to grind hard seats. Speckled.

**R**

Ruby
The original Black & Decker composition, general purpose stone.



Order 10 or more Valve Seat Wheels
(any combination, pages 18 & 20) and **SAVE 10% off jobber**

Colors may vary due to manufacturing processes

KW

Fits Kwik-Way 13/16"x13 thread

Size			General Purpose (GP) 90 Grit			Cool Blue (CB) 80 Grit			Stellite (S) 90 Grit		
Inch	mm	Jobber	00°	30°	45°	Jobber	00°	45°	Jobber	00°	45°
1/4"	32	\$16.99	KW-1000-GP	KW-1030-GP	KW-1045-GP	\$14.99	KW-1000-CB	KW-1045-CB	\$14.99	KW-1000-S	KW-1045-S
1/8"	33	16.99	KW-1000A-GP	—————	KW-1045A-GP	14.99	KW-1000A-CB	KW-1045A-CB	—————	—————	—————
1/8"	35	16.99	KW-1100-GP	KW-1130-GP	KW-1145-GP	14.99	KW-1100-CB	KW-1145-CB	14.99	KW-1100-S	KW-1145-S
1/8"	36	16.99	KW-1100A-GP	—————	KW-1145A-GP	14.99	KW-1100A-CB	KW-1145A-CB	14.99	KW-1100A-S	KW-1145A-S
1/2"	38	18.99	KW-1200-GP	KW-1230-GP	KW-1245-GP	14.99	KW-1200-CB	KW-1245-CB	18.99	KW-1200-S	KW-1245-S
1/8"	39	18.99	KW-1200A-GP	—————	KW-1245A-GP	14.99	—————	KW-1245A-CB	18.99	KW-1200A-S	KW-1245A-S
1/8"	41	18.99	KW-1300-GP	KW-1330-GP	KW-1345-GP	14.99	KW-1300-CB	KW-1345-CB	18.99	KW-1300-S	KW-1345-S
1 1/16"	43	18.99	KW-1300A-GP	—————	KW-1345A-GP	14.99	KW-1300A-CB	KW-1345A-CB	18.99	KW-1300A-S	KW-1345A-S
1/4"	44	18.99	KW-1400-GP	KW-1430-GP	KW-1445-GP	14.99	KW-1400-CB	KW-1445-CB	18.99	KW-1400-S	KW-1445-S
1/8"	47	18.99	KW-1500-GP	KW-1530-GP	KW-1545-GP	15.99	KW-1500-CB	KW-1545-CB	18.99	KW-1500-S	KW-1545-S
2"	51	20.99	KW-1600-GP	KW-1630-GP	KW-1645-GP	15.99	KW-1600-CB	KW-1645-CB	18.99	KW-1600-S	KW-1645-S
2 1/8"	54	20.99	KW-1700-GP	KW-1730-GP	KW-1745-GP	15.99	KW-1700-CB	KW-1745-CB	18.99	KW-1700-S	KW-1745-S
2 1/4"	57	20.99	KW-1800-GP	KW-1830-GP	KW-1845-GP	15.99	KW-1800-CB	KW-1845-CB	18.99	KW-1800-S	KW-1845-S
2 3/8"	60	20.99	KW-1900-GP	KW-1930-GP	KW-1945-GP	15.99	KW-1900-CB	KW-1945-CB	—————	—————	—————
Size			Finishing (F) 150 Grit			Nickel Chrome (NC) 60 Grit			Ruby (R) 80 Grit		
Inch	mm	Jobber	30°	45°	Jobber	00°	45°	Jobber	00°	45°	
1/4"	32	\$14.99	—————	KW-1045-F	\$14.99	KW-1000-NC	KW-1045-NC	\$14.99	KW-1000-R	KW-1045-R	
1/8"	35	14.99	KW-1130-F	KW-1145-F	14.99	KW-1100-NC	KW-1145-NC	14.99	KW-1100-R	KW-1145-R	
1 1/16"	36	14.99	—————	KW-1145A-F	14.99	KW-1100A-NC	KW-1145A-NC	—————	—————	—————	
1/2"	38	14.99	KW-1230-F	KW-1245-F	14.99	KW-1200-NC	KW-1245-NC	14.99	KW-1200-R	KW-1245-R	
1 1/8"	39	14.99	—————	KW-1245A-F	14.99	KW-1200A-NC	KW-1245A-NC	—————	—————	—————	
1/8"	41	18.99	KW-1330-F	KW-1345-F	14.99	KW-1300-NC	KW-1345-NC	14.99	KW-1300-R	KW-1345-R	
1 1/16"	43	18.99	—————	KW-1345A-F	14.99	KW-1300A-NC	KW-1345A-NC	—————	—————	—————	
1/4"	44	18.99	KW-1430-F	KW-1445-F	14.99	KW-1400-NC	KW-1445-NC	14.99	KW-1400-R	KW-1445-R	
1/8"	47	18.99	KW-1530-F	KW-1545-F	14.99	KW-1500-NC	KW-1545-NC	14.99	KW-1500-R	KW-1545-R	
2"	51	21.99	KW-1630-F	KW-1645-F	14.99	KW-1600-NC	KW-1645-NC	15.99	KW-1600-R	KW-1645-R	
2 1/8"	54	21.99	KW-1730-F	KW-1745-F	16.49	KW-1700-NC	KW-1745-NC	—————	—————	—————	
2 1/4"	57	21.99	—————	KW-1845-F	16.49	KW-1800-NC	KW-1845-NC	—————	—————	—————	
2 3/8"	60	21.99	—————	—————	16.49	KW-1900-NC	KW-1945-NC	—————	—————	—————	

Ordering is easy!

- 1 - Find the diameter (valve head diameter + 1/16" to 1/8").
- 2 - Find the angle you need (you can modify angles with our Valve Seat Wheel Dresser Stand, page 24).
- 3 - Select the abrasive to match your job.

tech tips
from the techxperts™

Keep your stones grinding at
their best with a
Seat Wheel Dresser Stand!

See Page 24 for details



Hex Drive Seat Grinding Kit includes everything listed below. Everything comes packed in a handy storage case.

Valve Seat Grinding Sets

Order the set as-is or modify a set to meet your specific needs. Set contents include:

Description	OE Number	Jobber	Order No.	Includes		
45° Hex Drive Motor Seat Grinding Set (110V, 50/60 Hz)		\$4299.99	SGH-110-KIT	▼		
45° Hex Drive Motor Seat Grinding Set (220V, 50/60Hz)		4399.99	SGH-220-KIT	▼		
Hex Drive Seat Grinder - 45° 110V, 50/60Hz	031-3100-20	1599.99	031-3100-20	1		
Hex Drive Seat Grinder - 45° 220V, 50/60Hz	031-3100-27	1599.99	031-3100-27	1		
Universal Valve Seat Wheel Dresser w/G-13P Diamond	-----	799.99	SWD-UNI	1 1		
Replacement Dressing Stand Diamond	-----	99.99	G-13P			
Dressing Stand Pilot with .437" Top	031-1102-89	164.99	031-1102-89	1 1		
Stone Holder - 13/16" x 13 Thread w/Plunger	031-0300-30	424.99	031-0300-30	2 2		
Heavy Duty Plastic Case (21 ⁵ / ₁₆ " x 12 ¹ / ₂ " x 13 ¹ / ₂ ")	001-1000-25	57.99	SG-CASE	1 1		
Seat Stone Removal Tool	-----	29.99	KW-SRT	1 1		
Leather Vibration Reducer (3 Pc.)	-----	13.99	KHW-3	1 1		
.437" Top Pilots Dia./mm						
.2755" / 7.00mm	030-0237-30	\$63.99	P-5275K	1 1		
.2763" / 7.02mm	030-0237-49	63.99	P-5276K	1 1		
.2765" / 7.05mm	030-0237-40	63.99	P-5277K	1 1		
.3125" / 7.93mm	030-0239-35	63.99	P-5312K	1 1		
.3135" / 7.96mm	030-0239-51	63.99	P-5313K	1 1		
.3145" / 7.98mm	030-0239-78	63.99	P-5314K	1 1		
.3150" / 8.00mm	030-0239-94	63.99	P-5315K	1 1		
.3437" / 8.72mm	030-0242-73	63.99	P-5343K	1 1		
.3440" / 8.74mm	030-0243-03	63.99	P-5344K	1 1		
.3457" / 8.78mm	030-0243-11	63.99	P-5345K	1 1		
.3730" / 9.47mm	030-0247-45	63.99	P-5373K	1 1		
.3750" / 9.52mm	030-0247-70	63.99	P-5375K	1 1		
General Purpose Valve Seat Grinding Stones (3/8" x 13)	30°			45°		
1.375" / 35mm	\$16.99	KW-1130-GP	1 1	\$16.99	KW-1145-GP	1 1
1.500" / 38mm	18.99	KW-1230-GP	1 1	18.99	KW-1245-GP	1 1
1.615" / 41mm	18.99	KW-1330-GP	1 1	18.99	KW-1345-GP	1 1
1.750" / 44mm	18.99	KW-1430-GP	1 1	18.99	KW-1445-GP	1 1
1.785" / 47mm	18.99	KW-1530-GP	1 1	18.99	KW-1545-GP	1 1
2.000" / 51mm	20.99	KW-1630-GP	1 1	20.99	KW-1645-GP	1 1
2.125" / 54mm	20.99	KW-1730-GP	1 1	20.99	KW-1745-GP	1 1
Finishing Valve Seat Grinding Stones (3/8" x 13)	30°			45°		
1.375" / 35mm	\$14.99	KW-1130-F	1 1	\$14.99	KW-1145-F	1 1
1.500" / 38mm	14.99	KW-1230-F	1 1	14.99	KW-1245-F	1 1
1.625" / 41mm	18.99	KW-1330-F	1 1	18.99	KW-1345-F	1 1
1.750" / 44mm	18.99	KW-1430-F	1 1	18.99	KW-1445-F	1 1
1.785" / 47mm	18.99	KW-1530-F	1 1	18.99	KW-1545-F	1 1
2.000" / 51mm	21.99	KW-1630-F	1 1	21.99	KW-1645-F	1 1
2.125" / 54mm	21.99	KW-1730-F	1 1	21.99	KW-1745-F	1 1



45° Kwik-Way Hex Drive (SGH) Electric Motor Unit
1/2"-20 Thread

- Heavy duty electric motor
- 11,500 RPM • Weighs 9 lbs.
- 3/5 HP, 7.5 Amps

Description	Jobber	Order No.
110V, 50/60Hz	\$1599.99	031-3100-20
220V, 50/60Hz	1599.99	031-3100-27
Nose Assembly	844.99	031-3105-12
Hex Drive Assembly	86.99	031-3112-17
Replacement Leather Pad	5.99	031-1009-41
2 Pc. Brush Set	34.99	003-0072-43
Trigger Switch	45.99	000-1201-20

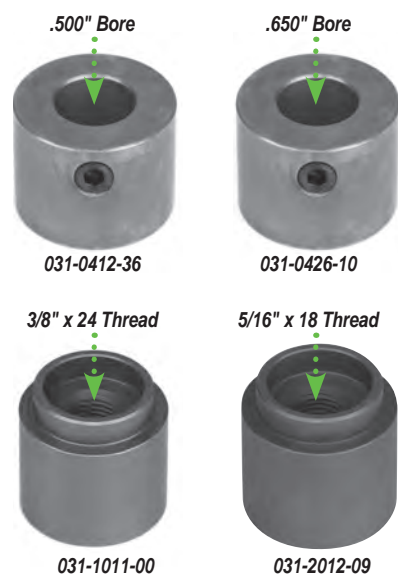

Hex Drive Replacement Adaptors

• Adapt your Seat Grinder Motor to fit various Kwik-Way Seat Grinders

Description	Jobber	Order No.
.500" Bore	\$85.99	031-0412-36
Fit SGA Motor Units with Serial No. 0 to 2000		
.650" Bore	69.99	031-0426-10
Fit SGA Motor Units with Serial No. 4000 & up		
3/8" x 24 Thread	77.99	031-1011-00
Fit SGAll Hex Motor Units		
5/16" x 18" Thread	63.99	031-2012-09
Fit SSG Hex Motor Units		

CYLINDER HEAD REBUILDING
CLEANING, ASSEMBLY & SAFETY
SHORT BLOCK REBUILDING
FLYWHEEL GRINDING
CRANKSHAFT/ MISCELLANEOUS TOOLS & SUPPLIES
BRAKE SERVICE TOOLING
MEASURING TOOLS
V-TWIN & METRIC HARD PARTS



"If you need a custom angle or size in a Valve Seat Stone, Goodson can do it. We grind seat stones in-house to standard and custom dimensions. Give Goodson a call today."

- Tim, Goodson Production - 9 years of service

Order 10 or more Valve Seat Wheels
(any combination) and
SAVE 10% off jobber



CYLINDER HEAD
REBUILDING

CLEANING,
ASSEMBLY & SAFETY

SHORT BLOCK
REBUILDING

CRANKSHAFT/
FLYWHEEL GRINDING

MISCELLANEOUS
TOOLS & SUPPLIES

BRAKE SERVICE
TOOLING

MEASURING
TOOLS

V-TWIN & METRIC
HARD PARTS

SX

Fits Sioux™, KO Lee, US, Thor, Skil, Winona 11/16"x16 thread

Colors may vary due to manufacturing processes

Size		General Purpose (GP) 70 Grit				Cool Blue (CB) 80 Grit		Ruby 80 Grit					
Inch	mm	Jobber	00°	30°	45°	60°	00°	45°	Jobber	00°	45°		
7/8"	22								\$23.99	SX-500-R	SX-545-R		
15/16"	24								23.99	SX-600-R	SX-645-R		
1"	25								23.99	SX-700-R	SX-745-R		
1 1/16"	27								23.99	SX-800-R	SX-845-R		
1 1/8"	28	\$13.99	SX-900-GP	SX-930-GP	SX-945-GP				23.99	SX-900-R	SX-945-R		
1 3/16"	30	13.99	SX-900A-GP		SX-945A-GP								
1 1/4"	32	13.99	SX-1000-GP	SX-1030-GP	SX-1045-GP	SX-1060-GP	\$13.99	SX-1000-CB	SX-1045-CB	13.99	SX-1000-R	SX-1045-R	
1 5/16"	33	13.99	SX-1000A-GP		SX-1045A-GP		13.99	SX-1000A-CB	SX-1045A-CB				
1 3/8"	35	13.99	SX-1100-GP	SX-1130-GP	SX-1145-GP	SX-1160-GP	13.99	SX-1100-CB	SX-1145-CB	13.99	SX-1100-R	SX-1145-R	
1 1/2"	36	13.99	SX-1100A-GP		SX-1145A-GP		13.99	SX-1100A-CB	SX-1145A-CB				
1 5/8"	38	13.99	SX-1200-GP	SX-1230-GP	SX-1245-GP	SX-1260-GP	13.99	SX-1200-CB	SX-1245-CB	13.99	SX-1200-R	SX-1245-R	
1 3/4"	39	13.99	SX-1200A-GP		SX-1245A-GP		13.99	SX-1200A-CB	SX-1245A-CB				
1 7/8"	41	13.99	SX-1300-GP	SX-1330-GP	SX-1345-GP	SX-1360-GP	13.99	SX-1300-CB	SX-1345-CB	13.99	SX-1300-R	SX-1345-R	
1 15/16"	43	13.99	SX-1300A-GP		SX-1345A-GP		13.99	SX-1300A-CB	SX-1345A-CB				
1 3/4"	44	13.99	SX-1400-GP	SX-1430-GP	SX-1445-GP	SX-1460-GP	13.99	SX-1400-CB	SX-1445-CB	13.99	SX-1400-R	SX-1445-R	
1 7/8"	47	13.99	SX-1500-GP	SX-1530-GP	SX-1545-GP	SX-1560-GP	13.99	SX-1500-CB	SX-1545-CB	13.99	SX-1500-R	SX-1545-R	
2"	51	13.99	SX-1600-GP	SX-1630-GP	SX-1645-GP	SX-1660-GP	13.99	SX-1600-CB	SX-1645-CB	13.99	SX-1600-R	SX-1645-R	
2 1/8"	54	13.99	SX-1700-GP	SX-1730-GP	SX-1745-GP		13.99	SX-1700-CB	SX-1745-CB	13.99	SX-1700-R	SX-1745-R	
2 1/4"	57	13.99	SX-1800-GP	SX-1830-GP	SX-1845-GP	SX-1860-GP	13.99	SX-1800-CB	SX-1845-CB	13.99	SX-1800-R	SX-1845-R	
2 3/8"	60	13.99	SX-1900-GP	SX-1930-GP	SX-1945-GP	SX-1960-GP	13.99	SX-1900-CB	SX-1945-CB	13.99	SX-1900-R	SX-1945-R	
2 1/2"	63	14.99	SX-2000-GP	SX-2030-GP	SX-2045-GP		13.99	SX-2000-CB	SX-2045-CB	13.99	SX-2000-R	SX-2045-R	
2 5/8"	66	14.99	SX-2100-GP	SX-2130-GP	SX-2145-GP		13.99	SX-2100-CB	SX-2145-CB				
Size		Stellite (S) 100 Grit			Finishing (F) 150 Grit			Nickel Chrome 60 Grit					
Inch	mm	Jobber	00°	30°	45°	Jobber	00°	30°	45°	Jobber	00°	30°	45°
7/8"	22					\$23.99	SX-500-F		SX-545-F	23.99	SX-500-NC		SX-545-NC
15/16"	24					23.99	SX-600-F		SX-645-F	23.99	SX-600-NC		SX-645-NC
1"	25					23.99	SX-700-F		SX-745-F	23.99	SX-700-NC		SX-745-NC
1 1/16"	27					23.99	SX-800-F		SX-845-F	23.99	SX-800-NC		SX-845-NC
1 1/8"	28	\$19.99	SX-900-S	SX-930-S	SX-945-S	20.99	SX-900-F	SX-930-F	SX-945-F	13.99	SX-900-NC	SX-930-NC	SX-945-NC
1 3/16"	30	19.99	SX-900A-S		SX-945A-S	20.99	SX-900A-F		SX-945A-F	13.99	SX-900A-NC		SX-945A-NC
1 1/4"	32	15.99	SX-1000-S	SX-1030-S	SX-1045-S	20.99	SX-1000-F	SX-1030-F	SX-1045-F	13.99	SX-1000-NC	SX-1030-NC	SX-1045-NC
1 5/16"	33	15.99	SX-1000A-S		SX-1045A-S	20.99	SX-1000A-F		SX-1045A-F	13.99	SX-1000A-NC		SX-1045A-NC
1 3/8"	35	15.99	SX-1100-S	SX-1130-S	SX-1145-S	20.99	SX-1100-F	SX-1130-F	SX-1145-F	13.99	SX-1100-NC	SX-1130-NC	SX-1145-NC
1 1/2"	36	15.99	SX-1100A-S		SX-1145A-S	20.99	SX-1100A-F		SX-1145A-F	13.99	SX-1100A-NC		SX-1145A-NC
1 5/8"	38	14.99	SX-1200-S	SX-1230-S	SX-1245-S	13.99	SX-1200-F	SX-1230-F	SX-1245-F	13.99	SX-1200-NC	SX-1230-NC	SX-1245-NC
1 3/4"	39	14.99	SX-1200A-S		SX-1245A-S	13.99	SX-1200A-F		SX-1245A-F	13.99	SX-1200A-NC		SX-1245A-NC
1 7/8"	41	14.99	SX-1300-S	SX-1330-S	SX-1345-S	13.99	SX-1300-F	SX-1330-F	SX-1345-F	13.99	SX-1300-NC	SX-1330-NC	SX-1345-NC
1 15/16"	43	14.99	SX-1300A-S		SX-1345A-S	13.99	SX-1300A-F		SX-1345A-F	13.99	SX-1300A-NC		SX-1345A-NC
1 3/4"	44	14.99	SX-1400-S	SX-1430-S	SX-1445-S	18.99	SX-1400-F	SX-1430-F	SX-1445-F	13.99	SX-1400-NC	SX-1430-NC	SX-1445-NC
1 7/8"	47	14.99	SX-1500-S	SX-1530-S	SX-1545-S	18.99	SX-1500-F	SX-1530-F	SX-1545-F	13.99	SX-1500-NC	SX-1530-NC	SX-1545-NC
2"	51	14.99	SX-1600-S	SX-1630-S	SX-1645-S	18.99	SX-1600-F	SX-1630-F	SX-1645-F	13.99	SX-1600-NC	SX-1630-NC	SX-1645-NC
2 1/8"	54	14.99	SX-1700-S	SX-1730-S	SX-1745-S	18.99	SX-1700-F	SX-1730-F	SX-1745-F	13.99	SX-1700-NC	SX-1730-NC	SX-1745-NC
2 1/4"	57	14.99	SX-1800-S	SX-1830-S	SX-1845-S	18.99	SX-1800-F	SX-1830-F	SX-1845-F	13.99	SX-1800-NC	SX-1830-NC	SX-1845-NC
2 3/8"	60	14.99	SX-1900-S	SX-1930-S	SX-1945-S	22.99	SX-1900-F	SX-1930-F	SX-1945-F	13.99	SX-1900-NC	SX-1930-NC	SX-1945-NC
2 1/2"	63	14.99	SX-2000-S	SX-2030-S	SX-2045-S	22.99	SX-2000-F	SX-2030-F	SX-2045-F	15.99	SX-2000-NC	SX-2030-NC	SX-2045-NC
2 5/8"	66									15.99	SX-2100-NC	SX-2130-NC	SX-2145-NC

All Valve Seat Wheels are guaranteed against manufacturing defects for 1 year from original purchase date

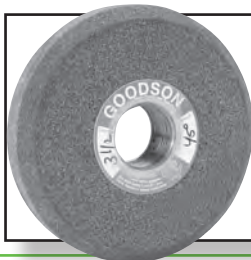

2 Angle Valve Seat Wheels

- Use with SX-HOLDER & SX-78 adaptor (page 22)
- 30° one side, 45° on the other side

General Purpose		
Inch	mm	Order No.
2 5/8"	66.0	SXL-2145-GP
3"	76.2	SXL-2345-GP
3 1/2"	88.9	SXL-2545-GP
3 3/4"	92.3	SXL-2645-GP
4"	101.6	SXL-2745-GP
Jobber		\$24.99

SX-HOLDER



SX-78





made in
America

KWIK-WAY
Seat Grinding Equipment & Supplies®
MFG BY

GOODSON

Tools and Supplies for Engine Builders



45° Sioux-Style (SGK) Star Drive Electric Motor Unit

- Heavy duty electric motor
- 11,500 RPM
- Weighs 9 lbs.
- 3/5 HP • 7.5 Amps

Description	Jobber	Order No.
110V, 50/60Hz	\$1599.99	031-3100-21
220V, 50/60Hz	1699.99	031-3100-28
Nose Assembly	839.99	034-3105-00
2 Pc. Brush Set	34.99	003-0072-43
Trigger Switch	45.99	000-1201-20

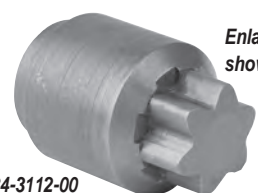

Enlarged to show detail

034-3112-00

Replacement Drive Assemblies

- 1/2" x 20 thread
- Easy to install
- Always keep one on hand for emergencies

Description	Jobber	Order No.
Star Drive (SGH)	\$87.99	034-3112-00

Sioux-Style Valve Seat Grinding Kits

These kits include everything you need to get started in seat grinding. Choose between kits including 110V and 220V Star Drive Electric Grinders. After that, everything else in the kit is identical.

We started with the most common sizes of pilots and valve seat stones, but you can customize one of these kits to meet your specific needs. Call 1-800-533-8010 for additional information.

Description	OE Number	Jobber	Order No.	Includes		
45° Star Drive Motor Seat Grinding Set (110V, 50/60 Hz)		\$3799.99	SGK-110-KIT	▼		
45° Star Drive Motor Seat Grinding Set (220V, 50/60Hz)		3899.99	SGK-220-KIT	▼		
Star Drive Seat Grinder - 45° 110V, 50/60 Hz	031-3100-21	1599.99	031-3100-21	1		
Star Drive Seat Grinder - 45° 220V, 50/60 Hz	031-3100-28	1699.99	031-3100-28	1		
Universal Valve Seat Wheel Dresser w/G-13P Diamond	-----	799.99	SWD-UNI	1 1		
Replacement Dressing Diamond	-----	99.99	G-13P			
Dressing Stand Pilot	031-0202-55	164.99	031-0202-55	1 1		
Stone Holder - 1/8" x 16 Thread	1702	209.99	SX-HOLDER	2 2		
Heavy Duty Plastic Storage Box (21 1/16" x 12 1/2" x 13 1/2")	001-1000-25	57.99	SG-CASE	1 1		
Seat Stone Removal Tool	-----	29.99	SX-SRT	1 1		
Bounce Spring Set (3 Pc.)	-----	21.99	BSS-100	1 1		
Leather Vibration Reducer (3 Pc.)	-----	13.99	SHW-3	1 1		
.385" Top Pilots	Dia./mm					
	.2755" / 7.00mm	\$51.99	P-5275S	1 1		
	.2763" / 7.02mm	51.99	P-5277S	1 1		
	.2779" / 7.05mm	51.99	P-5278S	1 1		
	.3125" / 7.94mm	51.99	P-5312S	1 1		
	.3130" / 7.95mm	51.99	P-5313S	1 1		
	.3141" / 7.98mm	51.99	P-5314S	1 1		
	.3149" / 8.00mm	51.99	P-5315S	1 1		
	.3430" / 8.71mm	51.99	P-5343S	1 1		
	.3440" / 8.73mm	51.99	P-5344S	1 1		
	.3450" / 8.76mm	51.99	P-5345S	1 1		
	.3750" / 9.53mm	51.99	P-5375S	1 1		
	.3760" / 9.55mm	51.99	P-5376S	1 1		
General Purpose Seat Grinding Stones (1/16"x16)	30°			45°		
1.375" / 35mm	\$13.99	SX-1130-GP	1 1	\$13.99	SX-1145-GP	1 1
1.500" / 38mm	13.99	SX-1230-GP	1 1	13.99	SX-1245-GP	1 1
1.625" / 41mm	13.99	SX-1330-GP	1 1	13.99	SX-1345-GP	1 1
1.750" / 44mm	13.99	SX-1430-GP	1 1	13.99	SX-1445-GP	1 1
1.785" / 47mm	13.99	SX-1530-GP	1 1	13.99	SX-1545-GP	1 1
2.000" / 51mm	13.99	SX-1630-GP	1 1	13.99	SX-1645-GP	1 1
2.125" / 54mm	13.99	SX-1730-GP	1 1	13.99	SX-1745-GP	1 1
Finishing Valve Seat Grinding Stones (1/16"x16)	30°			45°		
1.375" / 35mm	\$20.99	SX-1130-F	1 1	\$20.99	SX-1145-F	1 1
1.500" / 38mm	13.99	SX-1230-F	1 1	13.99	SX-1245-F	1 1
1.625" / 41mm	13.99	SX-1330-F	1 1	13.99	SX-1345-F	1 1
1.750" / 44mm	13.99	SX-1430-F	1 1	13.99	SX-1445-F	1 1
1.785" / 47mm	13.99	SX-1530-F	1 1	13.99	SX-1545-F	1 1
2.000" / 51mm	13.99	SX-1630-F	1 1	13.99	SX-1645-F	1 1
2.125" / 54mm	13.99	SX-1730-F	1 1	14.99	SX-1745-F	1 1

CYLINDER HEAD REBUILDING
CLEANING, ASSEMBLY & SAFETY
SHORT BLOCK REBUILDING
FLYWHEEL GRINDING
CRANKSHAFT/ TOOLS & SUPPLIES
MISCELLANEOUS
BRAKE SERVICE
TOOLING
MEASURING
TWIN & METRIC HARD PARTS



"We replenish our warehouse locations daily so that items are readily available to fill your orders without delay."

- Tracy, Goodson Receiving - 3 years of service

CYLINDER HEAD
REBUILDING

CLEANING,
ASSEMBLY & SAFETY

SHORT BLOCK
REBUILDING

CRANKSHAFT/
FLYWHEEL GRINDING

MISCELLANEOUS
TOOLS & SUPPLIES

BRAKE SERVICE
TOOLING

MEASURING
TOOLS

V-TWIN & METRIC
HARD PARTS

Rebuildable
¹³/₁₆"x13 Thread Hex Drive
Kwik-Way Stone Holder

- Use to replace worn-out holders or save time by having several holders set up with different sizes, compositions or angles of seat stones • Ball-bearing construction
- Without spring plunger
- Use rebuild kit 034-0002-00 (below)
- ¹³/₁₆" x 13 thread
- .437" Pilot Size
- Supersedes KW-3056
- Order No. **031-0300-56** Jobber \$399.99



Rebuildable
¹³/₁₆"x13 Thread Hex Drive
Kwik-Way Stone Holder

- Use to replace worn-out holders or save time by having several holders set up with different sizes, compositions or angles of seat stones • Ball-bearing construction
- With spring plunger
- Use rebuild kit 034-0002-15 (below)
- ¹³/₁₆" x 13 thread
- .437" Pilot Size
- Order No. **031-0300-30** Jobber \$424.99



New-Generation
Hex Drive Stone Holder
For .375" Top Pilot

- Use to replace worn-out holders or save time by having several holders set up with different sizes, compositions or angles of seat stones • Ball-bearing construction
- Without spring plunger
- ¹³/₁₆" x 13 thread
- .375" Pilot Size
- Order No. **KW-375E** Jobber \$244.99



New-Generation
Hex Drive Stone Holder
For .375" Top Pilot

- Use to replace worn-out holders or save time by having several holders set up with different sizes, compositions or angles of seat stones • Ball-bearing construction
- Without spring plunger
- ¹³/₁₆" x 13 thread
- .437" Pilot Size
- Order No. **KW-437** Jobber \$257.99



Accessories	Jobber	Order No.
Stabilizer Assembly with Bronze Bushing	\$ 59.99	031-0126-60
Heavy-Duty Twisted Cable Steel Coupling	109.99	031-0304-10
Replacement Hex Drive Body Cap	83.99	031-0302-95
Replacement Spring Plunger Assembly	11.49	031-0313-97
Leather Vibration Reducer (3 pc.) For KW-Holders	13.99	KHW-3
Valve Seat Stone Removal Tool	29.99	KW-SRT

SX-78

Accessories	Jobber	Order No.
Sioux-Style Conversion Bushings ¹ / ₁₆ "x16 to ⁷ / ₁₆ "x14	\$11.99	SX-78
Black & Decker ⁵ / ₈ " Hexball ⁵ / ₁₆ "x24 thread	59.99	BD-58
³ / ₁₆ "-16 to ¹ / ₁₆ "-16 Adaptor for Sioux Style	10.99	BD-60

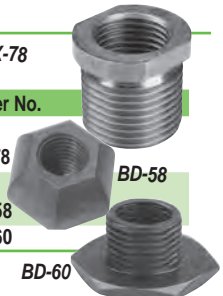

BD-60



Stone Holder Rebuild Kits

For Hex Drive Stone Holder without Spring Plunger Includes 2 Bearings, Bearing Sleeve, Bearing Lock Nut, Sleeve Key, Hex Cap & Garter Spring Fits OE & Goodson models
Jobber \$224.99 Order No. **034-0002-00**



For Hex Drive Stone Holder with Spring Plunger

Includes 2 Bearings, Bearing Sleeve, Bearing Lock Nut, Sleeve Key, Hex Cap & Spring Plunger. Fits OE & Goodson models
Jobber \$227.99 Order No. **034-0002-15**



For Flex Drive Stone Holder

Includes 2 Bearings, Bearing Sleeve, Heavy Duty Flex Coupling, Inner Sleeve Key & Set Screw
Jobber \$308.99 Order No. **034-0003-25**
Rebuild kit components are not available individually



031-0390-02



031-0391-00



031-0393-04

Grinding Wheel Adaptors

Description	Jobber	Order No.
¹³ / ₁₆ "-13 (KW) Threaded Stones to ¹ / ₁₆ "-16 Threaded Holders (Sioux™, KO Lee)	\$66.99	031-0390-02
¹³ / ₁₆ "-13 (KW) Threaded Stones to ³ / ₁₆ "-16 Threaded Holders (Black & Decker)	66.99	031-0391-00
¹³ / ₁₆ "-13 (KW) Threaded Stones to ² / ₁₆ "-18 Threaded Holders (Kwik-Way)	66.99	031-0393-04

Seat Stone Holders, Adaptors, Etc.

11/16" x16 Thread Star Drive Stone Holder

- Use to replace worn-out holders or save time by having several holders set up with different sizes, compositions or angles of seat stones
- Ball-bearing construction
- .385" Top Pilot Size



Description	OAL	OE#	Jobber	Order No.
Short Body	3 1/2"	1672	\$164.99	SX-1672
Standard Body	4 3/4"	—	209.99	SX-HOLDER

11/16" x16 Thread Hex Drive Stone Holder For .375" Top Pilot

- Use to replace worn-out holders or save time by having several holders set up with different sizes, compositions or angles of seat stones
- Ball-bearing construction
- OAL: 5 3/16"
- OE# 1702BB
- .375" Top Pilot Size
- Order No. **SX-1702BB** Jobber \$264.99



11/16" x16 Thread Star Drive Stone Holder For .375" Top Pilot

- Use to replace worn-out holders or save time by having several holders set up with different sizes, compositions or angles of seat stones
- Ball-bearing construction
- OAL: 4 3/4"
- .375" Top Pilot Size
- Order No. **SX-375** Jobber \$249.99



9/16" x16 Thread Black & Decker Style Stone Holder For .375" Top Pilot

- Use to replace worn-out holders or save time by having several holders set up with different sizes, compositions or angles of seat stones
- Ball-bearing construction • OE # BD-HOLDER
- .375" Top Pilot Size
- Includes BD-60 Adaptor to convert to 11/16" x16 thread
- Order No. **BDS-HOLDER** Jobber \$224.99



11/16" x16 Thread Star Drive Stone Holder For .389" Top Pilot

- Use to replace worn-out holders or save time by having several holders set up with different sizes, compositions or angles of seat stones
- Ball-bearing construction
- OAL: 4 3/4"
- OE# 1702
- .389" Top Pilot Size
- Order No. **SUN-HOLDER** Jobber \$244.99

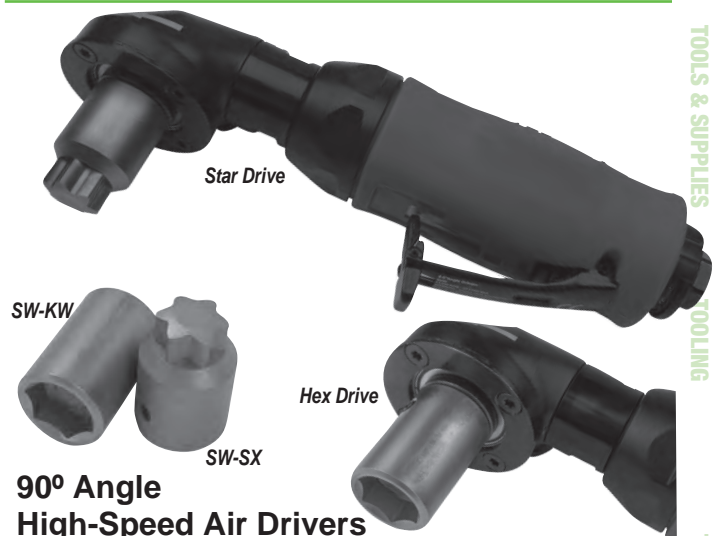

90° Angle High-Speed Air Drivers

- 2 models available - Star or hex drive
- 11,000 RPM motor
- 5/8" - 11 spindle
- 1/4" air inlet • 6 CFM • Rear exhaust
- Weighs 2.25 lbs. • Measures 8.75" long
- Composite grip and trigger are designed for user comfort

Description	Jobber	Order No.
Star Drive (SGK) 5/8" - 11 spindle	\$389.99	AG-SX90
Hex Drive (SGH) 5/8" - 11 spindle	389.99	AG-KW90
Replacement Drive Adaptors (1 1/2" OAL)		
Star-Drive (SGK) Adaptor	\$114.99	SW-SX
Hex Socket (SGH) Adaptor	109.99	SW-KW

Air Drive Adaptors

- 1/4" shank
- Adaptors available for a variety of stone holders
- Use with bounce springs (page 24) for best results



Description	Jobber	Order No.
Hexball Driver	5/8" SAE thread	\$84.99 ADA-BDS
Kwik-Way Drive Adaptor	1/2" x 20 thread	84.99 ADA-KW
Sioux-Style Drive Adaptor	Welded style adaptor	97.99 ADA-SX-HD

CYLINDER HEAD
REBUILDING

CLEANING,
ASSEMBLY & SAFETY

SHORT BLOCK
REBUILDING

CRANKSHAFT/
FLYWHEEL GRINDING

MISCELLANEOUS
TOOLS & SUPPLIES

BRAKE SERVICE
TOOLING

MEASURING
TOOLS

V-TWIN & METRIC
HARD PARTS

Goodson
exclusive

Universal Valve Seat Wheel Dresser Stand

- Infinitely adjustable from 0° to 90°
- Scale marked in 1° increments
- Dress stones up to 4" diameter
- Includes Premium dresser diamond & dresser pilot
- Base has pre-drilled holes for easy mounting to your bench
- **Choose dresser pilot from chart below**

Description	Jobber	Order No.	Incl.
Universal Dressing Stand	\$799.99	SWD-UNI	▼
Replacement Premium Dressing Diamond	99.99	G-13P	x
Dressing Stand Riser Bushings (.250" & .875" Tall)	12.49	SK-9-10	x
Dressing Stand Riser Bushings (For .437" dresser pilots)	12.49	SK-11-12	

See pages 18-23 for valve seat stones, stone holders, air drivers, etc.

Stones and Holders
sold separatelyIncludes
Premium Dresser Pilot
Choose From
Chart Below

Heavy Duty Valve Seat Wheel Dresser Stand

- Ball bearing mounted diamond carrier
- Adjustable in 1° increments from 0° to 90°
- Includes diamond
- **Choose dressing pilot from list below**
- Designed for maximum accuracy

Description	Jobber	Order No.
Heavy Duty Dresser	\$1229.99	031-1900-02
Replacement Torsion Spring for 031-1900-02	39.99	000-1850-78
Replacement Brass Plug	24.99	031-1917-00
Replacement Diamond Dresser	49.99	G-18

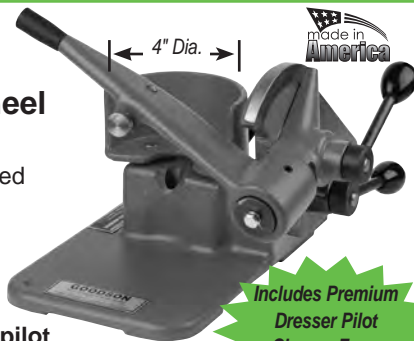
Includes Premium
Dresser Pilot
Choose From
Chart Below

Valve Seat Wheel Dresser Pilots for Universal & Heavy Duty Wheel Dresser Stands

- .437" top pilots include a groove
- All pilots have .625" bottom

Dresser Pilots (select based on stone holder type)			
Fits Stone Holder Type	OAL	Jobber	Order No.
A .437" Hex Stone Holder	5"	\$164.99	031-1102-89
B .437" Hex or Flex Stone Holder	7"	164.99	031-0202-80
C .385" Top Stone Holder	6"	164.99	031-0202-55
D .375" Top Stone Holder	6"	164.99	031-0202-47

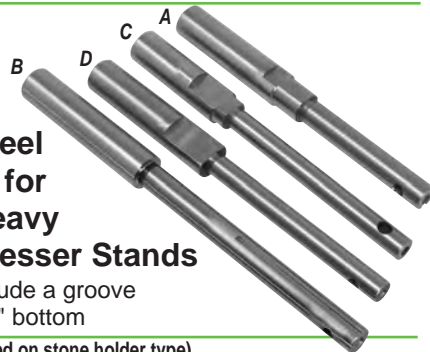

Seat Stone Removal Tool

Once in a while a valve seat stone will be so tight on the stone holder that it's almost impossible to get off. That's why we came up with this tool. Simply fasten it to your bench with screws or bolts (not included) or clamp it in a vise, place the holder onto the fixture and twist the stone off easily.

Description	Jobber	Order No.
Sioux-Style	\$29.99	SX-SRT
Kwik-Way Style	29.99	KW-SRT



Valve Seat Height Gauge

- Adjusts for all popular valve seat diameters • Gauge accurate to .001"
- Seat contact probe aligns on valve seat while gauge rides along the fire deck • Pilot aligns in valve guide
- Fully adjustable seat contact probe and gauge positions allow tool to fit popular seat diameters from .750" to 3.00"
- Includes Dial Indicator

Description	Fits Pilot	Jobber	Order No.
Valve Seat Height Gauge Kit	.375"	\$108.99	VSHG-375
Replacement Dial Indicator		32.99	EDI-1



tech tips Goodson recommends using Bounce Springs with your Valve Seat Stones to prevent damage to the stone and the from the techparts™ seat. This is especially important with the very small stones.

Standard Bounce Spring Set

- Includes 1 each of 3 lengths: 1" / 24.5mm, 1.50" / 38.1mm & 2" / 50.8mm
- ID = .450" / 11.4mm
- OD = .570" / 14.5mm
- Not for use with 3-D Fast Cut
- Order No. **BSS-100**
Jobber \$21.99

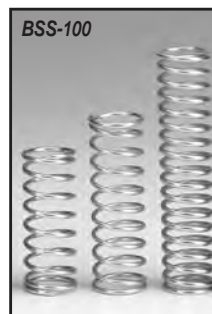

Small Diameter Bounce Springs

- ID = .406"/10.3mm
- OD = .500"/12.7mm

Length / mm	Jobber	Order No.
1.10" / 27.9	\$10.49	BS-1
1.67" / 42.4	10.49	BS-2
3.00" / 76.2	10.49	BS-3

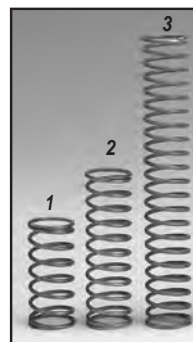

Valve Refacing

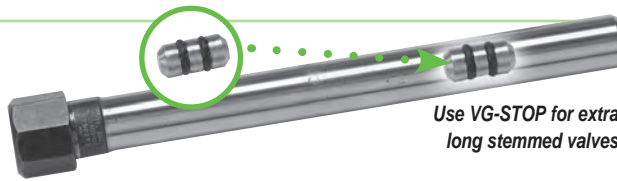

Use VG-STOP for extra long stemmed valves



Find out how to expand the capacity of your valve refacer to accept smaller valves. Scan the code at right with your smart phone or other smart device for instant access.



Adaptor for 1/2" Chucks

- For small diameter valves
- Collet cover range from 2.8mm to 6.5mm
- Hardened steel collet holder fits any machine with a 1/2" chuck
- Collet seats in retainer nut for fast, easy removal
- Internal stop adjusts, allowing you to reface an entire set of valves to identical specs quickly
- Start with the set then replace collets as needed (**collets will not work without the holder**)
- Use the Adaptor Stop to machine longer valve stems

Description	Range	Jobber	Order No.	Incl.
Full Set		\$379.99	UVRC-46	▼
Steel Collet Holder (collets MUST be used)		229.99	UVRC-46R	x
Replacement Collets	2.8 to 3.2mm (.109" to .125")	49.99	UVRC-18	
	3.0 to 3.5mm (.118" to .138")	49.99	UVRC-3.5MM	x
	3.5 to 4.0mm (.138" to .158")	49.99	UVRC-4.0MM	x
	4.0 to 4.5mm (.158" to .177")	49.99	UVRC-4.5MM	
	4.4 to 4.8mm (.172" to .1875")	49.99	UVRC-316	
	4.5 to 5.0mm (.177" to .196")	49.99	UVRC-5MM	x
	4.8 to 5.2mm (.1875" to .203")	49.99	UVRC-1364	
	5.0 to 5.5mm (.196" to .216")	49.99	UVRC-5.5MM	x
	5.5 to 6.0mm (.216" to .236")	49.99	UVRC-6.0MM	
	6.0 to 6.5mm (.236" to .256")	49.99	UVRC-6.5MM	x
Replacement Nut		49.99	UVRC-NUT	
Adaptor Stop		16.99	VG-STOP	x

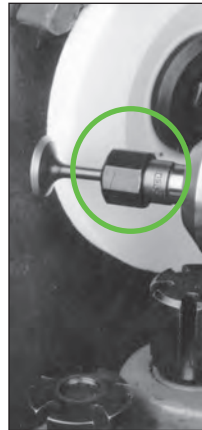

Valve Stem to Valve Face Concentricity Gauge

- Accurate to .001"
- Features a rugged, positive stop – set it once and do an entire set of valves • Use before grinding to eliminate needless cleaning & machine time • Use after refacing to ensure stem concentricity • Also check pilots and other small parts for concentricity
- For stems as small as 4mm
- Order No. VCG-16 Jobber \$299.99



Sun-Dura® Canvas Machine Covers

- Heavy-weight, breathable black Sun-Dura® fabric won't hold in moisture
- Several sizes to fit a variety of machines
- All covers will fit other machines, just match your machine's dimensions to the cover dimensions
- Covers are opaque, pictures for demonstration only

Fits Machine	Dimensions	Jobber	Order No.
Ring Filer	13"L x 7 1/2"D x 7 1/2"H	\$33.99	GMC-PRF
VST-2000 Spring Tester	10"L x 14"D x 18"H	45.99	GMC-VST
AG-Series Precision Gauge	8"L x 8"W x 4"D	40.99	GMC-AG300
Rimac Spring Tester	32"dia. x 18 1/2"H (tapers)	39.99	GMC-RIMAC



Valve Grinding Aid For Titanium, Stainless & Stellite Valves

- Not water soluble - add to your mineral based Valve Grinding Oil for better finish on titanium, stainless steel and stellite valves
- Mix ratio: 1:4 • Won't hinder your regular valve grinding process
- Seeks out, and bonds to hot metals
- Ideal for grinding hard metal racing valves • 32 oz. / 946 mL
- Order No. VGA-T32 Jobber \$45.99

Mix 1 part grinding aid to 4 parts refacer oil

CYLINDER HEAD REBUILDING
CLEANING, ASSEMBLY & SAFETY
SHORT BLOCK REBUILDING
CRANKSHAFT/ FLYWHEEL GRINDING
MISCELLANEOUS TOOLS & SUPPLIES
BRAKE SERVICE TOOLING
MEASURING TOOLS
V-TWIN & METRIC HARD PARTS

Precision made wheels = superior performance

We stock more than 40 individual valve refacer wheels, each one designed for a specific machine. Our 4" general purpose wheel for Black & Decker is different from our 4" general purpose wheel for Sioux™. We won't compromise on performance just to simplify our inventory. Your valve refacer requires a certain type of grit, grade and bond and Goodson delivers. All Goodson Valve Refacing Wheels are designed to be used with mineral based grinding oils such as VGO-10 or VGO-SD10. Goodson guarantees all valve refacing wheels against manufacturing defects for 1 year from original purchase date.

Choose from these types: **GP** = for general purpose grinding **S** = for grinding Stellite, **T** = for grinding Titanium, and **CB** = for general purpose grinding of harder materials. Stone color may vary due to manufacturing process.

To Fit	Use	Dia x Ht x Arb	Shape	Type	Color	Fits Models	OE No.	Jobber	Order No.		
Black & Decker	Valve	4" x 1" x 5/8"	Offset	CB	Blue	A, B, C, LW, M, MW, N, NW, NWB	Goodson Spec	\$ 37.99	GV-146-CB		
		4" x 1" x 3/8"	Offset	S	Ruby	A, B, C, LW, M, MW, N, NW, NWB	16371	39.99	GV-144		
		4" x 1" x 5/8"	Offset	GP	Gray	All but 680, 682, 285, 956		49.99	GV-147		
		4" x 1" x 5/8"	Offset	GP	Black	All but 680, 682, 285, 956		81.99	GV-148		
		4" x 1" x 3/8"	Offset	T	Green	All but 680, 682, 285, 956	Goodson Spec	68.99	GV-150		
	Stem	5" x 1" x 5/8"	Offset/20°	GP	Pink	P, PC, PCB, T, TD, TG	34131	55.99	GV-156		
		4" x 1 1/8" x 1/2"	Cup	GP	Ruby	All models	20939	47.99	GV-145		
Comec	Valve	215 x 35 x 76mm	Flared	GP	Gray	VR416, RV-516	7604	251.99	GV-925		
		215 x 35 x 76mm	Flared	S	Brown	VR416, RV-516	Goodson Spec	224.99	GV-980		
	Stem	100 x 50 x 20mm	Cup	GP	White	VR416, RV-516	7606	78.99	GV-928		
IDL Sunnen®	Valve	8" x 1 1/4" x 1 1/2"	Flared	GP	White	CG-50,-80,-82, V-90, VR-7000	8230	204.99	GV-823		
		8" x 1 1/4" x 1 1/2"	Flared	GP	Gray	CG-50,-80,-82, V-90, VR-7000	VR1703	267.99	GV-825		
		8" x 1 1/4" x 1 1/2"	Flared	S	White	CG-50,-80,-82, V-90, VR-7000	Goodson Spec	174.49	GV-821		
		8" x 1 1/4" x 1 1/2"	Flared	T	Green	CG-50,-80,-82, V-90, VR-7000	VR1704	187.99	GV-827		
	Stem	8" x 1 1/4" x 1 1/2"	Flared	GP	Ruby	CG-80, CG-82, V-90, VR-7000	VR1701	157.99	GV-824		
Kwik-Way	Valve	4 1/2" x 7/8" x 7/8"	Offset	GP	Black	CV, SK, KK, VC, SM, SV, XC	010-0450-10	89.99	GV-257		
		4 1/2" x 7/8" x 7/8"	Offset	S	Gray	CV, SK, KK, VC, SM, SV, XC	010-0457-03	54.99	GV-259		
		5" x 7/8" x 7/8"	Offset	GP	White	EVS, VS	Goodson Spec	91.99	GV-251		
		5" x 7/8" x 7/8"	Offset	GP	Gray	EVS, VS	010-0509-01	87.99	GV-252		
		5" x 7/8" x 7/8"	Offset	T	Green	EVS, VS	010-0508-04	179.99	GV-255		
		7" x 1" x 7/8"	Offset	GP	Gray	SVS, SVS-2	010-0709-00	89.99	GV-280		
		7" x 1" x 7/8"	Offset	CB	Blue	SVS, SVS-2	Goodson Spec	87.99	GV-280-CB		
		7" x 1" x 7/8"	Offset	S	White	SVS, SVS-2	010-0707-50	174.99	GV-281		
		7" x 1" x 7/8"	Offset	T	Green	SVS, SVS-2	010-0708-05	274.99	GV-282		
		7" x 1" x 7/8"	Offset	T	Green	SVS, SVS-2	Goodson Spec	102.99	GV-282A		
		7" x 1" x 7/8"	Offset	GP	Orange	SVS, SVS-2	Radiac Spec	119.99	F372239 Radiac		
		7" x 9/16" x 7/8"	Offset	GP	Ruby	SVS, SVS-2	Radiac Spec	99.99	F377419 Radiac		
		8" x 1 3/8" x 7/8"	Offset	GP	Gray	VL	010-0819-04	157.99	GV-260		
	Stem	3" x 1 1/4" x 5/8"	Cup	GP	Gray	All Models except VL	Radiac Spec	49.99	F336036 Radiac		
		3" x 1 1/4" x 5/8"	Cup	GP	Gray	All Models except VL	010-0300-05	27.99	GV-237		
		3" x 1 1/4" x 5/8"	Cup	CB	Blue	All Models except VL	Goodson Spec	30.99	GV-237-CB		
KO Lee	Valve	5" x 3/4" x 5/8"	Offset	GP	Gray	All models	OV5GH60	131.99	GV-658		
		5" x 3/4" x 5/8"	Offset	S	White	All models	OV5GH80S	96.99	GV-659		
	Stem	4" x 1" x 5/8"	Cup	GP	Gray	K500(C) & K403(C)	RV4KH60	44.99	GV-345		
4" x 1" x 5/8"		Cup	CB	Blue	All	Goodson Spec	41.99	GV-345-CB			
Rottler	Valve	7" x 1" x 7/8"	Offset	GP	Gray	VR-7, VR-10	VTRW-8	89.99	GV-280		
		7" x 1" x 7/8"	Offset	CB	Blue	VR-7, VR-10	Goodson Spec	87.99	GV-280-CB		
		7" x 1" x 7/8"	Offset	T	Green	VR-7, VR-10	VTRW-7	274.99	GV-282		
		7" x 1" x 7/8"	Offset	S	White	VR-7, VR-10		174.99	GV-281		
		7" x 1" x 7/8"	Offset	T	Green	VR-7, VR-10	Goodson Spec	102.99	GV-282A		
		7" x 1" x 7/8"	Offset	GP	Orange	VR-7, VR-10	Radiac Spec	119.99	F372239 Radiac		
		7" x 1" x 7/8"	Offset	GP	Ruby	VR-7, VR-10	Radiac Spec	99.99	F377419 Radiac		
		9" x 1 1/4" x 1 1/2"	Offset	GP	Orange	VR-9, VR-12		209.99	GV-725		
		9" x 1 1/4" x 1 1/2"	Offset	S	Pink	VR-9, VR-12		169.99	GV-726		
		9" x 1 1/4" x 1 1/2"	Offset	T	Green	VR-9, VR-12		179.99	GV-727		
		9" x 1 1/4" x 1 1/2"	Offset	S	Ruby	VR-9, VR-12	Nitrite Coated Diesel	194.99	GV-728		
			Stem	3" x 1 1/4" x 5/8"	Cup	GP	Gray	VR-7, VR-10	VTRW-9	27.99	GV-237
				3" x 1 1/4" x 5/8"	Cup	CB	Blue	All Models except VL	Goodson Spec	30.99	GV-237-CB
3" x 1 1/4" x 5/8"	Cup			GP	Gray	VR-7, VR-10	Radiac Spec	49.99	F336036 Radiac		
100 x 50 x 20mm	Cup			GP	White	VR416, VR-516, VTRW-3	7606	78.99	GV-928		

Colors may vary due to manufacturing processes. All valve refacing wheels are guaranteed for 1 year from original purchase date.



Valve Refacing Wheels

Colors may vary due to manufacturing processes. All valve refacing wheels are guaranteed for 1 year from original purchase date.



To Fit	Use	Dia x Ht x Arb	Shape	Type	Color	Fits Models	OE No.	Jobber	Order No.	
Skil	Valve	5" x 3/4" x 5/8"	Offset	GP	Gray	All models	7556/VW80	\$131.99	GV-658	
	Snap-On	5" x 3/4" x 5/8"	Offset	S	White	All models	VW80S	96.99	GV-659	
Sioux™	Stem	4" x 1" x 5/8"	Cup	GP	Gray	All but Skil 491	7557/VR2M89	44.99	GV-345	
		4" x 1" x 5/8"	Cup	CB	Blue	All but Skil 491	Goodson Spec	41.99	GV-345-CB	
	Valve	4" x 1" x 5/8"	Offset	CB	Blue	All but 680, 682, 285, 956	Goodson Spec	37.99	GV-146-CB	
		4" x 1" x 5/8"	Offset	GP	Gray	All but 680, 682, 285, 956	78SP	49.99	GV-147	
		4" x 1" x 5/8"	Offset	GP	Black	All but 680, 682, 285, 956	78E	81.99	GV-148	
		4" x 1" x 5/8"	Offset	S	Ruby	All but 680, 682, 285, 956	Goodson Spec	39.99	GV-144	
		4" x 1" x 5/8"	Offset	T	Green	All but 680, 682, 285, 956	Goodson Spec	68.99	GV-150	
		5" x 1" x 5/8"	Offset/20°	GP	Pink	Thor 299 & 300	Goodson Spec	55.99	GV-156	
		7" x 1 1/16" x 1 3/4"	Str./15°	GP	Orange	680, 956, 2001 & 2075	Goodson Spec	83.99	GV-270	
		7" x 1 1/16" x 1 3/4"	Str./15°	CB	Blue	680, 956, 2001 & 2075	Goodson Spec	63.99	GV-270-CB	
		7" x 1 1/16" x 1 3/4"	Str./15°	S	White	680, 956, 2001 & 2075	177	89.99	GV-271	
		7" x 1 1/16" x 1 3/4"	Str./15°	T	Green	680, 956, 2001 & 2075	174	197.99	GV-272	
		7" x 1 1/16" x 1 3/4"	Str./15°	GP	Ruby	2001, 2075, 680 & 956	Radiac Spec	59.99	A379613 Radtec	
		7" x 1 1/16" x 1 3/4"	Str./15°	T	Green	2001, 2075, 680 & 956	Radiac Spec	68.99	A340229 Radtec	
		Stem	4" x 1" x 5/8"	Cup	GP	Gray	All but 682 & 685	81 (73533)	44.99	GV-345
4" x 1" x 5/8"	Cup		CB	Blue	All but 682 & 685	Goodson Spec	41.99	GV-345-CB		
Sunnen® (TA) S&D	Valve	6" x 1 1/16" x 3/4"	Flared	GP	Black	VR6500, all S&D	Sunnen Spec	175.00	VR602	
		6" x 1 1/16" x 3/4"	Flared	GP	Black	VR6500, all S&D	VR602	209.99	GV-766	
		6" x 1 3/8" x 3/4"	Flared	T	Black	VR6500, all S&D	Sunnen Spec	162.00	VR603	
		6" x 1 3/8" x 3/4"	Flared	S	Black	VR6500, all S&D	Sunnen Spec	175.00	VR604	
		6" x 1 3/8" x 3/4"	Flared		Black	VR6500, all S&D	Sunnen Spec	329.99	VR605	
		6" x 1 3/8" x 3/4"	Cup		Black	TR6700 Tappet Grinder	Sunnen Spec	329.99	VR606	
		6" x 1 3/8" x 3/4"	Flared	GP	Black	TR6700	Sunnen Spec	229.99	VR607	
		6" x 1 3/8" x 3/4"	Flared	GP	Gray	VR6500	Radiac Spec	174.99	F345291 Radtec	
		6" x 1 3/8" x 3/4"	Flared	GP	Black	VR7000, VR8000	Sunnen Spec	280.00	VR1702	
		6" x 1 3/8" x 3/4"	Flared		Black	VR7000, VR8000	Sunnen Spec	279.99	VR1703	
		6" x 1 3/8" x 3/4"	Flared	T	Gray	VR7000, VR8000	Sunnen Spec	266.00	VR1704	
		Stem	5" x 1 3/8" x 3/4"	Cup	S	White	VR6500, all S&D	Sunnen Spec	139.99	VR601
			6" x 1 3/8" x 3/4"	Cup	GP	Black	VR7000, VR8000	Sunnen Spec	285.00	VR1701
5" x 1 1/2" x 3/4"	Cup		S	White	VR6500, all S&D	VR601	117.99	GV-755		
Winona	Valve	5" x 3/4" x 5/8"	Off./Bev.	GP	Gray	E, Y, YW, X, XA	75399	131.99	GV-658	
		5" x 3/4" x 5/8"	Off./Bev.	S	White	K500HM, K403CM	75400	96.99	GV-659	
Norman	Stem	4" x 1" x 5/8"	Cup	GP	Gray	All but 500 & CRW	40352	44.99	GV-345	
		4" x 1" x 5/8"	Cup	CB	Blue	All but 500 & CRW	Goodson Spec	41.99	GV-345-CB	

Colors may vary due to manufacturing processes. All valve refacing wheels are guaranteed for 1 year from original purchase date.

Mineral Based Valve Grinding Oil

- Long-lasting
- Cools while grinding
- Removes particles for a better finish
- Inhibits rust
- Prevents rancidity, foaming & deposits



Quantity	Jobber	Order No.
1 gallon / 3.79 L	\$ 44.99	VGO-10
5 gallons / 18.93 L	199.99	VGO-50

Severe Duty Mineral Based Valve Refacer Oil For Titanium, Inconel®, Stainless Steel & Stellite

- Mineral Based
- Includes additives to improve cutting performance under high pressure



Size	Jobber	Order No.
1 gallon / 3.79 L	\$ 64.99	VGO-SD10
5 gallons / 18.93 L	264.99	VGO-SD50

CYLINDER HEAD REBUILDING
CLEANING, ASSEMBLY & SAFETY
SHORT BLOCK REBUILDING
FLYWHEEL GRINDING
CRANKSHAFT/ FLYWHEEL GRINDING
MISCELLANEOUS TOOLS & SUPPLIES
BRAKE SERVICE TOOLING
MEASURING TOOLS
V-TWIN & METRIC HARD PARTS



"In addition to the wide selection of tools and supplies found in this catalog, we have access to hundreds more hard-to-find tools. If you're looking for a special tool, call us and we'll help you find it."

- Cheryl, Goodson Purchasing, 2 years of service

CYLINDER HEAD
REBUILDING



Replacement Belts For Kwik-Way Valve Refacers

Application	Machine	Jobber	Order No.
1 Spindle Belt 14.5" L "O" Ring - 1 Pr.	SVS II	\$21.99	000-2303-62
2 Chuck Belt 10" Cog, 50 tooth	SVS II	25.99	001-1899-90
3 Spindle Belt 18" Serpentine	SVS	43.99	001-1905-20
4 Chuck Belt 12" Cog, 60 tooth	SVS or VS	29.99	001-1899-99
5 Spindle Belt 16" V-Belt	VS	25.99	001-1900-67
6 Chuck Belt 19" 120 tooth	VS	33.99	001-1900-75

Replacement Chuck Balls For Kwik-Way Valve Refacers

- Measure chuck ball diameter before ordering to ensure correct replacement • 6 per set

Diameter	Jobber	Order No.
1/2"	\$54.99	010-2101-27
17/32"	47.99	010-2101-35

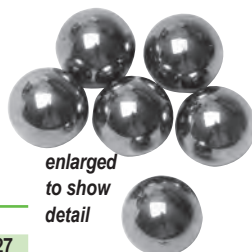

enlarged
to show
detail

CLEANING,
ASSEMBLY & SAFETY

SHORT BLOCK
REBUILDING

CRANKSHAFT/
FLYWHEEL GRINDING

MISCELLANEOUS
TOOLS & SUPPLIES

BRAKE SERVICE
TOOLING

MEASURING
TOOLS

V-TWIN & METRIC
HARD PARTS



Replacement Bearing Cap for Sioux™ 1710 Electric Driver

- Order No. **SX-23694**
Jobber \$69.99

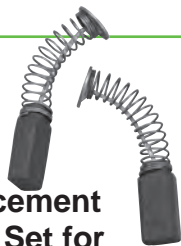

Replacement Brush Set for Sioux™ 1710 Electric Driver

- Carbon brushes for armature
- Measure 3/8" x 1/2"
- Order No. **SX-18004**
Jobber \$33.99

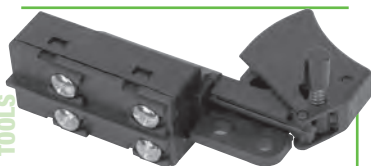

Replacement Switch for Sioux™ 1710 Electric Driver With Plastic Handle

- 125/250 VAC or 125VDC
- 2 Pole • Measures 1.87"L x 0.875"W x 1.07"H
- Order No. **SX-18204**
Jobber \$39.99



Replacement Bearing Cap for Sioux™ 1792 Pneumatic Driver

- Order No. **SX-33970**
Jobber \$69.99

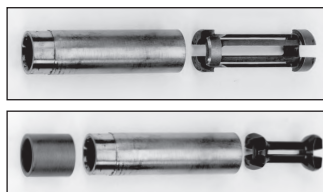

◀ Collet is
unavailable
from OE

◀ Replace with
two-piece set

Collet for Black & Decker™ Valve Refacers

- Two-piece set replaces the Black & Decker Twin Grip collet (no longer available)
- Remove the damaged, worn or broken collet and replace with this set
- Accommodates 1/4" (6.35mm) to 3/8" (9.53mm) valve stems
- Order No. **BVR-38** Jobber \$249.99

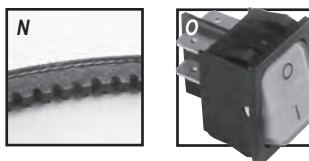
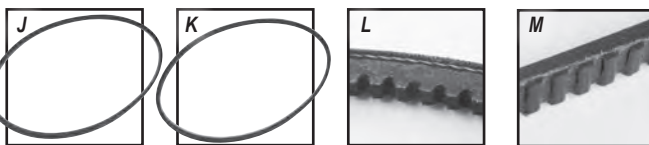
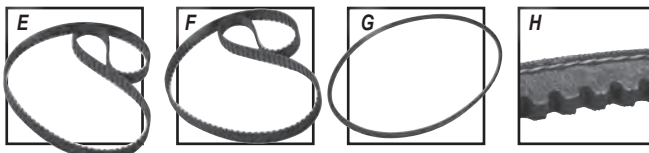
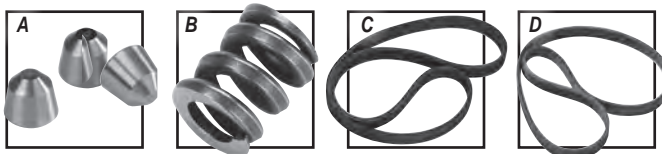

special
order Many more
replacement
parts available

Replacement Parts for Sioux™ Valve Refacers

Description	Fits Model No.	Jobber	Order No.
A- Chuck Balls (3 pc.)	680, 2075	\$266.99	24185
B- Chuck Springs (9 Pc.)	680, 2075	144.99	SX-53615
C- Spindle Belt 28"x1/2" 5 groove	2075	41.99	SX-65117
D- Serpentine 29"x1/2" 5 grooves	680	20.99	SX-14471
E- Cog Style 24"x1/2" 120 teeth	680	19.99	SX-14467
F- Chuck Belt 23"x3/8", 115 teeth	2075	13.99	SX-14473
G- Replacement Belt for Grinding Head Fits Serial #s up to 34999 (2 belts)	645	14.99	SX-14400
H- Chuck Belt Fits Serial #s 34999 & up (also coolant pump belt for #s 35217 & up).	645	13.49	SX-14401
J- Belt for Motor Shaft; Fits Serial #s up to 34999	645	13.49	SX-14402
K- Coolant Pump Belt; Fits Serial #s 34999-35216	645	13.49	SX-14403
L- Replacement Belt for Grinding Head; Fits Serial #s 35000-58700	645	13.49	SX-14453
M- Replacement Belt for Grinding Head; Fits Serial #s 58701 & up	645	47.99	SX-14461
N- Belt for Motor Shaft; Fits Serial #s 35000 & up	645	46.99	SX-14445
O- Replacement Switch (1100V, AC)	2001, 2075	60.99	SX-18221

Replacement Parts

CYLINDER HEAD
REBUILDING

CLEANING,
ASSEMBLY & SAFETY

SHORT BLOCK
REBUILDING

CRANKSHAFT/
FLYWHEEL GRINDING

MISCELLANEOUS
TOOLS & SUPPLIES

BRAKE SERVICE
TOOLING

MEASURING
TOOLS

V-TWIN & METRIC
HARD PARTS

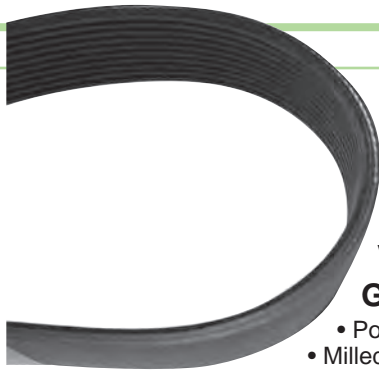

Replacement V-Belts for Sunnen® VGS-20 Seat & Guide Machine

- Poly V-Belts
- Milled construction
- Shippable worldwide

Application	Length	Replaces OE#	Jobber	Order No.
Drive	22"	PDB-310A/ST-467X	\$31.99	VGS-20-22
Countershaft	30"	PDB-309A/ST-467W	43.99	VGS-20-30

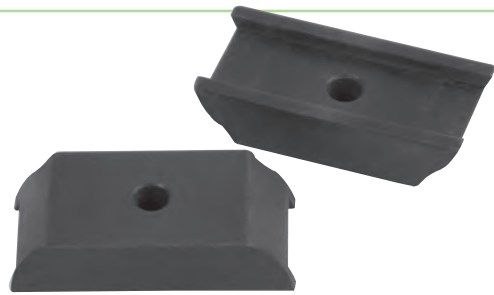

Valve Refacer Steady Rest Shoes for Sunnen® VR-7000 & VR-8000

- Sold by the pair
- Order No. **SUN-1202A** Jobber \$45.99

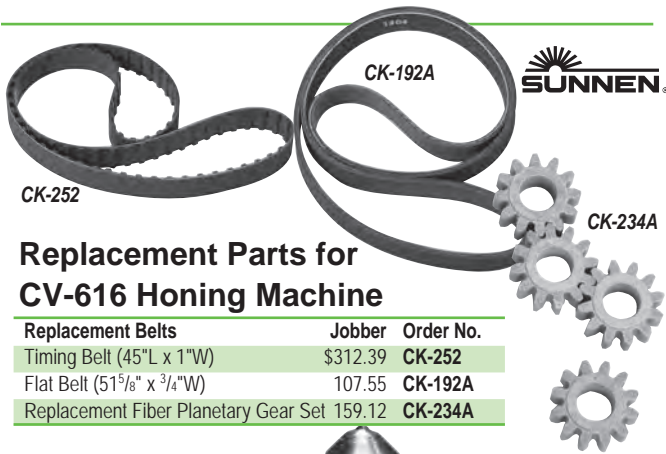

Replacement Parts for CV-616 Honing Machine

Replacement Belts	Jobber	Order No.
Timing Belt (45"L x 1"W)	\$312.39	CK-252
Flat Belt (51 ⁵ / ₈ " x 3 ¹ / ₄ "W)	107.55	CK-192A
Replacement Fiber Planetary Gear Set	159.12	CK-234A

Sunnen VR-6500 Valve Refacer Replacement Belts

- 2 sizes available
- Shippable worldwide

Belt Type	Length	OE Number	Jobber	Order No.
Drive Belt	11"	PDB-305A	\$15.99	VR-6500-11
Jack Shaft Belt	17"	PDB-306A	15.99	VR-6500-17
Splindle Belt	23"		51.99	VR-6500-23

Diamond dressers shown at approximately actual size



Diamond Dresser Tools for Common Valve Refacers

• Select from Standard or Premium Grade • See the complete assortment of diamond dresser tools on pages 114 and 115.

Machine	Description	Carat	Jobber	Standard	Jobber	Premium
Valve Refacers	B&D, Skil, Sioux™, Thor, VanDorn, WVN	3/8" x 1 5/8"	1/5	\$46.49	G-1	\$89.99 G-1P
	Kwik-Way, Tobin Arp (S&D)	5/16" x 2 1/2"	1/5	47.99	G-3	— —
	Kwik-Way, Valve Master (1714)	1/2" x 3 1/4" 20NF	1/5	49.99	G-4	— —
	Sioux™ (1713, 1715), IDL, WVN (CG50, CG80)	3/8" x 2 3/4" 24NF	1/5	49.99	G-5	89.99 G-5P
	IDL, WVN (CG50, CG80)	3/8" x 3 1/4" 24NF	1/5	53.99	G-80	— —
	US	7/16" x 2"	1/5	49.99	G-6	— —
	Skil (Talent)	5/16" x 2 1/4" 18NC	1/5	49.99	G-9	— —
	Kwik-Way	7/16" x 2 3/4" 20NF	1/5	46.99	G-17	89.99 G-17P



"I make sure all Goodson products are packaged properly and include instructions and other important information for you."

- Craig Goodson Receiving - 9 years of service

tech tips

from the techxperts™
For best results,
limit speed to
175 RPM

**High Speed Steel
Core Drill/Reamers**

- Save time – drill and ream in a single pass
- Top-quality, high speed steel
- Prepares the guide bore for standard OD valve guide inserts
- Several shank designs to fit most Seat & Guide machines
- For best results limit speed to 175 RPM

Fits	Size	mm	Jobber	Order No.
Peterson and K.I.	.375" x .500"	9.5x12.7	\$219.99	CDR-6197G
½" round shank				
Serdi	.275" x .437"	7.0x11.1	\$219.99	CDR-7192G
⅝" with flat				
	.275" x .500"	7.0x12.7	219.99	CDR-7193G
	.312" x .437"	7.9x11.1	219.99	CDR-7194G
	.312" x .500"	7.9x12.7	219.99	CDR-7195G
	.343" x .500"	8.7x12.7	219.99	CDR-7196G
	.375" x .500"	9.5x12.7	219.99	CDR-7197G
Cobalt Core Drills/	.275" x .437"	7.00x11.1	219.99	CDR-274-CB
Reamers	.275" x .500"	7.00x12.7	219.99	CDR-275-CB
½" round shank				
	.311" x .5628"	7.90x14.3	219.99	CDR-563-CB
	.312" x .500"	7.92x12.7	219.99	CDR-312-CB
	.343" x .500"	8.71x12.7	219.99	CDR-343-CB
	.373" x .625"	9.47x16.5	219.99	CDR-625-CB
	.375" x .500"	9.53x12.7	219.99	CDR-375-CB

High Speed
Steel Core Drill/
Reamers are
62 to 64 Rc

Steam-Oxide
Coating for Chip
Lubricity



**sized for
diesel**



**Valve Guide Tooling
For 5.9 L, 24 Valve, 7mm Cummins**

- To replace integral guides used in this diesel cylinder head
- Replacement guides are .502/.511" stepped to use with OE or replacement seals below

Description	Jobber	Order No.	Includes
Complete Kit	\$467.99	CVG-KIT	▼
Tooling Kit Only	349.99	CVG-59KIT	▼
A Core Reamer (.426" pilot, .485" shank)	179.99	CCR-59	1 1
B Core Drill (7mm pilot, .429" shank)	179.99	CCD-59	1 1
C Guide Driver (7.0mm)	27.99	PHL-2235-G	1 1
D Cast Iron Valve Guide (Exhaust)	4.99	CIG-3022	12
E Cast Iron Valve Guide (Intake)	4.99	CIG-3021	12
F Exhaust Seals (12 pk.)	15.99	CVS-59E	1
G Intake Seals (12 pk.)	15.99	CVS-59i	1

tech tips

from the techxperts™ This application requires you to perform all machining and guide installation from the spring side of the head.

CYLINDER HEAD REBUILDING
CLEANING, ASSEMBLY & SAFETY
SHORT BLOCK REBUILDING
CRANKSHAFT/ FLYWHEEL GRINDING
MISCELLANEOUS TOOLS & SUPPLIES
BRAKE SERVICE TOOLING
MEASURING TOOLS
V-TWIN & METRIC HARD PARTS



Piloted Core Drills and Reamers

- CNC-machined to .0003" T.I.R. or less
- Ideal for any Bridgeport-type (collet driven) machine
- Use dry at 175 to 225 RPM

Piloted Core Drills

- Center accurately in the guide
- Cutting angle prevents the bit from wandering due to irregular guide wear
- Flutes are designed to enlarge bores quickly

Precision Reamers

- Pilot size is carefully matched to the OD of the related core drill
- Assures accurate location of the reamer for smooth, vibration free operation
- Gives proper interference fit to match manufacturer specifications



Find out more about Piloted Core Drills & Reamers. Scan the code at right with your smart phone or other smart device for instant access



High Speed
Steel Core Drill/
Reamers are
65 to 67 Rc

Bronze-Oxide
Coating for
Chip Lubricity



Core Drills					Core Reamers				
	OD	Pilot	OE No.	Jobber	Order No.	OD	OE No.	Jobber	Order No.
DCM Tech,	.4687"	.312"	DP-1550	\$127.99	DPP-1511B	.500"	66-02147, RR-115	\$127.99	DRR-115
Peterson / K.I.									
½" Round									
Sunnen® /	.490"	.312"	VGS-156A	127.99	DTA-2082B	.500"	VGS-162A	127.99	DRT-2097
Tobin-Arp	.490"	.343"	VGS-152A	127.99	DTA-2082	.500"	VGS-162A	127.99	DRT-2097
½" with Flat									
	.490"	.371"	VGS-153A	127.99	DTA-2083	.500"	VGS-162A	127.99	DRT-2097
Universal	.429"	7mm				.4365"	Use for Ford 6.0L Diesel	154.99	FCR-60-1
.429" Round									
	.429"	7mm	sized for diesel			.4375"	Use for Ford 6.0L Diesel	154.99	FCR-60
Shank									
	.429"	7mm				.5000-.5003"	Use for 24V Cummins	179.99	CCR-59
Use Core Drill/Reamers (CDR) in chart above for sizing									
	.511"	8mm				.562"	.500" pilot	179.99	CCR-562B
	.541"	8mm				.550"	Use for 12V, 5.9 Cummins	179.99	CCR-550

Note: For the best performance, Core Drills and Reamers should be used in matched pairs. If you order a drill slightly smaller or larger than the OE specification to fit your machine, please order the matching reamer listed immediately to the right of the drill in the table.

Bronze Reaming Oil

- Prevents build-up • Extends reamer life • Improves valve guide finish

Size	Jobber	Order No.
1 Pint / 473.2mL	\$12.49	BW-303-G
1 Quart / 946.4mL	19.99	BW-303A-G
1 Gallon / 1.893L	43.99	BW-305-G



tech tips For best results always use Carbide Reamers with Bronze Reaming Oil (BW-303A-G)

Extended non-cutting pilot section for easier alignment with the guide

Pilot portion of reamer features 4 flutes to deliver more cutting oil to the work piece

Reamer body features 8 flutes to cut bronze valve guides quickly, accurately and repeatably

tech tips Once used on cast iron, do NOT use on bronze.

Small Reamers for Cast Iron or Bronze

- Premium quality reamers with tough cobalt flutes for long life in cast iron or bronze • Square drive shank
- Use at 200 to 300 RPM
- OAL is 4.50" (nominally)

Inch	mm	Shank Dia.	Drive Dia.	Jobber	Order No.
.1575"	4.00	.152"	.112"	\$ 108.99	MR-4MM
.1771"	4.50	.173"	.112"	108.99	MR-4.5MM
.1968"	5.00	.187"	.138"	108.99	MR-5.0MM
.1980"	5.03	.187"	.136"	108.99	MR-198
.2165"	5.50	.206"	.162"	124.99	MR-5.5MM
.2360"	6.00	.224"	.160"	124.99	MR-6.0MM
.2755"	7.00	.246"	.182"	134.99	MR-7.0MM

Solid Carbide Valve Guide Reamers Specifically Designed For Use Only With Bronze Guides

- Unique 8-flute body design with 4-flute pilot for longer tool life
- Cutting geometry requires less torque to drive the reamer
- More rigid tool construction
- Faster feeds than conventional design
- Non-cutting pilot allows easier alignment with guide
- Simply the best bronze valve guide reamer we've created!
- Use at 300 to 400 RPM • OAL: 6.00" (nominal)
- Pilot measures approximately .005" smaller than cutting diameter

Inch	mm	Jobber	Order No.	Inch	mm	Jobber	Order No.
.1771"	4.50	\$247.99	HGR-4.5MM*	.3115"	7.91	\$247.99	HGR-3115
.1968"	5.00	247.99	HGR-5.0MM*	.3120"	7.92	247.99	HGR-3120
.2165"	5.50	247.99	HGR-5.5MM*	.3141"	7.98	247.99	HGR-3140
.2362"	6.00	247.99	HGR-6MM	.3150"	8.00	247.99	HGR-8MM
.2750"	7.00	247.99	HGR-7MM	.3410"	8.66	247.99	HGR-3410
.2766"	7.03	247.99	HGR-2766	.3420"	8.69	247.99	HGR-3420
.2770"	7.04	247.99	HGR-2770	.3425"	8.70	247.99	HGR-3425
.3110"	7.90	247.99	HGR-3110	.3430"	8.71	247.99	HGR-3430
				.3435"	8.72	247.99	HGR-3435
				.3440"	8.74	247.99	HGR-3440

*Pilot, Flute & Shank Dimensions slightly smaller; call for specific details



High Speed Steel Finish Reamers Exclusively for Cast Iron

Precision size cast iron guides. Piloted and made from the finest tempered steel. With proper care, these reamers will accurately size multiple guides without losing their efficient cutting action. **NOT for hardened or bronze guides.** Use at 400 to 500 RPM. Pilot area measures .012" smaller than cutting diameter.

3/16" Square Drive				
Inch	mm	Jobber	Order No.	
.2165"	5.50	\$62.99	WR-5.5MM-G	
.217"	5.51	62.99	WR-217-G	
.218"	5.54	62.99	WR-218-G	
.236"	6.00	62.99	WR-6MM-G	
.250"	6.35	62.99	WR-250-G	
.256"	6.50	62.99	WR-6.5MM-G	
.260"	6.60	62.99	WR-260-G	
.273"	6.93	62.99	WR-273-G	
.274"	6.96	62.99	WR-274-G	
.275"	6.99	62.99	WR-275-G	
.2755"	7.00	62.99	WR-7MM-G	
.276"	7.01	62.99	WR-276-G	
.277"	7.03	62.99	WR-277-G	
.278"	7.06	62.99	WR-278-G	
.281"	7.14	62.99	WR-281-G	

1/4" Square Drive				
Inch	mm	Jobber	Order No.	
.310"	7.87	\$62.99	WR-310-G	
.311"	7.90	62.99	WR-311-G	
.312"	7.92	62.99	WR-312-G	
.313"	7.95	62.99	WR-313-G	
.314"	7.98	62.99	WR-314-G	
.315"	8.00	62.99	WR-8MM-G	
.316"	8.03	62.99	WR-316-G	
.317"	8.05	62.99	WR-317-G	
.341"	8.66	62.99	WR-341-G	
.342"	8.69	62.99	WR-342-G	
.343"	8.71	62.99	WR-343-G	
.3435"	8.72	62.99	WR-3435-G	
.344"	8.74	62.99	WR-344-G	
.345"	8.76	62.99	WR-345-G	
.346"	8.79	62.99	WR-346-G	
.354"	9.00	62.99	WR-9MM-G	
.355"	9.02	62.99	WR-355-G	
.356"	9.04	62.99	WR-356-G	
.358"	9.09	62.99	WR-358-G	

1/4" Square Drive				
Inch	mm	Jobber	Order No.	
.372"	9.45	\$62.99	WR-372-G	
.373"	9.47	62.99	WR-373-G	
.374"	9.50	62.99	WR-374-G	
.375"	9.52	62.99	WR-375-G	
.376"	9.55	62.99	WR-376-G	
.377"	9.58	62.99	WR-377-G	
.378"	9.60	62.99	WR-378-G	
.379"	9.63	62.99	WR-379-G	
.380"	9.65	62.99	WR-380-G	
.386"	9.80	69.99	WR-386-G	
.394"	10.00	69.99	WR-10MM-G	
.395"	10.03	69.99	WR-395-G	
.405"	10.29	69.99	WR-405-G	
.433"	11.00	69.99	WR-11MM-G	
.436"	11.07	69.99	WR-436-G	
.437"	11.10	69.99	WR-437-G	
.453"	11.51	69.99	WR-453-G	
.472"	12.00	69.99	WR-12MM-G	
.499"	12.67	69.99	WR-499-G	
.500"	12.70	69.99	WR-500-G	

See page 37 for Drive Adaptors

tech tips from the techxperts™

For best results, use high speed steel finish reamers exclusively on cast iron. Ream without oil.

... another satisfied customer

"I have been using the Goodson Hyper-Finish Diamond Valve Guide Hone for years. It makes quick and easy work for valve guide sizing. It will not load up, keeps the guide straight and true and gives great results every time. Best money I've spent on a tool."

- Wes Brown, Cycle-Rama, Inc., Pinellas Park, Florida, Goodson customer since 1999

CYLINDER HEAD REBUILDING

CLEANING, ASSEMBLY & SAFETY

SHORT BLOCK REBUILDING

CRANKSHAFT/ FLYWHEEL GRINDING

MISCELLANEOUS TOOLS & SUPPLIES

BRAKE SERVICE TOOLING

MEASURING TOOLS

V-TWIN & METRIC HARD PARTS



Introduced to the World Market in 2010!

Black Diamond Hyper-Finish™ Valve Guide Sizing System

The **NEW** Black Diamond Hyper-Finish Diamond Valve Guide Sizing System is better than ever. CNC manufactured tooling now has greater accuracy, more durability and better quality. Mandrels are made of black anodized hard plated steel. Not for use on Aluminum Heads.

With this easy-to-use system you can size guides from .193" to .389" (5.00 to 9.90mm) just by switching out mandrels. Mandrels also sold individually. The Drive Head (**HF-100**) fits every size mandrel assembly shown in the chart below, features a quick change set-up and now has an extended reach for more flexibility. Hyper-Finish Tooling is **NOT** interchangeable with the Sunnen® Valve Guide Hone Set (p. 34). Use at 200 RPMs max. **NOTE: BHFS-040 & BHFS-050 are the only replacement abrasives that will fit old style mandrels.**

Size	Range		Mandrel Assembly (abrasive & mandrel)	Abrasive Length	Replacement Abrasive	Replacement Mandrel	Drive Head	Guide Brush
	inch	mm						
5.0mm	.193"-.203"	4.90 - 5.15mm	399.99 BHFM-193C	40mm	BHFS-010	BHFM-193	HF-100	GVP-9N
5.5mm	.212"-.232"	5.40 - 5.90mm	399.99 BHFM-212C	40mm	BHFS-020	BHFM-212	HF-100	GVP-10N
6.0mm	.232"-.253"	5.90 - 6.40mm	399.99 BHFM-232C	40mm	BHFS-020	BHFM-232	HF-100	GVP-10N
6.5mm	.251"-.271"	6.40 - 6.90mm	399.99 BHFM-251C	40mm	BHFS-020	BHFM-251	HF-100	GVP-11N
7.0mm	.271"-.311"	6.90 - 7.90mm	399.99 BHFM-271C	80mm	BHFS-040*	BHFM-271	HF-100	GVP-11N
.312"	.311"-.350"	7.90 - 8.90mm	399.99 BHFM-307C	80mm	BHFS-050*	BHFM-307	HF-100	GVP-1N
.343"	.334"-.374"	8.50 - 9.50mm	399.99 BHFM-344C	80mm	BHFS-050*	BHFM-344	HF-100	GVP-2N
.375"	.350"-.389"	8.90 - 9.90mm	399.99 BHFM-350C	80mm	BHFS-050*	BHFM-350	HF-100	GVP-3N

*Only these replacement abrasives will fit old style mandrels

Jobber \$189.99 \$279.99 \$449.99 \$8.99



Diamond Abrasive produces 25 RA finish in soft guides and 8-10 RA in hardened guides. Every mandrel-abrasive assembly is quality checked to ensure it is true and on size.

Choose from the Standard Master Kit or Build Your Own!

Standard Master Kit includes: Driver Head, 4-Mandrel Assemblies (see chart above), 4-Nylon Valve Guide Brushes (7mm to 3/8") and 8 oz. Diamond Honing Oil.
Order No. **BHF-KIT** Jobber \$1799.99

Custom Kit includes: Driver Head, 4-Mandrel Assemblies (select from chart above), 4-Nylon Valve Guide Brushes (you pick the sizes - see chart above) and 8 oz. Diamond Honing Oil.
Order No. **BHF-KIT-CUSTOM** Jobber \$1799.99



Goodson
exclusive



Adjustable hose lets you direct coolant right where you need it

1/2" diameter holes (18) and 1" diameter holes (2) drilled in the top plate provide ample tool storage

Perforated steel grate lets oil through and can be removed for cleaning

Rolled front edge directs splashed coolant back into the sump

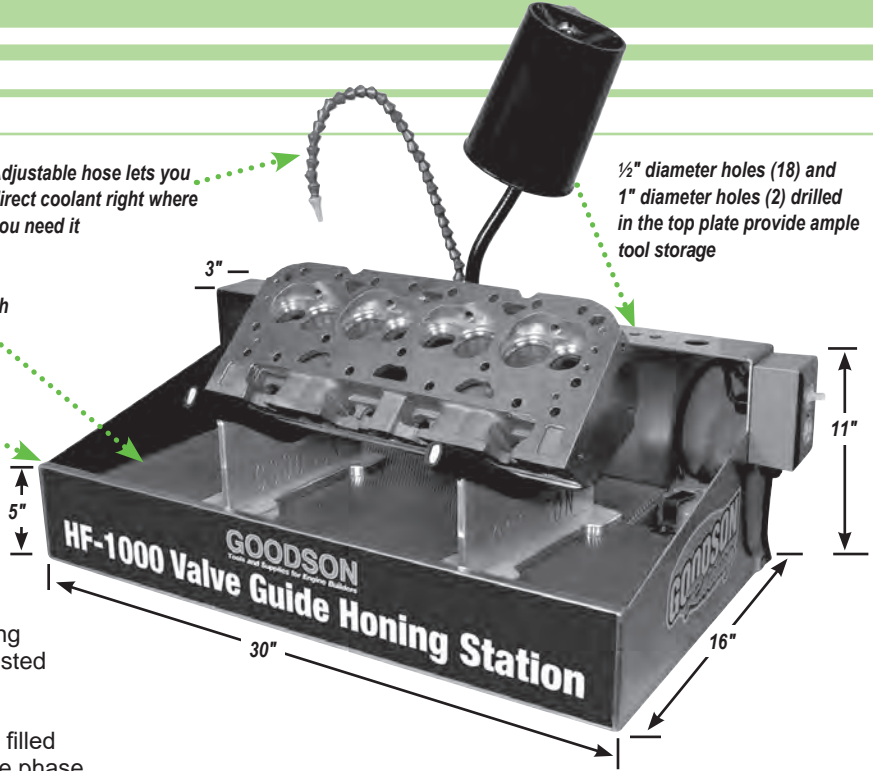

Benchtop Valve Guide Finishing Station

This Goodson designed valve guide finishing station incorporates the features you requested such as:

- Large 5-gallon capacity coolant sump
 - Integral high output pump - 1/150 HP oil filled submersible pump, 115V 60 cycle, single phase heavy-duty motor
 - Aluminum construction for durability and easy cleaning
 - Perforated steel grate allowing used coolant through to recirculate
 - Removable steel grate for easy maintenance
 - Built-in, easy-to-reach storage for tools
- Buy the complete kit and save!**

Description	Jobber	Order No.	Incl.
Complete 110V Valve Guide Finishing Station Kit	\$1329.99	HF-1000KIT	▼
Honing Station Only - 110V	1079.99	HF-1000	x
Universal Head Holders	174.99	HH-200	x
Pump 110V	204.99	HF-PUMP	x
5 Gallons Diamond Honing Oil	257.99	DHO-50	x

Export voltage available, contact Goodson for additional information

3/16" diameter shank pilot

Carbide or High Speed Steel Valve Guide Top Cutters

- Matches Seat & Guide machine pilots

Description	Shank	Jobber	Order No.
Cutters 1 1/16" High-Speed Steel	.500"	\$ 79.99	GFH-100
1 1/16" Carbide	.500"	197.99	GFC-200
1 1/8" High-Speed Steel	.486"	164.99	GFH-300
3/16" (.1875")	.312" (7.93mm)	20.99	GFP-312
Shank Pilots .343" (8.73mm)	.343" (8.73mm)	20.99	GFP-343
.375" (9.53mm)	.375" (9.53mm)	20.99	GFP-375
.437" (11.11mm)	.437" (11.11mm)	20.99	GFP-437
.500" (12.70mm)	.500" (12.70mm)	20.99	GFP-500

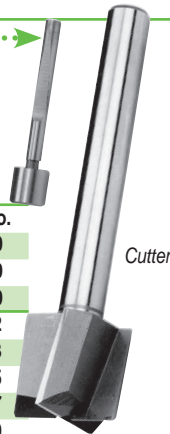

Valve Guide Top Collar

- Supports guide top during machining
- Protects against damage or breakage
- Ideal for high-performance work, and for installing thin-wall liners (pages 38-39)

Size	Range	Jobber	Order No.
.500"	.496" -.504"	\$11.99	VGC-502
.530"	.526" -.534"	12.99	VGC-530
.566"	.562" -.570"	13.99	VGC-566

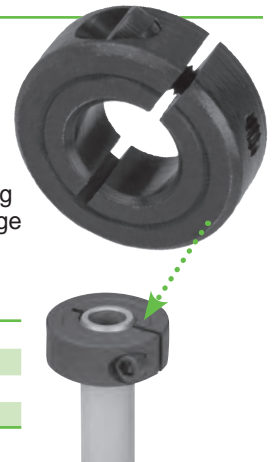

Diamond Honing Oil

- For high pressure honing
- Recommended for use with Black Diamond Valve Guide Sizing System

Size	Jobber	Order No.
8 oz./237mL	\$ 6.99	DHO-8
1 Gallon/3.79L	59.99	DHO-10
5 Gallons/18.93L	257.99	DHO-50



Valve Guide OD Chamfer Tool

- Improve oil deflection
- Universal cutter chamfers any OD from 1/4" to 5/8" (6.35-15.9mm)
- Most precise when used in a Seat and Guide Machine
- Order No. **GCT-35**
Jobber \$164.99



CYLINDER HEAD REBUILDING

CLEANING, ASSEMBLY & SAFETY

SHORT BLOCK REBUILDING

CRANKSHAFT/ FLYWHEEL GRINDING

MISCELLANEOUS TOOLS & SUPPLIES

BRAKE SERVICE TOOLING

MEASURING TOOLS

V-TWIN & METRIC HARD PARTS

full service
...fast



"We take our job of getting your order to you quickly very seriously. We use several different carriers allowing us to get your products to you when you need them at a price you can afford."

- Ashley, Goodson Shipping Department, 3 years of service

CYLINDER HEAD
REBUILDING



Valve Guide Hone Set

- Sets-up fast • Easy to use!
- Produces straight, round holes for top-quality work
- Ideal for high-performance applications
- Use a low RPM, 1/2" drill for driving power (200 RPM max.)
- Silicon-Carbide Roughing & Finishing Stones
- Sunnen® tooling is NOT interchangeable with Goodson Black Diamond Hyper-Finish (page 32)

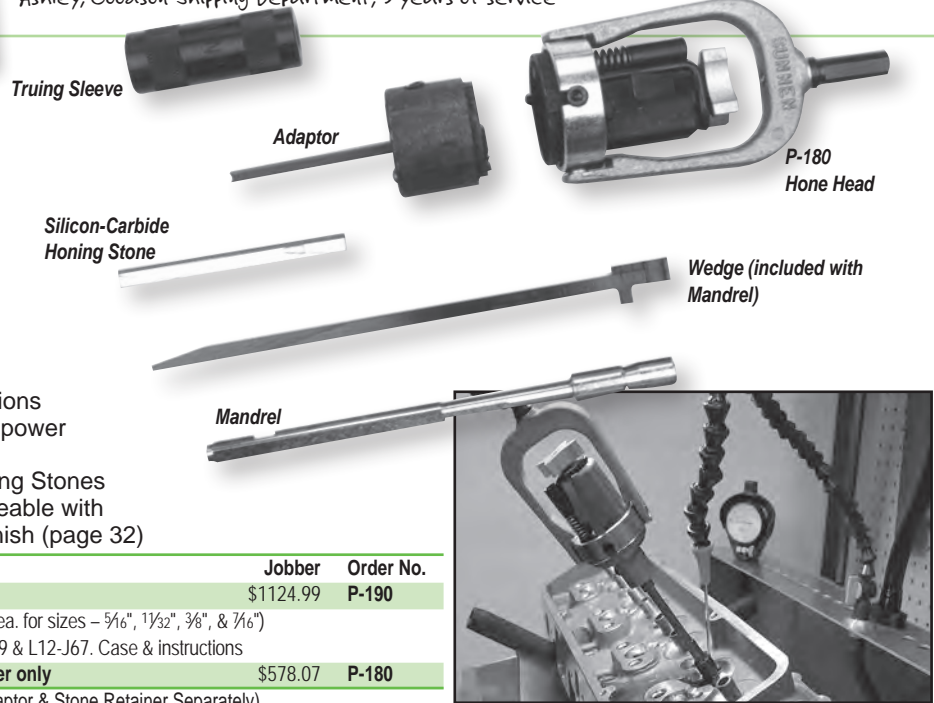

Description	Jobber	Order No.
Sunnen Honal® Valve Guide Hone Set	\$1124.99	P-190
Includes: Head & Driver. Mandrels & Sleeves (1 of ea. for sizes - 5/16", 11/32", 3/8", & 7/16")		
Adaptors: (1) PK10-A & (1) PK12-A. Stones L10-J69 & L12-J67. Case & instructions		
Sunnen Honal® Valve Guide Hone Head & Driver only	\$578.07	P-180
BL Mandrels (Order Mandrel, Sleeve, Stones, Adaptor & Stone Retainer Separately)		

Range		Mandrel		Sleeve		Roughing Stones		Finishing Stones		Adaptor		Stone Retainer		
Size	Inch	mm	Jobber	Order No.	Jobber	Order No.	Jobber	Order No.	Jobber	Order No.	Jobber	Order No.	Jobber	Order No.
3.8mm	.150"-.156"	3.8-3.9	\$59.43	BL5150CS	\$17.62	S150	\$112.53	L5J67 (12)	\$109.25	L5J95 (12)	\$113.49	PSK6-A ‡	\$19.90	LN3025C
4.5mm	.175"-.180"	4.4-4.6	59.43	BL5175CS	17.62	S175	112.53	L5J67 (12)	109.25	L5J95 (12)	113.49	PSK6-A ‡	19.90	LN3025C
5mm	.195"-.200"	4.9-5.1	57.82	BL6-195CS	18.15	S-195	107.64	L6-J47 (12)	107.64	L6-J67 (12)	113.49	PSK6-A ‡	15.77	LN-3087C
5.5mm	.210"-.215"	5.3-5.5	57.82	BL6-210CS	18.15	S-210	107.64	L6-J47 (12)	107.64	L6-J67 (12)	113.49	PSK6-A ‡	15.77	LN-3087C
	.215"-.220"	5.5-5.6	57.82	BL6-215CS	18.15	S-215	107.64	L6-J47 (12)	107.64	L6-J67 (12)	113.49	PSK6-A ‡	15.77	LN-3087C
6mm	.225"-.230"	5.7-5.8	51.90	BL6-225CS	18.15	S-225	107.64	L6-J47 (12)	107.64	L6-J67 (12)	113.49	PSK6-A ‡	15.77	LN-3087C
	.230"-.235"	5.8-6.0	57.82	BL6-230CS	18.15	S-230	107.64	L6-J47 (12)	107.64	L6-J67 (12)	113.49	PSK6-A ‡	15.77	LN-3087C
6.6mm	.235"-.240"	6.0-6.1	57.88	BL6-235CS	18.15	S-235	107.64	L6-J47 (12)	107.64	L6-J67 (12)	113.49	PSK6-A ‡	15.77	LN-3087C
	.245"-.250"	6.2-6.4	54.58	BL8-245AS	19.09	S-245	59.66	L8-J67 (6)	59.66	L8-J67 (6)	113.49	PK8-A	---	---
7mm	.250"-.255"	6.4-6.5	56.58	BL8-250AS	19.09	S-250	59.66	L8-J47 (6)	59.66	L8-J67 (6)	113.49	PK8-A	---	---
	.255"-.260"	6.5-6.6	56.43	BL8-255AS	19.09	S-255	59.66	L8-J47 (6)	59.66	L8-J67 (6)	113.49	PK8-A	---	---
7mm	.270"-.275"	6.8-7.0	56.54	BL8-270AS	19.09	S-270	59.66	L8-J47 (6)	59.66	L8-J67 (6)	113.49	PK8-A	---	---
	.275"-.280"	7.0-7.1	56.54	BL8-275AS	19.09	S-275	59.66	L8-J47 (6)	59.66	L8-J67 (6)	113.49	PK8-A	---	---
5/16" ♦	.308"-.316"	7.8-8.0	58.51	BL10-308AS	19.09	S-308	62.55	L10-J47 (6)	62.55	L10-J69 (6)	113.49	PK10-A	---	---
11/32" ♦	.339"-.347"	8.6-8.8	58.51	BL10-339AS	19.09	S-339	62.55	L10-J47 (6)	62.55	L10-J69 (6)	113.49	PK10-A	---	---
3/8"	.354"-.362"	9.0-9.2	58.47	BL10-354AS	19.09	S-354	62.55	L10-J47 (6)	62.55	L10-J69 (6)	113.49	PK10-A	---	---
3/8" ♦	.370"-.385"	9.4-9.8	61.91	BL12-370AS	26.08	S-370	68.75	L12-J47 (6)	68.75	L12-J67 (6)	113.49	PK12-A	---	---
7/16" ♦	.432"-.447"	11.0-11.4	61.88	BL12-432AS	26.08	S-432	68.75	L12-J47 (6)	68.75	L12-J67 (6)	113.49	PK12-A	---	---

♦ Included in set Order No. P-190 †NOTE: Remove the stone retainer included with the PSK6-A and replace with LN-3087C for valve guide honing

tech tips from the techxperts™ **Ordering Information:** The head and driver are interchangeable with the adaptors. Only one head and driver is required. Mandrels are available to cover all popular sizes. Please select from the parts in the photo above and order per size range desired. We suggest you have an adaptor for each mandrel to save change-over time between sizes.

MEASURING
TOOLS

5 Piece Nylon Bristle Valve Guide Brush Set

- Complete kit includes five popular nylon bristle brush sizes
- Brushes measure from 5/16" to 1/2" diameter x 2 1/2" L
- Overall Length: 12"
- For more sizes see page 64
- Order No. **GVP-SET** Jobber \$44.99

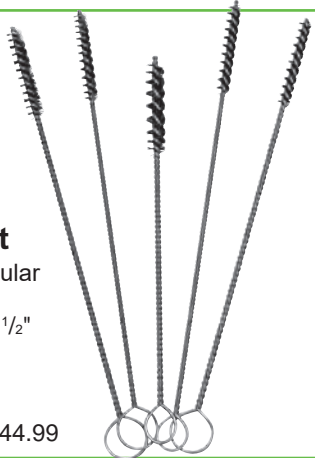

6 Piece Valve Guide Flex-Hone® Set

- Kit includes the most popular sizes for valve guide work
- 240 Grit Silicon-Carbide

6 Pc. Valve Guide Kit	Jobber	Order No.	Incl.
Size	mm	OAL	
1/4"	6.4	8"	\$25.99 VGF-6.4MM x
5/32"	7.0	8"	25.99 VGF-7MM x
5/16"	8.0	8"	25.99 VGF-8MM x
11/32"	9.0	8"	25.99 VGF-9MM x
3/8"	10.0	8"	25.99 VGF-10MM x
7/16"	11.0	8"	25.99 VGF-11MM x

More Valve Guide Flex-Hones® on page 83

Order 3 or more Flex-Hones®, Save 10% off Jobber



V-TWIN & METRIC
HARD PARTS



Valve Guide Replacement

Valve Guide Drivers

- Corrosion-resistant finish 1° negative angle prevents guides from spreading • Rockwell hardness of 45-50
- Pilots are slightly smaller than guide ID for easy removal

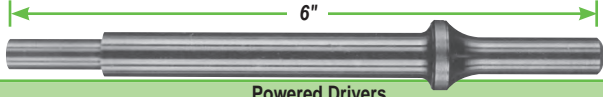

Powered Drivers				
Standard Sizes		Jobber	Order No.	Incl.
4-piece Kit		\$84.99	PH-2226-G	▼
Guide ID /mm	Driver OD	Pilot		
.312" / 7.92	.487" / 12.4	.300" / 7.62	\$22.99	PH-2228A-G
.312" / 7.92	.423" / 10.7	.304" / 7.72	22.99	PH-2228-G
.343" / 8.71	.422" / 10.7	.336" / 8.53	22.99	PH-2229A-G
.343" / 8.71	.487" / 12.4	.337" / 8.56	22.99	PH-2229-G
.372" / 9.47	.487" / 12.4	.367" / 9.32	22.99	PH-2231-G
.437" / 11.10	.612" / 15.5	.429" / 10.90	22.99	PH-2230-G
Metric Sizes		Jobber	Order No.	Incl.
6-piece Kit		\$128.99	PH-2600-G	▼
Guide ID /in.	Driver OD	Pilot		
5.0mm / .196"	9.0 / .355"	4.75 / .187"	\$22.99	PH-2250-G
5.5mm / .217"	10.5 / .412"	5.21 / .205"	22.99	PH-2255-G
6.0mm / .236"	10.5 / .412"	5.72 / .225"	22.99	PH-2260-G
6.6mm / .260"	11.8 / .463"	6.30 / .248"	22.99	PH-2234-G
7.0mm / .275"	11.0 / .432"	6.60 / .260"	22.99	PH-2235-G
8.0mm / .315"	11.7 / .462"	7.80 / .307"	22.99	PH-2236-G
9.0mm / .353"	12.4 / .487"	8.81 / .347"	22.99	PH-2237-G
10mm / .393"	15.5 / .612"	9.82 / .387"	22.99	PH-2238-G
11mm / .433"	15.5 / .612"	10.85 / .427"	22.99	PH-2239-G

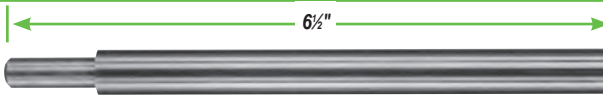

Manual Drivers				
Standard Sizes		Jobber	Order No.	Incl.
4-piece Kit		\$68.99	GP-500A-G	▼
Guide ID /mm	Driver OD	Pilot		
.312" / 7.92	.422" / 10.7	.305" / 7.75	\$20.99	GP-431-G
.312" / 7.92	.487" / 12.4	.302" / 7.67	20.99	GP-531-G
.343" / 8.71	.422" / 10.7	.336" / 8.53	20.99	GP-533-G
.343" / 8.71	.487" / 12.4	.336" / 8.53	20.99	GP-534-G
.372" / 9.47	.487" / 12.4	.367" / 9.32	20.99	GP-537-G
.437" / 11.10	.611" / 15.5	.428" / 10.87	20.99	GP-743-G
Metric Sizes		Jobber	Order No.	Incl.
6-piece Kit		\$101.99	GP-600M-G	▼
Guide ID /in.	Driver OD	Pilot		
6.6mm / .260"	11.7 / .462"	6.22 / .245"	\$20.99	GP-6.6MM-G
7mm / .275"	10.7 / .422"	6.78 / .267"	20.99	GP-7MM-G
8mm / .315"	12.3 / .484"	7.77 / .306"	20.99	GP-8MM-G
9mm / .353"	12.3 / .484"	8.84 / .348"	20.99	GP-9MM-G
10mm / .393"	15.5 / .611"	9.82 / .387"	20.99	GP-10MM-G
11mm / .433"	15.5 / .611"	10.82 / .426"	20.99	GP-11MM-G



Air Hammer

- Delivers 3500 blows per minute
- Weighs 3 lbs.
- .401" tool opening

Description	Jobber	Order No.
Air Hammer	\$87.99	AH-335
Replacement		
Retainer Spring	11.49	AH-5RS

Universal Driver Tool

- Will fit Diesel Guide Drivers at right to increase your reach
 - 4.75" OAL
 - .401" ID
 - Order No. **CL-7333**
- Jobber \$49.99

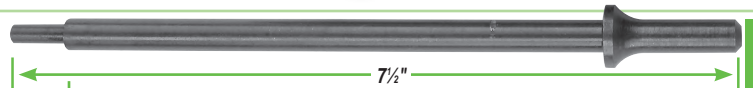

Extra-Long Powered Valve Guide Drivers

- For use with overhead cam heads
- 1° negative angle to prevent guide mushrooming
- Pilots are slightly smaller than guide ID • 7.5" long

Guide ID / in.	Driver OD	Pilot	Jobber	Order No.
4.0mm / .157"	9.0 / .355"	3.80 / .150"	\$27.99	PHL-2240-G
4.5mm / .177"	9.0 / .355"	4.30 / .170"	27.99	PHL-2245-G
5.0mm / .196"	9.0 / .355"	4.75 / .187"	27.99	PHL-2250-G
5.5mm / .217"	10.5 / .412"	5.21 / .205"	27.99	PHL-2255-G
6.0mm / .236"	9.1 / .358"	5.72 / .225"	27.99	PHL-2258-G
6.0mm / .236"	10.5 / .412"	5.72 / .225"	27.99	PHL-2260-G
6.6mm / .260"	11.8 / .463"	6.29 / .248"	27.99	PHL-2234-G
7.0mm / .275"	11.0 / .432"	6.60 / .260"	27.99	PHL-2235-G
7.9mm / .312"	10.7 / .423"	7.72 / .304"	27.99	PHL-2228-G
8.0mm / .315"	11.7 / .462"	7.80 / .307"	27.99	PHL-2236-G
8.7mm / .343"	12.4 / .487"	8.56 / .337"	27.99	PHL-2229-G
9.5mm / .375"	12.4 / .487"	9.32 / .367"	27.99	PHL-2231-G

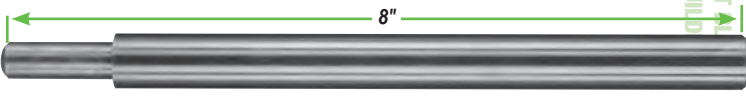

Extra Long Manual Valve Guide Drivers

- 8" OAL • Pilot approximately 1" long

NOTE: Due to the nature of these valve guide drivers, they cannot be warranted against breakage, but are guaranteed for dimensional accuracy.

Guide ID / in.	Driver OD	Pilot	Jobber	Order No.
4.0mm / .157"	9.0 / .355"	3.80 / .150"	\$23.99	GPL-2240-G
4.5mm / .177"	9.0 / .355"	4.30 / .170"	23.99	GPL-2245-G
5.0mm / .196"	9.0 / .355"	4.75 / .187"	23.99	GPL-2250-G
5.5mm / .217"	10.5 / .412"	5.21 / .205"	23.99	GPL-2255-G
6.0mm / .230"	9.1 / .358"	5.72 / .225"	23.99	GPL-2258-G
6.0mm / .236"	10.5 / .412"	5.72 / .225"	23.99	GPL-2260-G

sized for **diesel**

Air-Powered Valve Guide Drivers for Diesel Engines

- Drive guides in from the shoulder instead of from the top
- Installing drivers have the proper recess to drive guides in for the correct installed height
- Remove / Install guides faster – no measuring necessary
- For most standard pneumatic tools

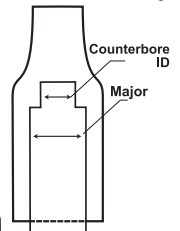
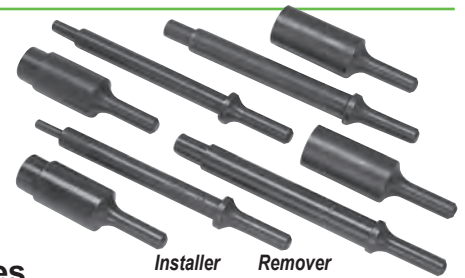

Application	Installer Major/ Counter Bore ID	Order No.	Remover Shank/Pilot OD	Order No.
Cummins	.752" / .503"	DVG-Ci	.595" / .450"	DVG-CR
Cummins 8.3. 6CT	.552" / —	DVG-8.3	.491" / .304"	DVG-71R
Caterpillar 3116	.515" / .475"	DVG-3116	.491" / .304"	DVG-71R
Caterpillar 3126	—	—	.595" / .354"	DVG-3468R
Caterpillar 3406-3408	.709" / —	DVG-3468i	.595" / .354"	DVG-3468R
Detroit GMC 53	.502" / .421"	DVG-53i	—	—
Detroit GMC 71/92	—	—	.491" / .304"	DVG-71R
International DT 466	—	—	.595" / .354"	DVG-3468R

Jobber \$38.99

Jobber \$38.99



"We work hard to have the right stock at the right price at the right time so you get your orders on time."

- Nancy, Goodson Inventory Fulfillment Manager, 29 years of service

CYLINDER HEAD
REBUILDING



tech tips
from the techxperts™

Install guides to same height every time!

CLEANING,
ASSEMBLY & SAFETY

SHORT BLOCK
REBUILDING

CRANKSHAFT/
FLYWHEEL GRINDING

MISCELLANEOUS
TOOLS & SUPPLIES

BRAKE SERVICE
TOOLING

MEASURING
TOOLS

V-TWIN & METRIC
HARD PARTS

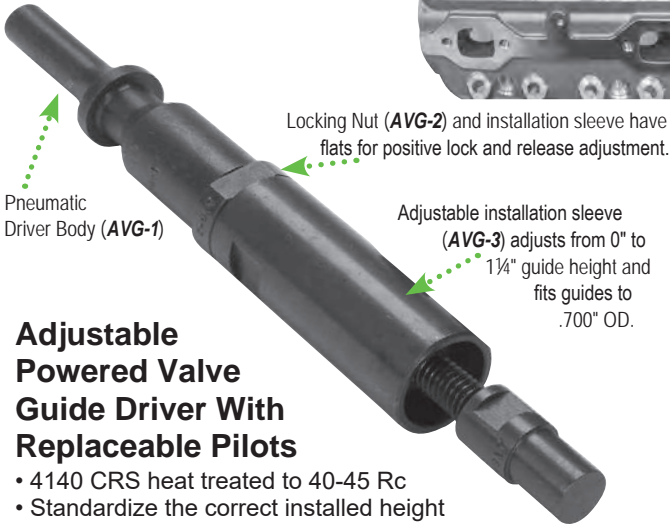

Locking Nut (AVG-2) and installation sleeve have flats for positive lock and release adjustment.

Pneumatic Driver Body (AVG-1)

Adjustable installation sleeve (AVG-3) adjusts from 0" to 1 1/4" guide height and fits guides to .700" OD.

Adjustable Powered Valve Guide Driver With Replaceable Pilots

- 4140 CRS heat treated to 40-45 Rc
- Standardize the correct installed height on one guide then repeat it on all others
- Screw-in pilots with 5/16" - 18 threads • 6 1/2" overall length

Description	Jobber	Order No.	Includes
Standard Valve Guide Driver Kit	\$159.99	AVG-STD	▼
Metric Valve Guide Driver Kit	159.99	AVG-MM	▼
Pneumatic Body Only 5/8" - 18 thread	57.99	AVG-1	x x
Installation Sleeve	28.99	AVG-3	x x
Locking Nut	12.99	AVG-2	x x
Replaceable Pilots	Diameter		
	.312"	\$26.99 AVG-312	x
	.343"	26.99 AVG-343	x
	.372"	26.99 AVG-372	x
	.437"	26.99 AVG-437	x
	5.0mm	26.99 AVG-5MM	x
	5.5mm	26.99 AVG-55MM	
	6.0mm	26.99 AVG-6MM	x
	7.0mm	26.99 AVG-7MM	x
	8.0mm	26.99 AVG-8MM	x
	9.0mm	26.99 AVG-9MM	



Use thread locker on pilot to resist loosening while in use.



Watch for the Made In America symbol throughout the catalog

This symbol indicates products manufactured within the United States. We are proud to feature products made by US manufacturers, including many right in our own backyard of Winona, Minnesota.

Valve Guide OD Machining Tool

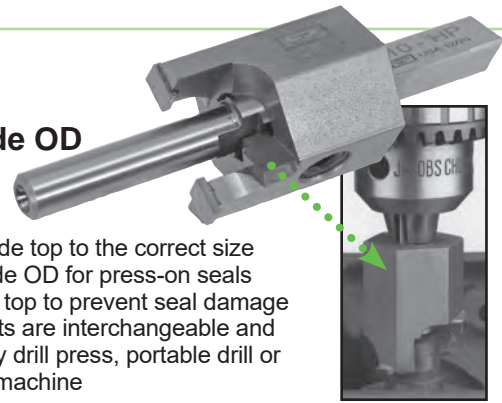

- Faces the guide top to the correct size
- Sizes the guide OD for press-on seals
- Chamfers the top to prevent seal damage
- Cutters & pilots are interchangeable and chuck into any drill press, portable drill or seat & guide machine

Individual Cutters

Guide OD	Order No.
.415"	10.5 VSC-415
.428"	10.8 VSC-428
.475"	12.1 VSC-475
.495"	12.6 VSC-495
.500"	12.7 VSC-500
.530"	13.5 VSC-530
.562"	14.3 VSC-562
.625"	15.9 VSC-625
Jobber ea.	\$109.99

Pilots

Guide ID	Order No.
.275"	7.0 VP-7MM
.312"	7.9 VP-312
.343"	8.7 VP-343
.375"	9.5 VP-375
Jobber ea.	\$42.99

Cutter and Pilot Assemblies

Guide OD	Pilot Size	Order No.
.415"	10.5 .312" 7.9	VSC-415312
.420"	10.7 .312" 7.9	VSC-420312
.428"	10.9 .312" 7.9	VSC-428312
.475"	12.1 .312" 7.9	VSC-475312
.475"	12.1 .343" 8.7	VSC-475343
.500"	12.7 .275" 7.0	VSC-500275
.500"	12.7 .312" 7.9	VSC-500312
.500"	12.7 .343" 8.7	VSC-500343
.500"	12.7 .375" 9.5	VSC-500375
.530"	13.5 .312" 7.9	VSC-530312
.530"	13.5 .343" 8.7	VSC-530343
.530"	13.5 .375" 9.5	VSC-530375
.562"	14.3 .343" 8.7	VSC-562343
.562"	14.3 .375" 9.5	VSC-562375
.625"	15.9 .375" 9.5	VSC-625375
Jobber ea.		\$136.99

tech tips
from the techxperts™

Right Hand Rotation Only.

For best results, keep your RPM about the same as your hone RPM, use the same rate of speed and number of strokes per minute.



Ultra-Finish Plateau Valve Guide Soft Hones

- Use AFTER guide honing to remove microscopic peaks and scuffs without enlarging the guide ID
- Abrasive impregnated nylon bristles
- Use with liberal amounts of honing oil
- Not interchangeable with Flex-Hones®
- Use with your portable drill or seat and guide machine

Hole Diameter	Hone	Head	Overall	Jobber	Order No.
in	mm	Dia.	Length	Length	
.2187"	5.5	.241"	1.00"	4.00"	\$12.99 UF-5.5MM
.2500"	6.4	.275"	1.25"	4.50"	12.99 UF-6.4MM
.2813"	7.0	.309"	1.25"	4.50"	12.99 UF-7MM
.3125"	8.0	.343"	1.25"	4.50"	12.99 UF-8MM
.3437"	9.0	.378"	1.25"	4.50"	12.99 UF-9MM
.3750"	10.0	.413"	1.25"	4.50"	12.99 UF-10MM

NOTE: Larger size Ultra-Finish hones on page 92

tech tips
from the techxperts™
Use with Knurlube

Knurling Arbors

- Piloted for positive centering
- Use by hand or with electric drill & speed reducer
- **Not for use on chilled, hardened or bronze guides**

Inch	mm	Drive	Jobber	Order No.
.236"	6.00	.1875"	\$108.99	WKA-6MM-G
.275"	7.00	.1875"	108.99	WKA-7MM-G
.312"	7.92	.2500"	108.99	WKA-312-G
.343"	8.71	.2500"	108.99	WKA-343-G
.375"	9.53	.2500"	108.99	WKA-375-G
1 Quart Knurlube (946.6mL)			22.99	WLB-47-G

Electric Drill Drive Adaptors For Knurling Arbors and/or Reamers

Use **WSR-41-3-G** (¼" sq.) and **WSR-41-4-G** (⅜" sq.) include the **WSR-41-7-G** (⅜" drill adaptor). Clamp ⅜" drive in drill to drive reamers directly.

Description	Jobber	Order No.
A Drill Adaptor for ⅜" drill	\$10.99	WSR-41-7-G
B ¼" Adaptor for arbors/reamers larger than .281"	19.99	WSR-41-3-G
C ⅜" Adaptor for arbors/reamers .281" or smaller	19.99	WSR-41-4-G
D Slip on Adaptor (converts WSR-41-3-G to .1875")	44.99	WSR-41-5-G

Knurlube

- High pressure lube prevents tool damage
- Extends knurler life by reducing friction and arbor wear

Size	Jobber	Order No.
8 oz. / 236.6mL	\$12.99	WLB-46-G
32 oz. / 946.4mL	22.99	WLB-47-G

Bronze Reaming Oil

- Prevents build-up
- Extends reamer life
- Improves valve guide finish

Size	Jobber	Order No.
16 oz. / 473.2mL	\$12.49	BW-303-G
32 oz. / 946.4mL	19.99	BW-303A-G
1 Gal. / 1.893L	43.99	BW-305-G

Valve Guide OD Knurling Tool

- Enlarge guides to fit bore
- Ideal for rare metric sizes and aluminum heads with damaged guide bores
- Works on most materials, **except** chilled or hardened guides

Description	Jobber	Order No.
Complete Tool	\$69.99	VGK-25
Replacement Knurling Wheel	25.99	VGK-25W
Replacement Knurling Rollers (2)	11.99	VGK-25R

tech tips
from the techxperts™

Hold guide firmly in Vise, Drill Press or Seat & Guide machine; tighten the knurler and turn it around the guide **by hand**. Increase OD up to .002".

The more guides you buy, the more you save!

- Buy 25 - 50 guides, save 10% off jobber.
- Buy 51+ guides, save 15% off jobber (mix & match sizes)



Harley valve guides on page 134

Cast Iron False Valve Guides

Universal Applications

ID	OD	Length	Job. 1+	Job. 25+	Job. 51+	Order No.
.312"	.439"	2.281"	\$4.99	\$4.49	\$4.24	CIG-312
.342"	.502"	3.062"	4.99	4.49	4.24	CIG-342
.372"	.502"	2.750"	4.99	4.49	4.24	CIG-372
.343"	.564"	2.750"	4.49	4.04	3.82	OG-343
.373"	.564"	2.750"	4.49	4.04	3.82	OG-373

24 Valve 7mm Cummins Diesel (.511" seal surface) see tooling, page 30

ID	OD	Length	Job. 1+	Job. 25+	Job. 51+	Order No.
Intake	.275"	.502"	1.940"	\$4.99	\$4.49	\$4.24 CIG-3021
Exhaust	.275"	.502"	2.020"	4.99	4.49	4.24 CIG-3022

Ford 6.0L (.513" x .659" seal surface) see tooling, page 30

ID	OD	Length	Job. 1+	Job. 25+	Job. 51+	Order No.
	.275"	.4395"	2.332"	\$4.99	\$4.49	\$4.24 CIG-3055
7.3 Powerstroke Use with Core Drill Reamer CDR-563-CB, page 30						
	.3146"	.5652"	2.440"	\$4.99	\$4.49	\$4.24 CIG-8476

Manganese Bronze False Valve Guides

Universal Applications

ID	OD	Length	Job. 1+	Job. 25+	Job. 51+	Order No.
.311"	.439"	3.062"	\$6.79	\$6.11	\$5.77	BVG-311
.343"	.502"	2.375"	6.99	6.29	5.94	BVG-343
.372"	.502"	2.375"	6.99	6.29	5.94	BVG-372

Cast Iron and Manganese Bronze Valve Guides for Harley-Davidson on page 134

Universal Repair Guides

- Unfinished ID ready to be reamed with Goodson's exclusive carbide reamers (page 31)
- Manganese bronze

ID	OD	Length	Job. 1+	Job. 25+	Job. 51+	Order No.
7.0mm	.740"	2.700"	\$13.99	\$12.59	\$11.89	UVBG-7MM
.308"	.740"	2.700"	13.99	12.59	11.89	UVBG-308
.341"	.740"	2.700"	13.99	12.59	11.89	UVBG-341
.372"	.740"	2.700"	13.99	12.59	11.89	UVBG-372



Get QualCast Valve Guides from your friends at Goodson

Goodson offers the complete line of QualCast Products for High Performance, Standard Duty and Heavy Duty vehicle engines. Visit the QualCast section of the Goodson website for listings.

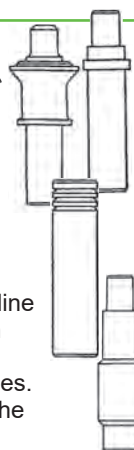

Scan the code below with your smart phone or other device for fast access to the QualCast Valve Guide listings on the Goodson website



CYLINDER HEAD REBUILDING

CLEANING, ASSEMBLY & SAFETY

DRILLING TOOLS

CRANKSHAFT/FLYWHEEL GRINDING

MISCELLANEOUS TOOLS & SUPPLIES

BRAKE SERVICE TOOLING

MEASURING TOOLS

V-TWIN & METRIC HARD PARTS

... another satisfied customer

"I have been using your products for over 30 years and have never had an issue. Your phone staff is friendly and helpful; my parts are packaged perfectly and the quality of your products is excellent. Keep up the good work."

— Brad Mattei, Mattei's Cycle Supply, New Orleans, LA, Goodson Customer Since 1990

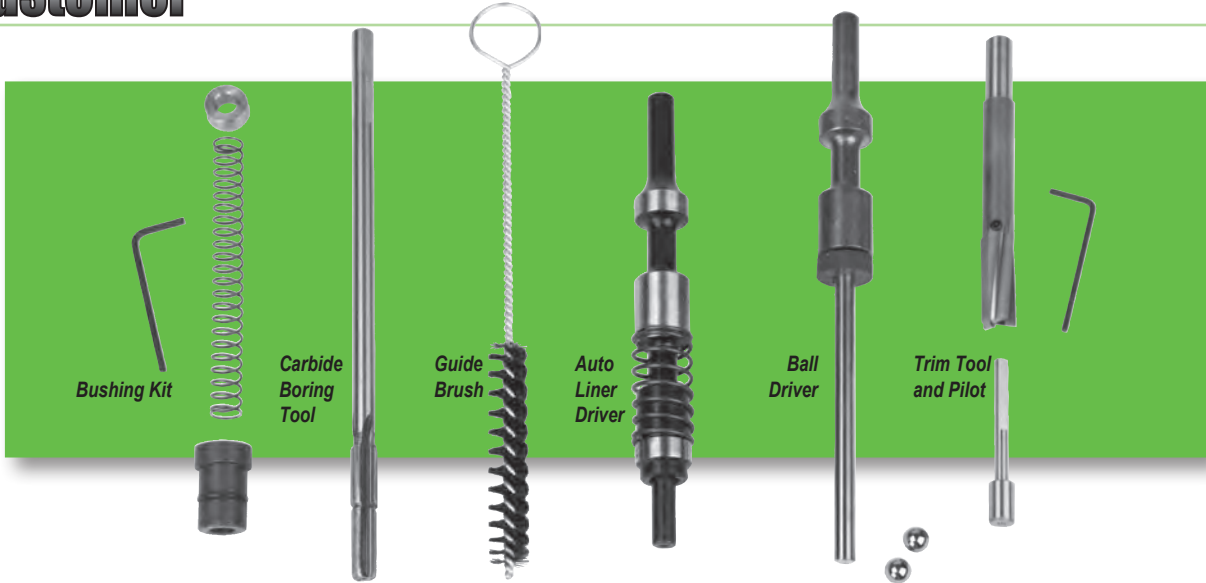

6.0mm to 3/8" Bronze-Liner Installation Tool Kits

Phosphor-Bronze is an ideal valve guide material – it's more durable than cast iron, conducts heat away faster and retains lubrication better to reduce wear. Install rugged, thin-wall (.030") Bronze-Liners in cast iron or aluminum heads to repair guides and deliver performance better than new! Plus, Bronze-Liners install quickly with simple tools. If a Bronze-Liner ever wears out, you can quickly and easily replace it with a new one to restore performance. **Removal Tools, page 39.**

Kits include ▼	6.0mm Guides		7.0mm Guides		5/16" Guides	
Master Tool Kits	\$719.99	CL-6MM	\$689.99	CL-7MM	\$739.99	CL-312
Carbide Boring Tool	287.99	CL-2024C	247.99	CL-2007C	287.99	CL-2005C
Bushing Kit	29.99	CL-2003	29.99	CL-2001	29.99	CL-2000
Ball Driver	104.99	CL-4452P	104.99	CL-4446P	104.99	CL-4444P
Carbide Sizing	66.99	.2370" CL-5237	66.99	.2770" CL-5277	66.99	.3125" CL-53125
Balls	66.99	.2380" CL-5238	66.99	.2780" CL-5278	66.99	.3130" CL-5313
Auto-Driver	139.99	CL-3600	139.99	CL-3507	139.99	CL-3500
Trim Tool	102.99	.402" OD CL-5602	102.99	.500" OD CL-5600	102.99	.500" OD CL-5600
Trim Tool Pilot	33.99	CL-5634	33.99	CL-5626	33.99	CL-5620
Guide Brush	8.49	GVP-10N	4.99	WCB-44	4.99	WCB-44

When Working By Hand, Kits Require Seat Centering Cones - See Chart Below

Kits include ▼	8.0mm Guides		11/32" Guides		3/8" Guides	
Master Tool Kits	\$739.99	CL-8MM	\$739.99	CL-343	\$739.99	CL-375
Carbide Boring Tool	287.99	CL-2008C	274.99	CL-2012C	287.99	CL-2014C
Bushing Kit	29.99	CL-2000	29.99	CL-2000	29.99	CL-2000
Ball Driver	104.99	CL-4444P	104.99	CL-4444P	104.99	CL-4444P
Carbide Sizing	66.99	.3160" CL-5316	66.99	.3440" CL-5344	66.99	.3750" CL-5375
Balls	66.99	.3170" CL-5317	66.99	.3445" CL-53445	66.99	.3760" CL-5376
Auto-Driver	139.99	CL-3500	139.99	CL-3504	139.99	CL-3506
Trim Tool	99.99	.500" OD CL-5600	102.99	.500" OD CL-5600	102.99	.500" OD CL-5600
Trim Tool Pilot	38.99	CL-5620	33.99	CL-5622	33.99	CL-5624
Guide Brush	4.99	WCB-44	4.99	WCB-44	4.99	WCB-44

tech tips
from the techxperts™

The centering cone must fit the valve seat properly so using the correct size is essential.

This is NOT a one-size-fits-all tool. If you have a cone that is too small for the seat it could slip through the opening. If you have one that's too large, the side of the combustion chamber could interfere or you won't have enough of the cone in the seat area for it to be stable and centered.

60° Seat Centering Cones

- Center firmly in the valve seat
- Cones feature a .625" ID
- Steel construction
- Use the Seat Centering Cones with the Master Tool Kits (above) for proper alignment of the reamer and guide bore

Description	Jobber	Order No.	
7 Piece Kit	\$264.99	CL-6500	▼
Nominal Range			
1"	0.970"-0.730"	\$45.99	CL-6310 x
1¼"	1.230"-0.740"	45.99	CL-6308 x
1½"	1.475"-0.805"	45.99	CL-6306 x
1¾"	1.730"-0.860"	45.99	CL-6304 x
2"	1.950"-0.875"	45.99	CL-6302 x
2¼"	2.230"-1.000"	45.99	CL-6300 x
2½"	2.550"-1.875"	45.99	CL-6312 x

Bronze-Liners & Tooling

Buy 3 or more sizing balls (any combination) and save 10% off jobber



Carbide Sizing Balls

- Finished to .00008" roundness
- Within the 90 Rockwell range
- The finished ID of the Bronze-Liner will be .001" smaller than the ball used

Size	Order No.	Size	Order No.
6.0mm .2360"	CL-5236	8.0mm .3150"	CL-5315
.2370"	CL-5237	.3160"	CL-5316
.2380"	CL-5238	.3170"	CL-5317
7.0mm .2760"	CL-5276	1 1/32" .3430"	CL-5343
.2770"	CL-5277	.3435"	CL-53435
.2780"	CL-5278	.3440"	CL-5344
5/16" .3125"	CL-53125	.3445"	CL-53445
.3130"	CL-5313	.3450"	CL-5345
.3140"	CL-5314	.3460"	CL-5346
Jobber 1+ \$66.99 ea.		3/8" .3730"	CL-5373
Jobber 3+ \$60.29 ea.		.3740"	CL-5374
		.3745"	CL-53745
		.3750"	CL-5375
		.3755"	CL-53755
		.3760"	CL-5376
		Jobber 1+ \$66.99 ea.	
		Jobber 3+ \$60.29 ea.	

tech tips

from the techxperts™

Always be sure to hold your hand under the cylinder head to catch the carbide ball as it comes out of the guide.



Removal Tool

Remove bronze liners without damaging the bore using the driver tool at right

Description	Jobber	Order No.
6.0mm	\$103.99	CL-7352
7.0mm	103.99	CL-7344
5/16"	103.99	CL-7310
8.0mm	103.99	CL-7320
1 1/32"	103.99	CL-7330
3/8"	103.99	CL-7340

Universal Driver Tool

- Fits all removal tools at left and is designed to work with your air hammer
- .401" ID • 4.75 OAL
- Order No. **CL-7333** Jobber \$49.99



Small Hole Gauge Set

- See if rebuilding or replacing is needed by checking guide wear
- Check guide bosses for proper interference fit during replacement
- Check and maintain correct stem-to-guide ID clearance
- 4-piece set has combined range of .125" to .500"
- Order No. **SHG-4** Jobber \$74.99



Phosphor-Bronze liners outlast original guides and are easy to replace

Stripe helps you quickly identify the round nose end

Rounded nose design makes installation fast and easy

Dimples inside promote oil retention

Thin-Wall .030" Bronze-Liners

- Outlast original guides
- Dimples promotes oil retention
- Rounded nose design makes installation quick and easy
- Stripe helps you identify rounded end
- Phosphor-bronze

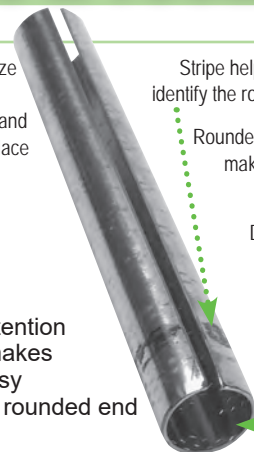

tech tips

from the techxperts™

NOTE: 5.0 & 5.5mm Guides do NOT interchange with competitors' guides. You MUST use our tooling with these guides.

Guide Size	Liner Size		Box of 16		Box of 100	
	OD	Length	Jobber	Order No.	Jobber	Order No.
5.0mm	+ .030"	2.00"	\$23.99	CL-500	\$ 93.99	CL-500A
5.5mm	+ .030"	2.50"	23.99	CL-550	93.99	CL-550A
6.0mm	+ .030"	2.50"	23.99	CL-600	93.99	CL-600A
7.0mm	+ .030"	2.50"	23.99	CL-700	93.99	CL-700A
.312"	+ .030"	2.50"	23.99	CL-1220	93.99	CL-1220A
8.0mm	+ .030"	2.50"	23.99	CL-1420	93.99	CL-1420A
.343"	+ .030"	3.00"	23.99	CL-1640	93.99	CL-1640A
.375"	+ .030"	3.00"	23.99	CL-1830	93.99	CL-1830A
Override OD Bronze Liners						
.343" +.002"	+ .032"	2.50"	\$30.99	CL-1640-2	\$119.99	CL-1640-2A
.375" +.002"	+ .032"	3.00"	32.99	CL-1820-2	137.99	CL-1820-2A
.375" +.004"	+ .034"	3.00"	32.99	CL-1820-4	137.99	CL-1820-4A

Chamfer Tool & T-Wrench

Use these optional accessories to remove any burrs that may be created when trimming the liner to length

Description	Jobber	Order No.
Chamfer Tool	\$31.99	CL-5800
T-Wrench	31.99	CL-5870

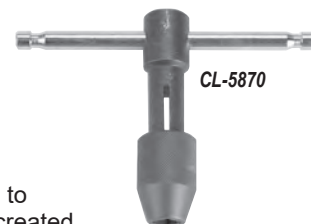

CL-5870



CL-5800

Mitutoyo

Split Ball Bore Gauge

- Dial gauge with large contact area
- Measures quickly & accurately to .0001" (.0025mm)
- Works in threaded or knurled guide IDs
- Range: .280" to .400"
- Easy to change contacts
- Includes molded plastic storage case
- Order No. **MVG-34** Jobber \$769.99



premium grade

CYLINDER HEAD REBUILDING

CLEANING, ASSEMBLY & SAFETY

SHORT BLOCK REBUILDING

FLYWHEEL GRINDING

CRANKSHAFT/ TOOLS & SUPPLIES

MISCELLANEOUS TOOLS & SUPPLIES

BRAKE SERVICE TOOLING

MEASURING TOOLS V-TWIN & METRIC HARD PARTS



"If any of our products aren't satisfactory, we want you to send it back. We have a no hassle return policy. Just send it back, freight pre-paid within 60 days and we'll exchange it, fix it or credit your account for the amount of the purchase."

- Kayla, Goodson Customer Service, 2 years of service

CYLINDER HEAD
REBUILDING

CLEANING,
ASSEMBLY & SAFETY

SHORT BLOCK
REBUILDING

CRANKSHAFT/
FLYWHEEL GRINDING

MISCELLANEOUS
TOOLS & SUPPLIES

BRAKE SERVICE
TOOLING

MEASURING
TOOLS

V-TWIN & METRIC
HARD PARTS

Valve Seal Puller

- .810" tool dia.
- Fits Multi-Valve Engines
- Lifts from the bottom of the seal
- Works within the confines of lifter bucket bores
- Fingers grip seal for fast, easy removal
- Works on most domestic and import vehicles
- New and improved seal puller with stronger 3 jaw pulling action

Description	Jobber	Order No.
Valve Seal Puller	\$219.99	VSP-323
Replacement Shaft	58.99	VSP-323-4
Replacement O-Ring	4.99	VSP-323-5
Replacement Jaw Set (3 Pc.)	89.99	VSP-323-3
Replacement Jaw Sleeve	51.99	VSP-323-1
Black Split Sleeve	30.99	VSP-323-2

Parts are interchangeable with VSP-320



3 Finger Jaw
Grips Seals
Firmly!

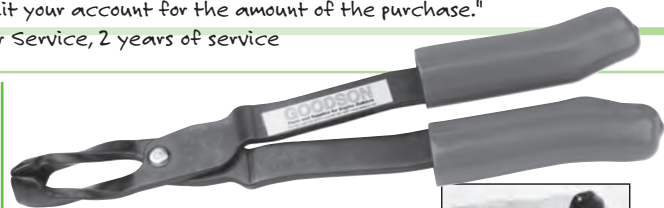

Universal Seal Pliers

- Works on OHC and in-line engines with recessed springs
- Long, serrated jaws reach into confined areas and grip seals firmly
- Heat-treated steel with easy-grip handles
- Order No. VSP-823
Jobber \$67.99



sized for
diesel

Intake & Exhaust Valve Stem Seals for 24 Valve, 7mm Cummins Diesel

- Fit 7mm valve stems
- OD measures .511"
- Sold in packs of 12

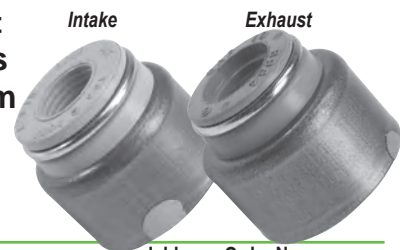

Application	Jobber	Order No.
Intake	\$15.99	CVS-59I
Exhaust	15.99	CVS-59E



Goodson now offers the full line of QualCast Products.

Whatever you're looking for, you can find it online at www.goodson.com!

- Valves
- Valve Guides
- Valve Spring Inserts
- Valve Lifters
- Rocker Components
- Push Rods
- And a whole lot more!
- Valve Seat Inserts
- Valve Springs
- Valve Keepers (cotters, keys)
- Valve Stem Seals
- Injector Components
- Freeze Plugs

You'll find products for High Performance, Light Duty, Standard Duty and Heavy Duty. Products ship directly from QualCast's Nashville location to your door. Visit the QualCast section on the Goodson website today or Call 1-800-533-8010.

Height Indicator

- Measure compressed spring height when testing pressure
- Ideal for high performance and checking identical springs
- For Rimac® and other spring testers
- Height Scale displays inches and metric
- Includes Dial Indicator, and Mounting Kit (additional dial indicators on page 127)
- Order No. VST-25 Jobber \$87.99

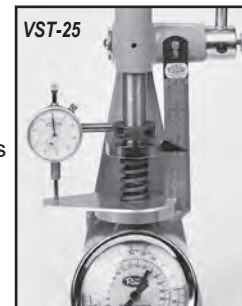

Minnesota Fast Freeze

- Instantly chills seats & guides to -50°F (-45.5°C)
- Creates interference fit with heated aluminum heads
- Finish seat and guide work faster than ever
- Aerosol*
- Use on tight bushings, pins, shafts, etc.
- 10 oz. can

Description	Jobber 1+	Jobber 6+	Order No.
Minnesota Fast Freeze	\$49.99	\$44.99	MFF-8

Order 6 or more to Save 10% off Jobber

*Hazardous Goods Fees Apply When Shipped by Air



Valve Spring Testing

Rimac® Valve Spring Testers

new

Rimac® Valve Spring Testers

- Specifically designed for quick, easy testing of multiple valve springs
- High-torque, lever-actuated compression is key to repeatable precision
- The vertical design ensures stability on the workbench
- Ideal for use in the shop, but portable enough to take to the racetrack
- Calibrated spring set includes two springs with different ranges that can be combined for a range of 10 to 640 lbs.

Description	Jobber	Order No.
0-500 lb. Tester (reads in 5 lb. increments)	\$899.99	VST-69
0 to 1000 lb. Tester (reads in 2 lb. increments)	899.99	VST-70
Calibrated Test Spring Set (2 pc.set)	79.95	VST-SPRINGS

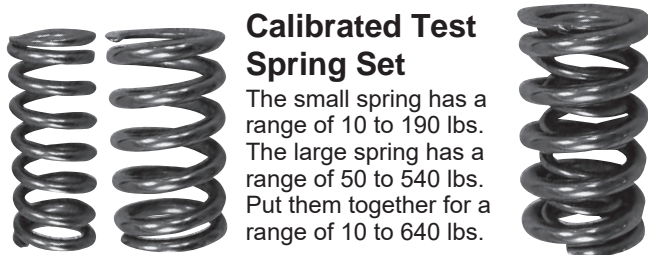

Calibrated Test Spring Set

The small spring has a range of 10 to 190 lbs. The large spring has a range of 50 to 540 lbs. Put them together for a range of 10 to 640 lbs.

made in America



VST-69

Positive stop for checking repeatability

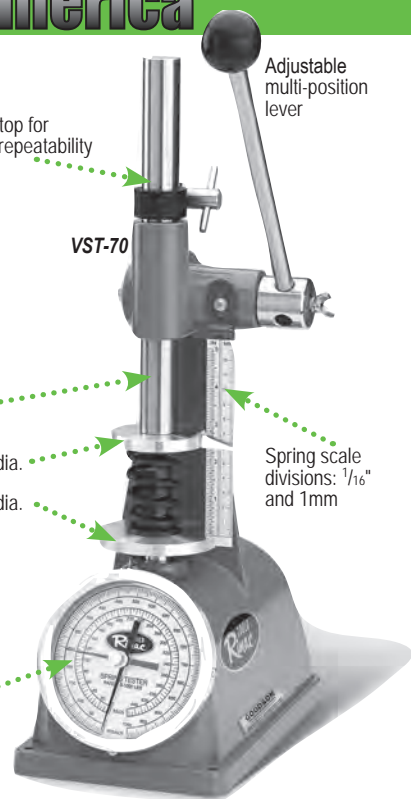

VST-70

Adjustable multi-position lever

Ram travels 4 5/8"

Upper Platform measures 2 1/4" dia.

Lower Platform measures 3 1/4" dia.

Spring scale divisions: 1/16" and 1mm

Easy to read dial shows both pounds and kilograms

CYLINDER HEAD
REBUILDING

CLEANING,
ASSEMBLY & SAFETY

SHORT BLOCK
REBUILDING

CRANKSHAFT/
FLYWHEEL GRINDING

MISCELLANEOUS
TOOLS & SUPPLIES

BRAKE SERVICE
TOOLING

MEASURING
TOOLS

V-TWIN & METRIC
HARD PARTS



Easy-to-use Travel Stop with adjustable set screws lets you set an exact position, allowing repeated testing at a desired height. Two set screws allow you to adjust for installed spring height and max lift (near coil bind).

Arbor style handle makes compressing springs fast and easy

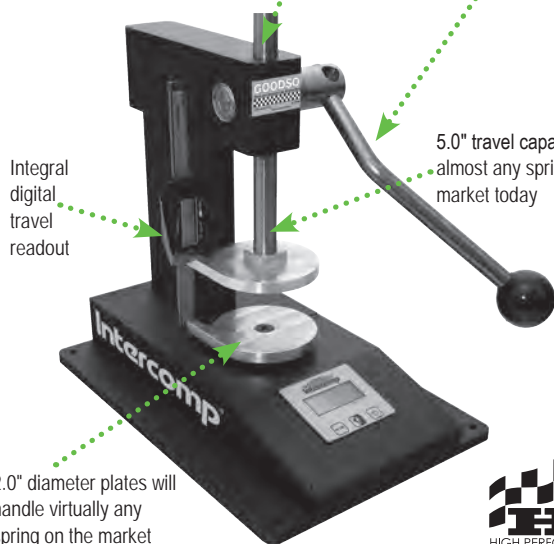

Integral digital travel readout

5.0" travel capacity will fit almost any spring on the market today

2.0" diameter plates will handle virtually any spring on the market



Protect Your Valuable Valve Spring Tester with a Machine Cover!

Fits Machine	Jobber	Order No.
VST-2000 Spring Tester	\$45.99	GMC-VST
Rimac Spring Tester	39.99	GMC-RIMAC

More Machine Covers on page 25

Intercomp® Digital Arbor Valve Spring Tester

- 1,500 lb / 680.4 kg load cell in 1 lb. increments
- Force units switchable from pounds to kilograms
- Billet 6061 T-6 Aluminum construction
- Digital travel readout at .001"/inch or .01/mm
- 5" travel capacity • 2.0" diameter spring pads
- Easy to read backlit screen
- Operates on 9V battery (included)
- Adjustable stop to repeatedly check springs at the same heights
- Order No. **VST-2000** Jobber \$1749.99

For routine calibration of spring testers, return tester to Goodson. Call for details, 1-800-533-8010.

... another satisfied customer

"Everyone at Goodson has been and is always great help! Quality products at great prices. A must to build high quality engines"

- Wayne Brown, Brunswick, GA, Goodson customer since 2023



CYLINDER HEAD REBUILDING



Pneumatic Head:
Adjustable to 25° in either direction for canted valves



Head Support:
Table adjusts 45° to the front and 30° to the rear



Positive Stops: Adjusts front and rear angles

CLEANING, ASSEMBLY & SAFETY



Speed Knobs:
Allows quick positioning of workpiece



Foot Pedal:
Easy, hands-free operation



Quick Release Knob:
Allows fast positioning to opposite cam bank

SHORT BLOCK REBUILDING

CRANKSHAFT/ FLYWHEEL GRINDING

MISCELLANEOUS TOOLS & SUPPLIES

BRAKE SERVICE TOOLING

MEASURING TOOLS

V-TWIN & METRIC HARD PARTS

Goodson exclusive

Slide Hammer:
A quick tap loosens keepers for fast removal

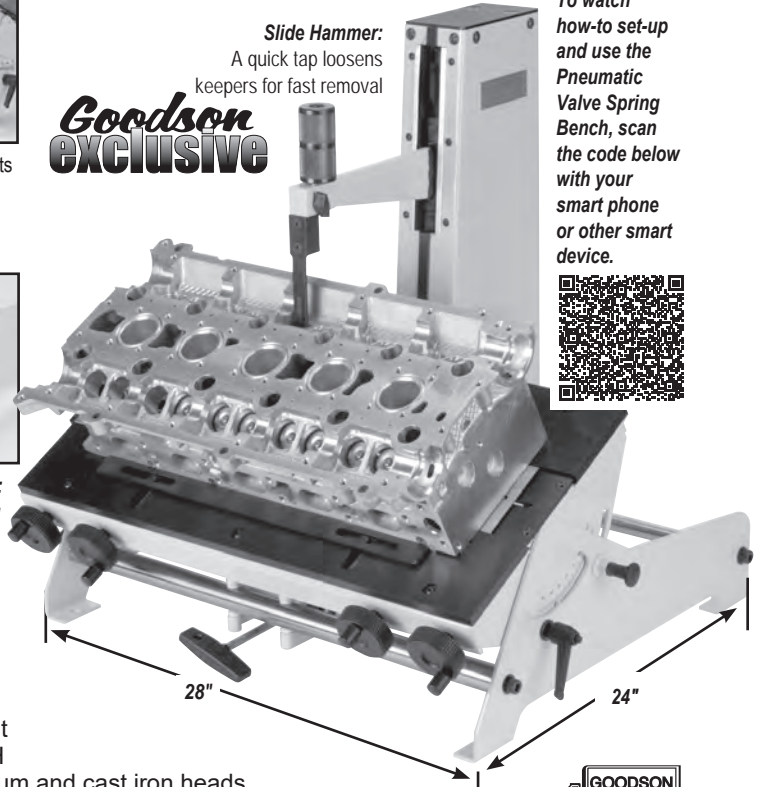

To watch how-to set-up and use the Pneumatic Valve Spring Bench, scan the code below with your smart phone or other smart device.



Pneumatic Valve Spring Press

- Pneumatic valve support holds valve closed as you compress the spring
- Produces 432 lbs. of force at 100 PSI
- Adjustable stainless steel plate won't damage the head
- 28mm Valve Spring Adaptor (**CF-502**) is standard with unit (other sizes are available) • Measures 28"L x 24"W x 26"H
- Ideal for use on heads with recessed springs • For aluminum and cast iron heads
- Ships fully assembled • Replacement Parts Available
- Order No. **PSB-5000** Jobber \$5799.99

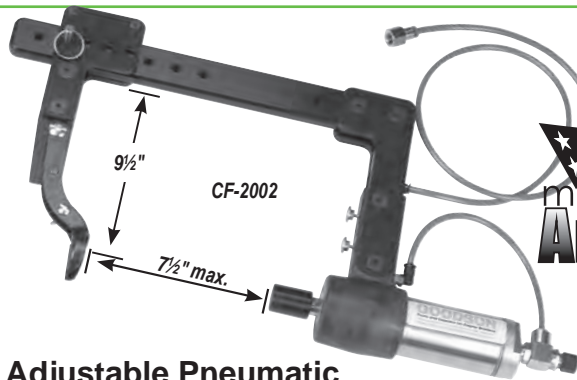

CF-2002

9 1/2"

7 1/2" max.

made in America

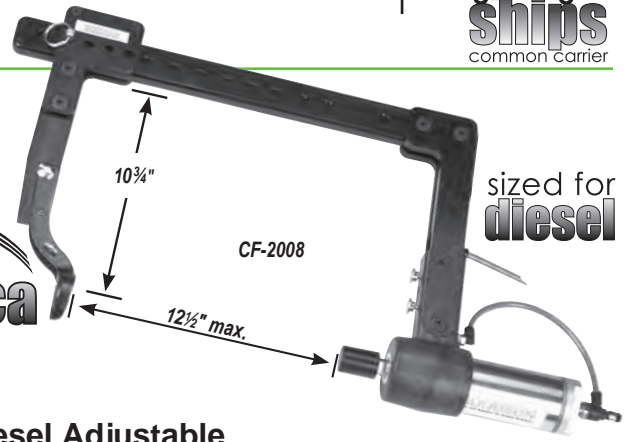

CF-2008

10 3/4"

12 1/2" max.

sized for diesel

Adjustable Pneumatic Valve Spring Compressor

- Develops up to 325 lbs. of force with 130 PSI
- For springs from 3/4" to 1 3/4" dia.
- CNC-machined 6061 T6 aircraft-quality aluminum frame is adjustable in 1/4" increments
- Includes adjustable jaws (**CF-44**)
- Stainless steel cylinder with viton grade seals
- 2" cylinder travel • Fingertip controls • Full 1 year warranty

Description	Jobber	Order No.
Valve Spring Compressor	\$739.99	CF-2002
Replacement Parts and Accessories		
Valve Spring Adaptor Jaw Set	\$ 19.99	CF-44
1/4" Green Air Line (lin. ft.)	2.99	CF-2001-AL
Air Control Needle Valve	54.99	CF-2001-NV
Intake / Exhaust Cartridge	16.99	CF-2003-C
Air Cylinder 2" Travel	139.99	CF-2001-AC
1/8" NPT L-Fitting	5.79	CF-2003-L

Diesel Adjustable Pneumatic Valve Spring Compressor

- Develops up to 325 lbs. of force with 130 PSI
- For springs from 3/4" to 1 3/4" dia.
- CNC-machined 6061 T6 aircraft-quality aluminum frame is adjustable in 1/4" increments
- Includes adjustable jaws (**CF-44**)
- Stainless steel cylinder with viton grade seals
- 2" cylinder travel • Fingertip controls • Full 1 year warranty

Description	Jobber	Order No.
Valve Spring Compressor	\$779.99	CF-2008
Replacement Parts and Accessories		
Valve Spring Adaptor Jaw Set	\$ 19.99	CF-44
1/4" Green Air Line (lin. ft.)	2.99	CF-2001-AL
Air Control Needle Valve	54.99	CF-2001-NV
Intake / Exhaust Cartridge	16.99	CF-2003-C
Air Cylinder 2" Travel	139.99	CF-2001-AC
1/8" NPT L-Fitting	5.79	CF-2003-L

Valve Spring Compressors



**Goodson
exclusive**

Locking Arm:
Holds the C-frame
securely in position
at the desired angle



Lock Collar:
Can be used to stop
vertical travel or to hold
spring compressed
while assembling
keepers

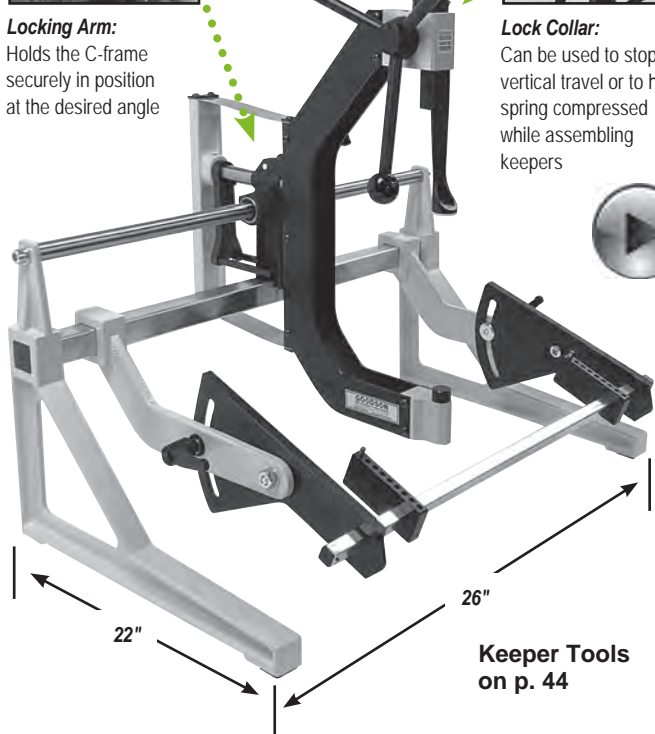

Keeper Tools
on p. 44

Manual Valve Spring Bench

- Remove and install valve springs on heads with recessed springs
- Creates 550 lbs. force with 45 lbs. exertion
- Includes 28mm diameter spring adaptor (CF-502), other size spring adaptors also available (see chart below)
- Frame tilts up to 25° in either direction for canted valves
- Full cylinder head support is adjustable from 0 to 45°
- Integral slide hammer easily releases stuck keepers
- Replacement parts available
- Order No. **CF-500** Jobber \$2199.99



To watch how-to use the Manual Valve Spring Bench, scan the code at right with the camera on your smart phone or other smart device.



Spring Adaptors

- Fit both manual (CF-500) and pneumatic (PSB-5000) spring benches
- 1/2" pin diameter
- Solid steel construction with replaceable nylon wear insert



OD	Reach	Jobber	Adaptor	Jobber	Insert
18mm	4 1/2"	\$299.99	CF-518	\$24.99	CF-518-1
23mm	4 1/2"	299.99	CF-501	24.99	CF-501-1
28mm	3 1/2"	299.99	CF-502	24.99	CF-502-1
35mm	2 1/2"	299.99	CF-503		insert not required



**made in
America**

Dual Stage 1000 Lb. Pneumatic Valve Spring Compressor

- Lightweight — built of 6061 / 7075 T-6 Aluminum
- 1 1/2" Screw Adjustment — 7" to 8 1/2" Throat
- Certified to 1000 lbs of force
- Dual stage air pump develops up to 1000 lbs. of force on as little as 70 psi air supply — **Do NOT exceed 120 psi**
- Includes 1.600" ID Jaw adaptor, 1.740" ID jaw sold separately

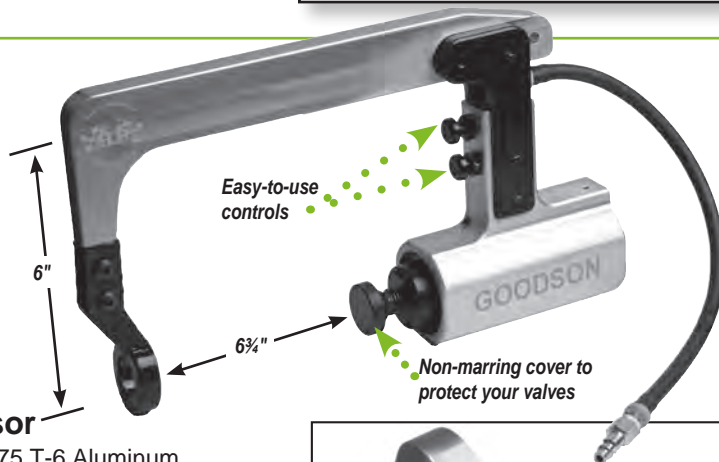

Easy-to-use
controls

Non-marring cover to
protect your valves

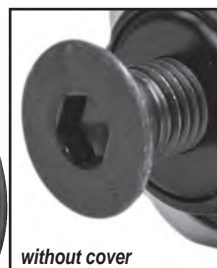

without cover



with cover

Description	Jobber	Order No
Spring Compressor with 1.600" ID Jaw	\$1029.99	GSC-1000
Replacement Standard Jaw, 1.600" ID	147.99	GSC-3002
Adaptor Jaw, 1.740" ID	147.99	GSC-3003
LS1 Jaw Adaptor (1.740 OD) use with CF-3002	44.99	GSC-3000-LS1
Rebuild Seal Kit (with Intake Button Return Spring)	124.99	GSC-3000SK
Replacement Intake Button Return Spring	71.99	GSC-3004
Intake Trigger Assembly	71.99	GSC-20004A
Exhaust Trigger Assembly	68.99	GSC-20004B
Delrin Pressure Cap (included)	21.99	B-10005C

NOT interchangeable with our CF-3000B Spring Compressor

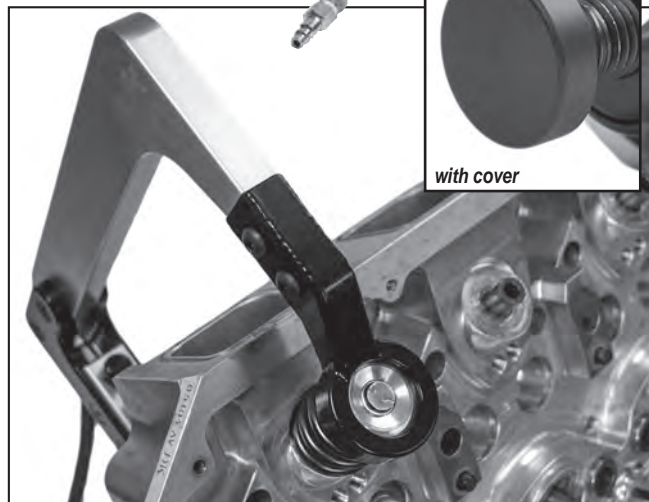

CYLINDER HEAD
REBUILDING

CLEANING,
ASSEMBLY & SAFETY

SHORT BLOCK
REBUILDING

CRANKSHAFT/
FLYWHEEL GRINDING

MISCELLANEOUS
TOOLS & SUPPLIES

BRAKE SERVICE
TOOLING

MEASURING
TOOLS

V-TWIN & METRIC
HARD PARTS



"You'll always get fast, reliable service from Goodson, even on international orders. We'll do whatever it takes to make sure you get your shop supplies as quickly and easily as possible - anywhere in the world."

- Paige, Goodson Customer Service, 6 years of service

CYLINDER HEAD
REBUILDING

Manual Valve Spring Compressor

- Weighs only 6 lbs
- High leverage allows for easy, one-hand operation
- Covers a range from 10"H to 8"D
- Works with most L-head and valve-in-head engines
- Fits truck & tractor engines
- Jaws adjust for different spring sizes

Description	Jobber	Order No.
Spring Compressor	\$104.99	CF-140
Replacement Jaw Set	17.99	CF-44
HD Replacement Jaw Set	39.99	CF-44HD

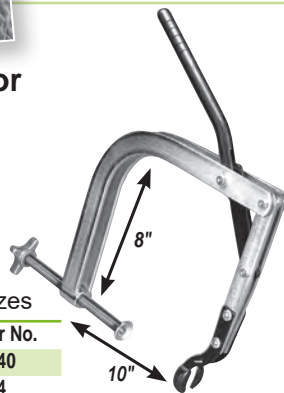

CLEANING,
ASSEMBLY & SAFETY



Manual Valve Spring Compressors

- Handle valve springs from a range of applications
- Welded, gusseted all-steel construction takes plenty of abuse
- Plenty of leverage to compress valve springs
- Order No. **CF-1500** Jobber \$289.99

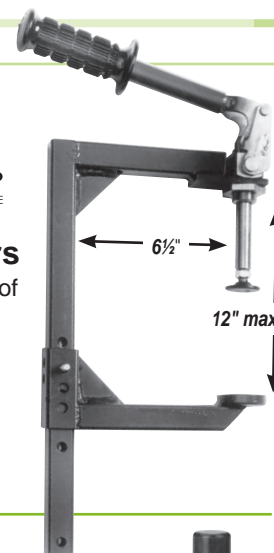

SHORT BLOCK
REBUILDING

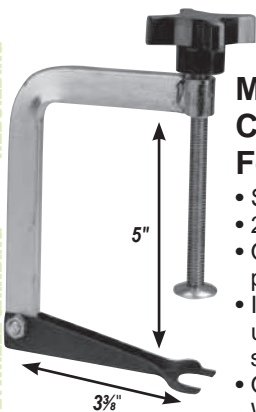

Manual Valve Spring Compressor For Small Engines

- Steel construction
- 20lb. max. spring pressure
- Once you lock the compressor in position, your hands are free to work
- Includes 2 jaw sets - small, for springs up to 7/8" (22.2mm) and large, for springs up to 1 1/16" 27.0mm)
- Order No. **CF-600** Jobber \$30.99 While Supplies Last

small engine
powersports

CRANKSHAFT/
FLYWHEEL GRINDING

Valve Spring Compressor Adaptor

- Fits seat and guide machines or drill press
- Puts collet or drill press chuck behind adaptor
- Allows more room to remove or re-install valve keepers and associated components
- Fits 1/2" collet or Jacobs chuck (not included)

OD (mm)	Reach (mm)	Jobber	Order No.
3/4" (19.1)	3 3/4" (95.3)	\$52.99	CF-6
1 3/16" (20.6)	3 3/4" (95.3)	52.99	CF-8
1" (25.4)	3 3/4" (95.3)	52.99	CF-10
1 1/4" (31.7)	3 3/4" (95.3)	54.99	CF-12
1 1/2" (38.1)	3 3/4" (95.3)	56.99	CF-15



MISCELLANEOUS
TOOLS & SUPPLIES



Keeper Installation Tools

- Spring-loaded plunger
- For single & multi-groove keepers
- Reaches keeper grooves located farther from the valve tip • Ideal for use with **CF-500** (p. 43) and **PSB-5000** (p. 42)

Best Keeper Tool
on the Market!

Size	Jobber	Order No.
5mm / .2031"	\$99.99	VKI-5
6mm / .2344"	99.99	VKI-6
7mm / .2812"	99.99	VKI-7
8mm / .3125"	99.99	VKI-8
Replacement Rubber Sleeve	7.99	VKI-56

BRAKE SERVICE
TOOLING

Adaptors for Deeply Recessed Springs

- Open top design gives easy access to keepers
- Durable, non-marring material
- Fit on Split-Jaw Spring Adaptors such as our **CF-44** (below)



Description	OD	Height	Jobber	Order No.
Small Metal Adaptor	26mm	4" (101.6mm)	\$35.99	CF-32
Medium Nylon Adaptor	27mm	3" (76.2mm)	35.99	CF-24-G
Large Nylon Adaptor	32mm	3" (76.2mm)	35.99	CF-25-G

MEASURING
TOOLS

One of the
handiest keeper
tools you'll ever
find!

Keeper Magnet

- 6 5/16" long holder fits easily into deep bores
- Powerful .170" diameter earth magnet holds keepers securely when removing or installing
- Order No. **VKM-17** Jobber \$19.99

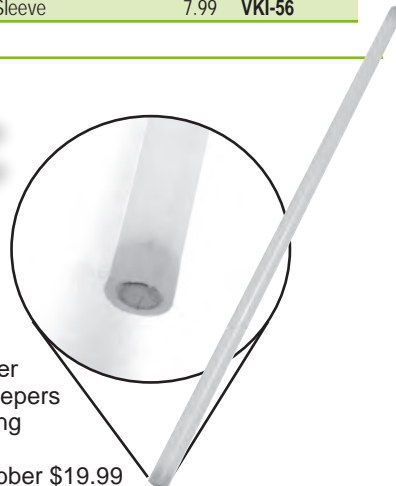

V-TWIN & METRIC
HARD PARTS



Valve Spring Adaptor Jaws

- Fit frames with double locking screws to secure jaws such as Goodson **CF-2002**, **CF-2008** and **CF-140**
- Heavy duty jaws are non-adjustable (has a 1 5/8" max spring diameter)

Description	Jobber	Order No.
Standard Duty 1.000"-1.875" (25.4-47.6mm) Range	\$17.99	CF-44
Heavy Duty (non-adjustable)	39.99	CF-44HD

Air Powered Grinder
uses standard shop air

DESIGNED BY AN ENGINE BUILDER FOR ENGINE BUILDERS!

Bucket Lifter Grinder Assembly with FREE Grinder

- Machine just the bucket lifter!
- Fast and accurate
- Save time — measure once, then remove the material from inside the Bucket Lifter instead of machining the stem height and finding the right VAD thickness or grinding the seat to meet your specs
- Micrometer feed shows how much material is being removed
- Confirm with dial indicator and bridge (included)
- Use right at your assembly station
- Works with most Bucket Style Lifters, including those with VADs
- Complete Assembly includes Air Driver, CBN Cutter, Micrometer Feed Body, Dial Indicator and Indicator Base
- **US Patent Number US 10456887**

Description	Jobber	Order No.
Complete Bucket Lifter Grinder Assembly	\$874.99	BLG-1000
Replacement CBN Cutter	92.99	BLG-1001
Replacement Dial Indicator	32.99	EDI-1
CBN Dressing Stick 1/2" x 1/2" x 6"	19.99	DS-CBN

Micrometer Feed shows
how much material you are
removing

CBN Cutter makes
quick work of
virtually any
bucket lifter

Use the Dial Indicator and Base
to measure the valve contact point.
Once determined, remove necessary
material to set lash.



View our Tech Lab Tuesday
video to see how easily you can
adjust valve lash by machining
the bucket lifters with the Bucket
Lifter Grinder. Scan the code
at left with the camera on your
smart phone or other smart
device for instant access.

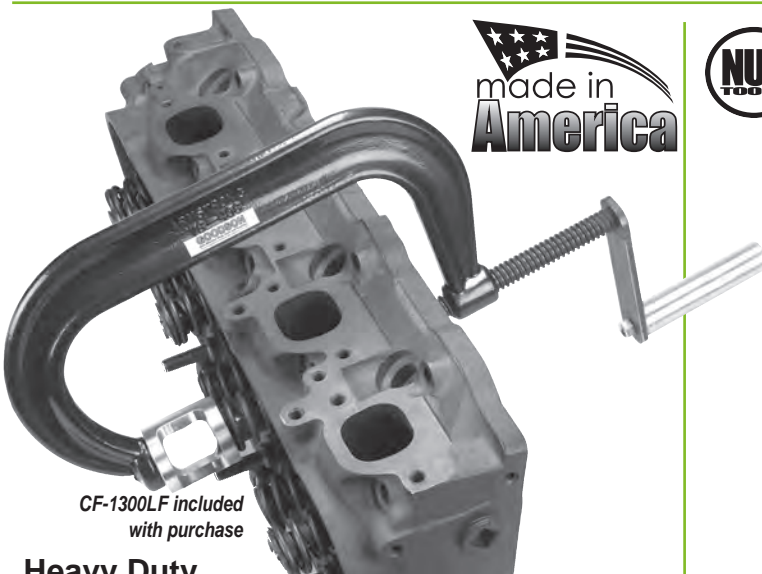

CF-1300LF included
with purchase

Heavy Duty Manual Valve Spring Compressor

- Drop forged steel frame
- Open receiver design allows for quick access to keepers
- Accommodates springs up to 1 3/4" diameter
- 8 1/2" throat • 6" deep
- Compresses springs up to 1000 pounds

Description	Jobber	Order No.
Manual Valve Spring Compressor	\$424.99	CF-1300
Small Receiver (OD: 1.625", ID: 1", Height: 2.156")	89.99	CF-1300SF
Large Receiver (OD: 2.0", ID: 1.197", Height: 2.25")	99.99	CF-1300LF

made in
America

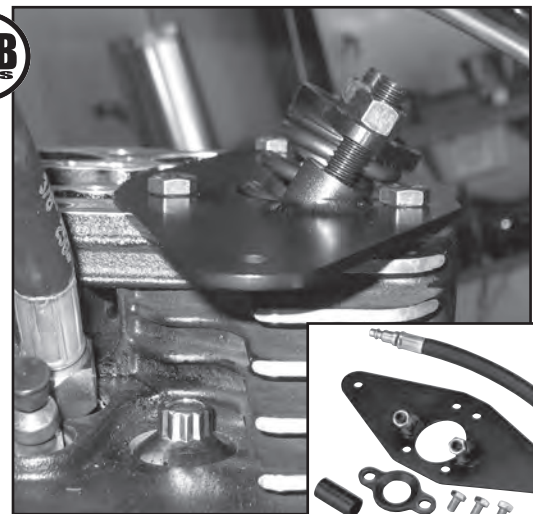

V-Twin On-the-Engine Valve Spring Compressor

Replace broken valve springs, install high performance valve springs, remove and replace valve guide seals all without disassembling the bike. Just remove the gas tank and get to work. Use on Sportster, Evolution, Twin-Cam and most aftermarket V-Twins. Kit includes valve spring compressor, adaptor for compressing beehive springs, valve seal driver/installer and head pressurizing hose. Order No. **CF-HDIF** Jobber \$189.99

made in
America

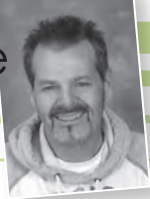

"We work hard to get the right products in the right boxes and ship them to the right address every single time."

- Shawn, Goodson Shipping, 6 years of service

CYLINDER HEAD
REBUILDING

CLEANING,
ASSEMBLY & SAFETY

SHORT BLOCK
REBUILDING

CRANKSHAFT/
FLYWHEEL GRINDING

MISCELLANEOUS
TOOLS & SUPPLIES

BRAKE SERVICE
TOOLING

MEASURING
TOOLS

V-TWIN & METRIC
HARD PARTS

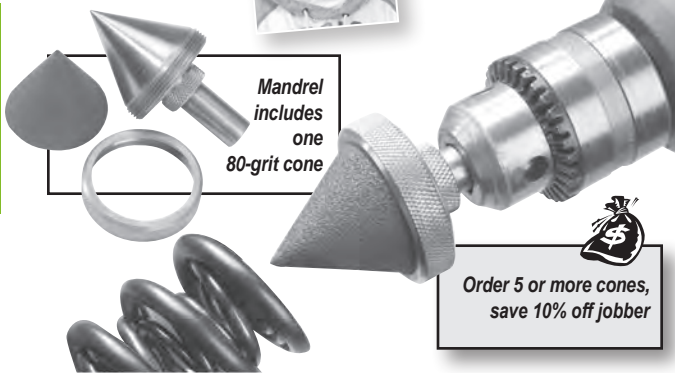

Mandrel
includes
one
80-grit cone

Order 5 or more cones,
save 10% off jobber

Small Chamfering Cones & Mandrels Make Deburring and Chamfering Easy In Tight Spaces

These mandrels are available in two diameters – 3/4" and 1 1/2" diameters with a 1/2" shank to fit most portable drills. The small diameter fits easily into tight spaces such as Beehive Valve Springs (see page 132) or bolt holes. The mandrel is designed to support a 60° abrasive cone which is held securely by the retaining ring. One 80-grit cone is included with initial purchase.

Description	Jobber 1+	Jobber 5+	Order No.
3/4" Dia. Mandrel	\$92.99		CC-34
3/4" Dia. Abrasive Cones	80 grit	5.19	\$4.67 CC-35
	120 grit	5.19	4.67 CC-36
1 1/2" Dia. Mandrel	\$89.99		CC-60
1 1/2" Dia. Abrasive Cones	80 grit	5.99	\$5.36 CC-61
	120 grit	5.99	5.36 CC-62

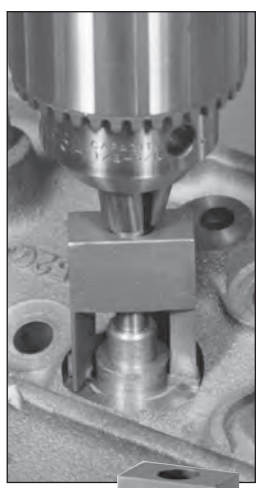

3-D Fast Cut™
Adjustable Spring Pad
Cutters on page 12



Valve Spring Seat Cutters

- Resize valve spring seats to maintain spring-to-valve concentricity or use to enlarge seats for over-size dual springs
- Requires special pilot – see chart below

Carbide Tipped Cutter Bodies
(use VP pilots below)

OD	ID	Jobber	Order No.
1.320"	.630"	\$117.99	VSS-1320
1.350"	.625"	117.99	VSS-1350
1.500"	.625"	117.99	VSS-1500
1.550"	.625"	117.99	VSS-1550
1.625"	.625"	117.99	VSS-1625
1.680"	.750"	117.99	VSS-1680HD
1.750"	.625"	117.99	VSS-1750

Hardened & Ground Pilots

Guide ID	Jobber	Order No.
.275"	7.0	\$42.99 VP-7MM
.312"	7.9	42.99 VP-312
.343"	8.7	42.99 VP-343
.375"	9.5	42.99 VP-375

tech tips

from the techxperts™
You must use these pilots with the VSS and VSC cutters. The flat sides are necessary for a proper fit.

Universal Gel Lube

- Sprays on as a liquid and forms into a gel within seconds
- Penetrating formula blends freely with motor oil
- Multiple uses, including cams, lifters, rocker arms, bearings, pistons/wrist pins, cylinders, etc.
- Provides lubrication for engines subjected to prolonged storage before initial start-up
- Aerosol*
- Order No. **GL-8U**
Jobber 1+ \$26.99 ea., Jobber 6+ \$24.29 ea.



*Hazardous Goods Fees Will Apply if Shipped By Air



8 Piece Valve Train Checking Spring Set

- 1.250" OD
- Spring Steel construction
- Essential for high-performance engine building and engine blueprinting
- Maintain a positive valve train position while checking valve to piston clearance
- Order No. **VTS-8** Jobber \$36.99



Dial Indicated Valve Stem Height Gauges

- 5 sizes to choose from
- Small diameter extended measuring body allows extra height for dial indicator clearance
- Use with our large-faced Dial Indicator to check valve tip height



Description	Jobber	Order No.	Incl.		
Valve Stem Height Gauge Kit w/Stand	\$339.99	VSH-KIT	▼		
Dial Indicator (2" travel, .001" graduations)	81.99	MDI-2	x		
Dial Indicator (1" travel, .001" graduations)	32.99	EDI-1			
Measuring Bodies					
	OD	ID	OAL		
	.750"	.625"	3.830"	\$44.99 VSH-205	x
	.900"	.770"	2.840"	44.99 VSH-203	x
	.900"	.770"	3.840"	44.99 VSH-204	x
	1.060"	.812"	2.840"	44.99 VSH-201	x
	1.250"	1.090"	3.300"	44.99 VSH-202	x
5-Post Tool Stand	56.99	TS-5	x		
1" Checking Standard	13.49	MCS-1			

More dial indicators on page 127

Non-Serrated Valve Spring Booster Shims

- Won't compress
 - Shims meet or exceed OE specifications
 - Maintain pressure and protect head from spring abrasion
 - Made of prime quality cold rolled steel
 - Support valve springs better than serrated shims
 - Won't damage spring pad area on aluminum heads or cause lateral loads or harmonics
- Special Orders are available.**

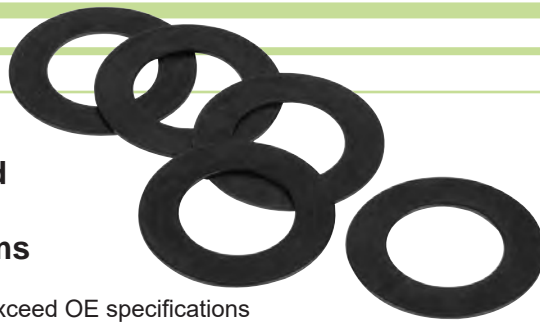

Order 5 or More Packs, SAVE 10% off jobber

Size	50 count High Performance			100 count		
	OD	ID		.060"	.030"	.015"
1.000"	0.688"			A-101	B-101	C-101
	0.765"			A-104	B-104	
1.100"	0.719"				B-106	
1.218"	0.875"			A-105	B-105	
1.250"	0.625"	A-107-HP	B-107-HP	C-107-HP	A-107	B-107
	0.812"	A-203-HP	B-203-HP	C-203-HP	A-203	B-203
	0.875"				A-201	B-201
1.360"	1.000"	A-102-HP	B-102-HP	C-102-HP	A-102	B-102
1.375"	0.765"	A-301-HP	B-301-HP	C-301-HP		B-301
1.438"	0.645"	A-306-HP	B-306-HP	C-306-HP		
1.439"	0.765"	A-305-HP	B-305-HP	C-305-HP		
1.480"	0.703"	A-303-HP	B-303-HP	C-303-HP	A-303	B-303
1.500"	0.645"	A-306S-HP	B-306S-HP	C-306S-HP		
	1.031"	A-103-HP	B-103-HP	C-103-HP	A-103	B-103
1.634"	0.643"	A-601-HP	B-601-HP	C-601-HP		
Jobber	\$25.99	\$25.99	\$25.99	\$25.99	\$25.99	\$25.99



View "CCing Heads — How To Measure Your Combustion Chamber Volume." Scan the code at right with the camera on your smart phone or other smart device for quick access.



Clear acrylic plate lets you see when the chamber is full



Positive fluid control

100cc Glass Buret allows use with alcohol or solvent with high-visibility red markings

Clamp gives you ability to fully adjust the height of the buret in relation to your cylinder head

Cylinder Head CC-ing Equipment

- Use glass buret with alcohol or solvent
- Positive on/off fluid control valve
- Clear acrylic plate lets you see when the combustion chamber is full
- Mix Measuring Concentrate with water to make 1 gallon

Description	Jobber	Order No.	Incl.
CC-Measurement Kit	\$194.99	CCB-KIT	▼
100cc Glass Buret	109.99	CCB-100	x
5" x 5" x 3/8" Acrylic Plate	16.99	GCB-3	x
Buret Cleaning Brush - 35/2" OAL	11.99	GCB-BRUSH	x
Buret Stand	24.99	GCB-1	x
Buret Clamp	21.99	GCB-2	x
Funnel - 2 oz. Capacity	12.49	CCB-FUNNEL	x
Blue Measuring Liquid Concentrate (Yields 1 Gal.)	21.99	GCB-LIQUID	
4" Precision Cylinder Head Level	199.99	LEV-4	
Replacement Vial for 4" level	169.99	VGL-101	
100cc Graduated Glass Beaker	45.99	GC-100	
Universal Cylinder Head Holders (pair)	174.99	HH-200	

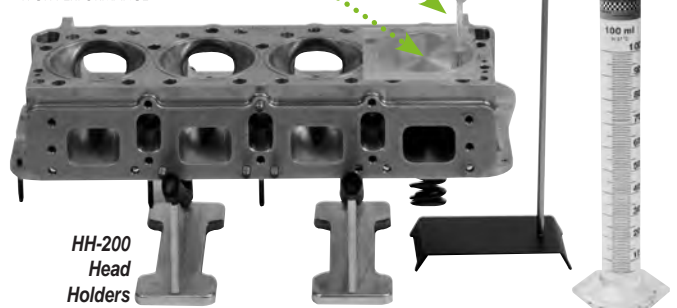

HH-200 Head Holders

GC-100

CYLINDER HEAD REBUILDING
CLEANING, ASSEMBLY & SAFETY
SHORT BLOCK REBUILDING
FLYWHEEL GRINDING
CRANKSHAFT/ TOOLS & SUPPLIES
MISCELLANEOUS
BRAKE SERVICE
MEASURING TOOLS
V-TWIN & METRIC HARD PARTS



Magnetic Head Bolt Washer & Valve Spring Shim Removal Tools

- Hollow design allows easy access over studs or head castings
- Powerful earth magnets grab firmly, letting you lift the washer or shim easily

Description	Jobber	Order No.	Incl.
Magnetic Remover Set	\$137.99	MWR-SET	▼
Washer Removers	ID	OD	
	0.250"	0.625"	41.99 MWR-14 x
	0.500"	0.865"	41.99 MWR-12 x
	0.450"	0.812"	41.99 MWR-716 x
Shim Remover	0.708"	1.355"	44.99 MVR-2 x



"Goodson accepts major credit cards, debit cards, bank drafts and personal checks. Call us for more information."
- Bev, Goodson Accounting Manager - 41 years of service

resharpening available

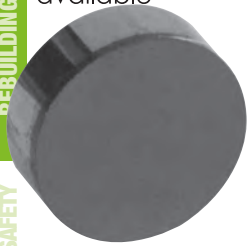

PCD Inserts for Aluminum

- A must for shops committed to meeting today's strict surface finish requirements
- Fits machines with 3/8" & 1/2" CBN holder
- 1/2" diameter inserts require shim*
- Use with Resurfacing Spray (HPS-16) for best results (below)

Titanium-Nitride Coated			Goodson		Radiac	
Dia.	Thick.	Sided	Jobber	Order No.	Jobber	Order No.
3/8"	1/8"	Single	\$209.99	PCDS-375	---	---
	1/8"	Single	97.99	GPCD-375	---	---
1/2"	1/8"	Single	---	---	\$309.99	2379264*
	1/8"	Single	102.99	GPCD-500*	---	---
1/2"	3/16"	Single	219.99	PCDS-500	---	---
1/2"	3/16"	Single	---	---	309.99	2379265
1/2"	3/16"	Single w/screw hole	---	---	189.99	2X6145
1/16"	Thick Carbide Shim*		26.99	CBN-500SHIM	---	---

CBN Cutter Inserts for Cast Iron

- Faster and cleaner than segments and wheels



Uncoated			Goodson		Uncoated	Radiac
Dia.	Thick.	Sided	Jobber	Order No.	Jobber	Order No.
3/8"	1/8"	Single	\$144.99	GCBN-375	---	---
	1/8"	Single	154.99	GCBN-500*	---	---
Titanium-Nitride Coated			---	---	---	---
1/2"	1/8"	Double	264.99	CBN-500D*	\$267.99	2X5299*
	3/16"	Single	297.99	CBN-500S	314.99	2359233
	3/16"	Solid	---	---	354.99	2359234
	3/16"	Single Sided with Screw Hole	---	---	179.99	2X6144
3/8"	1/8"	Double	\$209.99	CBN-375D	---	---
	1/8"	Single	189.99	CBN-375S	---	---
Sharp Uncoated			---	---	---	---
3/8"	1/8"	Single	\$169.99	CBNS-38	---	---
1/2"	3/16"	Single	199.99	CBNS-12	---	---
1/16"	Thick Carbide Shim*		26.99	CBN-500SHIM	---	---

resharpening available

CBN Super Abrasive For Cast Iron Diesel Heads

- Designed for cast diesel heads with hardened pre-cups • Won't chip
- Fits all overhead surfacers with 1/2" diameter insert capacity
- Will NOT work on standard cast heads

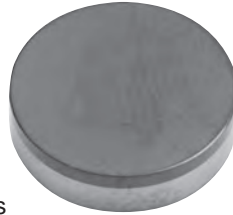

Cut using the dull finished side

Standard Grade Cutters				
Dia.	Thick.	Sides	Jobber	Order No.
3/8"	1/8"	Single	\$149.99	GCBN-D375
1/2"	1/8"	Single	159.99	GCBN-D500
Premium Grade Cutters				
Dia.	Thick.	Sides	Jobber	Order No.
1/2"	1/8"	Single	\$444.99	DRD-500
1/16"	Thick Carbide Shim		26.99	CBN-500SHIM

*NOTE: A 1/16" thick carbide shim must be used on DCM machines

Measure here for replacement vial

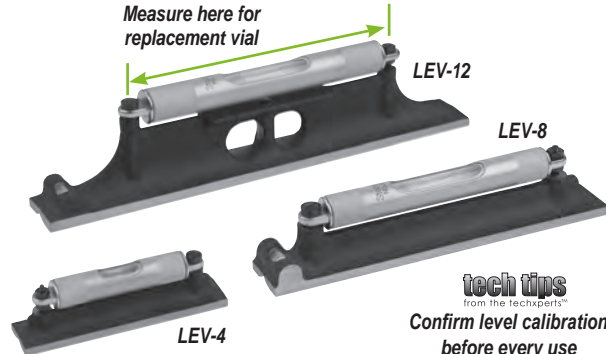

Starrett Precision Levels & Vials

- Graduated vials with satin-chromed, brass protective covers that rotate to close tightly
- Base castings are seasoned, then precision machined and finished on a bearing surface • Replaceable vials
- Adjustable for precise calibration
- 1 division equals .0005" per inch
- Fits pilots from 6mm to .437"
- Use replacement vial to right of level for correct fit

tech tips
from the techsperts
Confirm level calibration before every use



VGL-100
(use with your pilot or find on page 3)

Description	Jobber	Order No.	Replacement Vial
4" Valve Guide Level (3" vial)	\$309.99	VGL-100	\$169.99 VGL-101
4" Level (3" vial - nominal)	199.99	LEV-4	169.99 VGL-101
8" Level (6" vial - nominal)	314.99	LEV-8	199.99 LEV-8-1
12" Level (8" vial - nominal)	454.99	LEV-12	234.99 LEV-12-1

See goodson.com for level calibration instructions



Order 6 or more cans, Save 10% off Jobber



High Performance Resurfacing Fluid

- Prolongs cutter life
- Enhances surface finish
- Refreshing scent

Description	Jobber 1+	Jobber 6+	Order No.
11 oz. Aerosol*	\$29.99	\$26.99	HPS-16
4 oz. Bottle	7.99	---	HPS-4

*Hazardous Goods Fees Apply When Shipped By Air

resharpening available

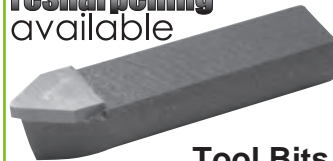

Tool Bits For Van Norman 530, 570 Rotary Broaches

- Can be resharpened
- Order No. VN-65C
Jobber 1+ \$31.99 ea.
Jobber 8+ \$28.79 ea.



Enlarged for clarity



Carbide Cutter Replacement Tips For Storm Vulcan Broach Style Surfacer

- Fits Storm Mill 85, 85B, 85BE, 85C, 85N and 880
- Order No. SV-85BE
Jobber \$37.99



Cylinder Head Resurfacing

Abrasive Industrial Supplies

Need a Different Size or Grit or Material?

We can make the size you need. Specify grit, grain and size and we'll take it from there. Call **1-800-533-8010** for info!

Cylinder Head Resurfacing Belts

A belt has three important parts: abrasive, bond and backing. Goodson belts are made for top performance and long life. Our belts also feature a unique splice that permits use in both directions for even longer wear; when worn one way, turn belt around to resurface more heads.

Abrasive: Match the abrasive to the workpiece (aluminum, cast iron or steel) and to your machine for the longest belt life.

Bond: Double-layer, heat-resistant resin holds abrasive firmly. Bond is so strong that grains wear out instead of loosening.

Selection Guide: which abrasive works best on what materials...

ALUMINUM	CAST IRON	STEEL	Zirconia-Alumina (40g)
			Silicon-Carbide (40g)
			Silicon-Carbide (80g)



Buy 3 or 4 belts, save 10% off jobber
Buy 5 or more, save 15% off jobber

Resin Backing: Waterproof, poly-back belt won't tear or fray. It's the toughest backing of any resurfacing belt.

See list of machines and belt sizes below to determine which belt(s) you need.

Silicon-Carbide 40-grit:
• Good-quality • Black
• Primarily for cast iron but can resurface aluminum if extra care is used
• Down-pressure optional

Silicon-Carbide 60-grit:
• Good-quality • Black
• Primarily for cast iron but can resurface aluminum if extra care is used
• Down-pressure optional

Silicon-Carbide 80-grit:
• Good-quality • Black
• Designed especially to resurface aluminum
• Down-pressure not recommended

Zirconia-Alumina 40-grit:
• Better-quality
• Blue
• Grains fracture under pressure to stay sharp
• For cast iron or steel
• Down-pressure recommended

Zirconia Alumina With Grind Aid - 40-grit:
• Premium-quality belt with pre-applied Grind Aid • Blue/Green
• Excels on severe applications
• Grains fracture under pressure to stay sharp
• For stainless steel, alloy
• Down-pressure required

Belts with * are made to order. Please allow 3 to 5 working days for delivery.



Belt Size	Jobber	Order No.	Jobber	Order No.	Jobber	Order No.	Jobber	Order No.	Jobber	Order No.
10" x 87"	\$40.99	SGS-10-87	\$36.99	SGS-10-87-60*	\$33.99	SGA-10-87*	\$37.99	SGB-10-87*	\$54.99	SGZ-10-87*
10" x 103"	42.99	SGS-10-103	43.99	SGS-10-103-60	39.99	SGA-10-103*	49.99	SGB-10-103	59.99	SGZ-10-103*
11 1/8" x 76"	34.99	SGS-11-76	34.99	SGS-11-76-60*	33.99	SGA-11-76	41.99	SGB-11-76	52.99	SGZ-11-76*
11 1/8" x 79"	37.99	SGS-11-79	36.99	SGS-11-79-60	35.99	SGA-11-79	44.99	SGB-11-79	54.99	SGZ-11-79
11 1/8" x 89"	41.99	SGS-11-89	39.99	SGS-11-89-60	38.99	SGA-11-89	47.99	SGB-11-89	58.99	SGZ-11-89
11 1/8" x 91"	41.99	SGS-11-91	39.99	SGS-11-91-60	39.99	SGA-11-91	48.99	SGB-11-91	62.99	SGZ-11-91*
11 1/8" x 101"	44.99	SGS-11-101	41.99	SGS-11-101-60*	41.99	SGA-11-101	54.99	SGB-11-101	64.99	SGZ-11-101*
14" x 86"	45.99	SGS-14-86	45.99	SGS-14-86-60	43.99	SGA-14-86	56.99	SGB-14-86	67.99	SGZ-14-86
14" x 103"	52.99	SGS-14-103	48.99	SGS-14-103-60	48.99	SGA-14-103	69.99	SGB-14-103	74.99	SGZ-14-103
14" x 107 1/2"	54.99	SGS-14-107	53.99	SGS-14-107-60	52.99	SGA-14-107	74.99	SGB-14-107	79.99	SGZ-14-107
14" x 113 1/2"	59.99	SGS-14-113	58.99	SGS-14-113-60	57.99	SGA-14-113	79.99	SGB-14-113	81.99	SGZ-14-113*
15" x 127 1/2"	64.99	SGS-15-127	81.99	SGS-15-127-60*	63.99	SGA-15-127	81.99	SGB-15-127	89.99	SGZ-15-127

Colors may vary due to manufacturing process. Guaranteed for 1 year from original purchase date.

Belt/Machine Compatibility **tech tips**

Belt Size	Machine(s)
10" x 87"	Rogers SB-1028, SF-1028, T&S Machine, Master Tool 1029
10" x 103"	Rogers SF-1036, T&S Machine, Master Tool PS1036
11 1/8" x 76"	Winona Van Norman BG-600
11 1/8" x 79"	RMC, Peterson RG-1203
11 1/8" x 89"	RMC-800, Serv-Equip PG-1229
11 1/8" x 91"	Peterson RG-1234, Kansas Instruments
14" x 86"	Automotive Craftsman
14" x 103"	Master Tool
14" x 107"	Kwik-Way 870 Master Surfacer
14" x 113 1/2"	Storm Vulcan/Anderson AB-1000A, Peterson PG-1400
15" x 127 1/2"	Storm Vulcan/Anderson AB-1540A, Anderson AB-1560, IDL HS-4350, Peterson PG-1500, Winona Van Norman BR-1500, BG-1515 & BG-1520



Semi-Synthetic Belt Resurfacer Coolant

- Rust-inhibiting
- For ALL belt resurfacers with a coolant sump
- Dilute 30 parts water to 1 part coolant

Size	Jobber	Order No.
1 Gallon (3.79L)	\$ 59.99	SGB-10
5 Gallons (18.39L)	299.99	SGB-50

CYLINDER HEAD REBUILDING
CLEANING, ASSEMBLY & SAFETY
SHORT BLOCK REBUILDING
FLYWHEEL GRINDING
CRANKSHAFT/ TOOLS & SUPPLIES
MISCELLANEOUS
BRAKE SERVICE TOOLING
MEASURING TOOLS
V-TWIN & METRIC HARD PARTS



"We are committed to maintaining your privacy. Information about you and your business is never sold, rented or given to anyone outside of our company."

- Sue, Goodson Office Manager - 39 years of service

CYLINDER HEAD REBUILDING
CLEANING, ASSEMBLY & SAFETY
SHORT BLOCK REBUILDING
CRANKSHAFT/ FLYWHEEL GRINDING
MISCELLANEOUS TOOLS & SUPPLIES
BRAKE SERVICE TOOLING
MEASURING TOOLS
V-TWIN & METRIC HARD PARTS

SAVE! Buy a complete set of 8 or more segments and take 10% off jobber!

tech tips
from the techxperts™

4 Keys to Resurfacing Aluminum Heads

- 1 - Choose the correct abrasive**
Use a speckled wheel segment to grind aluminum heads.
- 2 - Lubricate, Lubricate, Lubricate**
Put a light coat of **Grind Aid (GRA-10)** on the abrasive to reduce aluminum build up. Speed up the traverse and reduce the cut to .0005" to .0010" per pass.
- 3 - Dress for Success**
Keep grains open by dressing often. Don't dress before the last pass, but be sure to apply Grind Aid liberally so the stone yields a finer surface finish.
- 4 - Keep heat build-up to a minimum**
The greatest danger is heat build up that can cause scoring as aluminum transfers to the stone. Take shallow cuts and use plenty of lubrication to prevent this.

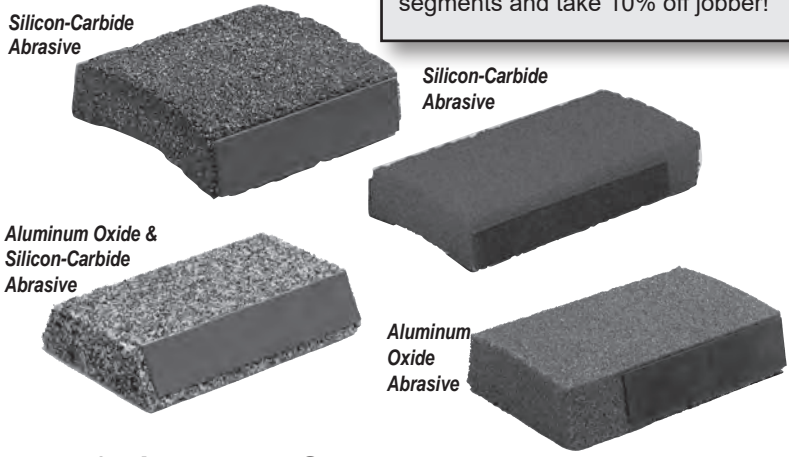

Resurfacing Wheel Segments

Segments are available in a variety of compositions. Match the abrasive to the material for best results and longest life. Order segments in 8, 10 or 12 piece sets.

Width	Thickness	Length	Application	Abrasive	Color	Jobber 1+	Jobber 8+	Order No.
2.56"/65mm	0.98"/25mm	3.94"/100mm	Cast Iron & Aluminum	Silicon-Carbide	Black	\$29.99	\$26.99	GS-PBS
			Steel & Hardened Metals	Aluminum Oxide	White	29.99	26.99	GS-PBS-1
			Aluminum, Cast Iron, Hardened Iron & Steel	Aluminum Oxide and Silicon-Carbide	Speckled	29.99	26.99	GS-PBS-2
			Steel & Hardened Metals	Aluminum Oxide	Ruby	29.99	26.99	GS-PBS-3
For Peterson/Peterson Berco 1055 AWL, RSC950 (std.), SYP320, -360, -1000, -1300, RSC1200, -1550, RPYS1500 models. For Winona Van Norman SM-2000, SM-4000/5000, MG-4000, SM-6000C/6000A and MG-3000/3850 models. For Storm Vulcan RT7Y Late (Serial No. 103152 and up) and RT 17Y Late (Serial No. 128697 and up) models.								
3.13"/79mm	0.81"/21mm	3.13"/79mm	Cast Iron & Aluminum	Silicon-Carbide	Black	\$28.99	\$26.09	GS-SVS
			Aluminum, Cast Iron, Hardened Iron & Steel	Aluminum-Oxide and Silicon-Carbide	Speckled	28.99	26.09	GS-SVS-2
For Peterson/Peterson Berco RG-32, RTY, RG-35, RG-300/900 models. For Storm Vulcan RT 7Y Early (Serial no. up to 103151) and RT 17Y Early (Serial no. up to 128696)								
1.97"/50mm	0.67"/17mm	3.62"/92mm	Cast Iron & Aluminum	Silicon-Carbide	Black	\$31.99	\$28.71	GS-RGS
For Peterson/Peterson Berco RG-32, RG-300/900 models.								
2.56"/65mm	0.79"/20mm	3.94"/100mm	Steel & Hardened Metals	Silicon-Carbide	Black	\$28.99	\$26.09	GS-KWS
			Aluminum, Cast Iron, Hardened Iron & Steel	Aluminum-Oxide and Silicon-Carbide	Speckled	28.99	26.09	GS-KWS-2
For Kwik-Way 858 and 862 models								

tech tips from the techxperts™
To maintain proper cutting action Goodson strongly recommends that you replace your cylinder head resurfacing segments in full sets. See your user's manual for wheel diameter and number of segments required. Due to manufacturing process colors may vary. Need help choosing the abrasive? Call the Goodson Techxperts™

Resurfacing Segments are guaranteed for 1 year from original purchase date

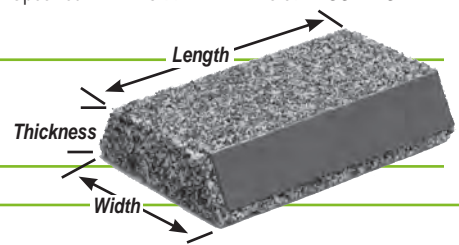

Import / Metric Cylinder Head Stud Stretchers

- Save time, don't remove the studs from a head for resurfacing
- Put stud stretchers on two studs and leave the rest
- Sold in pairs

Length	Thread	Jobber	Order No.
3"	8mm x 1.25	\$60.99	SS-20
3 3/4"	8mm x 1.25	60.99	SS-30
3 3/4"	10mm x 1.25	60.99	SS-40

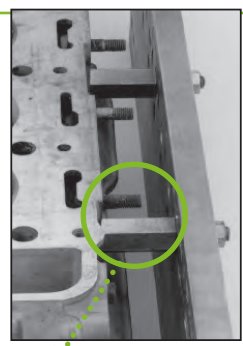

Surface Grinding Coolant for Segments and Single-Piece Wheels

- Synthetic
- Water soluble
- Non-foaming • Dilute 20:1

Size	Jobber	Order No.
1 Gallon / 3.78 L	\$ 39.99	SGC-10
5 Gallons / 18.93 L	199.99	SGC-50

Cylinder Head Resurfacing

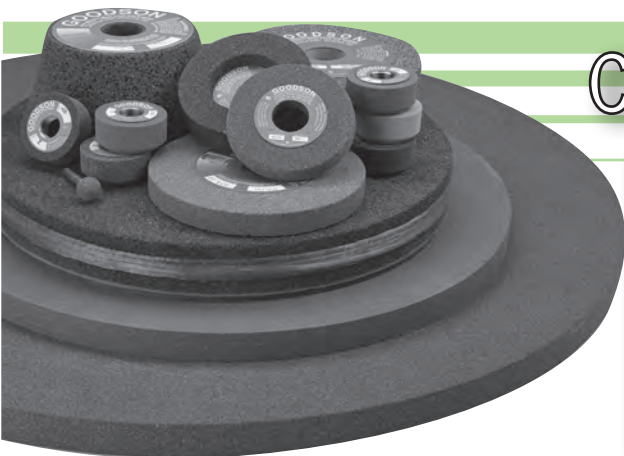

The most complete abrasives program in the industry ...

1. Consistent high quality abrasives

Each Goodson resurfer wheel is made to the highest standards of roundness, balance and strength. Extensive quality control, start-to-finish, lets us back our abrasives with our Iron-Clad Guarantee of total satisfaction.

2. Full inventory

Since we specialize in the distribution of abrasives to machine shops world wide we always carry an extensive inventory. Call Goodson, we have what you need on our shelves.

3. Same day shipping

We usually ship your order the same day that we receive it. Along with our huge inventory, our shipping speed ensures consistently faster delivery when you order from Goodson.

24 Grit Blanchard Grinder Wheels

- Includes gasket pad for mounting onto a Blanchard Grinder
- Also ideal for resurfacing clutch plates
- Wheel measures 11" x 5" x 9"
- Tape wound for added safety
- Excellent grade for most grinding conditions and metals
- Order No. **U69755** Jobber \$234.99



Radiac
Abrasives
A TYROLIT Company

Single-piece Resurfer Wheels

- Meet or exceed OE standards established for general purpose grinding applications
- Silicon-Carbide abrasive • Banding will wear off to expose more abrasive



U342040



GS-48

Peterson				
Machine Model(s)	Size: dia. x height x face width	Grit	Jobber	Order No.
All 14" Dry Grinders	14" x 1½" x 4" Plate	24	\$399.99	U342040
All 14" Dry Grinders	14" x 1½" x 4" Plate	36	749.99	GS-48

Grinding Wheels are guaranteed for 1 year from original purchase date



GS-545B



GS-545BL

NOTE: Plates are no longer painted, resulting in less warpage

Kwik-Way				
Machine Model(s)	Size: dia. x height x face width	Grit	Jobber	Order No.
545B,856,855-5,860	14" x 3" x 1½" (Serrated) Plate	24	\$739.99	GS-545B
545BL,860A, L & T	16" x 3" x 1½" (Serrated) Plate	24	824.99	GS-545BL

Grinding Wheels are guaranteed for 1 year from original purchase date



FG-1165-G



FG-1070A-G



FG-1045-G

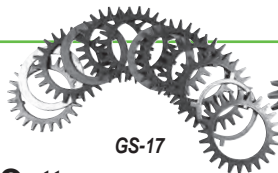

GS-17



GS-00



GS-0

Grinding Wheel Dressers & Replacement Cutters

Diamond Dresser Tools are available on pages 114-115

Applications	Cutter Assemblies				Replacement Cutters						
	OD	W	Jobber	Order No.	Pieces	Washers	OD	ID	Thick	Jobber	Order No.
Peterson (12mm shaft)					8 stars	3	2.375"	1.500"	.093"	\$30.99	GS-17
						1 w/locking tangs	1.750"	1.500"	.060"		
WVN SM2000, 4000, 5000, 6000C, 6000A, MG3000, 3850	1.250"	0.978"	\$32.99	FG-1165-G	7 stars	none	1.250"	0.313"	.095"	9.49	FG-1161-G
Peterson & DCM	2.375"	2.262"	87.99	FG-1070A-G	5 stars		2.375"	1.132"	.1375"	19.99	FG-1070-G
Hand held			58.99	FG-1045-G	1 stone	none	1.500"	0.313"	.6250"	15.49	FG-1044-G
Desmond Dresser for wheels to 10"			28.99	GS-0	4 blades, 2 spacers		0.250"			9.49	GS-00
					4 blades, 2 spacers		0.500"			10.49	GS-11

CYLINDER HEAD REBUILDING

CLEANING, ASSEMBLY & SAFETY

SHORT BLOCK REBUILDING

FLYWHEEL GRINDING

CRANKSHAFT/ MISCELLANEOUS TOOLS & SUPPLIES

BRAKE SERVICE TOOLING

MEASURING TOOLS

V-TWIN & METRIC HARD PARTS

"When you call Goodson, you speak to a person first - not a machine. We work hard to make sure we answer your calls promptly and avoid keeping you on hold."

- Ashley, Goodson Receptionist, 2 years of service



Scan the code at right with your smart phone or other smart device to watch **Magnetic Particle Inspection** on the Goodson website.



CYLINDER HEAD
REBUILDING

CLEANING,
ASSEMBLY & SAFETY

SHORT BLOCK
REBUILDING

CRANKSHAFT/
FLYWHEEL GRINDING

MISCELLANEOUS
TOOLS & SUPPLIES

BRAKE SERVICE
TOOLING

MEASURING
TOOLS

V-TWIN & METRIC
HARD PARTS



MMP-100

Ergonomic handle design for less operator fatigue.

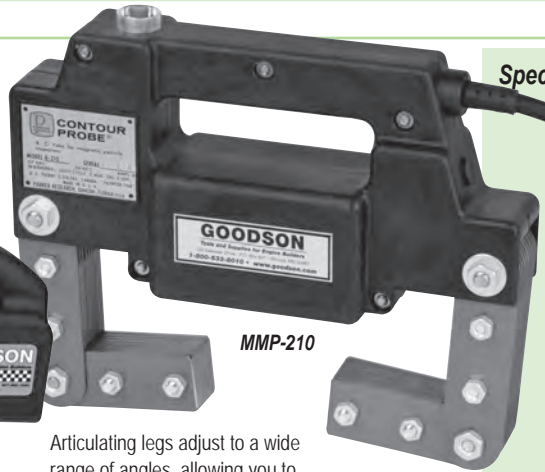

MMP-210

Articulating legs adjust to a wide range of angles, allowing you to test uneven surfaces with ease

Specifications



MMP-100 / MMP-100S

Physical: 7 3/8" x 9 1/4" x 2 1/8"
187 x 235 x 54mm
Max. Span: 12" (304.8mm)
across poles
Voltage: 115V (MMP-100)
230V (MMP-100S)
Line Current: 4 amp (MMP-100)
3 amp (MMP-100S)
Weight: 6.5 lb (2.95 kg)
Cord: 10' L, 3-wire



MMP-210

Physical: 10 1/2" x 11" x 2 3/4"
266 x 280 x 70mm
Max. Span: 18" (457mm) across
poles
Voltage: 115V (MMP-210)
230V (MMP-210S)
Line Current: 8 amp (MMP-210)
3 amp (MMP-210S)
Weight: 13 lb (5.9 kg)
Cord: 10' L, 3-wire

Magnetic Crack Detection Units

- Articulating legs conform to virtually any surface configuration
- Designed for one-person operation • Lightweight • No transformer box to drag around • 230V units feature a pigtail on the cord • Easy to access switches • Full 1-Year Manufacturer's Warranty for Repair • 50% duty cycle (example: 2 minutes on, 2 minutes off) • Produce a strong AC magnetic field



Description	Jobber	Order No.
115V Electronic Crack Detector with 10# Pull	\$669.99	MMP-100
115V Heavy Duty Electronic Crack Detector with 22# Pull	804.99	MMP-210
230V Electronic Crack Detector with 10# Pull (subject to stock on hand)	599.99	MMP-100S

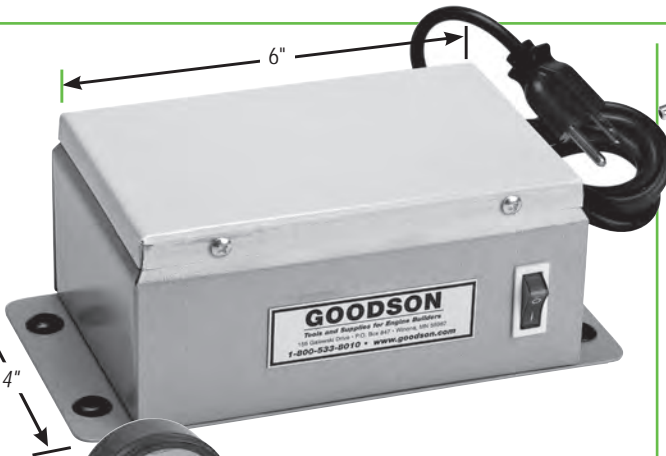

MFI-10010

Small Parts Demagnetizer

Don't jeopardize your engine work! Heat, friction and magnetic particle inspection can cause magnetism to build up in your engine components. If not removed, it will attract ferrous materials in engine lubrication and may cause premature engine failure. This easy to use table demagnetizer is a fast and easy way to ensure that all residual magnetism is eliminated from engine components. Use with the optional Magnetic Field Indicator (MFI-10010) to be sure all remaining magnetism has been fully eliminated.

Description	Jobber	Order No.
Small Parts Demagnetizer	\$154.99	SPD-46
Magnetic Field Indicator	114.99	MFI-10010



MM-301

WCD-266-G

Magnetic Powder Applicators

- A quick & easy method for distributing magnetic powder

Description	Jobber	Order No.
Atomizer Assembly for small areas (1 oz.)	\$28.99	MM-301
Applicator Bulb for large areas	28.99	WCD-266-G
Replacement Bulb for Atomizer Jar	15.49	MM-301-1

Non-Fluorescent Magnetic Powder for Dry Method Particle Inspection

- Works with all dry magnets including Magnaflux® and Parker
- Store in a moisture free environment

Color/Size	1 lb.	5 lb.	25 lb.
White/Gray	WCD-100-G	WCD-500-G	WCD-2500-G
Yellow	WCD-101-G	WCD-501-G	WCD-2501-G
Red	WCD-103-G	WCD-503-G	WCD-2503-G
Jobber ea.	\$12.99	\$64.99	\$279.99



Crack Detection



Scan the code below with your smart phone or other smart device to view our **Chemical Crack Detection** Video on the Goodson website.



Alumni-Chek

- Find surface cracks on aluminum & cast iron without electricity or special lights
- Ideal for aluminum, but also works on brass, cast-iron, steel, carbide, and Stellite • Even the tiniest cracks show as bright red • Complete kit includes Cleaner, Penetrant, Developer and Shop Towels (also available separately)

Description	Jobber 1+	Jobber 12+	Order No.	Incl.
Complete Kit	\$46.99		AC-KIT*	▼
Cleaner Aerosol*	21.99	\$19.79	AC-1*	x
Penetrant Aerosol*	21.99	19.79	AC-2*	x
Developer Aerosol*	21.99	19.79	AC-3*	x
5 Towels	3.99		WST-5	x

Mix or match Cleaner, Penetrant & Developer to make a case of 12 and save 10% off Jobber!

*Hazardous Goods Fees Apply When Shipped By Air



Maxxeon® WorkStar® 364 USB Rechargeable UV Leak Detection Pen/Inspection Light

- 3.7V 570mAh, 2.1 Wh Lithium battery with USB charger
- Run time: 35 min. continuous, 2 hr. intermittent operation
- Use with Goodson Glow for crack detection
- Easily adjustable beam to suit application
- Drop tested to 6 feet
- Order No. **DFL-364** Jobber \$49.99



Magnetic Crack Detection Spray

- Use with your magnetic crack inspection unit
- Applies quickly and easily — just spray it on the area you want to check
- Glows brightly under black-light
- 32 oz. non-aerosol spray
- Order No. **MFA-32** Jobber \$47.99

tech tips

from the techxperts™

- Step 1:** Spray cleaner evenly on the surface and allow it to dry completely.
- Step 2:** Spray on Penetrant. Allow to saturate for 5 minutes. Wipe off excess to avoid false readings.
- Step 3:** Spray on thin layers of developer to build up a uniform powdery film.
- Step 4:** Flaws and cracks will glow brightly when viewed under the black light (Applies only to Goodson Glow).



GOODSON Glow Crack Detection Sprays

- Easily detect surface cracks that could be missed with just visual inspection
- Cracks & flaws glow brightly under black light after treatment with Cleaner, Penetrant and Developer

Description	Jobber 1+	Jobber 12+	Order No.
Goodson Glo Cleaner Aerosol*	\$22.99	\$20.69	GLO-1*
Goodson Glo Penetrant Aerosol*	30.99	27.89	GLO-2*
Goodson Glo Developer Aerosol*	48.99	44.09	GLO-3*

Mix or match Cleaner, Penetrant & Developer to make a case of 12 and save 10% off Jobber.

*Hazardous Goods Fees Apply When Shipped By Air



Crack Detection Powder & Oil Carrier

- For wet method crack detection
- Mix powder with oil carrier
- Use with Ultra Violet Inspection Light to view results

	Size	Jobber	Order No.
Powder	4 oz. / 113.4g	\$ 58.99	GCR-14A-4
	1 lb. / 453.6g	219.99	GCR-14A
Oil Carrier	5 Gallons / 18.93L	154.99	GCR-50



Magnetic Crack Detection Oil

- Oil impregnated with magnetic powder (**GCR-14A, GCR-14A-4**) to glow under black-light
- Low viscosity oil flows into small cracks • Oil clarity makes cracks easier to see • Aerosol Spray is pre-mixed oil and carrier
- Order No. **MFA-50** Jobber \$179.99

CYLINDER HEAD REBUILDING
CLEANING, ASSEMBLY & SAFETY
SHORT BLOCK REBUILDING
FLYWHEEL GRINDING
CRANKSHAFT/ TOOLS & SUPPLIES
BRAKE SERVICE TOOLING
MEASURING TOOLS
V-TWIN & METRIC HARD PARTS

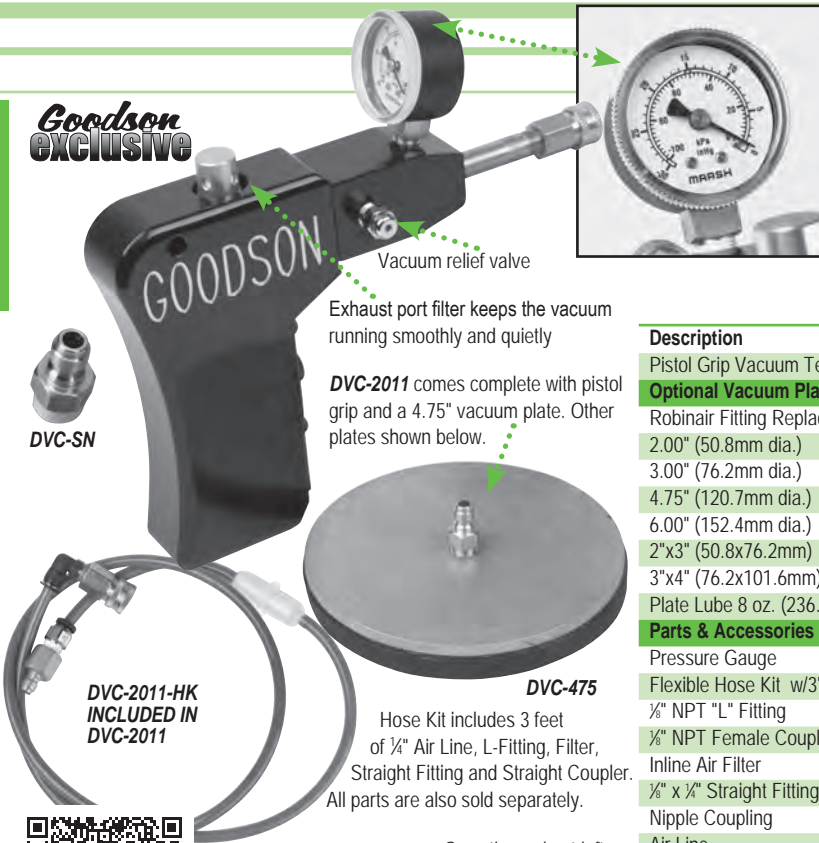
**Goodson
exclusive**

DVC-SN

DVC-2011-HK
INCLUDED IN
DVC-2011Exhaust port filter keeps the vacuum
running smoothly and quietlyDVC-2011 comes complete with pistol
grip and a 4.75" vacuum plate. Other
plates shown below.

DVC-475

Hose Kit includes 3 feet
of 1/4" Air Line, L-Fitting, Filter,
Straight Fitting and Straight Coupler.
All parts are also sold separately.Scan the code at left
with your smart phone
or other device to view
the product video.**Pistol Grip Vacuum Tester**

- Lightweight - only 1.9 lbs. without the plate
- Pulls and holds up to 24" vacuum on as little as 90 PSI
- Quick coupling Robinair fittings
- Easy to reach controls for single-handed operation
- Hard-anodized billet aluminum
- Tester includes one 4.75" vacuum plate and hose kit with filter

Description	Jobber	Order No.	
Pistol Grip Vacuum Tester Kit	\$849.99	DVC-2011	Incl. ▼
Optional Vacuum Plates			
Robinair Fitting Replacement Plate Set	\$184.99	DVC-7KIT	▼
2.00" (50.8mm dia.)	28.99	DVC-2	x
3.00" (76.2mm dia.)	31.99	DVC-3	x
4.75" (120.7mm dia.)	31.99	DVC-475	x x
6.00" (152.4mm dia.)	34.99	DVC-6	x
2"x3" (50.8x76.2mm)	26.99	DVC-23	x
3"x4" (76.2x101.6mm)	33.99	DVC-34	x
Plate Lube 8 oz. (236.6 mL)	6.79	DVC-PL	x
Parts & Accessories			
Pressure Gauge	\$51.49	DVC-GAUGE	
Flexible Hose Kit w/3' Air Line (optional)	54.99	DVC-2011-HK	▼
1/8" NPT "L" Fitting	5.79	CF-2003-L	x x
1/8" NPT Female Coupling	19.99	LDP-AR-6	x x
Inline Air Filter	14.49	DVC-FILTER	x x
1/8" x 1/4" Straight Fitting	9.99	DVC-SF	x x
Nipple Coupling	9.49	DVC-1N	x x
Air Line	lineal foot price 2.99	CF-2001-AL	x x
Robinair Fitting	9.49	DVC-SN	
1/8" NPT Male Coupling	22.99	DVC-1M	
6 Pc. Replacement Foam Set (1 of each size)	41.99	FOAM-KIT	
Replacement Foam Mat - 11" x 31" x 3/8"	45.99	DVC-1131	

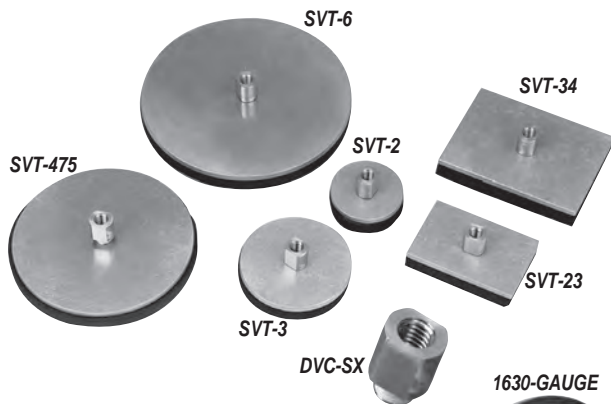
**Sioux-Style Replacement
Vacuum Tester Parts**

- For Sioux™ 1630K Tester no longer made
- Closed cell foam for an exceptional seal

Sioux-Style Replacement Plates for the 1630K Tester

Size	OE No.	Jobber	Order No.
2" / 50.8mm dia.	1630-2	\$37.99	SVT-2
3" / 76.2mm dia.	1630-3	40.99	SVT-3
4.75" / 120.7mm dia.	1630-4	40.99	SVT-475
6" / 152.4mm dia.	1630-6	46.99	SVT-6
2"x3" / 50.8 x 76.2mm		37.99	SVT-23
3x4" / 76.2 x 101.6mm		40.99	SVT-34

Replacement Parts for the 1630K Tester

Replacement Fitting	\$16.49	DVC-SX
Replacement Gauge	58.99	1630-GAUGE

**Heavy Duty Manual
Vacuum Tester**

- A steady reading of 25" (63.5cm) indicates proper valve seating
- All metal construction
- 4 1/2" plate, fittings and plate lube included
- DVC Plates (above) will fit this tester

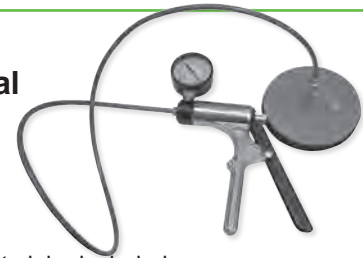

Description	Jobber	Order No.
Manual Vacuum Tester	\$189.99	DVC-101-HD
Replacement 4.75" Plate	31.99	DVC-475
Plate Lube - 8 oz. (236.6 mL)	6.79	DVC-PL

Vacuum Testing

Vacuum testing is the fastest method for testing valve to seat integrity. Simply assemble your machined cylinder head and install the spark plugs. Use a reliable vacuum source producing approximately 24" HG on the vacuum gauge and a closed cell foam test plate with a through fitting to draw down or evacuate the combustion chamber.

Once you've reached 24" HG on the gauge and close the vacuum to the chamber. Watch the gauge for a drop in vacuum. It should hold steady confirming that you have achieved valve to seat mating.

Coat the face of your closed cell foam test plate with Plate Lube (DVC-PL) to condition the foam. This produces a soft, yielding material that will fill minor head surface blemishes or imperfections.

tech tips
from the techperts™



Handy toggle switch turns the unit on and off.



Inline filter keeps debris out of the unit for longer life and more power.



Vacuum control knob has 3 settings — continuous, hold and release

Trego Electric Vacuum Tester

- Check valve to seat seal right on the bench or in the engine compartment — no special set up is required
- This unit is equipped with a vacuum piston pump and generates up to 850 Mbar of vacuum • Reads in PSI
- A built-in pressure control knob allows you to control vacuum settings accurately • 115V, 60Hz, 67W motor
- Dimensions: 9⁷/₈"L x 6³/₄"W x 4¹/₂"H

Description	Jobber	Order No.	Incl.
Electric Vacuum Tester	\$1679.99	VT-KIT	▼
2.00" (50.8mm dia.)	28.99	DVC-2	x
3.00" (76.2mm dia.)	31.99	DVC-3	x
4.75" (120.7mm dia.)	31.99	DVC-475	x
6.00" (152.4mm dia.)	34.99	DVC-6	x
2"x3" (50.8x76.2mm)	26.99	DVC-23	x
3"x4" (76.2x101.6mm)	33.99	DVC-34	x
Plate Lube 8 oz. (236.6 mL)	6.79	DVC-PL	x
1/4" Air Line (6')	lineal foot price 2.99	CF-2001-AL	x
Inline Air Filter	14.49	DVC-FILTER	x
1/8" NPT Female Coupling	19.99	LDP-AR-6	x

Jet Valve Eliminator Kit

- Some Mitsubishi/Chrysler 2.6L heads had jet valves while some didn't
- This kit lets you use a jet valve equipped head in place of one without
- 11mm diameter, 1.0 pitch threaded plugs replace entire valve body assembly
- Easier than welding the holes closed
- Package of 4 converts one 2.6L head
- Order No. **JVE-26** Jobber \$29.99



.235" Crack Repair Kit

- Complete kit includes everything you need to repair cracked cast iron heads using the cold repair process • Download the Goodson Crack Repair Manual by scanning code at right with the camera on your smart phone or other smart device



Description	Jobber	Order No.	Incl.
Complete Repair Kit:	\$499.99	CRK-150	▼
.235" x 1 ⁵ / ₁₆ " Threaded Iron Plugs (100 Pk.)	174.99	CRP-235	1
High Speed Steel Drill	8.49	CRD-235	1
High Speed Steel Tapered Reamer	109.99	CRR-235	1
High Speed Steel Tapered Taps	75.99	CRT-235	2
Cut-Off Saw with Blade	34.99	CR-SAW	1
Replacement Saw Blade	11.99	CR-BLADE	1
Cutting & Tapping Fluid*	14.99	CTF-14	1
All Weather Seal (16 oz.)	25.99	AWS-16	1
Ceramic Motor Seal (16 oz.)	26.99	CRS-16	1

*Hazardous Goods Fees Apply When Shipped By Air

Threaded Crack Repair Plugs

- Iron • Tapered • Threaded plugs
- Cast to rigid specifications

Plug Size	Qty.	Jobber	Order No.
.200" x 1 ⁵ / ₁₆ "	100	\$174.99	CRP-200
.200" x 1/2"	100	174.99	CRP-201
.235" x 1 ⁵ / ₁₆ "	100	174.99	CRP-235
.327" x 1 ⁵ / ₁₆ "	50	139.99	CRP-327



High Speed Steel Drills

- 118° points for fast chip removal

Plug Size	Jobber	Order No.
.200"	\$8.49	CRD-200
.235"	8.49	CRD-235
.327"	9.49	CRD-327



Tapered Reamers

- High Speed Steel

Plug Size	Jobber	Order No.
.200"		
.235"	\$109.99	CRR-235
.327"	154.99	CRR-327



Tapered Taps

- High strength steel machined to match plug taper & thread

Plug Size	Jobber	Order No.
.200"	\$82.99	CRT-200
.235"	75.99	CRT-235
.327"	97.99	CRT-327





"At Goodson, we're always on the lookout for new or improved tools that make engine rebuilding easier. If you have a tool you think we'd be interested in, give us a call."

- Richard, Goodson Product Manager, 25 years of service

CYLINDER HEAD
REBUILDING

CLEANING,
ASSEMBLY & SAFETY

SHORT BLOCK
REBUILDING

CRANKSHAFT/
FLYWHEEL GRINDING

MISCELLANEOUS
TOOLS & SUPPLIES

BRAKE SERVICE
TOOLING

MEASURING
TOOLS

V-TWIN & METRIC
HARD PARTS

shown actual size



melted center
reveals
overheating



Heat Tabs

- Provides visual evidence of engine overheating
- Special heat sensitive metal centers melt and fall out when engine exceeds the melting point of the tab
- 100 Heat Tabs per package
- Attach to heads with Heat Tab Adhesive (below)

Description	Melting Point	Jobber	Order No.
Round Heat Tabs	255-260° F / 124-127° C	\$51.99	RHT-100
Round Ironite Heat Tabs	255-260° F / 124-127° C	97.99	HT-100RD
Round Diesel Heat Tabs	225-235° F / 107-110° C	61.99	DHT-100
Heat Tab Adhesive (3 oz./88.7mL tube)		11.49	HTA-3

Leak Detection Mat

- Commercial-grade Neoprene
- Resists petroleum products, abrasion, swelling, sunlight and aging
- Repair worn mats or make custom leak detection plates
- Measures 3' x 4' x 3/16" thick
- Order No. **LDP-34MAT** Jobber \$104.99



Rust Inhibitor for Pressure Testing

- Clear fluid inhibits rust and does not discolor or cloud the test tank solution
- Lets you see better to pressure test
- Biocide and anti-rust additives extend tank solution life while preventing corrosion
- Synthetic formula
- Mix 20:1 with water
- Yields 20 gallons
- Order No. **PRI-10** Jobber \$39.99



Seal-All™

- Seals pin holes, porosity and small cracks in heads & blocks
- Penetrates and seals
- Out-performs ceramics
- Bonds with existing rust & corrosion to prevent spread
- Heat at 175°-200°F (79.4°-93.3°C) for 4 hours to cure
- Not for use on assembled engines
- 32 oz. (946 mL)
- Order No. **CPS-32** Jobber \$81.99



Fluid Weld®

- For cast iron or aluminum heads and blocks
- Use as a sealant for threaded or press-fit parts like valve guides and seats, threaded crack repair plugs, replacement studs, etc.
- Seals small cracks • Non-toxic
- Non-flammable
- **NOT** for use on assembled engines
- Withstands temperatures to 3000°F



Size	Jobber	Order No.
2 oz. (59 mL)	\$ 51.99	FW-2
8.8 oz. (260 mL)	164.99	FW-88

All Weather Seal

- Seals intakes & head gasket leaks
- Seals cracks in cylinder heads & engine blocks
- Prevents anti-freeze from seeping through gaskets and hoses
- Lubricates water pump seals
- Mixes with all anti-freeze and coolant
- Works in less than 5 minutes
- Fast-acting, non-corrosive, non-clogging
- Can be used with coolant or anti-freeze
- 16 oz./455 mL • Order No. **AWS-16** Jobber \$25.99



Ceramic Motor Seal

- Permanently seals leaking head gaskets, cracked heads and blocks (aluminum or cast iron)
- Coats the engine to inhibit rust formation and salt water corrosion during normal operation
- Seals porous castings in the cooling system
- Stops coolant leaks
- Not compatible with any anti-freeze or coolant, follow instructions on package
- Promotes heat dissipation for added power
- 16 oz./455 mL
- Order No. **CRS-16** Jobber \$26.99



Misc. Cylinder Head

S-373P
Pilot shown installed



Rocker Arm Stud Conversion Kit

- Convert pressed-in rocker arm studs to threaded studs
- Remove stud, face stud boss, then drill and tap the stud hole
- Use with a seat and guide machine

Description	Jobber	Order No.	Incl.
Conversion Kit	\$164.99	S-450-KIT	▼
Stud Boss Facer	154.99	S-450-F	x
3/8" Drill Bit	14.49	S-373D	x
7/16" x 14 Thread Tap	23.99	S-437T	x
3/8" Pilot	57.99	S-373P	
2 Pc. Tap Guide	47.99	S-350G	



Economy Cylinder Head Holder

- Holds head with either side up
- Tapered pins fit virtually any size head bolt hole and loosen with a twist
- Ideal for guide sizing with ample clearance to remove arbors and reamers
- Two piece set • Order No. **HH-100-G** Jobber \$51.99

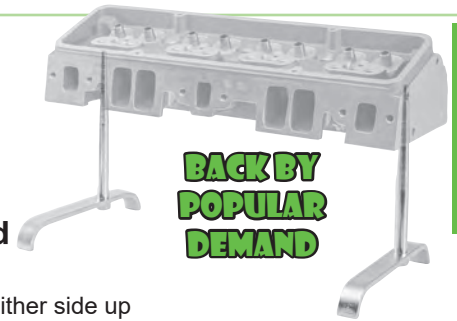

BACK BY POPULAR DEMAND

CYLINDER HEAD REBUILDING

CLEANING, ASSEMBLY & SAFETY

Manual Rocker Arm Stud Puller

- Heavy-duty ball bearing action
- Creates less stress and friction
- Fits 5/16" (7.9mm) and 3/8" (9.53mm) threaded studs
- Not recommended for use on thermally cleaned heads

Description	Jobber	Order No.
Complete Stud Puller	\$141.99	SP-600
Drive Nut	29.99	SP-601
Puller Body	59.99	SP-602
5/16" and 3/8" Mandrel	59.99	SP-603
Thrust Bearing	16.99	SP-604

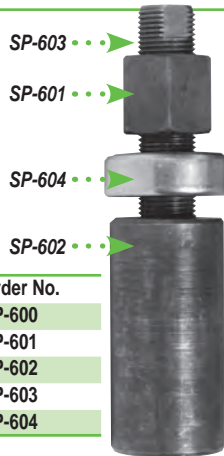

Ultra-Sturdy Cylinder Head Holder

- 360° stand holds head securely in position
- Tie-rod to prevent tipping
- Slip-resistant neoprene covered rails
- Fits domestic, foreign, truck & motorcycle heads
- 3-piece set
- Order No. **HH-450** Jobber \$144.99

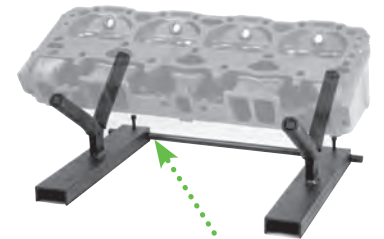

Set screws hold the two pieces firmly in place

SHORT BLOCK REBUILDING

FLYWHEEL, GRINDING CRANKSHAFT/

Universal Threaded Stud Extractor

- Use with your pneumatic impact tools & sockets (19/16" socket removes, 17/16" installs)
- Requires only 3/4" clearance to adjacent studs
- For threaded studs only • Fits 3/8" socket
- Hardened 3-jaw clamping system
- Internal taper support • Hollow body allows long studs to extend through the tool
- 1 1/2" dia. x 2 7/8" long • 1/4" - 1/2" range

Description	Jobber	Order No.
Universal Stud Extractor	\$149.99	PSR-375
Replacement Parts	131.99	PSR-JAWS
Spring Set (3 Piece)	7.99	PSR-3S
Snap Ring	6.29	PSR-SR



Universal Cylinder Head Holder

- Accommodates all types of cylinder heads
- Sturdy, durable, lightweight aluminum construction
- Slip-resistant neoprene covered rails
- Place heads quickly into any position and rotate them easily through 360°
- Requires no bolts, clamps or adaptors
- 2 piece set • Order No. **HH-200** Jobber \$174.99

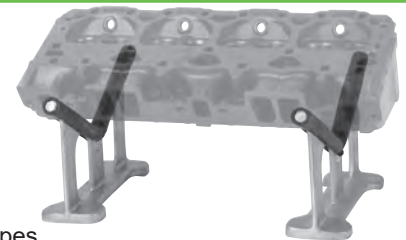

MISCELLANEOUS TOOLS & SUPPLIES

BRAKE SERVICE TOOLING

Torque-Angle Indicator

- When torque is given as degrees of turn past a certain ft./lb., use this gauge to show degrees
- Hold metal base with one hand
- Plastic dial turns as you tighten
- Fits between a socket-driven extension and the socket
- 1/2" square drive
- Order No. **TQR-4554** Jobber \$29.99



Professional Measuring & Inspection Stand

- Length adjusts up to 23"
- Rotate work to view or measure
- Solid aluminum frame with self lubricating, corrosion and chemical-resistant wear surfaces
- Order No. **PMIS-30** Jobber \$149.99

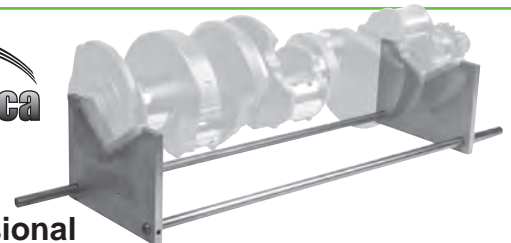

MEASURING TOOLS

V-TWIN & METRIC HARD PARTS



"We pride ourselves on getting orders to you quickly. We stock a wide variety of products in our warehouse and we use most shipping carriers so you can receive your order in 3 days or less."

- Shawn K. Goodson Shipping, 4 years of service

CYLINDER HEAD
REBUILDING

43 Piece Deluxe Porting Kit

- Professional grade porting supplies
- Packed in a clear plastic storage case

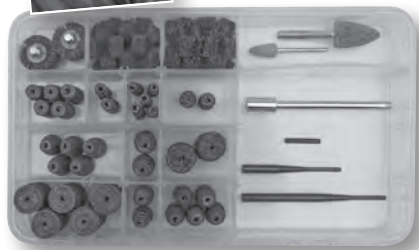

Description	Jobber	Order No.	Incl.
43 Pc. Kit	\$114.99	DPK-100	▼
Replacement Abrasives	Grit	Kit Qty.	
Flap Wheels - 1"x1"x1/4"	120	2	\$10.49 AFW-1-120 x
Cross Buffs 3 Ply, 1 1/2"	Med.	2	39.99 CB-15M-HD x
	Very Fine	2	39.99 CB-15VF-HD x
Cross Buff/Flapwheel Mandrel		1	14.99 CB-MANDREL x
1/4" Dia. Straight	40	2	28.99 SCR-250-40 x
Cartridge Rolls	80	5	28.99 SCR-250-80 x
3/8" Dia. Straight	40	2	32.99 SCR-375-40 x
Cartridge Rolls	80	5	32.99 SCR-375-80 x
3/4" Dia. Straight	40	2	66.99 SCR-750-40 x
Cartridge Rolls	80	2	66.99 SCR-750-80 x
1/2" Dia. Half Tapered	40	2	47.99 HTR-500-40 x
Cartridge Rolls	80	5	47.99 HTR-500-80 x
5/8" Dia. Full Tapered	40	2	55.99 FTR-625-40 x
Cartridge Rolls	80	5	51.99 FTR-625-80 x
Cartridge Roll Mandrel	2 3/4" Long	1	11.99 CR-275 x
	4" Long	1	12.99 CR-40 x
Mounted Points - 3/8" x 3/4"	60	1	9.99 GM-B52 x
	1 1/16" x 1 1/4"	60	9.99 GM-12 x

See next page for replacement abrasives

CLEANING,
ASSEMBLY & SAFETY

SHORT BLOCK
REBUILDING

CRANKSHAFT/
FLYWHEEL GRINDING

MISCELLANEOUS
TOOLS & SUPPLIES

TOOLING

MEASURING
TOOLS

V-TWIN & METRIC
HARD PARTS

Intake Port Reshaping Kit

- Superior formula uses 2-part epoxy
- Won't shrink when dry
- Mix ratio is 1:1 by weight
- Mix and knead the parts together by hand until the yellow and black colors have combined to make a uniform olive green color
- Working time at 70°F: Golf ball size mix: 40 minutes max.; Baseball size mix: 30 minutes max.
- Cure time at 70°F: full hardness in 6 to 8 hours
- Once cured, forms a hard coating resistant to abrasion, impact, water, chemicals and solvents
- **NOT** for use in contact with potable water or exhaust ports
- Can be milled or machined
- Withstands temperatures up to 500°F/ 260°C
- Kit includes epoxy, gloves and mixing sticks
- Yields 16 oz./453.6g of material
- 24 month shelf-life
- Order No. **PRK-99** Jobber \$43.99



tech tips

Adhesion of PRK-99 will be only as good as the cleanliness and soundness of the substrate. Remove all dirt, oil and grease. Soda blasting is acceptable. Scraping, wire brushing and other manual cleaning methods may also work. Do NOT use a petroleum-based cleaner before using PRK-99, it will prohibit adhesion.

NOTE: Extreme caution must be used when porting & polishing. Be sure to wear safety glasses.

small engine powersports

40 Piece Small Engine Porting Kit

- Professional grade porting supplies
- Packed in a clear plastic storage case



Description	Jobber	Order No.	Incl.
40 Pc. Kit	\$89.99	SEPK-5	▼
Replacement Abrasives	Grit	Kit Qty.	
Flap Wheels - 1"x1"x1/4"	120	2	\$10.49 AFW-1-120 x
Cross Buffs 2 Ply 3/4"	Very Fine	2	24.99 CB-75VF x
	1"	2	41.99 CB-1M x
	Very Fine	2	24.99 CB-1VF x
	1 1/2"	2	28.99 CB-15VF x
Cross Buff/Flapwheel Mandrel		1	14.99 CB-MANDREL x
3/8" Dia. Straight	80	4	32.99 SCR-375-80 x
Cartridge Rolls	120	4	32.99 SCR-375-120 x
	320	4	32.99 SCR-375-320 x
3/8" Half Tapered Cartridge Rolls	80	4	45.99 HTR-375-80 x
3/8" Full Tapered	80	4	34.99 FTR-375-80 x
Cartridge Rolls	120	4	34.99 FTR-375-120 x
1" x 2 Yds. Abrasive Roll	120	1	24.99 UR-1-120 x
	320	1	32.99 UR-1-320 x
Cartridge Roll Mandrel	2 3/4" Long	1	11.99 CR-275 x
	4" Long	1	12.99 CR-40 x

See next page for replacement abrasives

Quick Change Mandrels & Abrasive Sleeves

- 5 sleeves per pack • 1" x 1"
- Mandrel has 1/4" shaft



Description	Grit	Jobber	Order No.
Mandrel		\$ 9.99	GMS-101
Sleeves	40	10.29	GMS-140
5 Pack	60	10.29	GMS-160

Variable Speed Control



- Vary tool speed from 200 to 25,000 RPM
- Control switch with 3 settings – Variable Speed, OFF and Full Speed
- Speed control dial
- 31 1/2" long grounded cord with standard US plug • Fuse protected
- Built in grounded control outlet
- Not compatible with brushless motors
- Order No. **GEO-SC** Jobber \$61.99

Professional Porting & Polishing Tools

Aluminum Oxide Cloth Utility Shop Rolls

- 1" x 50 yards
- Easy to use ... just unroll and tear to length
- Use with butterfly mandrels at right

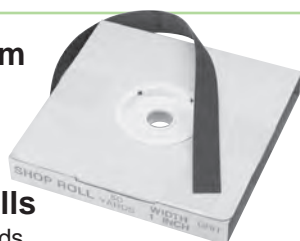

Grit	Jobber	Order No.
60	\$24.99	UR-1-60
80	25.99	UR-1-80
100	23.99	UR-1-100
120	24.99	UR-1-120
180	30.99	UR-1-180
320	32.99	UR-1-320

Crocus Cloth

- Must be used with Lapping Oil
- Great for final touch-ups on cranks, rod pins, valve stems, cams, etc.
- Use with slotted mandrels at right

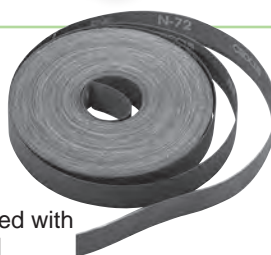

Description	Jobber	Order No.
1" x 50 yd. Roll	\$49.99	UR-1-CROCUS
4 oz. Lapping Oil	12.99	LP-LO-4
8 oz. Lapping Oil	21.99	LP-LO-8

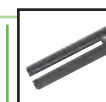

Slotted Butterfly Mandrels

- Use with roll abrasives such as those at left
- Several lengths available

Length	Jobber	Order No.
3"	\$ 7.49	BM-3
6"	13.49	BM-6
8"	14.99	BM-8

Want a different abrasive? We can make it in-house. Contact us for more information!

Replacement Abrasive Packs and Mandrels

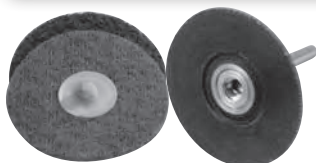

Replaceable Roll Lock Discs

10 per pack

Dia.	Jobber	Order No.
2" Medium	\$12.99	RSCD-2M
2" Coarse	14.99	RSCD-2C
3" Medium	20.99	RSCD-3M
3" Coarse	24.99	RSCD-3C
Disc Holder	Jobber	Order No.
2" Dia.	\$17.99	RLH-2
3" Dia.	19.99	RLH-3



Aluminum Machining Aid

- Designed for aluminum
- For porting & polishing with cartridge rolls, rotary files, emery cloth or Cross Buffs®
- Safe for cast iron
- 32 oz./946.4mL
- Order No. **PF-32** Jobber \$43.99

Hazardous Goods Fees Apply

Straight Cartridge Rolls

- 1½" long, ½" hole
- Fully glued • Box of 50

Dia.	Grit	Jobber	Order No.
¼"	40	\$28.99	SCR-250-40
	80	28.99	SCR-250-80
	120	28.99	SCR-250-120
¾"	40	32.99	SCR-375-40
	80	32.99	SCR-375-80
	120	32.99	SCR-375-120
1½"	40	34.99	SCR-500-40
	60	34.99	SCR-500-60
	80	34.99	SCR-500-80
2"	100	34.99	SCR-500-100
	120	34.99	SCR-500-120
	¾"	40	66.99
80		66.99	SCR-750-80
120		66.99	SCR-750-120

Roll Mandrels

Use with straight and tapered cartridge rolls • ½" pilot x ¼" dia.

OAL	Jobber	Order No.
2¼"	\$11.99	CR-275
4"	12.99	CR-40
6"	13.99	CR-60
8"	15.99	CRM-8H
10"	15.99	CRM-10H
12"	15.99	CRM-12H

Mirrored Safety Glasses

- Wrap-around design • Tinted lenses provide sun glare protection • Universal bridge • Polycarbonate lenses
- Do not use as welders helpers • Great for protecting your eyes when riding your motorcycle too
- Order No. **PGL-21** Jobber \$6.99



Half-Tapered Cartridge Rolls

- 1½" long, ½" hole
- Fully glued • Box of 50

Dia.	Grit	Jobber	Order No.
¾"	40	\$43.99	HTR-375-40
	80	45.99	HTR-375-80
1½"	40	47.99	HTR-500-40
	80	47.99	HTR-500-80

Full-Tapered Cartridge Rolls

- 1½" long, ½" hole
- Fully glued • Box of 50

Dia.	Grit	Jobber	Order No.
¾"	40	\$35.99	FTR-375-40
	80	34.99	FTR-375-80
	120	34.99	FTR-375-120
1½"	40	36.99	FTR-500-40
	60	36.99	FTR-500-60
	80	36.99	FTR-500-80
2"	120	51.99	FTR-500-120
	40	55.99	FTR-625-40
	80	51.99	FTR-625-80

3M® Cross Buffs®

- Aluminum-Oxide
- Box of 10

Dia.	Grit	Jobber	Order No.
2-Ply			
¾"	V. Fine	\$24.99	CB-75VF
	Med.	24.99	CB-75M
1"	V. Fine	24.99	CB-1VF
	Med.	41.99	CB-1M
1½"	V. Fine	28.99	CB-15VF
	Med.	28.99	CB-15M
3-Ply			
1¼"	Med.	\$39.99	CB-125M-HD
1½"	V. Fine	39.99	CB-15VF-HD
	Med.	39.99	CB-15M-HD

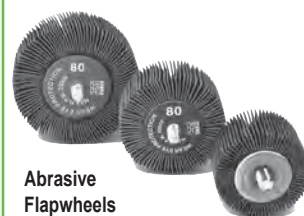

Abrasive Flapwheels

- 1" wide, ¼" x 20 threaded
- Aluminum-Oxide • 1 each

Dia.	Grit	Jobber	Order No.
1½"	80	\$14.99	APK-7
1"	120	10.49	AFW-1-120
2"	120	11.99	AFW-2-120
3"	120	13.99	AFW-3-120



- Cross Buff® / Flap Wheel Mandrel
- Use with Cross Buffs & Flap Wheels above

Description	Jobber	Order No.
4" Mandrel	\$14.99	CB-MANDREL
Set Screw (3)	6.99	CB-SCREW

NOTE: Extreme caution must be used when porting & polishing. Be sure to wear safety glasses.



"We unload, check and store inventory as efficiently & accurately as possible and we make sure all inventory is accounted for."

— Shane, Goodson Receiving Supervisor, 7 years of service

CYLINDER HEAD
REBUILDING

tech tips
from the techxperts™

Stay Safe:

Always ensure your burr shank is well inserted into your collet and clamped down tightly.

Keep pressure light and keep the burr moving focusing on the highest material first.

Ensure your work is secured tightly to your work bench.

Don't snag or jam your burr into your work.

Wear eye protection as a minimum, but better still, use a full shield for your face.

CLEANING,
ASSEMBLY & SAFETY

SHORT BLOCK
REBUILDING

Double Cut Carbide Rotary Files

FR-34-C



FR-45-C

• 1/4" dia. shank

Dia.	Length	Shank	Jobber	Order No.
1/2"	1 1/8"	1.1"	\$49.99	FR-34-C
1/4"	1"	1.0"	41.99	FR-45-C

CRANKSHAFT/
FLYWHEEL GRINDING

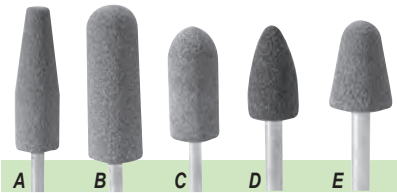

MISCELLANEOUS
TOOLS & SUPPLIES

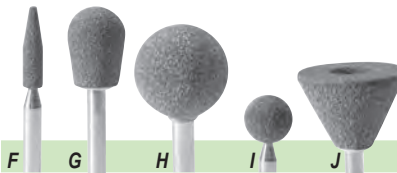

BRAKE SERVICE
TOOLING

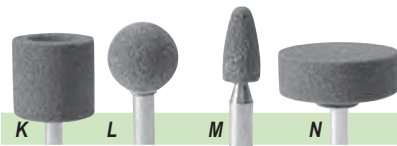

MEASURING
TOOLS

1/4" Shank Mounted Points

• Aluminum-Oxide abrasive is ideal for roughing cast iron • 1/2" shank length

Dia.	Length	Grit	Jobber	Order No.
A 3/4"	2 1/2"	60	\$9.99	GM-1
B 7/8"	2 3/4"	60	9.99	GM-3
C 7/8"	1"	60	9.99	GM-11
D 1 1/16"	1 1/4"	60	9.99	GM-12
E 3/4"	1 1/8"	60	9.99	GM-5
F 1/4"	1 1/16"	60	9.99	GM-15
G 3/4"	1"	60	9.99	GM-23
H 1"	1"	60	9.99	GM-25
I 5/8"	3/4"	60	9.99	GM-26
J 1 3/8"	1"	60	9.99	GM-31
K 1"	1"	60	9.99	GM-38
L 3/4"	3/4"	40	9.99	GM-40
M 3/8"	3/4"	60	9.99	GM-B52
N 1 1/2"	1 1/16"	60	9.99	GM-236

V-TWIN & METRIC
HARD PARTS

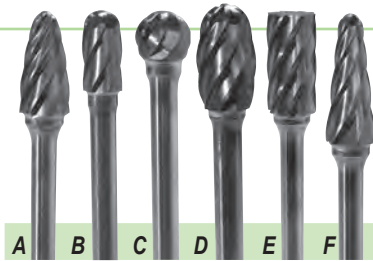

6" Long 1/4" Dia. Shank Open Fluted Rotary Files for Aluminum

- Carbide burrs
- Open flute design gives better chip discharge

	Dia.	Length	Jobber	Order No.
A	1/2"	1"	\$95.99	LAFR-34
B	3/8"	3/4"	53.99	LAFR-45
C	1/2"	7/16"	71.99	LAFR-55
D	1/2"	7/8"	89.99	LAFR-70
E	1/2"	1"	69.99	LAFR-93
F	3/8"	1 1/16"	104.99	LAFR-121

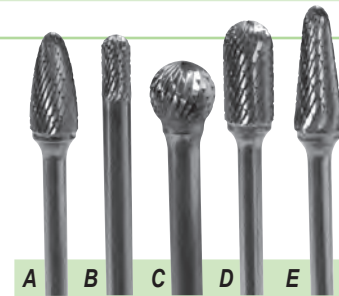

6" Long Shank Double Cut Carbide Rotary Files

• 1/4" diameter shank

Save when you buy the kit!

	Dia.	Length	Jobber	Order No.	Incl.
Complete 5 Pc. Kit			\$289.99	LFR-KIT	▼
A	1/2"	1 1/8"	69.99	LFR-34C	x
B	1/4"	1/2"	63.99	LFR-45C	x
C	1/2"	1/2"	63.99	LFR-55C	x
D	1/2"	1 1/16"	84.99	LFR-46C	x
E	1/2"	1 1/8"	72.99	LFR-141C	x



Order 5 or more Rotary Files, Burrs or Mounted Points (mix & match) and save 10% off jobber

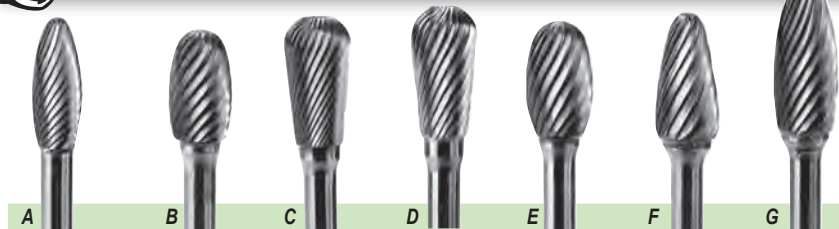

1/4" Carbide Rotary Files

- Nose design reduces back-gouging
- 1/4" shank • Shanks 4" long except MRT-56C at 6" long



	Dia.	Length	Jobber	Order No.
A	3/8"	1"	\$51.99	MSH-34C
B	11/32"	7/8"	55.99	MSE-44C
C	1/2"	31/32"	66.99	MRT-54C
D	1/2"	1"	66.99	MRT-56C

	Dia.	Length	Jobber	Order No.
E	1/2"	7/8"	\$55.99	MSE-54C
F	1/2"	1"	51.99	MSF-54C
G	1/2"	1 1/2"	55.99	MSH-54C



Bifocal Magnifying Safety Glasses

- Safety glasses and cheaters all in one • Anti-fog lenses
- Do not use as welders helpers

Diopter	Jobber	Order No.
1.00	\$14.49	BSG-100
1.25	14.49	BSG-125
1.50	14.49	BSG-150



Mirrored Safety Glasses

- Wrap-around design
- Tinted lenses provide sun glare protection
- Universal bridge
- Polycarbonate lenses
- Do not use as welders helpers
- Great motorcycle shades
- Order No. PGL-21 Jobber \$6.99

Parts Storage

Dual Overhead Cam Cylinder Head Organizer Tray

- Store valves, springs, retainers, keepers, valve lash adjusters & camshafts • Keep valve lash adjusters from getting mixed up and changing valve adjustment
- Heavy duty construction
- Oil and solvent resistant
- Measures: 23 1/4" x 26 1/2" x 2"H
- Order No. **DOHC-1**
Jobber 1+ \$54.99 each
Jobber 6+ \$49.49 each

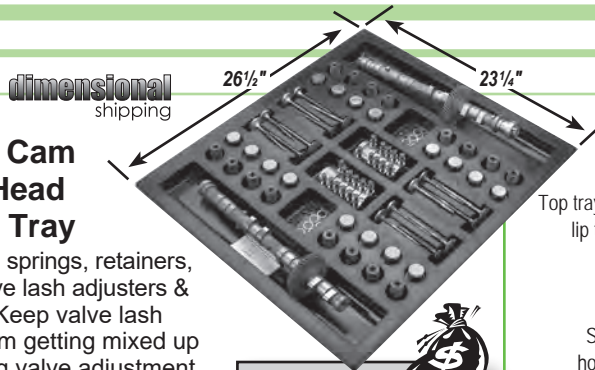

dimensional shipping

Parts Trays

Order 6 or more and SAVE 10% off jobber, Mix or match trays to make quantities



Top tray features 1" deep lip to keep parts from rolling off

Solid steel hangers hold piston rods and crankshafts
Heavy duty casters make moving the engine and cart easy

Engine Storage Cart

- An efficient space-saver
- Heavy-duty casters
- Holds all engine parts off the floor from tear-down to reassembly in less than 4 square feet
- Move the whole engine easily
- Some assembly required
- Order No. **EC-200**
Jobber \$499.99

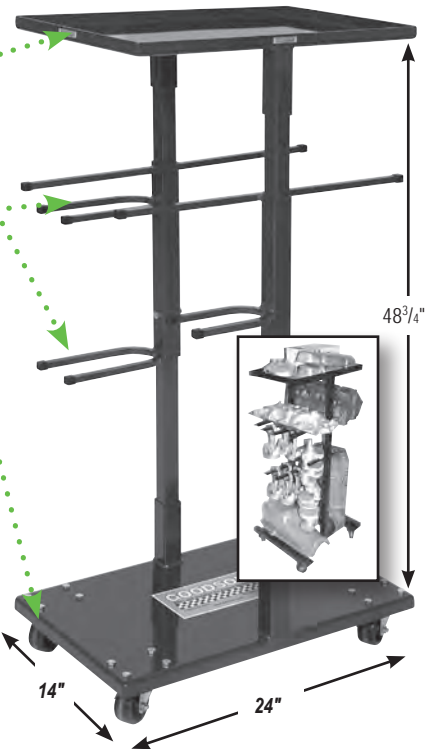

48 3/4"

dimensional shipping

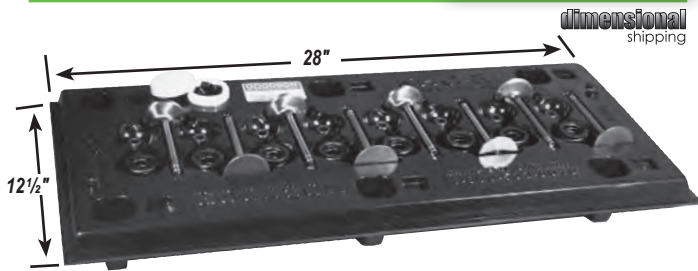

Stackable Cylinder Head Organizer Trays

- Store valves, springs, retainers and keepers in order of assembly • Impervious to oil and most solvents
- Measures 28" x 12 1/2" x 3"H
- Order No. **SHO-8**
Jobber 1+ \$63.99 each, Jobber 6+ \$57.59 each

dimensional shipping



Valve Train Tray For 4, 6 or 8-Cylinder OHV Engines

- Heavy duty construction
- Keeps push rods, rockers, lifters, etc. in order
- 64 compartments
- Measures: 11 7/8"W x 23 1/4"L x 1 3/4" H
- Order No. **VTO-80**
Jobber 1+ \$77.99 each
Jobber 6+ \$70.19 each

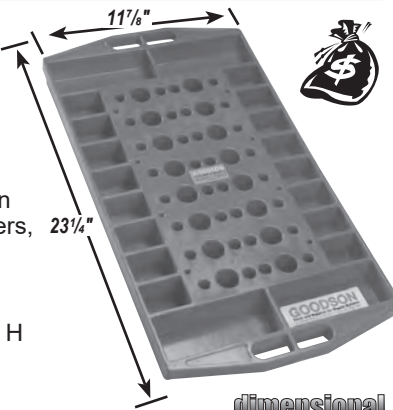

dimensional shipping

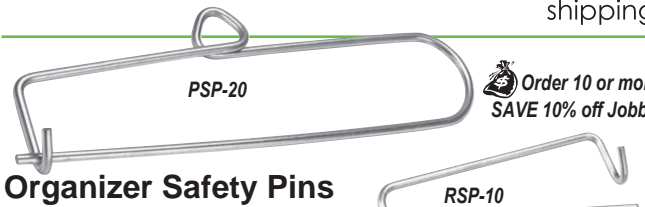

PSP-20

RSP-10

Order 10 or more, SAVE 10% off Jobber

Organizer Safety Pins

Keep Part Sets Together

Parts Safety Pin • Organize valve springs, rods, etc., from disassembly to cleaning to reassembly
Rod & Cap Mini Pin • Keep connecting rods & rod caps together to prevent mix-ups

Description	Jobber 1+	Jobber 10+	Order No.
Parts Safety Pin (3 3/4" x 12")	\$9.49 ea.	\$8.54 ea.	PSP-20
Rod & Cap Mini Pin (3/4" x 4")	3.79 ea.	3.41 ea.	RSP-10

Mix or match to make quantity break

Ford/Chevy Small Block Organizer Tray

- Store pistons, rods, lifters, push rods & camshafts
- Formed compartments keep engine components securely in place
- Measures: 24 1/4" x 25 1/2" x 1 1/2"D
- Order No. **IEO-80**
Jobber 1+ \$71.99 each
Jobber 6+ \$64.79 each

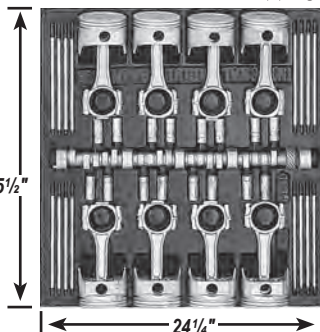

dimensional shipping

Parts Tags & Marker

- Won't tear or wash off
- Heavy wire ties
- Tough enough to go through a jet wash or hot tank
- Includes 2 Super-Permanent markers with specially formulated ink to withstand most chemicals and extreme heat and steam up to 500°F
- Tag dimensions: 3 1/2"L x 5/8"W with 5/32" hole for wire tie



Description	Jobber	Order No.
1000 Parts tags, with 2 markers	\$96.99	IDT-1000
Super-Permanent Marker only	3.59	IDT-MARKER

CYLINDER HEAD REBUILDING
CLEANING, ASSEMBLY & SAFETY
SHORT BLOCK REBUILDING
CRANKSHAFT/ FLYWHEEL GRINDING
MISCELLANEOUS TOOLS & SUPPLIES
BRAKE SERVICE TOOLING
MEASURING TOOLS
V-TWIN & METRIC HARD PARTS

... another satisfied customer

"Outstanding customer service; always. Goodson has gone above and beyond to assure we have the tooling we need."

— Jimmy Stray, Metro Motor Center, Houston, TX, Goodson customer since 1990

CYLINDER HEAD REBUILDING

Brass or Steel Shim Stock Assortment Packs

- A handy assortment • 4" x 6" each (120 sq. in.)
- One each of .001", .002", .003", .005", .010" thick

Description	Jobber	Order No.
Brass	\$14.99	SSB-50
Steel	14.99	SSS-51

CLEANING, ASSEMBLY & SAFETY

SHORT BLOCK REBUILDING



Smog Plugs

- Fit Ford 302 & 351
 - Replace smog plugs damaged during head cleaning
 - 5/8" x 11 thread outside, 7/16" x 14 thread inside
 - Order No. **EMP-34**
- Jobber 1+ \$5.99 ea. Jobber 5+ \$5.39 ea.

Order 5 or more, SAVE 10% off Jobber

CRANKSHAFT/ FLYWHEEL GRINDING

MISCELLANEOUS TOOLS & SUPPLIES

Premium Tapered Reamer

- Use by hand or with a powered driver to deburr or enlarge tapered holes for valve guides, bolt hole chamfering and more • Use in 1/2" chuck at approximately 40 RPM for best results • OAL: 5 3/4"
- Flute length: 3 3/4" • Small End: 1/8" dia. • Large End: 1/2" dia.
- Degree of Taper: 2.86° • Hardened and tempered steel with precision ground cutting edges • For steel, brass, aluminum, plastic, wood and more
- Order No. **TR-216-1** Jobber \$41.99

BRAKE SERVICE TOOLING

MEASURING TOOLS

14mm Spark Plug Thread Chaser/Burnisher

- Ideal for cleaning spark plug holes
- Reforms the original material by burnishing, not cutting so no chips are created to be cleaned out
- Order No. **SPB-14** Jobber \$128.99

V-TWIN & METRIC HARD PARTS

Two Blade Spot Facer

- 1 1/4" OD Spot Facer located on 3/8" stud
- Removes unneeded material for easier removal and installation of screw-in studs
- Replaceable carbide blades



Description	Jobber	Order No.	Incl.
Stud Boss Facer	\$159.99	SBF-5587	▼
Stud Boss Facer Tip (each) for SBF-5587 only	24.99	SBF-5587T	x
Stud Boss Facer Screw (each)	8.99	SBF-5587S	x
Replacement Stud Boss Facer 3/8" Pilot (optional)	32.99	SBF-5587P	



Head Bolt Spot Facer

- Spot face head bolt seat parallel to new deck surface after angle milling
- Allows proper head bolt torquing
- Cutting tip radius matches OE design to avoid stress points and cracks • .468" shank with flat
- Use with 7/16" Pilot below
- High Speed Steel construction

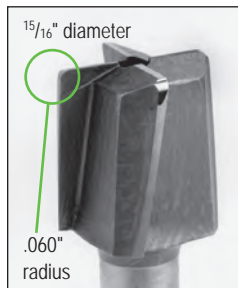

Description	Jobber	Order No.
Spot Facer	\$177.99	HBF-15
7/16" Pilot	20.99	GFP-437

GM Vortec Adaptor Plate Set For Van Norman & Storm-Vulcan Rotary Broaches

- Required when using the Van Norman VN 530 / 570 or Storm-Vulcan 850 Storm-Mill Rotary Broaches
- Two plate set • Includes fasteners
- Order No. **VN-VOR** Jobber \$59.99

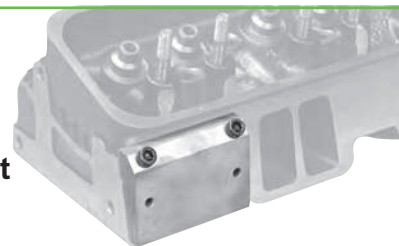

Chevy Conversion Plate Set

- Convert early model, 6-bolt heads for late model, 7-bolt applications
- Works with stock exhaust systems
- Use the standard exhaust manifold gasket or seal with High-Temp Silicone
- Order No. **CHC-10** Jobber \$29.99

Parts Storage & Cleaning

dimensional
shipping

Organize, Clean And Store Small Parts With **GOODSON Small Parts Baskets**

- Galvanized, welded 1/4" mesh
- Can be used with caustics
- Not for use with alkaline or acidic solutions, parts tumblers or shot blasters



Small Basket with Lid

- 2 1/2" dia. x 7" L
- Order No. **PWB-2** Jobber \$14.79

Medium Basket with Lid

- 4 1/2" dia. x 7" L
- Order No. **PWB-4** Jobber \$16.99



Single Basket with Handle

- 8.75" OD x 8.5" H
- Lid & clip sold separately
- Order No. **PWB-10** Jobber \$17.99

Single Basket with Lid, Clip & Handle

- 8.75" OD x 8.5" H
- Order No. **PWB-15** Jobber \$29.99



Double Basket with Clip

- 8.75" OD
- 17" H
- Hinged on one side
- Order No. **PWB-25** Jobber \$29.99



Lid & Clip

- For PWB-10
- Order No. **PWB-10L** Jobber \$11.99

Clip Only

- Order No. **PWB-15C** Jobber \$4.99



Engine & Parts Storage Bags

- Rugged, 3-mil thickness resists tearing
- Engine bags feature 4-mil thickness for extra strength
- Protects your professional work
- Waterproof • Protect finished work from damage
- Jumbo engine bags are extra-strong and big enough to fit complete engines
- Jumbo head bags fit the largest heads
- Ideal for storing heads, cranks, blocks, etc.

Description	Size	Thickness	Qty.	Jobber	Order No.
Heads, Cranks	16" x 37"	3-mil	100	\$ 72.99	BC-15
			10	11.99	BC-15-10PK
Jumbo Head	17" x 44"	3-mil	100	82.99	BC-17
			10	14.49	BC-17-10PK
Box-Style	27"x18"x36"	3-mil	50	80.99	BE-20
			10	18.99	BE-20-10PK
Jumbo Engine (Imprinted)	44" x 52"	4-mil	50	159.99	BE-44
			10	39.99	BE-44-10PK

Shrink Wrap

- Easy-to-use
- High-clarity film
- Keep machined surfaces clean
- Protects from dirt, dust and moisture
- No need to stock several bag sizes

Size	Jobber	Order No.
5" x 1000' w/ Extended Core	\$21.99	SW-5
18" x 1500' with 3" core	46.99	SW-18

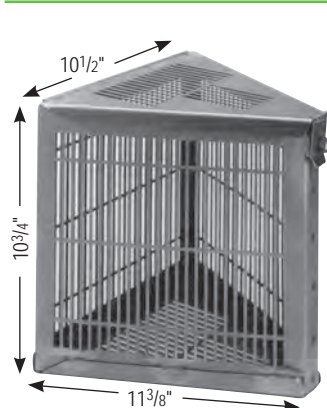

Buy 3 and save 10% off jobber

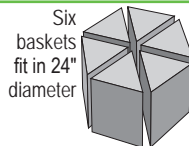

Jet Wash Parts Baskets

- Triangle-shaped • Sit side by side on Jet Wash table
- 6 baskets make a 24" circle
- Fit more baskets in the machine to clean faster
- Order No. **JWB-6** Jobber \$149.99



Flock Lined Nitrile Parts Gloves

- Nitrile exterior with diamond grip pattern
- Flock lined • Won't swell • 13" long
- Safe for solvents • Sold as pairs

Size	Jobber	Order No.
Large	\$10.49	PWG-SOL-L
X-Large	13.49	PWG-SOL-XL
XX-Large	13.49	PWG-SOL-XXL

Get the Right Size Gloves

- Size Inches
- L 3.5" to 4.0"
 - XL 3.9" to 4.4"
 - XXL 5.0" to 5.5"



CYLINDER HEAD REBUILDING
CLEANING, ASSEMBLY & SAFETY
SHORT BLOCK REBUILDING
FLYWHEEL GRINDING
CRANKSHAFT/ FLYWHEEL GRINDING
MISCELLANEOUS TOOLS & SUPPLIES
BRAKE SERVICE TOOLING
MEASURING TOOLS
V-TWIN & METRIC HARD PARTS

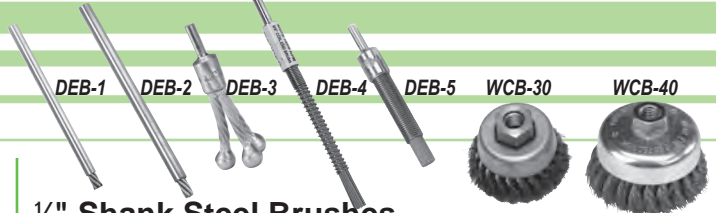

Steel End Brushes

Dia. / Wire gauge / Type	Jobber	Order No.
Standard Duty		
1/2" .020" crimped	\$ 9.99	GBC-4
3/4" .020" crimped	12.99	GBC-6
1" .020" crimped	13.49	GBC-10
1 1/2" .020" crimped	12.49	GBC-14
1 3/4" .012" crimped	16.99	NH-16
2 3/4" .012" crimped	20.99	NH-26
1 3/4" .014" galv. for alum.	17.49	ANH-16
2 3/4" .014" galv. for alum.	12.99	ANH-26
Ultra Duty (listed left to right)		
1/2" .014" crimped	\$ 9.99	GBC-4A
1 1/8" .020" knotted, 1 1/4"L	16.49	GBC-12
1 1/8" .020" knotted, 7/8"L	20.99	GBC-12HD
3/4" .020" knotted	14.49	NH-6



Engine Prep Brushes

Application	Jobber	Order No.
For small feed hole in block 1/4" x 2" x 10", nylon	\$6.99	OB-1
For Block Oil Return Line 5/16" x 2 1/2" x 12", nylon	6.99	OB-2
For Cam & Crank Work 5/16" x 2 1/2" x 12", nylon	7.49	OB-2A
For Block Oil Return Lines 3/8" x 2 1/2" x 12", nylon	7.49	OB-3
For diesel injector 1 3/4" brush, stainless	9.79	DIB-1
For lifter bores 1" x 3" x 14", nylon	10.99	LBB-100



Nylon Bristle Oil Gallery Brushes

Desc.	Jobber	Order No.
3-pc. Kit	\$21.99	OGB-SK ▼
1/4" x 3" x 24"	9.99	OGB-1 x
3/8" x 3" x 24"	10.99	OGB-2 x
5/8" x 3" x 24"	11.99	OGB-3 x

Desc.	Jobber	Order No.
5-pc. Kit	\$46.99	OGB-KIT ▼
3/8" x 3" x 34"	8.99	OGB-38 x
1/2" x 2 1/2" x 34"	9.99	OGB-42 x
5/8" x 3" x 34"	10.49	OGB-5 x
3/4" x 3" x 34"	9.99	OGB-7 x
3/4" x 3" x 40"	10.99	OGB-8 x

1/4" Shank Steel Brushes

Deep Well End Brush as brush wears cut back to expose new wire				
Dia.	Wire Gauge	Grade	Jobber	Order No.
1/4"	.012", 6" long	Economy	\$14.99	DEB-1
3/8"	.017", 6" long	Economy	17.99	DEB-2
Flare Brush use to remove carbon from engine ports				
1/2" ball, 5/16" cable		Ultra-duty	\$66.99	DEB-3
Port Brush as brush wears cut back spring for new wire				
3/8"	.014", 4" long	Standard	\$28.49	DEB-4
1/2"	.020", 2 1/2" long	Ultra-duty	25.99	DEB-5
Cup Brush 5/8"-11 NC - fits standard 4 1/2" angle grinder				
3"	.014" twisted	Ultra-duty	\$29.99	WCB-30
4"	.014" twisted	Ultra-duty	82.99	WCB-40

Order 10 or more brushes, (any combination) take 10% off jobber



Manual Guide Cleaning Brush

- 1/2" Dia. Nylon bristles
- OAL: 8 3/4"
- Order No. **WCB-44**
- Jobber \$4.99

Round Fiber Parts Brush

- 11" long • Nylon bristles
- Plastic Handle
- Order No. **PCB-348**
- Jobber \$9.99

Nylon Lifter Bore Brushes

Dia.	Job.	Order No.
7/8"	\$9.99	LBB-875
1"	10.99	LBB-100
1 1/8"	10.49	LBB-1125



Nylon Bore Washing Brushes

Dia.	Length	Jobber	Order No.
2"	36"	\$23.99	CBB-200
2 1/4"	36"	24.99	CBB-225
2 1/2"	36"	27.99	CBB-250
2 3/4"	12"	30.99	CWB-27W
3 1/2"	18 1/2"	30.99	CWB-35
4"	18 1/2"	25.99	CWB-40
4 1/2"	18 1/2"	33.99	CWB-45
5"	18 1/2"	41.99	CWB-50

Flow Through Parts Washing Brush

- 24" long hose slides over discharge nozzle on parts washer
- Order No. **PWB-FLO-1**
- Jobber \$35.99



Nylon Pushrod Brush

- Clean the inside diameter of your pushrods with this brush
- Fits pushrods as small as .080" ID
- 12" overall length
- Order No. **PRB-80**
- Jobber \$17.49

5 Pc. Nylon Valve Guide Brush Set

- Complete set includes 5 popular nylon brush sizes
- From 3/16" to 1/2" dia.
- Order No. **GVP-SET**
- Jobber \$44.99

Valve Guide Brushes

Size	Steel Brushes		Nylon Brushes	
	OAL	Order No.	OAL	Order No.
5/16" x 2 1/2"	9 1/2"	GVP-1	12"	GVP-1N
1 1/2" x 2 1/2"	9 1/2"	GVP-2	12"	GVP-2N
3/8" x 2 1/2"	9 1/2"	GVP-3	12"	GVP-3N
7/16" x 2 1/2"	9 1/2"	GVP-4	12"	GVP-4N
1/2" x 2 1/2"	-----	-----	10 1/2"	GVP-5N
9/16" x 2 1/2"	-----	-----	10 1/2"	GVP-6N
3mm x 1 1/4"	-----	-----	8"	GVP-7N
4mm x 1 1/4"	-----	-----	8"	GVP-8N
5mm x 1 1/4"	-----	-----	8"	GVP-9N
6mm x 1 1/4"	8"	GVP-10S	8"	GVP-10N
7mm x 1 1/4"	8"	GVP-11S	8"	GVP-11N
Jobber ea.		\$12.49		\$8.99



Parts Cleaning



Order 10 or more brushes,
(any combination) take 10% off jobber.



Radial Wire Brushes

- American made oil tempered high carbon steel wire
- High density for faster cleaning and longer life
- Excellent balance • 1/2" - 5/8" arbor

Size	Wire	Duty	Jobber	Order No.
6" x 1 3/16"	.014" Crimped	Std.	\$26.99	ADA-6
7" x 1/8"	.014" Crimped	Heavy	696.99	DA-7
6" x 3/8"	.016" Twisted	Super	29.99	TS-6
8" x 3/4"	.016" Twisted	Super	81.99	TS-8
6" x 7/8"	.023" Knotted	Ultra	43.99	QTC-6

made in
America

Super Scraper™

- Remove gaskets, carbon, rust, paint, etc.
- Precision-ground solid carbide-tipped, double-edged blade lasts longer than plain steel
- Nickel-chrome 1/8" thick steel shank • For all metals including aluminum



Width	Jobber	Order No.	Incl.
3 Pc. Set	\$119.99	SS-SET	▼
5/8"	32.99	SS-4U625	x
1 1/4"	41.99	SS-4U	x
2"	54.99	SS-4U2	x

CYLINDER HEAD
REBUILDING

CLEANING,
ASSEMBLY & SAFETY

SHORT BLOCK
REBUILDING

CRANKSHAFT/
FLYWHEEL GRINDING

MISCELLANEOUS
TOOLS & SUPPLIES

BRAKE SERVICE
TOOLING

MEASURING
TOOLS

V-TWIN & METRIC
HARD PARTS

Super Heavy Duty Double-Fill Cylinder Block Washing Brushes

- Highly aggressive
- Long lasting
- .050" Nylon bristles

Diameter	Jobber	Order No.
4" (101.6mm)	\$41.99	CWB-40DF
4 1/2" (114.3mm)	39.99	CWB-45DF

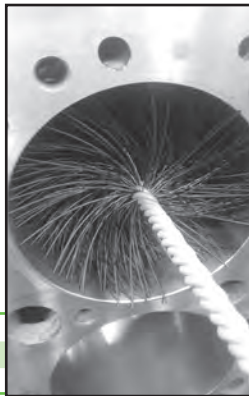

3M™ Roloc™ Bristle Discs

- Effective on cast iron, yet safe for aluminum
- Less aggressive than wire wheels
- Abrasive grains embedded in flexible plastic bristles that break down exposing new grain
- Bristles flex to maintain contact with contoured surfaces for faster, more thorough cleaning
- Use with holders below

Size	Color	Grit	Max. RPM	Jobber	Order No.
2"	Green	50	25,000	\$17.99	RBD-2G
	Yellow	80	25,000	16.49	RBD-2Y
	White	120	25,000	18.49	RBD-2W
3"	Green	50	18,000	30.99	RBD-3G
	Yellow	80	18,000	24.99	RBD-3Y

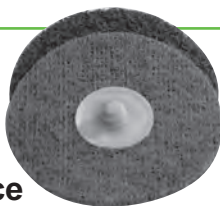
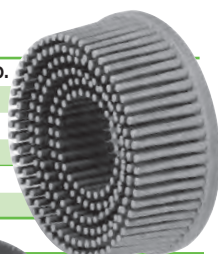

Surface Conditioning Discs

- Use with holders at right
- 10 per box

Dia.	Jobber	Order No.
2"	Medium	\$12.99
	Coarse	14.99
3"	Medium	20.99
	Coarse	24.99

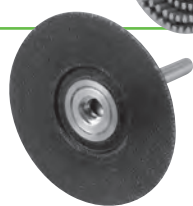

Roloc-Type Holders

- Use with Surface Conditioning Discs (left) and Bristle Discs (above)
- Threaded

Size	Jobber	Order No.
2"	\$17.99	RLH-2
3"	19.99	RLH-3



Buy the Kit,
SAVE!

BG-KIT

dimensional
shipping

Engine Rebuild Brush Kit

- Includes the brushes you'll need for an average engine job
- A great starting place, then add more brushes as you need them • Replacement brushes available

Description	Jobber	Order No.
Standard Brush Kit - 10 Pc. Kit	\$84.99	BG-KIT
4" Nylon Cylinder Washing Brush	25.99	CWB-40
1 1/2" Nylon Valve Guide Brush	8.99	GVP-2N
3/8" Nylon Valve Guide Brush	8.99	GVP-3N
Lifter Bore Brush	10.99	LBB-100
Small Nylon Feed Hole Brush	6.99	OB-1
Block Oil Return Line Brush	6.99	OB-2
3/8" Oil Gallery Brush	8.99	OGB-38
1/2" Oil Gallery Brush	9.99	OGB-42
5/8" Oil Gallery Brush	10.49	OGB-5
Round Fiber Parts Brush	9.99	PCB-348

Low Lint Disposable Assembly Wipes

- Blue, low lint wipes
- Pop-up box
- Hard-wearing
- Tear-resistant
- Ideal for a multitude of uses at the shop, at the track, even at home! • 100 per box
- Order No. **AW-100B**
- Jobber \$27.99



full service
...fast



"As a small business and employee owner, we wear many hats here at Goodson. Call me for your accounting questions but I'm also trained and knowledgeable to help you with your order!"

- Wendy, Goodson Accounting, 37 years of service

CYLINDER HEAD
REBUILDING



CLEANING,
ASSEMBLY & SAFETY

High Pressure Cleaning System

Aggressively clean oil galleries, lifter bores, cam bearing bores, main bores, cylinder bores and more

- Ergonomically designed pistol grip with easy to reach controls
- Incorporates the aggressive cleaning action of a stainless steel brush with the hydro action of a specially designed water manifold to be used with your shop air to quickly and easily clean the oil gallery holes in gas and diesel engines
- Stainless steel brushes are standard with the kits
- Do **NOT** use with caustics • 110°F max water temp.



Stainless Steel Brushes



Ergonomically designed billet aluminum grip

Water Pressure Button - 110°F Max
Air Pressure Button 125PSI Max

Stainless Steel wand will not corrode

Threaded to make brush changes quick & easy

Air/Water outlet holes are drilled in a spiral pattern to create a swirling motion to enhance the wand's cleaning power.

Goodson
exclusive

dimensional shipping



Scan the code at right with your smart phone or other smart device for fast access to the product video on the Goodson website.



SHORT BLOCK
REBUILDING

CRANKSHAFT/
FLYWHEEL GRINDING

Description	Jobber	Order No.
36" Cleaning Wand Kit	\$379.99	HPOG-1000
36" Cleaning Wand	67.99	HPOG-W36
3/8" Stainless Steel Cleaning Brush	11.49	HPOG-375
1/2" Stainless Steel Cleaning Brush	11.49	HPOG-500
5/8" Stainless Steel Cleaning Brush	11.49	HPOG-625
8-32 Thread Adaptor	33.99	HPOG-832ADP

MISCELLANEOUS
TOOLS & SUPPLIES

BRAKE SERVICE
TOOLING

MEASURING
TOOLS

V-TWIN & METRIC
HARD PARTS

Most Powerful



Heavy-Duty UltraSonic Cleaning Detergent

Use **Ultra 1 Cleaner** for: cast aluminum, cast iron, iron, wrought iron, carbon steel, stainless steel, tool steel, carbide, tin, nickel, zinc, cobalt, titanium. Ideal for brackets, clutch housings, axles, engine blocks (cast), nuts, screws

Quantity	Jobber	Order No
1 gal.	\$ 47.19	S-U1-1G
2.5 gal.	97.90	S-U1-2.5G
5 gal.	199.65	S-U1-5G

Moderate-Duty UltraSonic Cleaning Detergent

Use **Ultra 2 Moderate-Duty Cleaner** for: aluminum, billet aluminum, polished aluminum, cast aluminum, cast iron, iron, wrought iron, carbon steel, stainless steel, tool steel, carbide, tin, nickel, zinc, cobalt, titanium, magnesium, gold, silver, copper (requires additive), brass (requires additive), plastic. Ideal for pistons, wheels, brakes, bearings, connectors, crankshafts, valves, connecting rods, shock mounts and cylinder heads

Quantity	Jobber	Order No
1 gal.	\$ 42.35	S-U2-1G
2.5 gal.	95.59	S-U2-2.5G
5 gal.	180.29	S-U2-5G



Least Powerful

Multi-Purpose UltraSonic Cleaning Detergent

Use **Ultra 3 Moderate-Duty Cleaner** for: gold, silver, aluminum, billet aluminum, titanium, platinum, tin, nickel, zinc, cobalt, copper (requires additive), brass (requires additive), plastic. Ideal for pistons, wheels, brakes, bearings, connectors, crankshafts, valves, shock mounts, connecting rods and cylinder heads

Quantity	Jobber	Order No
1 gal.	\$ 54.45	S-U3-1G
2.5 gal.	119.79	S-U3-2.5G
5 gal.	235.95	S-U3-5G



The full line of ULTRASONIC, LLC machines, parts, filters and supplies are available on the Goodson website!

Visit Goodson.com to see the full selection today. All ULTRASONIC, LLC items ships directly from the manufacturer. Use your smart phone or smart device to scan the code below for instant access.





Concentrated Defoaming Agent Stops Foaming In Coolants

- For jet washers, air-agitated hot tanks and coolant sumps
- Highly concentrated – start with 1 ounce in 50 gallons

Size	Jobber	Order No.
8 oz. / 236.6mL	\$12.99	D-FOAM-10
1 gallon / 3.78L	39.99	D-FOAM-128

With Rust Inhibitor

Pro Jet Spray Cleaning Powder

- Heavy-duty • Non-caustic
- Penetrates to emulsify encrusted dirt, grease and oil on cast iron & aluminum
- Won't foam excessively
- Additives prevent scale build-up in jet spray components
- Use to maximum 165° F/ 73.9° C
- Mix ratio: 4 oz. powder to 1 gallon of water • pH: 12
- 40 lb. / 18.14 kg pail
- Order No. **PJS-50** Jobber \$184.99



Concentrated Hot Tank Detergent Powders For Cast Iron

- Strong alkaline • pH 12.8
- Removes dirt, heavy oil, grease, carbon, light rust and paint
- Mix ratio 1/2 lb. powder to 1 gal. of water
- 25 lbs.
- Order No. **D-Ci25** Jobber \$159.99

*Hazardous Goods Fees Apply – Non-Returnable**



Concentrated Hot Tank Detergent Powders For Non-Ferrous Parts

- Safe on aluminum & sensitive metals, rubber & plastic parts
- Removes heavy grease and oil
- 50 lb. pail • pH: 12.85
- Mix ratio: 1/4 lb. powder to 1 gallon of water
- Order No. **D-AL50** Jobber \$191.99

*Hazardous Goods Fees Apply – Non-Returnable**

pH Test Strips

- Easy to use • 100 tests per package
- Use the handy guide on the box to determine pH between 0 and 14
- Order No. **HT-PH** Jobber \$56.99



tech tips

from the techxperts™

Pay attention to the mix ratio on cleaning products!

It's important that you start mixing on the weak side and work your way up. An overly strong concentration is just as ineffective as an overly weak mixture. Use pH Test Strips to check the concentration.

Nozzle

Water Shut-Off Valve

Hydro-Air Gun

- Hold by the air supply hose
- Use with hot or cold water
- The grip stays cool even when spraying hot water
- Maintenance free design
- Compact for reaching into tight areas
- Replacement parts available

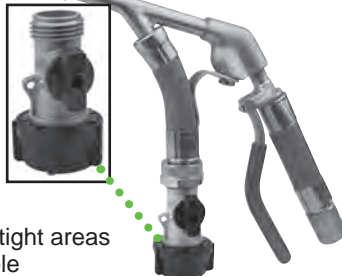

Description	Jobber	Order No.
Hydro-Air Gun Assembly	\$119.99	BG-150
Replacement Water Shut-off	13.49	BG-150W
Replacement Nozzle	27.99	BG-150A

Hot Tank Gloves

- One size fits most
- Sold in pairs
- Neoprene fully coated with knit lining and textured grip
- Shoulder length features eyelets & strings at tops to prevent slipping



Description	Jobber	Order No.
Gauntlet Length (14" long)	\$27.99	HTG-200
Elbow Length (17 1/2" long)	47.99	HTG-200E
Shoulder Length (34 3/4" long)	54.99	HTG-200L

Full Length Neoprene Shop Apron

- Protects from caustics, steam, grease and oil
- Bib-style • 35" x 45"
- Order No. **HTA-300** Jobber \$35.99

Shown with Shoulder Length Hot Tank Gloves (above)



CYLINDER HEAD REBUILDING
CLEANING, ASSEMBLY & SAFETY
SHORT BLOCK REBUILDING
FLYWHEEL, GRINDING
CRANKSHAFT/ TOOLS & SUPPLIES
MISCELLANEOUS
BRAKE SERVICE TOOLING
MEASURING TOOLS
V-TWIN & METRIC HARD PARTS



"Our easy-to-use catalog features more than 8,000 tools and supplies. Feel free to call if you're not sure what to order or if you have questions. We'll do everything we can to help you get what you need."

-Becky, Goodson Inventory Control, 10 years of service

CYLINDER HEAD
REBUILDING

CLEANING,
ASSEMBLY & SAFETY

SHORT BLOCK
REBUILDING

CRANKSHAFT/
FLYWHEEL GRINDING

MISCELLANEOUS
TOOLS & SUPPLIES

BRAKE SERVICE
TOOLING

MEASURING
TOOLS

V-TWIN & METRIC
HARD PARTS

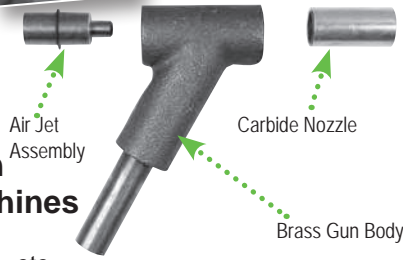

Glass Bead Gun for Smaller Machines

- Solid brass body
- Fits Trinco, Econoline, etc.
- Includes Gun Body, Nozzle and Air Jet Assembly
- Replacement parts available

Description	Jobber	Order No.
Complete Gun For Smaller Machines	\$124.99	GB-113
Replacement Parts		
Gun body only	\$71.99	GB-111
Carbide nozzle 19.05mm OD, 7.94mm ID	64.99	GB-204
Air jet assembly 3.97mm ID, 25 CFM	26.99	GB-330



Glass Bead Cabinet Window Film

- Protects the inside of glass bead cabinet windows
- Save time and money – replace the film rather than the glass • 24" x 10' roll
- Order No. **GB-FILM** Jobber \$22.99

tech tips

from the techxperts™

For best results, attach film to cabinet window with ordinary double-faced tape (not included).

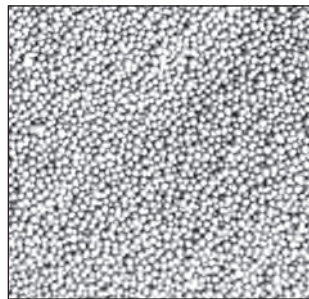

Glass Beads

- Clean parts thoroughly without removing material
- 50 lb. bag • Size #8
- Safe for ferrous & non-ferrous materials
- Order No. **GB-CM** Jobber \$59.99

ARMEX® Maintenance XL Formula Soda Blast Cleaning Media

- 270 micron / 70 Grit Formula
- Use to strip clean almost any car surface including, steel, aluminum, Fiberglas® and plastics
- Ideal for blocks, heads and intake manifolds
- Dissolves in warm water, minimizing particle ingestion that can block fuel lines and passageways
- Won't damage the surface you're cleaning
- Non-toxic and non-hazardous with a pH of 8.2
- 50 lb. / 22.7 kG bags
- Order No. **SMB-170** Jobber \$51.49

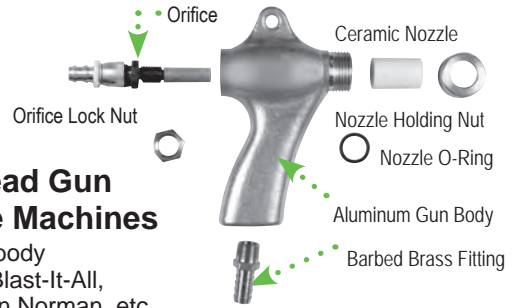

Glass Bead Gun for Large Machines

- Aluminum body
- Fits Zero, Blast-It-All, Winona Van Norman, etc.
- Includes .313" ID ceramic nozzle

Description	Jobber	Order No.
Complete Gun For Larger Machines	\$189.99	GB-100
Replacement Parts		
Gun body only	\$97.99	GB-101
Barbed Brass fitting	10.49	GB-04
Nozzle holding nut (not included in rebuild kit)	22.99	GB-54

Rebuild Kits	Jobber	Order No.	Includes
.250" ID	\$68.99	GB-4-OK	▼
.313" ID	89.99	GB-5-OK	▼
.375" ID	79.99	GB-6-OK	▼
.437" ID	79.99	GB-7-OK	▼
Ceramic Nozzles			
.250" ID	26.99	GB-74	x
7/8" OD x 1 1/8"	26.99	GB-75	x
.375" ID	26.99	GB-76	x
.437" ID	32.99	GB-77	x
Replacement Orifices			
#4	53.99	GB-64	x
#5	71.99	GB-65	x
#6	71.99	GB-66	x
#7	53.99	GB-67	x
Orifice Lock Nut	11.99	GB-52	x x x x
O-Ring	8.99	GB-53	x x x x



Glass Bead Gloves

- 30" overall length
- For ports up to 10" diameter
- Durable cloth-lined Neoprene glove with nylon sleeve
- Sleeve design makes attaching glove to your machine, faster and easier • Clamp sold separately

Port Size	Description	Jobber	Order No.
Up to 8" (20.32 cm)	Single: left-hand glove	\$ 39.99	GB-654-G
	Single: right-hand glove	39.99	GB-655-G
	Pair: one right-hand & one left-hand	69.99	GB-660-G
Up to 10" (25.4 cm)	Single: left-hand glove	48.99	GB-754-G
	Single: right-hand glove	48.99	GB-755-G
	Pair: one right-hand & one left-hand	89.99	GB-770-G
8" and 10"	Replacement Clamp: fits both port sizes	13.99	GB-CLAMP

SAFETY TIP: NEVER point the Glass Bead Gun at the cabinet window or your co-workers!

Cleaning Media

For Parts Tumblers



20 LB.

Ceramic Diagonals (20 lb.)
For soft materials such as brass and aluminum. $\frac{5}{16}$ " dia., $\frac{5}{8}$ " long
Order No. **PTM-20CR** Jobber \$99.99

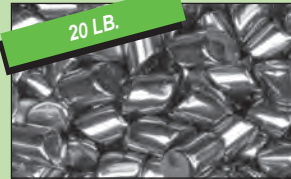

20 LB.

Steel Diagonals (20 lb.)
Ideal for valves.
 $\frac{5}{16}$ " dia., $\frac{5}{8}$ " long
Order No. **PTM-20D** Jobber \$289.99

For Airless Blasters

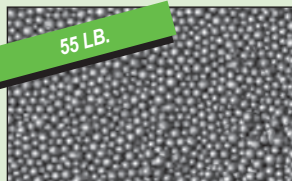

55 LB.

Steel Shot, 170 grade (55 lb.)
Ideal for cleaning cast iron heads.
Diameter varies from .017" to .024".
Order No. **SS-CM** Jobber \$94.99

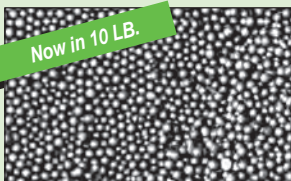

Now in 10 LB.

Stainless Steel Shot, Conditioned.
Clean aluminum heads to look like new.
Restores bright aluminum finish. Lasts longer than plain carbon steel shot.
Diameter varies from .006" to .016".
10 lb.
Order No. **SS-CS10** Jobber \$86.99

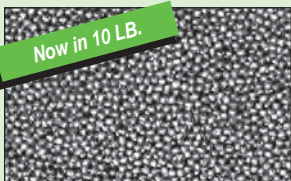

Now in 10 LB.

Stainless Steel Cut Wire Shot
Unconditioned. Clean cast iron or aluminum heads before and normalize after welding. Helps prevent surface corrosion after blasting.
.020" Diameter. 10 lb.
Order No. **SS-CW10** Jobber \$139.99



Parts Tumbler Solution

- Dilute 30:1 with water
- For best results, dry parts with compressed air • 1 gallon / 3.78L
- Order No. **PT-SOL** Jobber \$17.99

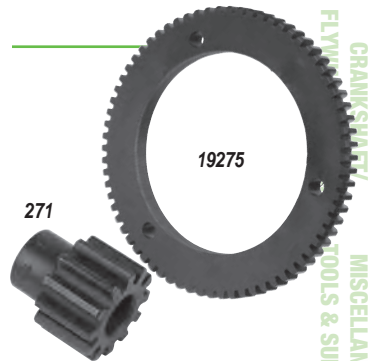

271

19275

Replacement Gears For Sioux™ 710 Parts Tumbler

- Replaces discontinued Sioux™ parts

Description	Jobber	Order No.
Steel Gear	\$77.99	271
Fiber Gear	74.99	19275



Gauntlet Style Heat & Flame Resistant Gloves

- Heavy lined red terrycloth
- 13½" Long
- Safe to 450°F / 232.2°C
- Order No. **HR-300** Jobber \$49.99



Keeper-Keeper

- Screws tightly closed
- ¼" holes
- Ideal for tumbling keepers
- Solvent resistant PVC
- Order No. **VK-15** Jobber \$18.49

See Page 135 for Valve Stems

Valve Stem Protectors

- Protects against parts tumbler damage
- Slips on and off easily
- 16 per package
- Order No. **VSP-16** Jobber \$14.99



Stay Up-To-Date With Your Friends At Goodson!

We're On Social Media Are You?



Facebook



Instagram



YouTube



Blog

Cloth Shop Apron

- Bib-style apron
- Heavy duty black fabric
- Several handy pockets
- Embroidered Goodson Racing logo
- Machine Washable
- Order No. **CA-100** Jobber \$39.99



Steel Parts Tumbler Basket

- Fits Goodson, K.I., Axe, RMC, and Peterson
- 8" x 12" x 12"
- Order No. **PT-BASKET** Jobber \$435.00



CYLINDER HEAD REBUILDING

CLEANING, ASSEMBLY & SAFETY

SHORT BLOCK REBUILDING

FLYING CRANKSHAFTS

MISCELLANEOUS TOOLS & SUPPLIES

BRAKE SERVICE TOOLING

MEASURING TOOLS

V-TWIN & METRIC HARD PARTS



"To improve speed and accuracy we scan every item when pulling and packing orders. Every order is checked first by a person, then by computer before it's shipped to you."
-Tanya, Goodson Shipping, 1 year of service

CYLINDER HEAD
REBUILDING

Mix or Match to SAVE!

Order 12 or more cans, save 10% off Jobber



Last Blast Spray Paint

- Quick-dry formula lets you handle parts in minutes
- Pigment won't smudge AND resist abrasion, corrosion and most solvents
- Paint heads, blocks and parts just like OE
- Withstands heat up to 250°F/121.1°C
- 12 oz. cans
- **Last Blast** restores original look to all types of cast iron
- **Aluminum Last Blast** makes aluminum heads and parts look new
- **Color Last Blast** paint heads and parts in popular, factory colors
- **Hi-Temp Last Blast** Withstands continuous heat up to 1200°F. Heat at 450°F for 1 hour to create a professional, durable finish

Color	Jobber 1+	Jobber 12+	Order No.
Cast Iron Gray	\$10.99	\$ 9.89	LB-1*
Aluminum Gray	10.99	9.89	ALB-1*
GM Black (Gloss)	10.99	9.89	CLB-58*
Chevy Orange	10.99	9.89	CLB-61*
Ford Blue	12.49	11.24	CLB-60*
Hi-Temp Cast Iron Gray	12.99	11.69	LB-1-HT*
Hi-Temp Aluminum Gray	12.49	11.24	ALB-1-HT*
Hi-Temp Black (Matte)	12.49	11.24	CLB-58-HT*

Mix or Match Quantities to SAVE! Order 12 cans, save 10% off Jobber
*Aerosol — Hazardous Goods Fees Apply When Shipped By Air



CLEANING,
ASSEMBLY & SAFETY

SHORT BLOCK
REBUILDING

CRANKSHAFT/
FLYWHEEL GRINDING

MISCELLANEOUS
TOOLS & SUPPLIES

BRAKE SERVICE
TOOLING

MEASURING
TOOLS

V-TWIN & METRIC
HARD PARTS

Industrial Metal Markers

- No shaking needed • Quick dry
- Withstands oil, grease & surface contact • Won't lose its brilliance or legibility
- Medium point



Color	Jobber 1+	Jobber 5+	Order No.
Orange	\$9.99	\$8.99	MM-STD
Black	9.99	8.99	MM-010
Yellow	9.99	8.99	MM-030
White	9.99	8.99	MM-050
Green	9.99	8.99	MM-060
Red	9.99	8.99	MM-070
Blue	9.99	8.99	MM-080

Mix or Match Quantities to SAVE! Order 5 or more, save 10% off Jobber

Universal Gel Lube

- Sprays on as a liquid and forms into a gel within seconds
- Penetrating formula blends with motor oil
- Multiple uses, including cams, lifters, rocker arms, bearings, pistons/wrist pins, cylinders, valve springs, etc.
- Provides lubrication for engines subjected to prolonged storage before initial start-up
- 8 oz. Aerosol* can
- Order No. **GL-8U**
- Jobber 1+ \$26.99 ea.
- Jobber 6+ \$24.29 ea.

Order 6 or more,
Save 10% off jobber



*Hazardous Goods Fees Will Apply if Shipped By Air

2" Dispensing Pliers for Flexible Tubes

- Maximizes the use of all the material in the tube due to its effective means of application
- Dispenses the thickest sealant through a very small opening, permitting better application control
- Reduces both cleanup time and the possibility of skin contact or other problems caused by excess material squeeze-out
- Order No. **EB-416** Jobber \$29.99



High-Performance Hylomar® Gasket Maker & Thread Sealer



- Maintains seal integrity up to 600°F / 315.5°C
- Polyol-based compound turns from a gel into flexible putty within minutes of application
- Non-hardening formula is impervious to oil, gasoline, glycol and other engine fluids
- Oxygen-sensor safe
- Seals gaps .01" or less
- 100 gram tube
- Order No. **HBS-1** Jobber \$41.99



Assembly & Break-In

Order 6 or more, Save 10% off jobber 

Press Fit Lube

- A light coat eases press fit
- Ideal for valve guides, piston pins, cylinder sleeves, etc.
- Eliminates the scoring, gouging and galling of parts during press fitting
- 6 oz. / 177.4mL • Aerosol*
- Order No. **PFL-200**
Jobber 1+ \$14.99 ea.
Jobber 6+ \$13.49 ea.

*Hazardous Goods Fees Apply When Shipped By Air



Press Fit Lubricant

- A light coat eases press fit
- Multiple applications
- Eliminates scoring, gouging and galling of parts during press fitting

Description	Jobber	Order No.
Aerosol 7 oz. / 207 mL	\$27.09	B-200*
Brush Applicator 200 mL	36.86	B-200L

*Hazardous Goods Fees Apply When Shipping By Air



Extreme Pressure Lube

- Withstands pressures up to 50,000 PSI
- Highly refined petroleum product
- Contains no lead, graphite or minerals
- Won't corrode fine surfaces or emulsify with cooling liquids
- Surfaces stay lubed and protected
- In a grease form • 4 fl. oz. / 118.29mL
- Order No. **EPL-4** Jobber \$14.99

Order 6 or more, Save 10% off jobber 

Spray Assembly Lube

- Ideal for lubricating parts to ease assembly
- Eliminates critical initial run-in of new and rebuilt high-performance engine components
- Spray on bearings, crankshafts, pistons, rings, etc.
- 11 oz. Aerosol* can • Order No. **SAL-11**
Jobber 1+ \$16.99 ea.
Jobber 6+ \$15.21 ea.

*Hazardous Goods Fees Apply If Shipped By Air



First Lube Engine Assembly Lube

- Prevent dry engine start-ups after long-term storage
- Contains Zinc and Moly
- Clings and forms a slick wall between moving parts
- Withstands start-up pressure
- Compatible with all motor oils

Size	Jobber	Order No.
8 oz. / 236.6mL	\$ 8.99	FL-10
1 gallon / 3.78L	54.99	FL-128



Blood Friction Master® Engine Assembly Lube

- Contains a low friction additive (PTFE) for dry start-ups
- Ideal for long-term storage
- Forms a slick wall between moving parts
- Clings until dissolved by oil
- Withstands start-up pressure
- Compatible with all motor oils
- Ideal for high performance

Size	Jobber	Order No.
8 oz./236.6 mL w/brush	\$ 17.99	AL-22-8
1 gal./3.78 L w/pump	159.99	AL-22-10



Need Zinc?

Cam-Shield® Camshaft Assembly Paste

- Provides anti-wear protection for camshafts during break-in
- 2500 parts per million of Zinc
- Use with mechanical and hydraulic camshafts & lifters
- For racing, street, classic, agricultural, diesel & marine camshafts
- 4 oz. / 118.29 mL Brush Top Jar
- Order No. **CSAP-4** Jobber \$29.99



Mr. Race Oil® Engine Assembly Gel

- For all 4-stroke engines!
- An advanced engine assembly gel designed to stay in place for engine protection during storage, shipping and start-up time
- Petroleum based, oil soluble product
- Colored blue so you can see where it's applied
- 8 ounce jar • Order No. **EAG-8** Jobber \$39.99



CYLINDER HEAD REBUILDING
CLEANING, ASSEMBLY & SAFETY
SHORT BLOCK REBUILDING
CRANKSHAFT/ FLYWHEEL GRINDING
MISCELLANEOUS TOOLS & SUPPLIES
BRAKE SERVICE TOOLING
MEASURING TOOLS
V-TWIN & METRIC HARD PARTS

Order 6 or more cans save 10% off jobber

Rust Shield Spray

- 2 formulas to choose from
- **Short Term (Indoor)**
- Non-sticky • Lasts several weeks
- Wipes off with just a towel
- **Long-Term (Outdoor)**
- Thicker than short term
- Protects longer
- Requires a solvent to remove



Formula	Jobber 1+	Jobber 6+	Order No.
Short Term	\$15.49	\$13.94	RS-16*
Long Term	16.99	15.29	RS-16-OD*

*Hazardous Goods Fees Apply When Shipped By Air

Rust Proofing Oil

- 1 Gallon / 3.78 L
- Apply full strength
- Creates a protective film
- Washes off with standard solvents
- Ideal for use with sprayers or can be applied with a brush
- Order No. **RPO-10**
- Jobber \$159.99



Petroleum Based Rust Inhibitor

- Brush directly from can onto freshly-machined engine components
- Protects iron, steel and aluminum
- Soften with mineral oil to dip small parts
- Order No. **RPC-2A**
- Jobber \$36.99



Snap Together Adjustable Coolant Hoses

- Hoses hold any shape • Chemical Resistant
- Ideal for most common shop machines

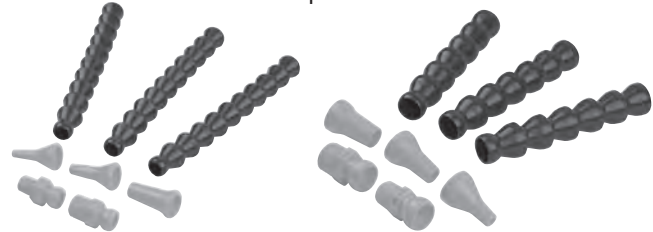

Size: $\frac{1}{4}$ " Hose Kit
Includes: 18" hose, $\frac{1}{4}$ " & $\frac{1}{8}$ " NPT fittings, $\frac{1}{16}$ ", $\frac{1}{8}$ " & $\frac{1}{4}$ " round nozzles

Application: Most parts washers, wet-type seat grinders, valve refacers

Order No.: **ACH-400** Jobber \$22.99

Size: $\frac{1}{2}$ " Hose Kit
Includes: 16 $\frac{1}{2}$ " hose, $\frac{3}{8}$ " & $\frac{1}{2}$ " NPT fittings, $\frac{1}{4}$ ", $\frac{3}{8}$ " & $\frac{1}{2}$ " round nozzles

Application: Most cylinder hones and flywheel grinders

Order No.: **ACH-600** Jobber \$26.99

Universal Coolant Magnet

- Ideal for Honing Tanks, Flywheel Grinders, Crankshaft Grinders, Head Surfacers and more
- Prevents metal swarf from passing into the coolant tank
- Cut or shape to fit machine bases and return ways
- Measures 3"x48" • Can be trimmed to any size needed
- Order No. **UCM-348** Jobber \$27.99

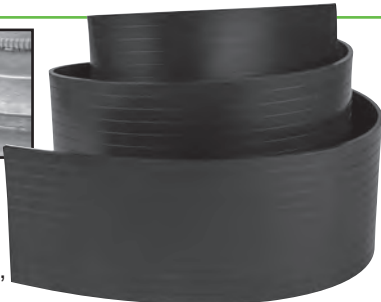

Size: 1" Flare Nozzle for $\frac{1}{4}$ " Hose

Order No.: **ACH-407**
Jobber \$15.99

Size: $\frac{1}{4}$ " Flare Nozzle for $\frac{1}{2}$ " Hose

Order No.: **ACH-807**
Jobber \$17.99

Size: 2 $\frac{1}{2}$ " Flare Nozzle for $\frac{1}{2}$ " Hose

Order No.: **ACH-809**
Jobber \$19.99



NPT	Hose ID	Jobber	Order No.
$\frac{1}{4}$ "	$\frac{1}{4}$ "	\$ 9.99	ACH-406
$\frac{3}{8}$ "	$\frac{1}{2}$ "	13.99	ACH-804
$\frac{1}{2}$ "	$\frac{1}{2}$ "	9.99	ACH-805

Hose ID	Lng.	Jobber	Order No.
$\frac{1}{4}$ "	11"	\$16.99	ACH-401
$\frac{1}{2}$ "	11"	17.99	ACH-801

Coolant & Solvent Pumps

Ideal for Parts Washers

170 Gal. Per Hour Pump

- HP: 1/125
- Capacity: 170 gal/hr. at 1" depth • Hi-temp Seals
- Voltage: 115
- Size: 4" x 3 $\frac{1}{4}$ " x 2 $\frac{3}{4}$ "
- Order No. **COP-166**
- Jobber \$209.99



Ideal for Flywheel Grinders

1200 Gal. Per Hour Pump

- HP: 1/6
- Capacity: 1200 gal/hr. at 1" depth
- Voltage: 115
- Size: 7 $\frac{3}{4}$ " x 6 $\frac{1}{16}$ " x 4 $\frac{5}{16}$ "
- Order No. **COP-1833**
- Jobber \$249.99



Sludge Filter Bag

- Fits any machine with a coolant sump
- Replace costly OE filters with this economical, universal sock
- Adds filtration to machines that don't have enough • 8" x 24" polyester knit sock
- Order No. **SB-1** Jobber \$11.49



Machine Lubricants, Etc.

Rust Shield for Shop Equipment

- Stops rust without causing rancidity
- Apply to machine parts
- Mixes with coolant – no need to remove before machining
- 1 Gallon / 3.78 L
- Order No. **RS-128**
- Jobber \$39.99



Way Oil

- Adhesive oil
- Formulated to provide extended lubrication and rust protection for machine-tool ways
- 1 Gallon / 3.78 L
- Order No. **WO-50**
- Jobber \$37.99



CYLINDER HEAD
REBUILDING
CLEANING,
ASSEMBLY & SAFETY



Flywheel Grinder Table Lubricant

- Helps extend flywheel grinder life
- High-pressure oil designed to lubricate table bearings and ways
- For all makes of flywheel grinders
- 1 Gallon / 3.78 L
- Order No. **FG-1131-G**
- Jobber \$47.99

EPL-LS1



EPL-14

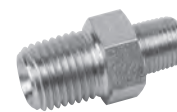

EPL-18



10 Quart Engine Pre-Lube Tank Replacement Parts

Description	Jobber	Order No.
Replacement 8' Hose	\$47.99	EPL-HOSE
LS1 Fitting	33.99	EPL-LS1
1/4" Replacement Fitting	5.79	EPL-14
1/8" Replacement Fitting	6.79	EPL-18
Replacement Gauge	14.49	EPL-CG
Mini Ball Valve	27.99	EPL-MBV

SHORT BLOCK
REBUILDING
FLYWHEEL GRINDING
CRANKSHAFT/



Replacement PF Filter Cartridges

- Cartridges remove grit, metal and dirt from honing oil
- Fit Sunnen® CK-10, CV-616, LBB-1810, PF-150 and CH-100 honing machines



Description	Application	Qty.	Jobber	Order No.
Extra Fine	Oil Only	4 Pk.	\$272.32	PF-105-4
Fine	Oil Only	4 Pk.	272.32	PF-110-4
Extra Fine	Water Only	1 Pk.	206.26	PF-104
Fine (Fiberglass)	Water Only	1 Pk.	193.21	PF-160

1" Thick Rod Hone Filter Mat

- Synthetic material
- Traps abrasive particles & metal filings BEFORE they enter the storage tank
- Cushions parts to prevent damage
- Replace when clogged
- 1" (25.4mm) thick

Inches	Metric	Jobber	Order No.
18" x 25"	45.7 x 63.5 cm	\$19.99	RH-MAT
26" x 40"	66.0 x 101.6 cm	39.99	RH-MAT-2
33" x 48"	83.8 x 121.9 cm	44.99	RH-MAT-3

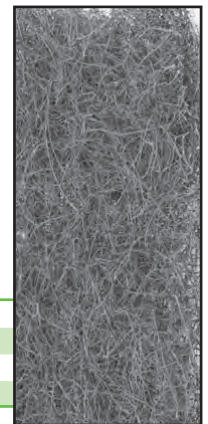

MISCELLANEOUS
TOOLS & SUPPLIES
BRAKE SERVICE
TOOLING

Mfr.	Machine	Capacity
Sunnen	LBB-1699	15 Gal.
	LBB-1660	15 Gal.
	LBB-1810	25 Gal.
	LBB-1803	25 Gal.
	EC-3500	32 Gal.
	ML-3500	32 Gal.
	ML-5000	32 Gal.
	ML-2000	28 Gal.
	CK-10	55 Gal.
	CV-616	55 Gal.
	SV-10	55 Gal.
CK-21	63.5 Gal.	

Mfr.	Machine	Capacity
Rottler	H85AXY	70 Gal.
	H85A	70 Gal.
	H85AX	70 Gal.
	H86A	70 Gal.
	H86AX	70 Gal.
	H86AXY	70 Gal.

tech tips
from the techxperts™

Hone Cabinet Filter Paper

- Reduce sump and filter clean-up
- Extend oil life
- Filter paper in the bottom of hone machine removes debris before oil enters the sump
- When full, dispose of properly
- 2 – 60" x 60" sheets (trim to fit)
- Order No. **HN-FP** Jobber \$23.99

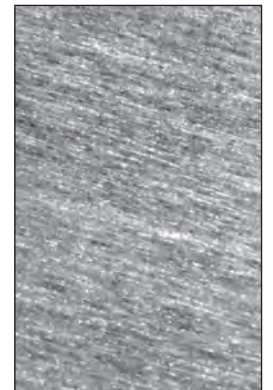

MEASURING
TOOLS
V-TWIN & METRIC
HARD PARTS



Coolants and Lubricants

We don't stock one type of coolant and claim that it suits all types of grinding, nor do we carry one type of oil and try to sell it for every application. Each of our coolants, lubricants and oils is formulated to deliver better results and longevity in its specific use. All of our coolants prolong the life of grinding wheels, retard corrosion and rancidity. Colors may vary. **Note: Dilution ratio is water to coolant.**

Grinding Coolants

All-Purpose Grinding Coolant

A synthetic water soluble coolant that "Licks Rust". Dilute 30:1

Size	Yield	Jobber	Order No.
1 gal.(3.78L)	30 gallons	\$ 51.99	CGC-1288

Crank & Cam Grinding Coolant

Synthetic, non-nitrate, high lubricity coolant. Dilute 20:1

Size	Yield	Jobber	Order No.
1 gal.(3.78L)	20 gallons	\$ 40.99	CGC-10
5 gal.(18.9L)	100 gallons	194.99	CGC-50

Multi-Duty Grinding Coolant

Medium-duty, low foaming, synthetic coolant with rust inhibitors. Safe for ferrous and non-ferrous metals alike. No nitrates, phenols, chlorine or sulfur. Dilute 30:1

Size	Yield	Jobber	Order No.
1 gal.(3.78L)	30 gallons	\$ 59.99	GPC-10
5 gal.(18.9L)	150 gallons	279.99	GPC-50

Belt-Resurfacing Coolant

For all belt-type resurfacers with or without down-pressure. Dilute 30:1

Size	Yield	Jobber	Order No.
1 gal.(3.78L)	30 gallons	\$ 59.99	SGB-10
5 gal.(18.9L)	150 gallons	299.99	SGB-50

Surface Grinding Coolant

Non-foaming, non-nitrate coolant for single-piece resurfacing wheels or segments. Dilute 20:1

Size	Yield	Jobber	Order No.
1 gal.(3.78L)	20 gallons	\$ 39.99	SGC-10
5 gal.(18.9L)	100 gallons	199.99	SGC-50

Flywheel Grinding Coolant

Includes a synthetic rust inhibitor that prevents rancidity. For all flywheel grinders. Dilute 30:1

Size	Yield	Jobber	Order No.
1 gal.(3.78L)	30 gallons	\$ 48.99	FG-1101-G
5 gal.(18.9L)	150 gallons	189.99	FG-1102-G

Grinding & Honing Oils (Not Water Soluble)

Cylinder Honing Oil (Clear)

Ideal for portable hones and all makes of automotive honing machines. Mixes readily with other brands (including Sunnen®).

Size	Jobber	Order No.
1 gal.(3.78L)	\$ 35.99	HO-10
5 gal.(18.9L)	159.99	HO-50



Sunnen® Mineral Based Honing Oil

Formulated for general purpose automotive machine shop honing. Compatible with most popular honing machines.

Size	Jobber	Order No.
5 gal. (18.9L)	\$208.01	MAN-845



Valve Grinding Oil (Light Yellow)

Universal valve grinding oil extends wheel life. Mineral based. Prevents rancidity, foaming & deposits.

Size	Jobber	Order No.
1 gal.(3.78L)	\$ 44.99	VGO-10
5 gal.(18.9L)	199.99	VGO-50



Rod Honing Oil (Dark Brown)

Keeps stones clean & free-cutting during rod reconditioning, pin fitting and other honing jobs. Will mix with other brands (including Sunnen®).

Size	Jobber	Order No.
1 gal.(3.78L)	\$ 54.99	RHO-10
5 gal.(18.9L)	269.99	RHO-50



Sunnen® Honing Oil Concentrate

Formulated for general purpose automotive machine shop honing. Compatible with most popular honing machines. Add your own Mineral Oil. Mix Ratio: 10:1 for MAN-845 or 2:1 for MB-30

NOTE: Cannot be shipped to California

Size	Jobber	Order No.
5 gal. (18.9L)	\$374.79	MAN-C



Severe Duty Valve Grinding Oil (Brown)

For grinding titanium, Inconel®, stainless steel and stellite valves. Includes additives to improve cutting performance under pressure.

Size	Jobber	Order No.
1 gal.(3.78L)	\$ 64.99	VGO-SD10
5 gal.(18.9L)	264.99	VGO-SD50



Diamond Honing Oil (Brown)

Specially formulated to withstand the cutting pressures created when using our Diamond Valve Guide Honing System.

Size	Jobber	Order No.
8 oz.(236.6mL)	\$ 6.19	DHO-8
1 gal.(3.78L)	59.99	DHO-10
5 gal.(18.9L)	259.99	DHO-50



Sunnen® Mineral Based Multi-Purpose Honing Oil

High performance lubricity agents with sulfur extreme-pressure additives. Won't weld or tear the work-piece.

For metals from aluminum to zirconium

Size	Jobber	Order No.
5 gal. (18.9L)	\$241.99	MB-30



Titanium Valve Grinding Aid

Mix ratio of 1:4. Add to mineral based valve grinding oils. Improves finish on titanium, stainless steel and stellite valves.

Size	Jobber	Order No.
32 oz.(946.6mL)	\$45.99	VGA-T32



Water Based

Diamond Honing Coolant

Suitable for diamond honing on cast iron blocks. Greatly reduces heat build-up in the block. Reduces amount of block cleaning needed after honing

Size	Jobber	Order No.
5 gal.(18.9L)	\$319.99	DHC-50



Sunnen® Water Based

Honing Coolant Concentrate for Cast Iron

Meets the demands of Single-Stroke and metal-bond Superabrasive honing. Ideal for honing aluminum or with diamond plated tools. Can be used as a general grinding coolant. 5 gallons makes up to 55 gallons of coolant. Mix ratio: 10:1.

Size	Jobber	Order No.
5 gal.(18.9L)	\$404.30	SCC750005



Need a Safety Data Sheet or Product Instructions?

Look on the Goodson website for SDS and Product Instructions. If you can't find what you need, give us a call.

3-D Fast Cut™

3-D Fast Cut™ Starter Kits	6, 7
Ball Head Drive Adaptors	6, 7
Bounce Springs	6, 7
Bowl Profiler	12
Lift Clip	6, 12
Micro Ball Head Tooling	7, 12
Pilots	3 - 5
Setting Micrometer	7
Tool Setting Fixture	6, 7
Universal Spring Pad Cutters	12
Valve Seat Cutter Blades	8 - 11
Valve Seat Cutter Tool Holder	6, 7
Valve Seat Removal Tooling	7

A

Abrasive Belt Dresser	107
------------------------------------	-----

Abrasives

Aluminum Oxide Cloth Shop Rolls	59
Belts	49, 108, 109
Bench Grinder Wheels	116
Blanchard Grinder Wheels	51
Brake Drum Grinding Wheels	122
Brake Shoe Grinding Sleeves	118
Cam Grinding Wheels	101
Cartridge Rolls	58, 59
CBN Inserts for Cast Iron	48
Chamfering Cones	46, 89
Crankshaft Grinding Wheels	102, 103
Crankshaft Polishing Belts	108, 109
Crocus Cloth	59
Cross Buffs®	58, 59
Cylinder Head Resurfacing	48 - 51
Cylinder Honing	86 - 92
Diamond Honing	32
Diesel Super Abrasive Insert	48
Discs	59, 65
Flapwheels	58, 59
Flex-Hones®	34, 83, 89, 101, 122
Flywheel	112 - 113
Grinding Discs	59, 65
Grinding Wheels	26, 27, 51, 91, 101-103, 116
Grinding Stones	18 - 23, 112, 113
Honing	32, 34, 83, 86 - 92
Hyper-Finish Diamond Honing	32
Lifter Bore Honing	99
Mounted Points	1, 58, 60
PCD Inserts for Aluminum	48
Rod & Cap Grinding Wheels	91
Rod Honing / Pin Fitting	90 - 91
Sleeves	58, 118
Ultra-Finish Plateau Honing	36, 88, 92
Valve Guide Honing	32, 34
Valve Refacing	25 - 27
Valve Seat	18 - 23

Accu-Turn

Replacement Cutting Tips	117
Replacement Parts	122

Adjustable Coolant Hoses

Adjustable Counterbore Cutter Kit	15
---	----

Air Tools	17, 35, 36, 42, 43, 45
------------------------	------------------------

Align Hone Mandrels & Stones	92
All Tool Brake Lathe Replacement Tips	117
Aluminum Last Blast	70
Alumni-Chek	53
Ammco	
Belts, Drive	121
Brake Lathe Arbor	120
Brake Lathe Cutting Tips	117
Replacement Parts	118 - 122
Aprons	67, 69, 136
Arbor Nuts	120
Arbors	120
Assembly Lubes	70, 71
Assembly Wipes	65

B

Bags	63
Balancing Scales	97
Ball Head Seat Cutter Driver	6, 7
Ball Hones	34, 83, 89, 101, 122
Band Ring Compressors	95
Baskets	63, 69
Beehive Springs	131, 132
Beeswax	98
Bean Brake Lathe Replacement Tips	117
Bearing Scraper	100
Bell Clamps	121
Belt Dressers	107
Belts	
Crankshaft Polishing	108, 109
Cylinder Head Resurfacing	49
Kwik-Way Valve Refacer Belts	28
Made-to-Order	106
Oil Pump Belts	29, 90
Rod Honing Belts (for Sunnen)	29, 90
Sioux Replacement Belts	28
Sunnen® Honing Machine Belts	29, 90
Surface Grinding Belts	49
Bench Grinder Wheels	116
Bifocal Safety Glasses	60

Black & Decker

Adaptor for Sioux Stones	22
Replacement Collet	28
Stone Holders & Accessories	22
Valve Refacer Wheels	26

Black Diamond Valves	135
-----------------------------------	-----

Black Diamond Valve Guide Sizing	32
---	----

Black Light	53, 116
--------------------------	---------

Black Smoke Series Cutters	11
---	----

Blanchard Grinder Wheel	51
--------------------------------------	----

Block Bags	63
-------------------------	----

Blood Friction Master® Assembly Lube	71
---	----

Bluing Fluid	13
---------------------------	----

Bore Gauges & Setting Fixtures	125, 126
---	----------

Boring Bar Cutters/Accessories	84, 85
---	--------

Bounce Springs	6, 7, 24
-----------------------------	----------

Bowl Profiler Tooling & Blades	12
---	----

Brake Drum Grinding Wheels	122
---	-----

Brake Flex-Hones®	122
--------------------------------	-----

Brake Lathe	
--------------------	--

Arbors	120
--------------	-----

Bits	117
------------	-----

Brake Lathe (cont.)

Centering Cones	121
Cross Feed Shear Gear	120
Cutting Tips	117
Drum Feed Screws & Bushings	120, 122
Dust Boots	122
Feed Motor	120
Flexible Arbor Spacers	120
Lead Screw Bushing	118, 120, 121
Locking Knob	120
Mounting Adaptors	121
Replacement Parts	120 - 122
Rotor Feed Screws	120 - 122
Seals	120
Serpentine Drive Belts	121
Silencer Bands	119
Spindle Boots	122
Switches	120
Tip Holders	118
Tips	117
Wear Inserts, Brass	120

Brake Lubes	121
--------------------------	-----

Brake Shoe Grinding Sleeves	118
--	-----

Brass Shim Stock	62
-------------------------------	----

Brass Wear Inserts	120
---------------------------------	-----

Brazed Carbide Cutting Tools	118
---	-----

Break-In Lubes	71
-----------------------------	----

Bronze Liners & Tooling	38, 39
--	--------

Bronze Reaming Oil	31, 37
---------------------------------	--------

Brushes	32, 34, 38, 47, 64, 65, 66, 98, 99, 101
----------------------	---

Bucket Lifter Grinder	45
------------------------------------	----

Burets and Stands	47
--------------------------------	----

Burr Buster	116
--------------------------	-----

Burrs, Carbide	60
-----------------------------	----

Bushing Press Kit, Tapered Pin	94
---	----

C

Calipers	126, 127
-----------------------	----------

Cam-Shield®	71
--------------------------	----

Camshaft Work

Cam Bearing Tools	100, 101
Cam Bore Washing Brushes	64, 101
Cam Wheels	101
Flex-Hones®	83, 101

Carbide

Brake Tips	84, 117
Burrs (Rotary Files)	60
Cutters	8 - 11, 15, 33, 48, 62, 84, 85
Glass Bead Nozzles	68
Pilots	5
Reamers	31
Resurfacing Tips	48
Rotary Files	60
Sizing Balls	38, 39
Spot Facers / Top Cutters	33
Valve Spring Seat Cutters	46

Cap Grinding Wheels	91
----------------------------------	----

Cartridge Rolls	58, 59
------------------------------	--------

CBN Cutter Inserts	48
---------------------------------	----

CBN Dressing Stick	113
---------------------------------	-----

CBN Flywheel Stones	113
----------------------------------	-----

CC-ing Equipment	47
-------------------------------	----

Index

- CC-ing Liquid Concentrate** 47
- Centering Cones, 60°** 38
- Ceramlub™** 121
- Chamfer Tools** 33, 39
- Chamfering Cones** 46, 89
- Chevrolet**
- Block Organizer Tray 61
 - Conversion Plate 62
- Clamp-On Brake Lathe Silencers** 119
- Cleaning Supplies**
- Aprons 69, 136
 - Baskets 63, 69
 - Brushes .. 32, 34, 38, 47, 64 - 66, 98, 99, 101
 - Cleaning Media 69
 - De-foaming Agent 67
 - Detergents 67
 - Glass Beads 68
 - Gloves 63, 67 - 69
 - Parts Tumbler Solution 69
 - Pro-Jet Spray Cleaning Powder 67
 - Roloc Bristle Discs 65
 - Safety Gear 59, 60, 63, 67, 69
 - Scrapers 65, 100
 - Shop Towels 65
 - Sludge Filter Bag 72
 - Soda Blast 68
 - Ultrasonic Detergents & Filters 66
- Clover Lapping Compound** 17, 111
- Collets**
- Black & Decker 28
 - Dowel Puller 111
 - Expanding Pilots 4
 - Valve Grinding 25
- Combustion Chamber Measuring** 47
- Compression Release Valves** 130
- Concentricity Gauges** 13, 25
- Connecting Rod Heaters** 95
- Cold Chisel** 104
- Coolant Filters** 73
- Coolant Hoses** 72
- Coolants, Lubricants & Oils**
- All-Purpose Grinding Coolant 74
 - Aluminum Machining Aid 59
 - Belt Resurfacer Coolant 49, 74
 - Blood Friction Master 71
 - Brake Lubes 121
 - Bronze Reaming Oil 31, 37
 - Cam-Shield® Assembly Lube 71
 - Crank & Cam Grinding Coolant 74, 101
 - Cutting and Tapping Fluid 13, 55
 - Cylinder Honing Oil 74, 85
 - Diamond Honing Oil 33, 74, 85
 - Engine Assembly Gel 71
 - Extreme Pressure Lube 71
 - First Lube 71
 - Flywheel Grinding Coolant 74, 110
 - Flywheel Grinder Table Lubricant 73, 110
 - Gasket Maker / Thread Sealer 70
 - Gel Lube 46, 70
 - High Performance Resurfacing Spray 48
 - High Performance Valve Grinding Aid 25, 74
 - Honing Oil Concentrate 74
- Coolants, Lubricants & Oils (cont.)**
- Hylomar® 70
 - Knurlube 37
 - Lapping Oil 59, 85
 - Magnetic Crack Detection Oil 53
 - Mineral Based Honing Oil 74, 85
 - Minnesota Fast Freeze 12, 17
 - Multi-Duty Grinding Coolant 74
 - Petroleum Based Rust Prevention 72
 - Porting & Polishing Machining Aid 59
 - Plate Lube 54
 - Press Fit Lubricant 12, 71, 94
 - Rod Honing Oil 74, 88, 90
 - Rust Inhibitor for Pressure Tester 56
 - Rust Proofing Oil 72
 - Rust Shield 72, 73
 - Seat Cutting Fluid 14
 - Spray Assembly Lube 71
 - Surface Grinding Coolant 50, 74
 - Titanium Valve Grinding Aid 25, 74
 - Universal Gel Lube 46, 70
 - Valve Grinding Oil 27, 74
 - Valve Seat Machining Aid 13
 - Water Based Diamond Coolant 74, 85
 - Way Oil 73
- Coolant Magnet** 72
- Coolant Pumps** 72
- Core Drills / Reamers** 30
- Counterbore Cutters** 8-11, 15
- Crack Detection and Repair**
- Additives 56
 - Alumni-Chek 53
 - Applicators 52
 - Ceramic Motor Seal 56
 - Fluid Weld® 56
 - Goodson Glow 53
 - Heat Tabs 56
 - Magnetic Crack Detection Oil 53
 - Magnetic Field Indicator 52
 - Magnetic Powder 52
 - Parker Magnetic Crack Detection Unit 52
 - Powder 52
 - Repair Kit 55
 - Seal-All™ 56
 - Small Parts Demagnetizer 52
 - Threaded Plugs, Ironite® 55
 - UV Inspection Light 53, 116
- Crankshaft**
- Bearing Scraper 100
 - Crank Grinding Wheels 102, 103
 - Crank Welding Plug Rods 106
 - Dial Indicator, Starrett 104, 127
 - Diamond Dresser Tools 115
 - Display Inspection Stand 57, 101
 - Eliptibur Tool 105
 - Grinding Coolant 74, 101
 - Journal Radius Gauge 104
 - Peening Tool 105
 - Plastigage 106
 - Polishers 107
 - Polishing Accessories 107
- Crankshaft (cont.)**
- Polishing Belts 1, 108, 109
 - Polisher Motor 107
 - Reluctor Ring Installation Tool 105
 - Steady Rest Shoes 105
 - Steel Stamps 106
 - Stroke Checker 106
 - Stroker Mimic™ 105
- Crocus Cloth** 59
- Cross-Buffs®** 58, 59
- Cross Feed Dust Boots** 122
- Cross Feed Shear Gear** 120
- CSS Ultra Grinding Wheels** 102, 103
- Cummins Tooling** 11, 30, 35, 40
- Cutter Drivers & Adaptors** 15
- Cutting & Tapping Fluid** 13, 55
- Cylinder Block Work**
- Automotive Dowel Puller & Collets 111
 - Bore Washing Brushes 64, 65, 101
 - Deck Bridge Combination Tool 127
 - Lifting Sling 100
 - Oil Gallery Brushes 64, 98
 - Oil Gallery Plugs & Tools 98
- Cylinder Head CC-ing Equipment** 47
- Cylinder Head Resurfacing**
- Belt Resurfacer Coolant 49, 74
 - CBN Cutter Inserts 48
 - Dressers 51
 - Grind Aid 107
 - High Performance Resurfacing Spray 48
 - PCD Inserts for Aluminum 48
 - Rotary Broach Tool Bit 48
 - Segments 50
 - Surfacing Belts 49
 - Surfacing Wheels 51
- Cylinder Honing**
- Chamfering Cones and Mandrels 89
 - Goodson 86 - 88
 - Honing Oil 74, 85
 - Keyway Honing Stones 88
 - Lisle® 89
 - Nicasil 89
 - Plateau Honing 88, 92
 - Portable Cylinder Hones 86
 - Stones 86 - 90
 - Sunnen® 86 - 90

D

- D-Foam** 67
- David Vizard Porting Kit** 1
- Deburring Tools** 94, 116
- Deck Stand** 127
- Degree Wheel** 100
- Demagnetizer** 52
- Depth Gauge, Flywheel** 110
- Desmond Style Dressers** 51, 110, 116
- Detergents** 67
- Dial Bore Gauge Setting Fixtures** 125
- Dial Bore Gauges** 125, 126
- Dial Calipers** 126, 127
- Dial Indicators** 104, 127
- Diamond Dresser Tools** 29, 91, 114, 115
- Diamond Hand Files** 9

Diamond Flex-Hones®	83
Diamond Guide Hone Tools	32
Diamond Honing Oil	33, 74, 85
Die Grinding Stones	1, 58, 60
Diesel	
Core Drills & Reamers	30
Guide Tooling	30 - 40
Heat Tabs	56
Relief Tooling	11
Seat Installers	17
Spring Compressor	42
Super Abrasive	48
Valve Guide Tooling	30 - 40
Valve Guides	30, 37
Valve Seals	30, 40
Valve Seat Cutter Blades	8 - 11
Dingleberry Hones	34, 83, 89, 101, 122
Disposable Assembly Wipes	65
Distributor Depth Gauge	124
DOHC Organizer Tray	61
Double Angle Valve Seat Wheels	20
Dowel Puller & Collets	111
Dressers	
Abrasive Belt Dresser	107
CBN Dressing Stick	113
Cutter Assemblies	51, 110
Desmond-Style Dressers	51, 110, 116
Diamond Stone Dresser	91
Flywheel Stone Dressers	110, 115
Hand-Held Dressing Sticks	104
Premium Diamond Dressers	29, 114, 115
Refacing Grinding Wheel Dressers	29
Star Dressers	51, 110
Valve Seat Wheel Dressing Stands	24
Dressing Stand Pilots	5, 24
Drive Adaptors	6, 15
Dykem® Layout Fluid	13
E	
Eliptibur Tool	105
Engine Assembly Gel	71
Engine Brush Kit	65
Engine Cart	61
Engine Pre-Lube Supplies	70 - 73
Electric Rod Heater	95
Epoxy, Porting	58
Expanding Pilots	4
Extended Length Pilots (.375" Top)	4
Extreme Pressure Lube	71
F	
False Guides	37, 134
Fast Freeze	12, 17
Feeler Gauges	123
File, Diamond	9
Filter Bag	72
Filter Inspection Tool	98
Filter Paper & Mats	73

Filters	
Hone	73
Inline Air Filter	54, 55
First Lube	71
Flapwheels	1, 58, 59
Flex-Hones®	34, 83, 89, 101, 122
Fluid Weld®	56
Flywheel Grinding	
Bolt Adaptors	110
CBN Flywheel Stones	113
Coolant	74, 110
Dowel Puller & Collets	111
Depth Gauge	110
Dressers	110
Grinding Stones	112, 113
Mounting Adaptors	112
Flywheel Step Gauge	110
FMC	
Brake Lathe Replacement Parts	122
Brake Lathe Replacement Tips	117
Ford	
Core Drills & Reamers	30
Diesel Seat Cutter Blades	11
Smog Plugs	62
Valve Guides	37
Formula One Boring Tools	85
G	
Gas Porting Tools	94
Gasket Maker	70
Gauges	
Concentricity Gauge	25
Crankshaft Journal Radius Gauge	104
Distributor Depth Gauge	124
Dial Bore Gauges	125, 126
Feeler Gauges	123
Flywheel Depth Gauge	110
Magnetic Field Gauge	52
Rod Bolt Stretch Gauge	96, 123
Small Hole Gauge Set	39, 123
Split Ball Bore Gauge	39, 123
Spring Tester Height Indicator	40
Sunnens AG-Gauge	124
Telescoping Gauge Set	123
Torque Angle Indicator	57
Vacuum Tester Gauge	54
Valve Guide Gauge Set	124
Valve Seat Height Gauge	24, 126
Valve Seat Run-Out Gauges	13
Valve Stem Height Gauges	46
Warp Gauges	123
Gel Lube	46, 70
General Motors (GM)	
Oil Pickup Tube Driver	98
Reluctor Ring Installation Tool	105
Vortec Adaptor Plate Set	62
Glass Beading Supplies	68
Glasses, Safety	59, 60, 111

Gloves	
Glass Bead	68
Heat & Flame Resistant	69, 95
Hot Tank Gloves	67
Nitrile	63
Parts Washing Gloves	63
Grind Aid	107
Grinding Stones & Wheels (see Abrasives)	
Guide Installers (Drivers)	35
Guide Knurling	
Knurling Arbors	37
Knurlube	37
OD Knurling Tool	37
Guide Liners	39
Guide Shoes	88 - 90
Guide Tooling, Diesel	30 - 40
Guides	30, 37, 134
H	
Harley-Davidson® (see V-Twin)	
Head Bags	63
Head Bolt Spot Facer	62
Head Holders	47, 57
Head Organizer Trays	61
Heat Tabs	56
Heavy Metal	111
Height Gauges	24, 46, 126
High Performance	
Cam Wheels	101
CC-ing Equipment	47
Gasket Maker & Thread Sealer	70
Resurfacing Spray	48
Valve Grinding Aid	25, 74
Valve Seat Cutter Blades	8 - 9
Valve Spring Booster Shims	47
Valve Spring Compressors	42 - 44, 129
Valve Spring Testers	1, 41
Valve Train Checking Springs	46
High Pressure Cleaning System	66
Hi-Temp Last Blast Paint	70
Honing Oil	74, 85
Honing Stones	
Cylinder Honing	86 - 92
Lifter Bore	99
Pin Fitting	91
Rod Honing	90, 91
Valve Guide	32, 34
Hoses	42, 54, 72, 73
Hot Tank Detergents	67
Hylomar® Gasket Maker & Solvent	70
Hyper Finish Diamond Guide Sizing	32, 33
I	
ID Tags	61
IDL Valve Refacer Wheels	26
Import Head Stud Stretchers	50
Inspection Lights	53, 116
Inspection Stand	57, 101
Indicators	24, 40, 45, 46, 54, 57, 104, 110, 127
Infinite Flow Cutting Tips (IFT)	8

Index

Intake Port Reshaping Kit	58	
Iron-tite	55, 56	
J		
Jet Spray Cleaning Powder	67	
Jet Valve Eliminator Kit	55	
Jet Washer Parts Baskets	69	
K		
Keeper-Keeper	69	
Keeper Tools	44, 129	
Keyway Honing Stones	88	
Knurling	37	
Knurlube	37	
KO Lee Valve Refacer Wheels	26	
Kwik-Way		
Belts	28, 49	
Boring Bar Cutters	84, 85	
Brake Lathe Tips	117	
Drive Adaptor	19, 22	
Expanding Pilots	4	
Heavy Duty Dressing Stand	24	
Rebuild Kit for KW Holders	22	
Resurfacers Wheel Segments	50	
Single-piece Resurfacers Wheels	51	
Solid Tapered Pilots	3	
Stone Holders	22	
Valve Refacer Replacement Parts	28	
Valve Refacer Wheels	26	
Valve Seat Grinder Motors	19	
Valve Seat Stones	18	
L		
Lapping Compound	17, 111	
Lapping Oil	59, 85	
Lapping Tools & Compound	16, 17, 111	
Last Blast Paint	70	
Layout Fluids	13	
Letter Stamps	106	
Levels & Vials	7, 48	
Lifter Bore Tools	99	
Lifting Sling	100	
Lights		
Inspection Lights	53, 116	
LED Lights	116	
Work Lights	116, 120	
Liners, Guide		39
Lisle® Honing Stone Sets		89
Litmus Paper		67
Low-Lint Wipes		65
Lubricants		
Blood Friction Master®	71	
Brake Lubes	121	
Cam-Shield® Assembly Lube	71	
Extreme Pressure Lube	71	
First Lube	71	
Flywheel Grinder Table Lubricant	73, 110	

Lubricants (cont.)	
Press Fit Lube	12, 71, 94
Spray Assembly Lube	71
Universal Gel Lube	46, 70
Way Oil	73

M

Machine Covers	25, 41, 124	
Magnetic Bolt Washer Removers	47	
Magnetic Crack Detection	52 - 53	
Magnetic Strap Silencer	119	
Magnetic Valve Spring Shim Removers	47	
Mallory (Heavy Metal)	111	
Mandrels		
Butterfly Mandrels	59	
Chamfering Cone Mandrels	46, 89	
Cross Buff / Flap Wheel Mandrel	59	
Diamond Sizing System	32	
Honing	86, 92	
Lifter Bore Honing Mandrel	99	
Quick Change	58	
Roll Mandrels	59	
Valve Guide Hone	34	
Manual Ring Grinders		97
Manual Spring Compressors		43 - 45
Manual Vacuum Testers		54
Manual Valve Guide Drivers		35
Markers		61, 70
Maxxeon Work Lights		53, 116
Measuring Liquid Concentrate		47

Measuring Tools

Bore Gauges	125, 126
Calipers	126, 127
Crankshaft Dial Indicator	104, 127
Dial Indicators	104, 127
Distributor Depth Gauge	124
Feeler Gauges	123
Flywheel Depth Gauge	110
Micrometers	128
Rod Bolt Stretch Gauges	96, 123
Small Hole Gauge Set	39, 123
Straight Edges	123
Stroke Checker	106
Telescoping Gauge Set	123
Torque Angle Indicator	57
Valve Seat Height Gauge	24, 126
Valve Seat Run-Out Gauge	13
Valve Stem Concentricity Gauge	25
Valve Stem Height Gauges	46
Warp Alignment Gauge	123

Metal Markers		70
Micrometers		128
Micro Ball Head Tooling		7
Micro Valve Seat Stones		20
Milwaukee-Eight™ Parts		132 - 135
Minnesota Fast Freeze		12, 17, 40
Mitutoyo® Split Ball Bore Gauge		39, 123
Mondello Seat Cutter Blades		8

Motors

Brake Lathe	120	
Crankshaft Polisher	107	
Seat Grinding	19, 21, 23	
Mounted Points		1, 58, 60
Mr. Race Oil Engine Assembly Gel		71

N

Neway

Easy Turn Wrench	14	
Pilots	3 - 5	
Replacement Cutter Blades & Screws	14	
Valve Seat Cutters	14	
Nicasil Honing Stones		89
Number Stamps		106

O

O-Ring Wire	85
OHC Bucket Grinder	45
Oil Filter Tools	98
Oil Gallery Brushes	64, 98
Oil Gallery Cleaning System	66
Oil Gallery Tools	98
Oil Gallery Wax	98
Oil Pump Belts	90
Oil Pump Tools	98
On-The-Engine Spring Compressor	45, 129
Organizers	61
Oversize Bronze-Liners	37
Oversize Valve Guides	37, 134
Oversize Valve Seat Inserts	16, 133

P

Paint

Last Blast Spray Paint	70	
Markers	70	
Paper Shop Towels		65

Parts Cleaning

Airless Blaster Media	69
Baskets	63, 69
Brushes	32, 34, 38, 64 - 66, 98, 99, 101
Detergent Powders	67
Glass Bead Tools & Supplies	68
Gloves	63, 68, 69, 95
Keeper-Keeper	69
Parts Tumbler Solution	69
Pro-Jet Spray Cleaning Powder	67
Roloc Bristle Discs	65
Soda Blast Media	68
Super Scraper™	65
Surface Conditioning Discs	59, 65
Tumbler Cleaning Media	69
Ultrasonic Detergents & Filters	66

Parts Storage & Organizers

Valve Stem Protectors	69
Baskets	63
DOHC Cylinder Head Tray	61
Engine Cart	61
Keeper-Keeper	69
Organizer Trays	61

Index

- Parts Storage & Organizers (cont.)**
Parts Tags & Marker 61
Plastic Bags 63
Safety Pins 61
Shrink Wrap 63
- Parts Tumbler Media** 69
- Pastelub™ Hi-Temp Brake Lube** 121
- Peening Tool** 105
- Performance Brake Lathe Tips** 117
- Peterson**
Boring Bar Cutters 84
Core Drills & Reamers 30
Crankshaft Grinding Wheels 102, 103
Cylinder Head Resurfacing Belts 49
Resurfacers Abrasives 49 - 51
- pH Test Strips** 67
- Pilots**
Expanding 4
Extended Length Top Solid-Tapered 4
Micro 3, 5
Seat Dresser 5, 24
Solid-Tapered Steel 3
Specialty 5, 36, 46
Tapered Carbide 5
- Pin Bushing Press Kit** 94
- Piston Installing Tools**
Deadblow Hammer 96
Electric Rod Heater 95
Gas-Fired Rod Heater 95
Piston Pin Installing Fixture 95, 96
Ring Compressing Pliers 95
Rod Clamping Vise 96
- Piston Pin Removal Fixture** 93
- Piston Ring Filers** 97
- Plastigage** 106
- Plateau Hones** 36, 88, 92
- Plugs**
Crack Repair 55
Oil Gallery 98
Smog Plugs 62
- Pneumatic Tools**
Air Hammer 35
Lapping Tool 17
Valve Guide Drivers 35
Valve Spring Compressors 42, 43
- Polishing Belts** 1, 108, 109
- Polishing Rouge** 107
- Portable Cylinder Hones** 86
- Porting & Polishing**
Aluminum Oxide Cloth Shop Rolls 59
Butterfly Mandrels 59
Crocus Cloth 59
Cross-Buffs® 58, 59
Epoxy 58
Flapwheels 58, 59
Mandrels 58, 59
Mounted Points 58, 60
Port Reshaping Kit 58
Porting Abrasives Kits 1, 58
Porting & Polishing Machining Aid 59
Replacement Abrasives and Mandrels 59
Rotary Files 60
- Powered Ring Filer** 97
- Premium Tapered Reamers** 62, 116
- Press Fit Lubricant** 12, 71, 94
- Press Kit, Tapered Pin** 94
- Pressure Lube** 71
- Pressure Tester Rust Inhibitor** 56
- Pro Jet Spray Cleaning Powder** 67
- Prussian Blue** 13
- Pullers** 16, 40, 57, 111
- Pumps** 33, 72
- ## Q
- QualCast Products** 37, 40
- ## R
- Radiac Abrasives**
Blanchard Grinder Wheels 51
Cam Grinding Wheels 101
CBN Cutters 48
CBN Flywheel Grinding Wheels 113
Crankshaft Grinding Wheels 102, 103
Flywheel Grinding Wheels 113
PCD Cutters 48
Resurfacing Segments 50
Resurfacing Wheels 51
Rod & Cap Grinding Wheel 91
Valve Refacing Wheels 26 - 27
- Radial Wire Brushes** 65
- Reamers**
Bronze 31
Carbide Valve Guide 31
Core 30
Diesel 30
High Speed Steel for Cast Iron 31
Piloted Core Reamers 30
Small Diameter 31
Tapered 62, 116
- Reaming Oil** 31, 37
- Rebuilding Kits**
Stone Holder 22
- Reductor Ring Installation Tool** 105
- Removers**
Booster Shim 47
Bronze Liners 39
Cam Bearings 100
Dowel Pin Pullers 111
Keeper 44, 129
Liner Removal Tool Driver 39
Oil Gallery Plugs 98
Piston Pin 93
Piston Rings 95, 96
Stud 57
Tapered Pin Bushings 94
Valve Guide 35
Valve Seat 7, 16
Valve Seat Stone 19 - 24
Valve Stem Seal 40
Washer 47
- Resurfacing Belts** 49
- Resurfacing Coolant** 49, 50, 74
- Resurfacing Dressers** 51
- Resurfacing Spray** 48
- Resurfacing Wheel Segments** 50
- Resurfacing Wheels** 51
- Right Angle Air Driver** 23
- Rimac Spring Testers** 1, 41
- Ring Band Compressors** 95
- Ring Expanders** 96
- Ring Grinders** 97
- Rocker Arm Tools** 57
- Rod and Cap Grinding Wheels** 91
- Rod Balancing Supplies** 97
- Rod Bolt Boots** 96
- Rod Bolt Installing Block** 96
- Rod Bolt Stretch Gauge** 96, 123
- Rod Clamping Vise** 96
- Rod Heaters** 95
- Rod Hone Filter Mat** 73
- Rod Honing** 90, 91
- Rod Honing Oil** 74, 88, 90, 99
- Roloc Bristle Discs** 65
- Rotary Broach Tool Bits** 48, 110
- Rotary Files** 60
- Rotor Adaptors** 121
- Rotor Silencers** 119
- Rottler**
Boring Bar Cutters 84, 85
Sleeve Cutters 84
Valve Refacer Wheels 26
- Round Brake Lathe Tips** 117
- RTI Brake Lathe Tips** 117
- Rubber Abrasive Belt Dresser** 107
- Rust Protection** 56, 72, 73
- ## S
- Saber Tooth Seat Cutter Blades** 8 - 11
- Safety Glasses** 59, 60, 111
- Safety Pins** 61
- Scales, Balancing** 97
- Scrapers** 65, 100
- Screws**
Ball Head 6, 7
Boring Bar 84
Carbide Cutter 6, 7, 14, 15
Catspaw 84
Cross Buff Mandrel 59
Feed Screws 118 - 122
Neway 14
- Scribe Tool** 13
- Seal-All™** 56
- Seals** 30, 40, 133
- Seal Cutters** 36, 129
- Seal Pullers** 40
- Seal Setters** 133
- Seats** 16, 133
- Seat Cutters** 8 - 12, 14 - 15, 46
- Seat Cutting Fluid** 14
- Seat Drivers** 17
- Seat Grinding** (see Valve Seat Grinding)
- Seat Removers** 7, 16
- Segments** 50
- Serdi-Style Bodies & Drivers** 6

Index

- Shim Remover** 47
Shim Stock 62
Shims 47, 62
Shot
Ceramic & Steel 69
Glass 68
Shop Towels, Low Lint 65
Shrink Wrap 63
Silencer Bands, Brake Lathe 119
Sioux™ Replacement Parts
Belts 28
Driver Parts 19, 21, 22, 28
Parts Tumbler Rebuild Parts 69
Vacuum Tester Gauge 54
Valve Grinder Parts 28
Valve Refacer Parts 28, 29
Wheel Dresser Parts 24
Sioux-Style
Drive Adaptor 21
Drivers 21
Pilots 3 - 5
Stone Holders 22
Vacuum Plates 54
Valve Refacer Wheels 27
Valve Seat Grinding Kit 21, 23
Valve Seat Stone Removers 21, 24
Valve Seat Wheels 20, 21, 23
Sizing Balls 38, 39
Sling, Lifting 100
Sludge Filter Bag (Sock) 72
Smog Plugs 62
Snap-on
Replacement Brake Lathe Cutting Tips... 117
Valve Refacer Wheels 27
Spark Plug Thread Chaser/Burnisher 62, 116
Spindle Boots 122
Split Ball Bore Gauge 39, 123
Spot Facers 62
Spray Assembly Lube 71
Spray Bluing Fluid 13
Spring Compressors 42 - 45, 129
Spring Pad Cutters 12, 46
Spring Testers 41
Stamps, Steel 106
Steady Rest Shoes 29, 105
Steel Shim Stock 62
Step Gauge 110
Stone Holders 19 - 23
Stones
Camshaft 101
Crankwheel 102, 103
Flywheel 112, 113
Honing 86 - 92
Porting & Polishing 58, 60
Refacing 26, 27
Resurfacing 50, 51
Rod Honing 90, 91
Valve Seat 18 - 23
Storage Bags 63
Storage Cart 61
Storm-Vulcan
Crankshaft Grinding Wheels 103
Resurfacers Belts 49
Resurfacers Wheel Segments 50
Resurfacing Carbide Cutter Tips 48
Straight Edges 123
Stroke Checker 106
Stroker Mimic™ 105
Stud Extractor 57
Stud Stretchers 50
Sunnen®
Adjustment Pinion 86
AG-Series Precision Gauge 124
Align Hone Stones 92
Belts for Rod Honing Machines 90
Cap Grinding Wheels 91
Coolants & Oils 74
Core Drills & Reamers 30
CV-616 Honing Machine Parts 29, 90
Cylinder Honing Stones 86 - 92
Dial Bore Gauges 125
Guide Shoes 88, 90, 91
Lifter Bore Hones 99
Mandrel Drivers 90, 92
Master Holder & Stone Supports 87
Oil Pump Belts 90
Plateau Honing Tools, Ultra-Finish 88
Portable Cylinder Hones 86
Press-Fit Lubricant 12, 71
Replacement Parts for CV-616 29, 90
Rod Honing Machine Belts 90
Rod Honing Stones & Guide Shoes .. 90, 91
Silicon Compound (AN-30) 92
Truing Sleeves 34, 99
Valve Guide Gauge Set 124
Valve Guide Hone Set 34
Valve Refacer Steady Rest Shoes 29
Valve Refacer Wheels 26, 27
Super Scraper™ 65
Surfacing
Belts 49
CBN Inserts 48
Coolants 49, 50, 74
PCD Inserts 48
Segments 50
Wheels 51
Swedge Cutting Tool 118
Switches 19, 21, 28, 120
T
Tapered Pin Bushing Kit 94
Tapered Reamers 62, 116
Tapping Fluid 13, 55
Taps
Crack Repair 55
Telescoping Gauge Set 123
Temperature Indicator Crayons 95, 105
Thin Wall Bronze Liners 39
Thread Chaser 62, 116
Timing Chain Tensioner 85
Tip Holders, Brake Lathe 118
Titanium Coated Cutting Tips 117
Tooling Stands 46
Top Cutters 33, 62
Torque-Angle Indicator 57
Trays, Organizing 61
Trizact™ Crank Polishing Belts 1, 108
Tumbling Media 69
U
Ultra-Finish Plateau Honing Tools .. 36, 88, 92
Ultrasonic Detergents & Filters 66
Universal Checking Standards 128
Universal Dressing Stand 24
Universal Gel Lube 46, 70
Universal Head Holder 47, 57
Universal Spring Pad Cutter 12
Utility Rolls 59
UV Inspection Light 53, 116
V
V-Twin
Compression Release Valves 130
Hard Parts 130 - 135
On-the-Engine Spring Compressor ... 45, 129
Valve Guides 134
Valve Seals 133
Valve Seat Inserts 16, 133
Valve Spring Compressors 45, 129
Valve Springs 130 - 132
Valves 132, 135
Vacuum Plates 54, 55
Vacuum Testers 54, 55
Valve Grinding
Adaptor for ½" Chucks 25
Black & Decker Valve Refacer Collets 28
Diamond Dresser Tools 29, 115
Dresser Pilots 5, 24
Machine Covers 25
Machine Parts 28, 29
Valve Grinding Aid 25, 74
Valve Grinding Oil 27, 74
Valve Refacer Wheels 26, 27
Valve Stem Concentricity Gauge 25
Valve Guide
Bronze-Liners 38, 39
Brushes 32, 34, 38, 64
Core Drill / Reamer 30
Diamond Hone Set 32
Drivers 35, 36
Flex-Hones® 34, 83
Gauge Sets 39, 123, 126
Guides 37, 134
Hone Set 32, 34
Knurling Tools 37
OD Chamfer Tool 33
OD Knurling Tool 37
Plateau Hones 36
Reamers 31
Small Hole Gauge Set 39, 123
Spot Facer 62

Valve Guide (cont.)	
Top Collars	33
Top Cutters	33, 62
Valve Guide Brushes	32, 38, 64
Valve Guides	37, 134
Valve Lapping Tools & Supplies	16, 17
Valve Refacing Wheels	26, 27
Valve Seal Drivers	133
Valve Seal Pullers	40
Valve Seal Setter	133
Valve Seals	30, 40, 133
Valve Seat	
Basic Valve Seat Grinding Kits	19, 21
Bounce Springs	6, 7, 21, 24
Cutter Blades	8 - 11, 14, 15
Cutter Drivers	6, 7, 14, 15
Cutting Fluid	14
Cutting System	6, 7, 14, 15
Dressers	19, 21, 24
Drivers	19, 21, 23
Inserts	16, 133
Layout Fluids	13
Machining Aid	13
Minnesota Fast Freeze	12, 17
Neway Seat Cutting System	14
Nickel-Chrome Valve Seats	16
Removers	7, 16
Run-Out Gauges	13
Stone Holders	22, 23
Valve & Seat Scribe	13
Valve Seat Cutter Blades	8 - 11, 14, 15
Valve Seat Counterbore Cutters	15
Valve Seat Grinding	18 - 24
Valve Seat Insert Driver	17
Valve Seat Wheels	18 - 21
Valve Spring	
Adaptors	43, 44
Booster Shims	47
Calibrated Springs	1, 41
Compressors	42 - 45, 129
Height Indicator	40
Inserts	47
Keeper Installation Tools	44, 129
Manual Valve Spring Bench	43
Pneumatic Valve Spring Press	42
Seat Cutters	46
Spring & Retainer Kits	130 - 132
Testers	1, 41
Valve Spring Inserts	47
Valve Spring Shim Remover	47
Valve Spring Testers	1, 41
Valve Stem	
Concentricity Gauge	25
Dial Indicated Valve Stem Height Gauge ...	46
Protectors	69
Valve Stem Oil Seals	30, 40, 133
Valves	132, 135
Van Norman	
Boring Bar Cutters & Parts	84, 85
Core Drills & Reamers	30
Crankshaft Grinding Wheels	103
Flywheel Cutter	110
Resurfacer Segments	50
Single-piece Resurfacer Wheels	51
Valve Refacer Wheels	27
Vials, Level	7, 48
Vizard Porting Kit	1
Vortec Tools	62

W

Warp Gauge	123
Water Based Honing Coolant	74, 85
Way Oil	73
Wear Inserts, Ammco	120
Wear Sleeves	15
Welding Rods	106
Wipes	65
Wire Wheels & Brushes	64, 65
Wrist Pin Bushing Press Kit	94

California Proposition 65



WARNING: Cancer and Reproductive Harm - www.P65Warnings.ca.gov

"Proposition 65 requires businesses to provide warnings to Californians about significant exposures to chemicals that cause cancer, birth defects or other reproductive harm."

Due to recent regulatory changes in California, we must now warn you that many of the materials commonly used to manufacture our products contain chemicals known to the state of California to cause cancer and reproductive harm.

A complete list of materials requiring the Prop 65 warning can be found at <https://www.p65warnings.ca.gov>.

WARNING: Operating, servicing and maintaining a passenger vehicle or off-road vehicle can expose you to chemicals including engine exhaust, carbon monoxide, phthalates, and lead, which are known to the State of California to cause cancer and birth defects or other reproductive harm. To minimize exposure, avoid breathing exhaust, do not idle the engine except as necessary, service your vehicle in a well-ventilated area and wear gloves or wash your hands frequently when servicing your vehicle. For more information go to www.P65Warnings.ca.gov/products/passenger-vehicle.

If you need additional information about any specific products sold by Goodson, please check our website or contact the Goodson Techxperts for details. Call 1-800-533-8010.

Your Shortcuts

Use the space below to record your most frequently ordered items.

Policies

Pricing:

Prices are subject to change without notice. There is no minimum order. Orders are billed at the prices in effect at the time of shipping. Discounts are not available on Sunnen® QualCast or ULTRASONIC, LLC products.

Shipping:

Goodson makes every effort to ship orders the same day they are received. Due to carrier cut-off times, orders received after 2:00 pm (central time), on weekends or holidays may not ship until the next business day.

You have several choices of shipping methods. Cost of shipping is based on total weight or package dimensions and the distance from our warehouse. **Goodson is not responsible for weather related shipping delays.**

- **STANDARD:** Unless otherwise requested, we ship items up to 100 pounds and up to 130" in combined width, length and height by US Postal Service, UPS or FedEx services. Items over the weight or size limit must go by common carrier.
- **EXPRESS:** We can ship most items by air to arrive in your choice of 1, 2 or 3 days. Aerosol products, however, require a HazMat fee when shipped by air.

Upon receipt of your order, please inspect all cartons immediately for damaged or missing products BEFORE signing for the merchandise. Any packages received in a damaged condition should be rejected and/or noted at the time of delivery. If items are missing or damaged, please contact Goodson within 3 business days.

Freight Allowance:

For open account orders shipped ground within the USA, you may deduct the freight charges on any **JOBBER** net invoice of **\$800** or more if you pay within 30 days (including Internet orders). However, Glass Beads, Steel Shot, Tumbler Media, Machines, Equipment, Bulk Liquids, Cleaning Detergents and Crankwheels are not included (shipped F.O.B. Winona, MN). Hazardous Materials, Dangerous Goods and Dimensional Shipping fees may apply on certain items. Please call to inquire.

Open Account Terms:

- 1) A 1% discount is given on merchandise if payment is made within 15 days from invoice date. This discount applies to the merchandise amount, before shipping, taxes & fees on the invoice. The discount amount is shown in the lower left hand corner of the invoice. This discount does not apply to statement payments and does not apply to credit card or PayPal orders.
- 2) Balances not paid in full within 30 days are subject to a finance charge of 1.5% per month (18% per year).

Credit & Debit Card Orders:

Goodson accepts MasterCard, Visa, American Express, Discover Card and PayPal. For your security, credit card numbers are NOT kept on file. Credit card and PayPal orders do not qualify for the 1% quick-pay discount.

Check Acceptance:

In the unlikely event that your check is returned for insufficient or held funds, we will debit your checking account electronically for the face amount of the check plus the service fee allowed by your state's law. This allows us to resolve the problem without turning you over to a collection agency and harming your credit rating. The transaction will appear on your bank statement and no one will have to contact you about payment.

Returns:

You may return any item, **except special orders and HazMat* items**, within 60 days. We will do our best to correct any problems or to send a replacement. If an item was damaged through mis-use or modification, Goodson will not accept it as a return. Credits will only be issued after it is determined that the part is resellable or it is deemed defective.

To return an item, please follow these easy steps:

1. Enclose a note explaining why you're returning the product. For faster processing, be sure to include your name and account number (you'll find this on your invoice)
2. Ship the item freight prepaid within 60 days from invoice date to
Goodson Tools & Supplies for Engine Builders
ATTN: Returns
156 Galewski Drive
Winona, MN 55987

For best results, please ship return merchandise by a trackable shipping method. Keep your shipping receipt as it may be necessary to track the package if it is lost in transit. A 10% restocking fee may apply on returns unless the problem was the fault of Goodson. If so, the restocking fee is waived and shipping costs are reimbursed.

ABRASIVES WARRANTY: Abrasives have a shelf-life, therefore, all abrasives are warranted against manufacturing defects for 1 year from the date of original purchase.

***HAZMAT ITEMS:** Only businesses certified to ship Hazardous Goods can ship such items. To return a HazMat item to Goodson, please call us at **1-800-533-8010** for shipping recommendations.

Privacy Policy:

All information that Goodson collects from its customers through purchases, credit applications or other transactions is kept private and is not disclosed to anyone except as permitted or required by law. Goodson will not sell or trade this information to anyone. Goodson will limit employee access to customers' private information to only those employees who need to know the information to provide products and services to you. Goodson maintains internal safeguards to protect our customer's non-public information. Please visit our website to read our privacy policy at <https://goodson.com/pages/privacy-policy> or scan the code at right to be directed to the page.



International Sales:

All items shipped F.O.B. Winona, MN, USA. To find a distributor near you, visit www.goodson.com.

Goodson currently has distributors in:

- Austria • Australia • Belgium
- Canada • Chile • Colombia
- Costa Rica • Ecuador
- El Salvador • Finland
- France • Germany
- Guatemala • Honduras • Italy • Luxembourg • Mexico • Netherlands
- New Zealand • Norway • Poland • Portugal • Spain • Suriname
- Sweden • Switzerland • United Kingdom • Venezuela



Resharpener & Resetting:

Goodson offers Resetting & Resharpener services for the following:

- Diamond Dressers • CBN & PCD Resurfacing Cutters
 - Valve Seat Cutter Blades • Rotary Broach Tool Bits for Van Norman
- Get more information and pricing by calling **1-800-533-8010**.



Flex-Hones® For Any Type And Size Of Cylinder

- Abrasive globules each have independent suspension • Self-centering • Self-aligning • Self-compensating for wear
- Applications are interchangeable, select bore size • Right Hand rotation only

CYLINDER HEAD REBUILDING
CLEANING, ASSEMBLY & SAFETY
SHORT BLOCK REBUILDING
GRANKSHAFT/ FLYWHEEL GRINDING
MISCELLANEOUS TOOLS & SUPPLIES
BRAKE SERVICE TOOLING
MEASURING TOOLS
V-TWIN & METRIC HARD PARTS

240 Grit Silicon-Carbide Valve Guide Flex-Hones®

- Ideal for all materials including cast iron, bronze, phosphor bronze and aluminum

Size mm	OAL	Jobber	Order No. Incl.
6 Pc. Kit \$99.99 VG-F-KIT ▼			
1 1/64"	4.5	6"	25.99 VG-F-4.5MM
1 3/64"	5.0	8"	25.99 VG-F-5MM
7/32"	5.5	8"	25.99 VG-F-5.5MM
1/4"	6.4	8"	25.99 VG-F-6.4MM x
9/32"	7.0	8"	25.99 VG-F-7MM x
5/16"	8.0	8"	25.99 VG-F-8MM x
11/32"	9.0	8"	25.99 VG-F-9MM x
3/8"	10.0	8"	25.99 VG-F-10MM x
7/16"	11.0	8"	25.99 VG-F-11MM x
15/32"	12.0	8"	25.99 VG-F-12MM
33/64"	13.0	8"	25.99 VG-F-13MM
7/16"	14.0	8"	25.99 VG-F-14MM
19/32"	15.0	8"	25.99 VG-F-15MM

400 Grit Diamond Valve Guide Flex-Hones®

- Ideal for heat treated steel, high nickel stainless steel, chromes or plated bores, MMX aluminum alloys, ceramics and carbides

Size mm	OAL	Jobber	Order No.
1/4"	6.4	8"	\$46.99 VGFD-6.4MM
9/32"	7.0	8"	46.99 VGFD-7MM
5/16"	8.0	8"	46.99 VGFD-8MM
11/32"	9.0	8"	46.99 VGFD-9MM
3/8"	10.0	8"	46.99 VGFD-10MM



Order 3 or more Flex-Hones® (mix & match) and save 10% off jobber

120 Grit Silicon-Carbide Flex-Hones®

- Ideal for all materials including cast iron, bronze, phosphor bronze and aluminum
- When ordering heavy-duty, order on cylinder size

Size	Standard			Heavy-Duty		
	mm	OAL	Jobber	OAL	Jobber	Order No.
2"	50.8	8"	\$39.99			BG-210
2 1/4"	57.2	8"	43.99			BG-225
2 1/2"	63.5	8"	38.99			BG-250
2 3/4"	69.8	8"	41.99			BG-275
3"	76.2	8"	47.99			BG-300
3 1/4"	82.6	13 1/2"	52.99	13 1/2"	\$76.99	BGD-300
3 1/2"	88.9	13 1/2"	57.99	13 1/2"	92.99	BGD-325
3 3/4"	95.3	13 1/2"	63.99	13 1/2"	83.99	BGD-350
4"	101.6			13 1/2"	86.99	BGD-375
4 1/8"	104.8	13 1/2"	75.99			BGD-400
4 1/4"	107.9			13 1/2"	101.99	BGD-425
4 3/8"	111.1	13 1/2"	87.99			BGD-450
4 1/2"	114.3			13 1/2"	105.99	BGD-450
4 5/8"	117.5	13 1/2"	76.99			BGD-462
5 1/2"	139.7			17 1/2"	136.99	BGD-550
6"	152.4			17 1/2"	138.99	BGD-600
6 1/2"	165.1			17 1/2"	159.99	BGD-650

180 Grit Silicon-Carbide Flex-Hones®

- Ideal for all materials including cast iron, bronze, phosphor bronze and aluminum
- Sizes with extra-long shanks are ideal for cam bearings

Size	Standard			Extra-Long Shank*		
	mm	OAL	Jobber	OAL	Jobber	Order No.
5/8"	15.9	8"	\$21.99			BH-625
3/4"	19.1	8"	22.99			BH-750
13/16"	20.6	8"	27.99			BH-820
7/8"	22.2	8"	22.99			BH-875
1"	25.4	8"	23.99			BH-1000
1 1/8"	28.6	8"	24.99			BH-1125
1 1/4"	31.8	8"	26.99			BH-1250
1 3/8"	34.9	8"	27.99			BH-1375
1 1/2"	38.1	8"	29.99			BH-1500
1 5/8"	41.3	8"	28.99			BH-1625
1 3/4"	44.5	8"	30.99	17 1/2"	\$61.79	CBF-175*
2"	50.8	8"	31.99	17 1/2"	63.99	CBF-200*
2 1/4"	57.2	8"	34.99	17 1/2"	64.99	CBF-225*
2 1/2"	63.5	8"	38.99	17 1/2"	66.99	CBF-250*
2 3/4"	69.8	8"	39.99	17 1/2"	67.99	CBF-275*

*CBF flex-hones include an extender & nipple for OAL of 17 1/2"

320 Grit Standard Duty Silicon-Carbide Flex-Hones®

- Ideal for all materials

Size	mm	OAL	Jobber	Order No.
1 1/4"	31.8	8"	\$40.99	BG-125320
2 1/4"	57.2	8"	51.99	BG-225320
3"	76.2	8"	69.99	BG-300320
3 3/4"	82.6	13 1/2"	81.99	BG-325320
3 1/2"	88.9	13 1/2"	86.99	BG-350320
3 3/4"	95.3	13 1/2"	92.99	BG-375320
4 1/8"	104.8	13 1/2"	95.99	BG-418320
4 3/8"	111.1	13 1/2"	131.99	BG-438320
4 5/8"	117.5	13 1/2"	115.99	BG-462320

320 Grit Heavy Duty Silicon-Carbide Flex-Hones®

- Ideal for all materials

Size	mm	OAL	Jobber	Order No.
4"	101.6	13 1/2"	\$138.99	BGD-400320
4 1/4"	107.9	13 1/2"	149.99	BGD-425320
4 1/2"	114.3	13 1/2"	154.99	BGD-450320

240 Grit Aluminum-Oxide Flex-Hones®

- Ideal for hard surfaces such as Nicasil and hardened steel

Size	mm	OAL	Jobber	Order No.
2 1/4"	57.2	8"	\$45.99	BA-225240
2 3/8"	60.2	8"	47.99	BA-237240
2 1/2"	63.5	8"	48.99	BA-250240
2 5/8"	66.8	8"	51.99	BA-262240
2 3/4"	69.8	8"	54.99	BA-275240
3"	76.2	8"	63.99	BA-300240
3 3/4"	82.6	13 1/2"	70.99	BA-325240
3 1/2"	88.9	13 1/2"	77.99	BA-350240
3 3/4"	95.3	13 1/2"	80.99	BA-375240
4 1/8"	104.8	13 1/2"	85.99	BA-418240
4 5/8"	117.5	13 1/2"	97.99	BA-462240

... another satisfied customer

"Very happy with both products and service."
- Alliance Diesel, Charlotte, NC, Goodson customer since 2014

CYLINDER HEAD REBUILDING

CLEANING, ASSEMBLY & SAFETY

SHORT BLOCK REBUILDING

CRANKSHAFT/ FLYWHEEL GRINDING

MISCELLANEOUS TOOLS & SUPPLIES

BRAKE SERVICE TOOLING

MEASURING TOOLS

V-TWIN & METRIC HARD PARTS



WINONA VAN NORMAN, VAN NORMAN, PETERSON, KANSAS INSTRUMENTS

1-EDGE CUTTER BIT				
Fits Model Numbers	Type	Bit Dia.	Jobber	Order No.
777, 900, 905, 944, 965	General	1/4"	\$50.99	VN-1
777S, 777S4, 944S, CB11, BC22XL, PK447S	General	3/8"	50.99	VGS-1
	Hard Sleeves	3/8"	50.99	VGS-2
	Sleeve Cutter	3/8"	50.99	VGS-3
888, 999	General	1/4"	74.99	VN-360

Original Van Norman				
Fits Model Numbers	Type	Bit Dia.	Jobber	Order No.
777S, 944S	Hard Sleeves	3/8"	\$69.99	777-179

HOLDERS FOR 6-EDGE TIPS - Use RT-6B and RT-6BT (each holder includes one tip)				
Fits Model Numbers	Length	Height	Jobber	Order No.
777, 900, 905, 944, 965	1 7/8"	3/4"	\$204.99	VN-135
777S, 777S4, 944S	2"	1 3/16"	203.99	VN-122
Bore Range: 2.65" to 4.50"	VN-122 Adjustment Set Screw		18.99	LW-1138

Standard Carbide Replacement Cutter Tip		\$12.99	RT-6B
Titanium Coated Carbide Replacement Tip		13.99	RT-6BT enlarged

MISCELLANEOUS PARTS			
Fits 6-Edge Holders Above	Bit Screw	\$4.99	VN-130

tech tips from the techexperts™
VN-130 will also fit KWL-116



KWIK-WAY

1-EDGE CUTTER BIT FOR OE HOLDERS				
Fits Model Numbers	Type	Bit Dia.	Jobber	Order No.
F, FT, FL, FN, FR, FS,	Rough	5/16"	\$37.99	KWL-R
FW, FWS, FWSII, FX	Finish	5/16"	37.99	KWL-F
Models After 1770	Sleeve Cutter	5/16"	37.99	KWL-C

HOLDER FOR 6-EDGE TIPS - Uses RT-6B or RT-6BT Tips (each holder includes one tip)				
Fits Model Numbers	Length	Height	Jobber	Order No.
FL, FN, FR, FS, FT, FW	2 1/16"	5/8"	\$179.99	KWL-116
Standard Carbide Replacement Cutter Tip			12.99	RT-6B
Titanium Coated Carbide Replacement Cutter Tip			13.99	RT-6BT

PETERSON-BERCO

1-EDGE CUTTER BIT FOR OE HOLDERS				
Fits Model Numbers	Length	Bit Dia.	Jobber	Order No.
ACP-151-A, ACP-151-BL, SCP-151-P	1 3/4"	10mm	\$43.49	PB-151

ROTTLER

1-EDGE CUTTER BIT FOR OE HOLDERS				
Fits Model Numbers	Length	Bit Dia.	Jobber	Order No.
All Bars	1 3/4"	1 1/32"	\$28.99	RL-1
Sleeve Cutter for All Bars	1 3/4"	1 1/32"	28.99	RL-1C

HOLDER WITH 3-EDGE TIP - Includes one RL-2T Tip				
Fits Model Numbers	Length	Bit Dia.	Jobber	Order No.
All Bars (holder includes one tip)	1 3/4"	1 1/32"	\$46.99	RL-2H
Replacement Screw for RL-2H			6.49	RL-2S
Replacement Cutter Tip			17.49	RL-2T

STORM-VULCAN

1-EDGE CUTTER BIT FOR OE HOLDERS				
Fits Model Numbers	Length	Bit Dia.	Jobber	Order No.
NS, BCG, BCT, 220, 260	3/4"	5/16"	\$49.99	S-1



1-Edge Replaceable Type
Tool holder with separate bit. Excellent cutting yet economical. Resharpen the cutter bit many times. When no longer usable, replace only the bit.

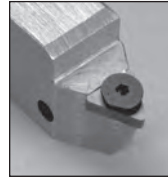

6-Edge Replaceable Type
Lowest-cost choice. Holders take 6-edge, replaceable tips. When one edge wears, turn to new surface. Never need to resharpen - just replace the tip.

Looking for Something Not Listed? Contact Goodson For Special Order Boring Bar Holders or Other Tooling
1-800-533-8010

Cutters enlarged for detail

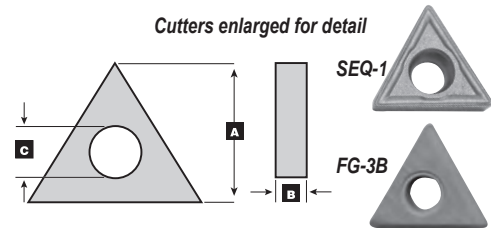

Replacement Tips & Parts

• Fit most boring bar holders

A	B	C	Edges	Jobber	Order No.
Standard Carbide					
.358"	.097"	.108"	3	\$21.99	SEQ-1
.345"	.094"	.140"	6	12.99	RT-6B
.360"	.094"	.124"	3	14.49	FG-3B
.327"	.094"	.140"	3	17.49	RL-2T
Titanium Coated					
.345"	.094"	.140"	6	\$13.99	RT-6BT

The more you buy, the more you save!
Order 10 or more tips, save 10% off jobber



Van Norman, Peterson or Kansas Instruments OE Catspaw Screws For 777S or PK-447S & 944S

Description	Jobber	Order No.
Catspaw Screws (1 each)		
For #1 Shoe (0.625"L)	\$15.99	800-114
For #2 Shoe (0.740"L)	14.49	800-115
For #3, 4 & 5 Shoe (0.940"L)	14.49	800-116



Fine Lapping Oil

- A light lap oil coat cools and lubricates
- Use with a variety of applications including diamond laps (below) and crocus cloth (p. 59)

Description	Jobber	Order No.
Very Fine Lap Oil (4 fl. oz.)	\$12.99	LP-LO-4
Very Fine Lap Oil (8 fl. oz.)	21.99	LP-LO-8
Dressing Stick	11.99	LP-DS

1 lb. Roll Copper or Stainless Steel O-Ring Wire

- Copper wire is .0403" diameter
- Stainless steel wire is .0410" diameter
- Each roll contains about 200 feet of wire

Description	Jobber	Order No.
Copper	\$106.99	OWC-0403
Stainless Steel	90.99	OWS-041



Boring Bar O-Ring Cutter Replaceable Tool Bits

- Cut grooves for O-rings to enhance gasket sealing for high-performance engines
- Machines a groove .037" wide • 1/4" Shank
- Fit Winona Van Norman, VN, Peterson, KI, Kwik-Way & Rottler Holders (available by special order)

Description	Application	Jobber	Order No.
Tool Bits	Standard	\$ 92.99	KWVN-57
	Premium	102.99	KWVN-57C6

tech tips

from the techxperts™

To avoid breakage, use the standard cutter on cast iron blocks only and the Premium cutter on hard blocks. **CAUTION:** Avoid column drop as this will break the tips as well.

Conversion Calculator

We've tried to convert as many SAE measurements to Metric (and vice versa) as possible. In some cases there hasn't been enough room.

If you need to convert a measurement, here are the formulas:

Starting Measurement	Conversion Formula	Converted Measurement
Inches (in)	Inches x 25.4	Millimeters (mm)
Feet (ft)	Feet x .3048	Meters (m)
Millimeters (mm)	Millimeters ÷ 25.4	Inches (in)
Fahrenheit (F)	(5 ÷ 9) x (F - 32)	Celsius (C)
Celsius (C)	(9/5 x C) + 32	Fahrenheit (F)

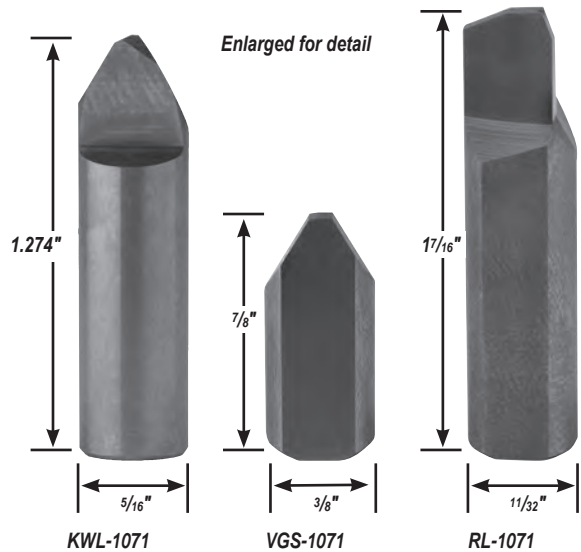

Solid Carbide Formula One Single Pass Boring Tools

- Greater fracture resistance than most carbide bits
- Ideal for hard alloys or interrupted cuts in automotive, high performance, marine, motorcycle and diesel engines

Description	Jobber	Order No.
Kwik-Way 5/16" x 1.274"L	\$85.99	KWL-1071
Van Norman 3/8" x 7/8"L	85.99	VGS-1071
Rottler 11/32" x 17/16"L	84.99	RL-1071

Water Based Diamond Honing Coolant

- Suitable for diamond honing on cast iron blocks
- Greatly reduces heat buildup in the block during honing
- Reduces amount of block cleaning after honing
- Disposal of used coolant is easy and more environmentally friendly than conventional honing oils
- 5 gallons makes up to 55 gallons of coolant
- Order No. **DHC-50** Jobber \$319.99



Clear Mineral Based Honing Oil

- Helps keep stones clean and free-cutting
- Ideal for portable hones and all makes of automotive honing machines
- Mixes easily with other brands, including Sunnen®
- **Not** water soluble

Size	Jobber	Order No.
1 Gal./3.78L	\$ 35.99	HO-10
5 Gal./18.9L	159.99	HO-50



CYLINDER HEAD REBUILDING
CLEANING, ASSEMBLY & SAFETY
SHORT BLOCK REBUILDING
CRANKSHAFT/ FLYWHEEL GRINDING
MISCELLANEOUS TOOLS & SUPPLIES
BRAKE SERVICE TOOLING
MEASURING TOOLS
V-TWIN & METRIC HARD PARTS

tech tips

from the techxperts™

- 1 - Extend the range of your hone with the Master Holder and Stone Supports on the bottom of page 87
- 2 - Use with 1/2" non-pistol grip drill (5/8" drill for AN-815 & GH-2555)
- 3 - Heavy Duty units can also be used in manual hone cabinets

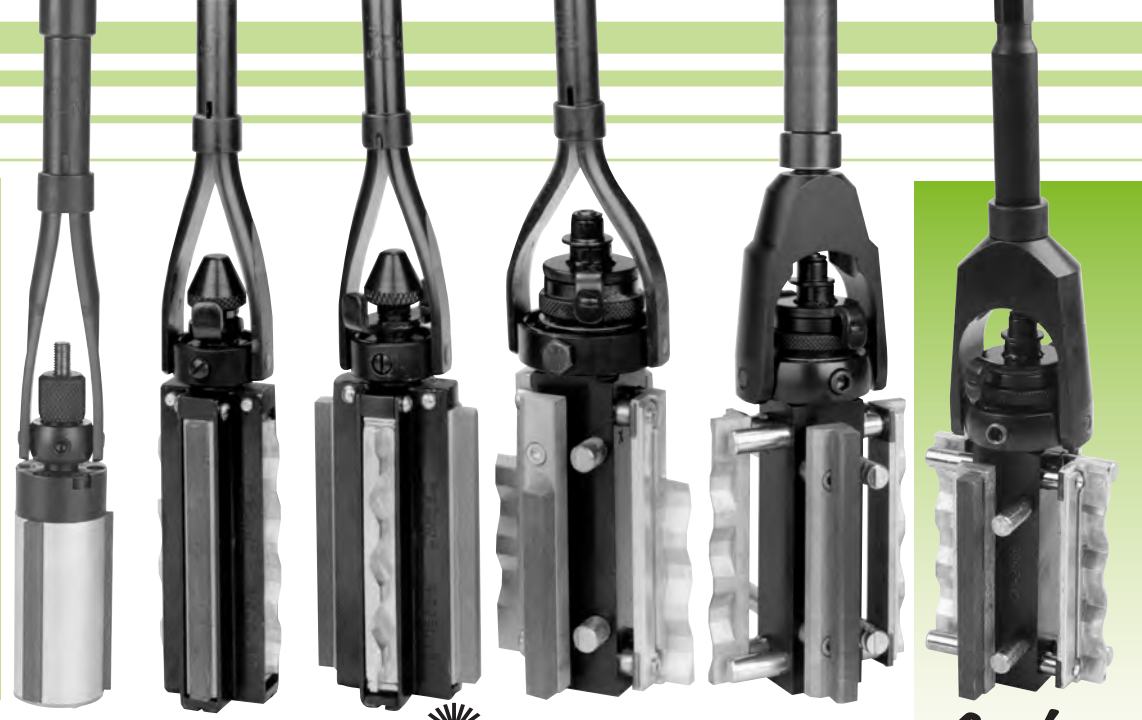

Portable Cylinder Hone Mandrels (stones sold separately)

Shaft extensions available.

	Junior Midget	Midget	Junior	Standard	Heavy-Duty	Heavy-Duty
Brand	Sunnen®	Sunnen®	Sunnen®	Sunnen®	Sunnen®	Goodson
Honing Range	1.25" - 1.75"	1.75" - 2.00"	2.00" - 2.60"	2.50" - 5.50"	2.50" - 5.50"	2.50" - 5.50"
Drive Shank	2.00" (incl.)	2.00" (incl.)	2.00" (incl.)	2.00" (incl.)	6.00" (incl.)	6.00" (incl.)
Drive Extension	12.00" (incl.)	12.00" (incl.)	12.00" (incl.)	12.00" (incl.)	12.00" (incl.)	12.00" (incl.)
Thread	3/8" - 14	3/8" - 14	3/8" - 14	3/8" - 14	3/8" - 11	3/8" - 11
Order No.	SNJ-10	SN-75	JN-95	AN-112	AN-815	GH-2555
Jobber	\$946.96	\$831.55	\$839.04	\$982.30	\$1056.48	\$629.99

NOTE: Goodson is authorized to ship Sunnen® products only within the Americas

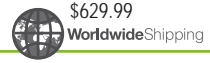

Cylinder Hone Center Adjustment Pinion



- Every Sunnen® AN-112, AN-815 and Goodson GH-2555 include the AN-16 Center Adjustment Pinion at purchase
- Use to adjust the stone honing diameter
- The Adjustment Pinion will wear over time so must be replaced
- Order No. **AN-16** Jobber \$251.57



Scan this code with the camera on your smart phone or other smart device for quick access to our Tech Lab Tuesday video showing how important the AN-16 is for cylinder honing success.

Honing Stones

• Ideal for Cast Iron



Grit	Range	mm	Finish	Supersedes	Jobber	Order No.
For Sunnen® Junior Midget Hone (SNJ-10) 3 Stones & No Wipers						
150 Grit	1.25" - 1.44"	31.8-36.6	45 Ra	---	\$40.44	SNJ1-J45
	1.42" - 1.60"	36.1-40.6	45 Ra	---	40.44	SNJ2-J45
	1.58" - 1.77"	40.1-44.9	45 Ra	---	40.44	SNJ3-J45
400 Grit	1.25" - 1.44"	31.8-36.6	8 Ra	---	40.44	SNJ1-J87
	1.42" - 1.60"	36.1-40.6	8 Ra	---	40.44	SNJ2-J87
	1.58" - 1.77"	40.1-44.9	8 Ra	---	40.44	SNJ3-J87
For Sunnen® Midget Hone (SN-75) 2 Stones & 2 Wipers						
70 Grit	1.75" - 2.00"	50.8-55.9	120 Ra	SN-100	\$35.35	S18-J17
150 Grit	1.75" - 2.00"	44.5-50.8	45 Ra	SN-200	35.35	S18-J45
220 Grit	1.75" - 2.00"	44.5-50.8	32 Ra	SN-300	35.35	S18-J55
280 Grit	1.75" - 2.00"	44.5-50.8	20 Ra	SN-500	35.35	S18-J65
400 Grit	1.75" - 2.00"	44.5-50.8	8 Ra	---	35.35	S18-J87
For Sunnen® Junior Hone (JN-95) 2 Stones & 2 Wipers						
70 Grit	2.00" - 2.20"	50.8-55.9	120 Ra	JN-100	\$35.35	T20-J17
	2.20" - 2.40"	55.9-60.9	120 Ra	JN-101	35.35	U22-J17
	2.40" - 2.60"	60.9-66.0	120 Ra	JN-102	35.56	V24-J17
150 Grit	2.00" - 2.20"	50.8-55.9	45 Ra	JN-200	35.35	T20-J45
	2.20" - 2.40"	55.9-60.9	45 Ra	JN-201	36.79	U22-J45
	2.40" - 2.60"	60.9-66.0	45 Ra	JN-202	35.56	V24-J45
220 Grit	2.00" - 2.20"	50.8-55.9	32 Ra	JN-300	35.35	T20-J55
	2.20" - 2.40"	55.9-60.9	32 Ra	JN-301	36.79	U22-J55
	2.40" - 2.60"	60.9-66.0	20 Ra	JN-501	40.46	U22-J65
280 Grit	2.00" - 2.20"	50.8-55.9	20 Ra	JN-500	35.35	T20-J65
	2.20" - 2.40"	55.9-60.9	20 Ra	JN-501	40.46	U22-J65
	2.40" - 2.60"	60.9-66.0	20 Ra	JN-502	35.56	V24-J65
400 Grit	2.00" - 2.20"	50.8-55.9	8 Ra	---	35.35	T20-J87
	2.20" - 2.40"	55.9-60.9	8 Ra	---	41.69	U22-J87
	2.40" - 2.60"	60.9-66.0	8 Ra	---	35.56	V24-J87



Goodson and Sunnen® Cylinder Honing Stones For all popular AN-style Honers and Hone Bodies

- Integral holder type Honing stone sets have 4 pieces: 2 holders with stones and 2 holders with aluminum wipers
- Fit Sunnen® AN Standard, AN Heavy-Duty and Goodson **GH-2555** hones
- Use with honing oil
- Stones for Short or Blind Holes are 2¹³/₁₆" long; all other stones are 4" long
- **Mix or Match 5 HN stones, Save 10% off jobber**

Grit	Bore Range		Usage	Finish	SUNNEN®			GOODSON			
	in	mm			Jobber	Old Order No.	New Order No.	Jobber 1+	Jobber 5+	Order No.	
70 Grit Roughing	2.5"-2.7"	63.5-68.6	Cast Iron	120 Ra	\$36.11	AN-115	G25-J17	\$34.99	\$31.49	HN-115S	
	2.7"-4.1"	68.6-104.1	Cast Iron	120 Ra	36.11	AN-100	M27-J17	34.99	31.49	HN-100S	
			Cast Iron	120 Ra	—	—	—	34.99	31.49	HN-100R¹	
	3.5"-5.5"	88.9-139.7	Short/Blind	120 Ra	41.45	AN-100-71	M27-J17-71	34.99	31.49	HN-102S	
			Harley / VW	120 Ra	92.84	AN-100F	AN-100F	34.99	31.49	HN-100F	
			Cast Iron	120 Ra	36.11	AN-101	N37-J17	34.99	31.49	HN-101S	
			Cast Iron	120 Ra	—	—	—	34.99	31.49	HN-101R¹	
	Use Master Holder & Sleeve Support	4.7"-15.0"	119.4-381	Short/Blind	120 Ra	41.45	AN-101-71	N37-J17-71	34.99	31.49	HN-104S
				Hard Sleeves	55 Ra	36.11	AN-131	N37-J11	34.99	31.49	HN-131S
				Cast Iron	120 Ra	36.11	AN-106	W47-J17	34.99	31.49	HN-106S
150 Grit Medium	2.5"-2.7"	63.5-68.6	Cast Iron	45 Ra	36.11	AN-215	G25-J45	34.99	31.49	HN-215S	
	2.7"-4.1"	68.6-104.1	Cast Iron	45 Ra	36.11	AN-200	M27-J45	34.99	31.49	HN-200S	
Use Master Holder & Sleeve Support	3.5"-5.5"	88.9-139.7	Short/Blind	45 Ra	41.45	AN-200-71	M27-J45-71	34.99	31.49	HN-202S	
			Hard Sleeves	30 Ra	—	—	—	34.99	31.49	HN-230S	
			Cast Iron	45 Ra	36.11	AN-201	N37-J45	34.99	31.49	HN-201S	
	4.7"-15.0"	119.4-381.0	Short/Blind	45 Ra	41.45	AN-201-71	N37-J45-71	34.99	31.49	HN-204S	
			Hard Sleeves	30 Ra	36.11	AN-231	N37-J43	34.99	31.49	HN-231S	
			Cast Iron	45 Ra	36.11	AN-206	W47-J45	34.99	31.49	HN-206S	
			Hard Sleeves	30 Ra	36.11	AN-236	W47-J43	34.99	31.49	HN-236S	
220 Grit Finishing	2.7"-4.1"	68.6-104.1	Cast Iron	32 Ra	36.11	AN-300	M27-J55	34.99	31.49	HN-300S	
	3.5"-5.5"	88.9-139.7	Short/Blind	32 Ra	41.45	AN-300-71	M27-J55-71	34.99	31.49	HN-302S	
			Cast Iron	32 Ra	36.11	AN-301	N37-J55	34.99	31.49	HN-301S	
Use Master Holder & Sleeve Support	4.7"-15.0"	119.4-381	Short/Blind	32 Ra	41.45	AN-301-71	N37-J55-71	34.99	31.49	HN-304S	
			Cast Iron	32 Ra	36.11	AN-306	W47-J55	34.99	31.49	HN-306S	
280 Grit Fine Finish	2.5"-2.7"	63.5-68.6	Cast Iron	20 Ra	36.11	AN-515	G25-J65	34.99	31.49	HN-515S	
	2.7"-4.1"	68.6-104.1	Cast Iron	20 Ra	36.11	AN-500	M27-J65	34.99	31.49	HN-500S	
			Short/Blind	20 Ra	41.45	AN-500-71	M27-J65-71	34.99	31.49	HN-502S	
			Hard Sleeves	12 Ra	36.11	AN-530	M27-J63	34.99	31.49	HN-530S	
	3.5"-5.5"	88.9-139.7	Cast Iron	20 Ra	36.11	AN-501	N37-J65	34.99	31.49	HN-501S	
			Short/Blind	20 Ra	41.45	AN-501-71	N37-J65-71	34.99	31.49	HN-504S	
Use Master Holder & Sleeve Support	4.7"-15.0"	119.4-381.0	Hard Sleeves	12 Ra	—	—	—	34.99	31.49	HN-531S	
			Cast Iron	20 Ra	36.11	AN-536	W47-J63	34.99	31.49	HN-536S	
400 Grit Extra Fine Finish	2.5"-2.7"	63.5-68.6	Cast Iron	8 Ra	36.11	—	G25-J87	34.99	31.49	HN-615S	
	2.7"-4.1"	68.6-104.1	Cast Iron	8 Ra	36.11	—	M27-J87	34.99	31.49	HN-600S	
			Hard Sleeves	5 Ra	36.11	—	M27-J85	34.99	31.49	HN-630S	
	3.5"-5.5"	88.9-139.7	Cast Iron	8 Ra	36.11	—	N37-J87	34.99	31.49	HN-601S	
			Hard Sleeves	5 Ra	36.11	—	N37-J85	34.99	31.49	HN-631S	
Cork Polishing	2.5"-3.3"	63.5-83.8	Cast Iron*	2-3 Ra	59.49	—	G25-C05				
	3.3"-4.2"	83.8-106.7	Cast Iron*	2-3 Ra	89.66	—	MM33-C05				
	4.0"-5.6"	101.6-142.2	Cast Iron*	2-3 Ra	89.66	—	NN40-C05				

(*Cast Iron – 3 Ra., Hard Sleeves – 2 Ra, Steel– 3 Ra)

¹Ruby Aluminum-Oxide abrasive for longer life in rough cutting use

SUNNEN® Master Holder & Stone Supports

- Holds one 4" stone set
- Stones sold separately
- AN-365 requires use of AN-260
- Larger sizes available upon special order

Master Holder		
Dia. Range	Jobber	Order No.
4.7"-7.0"	\$233.20	AN-355
6.0"-9.0"	233.20	AN-365
Stone Supports for AN-365		
6.0"-9.0"	\$166.31	AN-260

Note: Larger sizes available by special order.

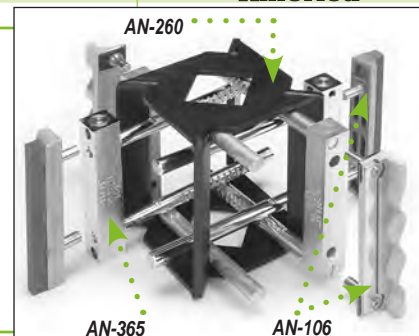

CYLINDER HEAD
REBUILDING
CLEANING,
ASSEMBLY & SAFETY
SHORT BLOCK
REBUILDING
GRANKSHAFT/
FLYWHEEL GRINDING
MISCELLANEOUS
TOOLS & SUPPLIES
BRAKE SERVICE
TOOLING
MEASURING
TOOLS
V-TWIN & METRIC
HARD PARTS

... another satisfied customer

"The thing I like about Goodson is you always have the correct, up-to-date tools."
 — ALC Machine, Santa Rosa, CA, Goodson customer since 1990

CYLINDER HEAD REBUILDING

CLEANING, ASSEMBLY & SAFETY

SHORT BLOCK REBUILDING

CRANKSHAFT/ FLYWHEEL GRINDING

MISCELLANEOUS TOOLS & SUPPLIES

BRAKE SERVICE TOOLING

MEASURING TOOLS

V-TWIN & METRIC HARD PARTS

Keyway Honing Stone Sets

- Two-stroke engines have intake and exhaust ports that interrupt the operation of your honing stone
- These stones allow the hone to pass the intake and exhaust ports while maintaining consistent pressure to remove material accurately and easily
- Use with any AN- or GH-series hone (p. 86)
- For Cast Iron



Grit	Range	mm	Finish	Type	Jobber	Order No.
150 Grit	2.5" - 3.3"	63.5 - 83.8	45 Ra	Alum.	\$68.35	GY25-J45
Medium	3.3" - 4.2"	83.8 - 106.7	45 Ra	Alum.	68.35	MY33-J45
280 Grit	2.5" - 3.3"	63.5 - 83.8	20 Ra	Brass	68.35	GY25-J65
Fine Finish	3.3" - 4.2"	83.8 - 106.7	20 Ra	Soft	68.35	MY33-J65
400 Grit	2.5" - 3.3"	63.5 - 83.8	8 Ra	Brass	68.35	GY25-J85
Extra Fine	3.3" - 4.2"	83.8 - 106.7	8 Ra	Soft	68.35	MY33-J85

EHU
type stones

GEHN type stones



Stones & Shoes for Sunnen Hone Machines

- Premium-quality replacements for all CV-616, and CK-10 hones equipped with Sunnen® Master Holder Sets
- Diameter Range: 4.125" - 5.000" (104.8 - 127.0mm)
- Use with Master Holder Set CK-3045A (sold separately)
- 2 stones per set

Stones			Goodson - 1 Pair		Sunnen - 6 Pair	
Use	Grit	Finish	Jobber	Order No.	Jobber	Order No.
Hard Blocks	70	60 Ra	\$18.49	GEHN-116	\$133.96	EHN-116
Hard Blocks	220	22-32 Ra	18.49	GEHN-512	133.96	EHN-512
Air Cooled Cyl.	220	22-32 Ra	18.49	GEHN-518	133.96	EHN-518
Hard Blocks	70	60 Ra	18.49	GEHU-123	133.96	EHU-123
Roughing	70	60 Ra	18.49	GEHU-133	133.96	EHU-133
Hard Blocks	220	22-32 Ra	18.49	GEHU-518	133.96	EHU-518
Gen. Purp.	220	22-32 Ra	18.49	GEHU-525	133.96	EHU-525
Aluminum	220	30-36 Ra	18.49	GJHU-525	133.96	JHU-525
High Nickel	280	20-25 Ra	18.49	GJHU-623	133.96	JHU-623
Finishing	280	16-23 Ra	18.49	GJHU-625	133.96	JHU-625
High Nickel	400	7-14 Ra	18.49	GJHU-818	133.96	JHU-818
Aluminum	400	7-14 Ra	18.49	GJHU-820	133.96	JHU-820
Accessories			Qty.	Jobber	Order No.	
Sunnen® Master Holder Set			1	\$361.83	CK-3045A	
Sunnen® Centering Guide (includes CK-3070)			1	182.66	CK-3090A	
Sunnen® Guide Shoe & 2 Screws			1	29.43	CK-3070	
Sunnen® Brass Guide Shoe & 2 Screws			1	92.69	CK-3120	
Goodson Wear Shoe			1	27.99	C-3070K	
Goodson Stabilizing Shoe			2	54.99	C-3120K	

For Rod Honing Stones and Shoes see page 91

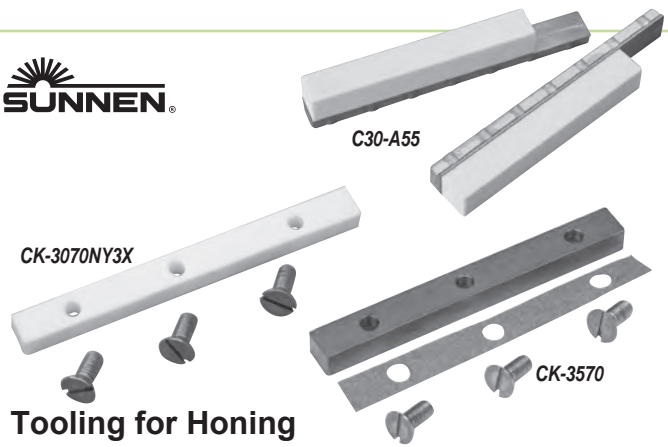

Tooling for Honing Dart Blocks & Ductile Sleeves

- Recommended for Dart™ Machinery
- Use with Sulfurated Rod Honing Oil (below)

Description	Jobber	Order No.
Honing Stone Sets For Portable Tooling		
80 Grit	\$36.11	N37-A25
220 Grit	36.11	N37-A55
280 Grit	36.11	N37-J65
400 Grit	54.21	MM33-J85
For CK/CV Type Machines		
80 Grit Stone Set (6)	\$133.96	C30-A25
150 Grit Stone Set (6)	133.96	C30-A45
220 Grit Stone Set (6)	133.96	C30-A55
280 Grit Stone Set (6)	133.96	C30-J65
400 Grit Stone Set (6)	133.96	C30-J85
Hardened Steel Guide Shoe (1)	242.54	CK-3570
Delron® Guide Shoe (1)	162.54	CK-3070NY3X
Goodson Brand Shoes For CK/CV Type Machines		
Hardened Steel Guide Shoe (1)	\$139.99	GCK-3570
Delron® Guide Shoe (1)	102.99	GCK-3070NY3X

tech tips For CK & CV Machines, **DO NOT** use Bronze Shoes, from the techxperts™ use Hardened Steel and Delron shoes above (1 of each)

Ultra-Finish Plateau Hones



- Abrasive impregnated nylon bristles
- Ideal for rebuilding high-performance engines and engines with low-tension rings • Superior plateau finish so rings will seal immediately
- Reduce break-in time
- Allow closer tolerances • 1 Pair

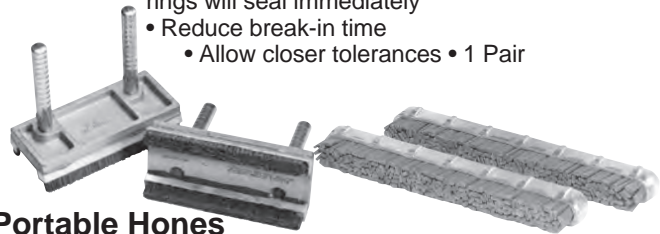

Portable Hones

- Fit AN- or GH- style hones
- Range: 3.78" to 4.68"
- Order No. **MM-PHT-731**
- Jobber \$442.53

CV/CK Hone Heads

- Range: 3.10" to 5.00"
- Order No. **C30-PHT-731**
- Jobber \$294.36

Sulfurated Honing Oil

- Includes additives for high pressure cutting

Size	Jobber	Order No.
1 gal./3.78L	\$ 54.99	RHO-10
5 gal./18.9L	269.99	RHO-50





82° 3" Dia. Chamfering Cones & Mandrel

- Chamfer sharp edges for safe piston and ring installation
- Handles all diameter cylinders or sleeves
- Fits 3/8" (9.53mm) or larger drill
- Kit (CC-100) includes mandrel and three 50 Grit Aluminum Oxide cones (CC-15)
- Due to manufacturing process, abrasive color may vary
- Aluminum-Oxide is a good general purpose abrasive suited for ferrous and non-ferrous metals
- Zirconium is a tough abrasive well suited for heavy stock removal on most metals



Description	Jobber	Order No.	Incl.
3" Top Dia. Chamfering Cone Kit	\$62.99	CC-100	▼
Replacement 3/8" Drill Adaptor	16.49	CC-100-1	x
Aluminum Oxide Chamfering Cones (red)	1+	5+	
40 Grit	\$10.99	\$ 9.89	CC-14
50 Grit	11.49	10.34	CC-15
80 Grit	10.99	9.89	CC-20
Premium Zirconia Chamfering Cones (blue)			
50 Grit	\$11.99	\$10.79	CCZ-15
80 Grit	11.99	10.79	CCZ-20

Mix & Match 5 Cones for Quantity Discount; Save 10% off Jobber



Honing Stone Sets For Nicasil

- For deglazing Nicasil with a CV/CK Honing Machine
- Diameter Range:
 - 3.0" - 5.0" (76.2-127.0mm) in standard automotive head
 - 2.6" - 3.5" (66.0-88.9mm) in junior head
- 150 grit aluminum oxide abrasive
- 6 pairs per package
- Order No. **EHU-412** Jobber \$133.96

Lisle® Honing Stone Sets

- Clip-on style mounts in seconds
- 5" / 127mm stones and wipers
- Each set contains two stones and two felt wipers
- Use dry

Replaces Lisle® No.	Grit	Order No.
15500	80	HL-80
15510	180	HL-180
15520	280	HL-280
15590	500	HL-500

Jobber per set \$20.49

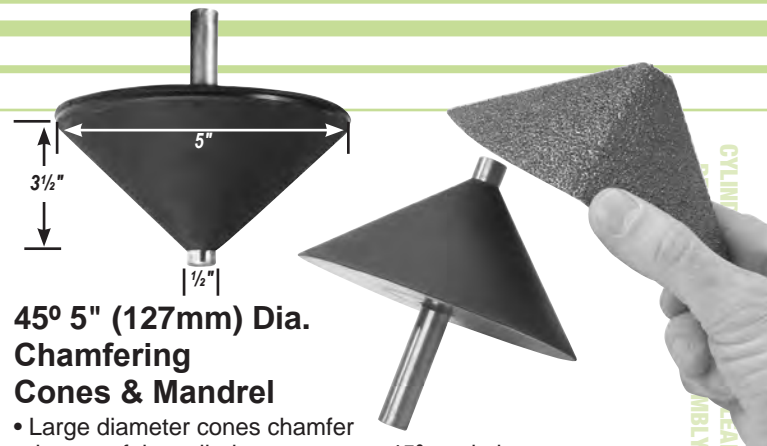
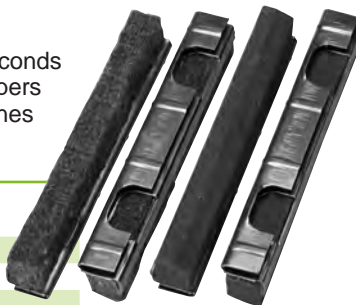

45° 5" (127mm) Dia. Chamfering Cones & Mandrel

- Large diameter cones chamfer the top of the cylinder to an exact 45° angle in one pass
- 1/2" (12.7mm) steel shank is permanently embedded in the cone base to ensure stability
- Cone height: 3/2" (88.9mm)
- Kit includes mandrel & one 36-grit cone (CC-30)
- Due to manufacturing processes, abrasive color may vary
- Aluminum-Oxide is a good general purpose abrasive suited for ferrous and non-ferrous metals
- Zirconium is a tough abrasive well suited for heavy stock removal on most metals



Description	Jobber	Order No.	Incl.
5" Chamfering Cone Kit	\$234.99	CC-130	▼
Chamfering Cones	Abrasive	Grit	1+ 5+
	Aluminum Oxide (red)	36	\$10.99 \$ 9.89
		50	10.99 9.89
		80	10.99 9.89
	Premium Zirconia (blue)	36	12.49 11.24
		50	12.49 11.24
		80	12.49 11.24

Mix & Match 5 Cones for Quantity Discount; Save 10% off Jobber



Honing Stones for Nicasil

- Deglaze Nicasil cylinders with portable hones
- Aluminum-Oxide abrasive
- Resizing cylinders requires diamond abrasive
- A43 = Aluminum-Oxide, J63 = Silicon-Carbide

Stones for SNJ-10 Portable Hones				Stones for AN & GH Style Hones			
Inch	Grit	Jobber	Order No.	Inch	Grit	Jobber	Order No.
1.42"-1.60"	150	\$40.44	SNJ2-A43	2.5"-3.3"	150	\$54.31	GG25-A43
	280	40.44	SNJ2-J63	3.3"-4.2"	150	54.31	MM33-A43
1.58"-1.77"	150	40.44	SNJ3-A43	4.0"-5.6"	150	54.31	NN40-A43
	280	40.44	SNJ3-J63				

Order 3 or more Flex-Hones® (mix & match) and save 10% off jobber



Use with RHO-10

Standard Duty 240 Grit Aluminum Oxide Flex-Hones® For Nicasil

Inch	mm	Jobber	Order No.	Inch	mm	Jobber	Order No.
2 1/4"	57.2	\$45.99	BA-225240	3 1/4"	82.5	\$70.99	BA-325240
2 3/8"	60.2	47.99	BA-237240	3 1/2"	88.9	77.99	BA-350240
2 1/2"	63.5	48.99	BA-250240	3 3/4"	95.3	80.99	BA-375240
2 5/8"	66.5	51.99	BA-262240	4 1/8"	104.8	85.99	BA-418240
2 3/4"	69.8	54.99	BA-275240	4 3/8"	117.5	97.99	BA-462240
3"	76.2	63.99	BA-300240				

More Flex-Hones® on page 83

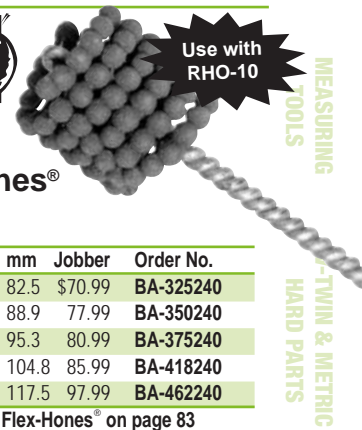

CYLINDER BEARING, ASSEMBLY & SAFETY
SHORT BLOCK REBUILDING
CRANKSHAFT/ FLYWHEEL GRINDING
MISCELLANEOUS TOOLS & SUPPLIES
BRAKE SERVICE TOOLING
MEASURING TOOLS
TWIN & METRIC HARD PARTS



"Our tech staff can help you solve problems fast. Call us with questions about product applications, machining processes, longer tool life, improving efficiency and any other technical topic. We're here to help."

- A.J., Goodson Tech Service - 1 year of service

CYLINDER HEAD
REBUILDING

CLEANING,
ASSEMBLY SAFETY

SHORT BLOCK
REBUILDING

CRANKSHAFT/
FLYWHEEL GRINDING

MISCELLANEOUS
TOOLS & SUPPLIES

BRAKE SERVICE
TOOLING

MEASURING
TOOLS

V-TWIN & METRIC
HARD PARTS



Stones & Replacement Parts For CR-Series Mandrels

- SunnEN honing stones are sold as pairs while Goodson honing stones are sold individually

Honing Stones for Manual Honing*

Fit Mandrels	Finish	Jobber	SunnEN Order No.	Goodson Jobber	Goodson Order No.
CR-1450 to 1750	Medium	\$36.00	CR-2	-----	-----
	Fine	36.00	CR-4	-----	-----
CR-1900 & Larger	Aluminum/ Titanium	36.00	CR-9	-----	-----
	Roughing	35.95	CR-10	\$16.99	HC-10
	Medium	36.00	CR-12	16.99	HC-12
	Fine	36.00	CR-14	16.99	HC-14
For Power Hone	Roughing	41.43	CR-10N	-----	-----
Guide Shoes (2 per box)					
CR-1450 to 1750	Die Cast	\$14.30	CR-40D	-----	-----
CR-1900 & larger	Die Cast	15.12	CR-50D	-----	-----
	Bronze	67.29	CR-50B	-----	-----

Wedge & Wedge Plates

CR-1450 to 1750	Wedge	\$118.16	CR-70	-----	-----
	Small Plate	51.02	CR-75	-----	-----
	Large Plate	51.02	CR-85	-----	-----
CR-1900 to 2500	Wedge	69.86	CR-100	-----	-----
CR-1900 & Larger	Small Plate	58.65	CR-110	-----	-----
	Large Plate	58.61	CR-120	-----	-----
CR-2900	Wedge	87.63	CR-200	-----	-----
SunnEN® Tension Block For CR-2900 & Larger				\$ 19.93	LN-1337A
SunnEN® Shoe Clamps (4 + screws) for CR-1900 & larger				128.28	CR-45A

*SunnEN® honing stones include 2/box, Goodson include 1/box

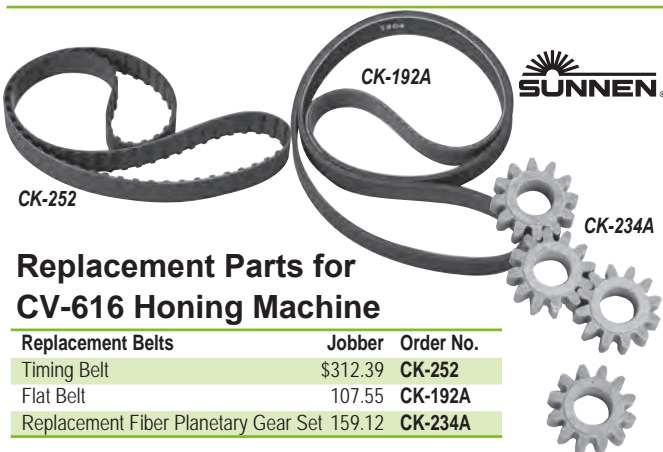

Replacement Parts for CV-616 Honing Machine

Replacement Belts	Jobber	Order No.
Timing Belt	\$312.39	CK-252
Flat Belt	107.55	CK-192A
Replacement Fiber Planetary Gear Set	159.12	CK-234A



Mandrel Driver for Portable Use of CR-, PL- and ML-Series Honers

- Ideal for spindle bushings mounted on axles and other jobs that can't be taken to the honing machine
- For holes 3/4"/19.05mm ID and larger, where length is at least 3 times the diameter
- ID Range: .744" - 3.875"/19mm - 98mm
- Graduated adjustment knob advances and retracts stones • 275 - 450 RPM range
- Use with any 1/2"/12.7mm drill or larger
- Order No. **GGN-150** Jobber \$1313.20



Rod Honing Oil

- Includes additives for high pressure cutting
- Keeps stones clean and free-cutting during rod reconditioning, pin fitting and other honing applications
- Will mix with other honing oils (including SunnEN®)

Size	Jobber	Order No.
1 gal./3.78L	\$ 54.99	RHO-10
5 gal./18.9L	269.99	RHO-50



Goodson Belts for SunnEN® Rod Honing Machines

- Top-quality belts for long life

tech tips

from the techexperts™
You must measure the belt you are replacing. Ordering is based on length, not machine model. If your belt size doesn't match one in the chart, order the next size down. For example, if your belt measures 72 1/2", order the 70" Oil Pump Belt. Belts stretch over time so the shorter belt will fit.



Size	Jobber	Order No.
Oil Pump Belts (.250" dia.)		
70"/1.78m	\$121.99	RHB-70
74"/1.88m	121.99	RHB-74
85"/2.16m	121.99	RHB-85
109"/2.77m	141.99	RHB-109
Flat Belts		
46 1/2" x 5/8"/1181.1x15.9mm	149.99	RHFB-46

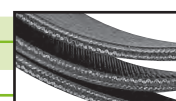
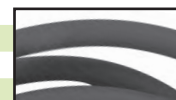

Rod Honing Stones & Mandrels



KL-Series Connecting Rod Lifetime Honing Unit Mandrel Adaptor

- Mandrel Adaptor comes with retainer
- Order No. **AK20-A** Jobber \$63.04



Rod Honing Stones, Guide Shoes & Replacement Parts

- Premium-quality • Choose Goodson or Sunnen®

SL
Stones



HP / PL
Stones

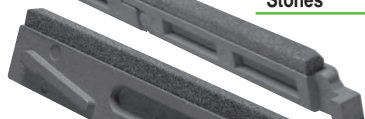

HM / ML
Stones



HK / KL
Stones

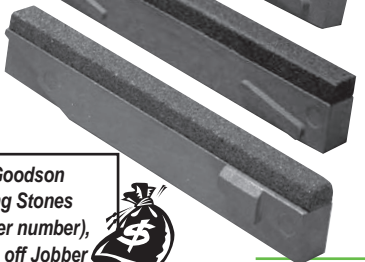

Order 12 Goodson
Rod Honing Stones
(same order number),
SAVE 10% off Jobber



Bronze
Guide
Shoes



Stones	Use	Goodson				Sunnen®		Old	
		Jobber	Jobber 12+	Order No.	Qty.	Jobber	Order No.	Order No.	Qty.
For Sunnen® SL720 - SL2300 Mandrel									
	Roughing					\$153.81	SL-5		6
	General Purpose				WorldwideShipping	153.81	SL-7		6
	Finishing					153.81	SL-13		6
For Sunnen® PL Series Mandrel 12+									
	Roughing	\$12.49	\$11.24	HP-5	1	\$128.83	P28-J27	PL-5	12
	General Purpose	12.49	11.24	HP-7	1	128.83	P28-J47	PL-7	12
	Finishing	12.49	11.24	HP-13	1	128.83	P28-J67	PL-13	12
For Sunnen® ML Series Mandrel									
	Roughing	\$10.49	\$9.44	HM-5	1	\$120.66	P20-J25	ML-5	12
	General Purpose	10.49	9.44	HM-7	1	120.66	P20-J47	ML-7	12
	Finishing	10.49	9.44	HM-13	1	120.66	P20-J67	ML-13	12
For Sunnen® KL Series Mandrel									
	Roughing	\$10.49	\$9.44	HK-5	1	\$120.66	K20-J25	KL-5	12
	General Purpose	10.49	9.44	HK-7	1	120.66	K20-J47	KL-7	12
	Finishing	10.49	9.44	HK-13	1	120.66	K20-J67	KL-13	12
	Steel	—	—	—	—	120.66	K20-A69	KL-14	12
Bronze Guide Shoes									
For Sunnen® KL and ML Series Mandrel									
	.775"-.805"	19.7-20.4mm	—	—	—	\$66.81	UA-B		2
	.838"-.899"	21.3-22.8mm	—	—	—	66.81	UB-B		2
	.900"-.993"	22.9-25.2mm	—	—	—	66.81	UC-B		2
	.994"-1.125"	25.2-28.6mm	—	—	—	66.81	UD-B		2
	1.119"-1.250"	28.4-31.8mm	—	—	—	66.81	UE-B		2
Note: Bronze guide shoes outlast die cast 6 to 1.									
Zinc Alloy Guide Shoes									
For Sunnen® PL and ML Series Mandrel									
	1.355" - 1.500"	34.4-38.1mm	—	—	—	\$31.64	WC-D		2
	1.480" - 1.625"	37.6- 41.3mm	—	—	—	31.64	WD-D		2
	1.730" - 2.000"	43.9- 50.8mm	—	—	—	31.64	WE-D		2

When cutting action of your honing stone slows down, a light stroke with the diamond dresser breaks the glaze and restores honing efficiency. Especially recommended for rod reconditioning. Consists of diamond stone on a sturdy metal holder with a chain for fastening it to the honing machine.



tech tips
from the techxperts™



Diamond Stone Dresser

- Diamond stone on durable metal tool
- Order No. **MAN-700**
- Jobber \$127.83

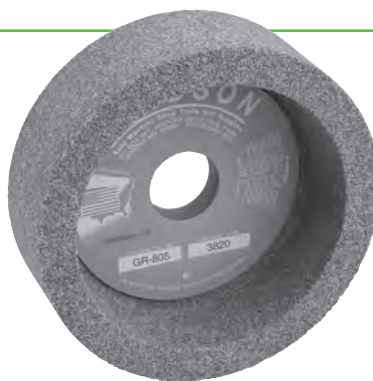

Rod & Cap Grinding Wheels

- Fits Sunnen® Rod and Cap Grinding Machines
- Recessed design
- Size: 6" x 2" x 1 1/4" (152.4 x 50.8 x 31.8mm)
- Order No. **GR-805** Jobber \$157.99



Rod & Cap Grinding Wheels

- For Sunnen® and other popular brand cap grinders
- Fits CRG 700, 750, 770, 780, 805 & 920K
- Softer than GR-805 • 6" x 2" x 1 1/4"
- Order No. **F343793** Jobber \$94.99



CYLINDER HEAD REBUILDING
CLEANING, ASSEMBLY & SAFETY
SHORT BLOCK REBUILDING
CRANKSHAFT/ FLYWHEEL GRINDING
MISCELLANEOUS TOOLS & SUPPLIES
BRAKE SERVICE TOOLING
MEASURING TOOLS
V-TWIN & METRIC HARD PARTS



"If you need engine building tools and supplies, you need Goodson! We're dedicated to providing you with the best quality products, the best value and the best service in the industry."

- Lea, Goodson Customer Service - 1 year of service

CYLINDER HEAD
REBUILDING

CLEANING,
ASSEMBLY & SAFETY

SHORT BLOCK
REBUILDING

CRANKSHAFT/
FLYWHEEL GRINDING

MISCELLANEOUS
TOOLS & SUPPLIES

BRAKE SERVICE
TOOLING

MEASURING
TOOLS

V-TWIN & METRIC
HARD PARTS

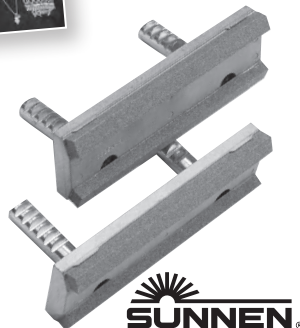

Hone High-Silicon Aluminum Alloy Blocks With Ease – Honing Stones & Silicon Compound

- Stones fit both the Sunnen® AN-112 and AN-815 and the Goodson GH-2555 Portable Honing Mandrels
- Use each stone set progressively until the final bore size is achieved • For Hone Diameter: 3.3" to 4.2"
- To create the final condition, coat the felt set and the honed cylinder surface with the Silicon Compound (AN-30) and lap the cylinders
- After completion, the cylinder will have a dull matte finish
- Piston and rings will ride on silicon instead of aluminum
- Silicon Compound 1 lb. / 450g

Description	Jobber	Order No.
Roughing (280 grit)	\$54.21	MM33-J63
Finishing (400 grit)	54.21	MM33-J85
Polishing (600 grit)	89.66	MM33-CO5
Felt Set	92.60	MM33-FO5
Silicon Compound	85.08	AN-30



Mandrel Driver for Line Honing Machines

- For Sunnen® CH-100 & similar line honing machines
- Graduated adjustment knob advances and retracts honing stones
- Quick release lever allows hone removal and installation without resetting
- Stone pressure adjusts with dial
- Automatically advances stones during honing
- **NOT** for portable honing applications
- Order No. **CH-75A** Jobber \$1412.48



Mineral Based Honing Oil

- Formulated for general purpose automotive machine shop honing
- Compatible with most popular honing machines
- 5 gallons (18.L)
- Order No. **MAN-845** Jobber \$208.01

tech tips

Right Hand Rotation Only.

For best results, keep your RPM about the same as your hone RPM, use the same rate of speed from the techxperts™ and number of strokes per minute.

Ultra-Finish Plateau Soft Hones

- Remove microscopic peaks and scuffs without enlarging bores
- Use with a portable drill
- Abrasive impregnated nylon bristles
- Ideal for high-performance engine rebuilding and for engines that use low-tension rings
- Use **after** honing
- Gives a superior plateau finish so rings seal immediately, reducing break-in time
- Allows closer tolerances for improved compression, better oil control, lower emissions
- For best results, use liberal amounts of honing oil (**HO-50**, pg. 85) • **NOT** interchangeable with Flex-Hones®

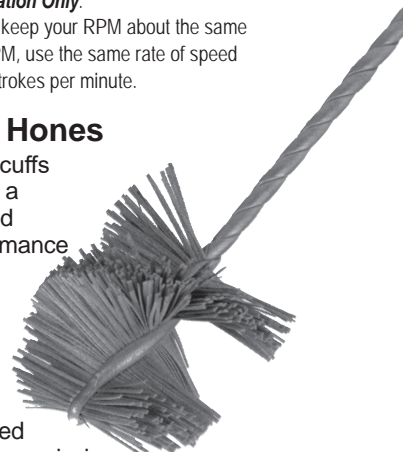

Hole Diameter Range	Hone	Head	Overall		
in	mm	Dia.	Length	Length	Jobber Order No.
.875"-1.00"	22-25	1.250"	2.00"	10.00"	\$51.99 UF-100
1.00"-1.25"	25-32	1.500"	2.00"	10.00"	55.99 UF-125
1.25"-1.75"	32-45	2.000"	2.00"	10.00"	55.99 UF-175
1.75"-2.25"	45-57	2.500"	2.00"	10.00"	62.99 UF-200
2.25"-2.75"	57-70	3.000"	3.00"	10.00"	62.99 UF-250
2.50"-3.00"	63-76	3.500"	4.00"	14.00"	62.99 UF-300
3.00"-3.50"	76-89	4.000"	4.00"	14.00"	74.99 UF-350
3.50"-4.00"	89-102	4.500"	4.00"	14.00"	74.99 UF-400
4.00"-4.50"	102-114	5.000"	5.00"	14.00"	74.99 UF-450
4.50"-5.00"	114-127	5.500"	5.00"	14.00"	76.99 UF-500

Valve Guide Plateau Hones on page 36



Line Hone Stones & Shoes

- For the Sunnen® CH-100, CHV-31, CH-20 & CH-40 Line Honing Machines
- Stones for Aluminum blocks (RY24-J45) are softer than those for cast iron (RY24-J49)

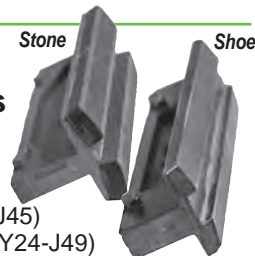

Description	Jobber	Order No.
Replacement Stones — 5 per box (Requires 10 stones)		
Recommended Application	Cast Iron	\$139.20 RY24-J49
	Aluminum	139.20 RY24-J45
Replacement Shoes — 10 per box (Requires 20 shoes)		
Fit 10RY-2400G & 10RY2700G	\$157.26	RG-D
Fit 10RY-3000H	167.94	RH-D

Goodson is
Authorized to Ship
Sunnen Automotive
Products into Canada

Rod & Piston Work

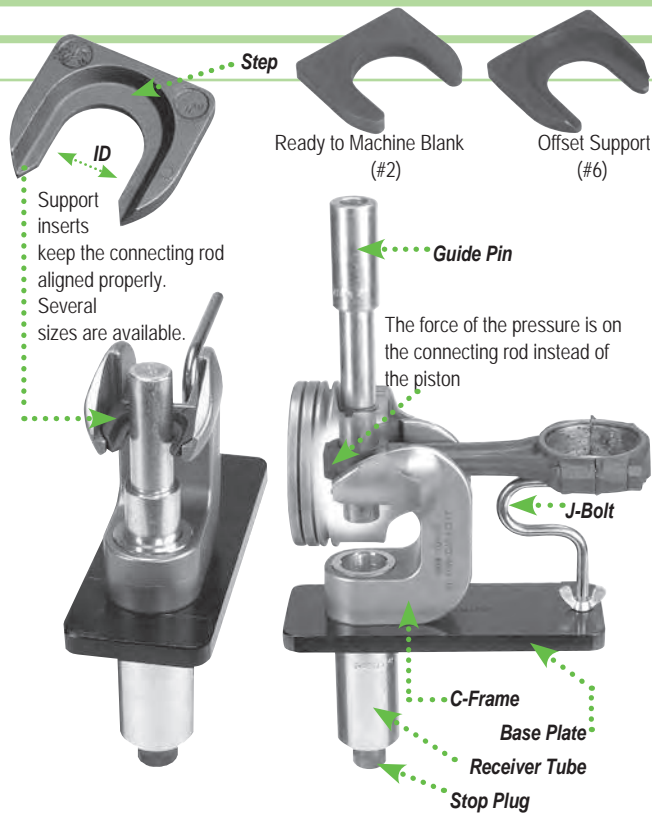

Piston Pin Removal Fixture

- Use to remove or install interference fit piston pins
- Force of removal is against the piston pin and connecting rod – no pressure is exerted on the piston itself
- Tool to fit most popular engines with pin diameters of 0.859" through 1.087"
- Replacement Support Inserts & Guide Pins sold separately



For Small Block Chevy use Support Insert #1 or Offset #6, for Big Block Chevy, use Support Insert #5, Support #2 is a .275" thick blank, ready to be machined to your exact specifications.

Description	ID	Step	Jobber	Order No.	Incl.
Complete Kit			\$1129.99	PPE-7082	▼
Replacement C-Frame			434.99	PPE-302186	x
Replacement Support Inserts	#1	0.945" .100"	49.99	PPE-39889	x
	#2	1.110" —	49.99	PPE-39890	x
	#3	1.000" .182"	49.99	PPE-39888	x
	#4	1.110" .182"	49.99	PPE-39886	x
	#5	1.000" .100"	49.99	PPE-39887	x
	#6	0.945" .100"	49.99	PPE-39822	x
Replacement Guide Pins	0.859"		39.99	PPE-17940	x
	0.897"		48.99	PPE-17936	x
	0.926"		39.99	PPE-17937	x
	0.970"		39.99	PPE-17938	x
	0.992"		39.99	PPE-17939	x
	1.032"		39.99	PPE-17941	x
	1.055"		39.99	PPE-17942	x
	1.087"		39.99	PPE-18729	x
Replacement Parts					
J" Bolt (Rear Support)			\$ 30.99	PPE-302224	x
Wing Nut			2.29	PPE-10588	x
1 1/2" / 30.2mm Stop Plug			49.99	PPE-17830D	x
Base Plate			119.99	PPE-17929	x
Receiving Tube			59.99	PPE-17931B	x
Body Guide			61.99	PPE-17932B	x
5/2" / 139.7mm Spring			11.99	PPE-17934	x
Guide Pin Driver			29.99	PPE-17935	x
1 1/2" / 41.3mm External Spiral Lock			13.49	PPE-17945	x

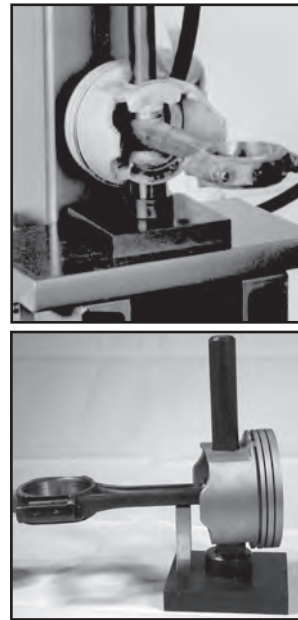

Universal Piston Pin Press-Out Tool

- Use with a shop press
- Top quality steel tooling
- Standard set handles most applications
- You can modify for individual needs

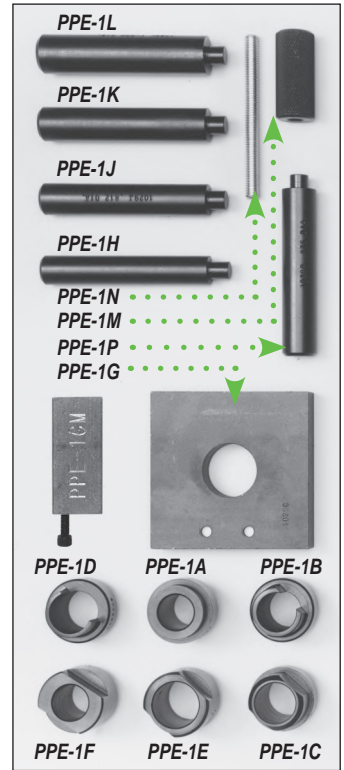

Description	Jobber	Order No.	Incl.
Piston Pin Extractor Kit	\$379.99	PPE-1	▼
Piston Support Fixtures			
.800" hole	33.99	PPE-1A	x
.865" hole	33.99	PPE-1F	x
.950" hole	33.99	PPE-1B	x
1.010" hole	33.99	PPE-1C	x
1.010" hole	33.99	PPE-1D	x
1.110" hole	33.99	PPE-1E	x
Fixture Base Block (4" x 4" x 3/4")	\$49.99	PPE-1G	x
Pin Pressing Drifts			
.760" dia.	21.99	PPE-1H	x
.812" dia.	21.99	PPE-1J	x
.875" dia.	21.99	PPE-1K	x
1.000" dia.	21.99	PPE-1L	x
Tapped Handle	21.99	PPE-1M	x
Threaded Rod	10.99	PPE-1N	x
Threaded Adaptor	18.49	PPE-1P	x
Rod Support	21.99	PPE-1GM	x

Kit includes the rod support for tapered boss pistons

GOODSON Rod Support for Sunnen® Pin Press Tooling

- Remove late model connecting rods from tapered boss pistons
- Aluminum construction prevents connecting rod damage • Fits B-162 Pin Press Reducing Ring

Description	Jobber	Order No.
Rod Support	\$62.99	BRS-130
Pin Press Reducing Ring	99.99	B-162

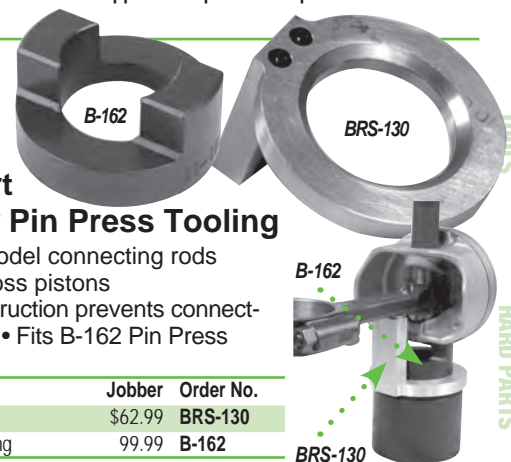

CYLINDER HEAD REBUILDING
CLEANING, ASSEMBLY & SAFETY
SHORT BLOCK REBUILDING
CRANKSHAFT/ FLYWHEEL GRINDING
MISCELLANEOUS TOOLS & SUPPLIES
BRAKE SERVICE TOOLING
MEASURING TOOLS
V-TWIN & METRIC HARD PARTS

... another satisfied customer

"Quality tools, fast turn around time and friendly, helpful people."

- Norman, NC Machine, Rutledge, Mo, Goodson customer since 2017

CYLINDER HEAD REBUILDING

CLEANING, ASSEMBLY & SAFETY

SHORT BLOCK REBUILDING

CRANKSHAFT/ FLYWHEEL GRINDING

MISCELLANEOUS TOOLS & SUPPLIES

BRAKE SERVICE TOOLING

MEASURING TOOLS

V-TWIN & METRIC HARD PARTS

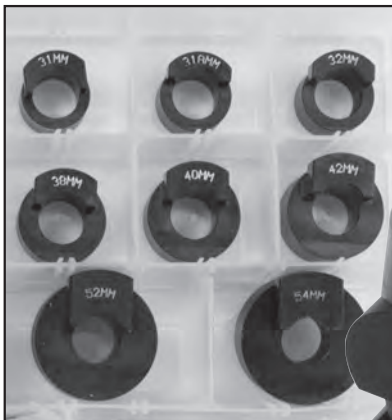

tech tips
from the techxperts™

Standard Wrist Pin Bushing Driver sizes range from 25mm to 54mm. If we don't have the size you're looking for in the chart below, choose the next size up and turn it down on your lathe to the exact size you require.



Universal Tapered Pin Bushing Press Kit For Light & Medium Duty Diesel Engines

sized for **diesel**

This press kit is specially designed to remove and replace tapered bushings in most common light to medium duty diesel applications. Don't spend time making a fixture that's dedicated to a single size. Our Tapered Pin Bushing Press Kit is ready to go when you receive it.

Description	Jobber	Order No.	Includes
Complete Wrist Pin Bushing Press Kit	\$1599.99	TB-KIT	▼
Wrist Pin Press Base (select drivers below)	927.99	TB-BASE	▼ x
Press Tube - Small (27x21x120mm)	47.99	TPT-SM	x
Press Tube - Large (30x31x110mm)	47.99	TPT-LG	x
Wrist Pin Ring (50x5x20/26mm)	19.99	WPR-001	x
Wrist Pin Parallels (2) 8x10x50mm	29.99	WPP-2	x
Extended Mandrel (8 1/2" long)	99.99	TB-MANDREL	x

Wrist Pin Bushing Drivers sold by dimension, not application

MM	Nominal	Actual	Step	Jobber	Order No.	Includes
25	1.000"	0.957"	0.063"	\$64.99	TBD-25	x
26	1.063"	0.990"	0.058"	64.99	TBD-26	x
27	1.060"	1.032"	0.067"	64.99	TBD-27	x
28	1.100"	1.006"	0.055"	64.99	TBD-28	x
30	1.180"	1.102"	0.075"	64.99	TBD-30	x
31	1.220"	1.158"	0.090"	64.99	TBD-31	x
31	1.220"	1.198"	0.067"	64.99	TBD-31A	x
32	1.260"	1.222"	0.078"	64.99	TBD-32	x
33	1.300"	1.268"	0.068"	64.99	TBD-33	x
34	1.340"	1.304"	0.073"	64.99	TBD-34	x
36	1.420"	1.377"	0.075"	64.99	TBD-36	x
38	1.500"	1.458"	0.076"	64.99	TBD-38	x
40	1.570"	1.554"	0.068"	64.99	TBD-40	x
42	1.650"	1.614"	0.097"	64.99	TBD-42	x
45	1.770"	1.742"	0.089"	64.99	TBD-45	x
46	1.810"	1.772"	0.108"	64.99	TBD-46	x
50	1.970"	1.940"	0.083"	64.99	TBD-50	x
52	2.050"	2.012"	0.114"	64.99	TBD-52	x
54	2.130"	2.099"	0.081"	64.99	TBD-54	x
Goodson Press Fit Lube (6 oz. Aerosol can)				19.99	PFL-200*	x
Deburring Tool				27.99	DT-6	x

*Hazardous Goods Fees Apply When Shipped Air

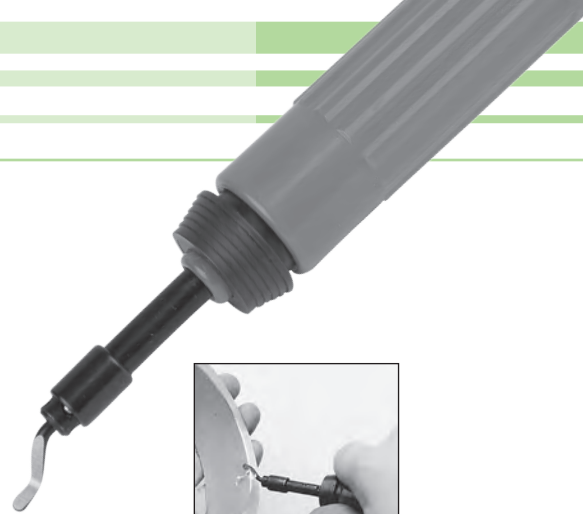

Deburring Tool

- Swivel tool chamfers sharp, machined edges, bolt holes, and much more
- DT-6 includes cutters for aluminum and cast iron

Description	Jobber	Order No.
Deburring Tool	\$27.99	DT-6
Replacement Cutters		
Steel/Aluminum	\$6.99	DT-10
Cast Iron/Brass	6.99	DT-20

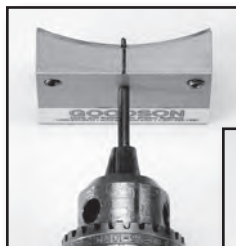

Gas Porting Tools for High Performance

- Virtually eliminate side ring clearance by drilling gas ports in your piston ring lands
- These tiny ports apply compression pressure directly to the back of the ring, pushing it against the cylinder wall with greater force while minimizing compression leakage
- Gas ports work best with piston-compression heights of 1.2" or less on engines running at high rpm (7,000 or higher)
- This simple tool kit take the guess-work out of gas porting and include everything you'll need to get started
- The complete kit includes: Drill Fixture, Depth Bushing and one Drill Bit

US Patent No. US D617,664 S

Description	Jobber	Order No.
Gas Porting Tool Kits	\$119.99	GPT-043
.040" Drill Bits (5 Pack)	9.99	GPT-040-DB
Gas Porting Tool Kits	119.99	GPT-062
.0625" Drill Bits (5 Pack)	9.99	GPT-062-DB



Rod & Piston Work



Toggle switches with flip-up covers to prevent accidental activation. LED lamps indicate when power is active.



Heating elements operate on separate thermostats.

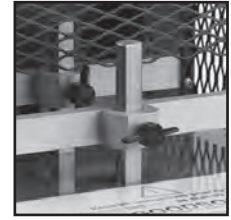

Adjustable rod supports accommodate most automotive connecting rods.

Temperature Indicating Crayon

- Mark the workpiece before heating
- Melts when temperature is reached

Melting Point	Jobber	Order
450°F / 232.22°C	\$24.99	TIC-450
500°F / 260.00°C	24.99	TIC-500
600°F / 315.56°C	24.99	TIC-600

Gauntlet Style Heat & Flame Resistant Gloves

- Heavy lined red terry-cloth • 13½" Long
- Safe to 450°F / 232.2°C
- Order No. **HR-300**
- Jobber \$49.99

220V, Single-Phase Electric Rod Heater

- Includes a digital timer and 450° temperature crayon
- Double wall insulated heat chamber with safety screen
- Vented top for better performance
- Powder-coated heavy-gauge steel housing for long life

Description	Jobber	Order No.	Incl.
220V, 50/60 Hz Single Phase Electric Rod Heater	\$1379.99	ERH-2220	▼
Digital Read-Out Timer (battery included)	17.99	ERH-TIMER	x
Replacement Toggle Switch (ea.)	21.99	ERH-SWITCH	
Replacement Toggle Switch Guard (ea.)	54.99	ERH-TSG	
Replacement Thermostat (ea.)	129.99	ERH-THERM	
Replacement Heater Coil (ea.)	119.99	ERH-COIL	
Replacement LED Light Assembly (ea.)	54.99	ERH-LED	
Replacement Bezel Knob (ea.)	27.99	ERH-KNOB	
Replacement Thumbscrew (ea.)	9.99	ERH-TST	
450° Melting Point Temperature Indicator Crayon	24.99	TIC-450	x
Piston Pin Installation Fixture	119.99	PIF-25	



Assemble 8 rods & pistons in as little as 5 minutes

Propane Fired Rod Heater

- Needs no warm-up time – start assembling rods and pistons almost immediately
- Heats piston pin ends so fast the rest of the rod stays cool
- Minimal cool down time after assembly
- Ceramic lined enclosure contains flame to keep hands safe
- One knob controls the pilot and gas flow, another sets air flow for ideal combustion
- Burner lights easily with a striker (not included)
- No heat coils to burn out or circuitry to fail
- Includes one 600°F Temperature Crayon (above)
- Propane model includes gas regulator and hose assembly
- Made to order - contact Goodson for current pricing and delivery time**

Description	Order No.
Rod Heater for Propane	RH-50
Rod Heater for Natural Gas	RH-50N

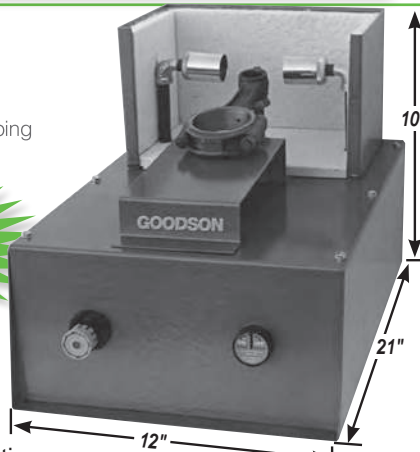

Band Ring Compressor Kits

- Install rings safely and easily • Hardened steel for durability
- Trigger ratchet mechanism for tight compressions

Description	Jobber	Order No.	Incl.
6 Pc. Band Ring Compressor Kit	\$102.99	GPS-98	▼
9 Pc. Band Ring Compressor Kit	139.99	GPS-99	▼
Compressing Pliers	38.99	GPS-98A	x x
Bands Range in. mm			
1.875" - 2.125"	47.63-53.98	\$17.49	GPS-98Q
2.125" - 2.375"	53.98-60.33	19.49	GPS-98R
2.375" - 2.625"	60.33-66.68	17.49	GPS-98S
2.625" - 2.875"	66.68-73.03	17.49	GPS-98T
2.875" - 3.125"	73.03-79.38	17.49	GPS-98B
3.125" - 3.375"	79.38-85.73	17.49	GPS-98C
3.375" - 3.625"	85.73-92.08	17.49	GPS-98D
3.625" - 3.875"	92.08-98.43	17.49	GPS-98E
3.875" - 4.125"	98.43-104.78	17.49	GPS-98F
4.125" - 4.375"	104.78-111.13	17.49	GPS-98G
4.500" - 4.750"	114.30-120.65	17.49	GPS-98H
4.750" - 5.000"	120.65-127.00	38.99	GPS-98I
5.000" - 5.250"	127.00-133.35	17.49	GPS-98J
5.250" - 5.500"	133.35-139.70	17.49	GPS-98N

Rod Clamping Vise

- Align rods and caps perfectly
- Smooth jaws won't damage connecting rods like an ordinary vise
- Clamp rods firmly to align parting faces while torquing rod bolts
- Clamp in a vise or bolt to a workbench
- Order No. **RCV-20**
Jobber \$194.99

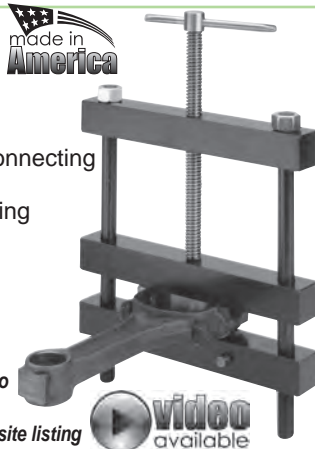

Watch a how-to video on the product's website listing



Rod Bolt Stretch Gauge

- Accurate to .001"
- Features a 1½" dial gauge
- Extra heavy-duty tension spring for repeatable accuracy
- For bolts from 1" to 2½" long
- See more information on rod bolt stretch on page 123

Description	Jobber	Order No.
Rod Bolt Stretch Gauge	\$92.99	RBSG-3
Optional Contact Point	13.99	ERBG-3T
Replacement Pointer	10.49	RBSG-P

Rod Bolt Boots

- Plastic boots protect crank journals & rod bolts during piston installation
- Save crank journals from rod bolt damage
- Don't risk your reputation for quality
- Reusable
- Set of 16
- Order No. **RBP-16**
Jobber \$9.99



On the product's website listing



Heavy-Duty Rod Bolt Installing Block

- Mount universal block in a vise to support rod while installing bolts
- Hardened aluminum won't slip
- If the top wears, you can restore it with a file or belt grinder
- Ream holes larger to accommodate oversize bolts
- Order No. **RB-50**
Jobber \$54.99



Piston Pin Installing Fixture

- Adjustable stops prevent over-centering rods
- Adjust the stop once and you're ready to assemble a full set of rods
- Base is pre-drilled to mount to a workbench
- Order No. **PIF-25**
Jobber \$119.99

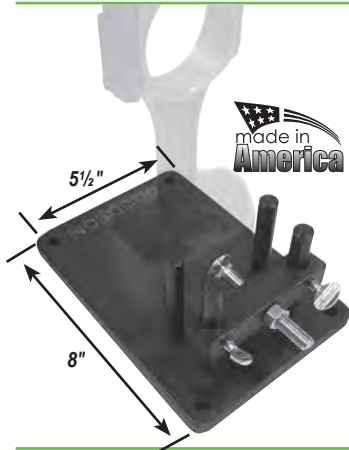

Piston Ring Expander

- Remove and install most rings
- Tapered jaws
- ¾" to ¼" ring width
- Order No. **PRE-500**
Jobber \$16.99

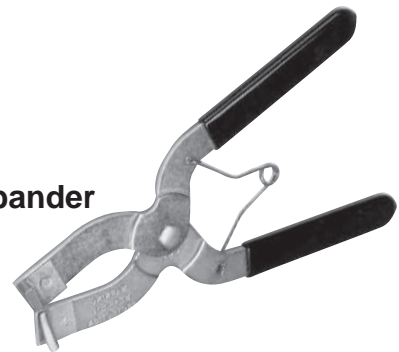

Fine Abrasive Stick

- Radiused for easier ring deburring after end gapping
- 4" L x ½" radius / 101.6mm x 12.7mm
- Works on all types of rings
- Works on ring ID radii
- Order No. **RS-103**
Jobber \$35.99



tech tips

from the techxperts™
Fine Abrasive

Sticks work great for deburring the ends of piston rings after filing, or any part that needs deburring. For a finer finish, soak the abrasive stick in Lapping Oil (LP-LO-4).

Piston Installing Deadblow Hammer

- 1 piece design
- Specially formulated urethane compound is cut and split resistant
- Convex-faced, non-mushrooming material
- Offset head
- Ideal for fast, mar-free piston installation
- Weighs 1.7 lbs./.77 kg
- Order No. **PK-200** Jobber \$69.99



made in America

The Original Goodson Powered Ring Filer

- No more tedious filing and checking and filing and checking to get desired end gap; set it once and cut multiple rings
- Easy to read integral dial indicator and positive ring stop make repeatable precision quick and easy
- Fits 2 1/2" to 5" / 63.5 to 127mm diameter rings
- Adjustable guide holds rings square to the cutting wheel
- Table pivots past cutting wheel
- No open ways to gather grinding dust that causes premature wear
- Handy knurled in-feed adjustment knob • High torque motor

Diamond Dresser is securely held in place by the ring clamping pin



Lighted Rocker Switch

Built-in deburring wheel eliminates the need to hand hone or deburr rings after filing

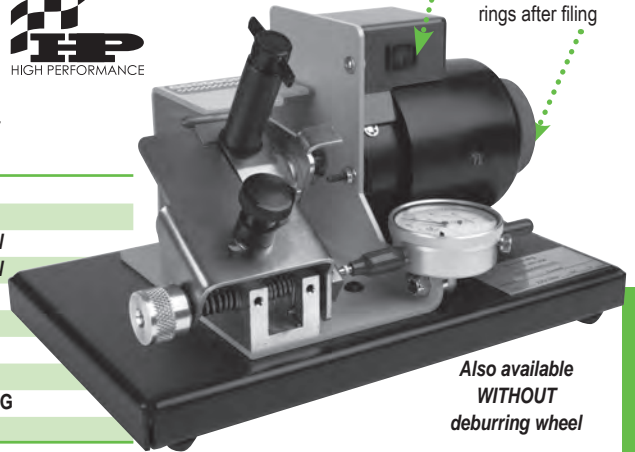

Also available WITHOUT deburring wheel

Description	Jobber	Order No.
Powered Ring Filer 110V / 60 cycle w/o Deburring Wheel	\$ 885.99	PRF-812
Powered Ring Filer with Deburring Wheel 110V / 60 cycle	979.99	PRF-812DW
Powered Ring Filer with Deburring Wheel 220V / 50 cycle	1059.99	PRF-822DW
Replacement Deburring Wheel	45.99	PRF-DW
2 1/2" Replacement Grinding Wheel (60 grit) for pre-2008 models	10.99	PRF-1001
3" Replacement Grinding Wheel (60 grit)	10.99	PRF-1002
Replacement Diamond Dresser	48.99	PRF-812D
Replacement Table Spring	29.99	PRF-SPRING
Sun-Dura® Canvas Machine Cover	33.99	GMC-PRF

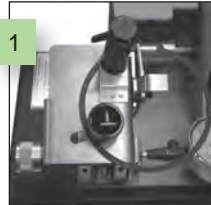

1 Stainless Steel Table

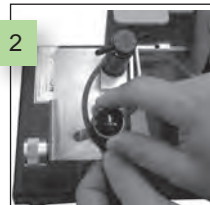

2 Eccentric adjusts quickly and easily

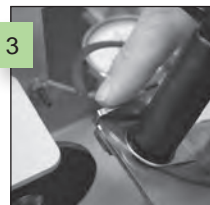

3 Positive ring stop

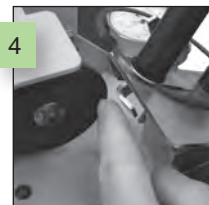

4 Table pivots past grinding wheel



GMC-PRF

Manual Ring Grinder

- Produce end gap rings squarely
- Heavy duty aluminum casting
- Precisely machined for long life
- Aluminum-Oxide wheel holds shape and produces clean precise cuts
- Includes 1 grinding wheel (replacements available)
- Wheel measures 2" OD x 7/16" ID x 1/8" thick

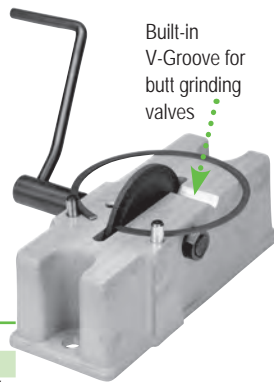

Built-in V-Groove for butt grinding valves

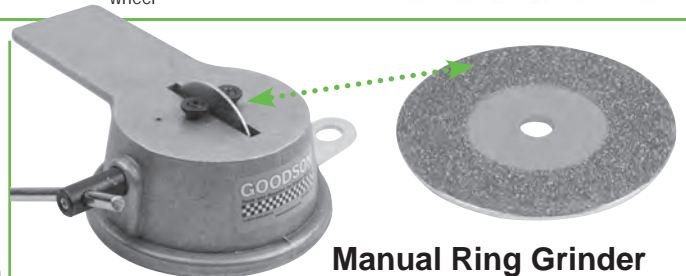

Manual Ring Grinder

- Universal design lets you grind almost any make, type or size of piston ring • Includes diamond abrasive wheel measuring 2" OD x 1/4" ID x 1/16" Thick

Description	Jobber	Order No.
Piston Ring Grinder	\$109.99	PRF-250
Replacement Wheel	19.99	PRF-250W

Description	Jobber	Order No.
Universal Piston Ring Filer	\$79.99	PRF-500
Replacement Diamond Abrasive Wheel	63.99	PRF-870-DW

Rod Balancing Stand

- Ideal for static balancing parts
- Use to weigh rotating and reciprocating masses and record the information for dynamic balancing
- Heavy-duty steel construction
- Includes 1-2" (50.8mm) and 1-2.3" (58.4mm) support discs
- Height adjustment for different rod sizes
- Order No. **BS-201** Jobber \$319.99

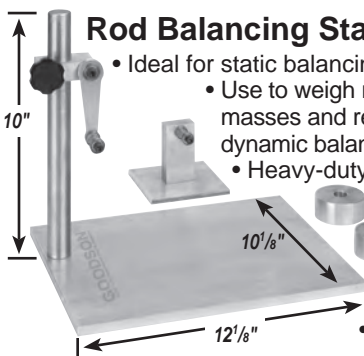

made in America

6100 Gram Balancing Scales

- Scales feature automatic tare weight correction
- 1.0 Gram / 0.100 Ounce increments
- Operates on 9V battery (not included) or 110V converter (included) • Low battery indicator
- Order No. **BS-6100** Jobber \$674.99



CYLINDER HEAD REBUILDING
CLEANING, ASSEMBLY & SAFETY
SHORT BLOCK REBUILDING
CRANKSHAFT/ FLYWHEEL GRINDING
MISCELLANEOUS TOOLS & SUPPLIES
BRAKE SERVICE TOOLING
MEASURING TOOLS
V-TWIN & METRIC HARD PARTS



"Technology has provided us with more efficient ways to give you, our customers, the quality of service you deserve! Our goal is to make ordering shop supplies faster & easier for you, whether you order by phone or through our website."

- Cheryl, Goodson IT/Order Fulfillment Manager - 29 years of service

CYLINDER HEAD REBUILDING
CLEANING, ASSEMBLY & SAFETY

Oil Gallery Plug Installer / Staker

- Set depth and lock plug in a single step
- Arbor nose aligns cup plug, then follows with two 180° staker lugs to set depth and lock oil gallery plug securely in place
- Order No. **ST-SB**
Jobber \$58.99



SHORT BLOCK REBUILDING

Steel Oil Gallery Plugs

- Replace lost or damaged originals
- 1/4" pipe plugs
- For use at the rear of Small Block Chevy oil galleries or other engines with similar size plugs
- 25 per box
- Order No. **OP-250**
Jobber \$12.99

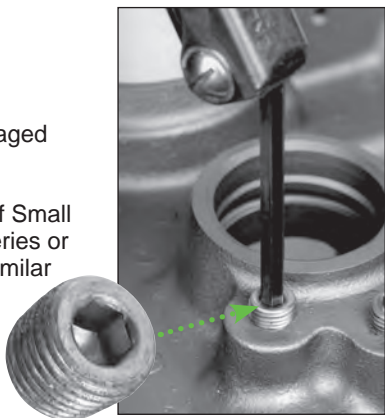

CRANKSHAFT/ FLYWHEEL GRINDING

MISCELLANEOUS TOOLS & SUPPLIES

Oil Gallery Brushes

Steel Wire		Jobber 1+	Jobber 10+	Order No.	Incl.
3-pc. Kit	Size	Length	\$21.99	OGB-SK	▼
	1/4" x 3"	24"	9.99	OGB-1	x
	3/8" x 3"	24"	10.99	OGB-2	x
	5/8" x 3"	24"	11.99	OGB-3	x
Nylon Bristle					
5-pc. Kit	Size	Length	46.99	OGB-KIT	▼
	3/8" x 3"	34"	8.99	OGB-38	x
	1/2" x 2 1/2"	34"	9.99	OGB-42	x
	5/8" x 3"	34"	10.49	OGB-5	x
	3/4" x 3"	34"	9.99	OGB-7	x
	3/4" x 3"	40"	10.99	OGB-8	x

Buy 10 or more brushes (any combination), Save 10% off Jobber

BRAKE SERVICE TOOLING

MEASURING TOOLS



100% Natural Oil Gallery Beeswax

- Preheat the part to be removed, apply wax to its base, allow to cool and remove the part
- 100% natural beeswax
- Measures 1" x 3/4" x 3"
- Weighs 1 oz.
- Order No. **BWS-1** Jobber \$4.79

V-TWIN & METRIC HARD PARTS



Includes 1 Replaceable Blade

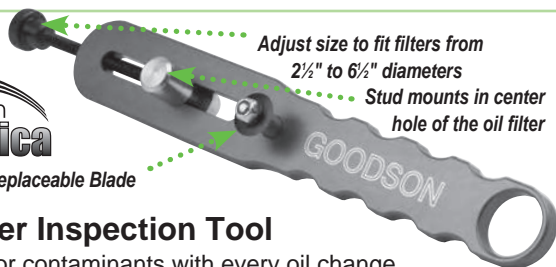

Oil Filter Inspection Tool

- Check for contaminants with every oil change
- Cut open the filter canister for inspection
- Fits 2 1/2" to 6 1/2" diameter filters
- Includes a single blade

Description	Jobber	Order No.
Oil Filter Inspection Tool	\$87.99	FIT-1-G
Replacement Cutter Blade	14.49	FIT-W

Oil Pump Pickup Tube Driver

- For all GM pumps
- Replace pickup tubes easily with a light mallet
- Driver grips the pickup tube flare
- Gives control for fast alignment and installation

Application	Tube OD	Jobber	Order No.
Small Block	5/8"/15.9mm	\$39.99	TI-25
Big Block	3/4"/19.1mm	39.99	TI-30

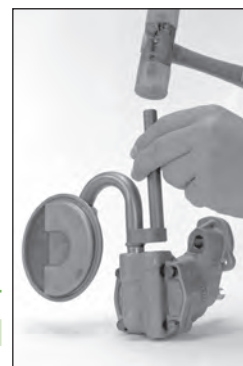

BRAKE SERVICE TOOLING

Oil Gallery Plug Removers

- Power plugs out with an impact wrench
- Threaded plug inside prevents bit from backing into the holder
- Hardened tool-steel holder with lifetime breakage guarantee (excludes bit)
- Tool-steel bit can be reground or replaced
- Set screw holds bit firmly in place
- 1/2" drive – fits your impact wrenches
- Do NOT use with a breaker bar or ratchet

Description	Size		Jobber	Order No.	Incl.
Plug Remover Kit	in	mm	\$199.99	PPS-KIT	▼
Replacement Tool	3/16"	4.76	45.99	PPS-187	x
Tool includes	1/4"	6.35	45.99	PPS-250	x
bit (except	5/32"	7.14	47.99	PPS-281*	x
PPS-281)	5/16"	7.94	45.99	PPS-312	x
	3/8"	9.53	45.99	PPS-375	x
Replacement Bits	3/16"	4.76	14.99	PPS-187B	
	1/4"	6.35	14.99	PPS-250B	
	5/16"	7.94	14.99	PPS-312B	
	3/8"	9.53	14.99	PPS-375B	

NOTE: *No bit is needed for PPS-281 (square socket).

... another satisfied customer

"Along with the slide hammer set, the lifter bore burnishing tool fixes tight lifter bores, even on assembled bottom ends quick and easy!! My last race motor build was going great until I noticed a few of my new lifters were real tight at the bottom of the bore.

This tool resized the bores fast and accurate even with the cam still in place. Due to the method of resizing, the entire block isn't contaminated with debris like a hone would do, and saves time and money."

- Grant Farmer, Grand Island, NY, Goodson Customer since 2018

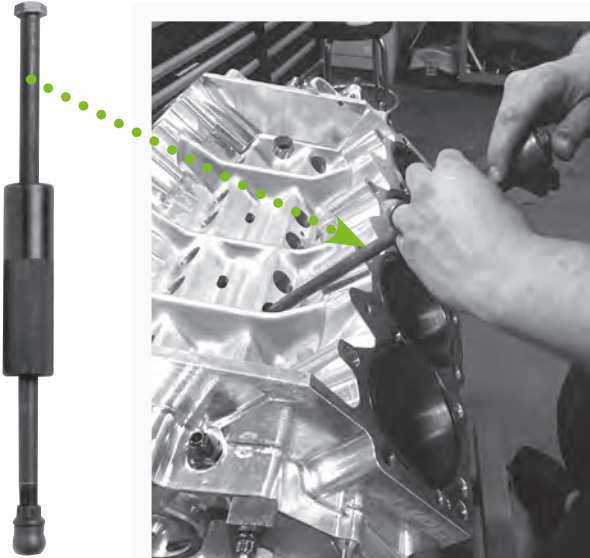

Photo courtesy Tim Wilkerson Racing

Lifter Bore Burnishing Tools

- Eliminate burrs caused by shot blasting
- Drive the burnishing tool into the bore with a soft hammer then slide-hammer it back out
- 60Rc burnishing balls deburr and correct out-of-round lifter bores quickly and easily
- Won't oversize the bore



Description	Jobber	Order No.	Includes
Standard Burnishing Tool Set	\$194.99	LBB-1500	▼
14" Slide Shaft	198.99	GAO-1	x
15" Slide Shaft	21.99	LBB-1	
Slide Hammer	39.99	GAO-2	x
Lifter Bore Burnishing Balls			
0.8450" dia. (General Motors)	\$44.99	LBB-GM1	x
0.8760" dia. (Ford)	44.99	LBB-FO1	x
0.9060" dia. (Chrysler)	44.99	LBB-CR1	x
1.0000" dia.	61.99	LBB-1.000	
1.0010" dia.	61.99	LBB-1.001	
1.0625" dia.	61.99	LBB-1.0625	
1.0635" dia.	61.99	LBB-1.0635	
Jam Nut	10.49	LBB-NUT	x
Lifter Bore Brushes.			
7/8" (.875") dia.	\$ 9.99	LBB-875	
1" (1.00") dia.	10.99	LBB-100	
1 1/8" (1.125") dia.	10.49	LBB-1125	

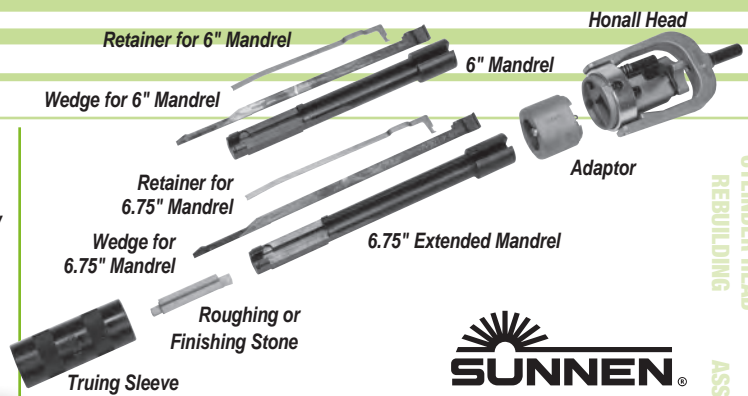

Sunnen® Lifter Bore Hones

- Restore bore size and finish after shot blasting
- Install oversize lifters for high-performance
- Stones work in cast iron bores or ones sleeved with brass or steel
- Wide stones contact a large area giving better stability for hand honing
- Cross oil ports without catching
- Wedge-type adjustment is a simple, positive way to expand or contract the stone to the precise size needed
- Use a 3/8"(9.5mm) or 1/2"(12.7mm) hand-held electric or air drill at approx. 200 RPM
- Use with honing oil
- **All parts MUST be ordered separately to make a complete unit**

tech tips
from the techxperts™

NOTE: Wedges may come with a tab that must be removed **BEFORE** using them with the P-180 Head

Description	Jobber	Order No
Honall Head	\$578.07	P-180
Adaptor	113.42	PAK20-A
Roughing Stone (280 Grit) 12/box	136.17	Y20-J67
Finishing Stone (400 Grit) 12/box	136.17	Y20-J87
Standard Lifter Bore Tooling (6" Reach)		
Mandrel .838" - .869" Range	\$533.75	AA20838BH6LH
.869" - .900" Range	507.93	AA20869BH6LH
Wedge	109.54	Y20-W-6LH
Retainer	66.39	LN-3688A-6LH
Truing Sleeve .838" - .869" Range	33.40	S-838
.869" - .900" Range	33.40	S-869
Extended Reach Lifter Bore Tooling (6 1/2" Reach)		
Mandrel .838" - .869" Range	\$544.11	AA20838675LH
.869" - .900" Range	561.70	AA20869675LH
Wedge	109.54	Y20-W-675LH
Retainer	66.39	LN-3688A675LH
Truing Sleeve .838" - .869" Range	33.40	S-838
.869" - .900" Range	33.40	S-869

Goodson is authorized to ship Sunnen products only within the Americas



Rod Honing Oil

- Includes additives for high pressure cutting
- Keeps stones clean and free-cutting during rod reconditioning, pin fitting and other honing applications
- Will mix with other honing oils (including Sunnen®)

Size	Jobber	Order No.
1 Gal. (3.78L)	\$ 54.99	RHO-10
5 Gal. (18.9L)	269.99	RHO-50

CYLINDER HEAD REBUILDING
CLEANING, ASSEMBLY & SAFETY
SHORT BLOCK REBUILDING
FLYWHEEL GRINDING
CRANKSHAFT/ MISCELLANEOUS TOOLS & SUPPLIES
BRAKE SERVICE TOOLING
MEASURING TOOLS
V-TWIN & METRIC HARD PARTS

... another satisfied customer

"Goodson is such an easy company to do business with. We'll certainly order again."
 — David Everitt, Milton, PA, Goodson customer since 2022

CYLINDER HEAD REBUILDING

CLEANING, ASSEMBLY & SAFETY

SHORT BLOCK REBUILDING

CRANKSHAFT/ FLYWHEEL GRINDING

MISCELLANEOUS TOOLS & SUPPLIES

BRAKE SERVICE TOOLING

MEASURING TOOLS

V-TWIN & METRIC HARD PARTS



Threaded Impact Cap now included with all drivers

Universal Cam Bearing Tool

- Remove and install hundreds of sizes of cam bearings with just four mandrels!
- Expanding Mandrels cover a 1.370"-2.250" range
- Adjusts instantly to under-size bearings so you can remove and install them from virtually any block
- Approximately 1/4" range for each size segment
- Interchangeable with Dura-Bond

Description	Jobber	Order No.	Incl.
Universal Cam Bearing Tool	\$719.99	CBT-300	▼
Replacement Segment with Sleeve			
Max Dia. 1.370"	\$66.99	CBT-5M	x
1.682"	67.99	CBT-6M	x
1.875"	71.99	CBT-7M	x
2.250"	79.99	CBT-8M	x
Replacement Backing Plate			
Max Dia. 1.375"	\$18.99	CBT-5W	x
1.682"	21.99	CBT-6W	x
1.885"	22.99	CBT-7W	x
2.250"	23.99	CBT-8W	x
Replacement Neoprene Sleeve			
Max Dia. 1.370"	\$ 9.49	CBT-5NS	
1.682"	11.49	CBT-6NS	
1.875"	11.49	CBT-7NS	
2.250"	13.39	CBT-8NS	
Drivers			
Length 5" (pictured at left)	\$ 63.99	CBT-1B	x
24"	127.99	CBT-2B	
36" (pictured at left)	164.99	CBT-3B	x
48"	174.99	CBT-4B	
Miscellaneous Replacement Parts			
1.200" Expander with stud	\$69.99	CBT-3E	x
1½" Expander with stud	67.99	CBT-4E	x
½"x13 Stud	17.49	CBT-1S	
3" Guide Cone	39.99	CBT-1C	x
Steel Storage Rack	134.99	CBT-300-WR	x

INTERCHANGEABLE WITH DURA-BOND

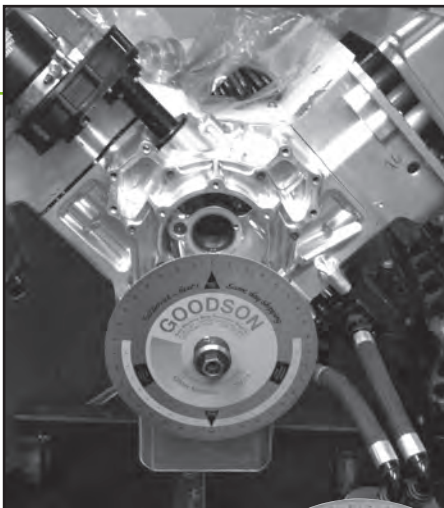

This is ... another satisfied customer
 one of those customer
 MUST have tools for the shop and trailer. We have needed our Goodson Degree wheel at the track a few times and in a few minutes we were done and ready to go! Thanks again for great equipment.
 — Dean Dubbin, DMP Awnings (NHRA Top Alcohol Dragster), Goodson customer since 2010

Degree Wheel

- Check cam timing, duration and overlap
- Degree wheel measures 11" / 279.4mm dia. with 1½"/47.6mm hole • Complete kit includes the Degree Wheel, a ¾" ID mounting hub for mounting on cranks using 7/16" to ¾" fasteners, a 1/2" hub and necessary fasteners • Use hubs or turning tool to mount the wheel.
- Use with ½" drive ratchet

Wheel / Adaptors	Jobber	Order No.	Incl.
Automotive Degreasing Kit	\$51.99	DW-KIT-2	▼
Degree Wheel	38.99	DW-11	x

Bearing Scraper

- Eliminate bearing high spots after installation to ensure correct oil clearance
- Solid hardwood handle
- 4" / 101.6mm blade with 3 cutting edges
- German steel blade
- Order No. **BS-30**
 Jobber \$51.99



Lifting Sling

- Lift up to 1800 lbs. safely and easily
- 1" x 36" looped nylon webbing sling
- Do NOT use with caustics or temperatures exceeding 190°F
- Order No. **LS-3** Jobber \$12.49



Whether you're regrinding cores for stock applications or custom grinding for diesel and high performance, you can count on Goodson Cam Grinding Wheels to deliver an excellent finish

Goodson abrasives are second to none. We work with our manufacturers to get you the most ideal grain that's bonded to be free-cutting, yet still shed before loading up. Our Premium wheels are ideal for steel high performance camshafts of 55 to 65 Rc and for Stellite overlays. Goodson finishes all Camshaft Grinding Wheels to your specifications in-house for faster turn-around and delivery. Choose from the sizes below or custom order your cam wheel today!



CYLINDER HEAD
REBUILDING
CLEANING,
ASSEMBLY & SAFETY

Cam Grinding Wheels - WAA54-L5V1 - 54 Grit						
Diameter	Width	Arbor		Jobber	Order No.	
18"	3/4"	19mm	6"	152mm	\$259.99	E341420
457mm	7/8"	22mm	6"	152mm	269.99	E335351
	1"	25mm	6"	152mm	279.99	E335352
	1 1/8"	29mm	6"	152mm	309.99	E335353
	1 1/4"	32mm	6"	152mm	309.99	E335354

Cam Grinding Wheels - 43A602-K8-V1 - 60 Grit						
Diameter	Width	Arbor		Jobber	Order No.	
18"	3/4"	19mm	6"	152mm	\$259.99	E342030
457mm	7/8"	22mm	6"	152mm	269.99	E339945
	1"	25mm	6"	152mm	279.99	E342031
	1 1/4"	32mm	6"	152mm	309.99	E348558

Cam Grinding Wheels - 7BL801 - 80 Grit						
Diameter	Width	Arbor		Jobber	Order No.	
18"	3/4"	19mm	6"	152mm	\$424.99	E416880
457mm	7/8"	22mm	6"	152mm	424.99	E427392

Due to the manufacturing process, actual colors may vary

Cam Grinding Wheels - WAA100 - 100 Grit						
Diameter	Width	Arbor		Jobber	Order No.	
18"	3/4"	19mm	6"	152mm	\$289.99	E379225
457mm	7/8"	22mm	6"	152mm	294.99	E397667
	1 1/4"	32mm	6"	152mm	319.99	E416183

Standard Goodson Cam Grinding Wheels - 100 Grit						
Diameter	Width	Arbor		Jobber	Order No.	
18"	3/4"	19mm	6"	152mm	\$264.99	GCC 18 x 0.750 x 6
457mm	7/8"	22mm	6"	152mm	294.99	GCC 18 x 0.875 x 6
	1"	25mm	6"	152mm	299.99	GCC 18 x 1.000 x 6
	1 1/4"	32mm	6"	152mm	329.99	GCC 18 x 1.250 x 6

Due to the manufacturing process, actual colors may vary

SHORT BLOCK
REBUILDING

CRANKSHAFT/
FLYWHEEL GRINDING

MISCELLANEOUS
TOOLS & SUPPLIES

BRAKE SERVICE
TOOLING

MEASURING
TOOLS

V-TWIN & METRIC
HARD PARTS

Ask about special order sizes, grits & grains

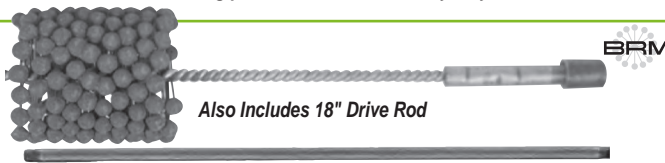

Also Includes 18" Drive Rod

180 Grit Cam Bearing Flex-Hones®

- Silicon-Carbide globules laminated to high density nylon
- Includes 18" drive rod

Inch	mm	OAL	Jobber 1+	Jobber 3+	Order No.
1 3/4"	45	17 1/2"	\$59.99	\$55.61	CBF-175
2"	51	17 1/2"	63.99	57.59	CBF-200
2 1/4"	57	17 1/2"	64.99	58.49	CBF-225
2 1/2"	64	17 1/2"	66.99	60.29	CBF-250
2 3/4"	70	17 1/2"	67.99	61.19	CBF-275

Order 3 or more (mix or match) to Save 10% off Jobber

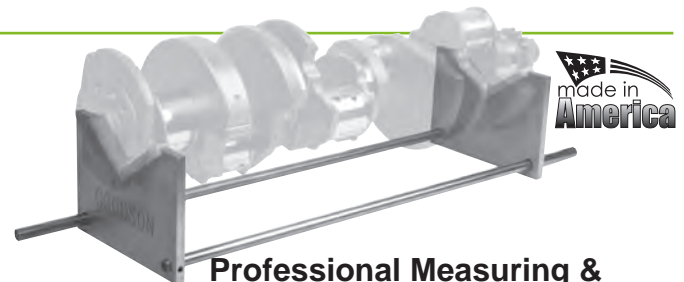

Professional Measuring & Inspection Stand For Cranks & Cams

- Length adjusts up to 23" to fit journal spacing
- Rotate work to view or measure
- Solid aluminum frame with self-lubricating, corrosion and chemical-resistant wear surfaces
- Order No. **PMIS-30** Jobber \$149.99

Bore Washing Brushes

- Clean tunnel housing bores and full-annular grooved area
- Heavy, hand-driven shank

Bore Washing Brushes

Dia.	Length	Jobber 1+	Jobber 10+	Order No.
2"	36"	\$23.99	\$21.59	CBB-200
2 1/4"	36"	24.99	22.49	CBB-225
2 1/2"	36"	27.99	25.19	CBB-250
2 3/4"	18 1/2"	30.99	27.89	CWB-27W
3 1/2"	18 1/2"	30.99	27.89	CWB-35
4"	18 1/2"	25.49	22.94	CWB-40
4 1/2"	18 1/2"	33.99	30.59	CWB-45
5"	18 1/2"	41.99	37.79	CWB-50

Order 10 or more (mix or match) to Save 10% off Jobber



Cam & Crank Grinding Coolant

- Semi synthetic
- Non-nitrite
- High-lubricity
- Dilute 20 parts water to 1 part coolant

Size	Jobber	Order No.
1 gallon (3.78L)	\$ 40.99	CGC-10
5 gallons (18.93L)	194.99	CGC-50



full service
...fast



"The Mach-B division of Goodson offers many services such as ANSI compliant speed testing, balance testing, grinding wheel shaping, resizing and more. Find out more at Mach-B.com."

- Jon, Goodson Production Manager, 43 years of service

Goodson crankwheels are made-to-order in-house

Other sources stock finished wheels, which makes it virtually impossible to stock a full range of sizes. If they don't have what you need, they may charge more and delay your order for weeks. That's why Goodson makes every wheel to order. We always have the right wheel because we take a Type 1 straight wheel, size it, shape it, speed test it and ship it.

For future reference write down your

Crank Wheel Number (s)

Select the shape



Hub

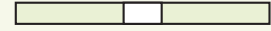

Straight

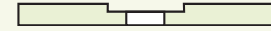

Recessed 1 Side

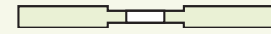

Recessed 2 Sides



Tapered

Select your wheel grade:

WAA



Superior Grade - 54 grit
Excellent dimensional accuracy, corner radii and surface finish. For multiple applications including weld grinding. Ideal for grinding everything from cast iron to steel. Finishing and roughing wheel.
Aluminum-oxide abrasive for light to medium stock removal.

CSS ULTRA

Premium Grade
This new abrasive formulation combines high-quality components and an innovative bonding technology to produce a long-lived, cool grinding abrasive wheel. White and sintered aluminum-oxide. Increase stock removal rates without sacrificing quality. Limited stock available.

GCH



Superior Grade - 54 grit
Better form holding ability, cuts cooler and needs less dressing. Use on crank journals with Rockwell hardness of 35 Rc or less. Use on crankshafts of cast or forged steel, Nodular iron. Ideal for large radii, thrust and plunge grinding. Great for high-performance.

GCD

Premium Grade - 60 grit
For harder materials. Good form holding ability; cuts cooler and needs less dressing. Grains yield faster, cooler grinding. Use on journals with Rockwell hardness of 35 Rc or more. Ideal for diesel, high-performance, industrial and billet steel.

Increase coolant flow with Crankwheel Slotting

Slotting facilitates the flow of coolant to the thrust and radius areas of the crankshaft to prevent journal burning. Highly recommended for high performance and diesel crankshafts. Don't waste time waiting on other suppliers who outsource their crankwheels for slotting – Goodson has a shop full of equipment, so we slot wheels in house!
Order No. **SLOTTING** Call for quote

How to order:

If you have any questions, please call 1-800-533-8010

Grade	Diameter (OD)	Face Width	Arbor Size (ID)	Machine	Shape
WAA - Superior	Diameters are available from 18" to 36" in most grades.	Most sizes from 3/4" to 2 5/8" (custom widths available). Be sure to include mounting surface thickness.	Arbor size of your grinder. Any arbor hole from 3" to 12".	Identify the make and model of your grinder.	Specify the shape for your grinder. We will need the diameter and depth of tapers, recesses and hubs.
GCD - Premium					
GCH - Superior					
CSS-ULTRA					

Crankshaft Grinding Wheels

Due to the commodity-like nature of abrasive grinding wheels, prices may change without notice. Please call us at **1-800-533-8010** or **1-507-452-1830** to confirm current pricing and availability.

No additional discounts available!



		WAA	GCH	GCD
Dia.	Face Width	Jobber	Jobber	Jobber
Fits Storm Vulcan 14, 15				
18"	3/4"-1"	\$223.99	\$349.99	call
3" Arbor	1 1/64"-1 1/4"	269.99	369.99	call
	1 17/64"-1 1/2"	279.99	599.99	call
	1 33/64"-1 3/4"	289.99	619.99	call
	1 49/64"-2"	299.99	639.99	call
Fits Storm Vulcan 15, 15 Special, 1550, 1648				
20"	3/4"-1"	\$259.99	\$349.99	call
3" Arbor	1 1/64"-1 1/4"	269.99	369.99	call
	1 17/64"-1 1/2"	279.99	599.99	call
	1 33/64"-1 3/4"	289.99	619.99	call
	1 49/64"-2"	299.99	639.99	call
Fits Kwik-Way / Lemppo				
20"	3/4"-1"	call	call	call
3 3/4" Arbor	1 1/64"-1 1/4"	call	call	call
	1 17/64"-1 1/2"	call	call	call
	1 33/64"-1 3/4"	call	call	call
	1 49/64"-2"	call	call	call
Fits Kwik-Way / Lemppo 539 & Storm Vulcan 15A (early)				
22"	3/4"-1"	\$379.99	call	call
5" Arbor	1 1/64"-1 1/4"	399.99	call	call
	1 17/64"-1 1/2"	419.99	call	call
	1 33/64"-1 3/4"	439.99	call	call
	1 49/64"-2"	609.99	call	call
Fits Peterson Berco 180				
22"	3/4"-1"	call	call	call
8" Arbor	1 1/64"-1 1/4"	call	call	call
	1 17/64"-1 1/2"	call	call	call
	1 33/64"-1 3/4"	call	call	call
	1 49/64"-2"	call	call	call
Fits Storm Vulcan 15A (late), 15A Special; RMC/Robbi REX-1200				
Fits Kwik-Way / Lemppo KGA and NKG Series				
24"	3/4"-1"	\$349.99	\$ 749.99	\$ 729.99
5" Arbor	1 1/64"-1 1/4"	369.99	919.99	979.99
	1 17/64"-1 1/2"	389.99	999.99	999.99
	1 33/64"-1 3/4"	599.99	1019.99	1319.99
	1 49/64"-2"	609.99	1039.99	1329.99
Van Norman 438, 448, 460, 465;				
Winona Van Norman/Zanrosso CG-210 (early); Storm Vulcan Scledum 200				
24"	3/4"-1"	\$499.99	\$ 749.99	\$ 839.99
8" Arbor	1 1/64"-1 1/4"	519.99	919.99	869.99
	1 17/64"-1 1/2"	699.99	999.99	899.99
	1 33/64"-1 3/4"	709.99	1019.99	949.99
	1 49/64"-2"	759.99	1039.99	1029.99
Storm Vulcan 15C				
25"	3/4"-1"	\$399.99	\$ 749.99	\$ 979.99
5" Arbor	1 1/64"-1 1/4"	419.99	919.99	999.99
	1 17/64"-1 1/2"	589.99	999.99	1019.99
	1 33/64"-1 3/4"	609.99	1009.99	1299.99
	1 49/64"-2"	629.99	1019.99	1329.99
AMC K1100; Peterson Berco 180, 225; Scledum 200, 230; Van Norman 438, 448, 460, 465, 475, 476; Winona Van Norman CG-210 (late), CG-840				
26"	3/4"-1"	\$469.99	\$ 739.99	\$ 789.99
8" Arbor	1 1/64"-1 1/4"	489.99	749.99	809.99
	1 17/64"-1 1/2"	689.99	789.99	829.99
	1 33/64"-1 3/4"	709.99	929.99	899.99
	1 49/64"-2"	759.99	969.99	1019.99
2 1/64"-2 1/4"	849.99	1049.99	1039.99	

		WAA	GCH	GCD
Dia.	Face Width	Jobber	Jobber	Jobber
Schou 1500/270, 1600, 260				
27 1/2"	3/4"-1"	call	call	call
8 5/8" Arbor	1 1/64"-1 1/4"	call	call	call
	1 17/64"-1 1/2"	call	call	call
	1 33/64"-1 3/4"	call	call	call
	1 49/64"-2"	call	call	call
2 1/64"-2 1/4"	call	call	call	
Peterson Berco 260; SV Scledum 230, 270/280; Zanrosso Mito 250; Van Norman 400, 438, 454, 475, 476, 666; RMC/Robbi REX-1500				
28"	3/4"-1"	\$499.99	\$ 809.99	\$ 699.99
8" Arbor	1 1/64"-1 1/4"	599.99	889.99	779.99
	1 17/64"-1 1/2"	689.99	899.99	859.99
	1 33/64"-1 3/4"	709.99	999.99	899.99
	1 49/64"-2"	759.99	1019.99	1029.99
2 1/64"-2 1/4"	849.99	1069.99	1119.99	
2 17/64"-2 5/8"	call	call	1149.99	
Seest MC62				
30"	3/4"-1"	call	call	call
6" Arbor	1 1/64"-1 1/4"	call	call	call
	1 33/64"-1 3/4"	call	call	call
	1 49/64"-2"	call	call	call
Zanrosso Mito 280; Storm Vulcan Scledum 270/280; RMC / Robbi REX-1800, REX 2200L				
30"	3/4"-1"	\$529.99	\$1249.99	\$ 949.99
8" Arbor	1 1/64"-1 1/4"	599.99	1319.99	1149.99
	1 17/64"-1 1/2"	639.99	1859.99	1279.99
	1 33/64"-1 3/4"	659.99	1859.99	1329.99
	1 49/64"-2"	679.99	1859.99	1619.99
2 1/64"-2 1/4"	call	call	1869.99	
2 17/64"-2 5/8"	call	call	1889.99	
AMC 1400, K1500, K1800; Van Norman 467, 477; Zanrosso				
32"	3/4"-1"	\$569.99	\$1244.99	\$ 949.99
8" Arbor	1 1/64"-1 1/4"	599.99	1319.99	1149.99
	1 17/64"-1 1/2"	649.99	1819.99	1279.99
	1 33/64"-1 3/4"	669.99	1839.99	1439.99
	1 49/64"-2"	689.99	1859.99	1629.99
2 1/64"-2 1/4"	call	call	1879.99	
2 17/64"-2 5/8"	call	call	1899.99	
Peterson Berco 280, 300; RMC Robbi REX-1800RM; REX-2200, REX-2200RM, REX-2700RM, REX-3100RM				
32"	3/4"-1"	call	call	call
12" Arbor	1 1/64"-1 1/4"	call	call	call
	1 17/64"-1 1/2"	call	call	call
	1 33/64"-1 3/4"	call	call	call
	1 49/64"-2"	call	call	call
2 1/64"-2 1/4"	call	call	call	
2 17/64"-2 5/8"	call	call	call	
Peterson Berco 300, 350; Storm Vulcan Scledum 250; RMC / Robbi REX-2200M, 2700M, 3100M; Winona Van Norman 111				
36"	3/4"-1"	\$729.99	call	\$1279.99
12" Arbor	1 1/64"-1 1/4"	749.99	call	1299.99
	1 17/64"-1 1/2"	779.99	call	1499.99
	1 33/64"-1 3/4"	799.99	call	1519.99
	1 49/64"-2"	869.99	call	1679.99
2 1/64"-2 1/4"	call	call	1699.99	
2 17/64"-2 5/8"	call	call	1979.99	

NOTE: All wheel widths are delivered up to .015" oversized to allow for side dressing when mounting the wheel

CYLINDER HEAD REBUILDING
CLEANING, ASSEMBLY & SAFETY
SHORT BLOCK REBUILDING
CRANKSHAFT/FLYWHEEL GRINDING
MISCELLANEOUS TOOLS & SUPPLIES
BRAKE SERVICE TOOLING
MEASURING TOOLS
V-TWIN & METRIC HARD PARTS

full service
...fast



"We've continually improving our production department to provide more flexibility in grinding wheel shapes and profiles. Give us a call when you need something special."

- Brandon, Goodson Production, 1 year of service

CYLINDER HEAD
REBUILDING

CLEANING,
ASSEMBLY & SAFETY



Crankshaft Journal Radius Gauge

- 16 radii ... 1/32" to 17/64"
- Measure radii of reground journals quickly
- Blades are clearly marked in 1/64" increments
- Use in holder or remove to use blades separately
- Order No. **RG-16** Jobber \$51.99

SHORT BLOCK
REBUILDING

Crankshaft Straightening Peening Tool

- Designed for narrow journals on some new-style V6 crankshafts
- Peen crankshafts in the radius area of damaged journals to straighten
- Long-shank
- Offset-radius face
- 10" long • 0.0625" radius
- 0.125" diameter

CRANKSHAFT/
FLYWHEEL GRINDING

Description	Jobber	Order No.
Peening Tool	\$59.99	CPT-062
Safety Glasses	6.99	PGL-21

tech tips
from the techexperts™
Stay Safe In

The Workplace!
Always wear
protective gear.



Hand-Held Dressing Sticks

- Keep your crankshaft grinding wheels cutting clean

GG-112

DS-NOR



Hard Silicon-Carbide

- 1" x 1" x 6"
- Use to deglaze wheel side
- Removes material with light pressure
- Order No. **GG-112** Jobber \$29.99

Dense Granular Norbide

- 3/16" x 1/2" x 3"
- Long lasting
- For fine tuning radius and side relieving wheels
- Order No. **DS-NOR** Jobber \$94.99

Starrett®

Universal 12"L Quick-Set Crankshaft Grinder Dial Indicator

- 3/8" diameter shaft • 12" long
- .125" travel, .050" per revolution
- Rotating, lockable bezel graduated in .001" from -.025" to + .025"
- Order No. **MDI-12** Jobber \$474.99



Goodson exclusive

More Dial Indicators on page 127

MISCELLANEOUS
TOOLS & SUPPLIES

Mach-B Grinding Wheel Shaping & Resizing



From routine grinding wheel shaping and sizing to emergency work, **Mach-B Can Do That!**

Mach-B Grinding Wheel Shaping & Resizing specializes in:

- Custom Grinding Wheel Shaping
- Custom Grinding Wheel Sizing
- Reducing Outside Diameters
- Increasing Inside Diameters
- ANSI Compliant Speed Testing
- Static Balance Testing
- Standard and Custom Profiles
- Grinding Wheel Slotting



Turn to Mach-B and Goodson for Fast Turnaround. Visit www.mach-b.com for more information.



Goodson has several videos available related to Camshaft & Crankshaft Grinding. To access them on our website, simply scan the appropriate code with your smart phone or other smart device.

Crankshaft Grinding Wheel Selection



Grinding Wheel Slotting





Eliptibur Tool

- Fastest, safest way to chamfer crank oil holes
- Simplify deburring and chamfering of angularly drilled holes on cylindrical surfaces
- Easily produces a chamfer of relative uniformity and depth
- Self-centering, spring loaded pilot
- Includes one replaceable blade
- For 30Rc or softer crankshafts

Description	Jobber	Order No.
Eliptibur Tool (1 blade included)	\$334.99	EBT-15
Replacement Blade	53.99	EBT-15B
Replacement Pilot	99.99	EBT-15N

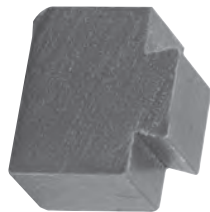

Need Steady Rest Shoes?

Email orderdesk@goodson.com or fax 1-507-452-2907 the design and dimensions for what you need

Crankshaft Grinder Steady Rest Shoes for Peterson-Berco

- Use same shoe for upper and lower replacement
- $\frac{5}{16}$ " thick
- Order No. **RBE-200** Jobber \$28.99



Create a relief in the block for rod #2 at the pan rail area using your normal process.



Place the arbor in main saddles 1 & 2, keeping the flange nearest to the pointer against #2.



Rotate the arbor and adjust the pointer until the tapered end passes freely through the relief with a minimum of clearance.



Lock the pointer in position with the set screw and check the clearance.



Once satisfied, scribe a line on the pointer opposite the set screw.

A Must-Have when building a Stroker Engine!

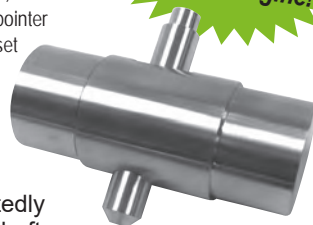

Stroker Mimic™

- Lightweight and easy to use
- Eliminates the need to repeatedly install and remove the crankshaft, pistons, rod assembly and the necessary bearings when clearancing a block for a stroker crank
- Once the Stroker Mimic™ has been set to a particular crank, rod and piston combination, the tool can be marked or measured for future reference
- Order No. **SM-350** Jobber \$117.99



Reluctor Ring Installation Tool



All steel construction features 2 indexing dowels to properly align the reluctor ring when installing it on the crankshaft. Designed to fit Generation III (LS1, LS6) and Generation IV (LS 2, LS3, LS7) engines. Aligns GM sensor rings (12559353, 12586768). **US Patent No. 7,716,827.**

Goodson exclusive

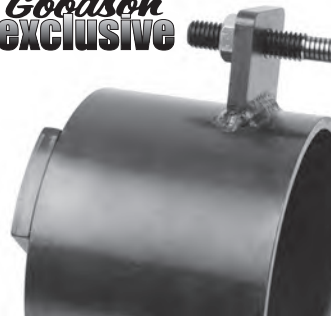

The 8mm indexing dowel is attached to the fixture by an exterior tang. It can be adjusted for depth to accommodate a variety of popular flange widths. This dowel fits into the only 8mm hole on the reluctor wheel.



The internal indexing dowel pin is designed to fit into the dowel pin hole on the crankshaft. It is adjustable to fit different depths. The combination of dowel pins gives very precise alignment of the reluctor wheel and crankshaft.

Description	Jobber	Order No.
Reluctor Ring Installation Tool	\$283.99	RRJ-350
Temperature Indicating Crayon (450° F/232°C)	24.99	TIC-450

tech tips
from the techxperts™

Heat reluctor ring to 450°F (232°C) then slide it onto the casting. Be sure to deburr all components before beginning assembly. Any sharp edges will cause the reluctor ring to catch on the casting, making assembly impossible.

Conversion Calculator

We've tried to convert as many SAE measurements to Metric (and vice versa) as possible. In some cases there hasn't been enough room. If you need to convert a measurement, here are the formulas:

Starting Measurement	Conversion Formula	Converted Measurement
Inches (in)	Inches x 25.4	Millimeters (mm)
Feet (ft)	Feet x .3048	Meters (m)
Millimeters (mm)	Millimeters ÷ 25.4	Inches (in)
Fahrenheit (F)	(5 ÷ 9) x (F - 32)	Celsius (C)
Celsius (C)	(9/5 x C) + 32	Fahrenheit (F)

CYLINDER HEAD REBUILDING
CLEANING, ASSEMBLY & SAFETY
SHORT BLOCK REBUILDING
CRANKSHAFT/FLYWHEEL GRINDING
MISCELLANEOUS TOOLS & SUPPLIES
BRAKE SERVICE TOOLING
MEASURING TOOLS
V-TWIN & METRIC HARD PARTS



"We do our best to get our inventory on the shelves; professionally and correctly packaged and ready for when you need it."

- Brandon, Goodson Receiving, 3 years of service

CYLINDER HEAD
REBUILDING

Plastigage

- Accurately measure bearing clearance
- Color coded by size
- Put a piece on rod or main bearing and torque the cap
- Remove and inspect – width of crushed Plastigage shows clearance
- Use at the workbench or in the vehicle
- 10 per pack

Clearance Range	Jobber	Order No.
.001" to .003" (.025 to .076mm)	\$25.79	PG-GREEN
.002" to .006" (.051 to .152mm)	25.79	PG-RED
.004" to .009" (.102 to .229mm)	25.79	PG-BLUE
10pk. Assortment : 5 Green, 3 Red, 2 Blue	25.79	PG-10PK



Stroke Checker

- Accurately measure strokes up to 6"
- Works with any precision caliper to accurately measure crankshaft strokes
- Measures strokes up to 6" with an accuracy of .001"
- Rigid, hard-anodized aluminum frame is fully adjustable
- Fits almost any crankshaft
- Order No. **CSG-1** Jobber \$211.99



Caliper sold separately

See page 127 for our selection of calipers

CLEANING,
ASSEMBLY & SAFETY

SHORT BLOCK
REBUILDING

Heavy Duty Steel Stamps

- For hard materials
- Order in sets



Number Sets			
Figure	Shank	Jobber	Order No.
1/8"	5/16"	\$53.99	SFH-1/8
3/16"	3/8"	59.99	SFH-3/16

Special and custom orders are available, call 1-800-533-8010

CRANKSHAFT/
FLYWHEEL GRINDING

Crank Welding Plug Rods

- 3 diameters available
- Each rod is 12½" long and cuts off easily
- Sharpen ends with your existing pencil sharpener
- 5 Crank Welding Plug Rods per pack

Size	Jobber	Order No.
.250"	\$17.99	CWPR-250
.312"	17.99	CWPR-312
.375"	18.99	CWPR-375



MISCELLANEOUS
TOOLS & SUPPLIES

Sanding, Grinding, Polishing Belts Made to Order In-House

To provide you better service and save you money, Goodson bought an abrasive converting company in 2017. Since then, we've added equipment and personnel and we're cranking out abrasive belts for a wide range of industries. **Abrasive Industrial Supplies** is operated as a division of Goodson and our feet are still firmly placed in the automotive market.

Almost every abrasive belt shown in the Goodson catalog is manufactured by **Abrasive Industrial Supplies (AIS)** but that's just the beginning. We know you use belts on machines other than cylinder head resurfacers and crankshaft polishers and we're ready to meet those supply needs too.

Contact your Customer Service Representative today to get current pricing. Have AIS make something great for you!

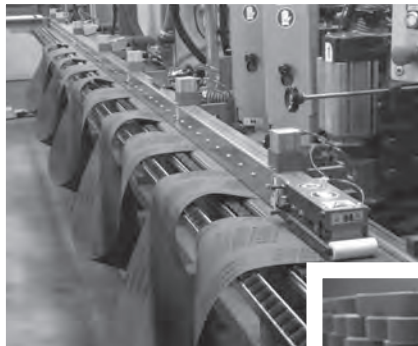

Abrasive Industrial Supplies
A Division of Goodson Manufacturing

MEASURING
TOOLS

BRAKE SERVICE
TOOLING

V-TWIN & METRIC
HARD PARTS

Crankshaft Polishing

Crankshaft Polishing Starter Kit

Includes 1 each of:

- Grind Aid,
- Polishing Rouge,
- Abrasive Dresser and
- 5-Pack of our most popular 72" belts
- Order No. **CP-KIT** Jobber \$66.99

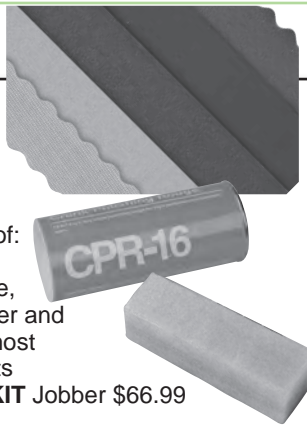

Grind Aid

- Cools and lubricates
- Reduces loading-up and grain fracturing
- Belts produce a better finish and last up to twice as long
- Use only on cloth-back belts such as those shown on pages 108 & 109
- Order No. **GRA-10** Jobber \$19.99



Polishing Rouge

- Produces high luster finish
- Use with light pressure, for cork or fine grit polishing to finish crank journals perfectly
- Hard, dry compound becomes viscous with heat
- White • 16 oz. / 454 g
- Order No. **CPR-16** Jobber \$14.99



Natural Rubber Abrasive Belt Dresser

- Prolongs belt life
- Hold at 45° angle on moving belt to remove foreign material
- Restores cutting ability of grains
- 2" x 2" x 4" / 51 x 51 x 102mm
- Order No. **ACB-224** Jobber \$10.49

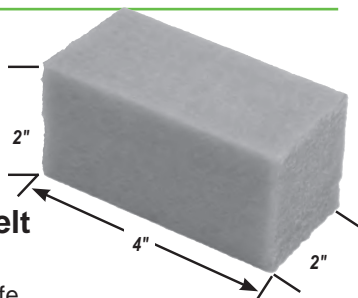

Check out the Crankshaft Polisher in action! Scan the code below with the camera on your smart phone or other smart device to see the **Crankshaft Polishing** episode of **Tech Lab Tuesday**.



dimensional shipping

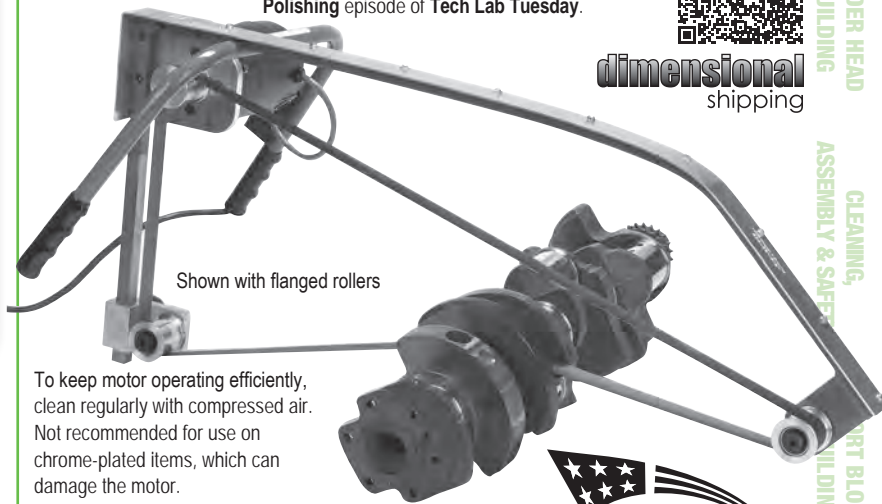

Shown with flanged rollers

To keep motor operating efficiently, clean regularly with compressed air. Not recommended for use on chrome-plated items, which can damage the motor.

Includes a sample pack of our most popular 72" Belts (PCP-72PAK)

made in America

tech tips from the techxperts™

Extend the life of your polishing belts by releasing the tension when not in use.



PCP-2S



PCP-2D



PCP-2



PCP-2-EA



PCP-2F

Adjustable 110V Crankshaft Polisher

- Adjusts to accommodate 60" to 72"L belts
- Flex resistant steel frame
- Weighs 15 lbs. (6.8 kg)
- Crowned rollers keep snug belt running true
- 1" nominal = 1.625" • 2" nominal = 2.625"
- 1/2 HP motor designed for high RPM not heavy loads
- Specify flanged or unflanged rollers when ordering
- 110V, 60Hz Motor

Roller Width		HP	Max. RPM	Jobber	Order No.		
Nominal	Actual						
1"/25mm	1.625"/41mm	1/2	10,000	\$1399.99	PCP-1072		
2"/51mm	2.625"/67mm	1/2	10,000	1449.99	PCP-1072-2		
Replacement Parts and Rollers						Includes	
Flanged Roller Sets (3 piece set)	1"			\$189.99	PCP-1		▼
Unflanged Roller Sets (3 piece set)	1"			234.99	PCP-2		▼
Flanged Drive Roller	1"			214.99	PCP-1S		▼
Fits 3/8" shaft - 1 ea.	2"			224.99	PCP-2S		▼
Flanged Roller Assembly 3/8" x 16 thread - 1 ea.	1"			63.99	PCP-1D	1	1
Unflanged Roller Assembly 3/8" x 16 thread - 1 ea.	2"			68.99	PCP-2D	1	1
Bearing - 1 ea.	1"			75.99	PCP-1F		2
Replacement Switch	2"			87.99	PCP-2F		2
Flanged Roller Assembly 3/8" x 16 thread - 1 ea.	1"			91.99	PCP-1-1EA	2	
Unflanged Roller Assembly 3/8" x 16 thread - 1 ea.	2"			87.99	PCP-2-EA	2	
Bearing - 1 ea.				16.49	PCP-BRG		
Replacement Motor (round housing)				29.99	PCP-SWITCH-72		
Replacement Motor (square housing)				839.99	PCP-MOTOR-RS		
Retrofit Motor Adaptor (round to square housing)				85.99	PCP-RFK		
Retrofit Motor Adaptor (square to round housing)				87.99	PCP-RFK2		
Replacement Motor Brush Set (1 Pair)				39.99	PCP-BRUSH-72		

CYLINDER HEAD REBUILDING
CLEANING, PART BLOCK BUILDING
FLYWHEEL GRINDING
CRANKSHAFT/ MISC. TOOLS & SUPPLIES
MISCELLANEOUS TOOLS & SUPPLIES
BRAKE SERVICE TOOLING
MEASURING TOOLS
V-TWIN & METRIC HARD PARTS

full service ...fast



"We make most of our abrasive belts in-house now. If you need a different size belt than you see in the catalog, give us a call. Let us make a custom belt for you."

- Justin, Abrasive Industrial Supplies Belt Technician, 1 year of service



Watch the Tech Lab Tuesday video in which we explain why we offer so many crank polishing belts.

Scan the code below with your smart phone or other smart device for instant access to the video.



Micro Finish Scotch-Brite Style Abrasive Rolls



- Ideal for hand polishing of high-performance crankshafts
- Non-directional polish
- Won't remove material
- Aluminum oxide abrasive
- Measures: ¾" x 10' • 1 Per Box
- Order No. **GFR-750** Jobber \$39.99

Premium Ceramic Micro Polishing Belts

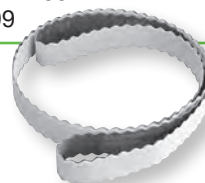

- Use with Polishing rouge to achieve high luster finish
- Structured Abrasive • 5 per box

Size (LxW)	Jobber	Order No.
60" x 1"	\$52.99	GSW-60x1
64" x 1"	54.99	GSW-64x1
72" x 1"	58.99	GSW-72x1
77" x 1"	71.99	GSW-77x1
Polishing Rouge	14.99	CPR-16

Crankshaft Polishing Belt Sample Pack

These sample packs include our most popular belts. Contents may vary.

Long	Wide	Qty.	Jobber	Order No.
64"	1"	5	\$21.99	PCP-64PAK
72"	1"	5	21.99	PCP-72PAK
72"	2"	2	21.99	PCP-72PAK-2

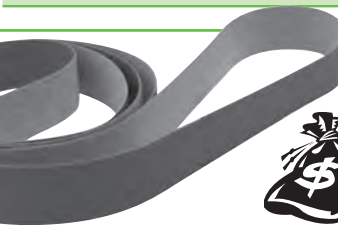

Blue 800 Grit Crankshaft Polishing Belts With Scrum Back

- Film substrate with aluminum-oxide abrasive
- 10 belts per box
- High quality joint with scrum back
- Highly flexible and long lasting

Size	Jobber	Order No.
60" x ¾"	\$38.99	BF-60X3/4X800
60" x 1"	39.99	BF-60X1X800
64" x ¾"	37.99	BF-64X3/4X800
64" x 1"	59.99	BF-64X1X800
72" x ¾"	54.99	BF-72X3/4X800
72" x 1"	64.99	BF-72X1X800
77" x 1"	69.99	BF-77X1X800

240 to 600 Grit Premium Ruby Aluminum-Oxide Crankshaft Polishing Belts

- Ruby Aluminum-Oxide abrasive specifically for use on metal
- Closed coat J-weight cloth backing with high strength joint
- Phenolic resin-over-resin bond
- Polish better and outlast other standard polishing belts
- Color may vary due to manufacturing process

SAVE 10% off jobber! 
Order 5 or more boxes of crank polishing belts (any combination)

		STRAIGHT-EDGE (10 per box)					
L	W	Jobber 1+	Jobber 5+	240 Grit	320 Grit	400 Grit	600 Grit
60"	¾"	\$29.99	\$26.99	R60x¾x240	R60x¾x320	R60x¾x400	R60x¾x600
	1"	32.99	29.69	R60x1x240	R60x1x320	R60x1x400	R60x1x600
	2"	41.99	37.79			R60x2x400	
64"	¾"	31.99	28.79	R64x¾x240	R64x¾x320	R64x¾x400	R64x¾x600
	1"	33.99	30.59	R64x1x240	R64x1x320	R64x1x400	R64x1x600
	1¼"	35.99	32.39		R64x1¼x320	R64x1¼x400	R64x1¼x600
	1½"	37.99	34.19	R64x1½x240		R64x1½x400	R64x1½x600
	1¾"	39.99	35.99	R64x1¾x240	R64x1¾x320		
72"	¾"	31.99	28.79	R72x¾x240	R72x¾x320	R72x¾x400	R72x¾x600
	1"	34.99	31.49	R72x1x240	R72x1x320	R72x1x400	R72x1x600
	1¼"	36.99	33.29	R72x1¼x240	R72x1¼x320	R72x1¼x400	R72x1¼x600
	1½"	39.99	35.99		R72x1½x320	R72x1½x400	R72x1½x600
	1¾"	42.99	38.69	R72x1¾x240	R72x1¾x320	R72x1¾x400	R72x1¾x600
77"	¾"	45.99	41.39	R72x2x240	R72x2x320	R72x2x400	R72x2x600
	1"	36.99	33.29		R77x1x320	R77x1x400	R77x1x600
	1¼"	38.99	35.09			R77x1¼x400	
	1½"	41.99	37.79			R77x1½x400	
	2"	47.99	43.19		R77x2x320	R77x2x400	R77x2x600

All abrasives are guaranteed for 1 year from the original purchase date

Need a size not listed in the chart? We can do that!

Goodson division, Abrasive Industrial Supplies, makes abrasive belts to order. Whether you're looking for other sizes of polishing belts or you need something to fit a grinder in your shop, they're available. Check out www.AbrasiveIndustrialSupplies.com or ask your customer service representative for more information.



3M™ Trizact™ Crankshaft Polishing Belts



- X-Weight cloth belt • A45 micron – equivalent to 400 grit
- Structured abrasive grains are perfectly shaped pyramids bonded at equal spacing to a high-strength polyester backing • Uniform wear for better performance and long life • Produce a high-luster finish • 5 per box

Size	Jobber	Order No.
64" L x 1" W	\$58.99	GSA-64x1
72" L x 1" W	63.99	GSA-72x1

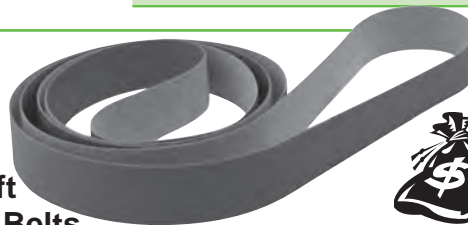

Crankshaft Polishing Belts

SAVE 10% off jobber!

Order 5 or more boxes of crank polishing belts (any combination)



10 Belts Per Box

240, 320 & 400 Grit Standard Polishing Belts

- US CAMI Grade aluminum-oxide abrasive
- 2-layer glue bond • Fast break-in
- Use with Polishing Rouge (CPR-16) for better finish
- Highly flexible J-Weight cloth backing
- Less aggressive belts for polishing

STANDARD STRAIGHT-EDGE (10 per box)					
Lgth	Width	Jobber	240 grit	320 grit	400 grit
60"	3/4"	\$28.99	60x3/4x240	60x3/4x320	60x3/4x400
	1"	29.99	60x1x240	60x1x320	60x1x400
	1 1/4"	35.99		60x1 1/4x320	
64"	3/4"	27.99	64x3/4x240	64x3/4x320	64x3/4x400
	1"	37.99	64x1x240	64x1x320	64x1x400
	1 1/4"	36.99		64x1 1/4x320	
	1 1/2"	38.99	64x1 1/2x240	64x1 1/2x320	
	1 3/4"	40.99		64x1 3/4x320	
70"	2"	42.99	64x2x240	64x2x320	64x2x400
	3/4"	33.99		70x3/4x320	
	1"	35.99	70x1x240	70x1x320	70x1x400
	1 1/4"	37.99			70x1 1/4x400
72"	1 1/2"	39.99			70x1 1/2x400
	3/4"	32.99	72x3/4x240	72x3/4x320	72x3/4x400
	1"	37.99	72x1x240	72x1x320	72x1x400
	1 1/4"	38.99	72x1 1/4x240	72x1 1/4x320	
	1 1/2"	40.99	72x1 1/2x240	72x1 1/2x320	72x1 1/2x400
77"	1 3/4"	42.99	72x1 3/4x240		
	2"	44.99	72x2x240	72x2x320	72x2x400
	3/4"	36.99		77x3/4x320	77x3/4x400
	1"	38.99	77x1x240	77x1x320	77x1x400
	1 1/2"	42.99		77x1 1/2x320	
1 3/4"	44.99			77x1 3/4x400	
2"	46.99	77x2x240	77x2x320		

All abrasives are guaranteed for 1 year from the original purchase date

Need a size not listed in the chart? We can do that!

Goodson division, Abrasive Industrial Supplies, makes abrasive belts to order. Whether you're looking for other sizes of polishing belts or you need something to fit a grinder in your shop, they're available. Check out www.AbrasiveIndustrialSupplies.com or ask your customer service representative for more information.

Standard Scalloped Edge Crankshaft Polishing Belts

- 10 per box • 320 grit • 1" wide
- Ideal for radius polishing
- Double layer urea glue bond CAMI grade polishing belts

Length	Jobber 1+	Jobber 5+	Order No.
64"	\$43.99	\$39.59	S64x1x320
72"	46.99	42.299	S72x1x320



Fine Finish

- Gold Aluminum-oxide • Flexible, woven blue backing • **Very** aggressive
- Phenolic Resin-Over-Resin bond
- Sharper grains cut faster without sacrificing finish • Use with Grind Aid (GRA-10) or Polishing Rouge (CPR-16) for cooler polishing or grinding



Custom Belt Sizes Available

Fine Finish (10 per box)

Length	Width	Jobber	320 grit	Jobber	400 grit
60"	1"	\$39.99	G-60x1x320	\$39.99	G-60x1x400
64"	1"	41.99	G-64x1x320	41.99	G-64x1x400
72"	1"	44.99	G-72x1x320	44.99	G-72x1x400
77"	1"	47.99	G-77x1x320	47.99	G-77x1x400

Scotch-Brite Style Micro Finish

- Rigid, 3-dimensional back • Resin bond • Aluminum-oxide abrasive • Non-directional Satin finish
- Use with Grind Aid (GRA-10)



Micro-Finish (1 per box)

Length	Width	Jobber	Order No.
60"	3/4"	\$27.99	GFB-60 x 3/4
	1"	31.99	GFB-60 x 1
64"	3/4"	32.99	GFB-64 x 3/4
	1"	33.99	GFB-64 x 1
70"	3/4"	32.99	GFB-70 x 3/4
	1"	33.99	GFB-70 x 1
72"	3/4"	34.99	GFB-72 x 3/4
	1"	35.99	GFB-72 x 1
77"	1"	36.99	GFB-77 x 1
	91"	1"	41.99

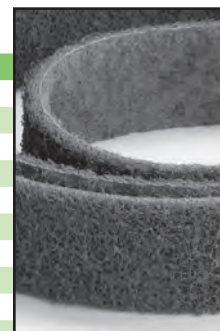

Scotch-Brite Style Super-Micro Finish

- Produces a mirror-like non-directional finish
- Resin bond • Silicon-Carbide abrasive
- For final Satin finish • Use with Grind Aid (GRA-10)



Super-Micro Finish (1 per box)

Length	Width	Jobber	Order No.
60"	3/4"	\$28.99	SGFB-60 x 3/4
	1"	28.99	SGFB-60 x 1
64"	3/4"	29.99	SGFB-64 x 3/4
	1"	29.99	SGFB-64 x 1
70"	3/4"	30.99	SGFB-70 x 3/4
	1"	30.99	SGFB-70 x 1
72"	3/4"	31.99	SGFB-72 x 3/4
	1"	31.99	SGFB-72 x 1
77"	3/4"	32.99	SGFB-77 x 3/4
	1"	32.99	SGFB-77 x 1

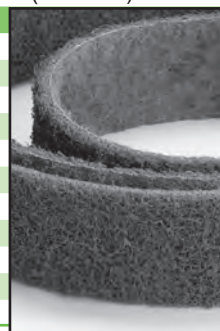

800 Grit Abrasive Cork Super-Fine Finish

- Won't disturb polished radii
- Silicon-carbide • Use with Polishing Rouge (CPR-16) for High Luster finish



Abrasive Cork (1 per box)

Length	Width	Jobber	Order No.
64"	3/4"	\$14.99	CPB-64-3/4
	1"	14.99	CPB-64-1
70"	3/4"	14.99	CPB-70-3/4
	1"	14.99	CPB-70-1
72"	3/4"	14.99	CPB-72-3/4
	1"	14.99	CPB-72-1
77"	3/4"	14.99	CPB-77-3/4
	1"	14.99	CPB-77-1



Need A Size You Don't See? Give Us A Call; We Make Most Belts In-House!

... another satisfied customer



"Goodson was able to help me select the right grinding stones for our racing clutch and flywheel program. Their support and technical advice is always available to keep our program on the right track."

- Johnny Ahten, Johnny Ahten Racing - Goodson customers since 2005

CYLINDER HEAD REBUILDING

CLEANING, ASSEMBLY & SAFETY

SHORT BLOCK REBUILDING

CRANKSHAFT/ FLYWHEEL GRINDING

MISCELLANEOUS TOOLS & SUPPLIES

TOOLING

MEASURING TOOLS

V-TWIN & METRIC HARD PARTS

Flywheel Radius Cutter Tip Holder

- For Winona Van Norman/ Van Norman FG-5000
- Holder measures 1.5"L with a .312" dia. shank
- Includes 1 indexable FG-3B cutter tip

Description	Jobber 1+	Jobber 10+	Order No.
Tip Holder	\$154.99		FG-5011
Replacement Tip	14.49	13.04 ea.	FG-3B

FG-3B

Order 10 or more, take 10% off jobber!

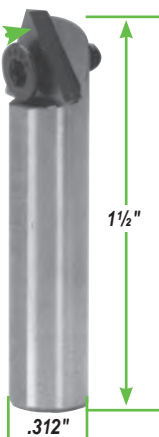

Flywheel Grinding Coolant

- Formula eliminates rancid coolant
- Synthetic inhibitors
- Dilute 30:1 (water:coolant)

Size	Jobber	Order No.
1 Gal. / 3.78L	\$ 48.99	FG-1101-G
5 Gal. / 18.8L	189.99	FG-1102-G



Order 5 or more, take 10% off jobber!

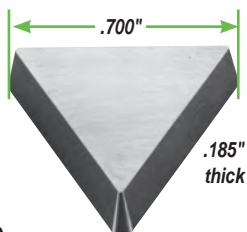

Flywheel Cutter Tip For Winona Van Norman 570 Rotary Broach

- 3-edge carbide cutting tip for use with the special flywheel attachment
- Order VN-FW Jobber \$21.99 each
- Order 5+, Jobber \$19.79

Flywheel Depth Gauge with Dial Indicator

- Measure flywheel before and after grinding to maintain proper depth specifications
- Gauge Assembly includes Dial Indicator, Bar & Magnets
- Spindle Extensions sold separately

Description	Jobber	Order No.
Gauge Assembly	\$149.99	FGG-12
Spindle 1.5"	15.99	DIS-1.5
Extensions 2.5"	14.99	DIS-2.5
3.0"	19.99	DIS-3.0

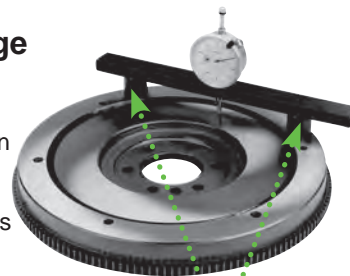

Magnetic feet adjust to flywheel diameter

Flywheel Grinder Bolt Adaptors

- Replace shoulder bolts with standard hardware
- Low-cost adaptor converts any 1/2" or 7/16" bolt to a 3/4" ID
- Includes countersunk adaptor with bolts for extra clearance



FG-LOCK

Fits	Size	Jobber	Order No.
DCM, Peterson, KW	1/2" x 13	\$36.99	FG-DCP-KIT
WVN	7/16" x 14	36.99	FG-AB-KIT
WVN Table Insert	OD: 5/8" x 11, ID: 7/16" x 14	7.99	FG-LOCK

Flywheel Grinder Table Lubricant

- Extend flywheel grinder life
- High pressure oil designed to lubricate table bearings and ways
- For all makes of flywheel grinders
- 1 Gal. (3.78L)
- Order No. FG-1131-G
- Jobber \$47.99



Grinding Wheel Dressers & Replacement Cutters

Diamond Dresser Tools are available on pages 114-115

Applications	Cutter Assemblies				Replacement Cutters						
	OD	W	Jobber	Order No.	Pieces	Washers	OD	ID	Thick	Jobber	Order No.
Peterson (12mm shaft)					8 stars	3	2.375"	1.50"	.093"	\$30.99	GS-17
						1 w/locking tangs	1.75"	1.50"	.060"		
WVN SM2000, 4000, 5000, 6000C, 6000A, MG3000, 3850	1.250"	.978"	\$32.99	FG-1165-G	7 stars	none	1.25"	0.313"	.095"	9.49	FG-1161-G
Peterson & DCM	2.375"	2.262"	87.99	FG-1070A-G	5 stars		2.375"	1.132"	.1375"	19.99	FG-1070-G
Hand held			58.99	FG-1045-G	1 stone	none	1.50"	0.313"	.6250"	15.49	FG-1044-G
Desmond Dresser for wheels to 10"			28.99	GS-0	4 blades, 2 spacers			0.250"		9.49	GS-00
					4 blades, 2 spacers			0.500"		10.49	GS-11

Crankshaft & Flywheel Tools



Petroleum Based Valve Lapping Compound

- Silicon-carbide, grease-based compound
- Petroleum based valve lapping compound facilitates precise mating between valve seats and valves
- Use with any powered or manual valve lapping tools
- The higher the number, the finer the grit

Size	Grit	Jobber	Order No.
2 oz. / 56.7g	400 Grit	\$16.99	VLC-2-400
	600 Grit	20.99	VLC-2-600
	800 Grit	20.99	VLC-2-800
	1200 Grit	22.99	VLC-2-1200

More lapping compounds on page 17

tech tips

from the techxperts™

Put a dab of valve lapping compound on a dowel pin that just won't come out, then use your puller to extract it. The grit in the lapping compound gives you more grip so you can successfully pull stubborn dowels.

Pin Pal Puller

- Remove dowels fast
- Adjusts to pull all sizes of dowels
- Locking pliers with special hardened jaws hold firm while 4 lb. slide hammer forces dowels out
- Also pulls pressed-in hollow tubes or frozen shafts
- Rugged steel construction

Description	Jobber	Order No.
Complete Tool	\$429.99	GA-300
Replacement Jaws	124.99	GA-300E-R



Mirrored Safety Glasses

- Wrap-around design
- Tinted lenses provide sun glare protection
- Universal bridge
- Polycarbonate lenses
- Do not use as welders helpers
- Order No. PGL-21 Jobber \$6.99

Heavy Metal

An essential component when balancing rods & pistons to crankshafts to ensure proper engine operation. Contains 90% Tungsten



HEAVY METAL - TUNGSTEN 90%

Hole in	Press Fit + in/mm	1.0" Long Grams	Jobber	Order No.	1.2" Long Grams	Jobber	Order No.
1/2"	.002"/.05	57	\$25.99	HM-57	65	\$34.99	HM-72
3/4"	.002"/.05	122	31.99	HM-122	147	37.99	HM-162
7/8"	.002"/.05	169	42.99	HM-169	198	49.99	HM-198
1"	.002"/.05	227	56.99	HM-227	265	64.99	HM-265

NOTE: Due to market fluctuations, heavy metal prices are subject to change without notice. Please confirm pricing when ordering.

tech tips

from the techxperts™

It is essential, when pulling a dowel, that the tightening sleeve is installed with the flared end toward the collet. This will allow the tightening sleeve to slide over the collet, locking it to the dowel you are removing. Also, be sure to select the correct collet size for the dowel you are removing.



video available
Scan the code below on your smart phone or other smart device to watch our How-To video on Dowel Pulling.



Dowel Puller and Collets

- Slide hammer action removes stubborn dowels
- Use on blocks, heads, flywheels, etc.
- Split collets grip firmly without causing damage
- A high-quality tool that lets you reuse dowel pins
- Choose from SAE or Metric kits
- All items also sold separately

Description	Jobber	Order No.	Incl.
Standard Kit	\$219.99	GA-600	▼
Metric Kit	219.99	GA-600M	▼
Slide Shaft (14" L)	19.99	GAO-1	x x
Slide Hammer	39.99	GAO-2	x x
Tightening Sleeve	39.99	GAO-3	x x
Gripping Collets			
OD	ID	mm	
1"	.1575"	4.00	\$39.99 GAO-22 x
1"	.1875"	4.76	39.99 GAO-4
1"	.1969"	5.00	39.99 GAO-13 x
1"	.2362"	6.00	39.99 GAO-14 x
1"	.2500"	6.35	39.99 GAO-5 x
1"	.2756"	7.00	39.99 GAO-26
1"	.3125"	7.94	39.99 GAO-6 x
1"	.3150"	8.00	39.99 GAO-10 x
1"	.3750"	9.53	39.99 GAO-7 x
1"	.3937"	10.00	39.99 GAO-23
1"	.4375"	11.11	39.99 GAO-8 x
1"	.4724"	12.00	39.99 GAO-24
1"	.5000"	12.70	39.99 GAO-9
1"	.6250"	15.88	39.99 GAO-20
Removal Basin	39.99	GAO-21	x x

Parts are stamped for easy identification & reordering

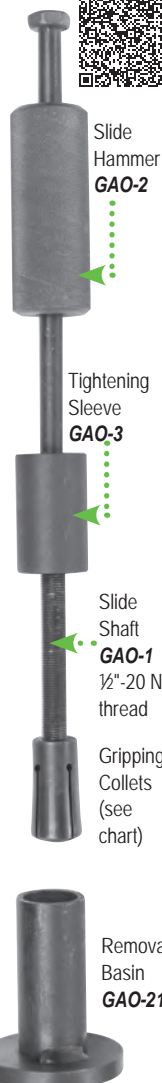

CYLINDER HEAD
REBUILDING

CLEANING,
ASSEMBLY & SAFETY

SHORT BLOCK
REBUILDING

CRANKSHAFT/
FLYWHEEL, GRINDING

MISCELLANEOUS
TOOLS & SUPPLIES

BRAKE SERVICE
TOOLING

MEASURING
TOOLS

V-TWIN & METRIC
HARD PARTS



"Every Goodson crankshaft grinding wheel is made-to-order. We ensure every wheel is checked and double checked for accuracy."

- Dylan, Goodson Production, 1 year of service

video available Goodson carries a wide selection of flywheel grinding stones. Watch as we unpack the reasons why in our **Tech Lab Tuesday** video "Choosing the Right Flywheel Stone." Scan the code at right with your smart phone or other smart device for instant access.



Coolant on pages 74 and 110

CYLINDER HEAD
REBUILDING

CLEANING,
ASSEMBLY & SAFETY

SHORT BLOCK
REBUILDING

CRANKSHAFT/
FLYWHEEL GRINDING

MISCELLANEOUS
TOOLS & SUPPLIES

BRAKE SERVICE
TOOLING

MEASURING
TOOLS

V-TWIN & METRIC
HARD PARTS

For Best Results... Choose The Right Flywheel Stone From Goodson

Goodson stones feature 50% more usable abrasive and much stronger construction, yet sell at prices comparable to ordinary stones. With Goodson stones you'll get longer wheel life and lower-cost flywheel grinding.

Cast Iron:

Cast Iron (soft) flywheels need to be ground with harder stones. Experiment to find the best stone. A starting point is the FGW-57, our best all-around stone for Cast Iron.

Cast Steel:

Cast Steel (medium) flywheels require medium-hard stones. The FGW-65 is our best all-around stone for Cast Steel.

Billet Steel:

Billet Steel (very hard) flywheels need to be ground with softer stones. Our best all-around stone for Billet Steel is the FGW-50-2. It's our most friable and free-cutting, requiring minimal dressing.

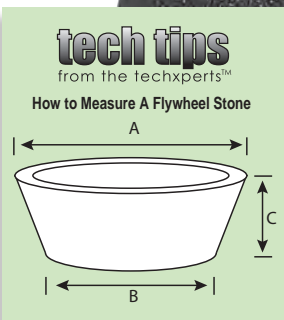

tech tips from the techxperts™ Be sure to use ample coolant to flush away swarf and help the stones perform better.

Silicon-Carbide Abrasive

CAST IRON (Passenger cars, light trucks)

A	B	C	Arbor	Description	Jobber 1+	Jobber 5+	Order No.
6"	4½"	2½"	1¼"	Harder than FGW-57, lasts longer, black	\$ 61.99	\$ 55.79	FGW-67
6"	4½"	2½"	1¼"	Best all-around for cast iron, black	61.99	55.79	FGW-57
6"	—	2½"	1¼"	Straight-sided FGW-57, black	59.99	53.99	FGW-57S
6"	4½"	2½"	1¼"	Softer than FGW-57, grinds faster, black	61.99	55.79	FGW-47
6"	4¾"	2½"	1¼"	Silicon-carbide, ideal for top fuel, black	61.99	55.79	FGW-37
6"	4¾"	2½"	1¼"	Silicon-carbide, softer, finer grit than FGW-37	59.99	53.99	FGW-37F
4"	3"	2"	1¼"	Small diameter FGW-57, black	124.99	112.49	FGW-61
4"	3"	2"	1¼"	Small diameter FGW-37, black	34.99	31.49	FGW-374
3"	—	2"	1¼"	Straight-sided green silicon-carbide, premium	41.99	37.79	FGW-93

Silicon-Carbide/Aluminum-Oxide Combination

CAST STEEL (Industrial, agricultural, OTR trucks)

A	B	C	Arbor	Description	Jobber 1+	Jobber 5+	Order No.
6"	4½"	2"	1¼"	Harder than FGW-65 lasts longer, lt. gray	\$ 94.99	\$ 85.49	FGW-53
6"	4½"	2½"	1¼"	Best all-around for Cast Steel, speckled	159.99	143.99	FGW-65
6"	4½"	2½"	1¼"	Slightly softer than FGW-65, black	61.99	55.79	FGW-49S
4"	3"	2"	1¼"	Small diameter FGW-65, speckled	68.99	62.09	FGW-69
6"	4½"	2½"	1¼"	Softer than FGW-65, grinds faster, black	134.99	121.49	FGW-49

Aluminum-Oxide Abrasive

BILLET STEEL (Import vehicles, high-performance)

A	B	C	Arbor	Description	Jobber 1+	Jobber 5+	Order No.
6"	4½"	2½"	1¼"	Harder, ruby stone, lasts longer	\$134.99	\$121.49	FGW-64
6"	4½"	2½"	1¼"	Harder, pink stone, lasts longer	144.99	130.49	FGW-62-1
6"	4½"	2½"	1¼"	Harder than FGW-50-2	114.99	103.49	FGW-50
6"	4½"	2½"	1¼"	Best all-around for Billet Steel	121.99	109.79	FGW-50-2
4"	3½"	1½"	1¼"	Harder, pink stone, lasts longer	64.99	58.49	FGW-63-1
4"	3"	2"	1¼"	Taller than FGW-56, more abrasive, white	79.99	71.99	FGW-306
4"	3½"	1½"	1¼"	Premium	46.99	42.29	FGW-56P
4"	3½"	1½"	1¼"	Small diameter, off white	47.99	43.19	FGW-56
3"	2¼"	1¼"	¾"	Small diameter, light gray	43.99	39.59	FGW-59
3"	—	2"	1¼"	Straight-sided sugar white stone	47.99	43.19	FGW-92

NOTE: Due to manufacturing process, colors may vary.

All abrasives are guaranteed for 1 year from original purchase date.

10% off jobber! Order 5 or more flywheel grinding stones (any combination)



Mounting Adaptor For Small Diameter Stones

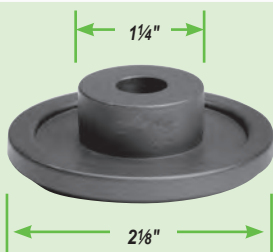

- Many flywheel grinders have lower mounting flanges that won't fit inside 3" and 4" diameter flared-cup stones
- Use this adaptor to avoid damage when mounting small stones
- Fits most small diameter stones
- Order No. **FG-FLANGE** Jobber \$52.99

tech tips

from the techxperts™

Use a 3/8" Cap Screw & Washer to mount 2" & 3" Diameter CBN Flywheel Grinding Wheels to Your Flywheel Grinder



FlyMaster® CBN Super Abrasive Flywheel Grinding Wheels

• For cast iron • Light to heavy applications

A	B	C	Arbor	Shape	Grit	Jobber 1+	Jobber 5+	Order No.
2"	2"	0.4"	3/8"	Straight	100	\$236.99	\$213.29	CBN-200
3"	3"	0.4"	3/8"	Straight	100	254.99	229.49	CBN-300
2"	1 3/8"	7/8"	3/8"	Cup	100	189.99	170.99	2H0998
3"	2"	1 1/4"	1 1/4"	Cup	100	299.99	269.99	261453
3 3/4"	2 5/8"	1 1/2"	1 1/4"	Cup	100	259.99	233.99	2371052
3 3/4"	2 5/8"	1 1/2"	1 1/4"	Cup	60	234.99	211.49	34296362
5"	3 3/4"	1 3/4"	1 1/4"	Cup	100	304.99	274.49	2379270
6"	4 5/8"	1 5/8"	1 1/4"	Cup	100	257.99	232.19	2367275*
6"	4 5/8"	1 5/8"	1 1/4"	Cup	60	299.99	269.99	2G7480
CBN Dressing Stick 1/2" x 1/2" x 6"						19.99		DS-CBN

*Most popular application

Order 5 or more Flywheel Grinding Stones (any combination) and SAVE 10% off Jobber



Flywheel Grinding Stones

• Four Abrasive formulas to choose from

SILICON-CARBIDE ABRASIVE

Ductile Iron, Cast Iron & Steel (Black)

A	B	C	Arbor	Hardness	Shape	Jobber 1+	Jobber 5+	Order No.
3"	2 1/2"	1 1/2"	1 1/4"	Med. Hard	Flared	\$49.99	\$44.99	U364512
4"	3"	2"	1 1/4"	Med. Soft	Flared	96.99	87.29	U335369
6"	4 1/2"	2 1/2"	1 1/4"	Med. Soft	Flared	69.99	62.99	U324495
6"	4 1/2"	2 1/2"	1 1/4"	Med. Hard	Flared	63.99	57.59	U335376
6"	4 1/2"	2 1/2"	1 1/4"	Hard	Flared	61.99	55.79	U335377
6"	4 1/2"	2 1/2"	1 1/4"	Med. Soft	Flared	62.99	56.69	U357854
6"	4 1/2"	2 1/2"	1 1/4"	Med. Hard	Flared	83.99	75.59	U343805

EXTENDED LIFE CERAMIC

Ductile Iron, Cast Iron and Steel (Black)

A	B	C	Arbor	Hardness	Shape	Jobber 1+	Jobber 5+	Order No.
6"	4 1/2"	3"	1 1/4"	Med. Hard	Flared	\$144.99	\$130.49	U370095

ALUMINUM-OXIDE ABRASIVE

Mild Steel & Hardened Steel (White)

A	B	C	Arbor	Hardness	Shape	Jobber 1+	Jobber 5+	Order No.
6"	4 1/2"	2 1/2"	1 1/4"	Soft	Flared	\$129.99	\$116.99	F342636

ALUMINUM-OXIDE ABRASIVE

Light to Medium Stock Removal on Steel, Cast Iron & Ductile Iron (Ruby)

A	B	C	Arbor	Hardness	Shape	Jobber 1+	Jobber 5+	Order No.
4"	3"	2"	1 1/4"	Medium	Flared	\$84.99	\$76.49	F348769
6"	4 1/2"	2 1/2"	1 1/4"	Soft	Flared	68.99	62.09	F372039
6"	4 1/2"	2 1/2"	1 1/4"	Med. Soft	Flared	64.99	58.49	F348771
6"	4 1/2"	2 1/2"	1 1/4"	Medium	Flared	89.99	80.99	F348772
6"	4 1/2"	2 1/2"	1 1/4"	Hard	Flared	89.99	80.99	F348773

Colors may vary due to the manufacturing process

tech tips

from the techxperts™

How to Measure A Flywheel Stone

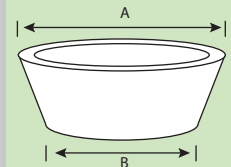

tech tips

from the techxperts™

Never dress your Superabrasive with the dresser attachment on your machine. Use our CBN dressing stick for best results.



Diamond Flywheel Grinding Wheel

- For hard, spray coated floaters and flywheels
- **Not for use on cast iron or steel flywheels**
- A = 6" | B = 4 5/8" | C = 1 7/8" | Arbor = 1 1/4"
- Order No. **2E5742** Jobber 1+ \$259.99
Jobber 5+ \$233.99



3/4" Thick Wall for Faster, More Aggressive Grinding

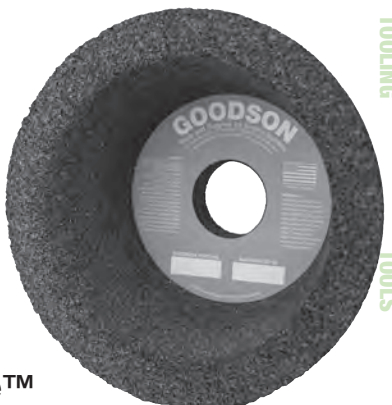

Big Brute™ Flywheel Grinding Stone

- Medium-Hard Silicon Carbide abrasive formula • Extra beefy for better grinding
- Measurements: A = 6" | B = 4 3/4" | C = 3" | Arbor = 1 1/4" (see graphic above)
- Order No. **U69693**
Jobber 1+ \$64.99 or Jobber 5+ \$58.49

CYLINDER HEAD REBUILDING
CLEANING, ASSEMBLY & SAFETY
SHORT BLOCK REBUILDING
CRANKSHAFT/FLYWHEEL GRINDING
MISCELLANEOUS TOOLS & SUPPLIES
BRAKE SERVICE TOOLING
MEASURING TOOLS
V-TWIN & METRIC HARD PARTS

Diamond Dresser Tools

shown at approximately full size

CYLINDER HEAD
REBUILDING

CLEANING,
ASSEMBLY & SAFETY

SHORT BLOCK
REBUILDING

CRANKSHAFT/
FLYWHEEL GRINDING

MISCELLANEOUS
TOOLS & SUPPLIES

BRAKE SERVICE
TOOLING

MEASURING
TOOLS

V-TWIN & METRIC
HARD PARTS



Diamond: Selected for very high point definition. A sharper diamond cuts faster and gives a superior finish.

Matrix: Matrix material is bronze or copper-based for a tight hold on the diamond & high heat transfer.

Holder: Cold rolled steel. Threaded types have precision threads over a long distance to screw easily into tool holders and support cutting point firmly to prevent vibration.

Diamonds are stamped for easy identification and re-ordering

Premium Diamond Resetting Service:

Send your worn premium diamonds to Goodson for fast resetting. Prices quoted upon request. Reset when wear facets exceed $\frac{1}{16}$ " on a $\frac{1}{2}$ to $\frac{3}{4}$ carat diamond and $\frac{1}{8}$ " on a 1 carat or larger.

Diamond Dresser Tools

Diamond Dressers for most shop machines are in stock and ready-to-ship



A diamond tool is only as good as the diamond itself. GOODSON diamonds are furnished by the most respected supplier in the U.S. Each is subjected to a microscopic examination by experts and must meet strict standards to be accepted. This rigorous inspection and careful control during manufacturing assures consistent high quality. Our diamond tools deliver the highest levels of performance and longevity.

In addition to our standard diamond tools, GOODSON stocks a wide selection of Premium Quality Diamonds. These diamonds last longer and improve wheel performance. They stay sharp longer and have more points so they can be reset more times. Because of this quality, they will dress harder wheels and wheels will need to be dressed less frequently. If you don't see the diamond you need in a premium quality, call 1-800-533-8010 for a special order.

	Machine	Description	Carat	Jobber	Standard	Jobber	Premium	
Valve Refacers	B&D, Skil, Sioux™, Thor, VanDorn, WVN	3/8" x 1 1/8"	1/5	\$ 46.49	G-1	\$ 89.99	G-1P	
	Kwik-Way, Tobin Arp (S&D)	5/16" x 2 1/2"	1/5	47.99	G-3	—	—	
	Kwik-Way, Valve Master (1714)	1/2" x 3 1/4" 20NF	1/5	49.99	G-4	—	—	
	Sioux™ (1713, 1715), IDL, WVN (CG50, CG80)	3/8" x 2 3/4" 24NF	1/5	49.99	G-5	89.99	G-5P	
	IDL, WVN (CG50, CG80)	3/8" x 3 1/4" 24NF	1/5	53.99	G-80	—	—	
	US	7/16" x 2"	1/5	49.99	G-6	—	—	
	Skil (Talent)	5/16" x 2 1/4" 18NC	1/5	49.99	G-9	—	—	
	Kwik-Way	7/16" x 2 3/4" 20NF	1/5	46.99	G-17	89.99	G-17P	
Valve Seat Grinders	B&D, S&D, Van Dorn	3/8" x 2 1/4" 24NF	1/5	49.99	G-2	—	—	
	Kwik-Way	1/2" x 3 1/4" 20NF	1/5	49.99	G-4	—	—	
	Sioux™ (1715), K-W (NSG), Thor	3/8" x 2 3/4" 24NF	1/5	49.99	G-5	89.99	G-5P	
	Hall HD (13-1938P), Skil, Snap-On, B&D	5/16" x 2 1/4" 24NF	1/5	51.99	G-8	87.99	G-8P	
	KO Lee, Skil	5/16" x 2 1/4" 18NC	1/5	49.99	G-9	—	—	
	Sioux™ Heavy Duty (1715B, 1719)	3/8" hex RH thread	1/5	69.99	G-11	—	—	
	Goodson Universal Wheel Dresser	8mm x 1.25mm	1/5	—	—	99.99	G-13P	
	Sioux™ Heavy Duty (1715A)	3/8" x 2 3/4" 24NF	1/2	89.99	G-15	—	—	
Clutch Grinders	Kwik-Way Heavy Duty Wheel Dresser	1/2" x 3" 20NF	1/5	49.99	G-18	84.99	G-18P	
	Lempco AC, NAC, VAC & Do-ALL	7/16" x 2"	1/5	49.99	G-6	—	—	
Piston Grinders	Van Norman 75, 76 & Relio	3/8" x 1 5/8"	1/5	46.49	G-1	89.99	G-1P	
	Storm-Vulcan D-3	7/16" x 2"	1/5	49.99	G-6	—	—	
Drum Lathes	Van Norman (all except 302, 302H)	3/8" x 1 5/8"	1/5	46.49	G-1	89.99	G-1P	
	Barret, V.N. 302, 302H	3/8" x 3"	1/5	47.99	G-1L	—	—	
	Lempco	7/16" x 2"	1/5	49.99	G-6	—	—	
	Ammco 5000	1/2" x 1 1/2"	1/5	49.99	G-19	—	—	
Rod Grinders	Sunnen® Rod & Cap Grinder (CRG-500)	3/8" x 1 5/8"	1/5	46.49	G-1	89.99	G-1P	
	Storm-Vulcan No. 65 Rod Grinder	1/2" x 3 1/4" 20NF	1/5	49.99	G-4	—	—	
Crank & Cam Grinders	Storm-Vulcan 14, 15, 15A, 15C, 75, 75A	1/2" x 3"	3/4	164.99	G-25	—	—	
		1/2" x 3"	1	219.99	G-25A	—	—	
	Scledum	10mm x 1 5/8"	3/4	164.99	G-27	—	—	
	Winona Van Norman/Zanrosso,	7/16" x 1 1/4", 5/8" head	3/4	164.99	G-30	—	—	
	Lempco, Landis	7/16" x 1 1/4", 5/8" head	1	234.99	G-30A	—	—	
	Berco	tapered, step type	1	239.99	G-32A	379.99	G-32AP	
	Berco	tapered, step type	1 1/2	394.99	G-32B	—	—	
	Storm-Vulcan, WVN CG210, 250, 280	1/2" x 2" 70° radius dress	3/4	297.99	G-33	—	—	
	Flywheel Grinder	Kwik-Way 796	7/16" x 2"	1/5	49.99	G-6	—	—

tech tips

from the techxperts™

- 1. Set tool at a proper angle.** Position at 10° to 15° from surface. Smaller angles blunt the diamond. Larger angles may cause the wheel to remove matrix material.
- 2. Prevent vibration in the holder.** Any looseness in the tool holder will allow vibration of the tool resulting in poor finish on the wheel.

- 3. Turn coolant on before dressing.** Wheels used wet should be dressed wet. To keep diamond cool, turn coolant on before starting to dress. (If wheel is dressed dry, air-cool diamond between cuts but don't quench with water.)
- 4. Start at highest point.** Wheels often wear unevenly & may have high & low spots. Set tool to dress high spots first, feed in about .001" per pass until done. This prevents overheating & damage.

- 5. Use steady travel.** Uneven travel causes an uneven finish. The best rate is found by experiment, but whatever the rate of travel, it must be even.
 - 6. Turn the tool in the holder.** Turn the tool often to expose new diamond surface to the wheel.
 - 7. Don't bump or drop diamond.** They are hard but brittle, and can be harmed if dropped or bumped.
- CAUTION: Grinding Wheel must never touch the matrix or holder.**

CYLINDER HEAD
REBUILDING
CLEANING,
ASSEMBLY & SAFETY
SHORT BLOCK
REBUILDING
FLYWHEEL GRINDING
CRANKSHAFT/
GRINDING
MISCELLANEOUS
TOOLS & SUPPLIES
BRAKE SERVICE
TOOLING
MEASURING
TOOLS
V-TWIN & METRIC
HARD PARTS



14mm Spark Plug Thread Chaser/Burnisher

- Ideal for spark plug hole cleaning
- Re-forms the original material by burnishing, not cutting, and won't create new chips to clean out
- Order No. **SPB-14** Jobber \$128.99

Burr Buster

- Use on air float tables, seat & guide machines, beds of crankshaft grinders and flywheel grinder tables
- Deburrs gasket surfaces on heads, blocks, manifolds, etc.
- 120 grit premium grade abrasive
- 1½" x 2¾" x 9"
- Order No. **BB-9** Jobber \$45.99



Premium Tapered Reamer

- Use by hand or with a powered driver to deburr or enlarge tapered holes for valve guides, bolt hole chamfering, and more • Degree of Taper: 2.86°
- Use in ½" chuck at approx. 40 RPM
- OAL: 5¾" • Flute Length: 3¾"
- Small End: 1/8" dia.
- Large End: 1/2" dia.
- Order No. **TR-216-1** Jobber \$41.99



Maxxeon® WorkStar® 364 USB Rechargeable UV Leak Detection Pen/Inspection Light

- 3.7V Lithium battery with USB charger
- Run time: 35 min. continuous, 2 hr. intermittent operation
- Use with Goodson Glow or Magnetic Crack Detection Oil (page 53) • Dust-tight, waterproof to 3 feet
- Easily adjustable beam to suit application
- Drop tested to 6 feet
- Order No. **DFL-364** Jobber \$49.99



Maxxeon® WorkStar® 360 Rechargeable LED Pen/Inspection Light

- No batteries to replace! Includes Micro USB charger
- 3X zoom provides 160 lumens on low
- 1X zoom provides 260 lumens on high
- 40 minute continuous or 2-hour intermittent operation
- Dust-tight, waterproof to 3 feet
- Drop tested to 6 feet
- Order No. **DFL-360** Jobber \$45.99

Maxxeon® WorkStar® 810 CYCLOPS Rechargeable LED Work Light

- Puts the light right where you need it • Drop tested to 6 feet
- LiPo battery with USB charger
- 3 light settings
- Magnetic base attaches the light to your machine
- Water resistant, do not immerse
- Order No. **DFL-810** Jobber \$42.99

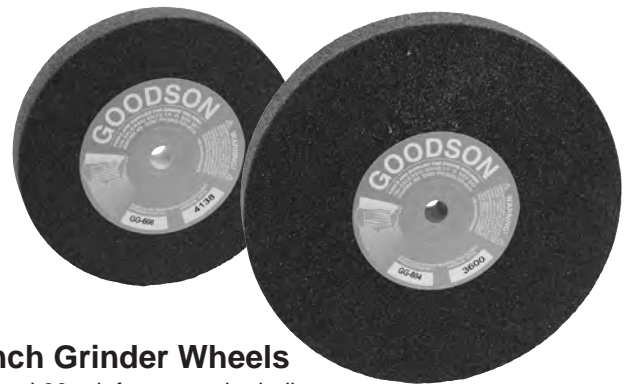
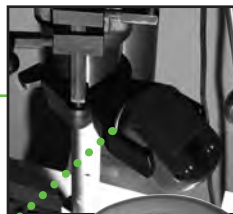

Bench Grinder Wheels

- 40 and 60 grit for general grinding
- 100 grit for sharpening carbide tools
- Includes bushings to reduce arbor hole from ¾" to ½"
- PLUS a 5/8" bushing adaptor

Size	Grit	Jobber	Order No.
General Purpose Wheels: For steel and cast iron			
6" x ¾"	60	\$30.99	GG-666
6" x 1"	60	30.99	GG-686
8" x 1"	60	39.99	GG-886
Green Grit Wheels: For sharpening carbide tools			
6" x ¾"	100	41.99	GGC-661
6" x 1"	100	50.99	GGC-681



Grinding Wheel Star Dressers

Description	Jobber	Order No.
Desmond Hand Dresser for Wheels to 10" Dia.	\$28.99	GS-0
Replacement Cutter Sets		
4 Blades, 2 Spacers, ¼" ID for GS-0 dresser	\$ 9.49	GS-00
4 Blades, 2 Spacers, ½" ID for GS-1 dresser	10.49	GS-11

Deburring Wheels for Bench Grinders

- Medium-hard wheels are better suited for heat sensitive materials
- Use to clean and polish white metal
- Buff and Blend Wheels deliver the same results as a wire brush but are much safer to work with



Description	Size	Qty.	Jobber	Order No.
Medium-Hard Deburring Wheel	6" x 1" x 1"	1	\$127.99	SCW-68M
Buff and Blend Wheels	6" x ½" x 1"	5	23.99	BBD-65

Brake Lathe Replacement Tips

Tips Are Shown Actual Size

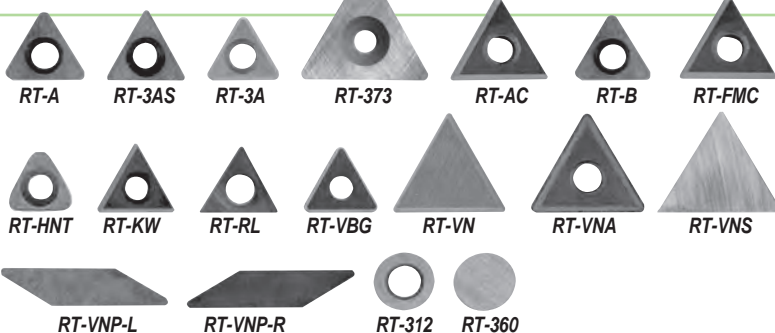

Buy 3 or More
10-Packs (mix & match), SAVE 10% off Jobber



Solid Carbide

These standard grade, solid carbide cutting tips are parallel ground for resurfacing cast iron drums and rotors.

Honed Edge Carbide

Parallel & peripheral ground. Deliver a better finish on cast iron and composite rotors.

Titanium

Premium grade titanium coated carbide. Parallel and peripheral ground for ultimate performance on cast iron & composite rotors.

10 Pack Brake Lathe Replacement Tips

Machine	Model(s)	OE No.	Edges	Rake	Screws	Jobber	Order No.	Jobber	Order No.	Jobber	Order No.
Ammco	700, 710, OTC Lathes, 1000, 2002, 3000, 4000, 4100, 7000, 7500, 7700	6914	6	Neg	Yes	\$35.99	RT-A-10	\$43.99	RT-A-H-10	\$48.99	RT-A-T-10
	3850 smaller (3/4") radius	6918	3	Pos	Yes	53.99	RT-3AS-10	61.99	RT-3AS-H-10	71.99	RT-3AS-T-10
	larger (1/2") radius	7681	3	Pos	Yes	53.99	RT-3A-10	61.99	RT-3A-H-10	71.99	RT-3A-T-10
Twin Cutters:	6900,6950 negative rake (std.)	6914	6	Neg	Yes	35.99	RT-A-10	43.99	RT-A-H-10	48.99	RT-A-T-10
	positive rake (standard) 1/4" (finer finish)	6918	3	Pos	Yes	53.99	RT-3AS-10	61.99	RT-3AS-H-10	71.99	RT-3AS-T-10
	positive rake (modified) 1/2" (more durable)	7681	3	Pos	Yes	53.99	RT-3A-10	61.99	RT-3A-H-10	71.99	RT-3A-T-10
	7900	6914	6	Neg	Yes	35.99	RT-A-10	43.99	RT-A-H-10	48.99	RT-A-T-10
Ammco HD	5000, 6000, 6002	5677	3	Pos	No	134.99	RT-373-10	---	---	---	---
Accu-Turn	All combination disc/drum lathes	433796	3	Pos	Yes	58.99	RT-AC-10	58.99	RT-AC-H-10	61.99	RT-AC-T-10
	On-The-Car Lathes	878051	6	Neg	Yes	35.99	RT-A-10	43.99	RT-A-H-10	48.99	RT-A-T-10
All-Tool	747	3331	6	Neg	Yes	35.99	RT-A-10	43.99	RT-A-H-10	48.99	RT-A-T-10
Bean	B-401, B-410, B-501, B-601	90487	3	Pos	Yes	46.99	RT-FMC-10	61.99	RT-FMC-H-10	72.99	RT-FMC-T-10
Bear	1410,1466,1467,1468, 1469, 1478	2264,72265,772834	6	Neg	Yes	37.99	RT-B-10	---	---	---	---
	10-1430, 10-1435	W136	6	Neg	No	116.99	RT-HF-10	---	---	---	---
FMC	600, 601, 700, 701, RotoTruer	90487	3	Pos	Yes	48.99	RT-FMC-10	61.99	RT-FMC-H-10	72.99	RT-FMC-T-10
	505, On-The-Car Lathe	91212	3	Pos	Yes	48.99	RT-KW-10	55.99	RT-KW-H-10	61.99	RT-KW-T-10
Hoffman	660	3331	6	Neg	Yes	35.99	RT-A-10	43.99	RT-A-H-10	48.99	RT-A-T-10
Hunter	BL300 On-The-Car Lathe	221580-2	6	Neg	Yes	35.99	RT-A-10	43.99	RT-A-H-10	48.99	RT-A-T-10
	BL-500, BL-501, BL-505	6918	3	Pos	Yes	53.99	RT-3AS-10	61.99	RT-3AS-H-10	71.99	RT-3AS-T-10
	BL-500	221-678-3	3	Pos	Yes	91.99	RT-HNT-10	---	---	---	---
Kwik-Way	CBL, NCL, SDL Kwik-Lathe OTC Lathe	109-1092-23	3	Pos	Yes	48.99	RT-KW-10	55.99	RT-KW-H-10	61.99	RT-KW-T-10
	Lightening Lathe	109-1092-45	3	Pos	Yes	---	---	---	---	97.99	RT-KWL-T-10
Performance	6600,7200,7100, 7600	3331	6	Neg	Yes	35.99	RT-A-10	43.99	RT-A-H-10	48.99	RT-A-T-10
Pro-Cut	On-The-Car Lathe	50-701, 50-742	3	Pos	Yes	46.99	RT-VBG-10	53.99	RT-VBG-H-10	61.99	RT-VBG-T-10
RJ West	Perfect 400, 1115HD	W139	3	Pos	Yes	58.99	RT-AC-10	58.99	RT-AC-H-10	61.99	RT-AC-T-10
RTI	BRC35 On-The-Car Lathe	91212	3	Pos	Yes	53.99	RT-3A-10	61.99	RT-3A-H-10	71.99	RT-3A-T-10
Snap-On	YA282,YA277,YA278, YA180 OTC Lathe	109-1092-23	3	Pos	Yes	48.99	RT-KW-10	55.99	RT-KW-H-10	61.99	RT-KW-T-10
Van Norman and Rels	204, 204D, 205, 205DC, 415, 243XV	29687	3	Pos	No	61.99	RT-VN-10	65.99	RT-VN-H-10	72.99	RT-VN-T-10
	Smaller (3/4") radius	---	3	Pos	No	55.99	RT-VNS-10	---	---	---	---
	204, 304, 405	29005	6	Neg	No	90.99	RT-VNA-10	---	---	---	---
	303,304,305,404,405,V22	304-7167	2	Pos	No	113.99	RT-VNP-L-10	---	---	---	---
	204,205,205DR,300,302,333,243,243XV	302-7167	2	Pos	No	113.99	RT-VNP-R-10	---	---	123.99	RT-VNP-RT-10
Rels 2000 rotor	45016, 45021	3	Pos	Yes	74.99	RT-RL-10	---	---	---	---	
VBG	On-The-Car Lathe	50-701	3	Pos	Yes	48.99	RT-VBG-10	53.99	RT-VBG-H-10	61.99	RT-VBG-T-10
Round Tips With Hole	---	RT-312,RT-312T	360°	Pos	Yes	19.99	RT-312	---	---	24.99	RT-312T
Round Solid	Fits RJH and CT Holders	CT10	360°	Pos	No	54.99	RT-360-10	---	---	---	---

NOTE: The table above shows the original equipment cutting tips for Ammco machines. Most of them use negative-rake tool systems. However, some Ammco machines (especially the 4000 and 7000-series) have been modified in the field by using the TAM-25968 and TAM-25969 positive-rake tool holders (see next page).

If your machine is shown above to have 6-edge tips but has 3-edge tips, it has been modified - please order our RT-3A or RT-3AS series tips.

RT-A	RT-3A	RT-AC	RT-HNT	RT-VN	RT-B	RT-VNA	Cutting Tip Measurements					
Height: .350"	Height: .343"	Height: .445"	Height: .312"	Height: .545"	Height: .343"	Height: .535"						
Thick: .095"	Thick: .093"	Thick: .131"	Thick: .103"	Thick: .125"	Thick: .105"	Thick: .188"						
Hole: .135"	Hole: .133"	Hole: .145"	Hole: .127"	Hole: N/A	Hole: .130"	Hole: .148"						
Rake: NEG	Rake: POS	Rake: POS	Rake: POS	Rake: POS	Rake: NEG	Rake: NEG						
RT-3AS	RT-373	RT-KW	RT-VBG	RT-FMC	RT-VNS	RT-RL		RT-VNP-L / -R	RT-360	RT-312		
Height: .357"	Height: .625"	Height: .358"	Height: .344"	Height: .452"	Height: .547"	Height: .421"		Height: .902"	Diameter: .311"	Diameter: .311"		
Thick: .104"	Thick: .125"	Thick: .101"	Thick: .098"	Thick: .125"	Thick: .121"	Thick: .130"	Thick: .100"	Thick: .100"	Thick: .100"			
Hole: .127"	Hole: .117"	Hole: .125"	Hole: .124"	Hole: .090"	Hole: N/A	Hole: .147"	Hole: N/A	Hole: N/A	Hole: .150"			
Rake: POS	Rake: POS	Rake: POS	Rake: POS	Rake: POS	Rake: POS	Rake: POS	Rake: POS	Rake: POS	Rake: POS			

CYLINDER HEAD
REBUILDING
CLEANING,
ASSEMBLY & SAFETY
SHORT BLOCK
REBUILDING
FLYWHEEL, GRINDING
CRANKSHAFT/
GRINDING
MISCELLANEOUS
TOOLS & SUPPLIES
BRAKE SERVICE
TOOLING
MEASURING
TOOLS
V-TWIN & METRIC
HARD PARTS

... another
satisfied
customer

"Goodson is the most hassle-free vendor that I deal with. Everything I have ordered has always been in stock."

- Jerry Darien, Darien Racing, Goodson customer since 2012

CYLINDER HEAD
REBUILDING



Tip Holder for Drums

Fits **Ammco** 1000, 2002, 3000, 4000, 4100, 7500 & 7700; **All Tool** 747; **Hoffman** 660; **Performance** 6600, 7200, 7100 & 7600
Dimensions: $\frac{1}{2}$ " x $\frac{3}{8}$ " x $2\frac{1}{4}$ "
Replaces OE No. 9872
Orientation: Right
Use Tips: RT-A Series (includes 1)
Order No. **TAM-41R** Jobber \$24.99

CLEANING,
ASSEMBLY & SAFETY



Tip Holder for Rotors

Fits **Ammco** 3000, 3850, 4000, 4100, 7000 & 6900, 6950 Twin Cutters; **All Tool** 747; **Performance** 6600, 7200, 7100, 7600; **Hoffman** 660
Dimensions: $\frac{3}{8}$ " x $\frac{3}{8}$ " x $1\frac{1}{8}$ "
Replaces OE No. 10701, 10702
Use Tips: RT-A Series (includes 1)
Left: Order No. **TAM-702** Jobber \$24.99
Right: Order No. **TAM-701** Jobber \$24.99

SHORT BLOCK
REBUILDING



Tip Holder for Rotors

Fits **Ammco** 3000, 3850, 4000, 4100, 7000 & 6900, 6950 Twin Cutters
Dimensions: $\frac{3}{8}$ " x $\frac{3}{8}$ " x $1\frac{1}{8}$ "
Replaces OE No. 25968, 25969
Use Tips: RT-3A or RT-3AS (includes 1)
Left: Order No. **TAM-25969** Jobber \$30.99
Right: Order No. **TAM-25968** Jobber \$30.99

CRANKSHAFT/
FLYWHEEL GRINDING



Tip Holder for Drums & Rotors

Fits **Kwik-Way** CBL, NCL, SDL;
Snap-On Y282, Y277, Y278, 180
Dimensions: $\frac{3}{8}$ " x $\frac{3}{8}$ " x $2\frac{1}{2}$ "
Replaces OE No. 109-1091-02,
109-1091-00
Use Tips: RT-KW Series (includes 1)
Left: Order No. **TKW-85L** Jobber \$26.99
Right: Order No. **TKW-84R** Jobber \$26.99

MISCELLANEOUS
TOOLS & SUPPLIES

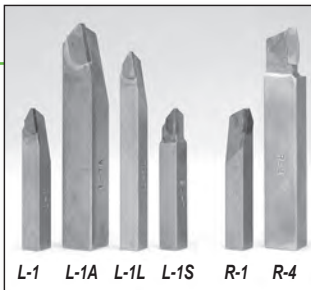

Brazed Carbide Brake Lathe Tools

• Fit most popular brake drum lathes

Left Hand Cutting Tools

Size	Application	Jobber	Order No.
$\frac{3}{8}$ " sq. x $2\frac{1}{2}$ "	Replaces Bean 43-46L; Bear 23211; Star CB-8; VN 302-7272 for 303, 304, 304H	\$13.99	L-1
$\frac{5}{8}$ " sq. x 4"	Replaces Ammco 5725, for 5000; Star CB-30; VN "Big Brute" for 310-404 Hardspots	23.99	L-1A
$\frac{3}{8}$ " sq. x $3\frac{1}{2}$ "	Extra long L-1 for small dia. drums	13.99	L-1L
$\frac{3}{8}$ " sq. x $2\frac{1}{2}$ "	Master carbide-tipped with 7° rake angle	18.99	L-1S

Right Hand Cutting Tools

Size	Application	Jobber	Order No.
$\frac{3}{8}$ " sq. x $2\frac{1}{2}$ "	Replaces Bean 43-46R; Bear 20718; Star LB-16; VN 302-7171 for 204, 300, 302, 302H, 333, 243XV; and Barrett & Lemppo	\$13.99	R-1
$\frac{3}{8}$ " sq. x $2\frac{1}{2}$ "	Master carbide-tipped with 7° rake angle	9.99	R-1S
$\frac{5}{8}$ " sq. x 4"	Replaces Bear 24034, Star CB-35	24.99	R-4

Hardspot Cutters

Left Hand

Size	Use	Jobber	Order No.
$\frac{3}{8}$ " x $\frac{1}{2}$ " x $2\frac{3}{8}$ "	Drums	\$19.99	L-5

Right Hand

Size	Use	Jobber	Order No.
$\frac{3}{8}$ " x $\frac{1}{2}$ " x $2\frac{3}{8}$ "	Drums	\$19.99	R-5



L-5 R-5

BRAKE SERVICE
TOOLING

MEASURING
TOOLS

V-TWIN & METRIC
HARD PARTS

Don't buy a new
brake lathe ...
expand your existing
one to handle rotors
up to 15"



Lead Screw Bushing

- Easy installation
- Increases lathe capacity to 15"
- Ideal for machining large rotors common on SUVs and large pick-ups
- Fits Ammco 3000 and 4000 Brake Lathes
- Order No. **LSB-78529** Jobber \$35.99

Brake Shoe Grinding Sleeves

- Aluminum-Oxide abrasive



ID	Length	Grit	Jobber	Order No.
3"	5 $\frac{1}{4}$ "	40	\$6.99	AS-2
3"	6 $\frac{1}{2}$ "	40	7.99	AS-4

Carbide Tipped Brake Drum Swedge Cutting Tool

- Hard-to-find tool cuts wheel stud swedges to remove and replace pressed-in wheel studs
- Use with a drill press or mill
- For 1/2" stud
- Order No. **ST-500** Jobber \$114.99



Brake Lathe Silencers



34" Neoprene Brake Lathe Silencer

- Longer lasting than rubber
- Neoprene material resists deterioration associated with standard rubber belts
- 7 sound deadening weights
- Measures: 34" L x 5/8" W x 3/16" Thick
- Order No. **GT-6030N** Jobber \$25.99



34" Rubber Brake Lathe Silencer

- Live rubber strap with 7 sound deadening weights
- For vented rotors
- Measures: 34"L x 5/8"W x 3/16" thick
- Order No. **CE-8** Jobber \$25.99

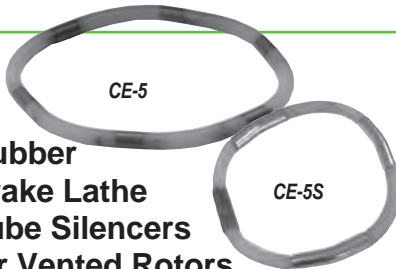

Rubber Brake Lathe Tube Silencers for Vented Rotors

- 9/16" OD rubber tube with internal sound dampeners
- 2 sizes to choose from

Diameter	Weights	Jobber	Order No.
9"	6	\$29.99	CE-5
8"	4	28.99	CE-5S



Magnetic Strap Brake Lathe Silencer for Non-Vented Rotors

- Measures 48"L x 1/4" wide
- Eliminates silencer wandering on solid, non-vented rotors
- Order No. **CE-10** Jobber \$12.99



Spring Silencer For Vented Rotors

- For 6" to 9" rotors
- Metal spring with internal sound dampeners
- Order No. **CE-13** Jobber \$33.99

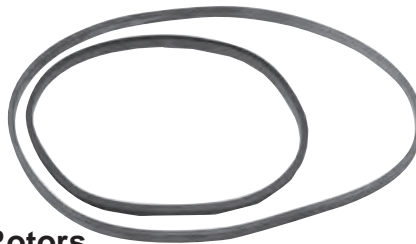

Rubber Band Brake Lathe Silencers for Non-Vented Rotors

- Neoprene rubber gasket type bands for thin solid rotors
- Both lengths measure 5/16" wide x 3/16" thick

Length	Jobber	Order No.
6 1/2"	\$7.49	CE-11
9"	9.99	CE-12



Replacement Pucks for Ammco Friction Rotor Silencer

- Heavy non-asbestos pucks provide the mass needed to dampen vibration
- Sold as a pair
- Fits Ammco 7075 silencer
- Order No. **CE-9** Jobber \$25.99



Clamp-On Brake Lathe Silencers For Vented & Non-Vented Rotors

- Follows the cut to absorb vibrations where they start
- Outlast plastic pads, rubber straps and bands

Application	Jobber	Order No.
For Bench Model Brake Lathes	\$43.99	CE-6
For On-The-Car Brake Lathes	41.99	CE-26



Premium Rubber Brake Lathe Silencers for Brake Drums

- Premium live rubber straps
- Two sizes to choose from

Application	Size	Jobber	Order No.
Passenger Cars	62"L x 2 7/8"W x 1/8" Thick	\$22.99	CE-1
Trucks	78"L x 2 7/8"W x 1/8" Thick	37.99	CE-2

CYLINDER HEAD REBUILDING
CLEANING, ASSEMBLY & SAFETY
SHORT BLOCK REBUILDING
FLYWHEEL GRINDING
CRANKSHAFT/GRINDING
MISCELLANEOUS TOOLS & SUPPLIES
BRAKE SERVICE TOOLING
MEASURING TOOLS
V-TWIN & METRIC HARD PARTS



Replacement Work Light

- 30" adjustable arm
- 5/8" round mounting end
- Uses up to 100W standard base bulb (not included)
- Easily accessible switch
- Fits most Ammco models
- Order No. **GT-7963**
Jobber \$104.99

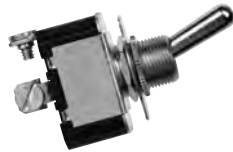

Replacement Switch for Ammco Brake Lathes

- Easy to install
- Fits most models
- Order No. **GT-7893**
Jobber \$15.99



1" Arbor for Ammco

- Fits Ammco 2002, 3000, 4000, 4100, 7000, 7500 & 7700 models
- 7/8" x 9 LH thread
- Precision ground
- Factory checked for run-out of less than .001" • Heat treated, stress relieved tool steel • For drums & rotors up to 125 lbs.
- Order No. **GT-3101**
Jobber \$419.99

1HP Motor for Ammco Brake Lathes

- Fits 3000, 4000, 4100, 7000, 7500 & 7700 models
- 208 / 230 / 115V • 60Hz
- 1725 RPM • Shaft: .625"
- Includes motor plate and fasteners
- Order No. **GT-2165**
Jobber \$617.99



1" Arbor Nut For Ammco

- 7/8" x 9 LH thread
- Fits Ammco 2002, 3000, 4000, 4100, 7000, 7700 and 3850 models
- Order No. **GT-3102**
Jobber \$36.99



1" Arbor Nut For All But Ammco

- 1" x 9 LH thread
- Fits AccuTurn 433701, All Tool 747, FMC 601, 701 & 702, Hunter, Van Norman/Rels 204, 243
- Order No. **GT-20442N**
Jobber \$31.99



Brake Lathe Centering Spring

- Fits any 1" arbor brake lathe
- 1.687" ID
- 1.927" OD
- 4.000" OAL
- Order No. **GT-3110**
Jobber \$7.99



Mounting Spacers

- Fit all 1" arbor brake lathes

Length	Jobber	Order No.
1/2"	\$ 6.99	GT-3125
Flexible	56.99	GT-9492



enlarged to show detail

Brass Wear Inserts For Ammco

- Sold individually

Dia. x Lgth.	Jobber	Order No.
3/8" x 1/8"	\$3.19	GT-3141
1/8" x 1/4"	3.19	GT-3142
(most popular)		
1/4" x 1/8"	3.19	GT-9836



Replacement Feed Screw Seal For Ammco

- 1 1/4" OD
- Order No. **3163**
Jobber \$10.49



Replacement Screw for Twin Cutter Tool Bit Holders

- Square Head Screw
- Order No. **GT-9249**
Jobber \$2.79

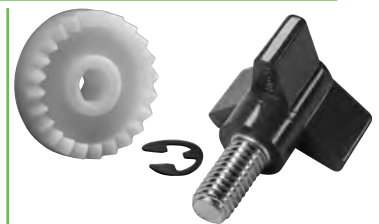

Small Ammco Replacement Parts

Description	Jobber	Order No.
Locking Knob	\$6.99	6854
Cross Feed Shear Gear with C-Clip	7.49	7996



Ammco Rotor & Drum Feed Screw Bushings

Description	Jobber	Order No.
Rotor Feed Bushing (early)	\$38.99	GT-10868
Rotor Feed Bushing (late)	36.99	GT-10868X
Drum Feed Bushing (all)	89.99	GT-4670
Lead Screw Bushing Adaptor	35.99	LSB-78529



GT-4670



Tooling Hold Down Pieces For Ammco

Description	Jobber	Order No.	Incl.
Stud Assembly	\$43.99	GT-25900	▼
6 1/2" Stud	13.99	GT-25913	x
Nut Assembly (must be used with 6 1/2" Stud)	34.99	GT-11227	x



Pastelub™ Synthetic High Temp Brake Lubricant

- OE recommended • High pressure resistant
- Recommended for the backs of brake pads
- Not for use on friction surfaces
- 2400°F Ultra high-temperatures range
- Patented "real synthetic" Swiss formula won't melt, rub or wash off brake parts • Gray • Net wt. 7 oz.
- No silicone or petroleum to weaken the carrier base
- Order No. **BPL-2400**
- 1+ Jobber \$20.99 ea. | 12+ Jobber \$18.89 ea.



Ceramlub-2800™ Extreme High Temperature Lubricant

- Use on brake caliper slides, etc.
- Contains ceramic pressure solids and high concentrations of anti-corrosive agents
- Specifically designed for use on caliper slides, rubber seals & O-Rings
- A great complement to Pastelub™ Hi-Temp Lubricant
- Purple • Net wt. 7 oz.
- Order No. **CBL-2800**
- 1+ Jobber \$20.99 ea. | 12+ Jobber \$18.89 ea.



Buy a case of 12 (any combination BPL-2400, CBL-2800), SAVE 10% off jobber



GOODTOOL
Now exclusively from Goodson

Heavy Duty Brake Lathe Centering Cones

- For brake lathes with 1" dia. arbors

Large Dia.: 5.125"	Large Dia.: 5.500"	Large Dia.: 6.125"
Small Dia.: 3.750"	Small Dia.: 4.500"	Small Dia.: 5.000"
Order No.: GT-5053	Order No.: GT-5052	Order No.: GT-5054
Jobber: \$134.99	Jobber: \$109.99	Jobber: \$139.99

When using bell clamps and centering cones always be sure they are clean and free of any dirt or rust. Keep a light coating of oil on them to prevent rusting.

Never use a cone or a bell clamp for anything other than mounting a brake rotor or drum onto the brake lathe. Always use the largest bell clamp that will fit the rotor or drum for the best support.



Automotive Brake Lathe Bell Clamps

- For brake lathes with 1" dia. arbors

OD Size: 4.500"	OD Size: 5.700"
Arbor Size: 1.000"	Arbor Size: 1.000"
Order No.: GT-9490	Order No.: GT-3123
Jobber: \$51.99	Jobber: \$83.99

Heavy Duty Brake Lathe Bell Clamps

- For brake lathes with 1" dia. arbors

OD Size: 6.500"	OD Size: 7.750"
Arbor Size: 1.000"	Arbor Size: 1.000"
Order No.: GT-5055	Order No.: GT-5056
Jobber: \$138.99	Jobber: \$199.99

Heavy Duty Brake Lathe Spring

- Use to exert extra pressure
- Measures 2.515"OD x 2.217" ID x 4"L
- Order No. **GT-5059** Jobber \$20.99



Drive Pulleys & Belts for Ammco

- Fit Ammco 3000, 4000, 4100, 7000 & 7100
- Serpentine design runs quieter and increases arbor speed by 175RPMs • Virtually eliminates vibration



New-Style (Serpentine)

Description	Jobber	Order No.
Pulley Set (Includes 20¼" belt & 2 pulleys)	\$227.99	GT-5001
20¼" Belt	22.99	GT-5002
19" Belt	22.99	GT-5003

Original-Style (V-belt) Replacements

Description	Jobber	Order No.
25" Belt (replaces OE 3161)	\$14.99	GT-3161
24" Belt (replaces OE 10241)	16.99	GT-10241

tech tips from the techxperts™ Install the drive pulley with the pin toward the right angle drive. The roll-pins drive against each other. A nylon sleeve prevents metal to metal contact.

Don't buy a new brake lathe ... expand your existing one to handle rotors up to 15"

Lead Screw Bushing

- Easy installation
- Increases lathe capacity to 15"
- Ideal for machining large rotors common on SUVs and large pick-ups
- Fits Ammco 3000 and 4000 Brake Lathes
- Order No. **LSB-78529** Jobber \$35.99



CYLINDER HEAD
REBUILDING
CLEANING,
ASSEMBLY & SAFETY
SHORT BLOCK
REBUILDING
FLYWHEELS
CRANKSHAFT/
Pistons
MISCELLANEOUS
BRAKE SERVICE
TOOLING
MEASURING
TOOLS
V-TWIN & METRIC
HARD PARTS



"We pride ourselves on packaging our products carefully and professionally. We want you to receive your order quickly and in good condition."

- Brian, Goodson Receiving, 34 years of service

CYLINDER HEAD REBUILDING
CLEANING, ASSEMBLY & SAFETY
SHORT BLOCK REBUILDING
CRANKSHAFT/ FLYWHEEL GRINDING
MISCELLANEOUS TOOLS & SUPPLIES
BRAKE SERVICE TOOLING
MEASURING TOOLS
V-TWIN & METRIC HARD PARTS

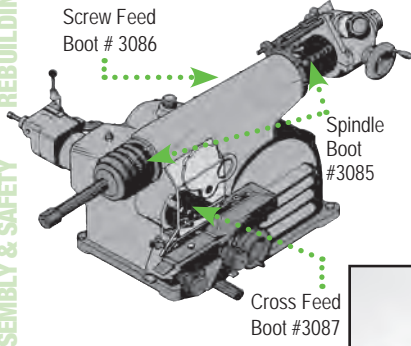

GOODTOOL
Now exclusively from Goodson



Replacement Boot Packs

- Keep extra boots on hand for routine maintenance or emergency replacement
- Fits Ammco 3000, 4000, 4100, 7000, 7700

Description	Jobber	Order No.
Polyethylene Spindle Boot	\$27.49	3085
Screw Feed Dust Boot	26.49	3086
Cross Feed Dust Boot	20.99	3087
Boot Ring	37.99	23682
C-Clip	4.99	SBR-4435
Snap Ring	8.99	SBR-3159

tech tips
from the techxperts™



Get step by step instructions on replacing brake lathe boots

Check out the blog post (with pictures) on our website. Use your smart phone or other smart device to scan the code at left for instant access to the post.

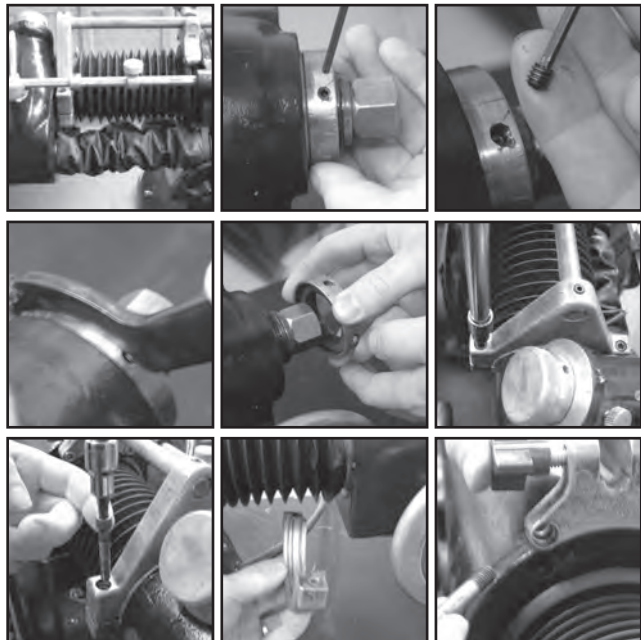

See page 83 for more Flex-Hones®

Brake Rotor Flex-Hones®

- Provide a non-directional finish
- Use with a 3/8" variable speed drill at 600-1000 RPM
- Zirconium abrasive
- Use dry

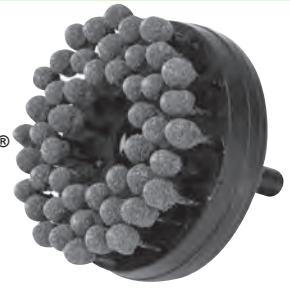

Type	Grit	Jobber 1+	Jobber 3+	Order No.
Fine	240	\$60.99	\$54.89	BRF-25F
Medium	120	60.99	54.89	BRF-25M
Coarse	60	60.99	54.89	BRF-25C

Order 3 or more Flex-Hones® (any combination) to Save 10% off Jobber!

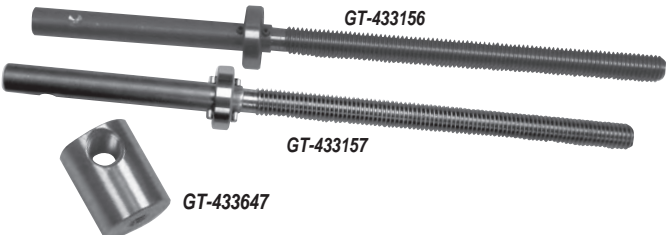

Assorted Accu-Turn Replacement Parts

Description	Jobber	Order No.
Rotor Feed Screw Assembly (1/2" 20TPI)	\$83.99	GT-433156
Drum Feed Screw Assembly (1/2" 13TPI)	84.99	GT-433157
Rotor Feed Bushing (fine thread)	46.99	GT-433647
Drum Feed Bushing (not shown) (coarse thread)	53.99	GT-433646

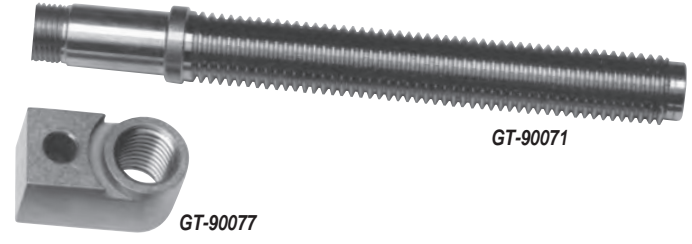

Rotor Feed Screws & Nuts For FMC & Bean

Description	Jobber	Order No.
Rotor Feed Screw	\$63.99	GT-90071
Rotor Feed Nut	63.99	GT-90077



Brake Drum Grinding Wheels

- Aluminum-Oxide abrasive
- For Van Norman / Rels 204, 300, 302, 303, 333 & 404 Drum Grinders
- Size: 3" x 1/2" x 1"
- OE No.: 8522
- Shape: Recessed
- Order No. **GDV-304** Jobber \$27.99



Precision Straight Edges

- 2 sizes to choose from
- Accuracy .005" per foot
- Precision ground one edge
- .375" thick high quality heat-treated steel construction
- Each straight edge is pre-drilled for easy wall storage

Description	Jobber	Order No.
24" straightedge, 1 precision edge	\$189.99	DIS-24
36" straightedge, 1 precision edge	314.99	DIS-36



Rod Bolt Stretch Gauge

- Accurate to .001"
- Features a 1½" dial gauge
- Extra heavy-duty tension spring for repeatable accuracy
- For bolts from 1" to 2½" long

Description	Jobber	Order No.
Rod Bolt Stretch Gauge	\$92.99	RBSG-3
Optional Contact Point	13.99	ERBG-3T
Replacement Pointer	10.49	RBSG-P

tech tips
from the techxperts™

Most engine rod failures aren't from faulty parts, they're from improper installation. When you're installing connecting rods, you need to

check the rod bolt stretch by performing a series of torquing and loosening and recording the readings.

Here's how:

1. Torque the bolts to 15 foot pounds and measure the stretch. Record the reading, then loosen the bolts.
2. Repeat at 15 foot pounds and record the reading.
3. Repeat, increasing to 30 foot pounds, record the reading.
4. Repeat, increasing to 60 foot pounds, record the reading.
5. Repeat at 60 foot pounds and record the reading.

Each time you loosen the bolts, measure to be sure that the rod bolts have returned to within .001" of the starting size. If you have a greater variation, get rid of the rod bolts and start with new ones.

When you're conducting final assembly, be sure you use the stretch specified by your rod manufacturer. Attach a rod bolt stretch gauge to the connecting rod bolt and zero it. Use an extra-long box wrench to tighten until the proper stretch is achieved.

Small Hole Gauge Set

- See if rebuilding or replacing is needed by checking guide wear
- Check guide bosses for proper interference fit during replacement
- Check and maintain correct stem-to-guide ID clearance
- 4-piece set has combined range of .125" to .500"
- Order No. **SHG-4** Jobber \$74.99

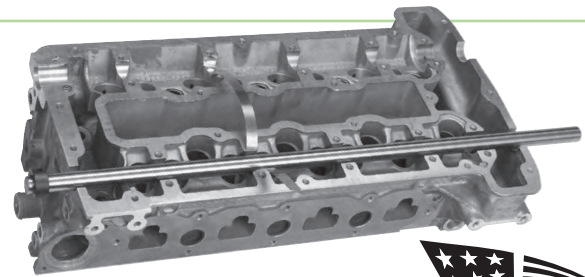

26" Round Warp Gauge

- Use with feeler gauges (below)
- ¾" diameter tool steel
- Includes anti-roll collar and eye bolt allowing you to hang it for safe, convenient storage
- Order No. **EWG-100** Jobber \$189.99



12" Feeler Gauges

- Measure piston-to-wall clearance when honing, to find ring end gap and to check cylinder heads with a straight-edge
- Also useful for shimming while straightening heads and for machine set-ups

	Jobber	Order No.	
Complete Kit	\$46.99	FE-KIT	▼
Thick			
.0015"	5.49	FE-0015	x
.0020"	5.49	FE-002	x
.0030"	5.49	FE-003	x
.0040"	5.49	FE-004	x
.0050"	5.49	FE-005	x
.0060"	5.49	FE-006	x
.0070"	5.49	FE-007	x
.0080"	5.49	FE-008	x
.0090"	5.49	FE-009	x
.0100"	5.49	FE-010	x
.0150"	5.49	FE-015	x
.0200"	5.49	FE-020	x

Mitutoyo

Split Ball Bore Gauge

- Dial gauge with large contact area
- Measures quickly & accurately to .0001"
- Works in threaded or knurled guide IDs
- Range: .280"-.400" • Easy to change contacts
- Order No. **MVG-34** Jobber \$769.99



6 Piece Telescoping Gauge Set

- Compress spring plunger and lock by twisting handle
- Insert into bore and release plunger – it will expand to fit
 - Lock again and remove
 - Measure with a micrometer
 - Double plunger design for consistent measuring
 - Long-lasting finish
 - Size range: ¾" - 6"
- Order No. **MTG-6** Jobber \$149.99



CYLINDER HEAD REBUILDING
CLEANING, ASSEMBLY & SAFETY
SHORT BLOCK REBUILDING
CRANKSHAFT/ FLYWHEEL GRINDING
MISCELLANEOUS TOOLS & SUPPLIES
BRAKE SERVICE TOOLING
MEASURING TOOLS
V-TWIN & METRIC HARD PARTS

full service
...fast



"From the time we answer the phone to when you receive your delivery, our goal is to get it right the first time and every time."
- Daniela, Goodson Advertising Department, 2 years of service



Build Your Own Valve Guide Gauge Set! Order the Valve Guide Gauge (P-300), Setting Fixture (P-610A) and the Valve Guide Probe you need.



Valve Guide Gauge Set

- The only way to be sure clearance is correct is to gauge it
- Checks all types of guides for size and roundness FAST
- Set up and measure valve guide IDs quickly and easily
- Complete set includes gauge, 3 probes (.312", .344" and .375"), hex wrench, setting fixture and metal storage case with spaces for all components
- Dial calibrated in .0002" increments

Description	Jobber	Order No.	Incl.
Complete Valve Guide Gauge Set	\$3348.68	P-310	▼
Valve Guide Gauge	852.38	P-300	x
Setting Fixture	922.22	P-610A	x
Valve Guide Probes			
Size	Range in.	mm	
.236"	.224" to .264"	5.69 to 6.71	\$558.77 P-236
.250"	.238" to .278"	6.05 to 7.05	580.43 P-250
.281"	.269" to .309"	6.83 to 7.85	602.08 P-281
.312"	.300" to .340"	7.62 to 8.64	623.74 P-312 x
.344"	.332" to .372"	8.43 to 9.45	642.67 P-344 x
.375"	.363" to .403"	9.22 to 10.24	665.68 P-375 x
.438"	.426" to .466"	10.82 to 11.84	710.32 P-438

Additional probe sizes available by special order

⚠ WARNING: Operating, servicing and maintaining a passenger vehicle or off-road vehicle can expose you to chemicals including engine exhaust, carbon monoxide, phthalates, and lead, which are known to the State of California to cause cancer and birth defects or other reproductive harm. To minimize exposure, avoid breathing exhaust, do not idle the engine except as necessary, service your vehicle in a well-ventilated area and wear gloves or wash your hands frequently when servicing your vehicle. For more information go to www.P65Warnings.ca.gov/products/passenger-vehicle.



Sunnen® AG-Series Precision Gauge

- Dial reads directly in "tenths" (.0001")
- Checks rod journal bore for distortion
- Measures size instantly
- Wear-compensated gauge points for permanent accuracy
- Rugged construction – all moving parts are enclosed in the housing
- Includes Point Sets listed below (optional sets are available, call for information)



Description	Jobber	Order No.
.375" - 3.375" (9.5 - 85.7mm) Range Gauge	\$5407.49	AG-300
Standard Point Set (.720" - 1.530" Range)	174.78	AG-210
Medium Point Set (1.50" - 2.25" Range)	132.32	AG-620
Large Point Set (1.932" - 2.687" Range)	132.32	AG-630
Sun-Dura® Gauge Cover (8"L x 8"H x 4"D)	40.99	GMC-AG300

Point sets will only fit AG-gauges higher than Serial No. 4000



Distributor Depth Gauge

Working on a Big Block or Small Block Chevy with a distributor? Avoid problem wear and potential failure caused by a distributor that fits too deep. This easy to use gauge measures the depth of engagement allowing you to compensate to create adequate clearance. Kit comes complete with a .500" diameter adaptor. An optional .491" shaft is also available.

Description	Jobber	Order No.
Distributor Depth Gauge Kit	\$284.99	DDG-05
.491" Shaft	79.99	DDG-491

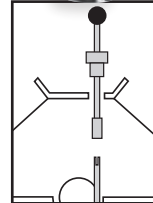

Fig. 1 Insert depth gauge in place of distributor. Bottom out in oil pump drive.

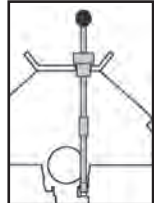

Fig. 2 Push down on the top collar, making contact with manifold.

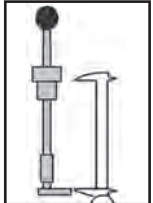

Fig. 3 Remove depth gauge from engine. Install adaptor in distributor tool. Measure and record depth.

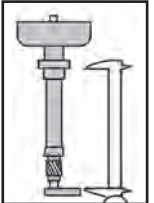

Fig. 4 Install adaptor in distributor drive. Measure as before and compare. Shim as needed to create clearance.

CYLINDER HEAD REBUILDING
CLEANING, ASSEMBLY & SAFETY
SHORT BLOCK REBUILDING
CRANKSHAFT/ FLYWHEEL GRINDING
MISCELLANEOUS TOOLS & SUPPLIES
BRAKE SERVICE TOOLING
MEASURING TOOLS
V-TWIN & METRIC HARD PARTS

Sunnen® Dial Bore Gauges

Sunnen® Dial Bore Gauges



- Standard Sunnen® Dial Bore Gauges read out in tenths
- Also available in five-tenths and metric (special order)
- Diameter ranges from .495" to 6.000" (see chart for gauge ranges)
- All models below feature all-carbide gauging points, wear-proof ball crank and adjustable centralizers
- Includes molded storage case with all tools and wrenches required for setup and adjustment

Shock-Shield protects dial from hand heat and jarring to assure accurate reliable readings.

All standard Sunnen Dial Bore Gauges are TENTH READING. Metric and .0005" readouts are also available (special order). Dial can be indexed 90° for easy reading at any angle.

Adjustable centralizers for proper centering over the entire diameter range. One twist adjusts gauge tension so head goes into and out of any size hole smoothly.

Patented wear-proof ball crank assures repeatability over a long life.

Carbide indicating points are long wearing and replaceable.

Transfer Rod

Indexable Centralizer Points

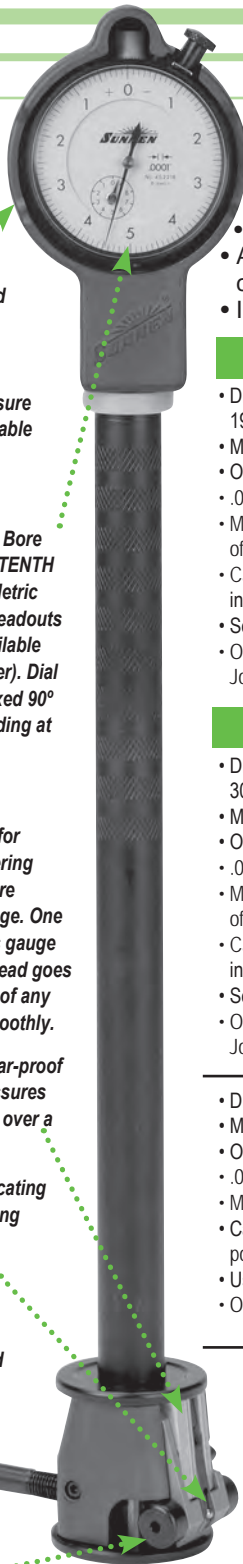

Non-Retractable Dial Bore Gauges

- Dia. Range: .495" to .750" (12.6 to 19.0mm)
- Max. Gauging Depth: 7.00" (175mm)
- Overall Length: 11.8125" (302mm)
- .0001" Reading
- Measures to within .200" of the bottom of a blind bore
- Carbide balls replaceable in the indicating fingers only
- Set with SCF-502 Setting Fixture
- Order No. **GA-4141**
Jobber \$1461.56

- Dia. Range: 2.00" to 6.00" (50 to 150mm)
- Max. Gauging Depth: 12.00" (300mm)
- Overall Length: 17.00" (432mm)
- .0001" Reading
- Measures to within .500" of the bottom of a blind bore
- Carbide balls replaceable in indicating fingers and extension points
- Use CF-1126 Setting Fixture
- Order No. **GA-2121**
Jobber \$1524.36

- Dia. Range: 2.00" to 6.00" (50 to 150mm)
- Max. Gauging Depth: 12.00" (300mm)
- Overall Length: 17.00" (432mm)
- .0005" Reading
- Measures to within .500" of the bottom of a blind bore
- Carbide balls replaceable in indicating fingers and extension points
- Use CF-1126 Setting Fixture
- Order No. **GA-2125**
Jobber \$1524.36

Retractable Dial Bore Gauges

- Dia. Range: .740" to 1.19" (18.9 to 30.20mm)
- Max. Gauging Depth: 12.00" (300mm)
- Overall Length: 17.6875" (451mm)
- .0001" Reading
- Measures to within .270" of the bottom of a blind bore
- Carbide balls replaceable in the indicating fingers only
- Set with SCF-502 Setting Fixture
- Order No. **GR-6241**
Jobber \$1684.49

- Dia. Range: 1.18" to 2.00" (30.0 to 50.8mm)
- Max. Gauging Depth: 12.00" (300mm)
- Overall Length: 17.75" (452mm)
- .0001" Reading
- Measures to within .335" of the bottom of a blind bore
- Carbide balls replaceable in indicating fingers and extension points
- Use SCF-502 Setting Fixture
- Order No. **GR-9241**
Jobber \$1738.61

- Dia. Range: 2.00" to 6.00" (50 to 150mm)
- Max. Gauging Depth: 12.00" (300mm)
- Overall Length: 17.00" (432mm)
- .0001" Reading
- Measures to within .500" of the bottom of a blind bore
- Carbide balls replaceable in indicating fingers and extension points
- Use CF-1126 Setting Fixture
- Order No. **GR-2121**
Jobber \$1816.55

- Dia. Range: 2.00" to 6.00" (50 to 150mm)
- Max. Gauging Depth: 24.00" (600mm)
- Overall Length: 29.00" (737mm)
- .0001" Reading
- Measures to within .500" of the bottom of a blind bore
- Carbide balls replaceable in indicating fingers and extension points
- Use CF-1126 Setting Fixture
- Order No. **GR-2241** Jobber \$1816.55

- Dia. Range: 2.00" to 6.00" (50 to 150mm)
- Max. Gauging Depth: 24.00" (600mm)
- Overall Length: 29.00" (737mm)
- .0005" Reading
- Measures to within .500" of the bottom of a blind bore
- Carbide balls replaceable in indicating fingers and extension points
- Use CF-1126 Setting Fixture
- Order No. **GR-2245** Jobber \$1826.90

Dial Bore Gauge Setting Fixtures

- Models combine to cover a continuous range of .054" to 8" in .0001" increments
- Heavy stress-relieved cast iron bases
- Lapped carbide micrometer anvils
- Built-in magnifier
- Each setting fixture includes a master calibrating ring
- Size Setting Adaptor centers gauge probes between parallel reference surfaces on SCF-502 Setting Fixture

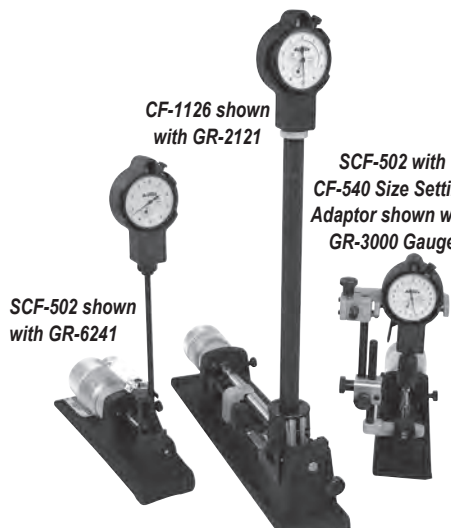

Range	Jobber	Order No.
.054" to 2.00"	\$2963.08	SCF-502
2.00" to 8.00"	3049.62	CF-1126
Size Setting Adaptor	1346.24	CF-540

Gauges & Setting Fixtures Sold Separately



CYLINDER HEAD REBUILDING
CLEANING, ASSEMBLY & SAFETY
SHORT BLOCK REBUILDING
FLYWHEEL GRINDING
CRANKSHAFT/ MISCELLANEOUS
TOOLING
BRAKE SERVICE
MEASURING TOOLS
V-TWIN & METRIC HARD PARTS

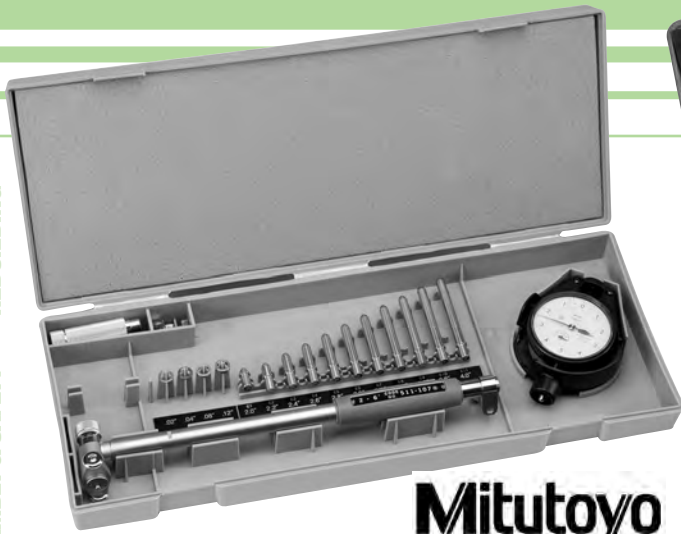

Mitutoyo

Dial Bore Gauge Set

- Rugged bore gauge with protected dial
- Carbide tipped contact points
- .0001" (.001mm) graduations • Indication stability: .00008"
- Accuracy: .0002" • Shoe can be rotated for a fresh wear surface • Sets up with a standard micrometer (see page 128)

Range	Description	Jobber	Order No.
2.0"-6.0"	11 anvils and 4 spacers	\$634.99	MMCB-06
Replacement Spacers for anvils 2" & larger	.020"	11.49	MMCB-06-020
	.040"	11.49	MMCB-06-040
	.080"	11.49	MMCB-06-080
	.120"	11.49	MMCB-06-120
Replacement Lens		24.99	MMCB-06LENS
Replacement Dial Indicator		239.99	MMCB-06IND
Replacement Dial Cover		31.99	MMCB-06COVER



0.0005" Graduation Dial Bore Gauge

- Includes: .050" travel indicator, 3 spacers (.100", .050" and .020"), 11 anvils and storage case
- Use for precise bore measurements
- Bore depth: 6" • Range: 2" to 6"

Description	Jobber	Order No.
Dial Bore Gauge	\$199.99	EBG-265
11 Piece Replacement Spacer Set	49.99	EBG-ANVILS



Metric Dial Bore Gauge

- Carbide anvils
- Easy-to-read gauge
- Insulated grip with chrome plated handle
- Includes: extension holder and fitted case
- Range: 35 to 160mm
- Graduations: 0.01mm
- Order No. **MCBG-160** Jobber \$244.99



0.7" to 1.5" Range Cylinder Dial Bore Gauge Set

- Carbide anvils • Easy to read gauge
- Measure cylinders up to 9.5" deep
- Graduations: 0.0005" • Self-centering • Insulated grip
- Chrome plated handle • Includes extension holder and case • Order No. **FBG-7** Jobber \$179.99



Internal Electronic Caliper

- Ideal for measuring mating port runners and bowl diameters
- Hardened contact surfaces
- Robust housing with large LCD display
- Range: 0.5" to 6.0" • Reading: .01" (.3mm)
- Spring loaded locking nut
- Order No. **IEC-56** Jobber \$67.99

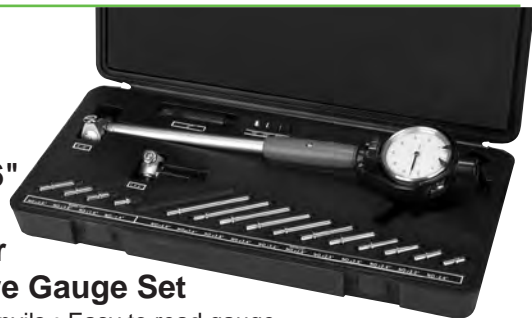

1.4" to 6" Range Cylinder Dial Bore Gauge Set

- Carbide anvils • Easy to read gauge
- Measure cylinders up to 9.5" deep • Graduations: 0.0005"
- Self-centering • Insulated grip • Chrome plated handle
- Includes extension holder and case
- Order No. **FBG-146** Jobber \$219.99

Mounts on Your Pilot



Valve Seat Height Gauge

Includes Dial Indicator

- Confirm seat height to fire deck location
- Adjusts for all popular seat diameters
- Accurate to .001"
- Seat contact probe aligns on valve seat while gauge rides along the fire deck
- Pilot aligns in valve guide (pilot sold separately)
- Adjustable to fit popular seat diameters from .750" to 3.00"

Description	Fits Pilot	Jobber	Order No.
Valve Seat Height Gauge Kit	.375"	\$108.99	VSHG-375
Replacement Dial Indicator		32.99	EDI-1

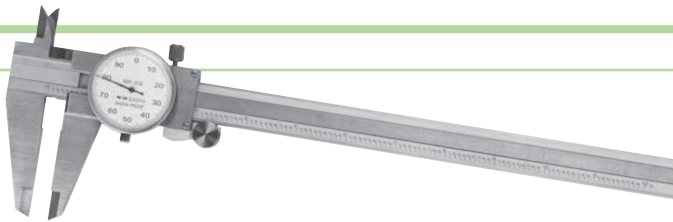

12" Direct Reading Dial Caliper

- .001" single revolution • Hardened measuring face
- Precision Ground • Micro-lapped for accuracy
- Adjusting slide for fine adjustment
- Take inside, outside and depth measurements
- Satin Chrome finish with engraved graduations
- Clamp for repetitive readings • Accurate to .001" per 6"
- Covered Rack • Deluxe fitted case
- Order No. **EDC-12** Jobber \$154.99

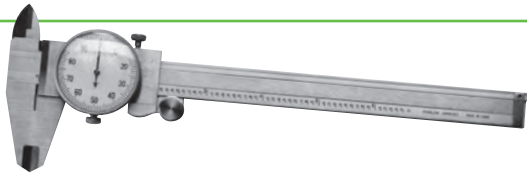

6" Direct Reading Dial Caliper

- Four way measurement - outside, inside, depth and step
- Hardened stainless steel with satin chrome finish
- Precision ground and lapped measuring surfaces
- Reads direct to .001" or with .100" graduations on beam
- Adjustable bezel with lock • Thumb roll with lock
- 1 1/8" jaw length • Large easy to read dial
- Covered rack • Deluxe fitted case
- Order No. **MDC-03** Jobber \$82.99



6" Digital Caliper

- Accuracy: .0008" under 4" length / .0012" over 4" length
- .0005" (.01mm) resolution • Automatic floating zero
- Used to take inside and outside measurements
- Direct inch/metric conversion
- Large, high-contrast LCD display
- On/Off Button • Deluxe fitted case

Description	Jobber	Order No.
Digital Caliper	\$71.99	EEDC-06
Replacement Battery	6.99	EDC-06B

Use with a one or more dial indicators

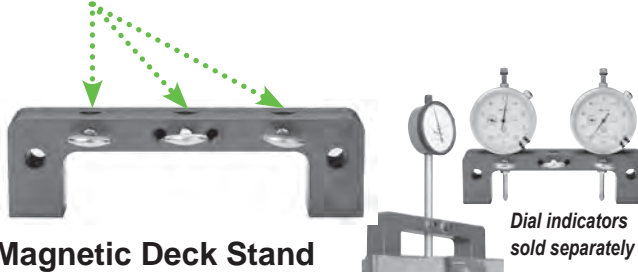

Magnetic Deck Stand

- Precision manufactured with 6 to 8 pounds of magnetic pull yet slides smoothly over the piston dome and deck
- Should only be used with dial indicators (sold separately) in upright position - perpendicular to the ground
- Order No. **MDBS-2** Jobber \$114.99

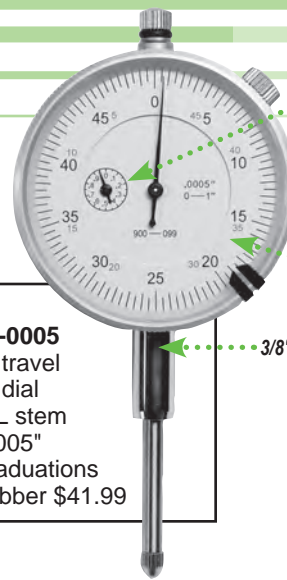

Revolution Counter
(included on most models)

Adjustable bezel
for zero settings

Shatter resistant crystal

3/8" stem

EDI-0005

- 1" travel
- 2" dial
- 1"L stem
- .0005" graduations
- Jobber \$41.99

All indicators
have lug back



EDI-1

- 1" travel • 2" dial
- 1"L stem
- .001" graduations
- Jobber \$32.99



MDI-2

- 2" travel • 3" dial
- 2"L stem
- .001" graduations
- Jobber \$81.99



MDI-12

- .125" travel
- 2" dial
- 12"L stem
- .001" graduations
- Jobber \$474.99



Starrett
Goodson
EXCLUSIVE

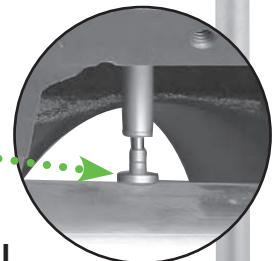

Dial Indicator Flat Anvil

- Use with dial indicator (sold separately) to make full contact on surface to be measured
- Especially useful when measuring deep inside blocks in combination with our magnetic deck stand (MDBS-2 at left)
- Order No. **MDI-12A** Jobber \$42.99

CYLINDER HEAD REBUILDING
CLEANING, ASSEMBLY & SAFETY
SHORT BLOCK REBUILDING
CRANKSHAFT/GRINDING TOOLS & SUPPLIES
MISCELLANEOUS TOOLING
BRAKE SERVICE TOOLS
MEASURING TOOLS
V-TWIN & METRIC HARD PARTS

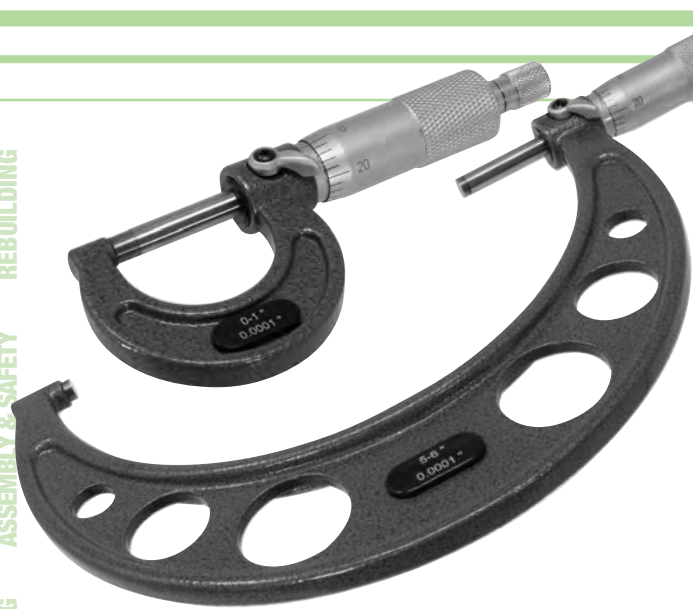

Premium Micrometers

- Precision ground carbide anvil parallel to within .0001"
- .0001" graduations
- Set includes wood storage case

Description	Range	Jobber	Order No.	Incl.
Micrometer Set	(wood storage case)	\$349.99	EMS-06	▼
Individual Micrometers	0"-1" (no standard)	45.99	EMIC-01	x
	1"-2"	51.99	EMIC-12	x
Each Micrometer	2"-3"	57.99	EMIC-23	x
includes a Standard,	3"-4"	66.99	EMIC-34	x
Spanner Wrench & Case	4"-5"	80.99	EMIC-45	x
(except EMIC-01)	5"-6"	82.99	EMIC-56	x

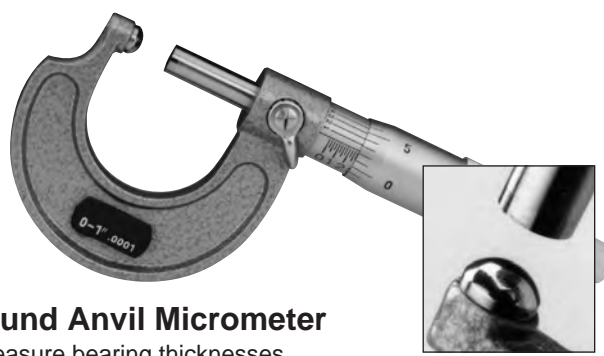

Round Anvil Micrometer

- Measure bearing thicknesses
- Ratchet spindle • 0-1" range • Precise to .0001"
- Order No **MIC-01-B** Jobber \$134.99

Checking Standards

- Use to set up dial indicators in special application gauging and to check micrometer accuracy
- Made of hardened, ground and lapped tool steel
- Meet or exceed federal accuracy specifications



Length	Jobber	Order No.
1"	\$13.49	MCS-1
2"	14.49	MCS-2
3"	15.49	MCS-3

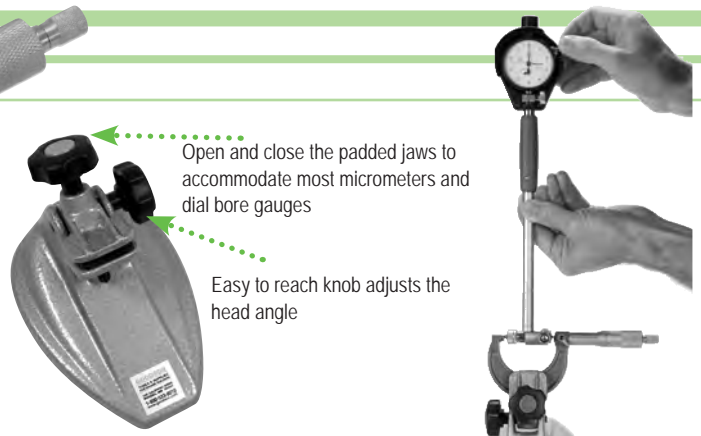

Open and close the padded jaws to accommodate most micrometers and dial bore gauges

Easy to reach knob adjusts the head angle

Micrometer Stand

- Heavy cast iron construction
- Use to hold micrometers, standards or just about anything you need an extra hand for
- Swivel head and padded jaws won't damage expensive measuring tools
- Order No. **MIC-FIX** Jobber \$25.99

Use a Micrometer Stand When Setting Your Dial Bore Gauge

Read more about it on our blog. Scan the code with your smart phone or other smart device for quick access.



Use with Goodson Dial Indicators: EDI-0005, EDI-1 and MDI-12 (page 127)



MBR-1

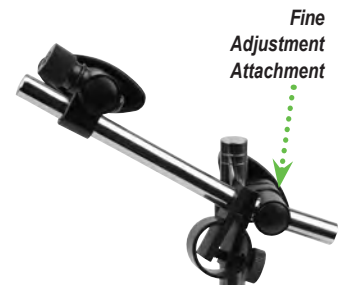

Fine Adjustment Attachment

MBR-1F

Universal Magnetic Base Holders

- Fit any type of dial indicator with lug back
- Magnetic base features an on-off switch with magnetic pull of 110 pounds
- 5/8" diameter 7 1/4" high vertical column
- 3.45" x 1.97" x 2.187" base
- Available with or without fine adjustment feature

Description	Jobber	Order No.
Universal Holder	\$45.99	MBR-1
With Fine Adjustment	47.99	MBR-1F

V-Twin On-the-Engine Valve Spring Compressor

Replace broken valve springs, install high performance valve springs, remove and replace valve guide seals all without disassembling the bike – just remove the gas tank and get to work. Use on Sportster, Evolution, Twin-Cam and most aftermarket V-Twins. Kit includes valve spring compressor, adaptor for compressing beehive springs, valve seal driver/installer and head pressurizing hose. Order No. **CF-HDIF** Jobber \$189.99

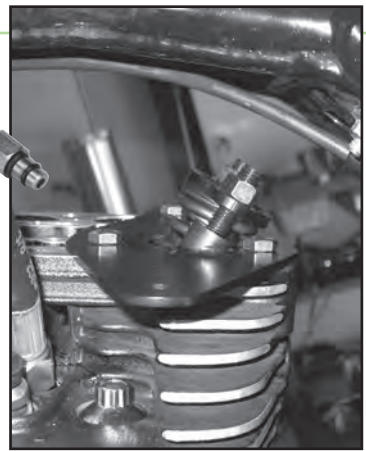

Pan/Shovel Spring Seat Cutting Tool

- Convert Pan & early Shovel to late style Shovel easily to attain higher lift
- Spacer stops the cutter at the correct height for uniform spring spacing
- Use with lower spring collars or stock late style lower spring collars (1980-1984) • OD: 1.680" • ID: 0.750"



Description	Jobber	Order No.
Spring Seat Cutting Tool	\$117.99	VSS-1680HD
.375" Spring Pad Pilot	42.99	VP-375

Guide Driver for Reduced Diameter Top Valve Guides

The guide top fits into the groove between the driver and the bushing to center and drive the guide into place. Puts pressure on the step top of the guide, not the seal area. Required for installing 20-2120 & 20-2130 series guides on page 134. Order No. **VGD-315420** Jobber \$49.99



Keeper Installation Tools

- Spring-loaded plunger
- For single & multi-groove keepers
- Reaches keeper grooves located farther from the valve tip • Ideal for use with **CF-500** (p. 43) or **PSB-5000** (p. 42)

Size	Jobber	Order No.
5mm / .2031"	\$99.99	VKI-5
6mm / .2344"	99.99	VKI-6
7mm / .2812"	99.99	VKI-7
8mm / .3125"	99.99	VKI-8
Replacement Rubber Sleeve	7.99	VKI-56

Best Keeper Tool on the Market!

One of the handiest keeper tools you'll ever find!

Keeper Magnet

- 6⁵/₁₆" long holder fits easily into deep bores
- Powerful .170" diameter earth magnet holds keepers securely when removing or installing
- Order No. **VKM-17** Jobber \$19.99

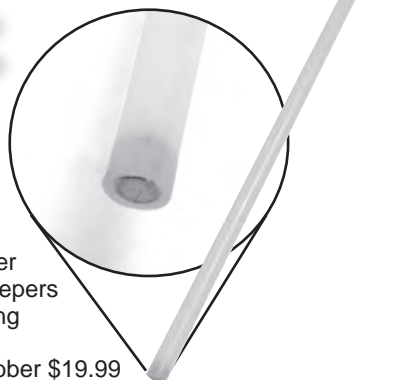

.421" Valve Seal Cutter

- Evo/Twin Cam
- Will shorten and re-chamfer the guide top, increasing seal-to-retainer clearance for higher lift camshafts
- Can also be used to modify .530" guides to .421" guides
- Guide OD: .421" • Pilot Size: .312"
- Use with 71010 seal (page 133)
- Order No. **VSC-420312** Jobber \$136.99



Universal Seal Pliers

- Works on OHC and in-line engines with recessed springs
- Long, serrated jaws reach into confined areas and grip seals firmly
- Heat-treated steel with easy-grip handles
- Order No. **VSP-823** Jobber \$67.99



CYLINDER HEAD REBUILDING ASSEMBLY & SAFETY CLEANING, SHORT BLOCK REBUILDING FLYWHEEL GRINDING TOOLS & SUPPLIES MISCELLANEOUS TOOLING BRAKE SERVICE TOOLS MEASURING TOOLS V-TWIN & METRIC HARD PARTS

CYLINDER HEAD REBUILDING
CLEANING, ASSEMBLY & SAFETY
SHORT BLOCK REBUILDING
CRANKSHAFT/ FLYWHEEL GRINDING
MISCELLANEOUS TOOLS & SUPPLIES
BRAKE SERVICE TOOLING
MEASURING TOOLS
V-TWIN & METRIC PARTS



.415" Lift Panhead™
1948 to 1965
Valve Spring Kit for 3/8" Valve Stems

- OE Replacement
- Fits Intake Valve 20-4257 and Exhaust Valve 20-4195
- Heat-treated and shot peened for long life • Kits include 4 Retainers, 4 Springs, 4 Keepers & 4 Base Washers

Max Lift	Installed Height	Seat Pressure	Open Pressure	@ Lift	MSRP	Jobber	Order No.
.415"	1.375"	129 lbs.	272 lbs.	.415"	\$129.79	\$106.37	20-20430

.600" Lift Shovelhead™
1966 to 1977

Valve Spring Kit For 3/8" Valve Stems

- Lightweight Racing Kits include 4 Retainers, 4 Springs, 4 Keepers and 4 Base Washers • Lightweight, hard anodized 7075T-6 Retainers offset .070" for taller installed height • Base Washers counter-bored for a .665" OD seal
- Use with Intake Valve 20-4194 & Exhaust Valve 20-4195

Max Lift	Installed Height	Seat Pressure	Open Pressure	@ Lift	MSRP	Jobber	Order No.
.600"	1.510"	150 lbs.	385 lbs.	.600"	\$147.47	\$128.74	20-2110

.600" Lift Evolution™
1984 to 1999
Valve Spring Kit For 5/16" Valve Stems

- Heat-treated and shot peened for long life
- Lightweight Racing Kits include 4 Retainers, 4 Springs, 4 Keepers & 4 Base Washers
- Use with Intake Valve 20-4171 & Exhaust Valve 20-4170

Max Lift	Installed Height	Seat Pressure	Open Pressure	@ Lift	MSRP	Jobber	Order No.
.600"	1.810"	163 lbs.	361 lbs.	.600"	\$148.02	\$121.31	20-20132

.600" Lift Shovelhead™
1966 to 1977

Valve Spring Kit For 3/8" Valve Stems

- Springs heat-treated and shot peened for long life
- Lightweight Racing Kits include 4 Steel Retainers, 4 Springs, 4 Keepers and 4 Base Washers
- Use with Intake Valve 20-4194 & Exhaust Valve 20-4195

Max Lift	Installed Height	Seat Pressure	Open Pressure	@ Lift	MSRP	Jobber	Order No.
.600"	1.510"	150 lbs.	385 lbs.	.600"	\$142.97	\$117.17	20-20450

.655" Lift Evolution™
1984 to 1999
Valve Spring Kit For 5/16" Valve Stems

- Springs heat-treated and shot peened for long life
- Lightweight Racing Kits include 4 Retainers, 4 Springs, 4 Keepers and 4 Base Washers
- Use with Intake Valve 20-4171 & Exhaust Valve 20-4170

Max Lift	Installed Height	Seat Pressure	Open Pressure	@ Lift	MSRP	Jobber	Order No.
.655"	1.860"	190 lbs.	465 lbs.	.655"	\$228.42	\$187.21	20-20081

.415" Lift Shovelhead™
1966 to 1977
Valve Spring Kit For 3/8" Valve Stems

- Springs heat-treated and shot peened for long life
- OE Replacement Kit includes 4 Steel Retainers, 4 Springs, 4 Keepers and 4 Base Washers
- Use with Intake Valve 20-4194 & Exhaust Valve 20-4195

Max Lift	Installed Height	Seat Pressure	Open Pressure	@ Lift	MSRP	Jobber	Order No.
.415"	1.375"	129 lbs.	272 lbs.	.415"	\$129.75	\$106.37	20-20435

Ensure Your Valve Springs Are Set Correctly with a Valve Spring Tester from Goodson

See page 41



Compression Release Valves

- 2 per pack
- 10 x 1.0mm thread
- High temperature resistant knobs
- Shorter thread section makes installation easier with less drilling than required with OE-style



Application	Length	Thread	MSRP	Jobber	Order No.
Evolution	1.400"	.350"L	\$49.71	\$35.31	20-21250
Twin Cam	1.730"	.350"L	49.71	35.31	20-21255
OE Replacement	1.750"	.500"L	49.71	35.31	20-21260



.610" Max Lift Beehive Valve Spring Set for 5/16" Valves

- Advanced spring design with special attention to cam and spring harmonics, stress, mass and operating RPM
- Premium grade, super clean ground chrome silicon wire
- Kits include 4 Retainers, 4 Springs, 4 Keepers and 4 Base Washers • Supersedes HVS-6000S

Max Lift	Installed Height	Seat Pressure	Open Pressure	@ Lift	MSRP	Jobber	Order No.
.610"	1.860"	175 lbs.	400 lbs.	.610"	\$184.99	\$139.85	20-21300

.660" Max Lift Beehive Valve Spring Sets for 5/16" Valves

- 9° taper • Advanced spring design with special attention to cam and spring harmonics, stress, mass & operating RPM
- Premium grade, super clean ground chrome silicon wire
- Kits include 4 Retainers, 4 Springs, 4 Keepers and 4 Base Washers • Supersedes HVS-6500S

Max Lift	Installed Height	Seat Pressure	Open Pressure	@ Lift	MSRP	Jobber	Order No.
.660"	1.860"	178 lbs.	371 lbs.	.660"	\$207.41	\$147.33	20-21500

.610" Max Lift Beehive Valve Spring Sets for 7mm Valves

- Advanced spring design
- Premium grade, super clean ground chrome silicon wire
- Kits include 4 Retainers, 4 Springs, 4 Keepers 4 Viton Seals and 4 Base Washers • Supersedes HVS-6000-7SG

Max Lift	Installed Height	Seat Pressure	Open Pressure	@ Lift	MSRP	Jobber	Order No.
.610"	1.860"	175 lbs.	400 lbs.	.610"	\$184.99	\$131.41	20-21400

.660" Max Lift Beehive Valve Spring Sets for 7mm Valves

- 9° taper
- Advanced spring design
- Premium grade, super clean ground chrome silicon wire
- Kits include 4 Retainers, 4 Springs, 4 Keepers, 4 Viton Seals and 4 Base Washers • Supersedes HVS-6500-7SG

Max Lift	Installed Height	Seat Pressure	Open Pressure	@ Lift	MSRP	Jobber	Order No.
.660"	1.860"	178 lbs.	371 lbs.	.660"	\$214.17	\$152.13	20-21550

Evolution™ (04-99), Evo Sportster™ 883cc (96-03) XL™ 1100cc (86-87), Evo Sportster™ 1200cc (88-20), Twin Cam™ 88" (99-04) & Buell™ XB9-XB-12 (03-10)



20-21650



20-23650

Lightweight Racing Dual Spring Kits

- Exact match for installation heights and spring pressures
- Retainers designed for optimum rocker cover clearance
- Includes 4 heavy-duty 9° high-temperature steel keepers, 4 springs, 4 retainers and 4 base washers

Max Lift	Installed Height	Seat Pressure	Open Pressure	@ Lift	MSRP	Jobber	Order No.
Fit 5/16" Valve Stems High Temperature Steel Retainers and BaseWashers Seals Sold Separately							
.650"	1.860"	185 lbs.	440 lbs.	.650"	\$219.85	\$156.17	20-21650
.675"	1.860"	185 lbs.	450 lbs.	.675"	219.39	155.84	20-21600
Fit 7mm Valve Stems High Temperature Steel Retainers and BaseWashers Seals Included							
.650"	1.860"	185 lbs.	440 lbs.	.650"	\$226.58	\$123.59	20-23500
.675"	1.860"	185 lbs.	450 lbs.	.675"	226.58	123.59	20-23600
Fit 7mm Valve Stems Titanium Retainers and High Temperature Steel BaseWashers Seals Included							
.650"	1.860"	185 lbs.	440 lbs.	.650"	\$373.06	\$265.73	20-23550
.675"	1.860"	185 lbs.	450 lbs.	.675"	373.06	265.73	20-23650

CYLINDER HEAD
REBUILDING
ASSEMBLY & SAFETY
CLEANING
SHORT BLOCK
REBUILDING
FLYWHEEL GRINDING
CRANKSHAFT/
TOOLS & SUPPLIES
MISCELLANEOUS
BRAKE SERVICE
TOOLING
MEASURING
TOOLS
V-TWIN & METRIC
HARD PARTS

... another satisfied customer

"No complaints! Been in this business 40 years. Goodson is one of the best companies I've dealt with."

- Joe James, Brighton, CT - Goodson Customer since 2002



White Diamond® Hard Chrome Replacement Valves for Milwaukee-Eight™ Heads

- 1-piece forged with White Diamond® hard chrome stems for impervious wear resistance
- Inconel® 751 exhaust valves designed to outperform in the most extreme forced induction or racing applications
- Flow bench tested to optimize intake and exhaust profiles

Type	Head Dia.	Stem Dia.	Radius	Angle	OAL	MSRP	Jobber	Order No.	Material	Supersedes
Intake	1.614" (41.00mm)	0.2347"	0.235"	15°	4.035"	\$31.01	\$25.66	20-21060H	Chrome	-----
Intake	1.630" (41.40mm)	0.2347"	0.235"	10°	4.055"	31.01	25.42	20-21009H	Chrome	20-21009
Intake	1.654" (42.01mm)	0.2347"	0.235"	15°	4.032"	31.01	27.80	20-21061H	Chrome	20-21014
Exhaust	1.264" (32.11mm)	0.2342"	0.460"	24°	4.050"	31.01	27.80	20-21016H	Chrome	20-21016
Exhaust	1.284" (32.61mm)	0.2342"	0.460"	24°	4.050"	31.01	27.80	20-21017H	Chrome	20-21017
Exhaust	1.299" (32.99mm)	0.2342"	0.395"	0°	4.055"	34.99	29.99	20-21062K	Chrome	-----



Milwaukee-Eight™ Beehive Spring Kits

- Includes 8 progressively wound ovate wire Beehive Springs, 8 Retainers, 8 Tophat Seals and 8 Spring Bases

Max Lift	Installed Height	Seat Pressure	Open Pressure	@ Lift	MSRP	Jobber	Order No.
Titanium Retainers							
.625"	1.500"	85 lbs.	280 lbs.	.625"	\$416.13	\$341.05	20-21800
Heat Treated Steel Retainers							
.625"	1.500"	85 lbs.	280 lbs.	.625"	332.91	272.85	20-21850

Milwaukee-Eight™ Beehive Valve Spring Kits

- Advanced spring design with special attention to cam and spring harmonics, stress, mass and operating RPM
- Premium-grade, super clean ground chrome silicon wire • Heat-treated and shot peened for long life

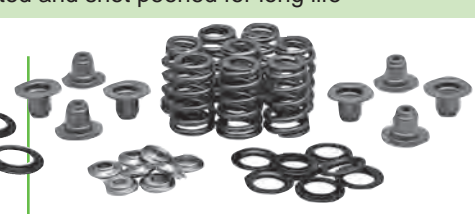
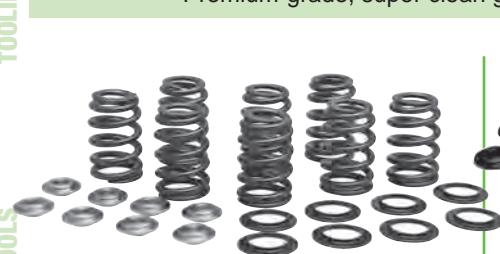

.465" Max Lift Beehive Valve Spring Kit With Titanium Retainers

- Includes 8 retainers, 8 springs and 8 base washers
- Installed Height: 1.410"
- Seat Pressure: 80 lbs.
- Open Pressure: 212 lbs. at .465"
- Order No. **20-21000**

MSRP: \$313.38 | Jobber: **\$229.28**

.465" Max Lift Beehive Valve Spring Kit With Heat Treated Steel Retainers

- Includes 8 retainers, 8 springs and 8 base washers
- Installed Height: 1.410"
- Seat Pressure: 80 lbs.
- Open Pressure: 212 lbs. at .465"
- Order No. **20-21050**

MSRP: \$250.70 | Jobber: **\$205.479**

.550" Max Lift Beehive Valve Spring Kit With Titanium Retainers

- Supersedes #20-21200
- Includes 8 retainers, springs, base washers and viton tophat seals
- Installed Height: 1.550"
- Seat Pressure: 85 lbs.
- Open Pressure: 257 lbs. at .550"
- Order No. **20-21205**

MSRP: \$416.13 | Jobber: **\$346.49**

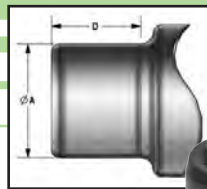

Solid Viton Seals With Metal Jacket & Choker Spring

• 16 Per Package

Stem Dia.	OAL	Seal OD	A	D	MSRP	Jobber	Order No.	Supersedes
7.0mm	0.510"	0.665"	0.560"	0.375"	\$50.25	\$41.18	71028	HVS-7MM
.312"	0.412"	0.566"	0.420"	0.275"	25.73	21.47	71010	HVS-421
.312"	0.514"	0.671"	0.530"	0.330"	50.25	41.18	71045	HVS-531
.375"	0.516"	0.661"	0.562"	0.375"	29.37	24.07	71011	—

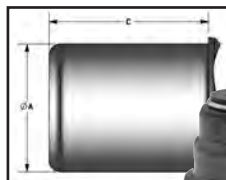

Solid Viton Seals With Metal Jacket & Integral Spring Base

• 16 Per Package

• Spring Shoulder Diameter: 0.970"

Stem Dia.	OAL	Seal OD	A	C	MSRP	Jobber	Order No.	Supersedes
7.0mm	0.974"	1.457"	0.560"	0.700"	\$36.94	\$30.27	71030	HV-7MMOE



Milwaukee-Eight™ Tophat Valve Seal

• 16 Per Package

Stem Dia.	OAL	Seal OD	A	C	MSRP	Jobber	Order No.	Supersedes
6.0mm	0.712"	1.170"	—	—	\$36.94	\$25.49	71046-16	—

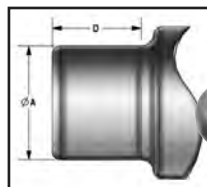

OE Style Seals Solid Teflon With Metal Jacket

16 Per Package

Stem Dia.	OAL	Seal OD	A	D	MSRP	Jobber	Order No.	Supersedes
.312"	0.385"	0.565"	0.420"	0.315"	\$29.37	\$24.07	71032	HSS-420
.312"	0.375"	0.630"	0.530"	0.295"	29.37	24.07	71033	HSS-530312
.343"	0.375"	0.630"	0.530"	0.365"	29.37	24.07	71034	HSS-530343
.375"	0.375"	0.660"	0.562"	0.315"	29.37	24.07	71035	HSS-562
.375"	0.400"	0.720"	0.625"	0.310"	29.37	24.07	71036	HSS-625

Need something not listed here?

We can order just about anything in the Kibblewhite catalog for you.

Call us at 1-800-533-8010 for more information.

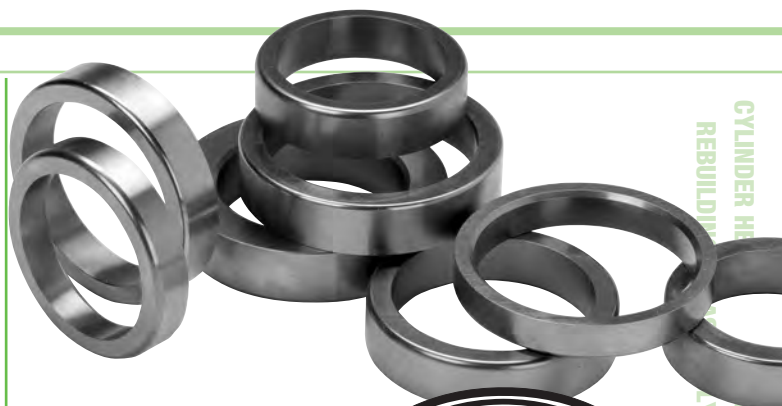

Valve Seat Inserts

- For Harley-Davidson®
- Easy to machine
- Effectively dissipate heat for consistent valve sealing
- Hardness increases during engine break-in
- Radiused for easy installation



Replacement Valve Seats For Shovel Head 1200 & 1340

Application	OD	ID	Thick	MSRP	Jobber	Order No.	Supersedes
Exhaust	1.944"	1.575"	.400"	\$14.47	\$10.29	10-HC493	HVS-1944
Intake	2.135"	1.750"	.400"	14.47	10.29	10-HC542	HVS-2135

Oversize Seats For Shovel, Evolution, Twin Cam & M8 – machining required

	OD	ID	Thick	MSRP	Jobber	Order No.	Supersedes
Fits M8	1.630"	1.180"	.385"	\$14.47	\$10.29	10-HC414	HVS-1630
	1.757"	1.410"	.430"	14.47	10.29	10-HC447	HVS-1757
	1.882"	1.520"	.410"	14.47	10.29	10-HC478	HVS-1882
	2.008"	1.610"	.440"	14.47	10.29	10-HC510	HVS-2008
	2.040"	1.700"	.425"	14.47	10.29	10-HC518	HVS-2040
	2.070"	1.610"	.460"	14.47	10.29	10-HC526	HVS-2070
	2.132"	1.800"	.460"	14.47	10.29	10-HC541	HVS-2132
	2.163"	1.750"	.455"	14.47	10.29	10-HC549	HVS-2163

For Iron Head Sportster

Application	OD	ID	Thick	MSRP	Jobber	Order No.	Supersedes
Exhaust	1.757"	1.371"	.315"	\$14.47	\$10.29	10-HC446	HVS-1757S
Intake	2.068"	1.750"	.315"	14.47	10.29	10-HC525	HVS-2068

Universal Repair Seat

	OD	ID	Thick	MSRP	Jobber	Order No.	Supersedes
Powdered	1.339"	1.024"	.375"	\$ 8.98	\$ 10.29	10-SC340	MVS-42
Metal	1.693"	1.299"	.434"	10.55	10.29	10-SC430	MVS-58
	1.819"	1.375"	.450"	14.47	10.29	10-HC462	HVS-1820
	1.945"	1.500"	.450"	14.47	10.29	10-HC494	HVS-1945
	2.257"	1.870"	.450"	14.47	10.29	10-HC573	HVS-2257

Nickel Chrome Valve Seats on Page 16

tech tips When installing seats preheat head to 400° and freeze the seat for easier installation. Press fit .006" to .008".



6061-T6 Aluminum Seal Drivers

These installation tools for OE style seals are manufactured from high strength 6061-T6 Aluminum for increased durability when compared to plastic installers.

Application	Color	Fits Seal Up To	Order No.
Evolution	Red	0.575"	20-20830
Pan/Shovelhead 74"	Black	0.673"	20-20833
Ironhead Sportster	White	0.638"	20-20832
Shovelhead 80"	Blue	0.758"	20-20831

MSRP: \$8.58

Jobber \$8.24

... another satisfied customer

"Thank you for a good supply of tooling. Everyone there is very helpful. You don't always find that anymore."
- John Bursick, Harts Machine Service, Cecil, OH, Goodson Customer since 1997

CYLINDER HEAD REBUILDING
CLEANING, ASSEMBLY & SAFETY
SHORT BLOCK REBUILDING
CRANKSHAFT/ FLYWHEEL GRINDING
MISCELLANEOUS TOOLS & SUPPLIES
BRAKE SERVICE TOOLING
MEASURING TOOLS
V-TWIN & METRIC HARD PARTS

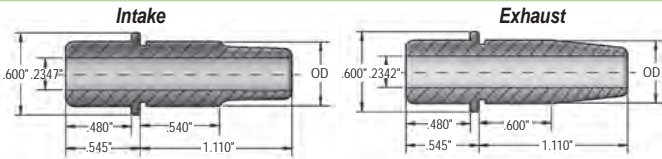

Milwaukee-Eight™ Valve Guides

• Use with 6mm seals (71046 or OE)

Intake				Manganese Bronze	Cast Iron	
OD	ID	OAL	Size			
.4750"	.2347"	1.655"	Std.	20-21020M	—	
.4760"			+ .001"	20-21021M	—	
.4770"			+ .002"	20-21022M	20-21022C	
.4850"			+ .010"	20-21029M	20-21029C	
Exhaust				Manganese Bronze	Cast Iron	
OD	ID	OAL	Size			
.4750"	.2342"	1.655"	Std.	20-21030M	20-21030C	
.4760"			+ .001"	20-21031M	20-21031C	
.4770"			+ .002"	20-21032M	20-21032C	
.4850"			+ .010"	20-21039M	20-21039C	
MSRP / Jobber				\$13.12 / \$10.79	\$8.83 / \$7.29	

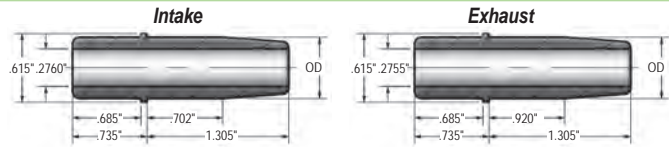

Twin Cam & Evo Sportster w/ 7mm Valves

• Use with 71028 (0.562") Viton Seals

Intake				Manganese Bronze	Cast Iron	Supersedes
OD	ID	OAL	Size			
.5625"	.2760"	2.040"	Std.	20-20690M	—	HVG-6600
.5635"			+ .001"	20-20691M	—	HVG-6601
.5645"			+ .002"	20-20692M	—	HVG-6602
.5725"			+ .010"	20-20699M	—	
Exhaust				Manganese Bronze	Cast Iron	Supersedes
OD	ID	OAL	Size			
.5620"	.2755"	2.040"	Std.	20-20700M	—	HVG-6700
.5630"			+ .001"	20-20701M	—	HVG-6701
.5640"			+ .002"	20-20702M	—	HVG-6702
.5720"			+ .010"	20-20709M	—	
MSRP / Jobber				\$13.12 / \$10.79		

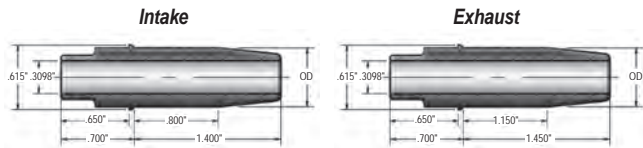

Evolution, Twin-Cam & Evo Sportster With 5/16" Valves (.420" Guide Top)

• Use with 71010 Viton Seals or 71032 OE Style Seals

Intake				Manganese Bronze	Cast Iron	Supersedes
OD	ID	OAL	Size			
.5620"	.3098"	2.100"	Std.	20-2120M	20-2120C	
.5630"			+ .001"	20-2121M	20-2121C	HVG-5600S
.5640"			+ .002"	20-2122M	20-2122C	HVG-5601S
.5720"			+ .010"	20-2129M	—	
Exhaust				Manganese Bronze	Cast Iron	Supersedes
OD	ID	OAL	Size			
.5620"	.3098"	2.150"	Std.	20-2130M	20-2130C	
.5630"			+ .001"	20-2131M	20-2131C	HVG-5700S
.5640"			+ .002"	20-2132M	20-2132C	HVG-5701S
.5720"			+ .010"	20-2139M	—	
MSRP / Jobber				\$13.12 / \$10.79	\$8.83 / \$7.29	

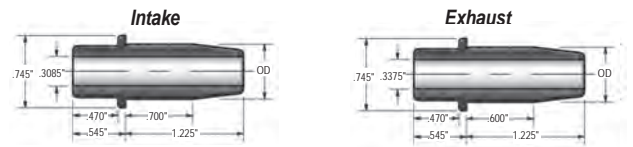

Sportster (1970-1983)

• Use with 71033 (intake) & 71034 (exhaust) OE-Style Seals

Intake				Manganese Bronze	Cast Iron	Supersedes
OD	ID	OAL	Size			
.5650"	.3085"	1.770"	Std.	—	20-2320C	HVG-5100C
.5660"			+ .001"	—	20-2321C	HVG-5101C
.5670"			+ .002"	—	20-2322C	HVG-5102C
Exhaust				Manganese Bronze	Cast Iron	Supersedes
OD	ID	OAL	Size			
.5650"	.3375"	1.770"	Std.	—	20-2330C	HVG-5200C
.5660"			+ .001"	—	20-2331C	HVG-5201C
.5670"			+ .002"	—	20-2332C	HVG-5202C
MSRP / Jobber					\$8.83 / \$7.29	

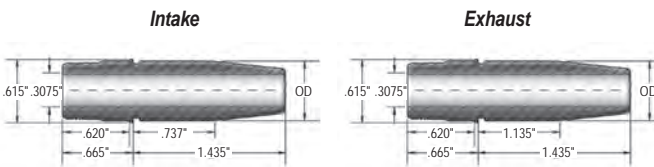

Evolution, Twin-Cam & Evo Sportster With 5/16" Valves (.530" Top Guides)

• Use with 71045 Viton Seals

Intake				Manganese Bronze	Cast Iron	Supersedes
OD	ID	OAL	Size			
.5625"	.3075"	2.100"	Std.	20-20860M	—	HVG-5600
.5635"			+ .001"	20-20861M	—	HVG-5601
.5645"			+ .002"	20-20862M	—	HVG-5602
Exhaust				Manganese Bronze	Cast Iron	Supersedes
OD	ID	OAL	Size			
.5625"	.3096"	2.100"	Std.	20-20870M	—	HVG-5700
.5635"			+ .001"	20-20871M	—	HVG-5701
.5645"			+ .002"	20-20872M	—	HVG-5702
.5725"			+ .010"	20-20879M	—	
MSRP / Jobber				\$13.12 / \$10.79		

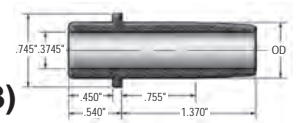

Shovel Head 80" (78-83)

• Use with 71036 OE Style Seals

Intake or Exhaust				Manganese Bronze	Cast Iron	Supersedes
OD	ID	OAL	Size			
.6250"	.3745"	1.910"	Std.	20-2050M	20-2050C	HVG-5400
.6260"			+ .001"	20-2051M	20-2051C	HVG-5401
.6270"			+ .002"	20-2052M	20-2052C	HVG-5402
MSRP / Jobber				\$13.12 / \$10.79	\$8.83 / \$7.29	

Shovel & Pan Heads

• Use with 71011 Viton seals or 71035 OE Style Seals

Intake or Exhaust				Manganese Bronze	Cast Iron	Supersedes
OD	ID	OAL	Size			
.5650"	.3760"	1.900"	Std.	20-2020M	20-2020C	
.5660"			+ .001"	20-2021M	20-2021C	
.5670"			+ .002"	20-2022M	20-2022C	
.5680"			+ .003"	20-2023M	20-2023C	
.5750"			+ .010"	20-2029M	20-2029C	
MSRP / Jobber				\$13.12 / \$10.79	\$8.83 / \$7.29	

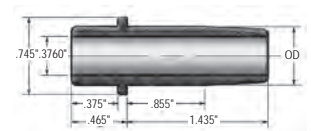

High Performance Valves



tech tips Always check and confirm running clearances when installing new valves.
from the techxperts™

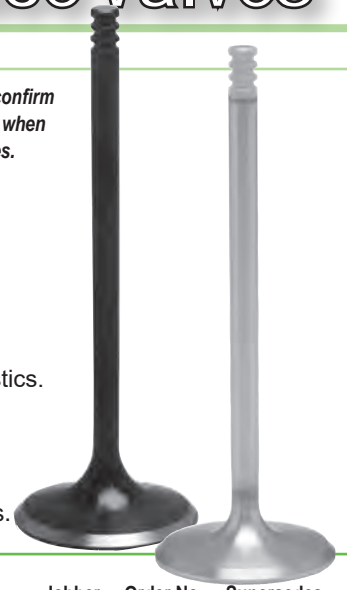

Black Diamond™ & White Diamond® Valves for Harley-Davidson® Engines

- **Light and strong with optimum airflow** A combination of stress analysis and flow bench testing for optimally balanced valve mass, strength and airflow characteristics.
- **Black Diamond™ Valves** One piece forged stainless steel valves impregnated by a special German process to improve wear properties and reduce friction. Provides resistance to corrosion and superior wear.
- **Chrome Diamond® Valves** One piece forged with White Diamond® hard chrome stems. Inconel® 751 exhaust valves are designed to perform even in the most extreme conditions. Flow bench tested to optimize intake and exhaust profiles.

Application	Type	Head Diameter	Stem Diameter	Tulip		Overall Length	MSRP	Jobber	Order No.	Supersedes
Milwaukee-Eight	Intake	1.571" (39.90mm)	0.2347"	0.235"	10°	4.015"	\$31.01	\$27.48	20-21012H	20-21012
	Intake	1.614" (41.00mm)	0.2347"	0.235"	15°	4.035"	31.01	25.66	20-21060H	-----
	Intake	1.630" (41.40mm)	0.2347"	0.235"	10°	4.055"	31.01	25.42	20-21009H	20-21009
	Intake	1.654" (42.01mm)	0.2347"	0.235"	15°	4.032"	31.01	27.80	20-21061H	20-21014
	Exhaust	1.264" (32.11mm)	0.2342"	0.460"	24°	4.050"	31.01	27.80	20-21016H	20-21016
	Exhaust	1.284" (32.61mm)	0.2342"	0.460"	24°	4.050"	31.01	27.80	20-21017H	20-21017
Pan Head 1948-1965 Black Diamond™	Intake	1.750" (44.45mm)	0.3765"	0.234"	23°	3.800"	31.01	25.42	20-4257	-----
	Exhaust	1.750" (44.45mm)	0.3760"	0.234"	29°	3.820"	26.62	21.82	20-4195	-----
Sportster 1970-1983	Intake	1.935" (49.15mm)	0.3090"	0.256"	23°	3.620"	37.55	32.95	20-4196	HEV-5
	Intake	1.950" (49.53mm)	0.3090"	0.256"	23°	3.690"	37.55	30.78	20-4167	-----
	Exhaust	1.570" (39.88mm)	0.3384"	0.236"	29°	3.512"	37.55	32.95	20-4197	HEV-3
Shovelhead 74" & 80" 1966-1983	Intake	1.950" (49.53mm)	0.3765"	0.234"	23°	3.885"	26.62	21.82	20-4194	HEV-9
	Intake	2.000" (50.80mm)	0.3765"	0.234"	23°	3.885"	31.01	25.42	20-4256	-----
	Exhaust	1.750" (44.45mm)	0.3760"	0.234"	29°	3.810"	26.62	21.82	20-4195	HEV-7
Shovelhead 74" & 80" 66-83 "Fat Stem"	Intake	1.950" (49.53mm)	0.3780"	0.234"	23°	3.885"	31.01	25.42	20-4294	-----
	Exhaust	1.750" (44.45mm)	0.3775"	0.234"	29°	3.810"	31.01	25.42	20-4295	-----
Evolution 1984-1999	Intake	1.840" (46.74mm)	0.3100"	0.236"	23°	4.445"	29.81	24.43	20-4171	-----
	Intake	1.940" (49.28mm)	0.3108"	0.675"	25°	4.440"	41.12	29.21	20-20910	HBV-1940
	Intake	1.900" (48.26mm)	0.3108"	0.675"	25°	4.440"	41.12	29.21	20-20915	HBV-1900
	Intake (Racing)	1.900" (48.26mm)	0.3100"	0.344"	28°	4.420"	26.62	24.68	20-4171R	HBV-1900S
	Intake	2.150" (54.61mm)	0.3108"	0.550"	24°	4.480"	41.12	29.21	20-20900	HCV-2150
	Exhaust	1.615" (41.02mm)	0.3096"	0.236"	29°	4.525"	29.81	24.43	20-4170	HEV-10
	Exhaust (Racing)	1.630" (41.40mm)	0.3096"	0.500"	40°	4.525"	26.62	21.82	20-4170R	-----
	Exhaust	1.650" (41.91mm)	0.3106"	0.750"	25°	4.515"	41.12	29.21	20-20920	HBV-1650
	Exhaust	1.610" (40.89mm)	0.3106"	0.750"	25°	4.510"	41.12	29.21	20-20925	HBV-1610D
	Exhaust	1.585" (40.26mm)	0.3106"	0.750"	25°	4.505"	41.12	29.21	20-20930	HBV-1585
Evo Sportster 883 to 1200cc	Intake	1.715" (43.56mm)	0.3100"	0.236"	23°	4.550"	37.55	30.78	20-2010	HBV-1720
	Exhaust	1.480" (37.59mm)	0.3096"	0.500"	40°	4.625"	37.55	30.78	20-2012	-----
Twin Cam 88"-103" 2005-2017	Intake	1.805" (45.85mm)	0.2760"	0.413"	1.700°R	4.420"	31.01	30.78	20-20322	HBV-1810-7TG
	Intake	1.900" (48.26mm)	0.2760"	0.344"	28°	4.420"	37.55	25.42	20-20323R	-----
	Exhaust	1.575" (40.00mm)	0.2755"	0.354"	22°	4.520"	41.12	30.78	20-20325	-----
	Exhaust	1.630" (41.40mm)	0.2755"	0.500"	34°	4.520"	31.01	30.78	20-20326R	-----
Buell® XB9™ 2003-2007	Intake	1.805" (45.85mm)	0.2760"	0.344"	28°	4.525"	54.10	43.05	20-20260	-----
	Intake	1.900" (48.26mm)	0.2760"	0.344"	28°	4.500"	54.10	44.34	20-20262	-----
Twin Cam, Sportster & Buell® Triple Groove	Intake	1.980" (50.29mm)	0.2757"	0.290"	23°	4.455"	51.79	36.79	20-20935	HBV-1980-7TG
	Intake	1.900" (48.26mm)	0.2757"	0.475"	24°	4.445"	51.79	36.79	20-20940	HBV-1900-7TG
	Exhaust	1.610" (40.89mm)	0.2755"	0.595"	25°	4.545"	51.79	36.79	20-20945	HBV-1610-7TG
Evo, Big Twin & Twin Cam	Intake	2.020" (51.31mm)	0.3108"	0.670"	25°	4.440"	41.12	29.21	20-20990	HBV-2020A
	Exhaust	1.700" (43.18mm)	0.3106"	0.600"	25°	4.535"	41.12	29.21	20-20960	HBV-1700A
S&S®, Screaming Eagle & Ultima®	Intake	2.020" (51.31mm)	0.3108"	0.645"	25°	4.510"	41.12	29.21	20-20965	HBV-2020S
SE® / JIMS®	Exhaust	1.610" (40.89mm)	0.3106"	0.750"	25°	4.565"	41.12	29.21	20-20970	HBV-1610S
Blank Valves	Black	2.100" (53.34mm)	0.3108"	-----	24°	5.700"	37.53	27.57	20-20980	HBV-1700BC
	Chrome	2.200" (55.88mm)	0.3108"	-----	25°	5.700"	37.53	27.57	20-20975	HCV-2200BC

CYLINDER HEAD
REBUILDING
CLEANING,
ASSEMBLY & SAFETY
SHORT BLOCK
REBUILDING
CRANKSHAFT/
FLYWHEEL GRINDING
TOOLS & SUPPLIES
MISCELLANEOUS
BRAKE SERVICE
TOOLING
MEASURING
TOOLS
V-TWIN & METRIC
HARD PARTS

RAPIDEX

A rapid-use index of product categories

Cylinder Head Rebuilding

Pilots.....	3-5
Valve Seat Work.....	6-24
Valve Refacing.....	25-29
Reamers.....	30-31
Valve Guide Resizing.....	32-34
Valve Guide Replacement.....	35-39
Valve Seal Work.....	40
Valve Spring Work.....	41-46
Cylinder Head Resurfacing.....	48-51
Crack Detection & Repair.....	52-55
Porting & Polishing.....	58-60

Cleaning, Assembly & Safety

Parts Storage & Organizers.....	61-63
Parts Baskets.....	63
Wire Wheels & Brushes.....	64-65
Cleaning.....	66-69
Last Blast Paint & Metal Markers.....	70
Assembly Lubes.....	71
Coolants & Lubricants.....	72-74

Index	75-82
Flex-Hones®.....	83

Short Block Rebuilding

Boring Bar Tooling & Supplies.....	84-85
Cylinder Honing.....	86-91
Rod Honing.....	92
Rod & Piston Work.....	93-97
Lifter Bore Tooling.....	99
Camshaft Work.....	100-101

Crankshaft/Flywheel Grinding

Crankshaft Grinding Wheels.....	102-103
Crankshaft Grinding & Polishing.....	105-109
Flywheel Grinding.....	110-113

Miscellaneous Tools

Diamond Dresser Tools.....	114-115
Miscellaneous.....	116

Brake Service Tooling

Brake Tips & Holders.....	117-118
Brake Lathe Silencers.....	119
Brake Lathe Replacement Parts.....	120-122

Measuring Tools

Straight Edges.....	123
Dial Bore Gauges.....	125-126
Calipers & Dial Indicators.....	127
Micrometers.....	129

V-Twin Hard Parts

Valve Springs.....	130-132
Seats & Seat Inserts.....	133
Valve Guides.....	134
Replacement Valves.....	135

© Copyright 2024, Goodson Mfg. Co., Inc. All copy and illustrations are copyrighted. Absolutely no mechanical or electronic reproduction or use of any part is allowed without our prior written permission. Goodson reserves the right to correct printing errors. Prices are subject to change without notice.

RW-GR-CAP
One-Size-Fits-Most
Snap-Back Cap



RW-CC
Goodson
logo on one
side and
"Goodson
Forever" on
the other



CA-100
Modeled by
Tim from
Production

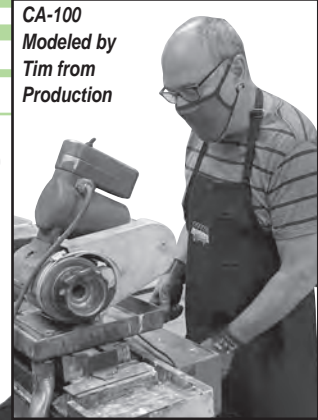

RW-CAP
Flex-Fit Cap with
closed back.
Available in two
sizes —
Small/Medium
and Large/X-Large
Modeled by Dylan from
Production



RW-GTB
Modeled by
Tracy & Craig
from Receiving

RW-GTW
Modeled by
Paige from
Customer
Service

GOODSON Gear

Sport your Goodson gear around the shop, at the track or just out and around!

Description	Color	Sizes	Jobber	Order No.
Pre-Shrunk Cotton T-Shirts	White	Large	14.99	RW-GTW-L
		X-Large	14.99	RW-GTW-XL
		XX-Large	15.99	RW-GTW-XXL
	Black	Medium	14.99	RW-GTB-M
		Large	14.99	RW-GTB-L
		X-Large	14.99	RW-GTB-XL
		XX-Large	15.99	RW-GTB-XXL
Snap Back Cap	Black	adjustable	14.99	RW-GR-CAP
Flex-Fit Cap	Black	Small/Medium	19.99	RW-CAP-SM
	Black	Large/X-Large	19.99	RW-CAP-L
Shop Apron	Black	n/a	39.99	CA-100
Can Cooler	Black	n/a	1.99	RW-CC



Watch for this symbol throughout the catalog

We know pictures often tell the story better than words so we are making videos for many of the products in the Goodson product line. The symbol above indicates that there is a video available for that product. Where space allows we are including a QR code that will take you directly to the video. All you need to do is point your smartphone camera at the code and the link will open.



Mach-B Grinding Wheel Shaping & Resizing

From routine grinding wheel shaping and sizing to emergency work, ***Mach-B Can Do That!***

Mach-B Grinding Wheel Shaping & Resizing specializes in:

- Custom Grinding Wheel Shaping
- Custom Grinding Wheel Sizing
- Reducing Outside Diameters
- Increasing Inside Diameters
- ANSI Compliant Speed Testing
- Static Balance Testing
- Standard and Custom Profiles
- Grinding Wheel Slotting



Turn to Mach-B and Goodson for Fast Turnaround. Visit www.mach-b.com for more information.



Custom Abrasive Belts

- Any Length (up to 520")
- Any Width (up to 15")*
- Aluminum-Oxide
- Ceramic-Alumina
- Silicon-Carbide
- Zirconia-Alumina
- 36 to 600 Grit*

Abrasive Industrial Supplies Has You Covered!

Abrasive Industrial Supplies (AIS) is a division of Goodson specializing in stock and custom grinding, sanding and polishing belts. We make belts in-house and can make whatever size belt you need.

*Grit & width availability varies by abrasive grain.

Choose from a variety of abrasives in several grits and backings for a wide range of applications.

You can order directly from AIS by calling **1-800-433-8010** or visiting the website: www.abrasiveindustrialsupplies.com OR talk to your Goodson customer service rep.

Now that's ONE STOP SHOPPING!



Abrasive Industrial Supplies
A Division of Goodson Manufacturing



A TYROLIT Company

10
9
8
7
6
5
4
3
2
1

GOODSON

Tools and Supplies for Engine Builders

156 Galewski Drive
Winona, MN 55987

Easy Toll-Free Ordering by Phone
1-800-533-8010

Toll-Free Fax 24-Hours a Day
1-888-466-3909

Order Online!
www.goodson.com

Use this ruler to measure the approximate size of your parts.

Meet the Goodson Employee Owners

We're here to serve you!

