

# DCM Melanger 20 Mark 2

## User Manual

---

Diamond Custom Machines Corporation  
9 Ilene Ct, Unit 9  
Hillsborough, NJ 08844  
USA  
USA phone: +1 888-717-9222  
International phone: +1 908-301-4704  
Email: [support@melangers.com](mailto:support@melangers.com)



## TABLE OF CONTENTS

<b>1. DCM MELANGER 20 MARK 2 OVERVIEW</b>	<b>3</b>
System Features	
Technical Specifications and Dimensions	
<b>2. PARTS DIAGRAM</b>	<b>4</b>
<b>3. SAFETY INSTRUCTIONS AND PRECAUTIONS</b>	<b>4-5</b>
General Safety	
Electrical Safety	
Precautions	
<b>4. INSTALLATION PROCEDURE</b>	<b>6-7</b>
Assembly	
Melanger Component List	
Melanger Assembly Instructions	
Installation	
<b>5. FIRST-USE CLEANING</b>	<b>8</b>
<b>6. CHOCOLATE REFINING</b>	<b>9-10</b>
Recipe Pointers	<b>11</b>
Sweeteners	
The sugar used should be standard white granulated cane sugar.	
Seeds and Nuts	
Soy Lecithin	
Milk Powders and Other Ingredients	
<b>7. RECIPES</b>	<b>12</b>
70% Dark Chocolate	<b>13</b>
Ingredients	
Directions	
Traditional Dairy-Free Giandujotti Bar	<b>14</b>
Ingredients	
Directions	
Dark milk 55%	<b>15</b>
Ingredients	
Directions	
Espresso Macchiato Chocolate	<b>16</b>
Ingredients	



Directions	
White Chocolate	17
Ingredients	
Directions	
Golden Vegan Milk Chocolate	18
Ingredients	
Directions	
Cashew and Strawberry Vegan Spread	19
Ingredients	
Directions	
Non-Dairy Hazelnut Spread	20
Ingredients	
Directions	
Tahini	21
Ingredients	
Directions	
Omega Spread	21-22
Ingredients	
Directions	
<b>8. TROUBLESHOOTING and FAQs</b>	<b>23</b>
<b>9. TECHNICAL SPECIFICATIONS</b>	<b>24</b>
<b>10. SERVICE, MAINTENANCE and REPAIRS</b>	<b>24</b>
<b>11. WARRANTY INFORMATION</b>	<b>25-26</b>
What are the limits of DCM's liability?	
Obtain Warranty Service	

*NOTE: Due to continuous product improvement, design changes are made from time to time. Some changes and modifications may not be covered in this manual. If you are unsure about the safe operation of your DCM Melanger 20 Mark 2, please contact Diamond Custom Machines Corporation for assistance.*



## 1. DCM MELANGER 20 Mark 2 OVERVIEW

Welcome to your DCM Melanger 20 Mark 2, a space-efficient, commercial, tilting refiner that is plug-and-play ready. This professional, tabletop model features high-quality, all-natural granite roller stones that refine particle size down to less than 20 microns. This machine creates great shear, enabling a faster working time. The processing efficiency allows for maximum retention of the beans' inherent qualities, therefore honoring their true potential to express organoleptic profiles.

The machine and its components are light enough to be handled by a single person. DCM Melanger 20 Mark 2's high-efficiency, continuous duty, variable speed motor maximizes work time, and the fine-tension controller adjusts stone pressure during the refining/conching stage.

### System Features

- Only all-natural, high-quality granite stones are used in DCM Melangers.
- Geared Drive from the gearbox, with no belts or chains to maintain
- Standard product is Single Phase, 110 or 220V, 50/60Hz input. Please contact us for power requirement customization
- Double Stainless Steel wiper design provides years of performance and shorter refining times
- Variable bowl speed from 0 to 120 rpm
- All-Stainless Steel extra heavy duty frame for reliability and hygiene
- 1 year limited manufacturer's warranty
- Easy to transport due to manageable size and weight
- Manageable size and weight make international shipping stress-free
- Made in the USA
- Spare parts are stocked for short lead times

### Technical Specifications and Dimensions

- Motor: ¼ HP.
- Amps: 3.0 (110V), 1.5 (220V)
- Capacity: Approximately 25 lbs/ 11 kgs of chocolate per batch
- Approximate overall weight: 100 lbs/ 45 kg
- Approximate Machine Size: 20" x 17.5" x 24"



## 2. PARTS DIAGRAM

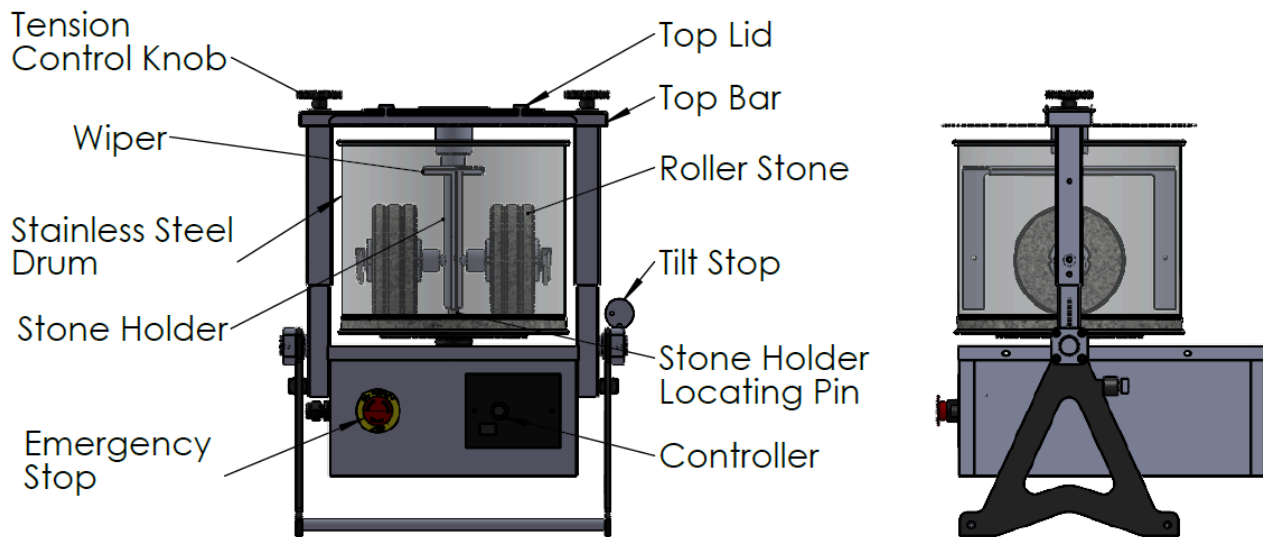

*\*The images of the parts may not accurately reflect the actual product.*

## 3. SAFETY INSTRUCTIONS AND PRECAUTIONS

Generally accepted and recommended safety practices are applicable to appliances purchased from Diamond Custom Machines Corporation.

Users are required to read and understand operating instructions, labels and general safety and warnings prior to using the appliance. Save these instructions for future reference.

Failure to follow the instructions detailed in this manual may lead to a voided warranty, personal harm, damage to appliance, fire hazard, or other unsafe and potentially dangerous conditions.

### A. General Safety

- a. Do not use the appliance for anything other than its intended use. Do not use outdoors; this product is intended for indoor use only. Do not place the appliance near a hot gas or electric furnace.
- b. Place the appliance on a hard, flat, level, and stable surface.
- c. This is a heavy machine. Use proper lifting procedures to avoid personal injury. During disassembly for maintenance, exercise extra care especially when handling heavy components such as grinding stone, grinding vessel etc. Handle the pinch point sharp edges carefully.
- d. Do not run the appliance longer than the time recommended in the instruction manual.
- e. The unit should always be run in the vertical upright position. Ensure the tilt lock is engaged and the machine is in a vertical position.
- f. Never leave the unit unattended while operating. Close supervision is always necessary



when the appliance is in operation. Only trained staff should operate the unit.

- g. Do not touch the rotating drum while in operation.
- h. Loose clothing and long hair must be secured prior to operation.
- i. Never put your hands or any other objects into the drum during operation. Checking the contents can be done only when the unit is turned off and after complete stopping of the operation.
- j. Do not touch any moving parts of the machine when in operation.
- k. Do not use any accessory attachments that are not recommended by Diamond Custom Machines Corporation. This may cause personal injuries and/or damage to the unit.

## **B. Electrical Safety**

- a. Use this product with a rated voltage AC outlet only. Use a dedicated electrical outlet/circuit for the unit when possible.
- b. To protect against electric shock, do not immerse the power cord, power plug or the machine in water or in any other liquid.
- c. Always switch off the unit and unplug the cord when the machine is not in use.
- d. Do not operate the appliance with a damaged cord or plug.
- e. If the appliance has malfunctioned or has been damaged in any way, call an Authorized Service Technician for examination or repair.
- f. Disconnect the unit during cleaning or when not in use.
- g. Periodically check the power cord for any visible damages.
- h. Do not allow the power cord to touch hot surfaces.
- i. Never allow water to enter the motor compartment.

## **C. Precautions**

- a. Always plug the DCM Melanger 20 Mark 2 into an appropriate rated outlet.
- b. Never handle the plug with wet hands.
- c. Ensure that the electrical outlet is properly grounded.
- d. Ensure the tilt Stop Locks are in place and pinned so that the Melanger does not accidentally tilt during operation.
- e. Do not dry run the DCM Melanger 20 Mark 2 prior to adding ingredients for an extended period of time. Dry running will cause the stones to fail prematurely.
- f. In case of any blockage, switch off the machine immediately. Please visit the Troubleshooting section to learn more.
- g. Operate the machine only when it is in the upright vertical position. Do not attempt to run the machine when it is tilted.
- h. While cleaning the machine after use, ensure that water does not enter the motor compartment.

## **4. INSTALLATION PROCEDURE**



## A. Assembly

### Melanger Component List

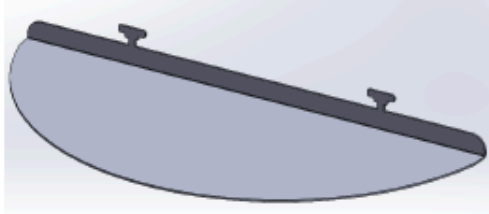

**Top Cover – Qty. 2**

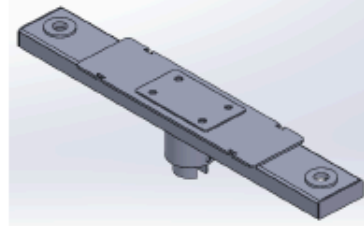

**Top Bar – Qty. 1**



**Side Top Arm – Qty. 2**

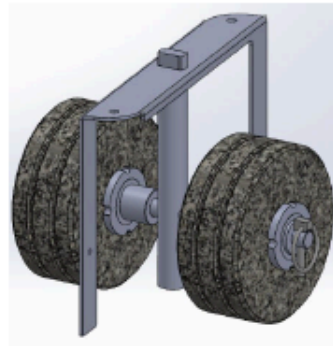

**Stone Holder – Qty. 1**



**Drum – Qty. 1**

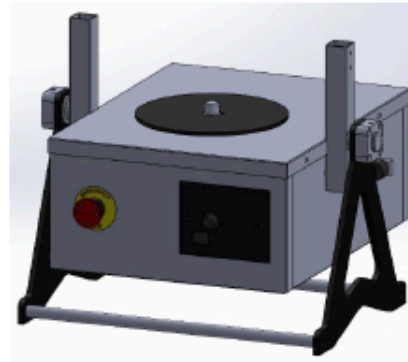

**Melanger Base – Qty. 1**



**Tensioner knob – Qty. 2**



### Melanger Assembly Instructions

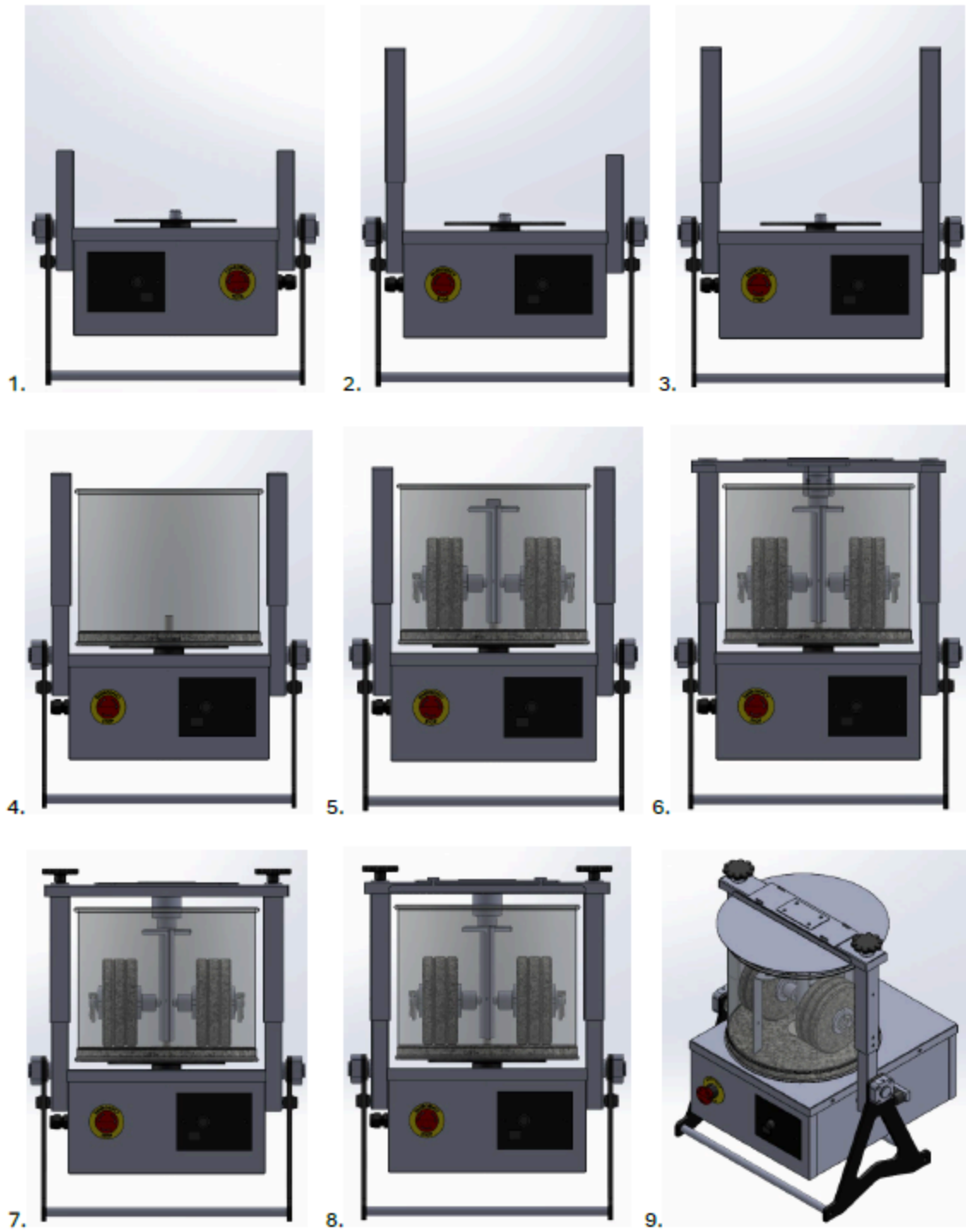





## B. Installation

- a. Ensure that the DCM Melanger 20 Mark 2 has arrived safely without any damage during transit. Inspect the grinder for any visual defects. If you see any defects, please call +1 888-717-9222 immediately.
- b. Select a secure, well-ventilated area with a flat, stable surface on which to place the melanger.
- c. It is recommended that the ambient temperature of your work area not be below 64°F/18° C. The chocolate could solidify in the drum during production.
- d. Ensure adequate space in front and back of the machine so the DCM Melanger 20 Mark 2 can be tilted without hitting any objects or walls.

## 5. FIRST-USE CLEANING

When your melanger arrives, it will need to be thoroughly cleaned before beginning production.

- a. Wipe clean the outside of the drum and the body of the machine using a soft, lint-free cloth.
- b. Next, wipe down the bowl and granite stones with a clean, soft cloth. To remove the fine stone dust on the granite stones, choose one of the following methods:
  - o Roasted cocoa nibs: at least 2.2lbs/1kg
  - o Rice: at least 2.2lbs/1kg (with about 500 g of water)Allow the machine to run for 10 to 15 minutes.
- c. The stones and the drum can then be washed, using warm water and dishwashing liquid. Proceed with proper sanitizing protocol per the document sent with your tracking information.
- d. Never place the drum or stones in a dishwasher. Hand wash all parts of the refiner.
- e. Always allow all components to air-dry completely before beginning production.
- f. Do not dry-run the stones. Dry-running could result in permanent damage to the stones and the bowl.



## 6. CHOCOLATE REFINING

Always be sure that your DCM Melanger 20 Mark 2 is completely dry when you start production. Even the smallest amount of moisture can cause the chocolate to seize, ruining the entire batch. The resulting thick mass cannot be refined in a DCM Melanger.

- a. If the machine has not been used for a period of time between batches, thoroughly clean, sanitize, and dry before use.
- b. Plug the unit into an appropriate power outlet.
- c. Turn the Power On/Off button to On position.

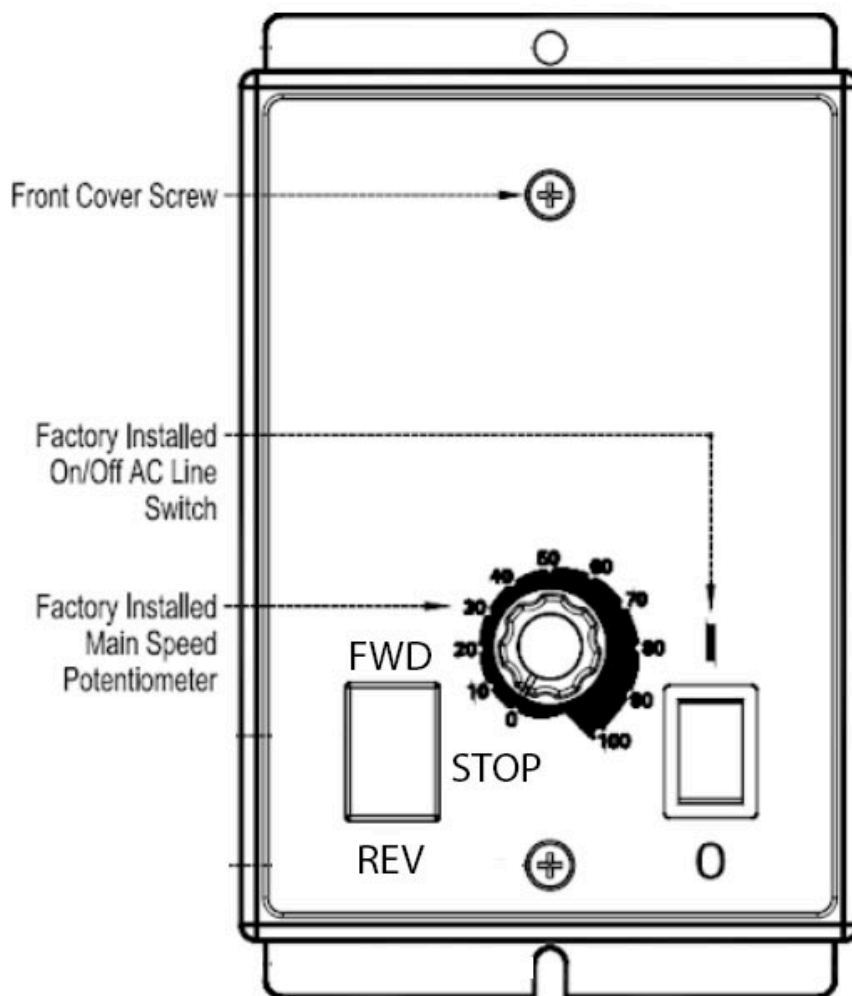

- d. Turn the black Speed Control knob to set the motor speed at 20
- e. The unit will begin to spin. Immediately begin to gradually add ingredients to the drum. **Never dry run the machine.**
- f. The roller stone pressure setting is key in refining chocolate. To adjust the pressure, turn the



tension control knob until they slightly resist turning. You will feel a little back pressure pushing against the knob, turn one full turn and then stop. **DO NOT TIGHTEN THE KNOB ALL THE WAY DOWN.**

**⚠ Caution:** *Do not put too much tension on the stones. This will result in the plastic parts inside the rollers and the rollers themselves wearing out quickly.*

- g. To help ensure a cohesive mass, it is recommended to add additional heat to the chocolate during the first 30 minutes of processing, especially if you notice that the mixture cools too much and starts to thicken. A standard heat gun works very well for adding heat to the machine. Be sure that the temperature stays below 150°F/65°C. You can also preheat all of your ingredients in a warm oven (140°F/60°C) for about 30 minutes. This will allow the DCM Melanger to work more easily.
- h. Continue to gradually add the necessary ingredients to the machine. Slowly increase the speed of the machine as desired and add the rest of the ingredients.

**⚠ For First Use:** *Do not run the DCM Melanger 20 Mark 2 above half speed for the first 48 hours to allow proper break-in of the machine.*

- i. The first hour of production, while ingredients are being added, requires constant and active supervision to ensure ingredients are being refined correctly.
- j. 30-40 minutes after adding the last ingredients, the chocolate should be flowing easily over and under the rollers like a smooth paste. If not, please visit the Troubleshooting section.
- k. Minimum refining time will vary depending on the ingredients used. If cocoa nibs are used, the minimum refining time to achieve a smooth chocolate is 12/24 hours. Note: Chocolate can become over-refined, leading to a sticky, unpleasant feeling on the palate.
- l. After the batch is finished, turn the main speed potentiometer on the controller to 0 to stop the rotation of the drum.
- m. Turn off the power to the controller.
- n. Release the tilt stop latch on the side and gently tilt the machine to empty the drum. Tilt slowly to prevent spillage.

**⚠ Caution:** *Always be sure that the roller stones are locked in place inside the drum before attempting to empty the contents. Because the roller stones hold the drum in place, removal of the stones will cause the drum to disengage from the base of the machine when it is tilted.*

- o. Always be sure to filter your chocolate in a regular mesh sieve to catch any impurities and uncrushed nibs.
- p. Do not under any circumstances store the product in the machine after the batch has finished.
- q. Pour the chocolate into storage containers or proceed directly to tempering and finish molding.
- r. Once the contents of the drum have been emptied, return the drum to vertical position and engage the tilt stop. It is now safe to remove the roller stones and drum to wipe clean any



remaining product.

- s. Carefully disassemble each component of the machine and, using a scrub brush with dish soap, wash well under warm running water to help remove any product that remains.
- t. Washed utensils and equipment should be rinsed with running water so that abrasives and cleaning chemicals are removed.
- u. Once every component is completely clean from residues, proceed with submerging every item in an appropriate dilution of your sanitizer of choice, for example: 1 oz Star San per 5 gallons of hot water (160°F/70°C).
- v. Leave the components submerged for a minimum of 1 minute to a maximum of 5. Alternatively, the sanitizer can be applied with a spray bottle. The sanitizer does not require rinsing when used at the recommended dilution.

## Recipe Pointers

### Sweeteners

The sugar used should be standard white granulated cane sugar.

To save time, “powdered” sugar can be used. However, do not use commercial confectioners (powdered) sugar, which contains cornstarch. Two minutes of pre-grinding the sugar will save you 2 or more hours of refining time in the DCM Melanger. If grinding your own sugar in a coffee grinder or food processor, be sure to use immediately or store in an airtight container to prevent it from absorbing moisture.

Other sugars may or may not work due to their moisture content. Brown sugar and coconut sugar, for instance, need to be dried before it can be used. To dry, spread the sugar on a baking sheet and place in a convection oven at 140°F/60°C for 2 hours. Use immediately or store in an airtight container. Malt powder holds enough moisture to cause your batch of chocolate to seize. Any additional ingredients containing water or alcohol are to be avoided, such as honey and syrups, including agave, maple syrup, etc.

If you experiment with alternative unrefined sugars, such as various brown sugars and coconut sugar, you will probably have to dehydrate them or their water content will be too high and your chocolate may seize.

The use of these (or any other ingredient that contains moisture) can cause the chocolate to seize and may damage the equipment. Melangers damaged by the use of any liquid-based ingredient are not covered by warranty. Use at your own risk. If you have any concerns about the appropriateness of an ingredient, please feel free to contact us.

### Seeds and Nuts

When working with seeds and nuts be sure that ingredients are no larger than the size of a cocoa nib.

If using raw nuts, allow to dry by placing in the oven at 140°F/60°C for 1 hour or increase the fat content of your recipe by roughly 5%.

### Soy Lecithin

If using soy lecithin, please note that it is an extremely powerful emulsifier so only very small quantities are recommended, use a maximum of 0.4% of the total recipe.

### Milk Powders and Other Ingredients

If making a milk chocolate product, always be sure to use powdered milk. Using liquid milk, cream, condensed milk or evaporated milk will cause your chocolate to seize. We specifically do not



recommend adding any flavorings to your chocolate during the refining stage (es. essential oils, pepper, salt etc). as the aromatic profile will be lost.

If adding dried fruit, do so after the chocolate has been refined and tempered.

If using vanilla, use a fresh pod. Adding vanilla extract will cause your chocolate to seize.

The following ingredients are not recommended for refining with the DCM Melanger 20 Mark 2:

- Liquid milk or cream
- Condensed milk
- Evaporated milk
- Water
- Fresh or not fully dried fruits
- Water or alcohol based extracts, including vanilla extract

The ingredients used and storage conditions may vary so storage times are only recommendations. Makers will have to establish their own sell Best Before Date. DCM Corp. is not liable for the shelf life of products made according to recipes provided in this manual.

**Important Notes on Batch Sizes:** If you are looking to make a small batch of chocolate or nut-based spread, be sure that your recipe is at least 40% of the drum capacity volume.



## 7. RECIPES

### 70% Dark Chocolate

This is a basic recipe for a classic dark chocolate. It can be used to make chocolate bars, confections, hot chocolate, and for a variety of baking needs.

#### Ingredients

▷▷	2100 g	17 ¾ cups	70%	Cocoa nibs
▷▷	900 g	4 ½ cups	30%	Granulated White Cane Sugar

#### Directions

1. Gradually pour the nibs into the drum of the DCM Melanger. With a heat gun, heat the drum of the refiner to speed up processing, never exceeding 140°F/60°C.

NOTE: To further shorten the processing time, warm the nibs in the oven at 215°F/100°C for 5-10 minutes and pulse-crush in batches in a mixer-grinder/Cuisinart for 1 minute.

2. Once all the cocoa nibs have been put in the DCM Melanger, let run for 3 hours minimum.
3. At this point, add the sugar, 300g - roughly 1 ½ cups at a time, making sure it is fully incorporated before adding more.
4. Let the DCM Melanger run for at least 10-15 hours. The refining time is approximate and depends on the desired end product. Once you are pleased with the consistency of the chocolate, proceed with removing the contents of the drum to temper or store as needed.
5. Temper the chocolate and shape into molds, then place in the refrigerator until solid, approximately 10-15 minutes.
6. Enjoy your silky smooth and creamy dark chocolate!

Yield: Approximately 3kg/6.6lbs of 70% dark chocolate, equal to 30 x 100 g bars.

Storage: Up to 12 months in a cool, dark, well-ventilated and odorless place in an airtight container.



## Traditional Dairy-Free Giandujotti Bar

This traditional recipe from the north of Italy makes a firm, yet creamy hazelnut paste and chocolate bar. Great for those looking for the mouthfeel of milk chocolate without the dairy.

### Ingredients

▷▷	480 g	4 cups	16%	Domori cocoa nibs
▷▷	600 g	2 ¾ cups	20%	Cocoa butter
▷▷	1320 g	6 ½ cups	44%	Granulated White Cane Sugar
▷▷	600 g	5 cups	20%	Roasted hazelnuts

### Directions

1. Melt the cocoa butter in a bain marie. For best results, never heat cocoa butter above 140°F/60°C.
2. Pour the melted cocoa butter into the DCM Melanger and gradually add the nibs to the drum. With a heat gun, warm the drum of the refiner to speed up processing, never exceeding 140°F/60°C.

NOTE: To further shorten the processing time, warm the nibs in the oven at 215°F/100°C for 5-10 minutes and pulse-crush in batches in a mixer-grinder/Cuisinart for 1 minute.

3. Once all the cocoa nibs have been put in the DCM Melanger, let run for 3 hours minimum.
4. In the meantime, roast the hazelnuts by placing them in a thin layer in a convection oven at 285°F/140°C for about 30 minutes. They are properly roasted when they turn a light caramel color in the middle.
5. After removing the skins, pre-grind the hazelnuts by pulse-crushing them in a mixer-grinder/Cuisinart for approximately 1 minute, obtaining a fine hazelnut flour.
6. At this point, add the sugar and the hazelnut flour, 300g - roughly 1 ½ cups at a time, making sure it is fully incorporated before adding more.
7. Let the Refiner run for at least 10-15 hours. The refining time is approximate and depends on the desired end product. Once you are pleased with the consistency of the chocolate, proceed with removing the contents of the drum to temper or store as needed.
8. Temper the chocolate and shape it into molds, then place in the refrigerator until solid, approximately 10-15 minutes.
9. Enjoy your traditional Piemontese Gianduja bar.

**Yield:** Approximately 3kg/6.6lbs of dairy-free Gianduja chocolate, equal to 30 x 100g bars.

**Storage:** Up to 6 months in a cool, dark, well-ventilated and odorless place in an airtight container.



## Dark milk 55%

This is a recipe for both milk and dark chocolate lovers. The high cocoa content brings an intense flavor to the chocolate that is sweetened by the milk.

### Ingredients

▷▷	840 g	7 cups	28%	Domori cocoa nibs
▷▷	840 g	3 ¾ cups	28%	Cocoa butter
▷▷	630 g	3 ¼ cups	21%	Granulated White Cane Sugar
▷▷	690 g	6 ½ cups	23%	Milk Powder

### Directions

1. Melt the cocoa butter in a bain marie. For best results, never heat cocoa butter above 140°F/60°C.
2. Pour the melted cocoa butter into the DCM Melanger and gradually add the nibs to the drum. With a heat gun, warm the drum of the refiner to speed up processing, never exceeding 140°F/60°C.

NOTE: To further shorten the processing time, warm the nibs in the oven at 215°F/100°C for 5-10 minutes and pulse-crush in batches in a Mixer-grinder/Cuisinart for 1 minute.

3. Next, add the sugar, 300g - roughly 1 ½ cups at a time, making sure it is fully incorporated before adding more.
4. After an hour, slowly add the milk powder until well-incorporated, carefully scraping the sides of the drum.
5. Let the DCM Melanger run for at least 10-15 hours.
6. Once you are pleased with the consistency of the chocolate, proceed with removing the contents of the drum to temper or store as needed.
7. Temper the chocolate and shape into molds, then place in the refrigerator until solid, approximately 10-15 minutes.
8. Enjoy your silky smooth and creamy dark milk chocolate!

**Yield:** Approximately 3kg/6.6lbs of dark milk 55% chocolate, equal to 30 x 100g bars.

**Storage:** Up to 12 months in a cool, dark, well-ventilated and odorless place in an airtight container.





## Espresso Macchiato Chocolate

With intense notes of coffee and caramel this is a wonderfully indulgent bar, perfectly enjoyed with a cup of espresso macchiato.

### Ingredients

▷▷	750 g	6 ⅓ cups	25%	Domori cocoa nibs
▷▷	750 g	3 ½ cups	25%	Cocoa butter
▷▷	630 g	3 ¼ cups	21%	Granulated White Cane Sugar
▷▷	660 g	6 ¼ cups	22%	Milk Powder
▷▷	210 g	2 cups	7%	High quality Instant Coffee Powder

### Directions

1. Melt the cocoa butter in a bain marie. For best results, never heat cocoa butter above 140°F/60°C.
2. Pour the melted cocoa butter into the DCM Melanger and gradually add the nibs to the drum. With a heat gun, warm the drum of the refiner to speed up processing, never exceeding 140°F/60°C.  
NOTE: To further shorten the processing time, warm the nibs in the oven at 215°F/100°C for 5-10 minutes and pulse-crush in batches in a mixer-grinder/Cuisinart for 1 minute.
3. Next, add the sugar, 300g - roughly 1 ½ cups at a time, making sure it is fully incorporated before adding more.
4. After one hour, add in the milk powder and the instant coffee. Slowly add the milk powder until well-incorporated, carefully scraping the sides of the drum;
5. Let run for at least 10-15 hours.
6. Once you are pleased with the consistency of the chocolate, proceed with removing the contents of the drum to temper or store as needed.
7. Temper the chocolate and shape into molds, then place in the refrigerator until solid, approximately 10-15 minutes.
8. Enjoy your silky smooth and creamy cappuccino chocolate!

**Yield:** Approximately 3kg/6.6lbs of espresso macchiato chocolate, equal to 30 x 100g bars.

**Storage:** Up to 12 months in a cool, well-ventilated, odorless place in an airtight container.



## White Chocolate

In its simplicity, white chocolate is always an indulgent treat. This recipe calls for fresh vanilla beans for a classic white chocolate. Enjoy as is, or use a great base for experimenting with unusual flavors. Try adding 50 gr of your favorite freeze dried fruit for a colorful chocolate. Or get creative with spices!

### Ingredients

▷▷	1050 g	4 ¾ cups	35%	Cocoa butter
▷▷	990 g	5 cups	33%	Granulated White Cane Sugar
▷▷	960 g	4 ⅓ cups	32%	Milk powder
▷▷	4	4	-	Fresh vanilla beans

### Directions

1. Melt the cocoa butter in a bain marie. For best results, never heat cocoa butter above 140°F/60°C.
2. Pour the melted cocoa butter into the DCM Melanger.  
NOTE: watch for changes in color and consistency of the cocoa butter; it might be slowly dropping in temperature and solidifying in the DCM Melanger.  
Should this happen, use a hair dryer on high setting, warm the drum of the refiner, never exceeding 140°F/60°C.
3. With a heat gun, warm the drum of the refiner to speed up processing, never exceeding 140°F/60°C.
4. Next, add the sugar, 300g - roughly 1 ½ cups at a time, making sure it is fully incorporated before adding more.
5. Let the mixture process for about 1 hour or until smooth.
1. Slowly add the milk powder until well-incorporated, carefully scraping the sides of the drum. If using freeze-dried fruit, pulse-crush in a mixer-grinder for 1 minute before adding to the drum.
6. Let the white chocolate refine for at least 10 hours.
7. Cut the vanilla beans lengthwise and scrape the seeds out (never use vanilla extract as any liquid will cause your chocolate to seize), add them to the refined white chocolate and let it run covered for an additional 30 minutes.
8. Once you are pleased with the consistency of the chocolate, proceed with removing the contents of the drum to temper or store as needed.
9. Temper the chocolate and shape into molds, then place in the refrigerator until solid, approximately 10-15 minutes.
10. Enjoy your white chocolate!

**Yield:** Approximately 3kg/6.6lbs, equal to 30 x 100g bars.

**Storage:** Up to 6 months in a cool, well-ventilated, odorless place in an airtight container.



## Golden Vegan Milk Chocolate

A surprisingly fresh, dairy-free white chocolate, combining the health benefits of turmeric and baobab with the sweetness of coconut and cardamom.

### Ingredients

▷▷	1200 g	5 ½ cups	39%	Cocoa butter
▷▷	1050 g	5 ¼ cups	35%	Granulated White Cane Sugar
▷▷	450 g	4 ½ cups	14%	Toasted unsweetened coconut shreds*
▷▷	300 g	2 ½ cups	10%	Lightly roasted cashews
▷▷	45 g	3 tbsp	1.5%	Baobab powder
▷▷	22 g	4 tbsp	-	Turmeric powder
▷▷	9 g	2 tbsp	-	Ground cardamom

### Directions

1. Melt the cocoa butter in a bain marie. For best results, never heat cocoa butter above 140°F/60°C.
2. Pour the melted cocoa butter into the DCM Melanger.
3. With a heat gun, warm the drum of the refiner to speed up processing, never exceeding 140°F/60°C.
4. Next, add the sugar, 300g - roughly 1 ½ cups at a time, making sure it is fully incorporated before adding more.
5. Let the mixture process for about 1 hour or until smooth.
6. In the meanwhile, lightly roast the cashew nuts by placing them in a thin layer in a convection oven at 265°F/130°C for 15 minutes.
7. \*If toasted coconut shreds are unavailable, take the same quantity of dried, unsweetened coconut or coconut flour and place it in a thin layer in a convection oven at 285°F/140°C for 25 minutes, stirring from time to time.
8. Grind the cashews and the coconut by pulse-crushing them in a Mixer-grinder/Cuisinart for approximately 1 minute, to obtain a fine flour and pour into your DCM Melanger.
9. Let run for about 6 hours.
10. Once you are pleased with the consistency of the chocolate, proceed with removing the contents of the drum into a bowl and stir in the baobab powder, turmeric and cardamom until blended together.
11. Temper the chocolate and shape into molds, then place in the refrigerator until solid, approximately 10-15 minutes.
12. Enjoy your golden vegan milk chocolate!

**Yield:** Approximately 3kg/6.6lbs of vegan golden milk chocolate, equal to 30 x 100g bars.

**Storage:** Up to 6 months in a cool, well-ventilated, odorless place in an airtight container.



## Cashew and Strawberry Vegan Spread

This fragrant dairy-free spread is perfect on bread and tartines. It can also be added to yogurt and ice cream or used as a base for a smoothie for an extra strawberry kick.

### Ingredients

▷▷	2250 g	19 cups	75%	Lightly roasted cashews
▷▷	375 g	1 ¾ cups	12%	Granulated White Cane Sugar
▷▷	225 g	2 cups	8%	Freeze dried strawberries
▷▷	150 g	¾ cups	5%	Coconut oil
▷▷	5	5		Fresh vanilla beans

### Directions

1. Lightly roast the cashew nuts by placing them in a thin layer in a convection oven at 265°F/130°C for 15 minutes.
2. Grind the cashews by pulse-crushing them in a Mixer-grinder/Cuisinart for approximately 1 minute, obtaining a fine cashew flour.
3. If needed, melt the coconut oil in a bain marie.
4. Pour the coconut oil into your DCM Melanger and start adding the cashews, until you obtain a smooth paste. If necessary, gently increase the temperature using a heat gun, never exceed 140°F/60°C.
5. Let process for about an hour.
6. Grind the freeze-dried strawberries by pulse-crushing them in a Mixer-grinder/Cuisinart for approximately 1 minute, obtaining a fine powder.
7. Once the cashew butter looks smooth and fluid, add the sugar and strawberries and let it process for another 3 hours.
8. Cut the vanilla beans lengthwise and scrape the seeds out (never use vanilla extract as any liquid will cause your chocolate to seize), add to the refined cashew butter and let run, covered, for an additional 30 minutes.
9. Once you are pleased with the consistency of the spread, proceed with removing the contents of the drum. For optimal results, store the spread in sterilized, airtight glass jars.

**Yield:** Approximately 3 kg/6.6lbs of vegan Strawberry & Cream spread.

**Storage:** Up to 6 months in a cool, well-ventilated, odorless place.



## Non-Dairy Hazelnut Spread

The ultimate treat for kids and grownups, this luxurious spread is completely dairy free, as the original recipe for gianduja demands. Ideal on virtually anything: bread, ice cream, mixed in with hot coffee or simply on a spoon directly out of the jar.

The key ingredients for this recipe are hazelnuts, so be sure to use the highest quality available.

### Ingredients

▷▷	1650 g	14 cups	75%	Hazelnuts
▷▷	1050 g	5 ¼ cups	12%	Granulated White Cane Sugar
▷▷	300 g	2 cups	8%	Cocoa powder

### Directions

1. Roast the hazelnuts by placing them in a thin layer in a convection oven at 265°F/140°C for about 30 minutes. Stir from time to time. They are properly roasted when they turn a light caramel color in the middle.
2. After removing the skins, pre-grind the hazelnuts by pulse-crushing in a Mixer-grinder/Cuisinart for approximately 1 minute, obtaining a fine hazelnut flour.
3. At this point, pour the sugar and the hazelnut flour into the DCM Melanger, 300g - roughly 2 cups at a time, making sure ingredients are evenly combined and worked into a coarse paste before adding more.
4. Let process for three hours.
5. Once you are pleased with the consistency of the spread, proceed by sprinkling in the cocoa powder 150g - roughly 1 cup at a time, and allow it to combine well with the nut paste. Once all of the cocoa powder is blended in, let run for an additional half an hour.
6. Proceed with removing the contents of the drum. For optimal results, store the spread in sterilized, airtight glass jars.

Yield: Approximately 3kg of non-dairy Hazelnut Spread

Storage: Up to 3 months in a cool, well-ventilated, odorless place.



## Tahini

Sesame seeds are extremely rich in iron, magnesium, and phosphorus making this dressing a nutritional powerhouse. Use it as a base for such dishes as hummus, stuffed avocados, and a wide variety of salads. The sesame oil gives the dressing a lightly roasted flavor.

### Ingredients

- ▷▷ 2850 g 19 ½ cups 95% Sesame seeds (whole or hulled)
- ▷▷ 150 g ¾ cups 5% Sesame oil

### Directions

1. Roast the sesame seeds by placing them in a thin layer in a convection oven at 265°F/140°C for about 30 minutes. Mix the seeds during this process to prevent the ones on the bottom from burning.
2. Pour the sesame oil into your DCM Melanger and start adding the sesame seeds, 300g - roughly 2 cups at a time, making sure it is fully incorporated before adding more. If necessary, gently increase the temperature using a heat gun, never exceed 140°F/60°C.
3. Let process for three hours.
4. Once you are pleased with the consistency of the tahini, proceed with removing the contents of the drum. For optimal results, store the spread in sterilized, airtight glass jars.

Yield: Approximately 3 kg/6.6 lbs of Tahini.

Storage: Up to 3 months in a cool, well-ventilated, odorless place.

## Omega Spread

This is a versatile, plant-based supplement for boosting essential fatty acids and micronutrients, especially omega-3 and omega-6. It can be used to enrich your smoothies, salad dressings, and a variety of savory dishes.

### Ingredients

- ▷▷ 900 g 8 ¼ cups 30% Lightly roasted almonds
- ▷▷ 900 g 6 ¼ cups 30% Hulled hemp seeds
- ▷▷ 900 g 6 ¼ cups 30% Hulled pumpkin seeds
- ▷▷ 300 g 1 ⅓ cups 10% Coconut oil

### Directions

1. Lightly roast the almonds by placing them in a thin layer in a convection oven at 265°F/130°C for about 15 minutes. Stir from time to time.



2. Next, grind the almonds by pulse-crushing in a mixer-grinder/Cuisinart for approximately 1 minute, obtaining a fine almond flour.
3. If needed, melt the coconut oil in a bain marie.
4. Pour the coconut oil into the DCM Melanger and start adding the almond flour, a little at a time, until you have a smooth paste. If necessary, gently increase the temperature using a heat gun, never exceeding 120°F/50°C.
5. Let process for about an hour.
6. While almonds are processing, grind the pumpkin seeds by pulse-crushing in a mixer-grinder/Cuisinart for approximately 1 minute until obtaining a fine pumpkin seed flour.
7. Next pour the hulled hemp seeds and the ground pumpkin seeds, 300g - roughly 2 cups at a time into the drum making sure ingredients are evenly combined into a coarse paste before adding more.
8. Let process for three more hours.
9. Once you are pleased with the consistency of the spread, proceed with removing the contents of the drum. For optimal results, store the spread in sanitized, airtight glass jars.

Yield: Approximately 3kg/6.6lbs of Omega spread.

Storage: Up to 3 months in a cool, well-ventilated, odorless place.



## 8. TROUBLESHOOTING and FAQs

Q: Why is my machine not turning on?

A: Please ensure that the Red Emergency stop button is pulled all the way out. This machine is shipped with the Emergency button engaged for safety purposes.

Q: Can I make nut butters with a DCM Melanger 20 Mark 2?

A: Yes, absolutely. Please note that also in this case, no water based or alcohol based products can be added. Kindly check the Recipe Pointers section for further info.

Q: The cocoa nibs and sugar are packing down on the base of the drum and the wheels are running on top. The product was dry and crumbly, and caused the motor to stop. What should I do?

A: Immediately turn off the machine and empty its contents completely.

You may have been adding the ingredients too quickly, always make sure the nibs have reached a creamy paste before adding any other ingredient, especially sugar or milk powder.

To restart the process use a heat gun and heat up the stones and slowly add the removed ingredients back into the drum. Keep the heat on the drum and the stones to aid the process. Alternatively you could add extra melted cocoa butter to the machine as the first ingredient in DCM Melanger. Let run for 1 minute and please make sure to heat up the wheels and drum with a heat gun. Now start adding back roughly 10% of your mixture at a time. Do not add any extra mixture until the machine has refined the content to a rough paste.

For further info please visit the Chocolate Refining section.

Q: My chocolate has become a thick fudge-like mass, what do I do?

A: Immediately turn off the machine. It is possible that you have added a water or alcohol based ingredient in the refining stage. Please find a more detailed list of unsuitable ingredients in the Recipe Pointers section.

If you wish to sweeten your product with honey or other ingredients you may do so only once the product is finished and tempered.

To rectify the situation, place the drum in the oven at 104°F/40°C until the mass loosens. Put the drum back in place and restart the process at minimum speed.

Should this not work the mixture can be used in baking.

Q: The machine's rolling stones are not spinning while the drum continues to turn. How to fix the wheel spinning issue?

A: There are a series of reasons why this might have happened.

> Temperature: the room temperature might be too low. Always keep the working area at minimum 64°F/18°C;

> Adding ingredients: it is possible that ingredients were added in too fast;

> Machine overload: too much product could have been inserted into the machine and this could overwhelm the wheels from spinning, slowly adding the ingredients and allowing the wheels to catch up will solve the issue.

> Seizing: if you have added an ingredient containing too much moisture, your chocolate will seize, increasing thickness. The wheels could also seize if there is a trace amount of moisture between the rolling stone hub and the metal shaft. You will need to remove the rolling stones from the machine and completely clean the inside of the rolling stone and air dry it well before





reassembly.

Q: My machine is making a strange scraping sound from time to time, is that normal?

A: There is a possibility that in your nibs there was a small stone or hard impurity of some kind. The scraping noise could also come from the wipers touching the drum. Make sure there is clearance between the wall of the drum and the wiper. Also ensure that there is space between the wiper and the bottom bed stone.

In general, if your refining mixture is not "flowing" smoothly in the drum, something is wrong and needs to be addressed. If you have ANY concerns or questions about your Melanger, please feel free to contact us immediately.

## 9. TECHNICAL SPECIFICATIONS

Generic Name:	DCM Melanger 20 Mark 2
Color:	Stainless Steel outer body
Outer body:	Stainless Steel
Stones and Base:	Granite
Power Requirements:	100-120 VAC or 200-230 VAC, 1 phase 50/60 Hz, 5 amps
Overall Dimensions:	Approx 20"x 17.5"x 24"
Weight:	Approx 110 lbs/ 50 kg
Motor:	1/4 HP, DC motor
Cable Length:	10 feet
Maximum Capacity:	11 kgs / 25 lbs



## 10. SERVICE, MAINTENANCE and REPAIRS

The Gearbox, the motor and the control panel do not require regular service or maintenance. It is a good practice to rotate the roller stones inside out once every month to ensure that the stones wear uniformly. The drum and the stones have to be cleaned as per your internal changeover operating procedures.

If direct support or replacement parts are needed, contact us at the information below.

## 11. WARRANTY INFORMATION

### 1-year Limited Warranty.

Diamond Custom Machines Corporation (DCM) warrants that for a period of one year from the date of purchase, this product will be free from defects in material and workmanship. DCM, at its option, will repair or replace this product or any component of the product found to be defective during the warranty period. Replacement will be made with a new or remanufactured product or component. If the product is no longer available, replacement may be made with a similar product of equal or greater value. This is your exclusive warranty. Do NOT attempt to repair or adjust any electrical or mechanical functions on this product. Doing so will void this warranty. This warranty is valid for the original purchaser from the date of initial purchase and is not transferable. Keep the original sales receipt. Proof of purchase is required to obtain warranty performance. DCM dealers, service centers, or retail stores selling DCM products do not have the right to alter, modify or in any way change the terms and conditions of this warranty.

This warranty does not cover normal wear of parts or damage resulting from any of the following: negligent use or misuse of the product, use on improper voltage or current, use contrary to the operating instructions, disassembly, repair or alteration by anyone other than DCM authorized service center. Further, the warranty does not cover: Acts of God, such as fire, flood, hurricanes and tornadoes.

### What are the limits of DCM's liability?

DCM shall not be liable for any incidental or consequential damages caused by the breach of any express, implied or statutory warranty or condition.

Except to the extent prohibited by any applicable law, any implied warranty or condition of merchantability or fitness for a particular purpose is limited in duration to the duration of the above warranty.

DCM disclaims all other warranties, conditions or representation, express, implied, statutory or otherwise. DCM shall not be liable for any damages of any kind resulting from the purchase, use or misuse of, or inability to use the product including incidental, special, consequential or similar damages or loss of profits, or for any breach of contract, fundamental or otherwise, or for any claim brought against purchaser by any other party.



### Obtain Warranty Service

If you have any questions regarding this warranty or would like to obtain warranty service, please contact us at:

Diamond Custom Machines Corporation  
9 Ilene Ct, Unit 9  
Hillsborough, NJ 08844, USA

Direct: Toll Free USA +1-888-717-9222, +1-908-301-4704  
Fax: +1-732-289-6230  
Email: [support@melangers.com](mailto:support@melangers.com)