

 **MITSUBISHI**
HEAVY INDUSTRIES, LTD.
AIR CONDITIONERS
HEAVY DUTY

Our Technologies, Your Tomorrow

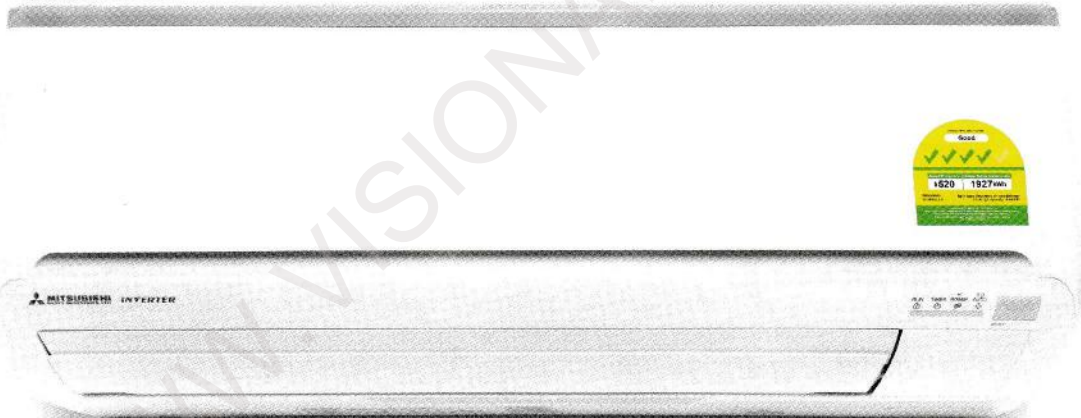

Eco•lution

more efficient, more sophisticated

Industry leading energy efficiency and high reliability from our high technology.

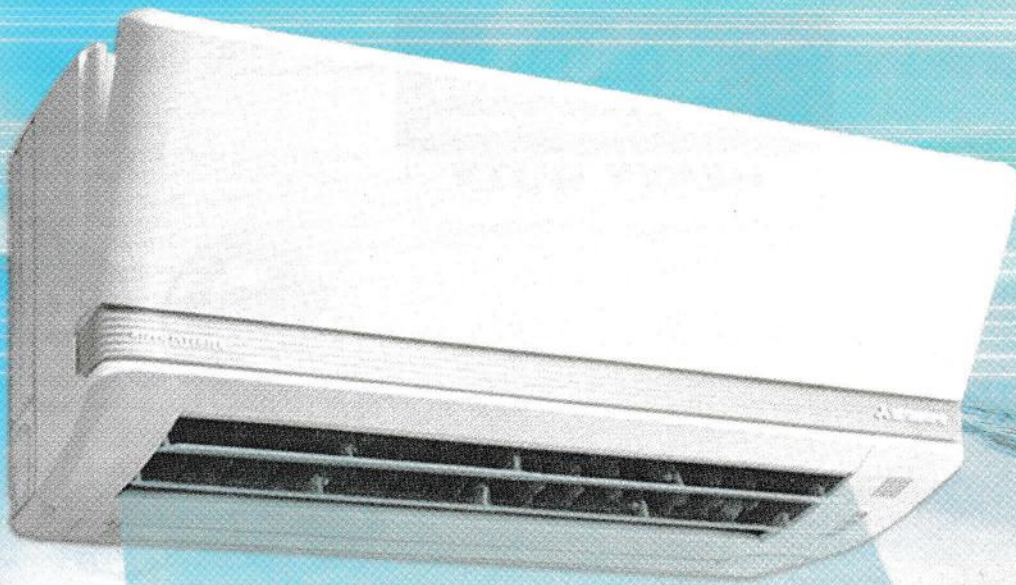

Diamond Series

SRK ZMX

Wall Mounted type

NEW



Remote control

The industry's highest levels
SEER 7.60
(SRK25ZMX-S in the cooling mode)

3D AUTO

Programmed air distribution

Sophisticated design

Quiet operation

Industry leading energy efficiency
and high reliability
from our advanced technology.



Our latest technologies

New propeller fan

Matching a new propeller fan with a fan motor has been optimized in order to keep the same capacity as that of previous models with less electrical consumption. Synergy effect with leaf shape grill has realized improvement of energy efficiency by 5% and decrease of sound level. (SRC40/50/60ZIX-S)

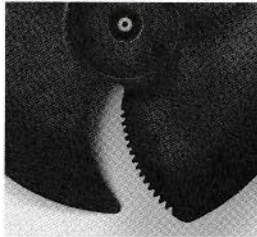

Serration fan

Energy saving leaf shape grill

Radial shape grill has been developed in order to realize natural air flow sent by propeller fan along with it. Airflow is very smooth with minimum air resistance and it can make decrease motor load and lead to improvement of energy efficiency.

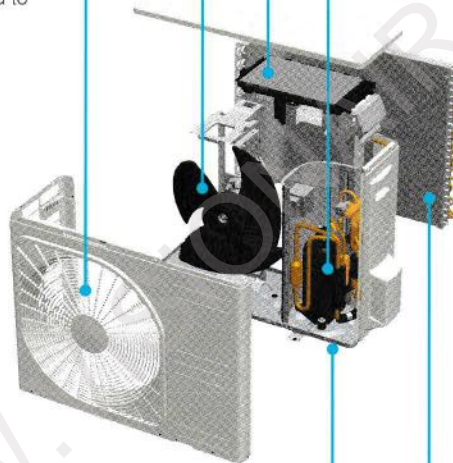
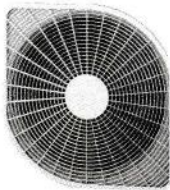

Silicon-coated PCB

The printed wiring board of the outdoor unit is coated by silicon. It lasts long having a tolerance for humidity.



High efficiency scroll compressor Realizing low vibration and low sound level

Thanks to applying scroll compressor, improvement of energy efficiency has been realized with lower vibration and lower sound level. Furthermore high efficiency and high output has realized by use of neodymium magnet applied in the motor. The magnet produces huge neodymium energy, reducing loss occurred during compression of refrigeration. (SRC40/50/60ZIX-S)



photo is composite image

Superior corrosion resistance hot dipping steel sheet

Superior corrosion resistance hot dipping steel sheet is applied at base of outdoor units. It has superior corrosion resistance and scratch resistance properties compared to conventional materials.

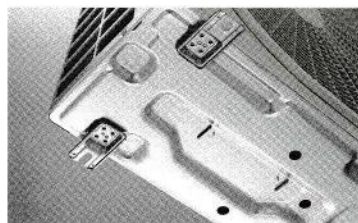

Indoor unit

Optimization of combination of fin configuration and copper tube has achieved maximum air flow keeping size in width of indoor unit. Efficiency rate of heat exchanger has been drastically improved by 33% compared with previous models. New fin can realize maximum air flow and saving energy simultaneously. (except SRK-ZJP)

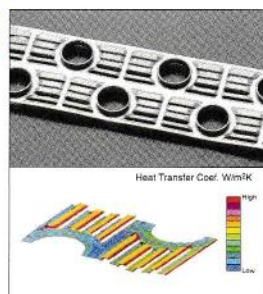

Outdoor unit

Thanks to changing fin configuration from flat sheet to new M shape fin, efficiency has been improved by 10%. Optimum balance of heat transfer and air flow has been achieved in a high-dimensional structure.



Applied models
All SRK

Anti-microbial specifications and design will deliver cleanliness and safety

Anti-microbial fan

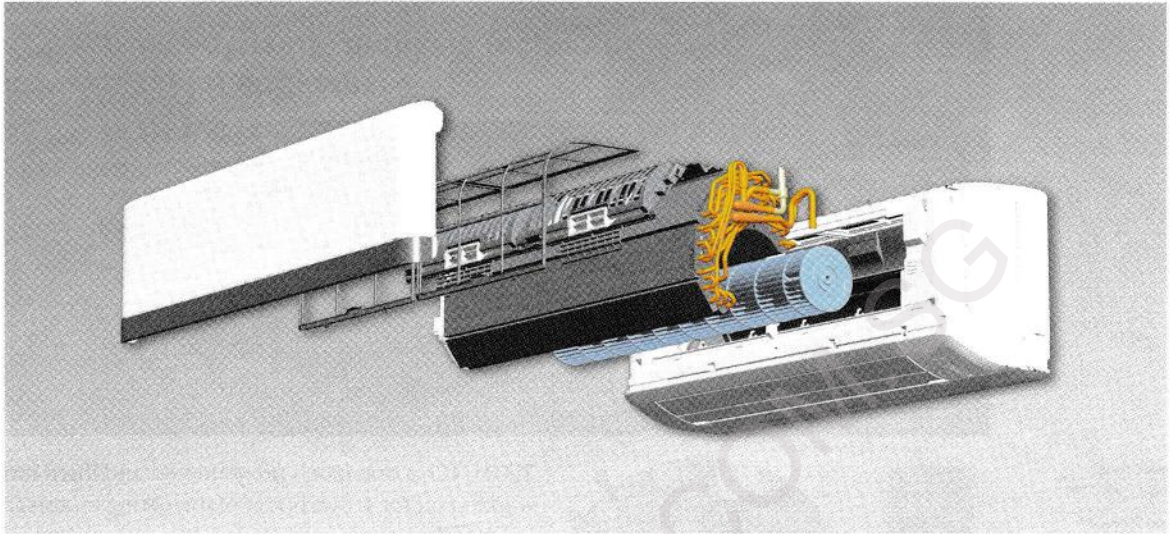

The fan has undergone anti-microbial treatment to resist mold and germs, making the system clean and safe. Foul odors and molds, etc. which can occur when an air conditioning system is not in operation are prevented.



Comparison of growth of bacteria and mold on fan surfaces (microscopic image)

- Intestinal bacteria (*Escherichia coli* IFO 3972)
- *Staphylococcus aureus* subsp. *aureus* IFO 12732
Testing Authority: Japan Food Analysis Center
Test Results Issued: 2004-4-7.
Test Report No.: 104034022-001
Tests were conducted with reference to the antimicrobial strength tests in JIS Z 2801 2000 "Antimicrobial Products-Antimicrobial Test Method" -5.2 Antimicrobial Effects: Test Methods for Plastic Products, etc.
- *Aspergillus niger* IFO 6341
Testing Authority: Japan Food Analysis Center
Test Results Issued: 2004-4-23.
Test Report No.: 104034022-002
Tests were conducted with reference to the antimicrobial strength tests in JIS Z 2801 2000 "Antimicrobial Products-Antimicrobial Test Method" -5.2 Antimicrobial Effects: Test Methods for Plastic Products, etc.

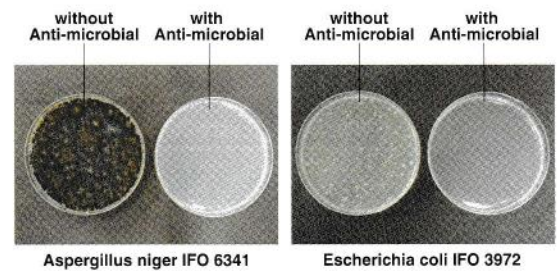

In tests conducted at the Mitsubishi Heavy Industries Nagoya Research Lab, 24 hrs after contact with bacteria, cultured on agar media.

Live Bacteria Count on Measured Test Pieces

| Tested Contaminant | Measurement | Test Pieces | Bacteria Count Per Test Piece | | |
|---------------------------------------|---------------------------|-----------------------------|-------------------------------|--------------------------|--------------------------|
| | | | Measurement 1 | Measurement 2 | Measurement 3 |
| <i>Escherichia coli</i> IFO 3972 coli | Immediately after contact | Not treated | 1.9×10^5 | 1.6×10^5 | 1.3×10^5 |
| | After 24 hrs at 35°C | Test piece 1 Not treated | <10 3.8×10^6 | <10 4.9×10^6 | <10 7.2×10^6 |
| <i>Staphylococcus aureus</i> | Immediately after contact | Not treated | 1.4×10^5 | 1.6×10^5 | 1.3×10^5 |
| | After 24 hrs at 35°C | Test piece 1 Not treated | <10 8.6×10^5 | <10 4.5×10^5 | <10 3.6×10^5 |
| <i>Aspergillus niger</i> | Immediately after contact | Not treated | 1.5×10^4 | 2.2×10^4 | 1.6×10^4 |
| | After 24 hrs at 35°C | Test piece 1 Not treated | <10 1.0×10^4 | <10 1.2×10^4 | <10 2.5×10^4 |

Test Pieces 1) Products with Antimicrobial and Antifungal Treatment

3D AUTO Vertical + Horizontal AIR SCROLL

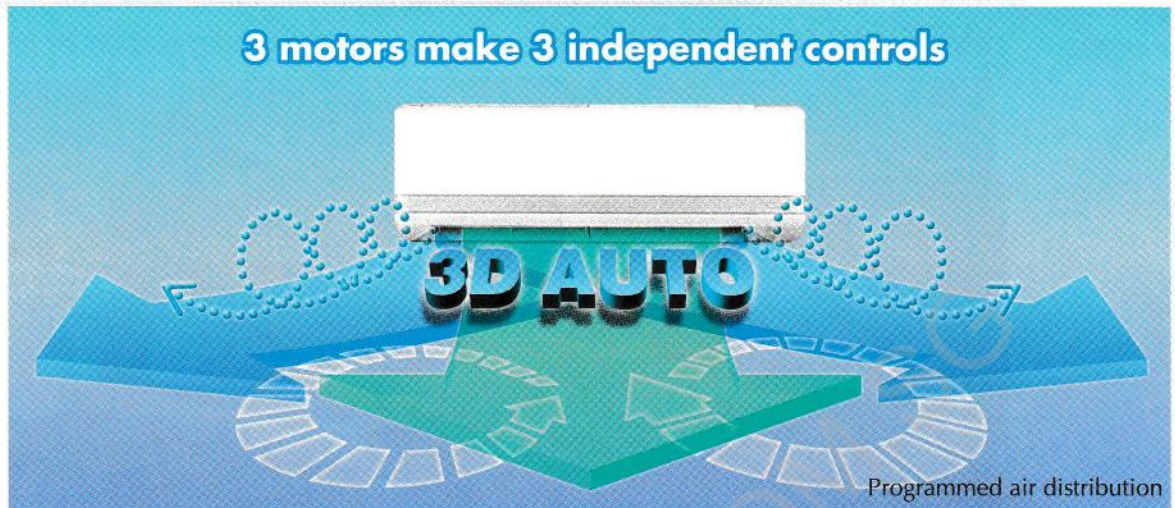

Applied models
SRK-ZMX, SRK-ZMA,
SRK-ZM
Manual Setting only

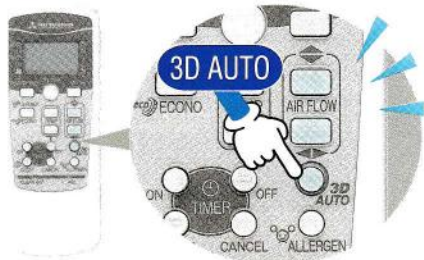

3D AUTO is one touch programmed and three motors (one vertical working motor + two horizontal working motors) make three independent air flow controls.

The uniform and quiet airflow can be delivered to every corner of the room, achieving economical operation and minimizing energy loss.

Programmed 3D AUTO

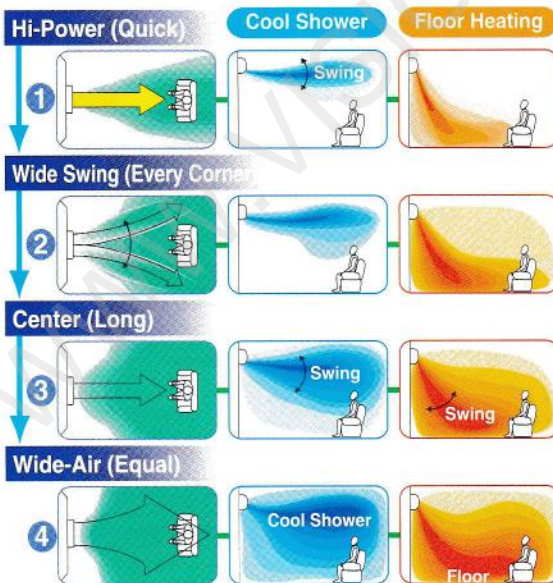

Thanks to automatic control of air flow volume and air flow direction, comfortable air conditioning of the entire room can be done effectively.

The cooled air flows directly to the ceiling in cooling operation mode, not directly at the occupants of the room. Comfort cooled air flow comes via the ceiling like a cool breeze.

In the heating mode, warm air flow can be sent down to the floor directly. The warm air then spread along the floor achieving optimum comfort.

Manual Setting

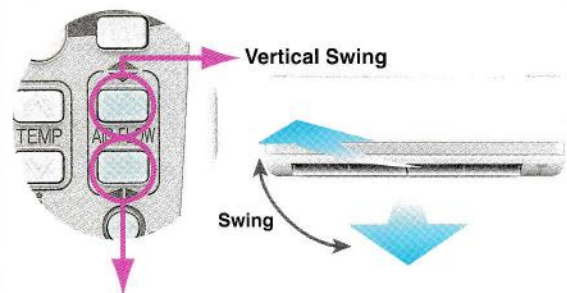

Horizontal Air Scroll 8 Direction Swing

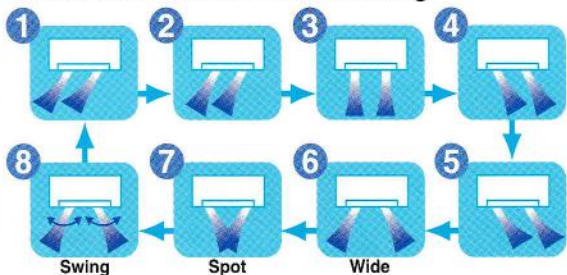

The airflow direction from the right and left louvers can be controlled individually. Eight different air flow patterns can be selected.

Aircraft technology was used in the design of the air conditioner's airflow system

Jet Air Scroll Long Reach & Silent Air Flow

Applied models
All SRK

We used the same aerodynamic analysis technology as used in developing jet engines.

CFD (computational fluid dynamics), used in blade shape design of jet engines, has been applied to the design of air channels in air conditioners to develop the ideal air channel system (air circulation). The jet air stream generated by this air channel system can bring large volume air without consuming much power. While at the same time, it delivers a uniform gentle breeze to every corner of the room.

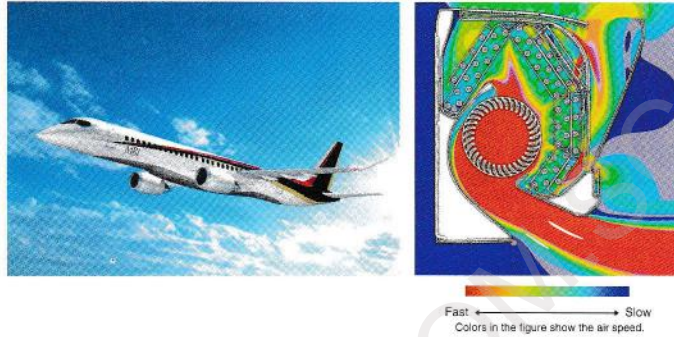

Long Reach Air Flow

Powerful airflow is realized by Jet technology. Good for large living rooms and shops. Increase your comfort.

Applied models
SRK60ZJX,
SRK-ZK,



Installation Positioning

The air flow direction can be set to suit your room's configuration.

Applied models
SRK60ZMX, SRK-ZMA



Clean Air



Applied models
SRK-ZMX, SRK-ZMA



Generates the same amount of negative ions as a forest environment

24-hour ION

The air conditioner main body employs a tourmaline-coated sheet. The sheet generates negative ions around the clock. Even when the air conditioner is not running, it generates as many negative ions (2,500– 3,000/cc) as in a forest, stream or fall does, allowing you to experience them without incurring any electrical charges.

Applied models
SRK-ZMX, SRK-ZM,
SRK-ZMA

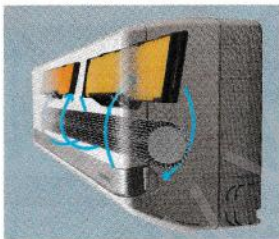

Always keeping the indoor unit clean

Self Clean Operation

“Self clean operation” is operated for 2 hours after the unit has stopped its normal operation.

The indoor unit is dried up and the growth of mold is restrained. Users can select whether this mode is utilized or not.

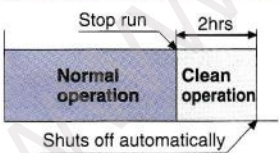

Situation of mold after one week

When you don't execute “Self Clean Operation”

Fungal mycelia expand.

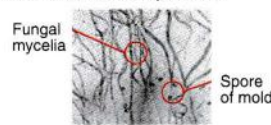

When you execute “Self Clean Operation”

The spore of mold doesn't germinate.

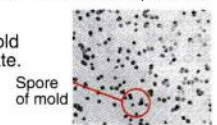

Applied models
SRK-ZMX, SRK-ZM,
SRK-ZMA



Push ALLERGEN Mode

The air in your room is kept fresh

Allergen Clear System

“Allergen clear system” is equipped to suppress the influence of the allergen caught by the filter by controlling the temperature and humidity.

In case of Multi-split system, Allergen Clear System is not available. If [Allergen] button is pushed by mistake, the indoor unit will stop.

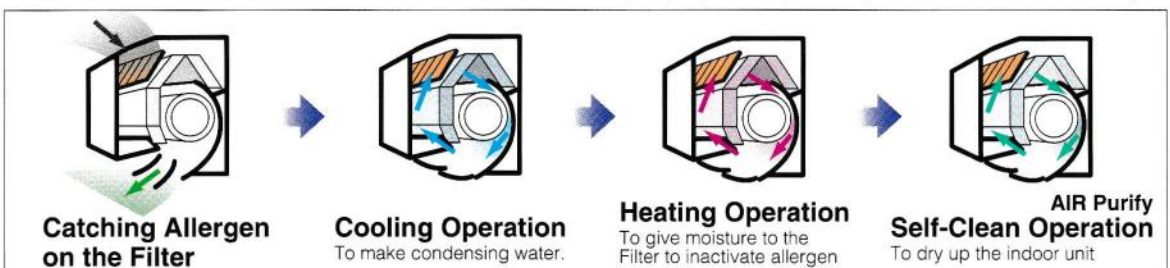

This is the original and only technology to control the temperature and humidity for inactivating allergens

Allergen Clear Filter

Enzyme + Urea deactivates allergens and kills bacteria.

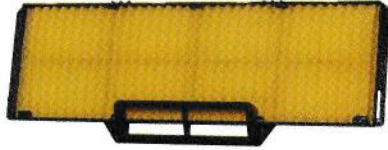

The allergen clear filter breaks down the pollen, lice, and allergens that live on cat skins, etc. and deactivates them. The secret of deactivation is the Enzyme-urea compound. It deactivates not only allergens but also all kinds of bacteria, molds and viruses. Even if allergens and bacteria, etc. fly off of the filter, they are deactivated, so the air in your room is kept fresh.

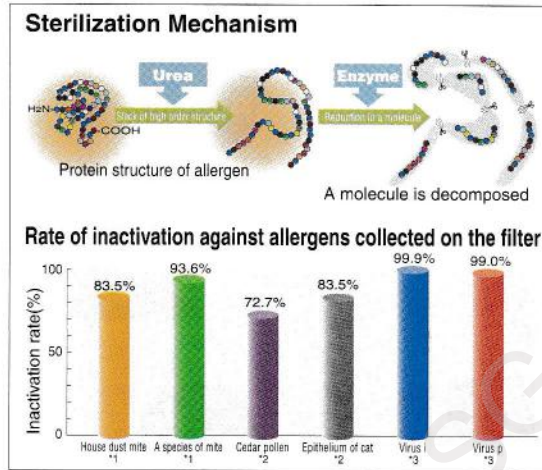

¹ Test method: ELISA colorimetric method / ELISA fluorescent method
Laboratory: Independent administrative agency national hospital mechanism Sagami Hospital, No. 1536

² Test method: ELISA colorimetric method
Laboratory: Independent administrative agency national hospital mechanism Sagami Hospital, No. 1536

³ Test method: TCID (Infection value 50%)
Laboratory: Foundation of Kitazato Environmental Science Center, No. 15-0145

Sure to destroy fungi and bacteria, also effective on viruses and allergenic compounds (Cat hair, dust mite, pollen etc.)

Natural Enzyme Filter

The first release in this range of the enzyme-sterilizing filter



Enzymes used in these filters are naturally occurring lytic enzymes. The lytic enzymes attack cell walls of microorganisms trapped on a filter and destroy them and doing so, have a powerful sterilizing which will effect decrease the number of molds and bacteria. Natural Enzyme Filter will clean and sanitize air passing through it to keep air in the room clean and safe.

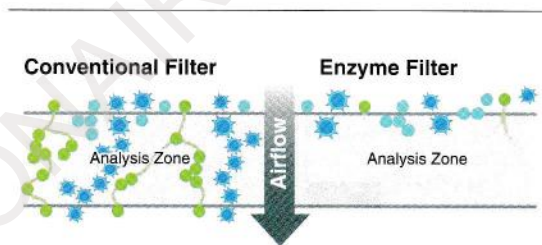

Enzyme's sterilizing mechanism



The deodorizing ability of this filter can be easily restored simply by cleaning and exposing to the sunlight

Photocatalytic Washable Deodorizing Filter

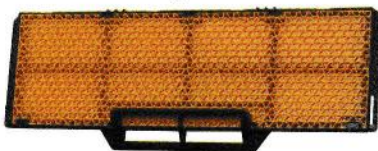

It will keep the air fresh by deodorizing the molecules causing odor. Its deodorizing power can be restored by washing with water and drying under the sun, as such it is a Recycling deodorizing filter capable of repeat use.

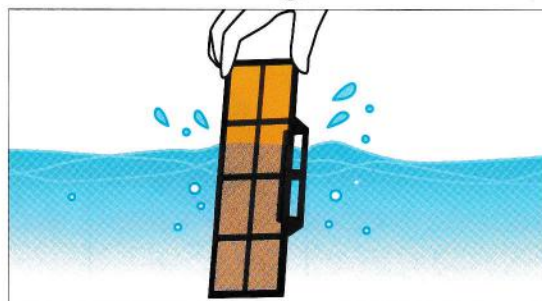

Product Range

| DC Inverter Multi Split | Type | Energy Labeling | Indoor Units To Be Combined |
|--|---|---|---|
| <p>SCM45ZJ-S 2 Indoor Unit</p>  <p>Refer Page 15</p> |  |  | <p>SRK25/35/50ZMA-S</p>  <p>Refer Page 16</p> |
| <p>SCM60ZJ-S1 3 Indoor Unit</p>  <p>Refer Page 15</p> |  |  | <p>SRK60ZMX-S</p>  <p>Refer Page 17</p> |
| <p>SCM80ZJ-S1 4 Indoor Unit</p>  <p>Refer Page 15</p> |  |  | <p>SRK71ZM-S</p>  <p>Refer Page 13</p> |
| <p>SCM100ZJ-S1 5 Indoor Unit</p> <p>SCM125ZJ-S1 6 Indoor Unit</p>  <p>Refer Page 15</p> |  |  | <p>FDT40/50-VF</p>  <p>Refer Page 20</p> |
|  <p>Refer Page 15</p> |  |  | <p>SRR35/50/60ZJ-S</p>  <p>Refer Page 19</p> |

Product Range

| DC Inverter Single Split | Type | Energy Labeling | Indoor Units To Be Combined |
|---|---|---|--|
| <p>SRC10YL-S SRC13YL-S</p>  <p>Refer Page 14</p> |  |  | <p>SRK10/13YL-S</p>  <p>Refer Page 14</p> |
| <p>SRC18YL-S</p>  <p>Refer Page 14</p> |  |  | <p>SRK18YL-S</p>  <p>Refer Page 14</p> |
| <p>SRC71ZM-S</p>  <p>Refer Page 13</p> |  |  | <p>SRK71ZM-S</p>  <p>Refer Page 13</p> |

Note: Due to the compact high efficient design of heat exchanger, the use of wall mounted fan & Ceiling Cassette coil units are not recommended for hair saloon environment. Please contact our Dealers for Recommendations of appropriate model.

Clean Operation / Filter



Allergen Clear System

The system is equipped to suppress the influence of the allergen caught by the filter by controlled the temperature and humidity.



Self Clean Operation

The operation is operated for 2 hours after the unit has stopped its normal operation. The indoor unit is dried up and growth of mold is restrained.



Allergen Clear Filter

The filter breaks down the pollen, lice, and all allergens that live on cat skins, etc. and deactivates them.



Photocatalytic Washable Deodorizing Filter

It keeps air fresh by deodorizing the molecules causing odor. The deodorizing ability can be easily restored simply by cleaning and exposing to the sunlight.



Natural Enzyme Filter

Enzymes used in the filter are naturally occurring lytic enzymes which attack cell walls of microorganisms trapped on the filter and destroy them.

Comfortable Functions



Fuzzy Auto Mode

Automatically, the unit determines its operating mode and temperature setting based on a fuzzy calculation, and adjusts the inverter frequency.



"HI POWER" Operation

The unit can operate continuously in "HI POWER" mode for 15 minutes. This mode is convenient to reach the desired temperature quickly.



Three "Hot" System

This series offers three "hot" systems. "Hot start" allows the unit to begin operating immediately, while the "hot spurt" fast-heating system works to increase the temperature setting by two degrees. The "hot keep" system is used during automatic defrosting or to prevent the influx of cool air. These three operational control systems help ensure comfortable and efficient heating.



Automatic Operation

The air conditioner automatically selects from among heating, cooling and dry operations.

Comfortable Air Flow Functions



3D Auto

You can choose the best cooling or heating pattern by only pushing one button.



Auto Flap Mode

Whatever the operating mode is, the unit automatically selects the optimal angle.



COOLING & DRY
Horizontal blowing



HEATING

Slant forward blowing



Memory Flap

While the flap is swinging, it can be stopped at any angle desired. The flap returns to the position that it was in when operation last stopped.



Air Scroll

The swing of the flap causes the air flow to spiral as it reaches the floor, and breeze reaches all of a room.



Red line : moves quickly

Black line : moves slowly

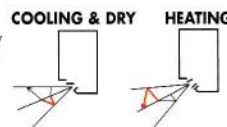

Up/Down Flap Swing

Flap moves up and down continuously. The Up/Down flap swing can be fixed at the preferred operation angle.



Right/Left Louver swing

Louver moves right and left continuously. The Right/Left louver swing can be fixed at the preferred operation angle.



Air Outlet Selection

Both lower and upper air outlets and upper air outlet can be selected.



Positioning of Installation

You can set the left-right air flow directions when you installed the air conditioner near the side wall by remote controller operation.

Convenience & Economy Functions



On Timer

This facility enables the operation to start a little earlier, so that the room approaches optimum temperature at ON time when the operation is started by ON-TIMER. Thus it will try to be at the temperature you want, when you want.



Economy Mode

The unit realizes effective energy saving operation, while still keeping a comfortable cooling and heating condition.



Dry Operation

The unit dehumidifies the room by intermittent cooling operation.



24-hour On/Off Programmable Timer

By combining a start timer with a stop timer, you can register two timer operations a day. Once set, timers will faithfully start or stop the system at a specified time of the day repeatedly.



Off Timer

The unit stops automatically at the set time.



Sleep Mode

The room temperature is automatically controlled during the set sleep mode period, ensuring that room temperature will not get too cold or too hot.

Maintenance & Prevention Functions



Microcomputer-Operated Defrosting

This mode automatically eliminates frost, and helps minimize excessive operation in other modes.



Self-Diagnostic Function

In the case that the air conditioner malfunctions, an internal microcomputer automatically runs a self-diagnosis. (Inspection and repair should be performed by authorized dealers.)



Detachable Indoor Air Inlet Panel

The air inlet panel on the indoor unit opens and closes easily, making filter cleaning simple. The suction panel can also be removed.

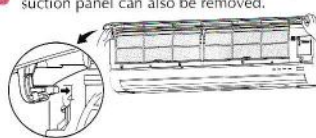

When removing the air inlet panel for internal cleaning or others, open the grill by 65 degrees and then pull it to this side.

Others



Back-up Switch

On the main unit, there is a backup on/off switch, which is useful when you can't use remote control, or batteries are flat.



Auto Restart Function

Power blackout auto restart function is a function that records the operational status of the air-conditioner immediately prior to it being switched off by a power cut, and then automatically resumes operations at that point after the power has been restored.



24-hour ION

Tourmaline-coated sheet generates negative ions around the clock. Even when the air conditioner is not running, it generates as many negative ions as a forest, stream or fall does, allowing you to experience them without incurring any electricity charges.



Luminous Button

With wireless "Luminous" remote controls that even "glow in the dark", it is possible to operate all desired functions of the unit with the click of a button.

INVERTER SINGLE SPLIT PREMIUM <COOLING> ZM SERIES



Inverter SUPER HIGH EER



SRK71ZM-S



SRK71ZM-S can be selected for use as indoor units in the combination with SCM Multi system outdoor unit.



SRC71ZM-S

Functions



Comfortable Functions



Comfortable Air Flow Functions



Convenient & Economy Functions



Maintenance & Prevention Functions



Others



Specifications

| | | | ZM series |
|---------------------------------|--------------|---------------------|---|
| Item | Model | Indoor unit | SRK71ZM-S |
| | | Outdoor unit | SRC71ZM-S |
| Power Source | | | 1Phase, 220/230/240V; 50Hz |
| Capacity | Cooling | kW | 7.10 |
| | | BTU/h | 24300 |
| Input | Cooling | kW | 2.16 (0.54-2.80) |
| EER | in Cooling | BTU/hW | 3.29 |
| Current | Cooling | A | 9.7 |
| Exterior dimensions (H × W × D) | Indoor unit | mm | 318 × 1098 × 248 |
| | Outdoor unit | mm | 750 × 880 (+88) × 340 |
| Net weight | Indoor unit | kg | 16 |
| | Outdoor unit | kg | 57 |
| Air Flow (Cooling) | Indoor unit | m ³ /min | 19.5 (Hi) |
| | Outdoor unit | m ³ /min | 55.0 |
| Refrigerant | | | R410A |
| Refrigerant piping | Liquid line | mm | Ø6.35 (1/4") |
| | Gas line | mm | Ø15.88 (5/8") |
| Connecting wiring | | | 1.5mm ² × 4cores (Including earth cable) |
| Connecting method | | | Terminal block (Screw fixing type) |

Note: The use of wall mounted fan coil units are not recommended for hair saloon environment. (Refer page 11)



DELUXE <COOLING> YL SERIES

Inverter

NEW

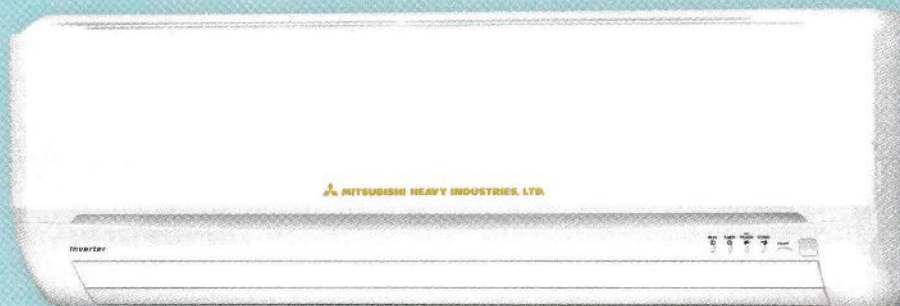

SRK10YL-S, SRK13YL-S, SRK18YL-S



SRC10YL-S, SRC13YL-S

SRC18YL-S

Refrigerant Pipe Length

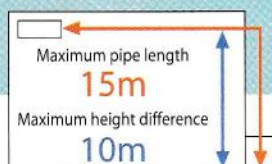

SRK10YL-S
SRK13YL-S
SRK18YL-S

Functions

Enzyme Filter

SOLAR Filter

Anti Micro Bial Fan

Comfortable Functions

Fuzzy Auto HI POWER

Comfortable Air Flow Functions

3D AUTO Auto Flap Air Scroll Memory UP/DOWN Lateral Swing

Convenient & Economy Functions

Economy DRY OFF Timer Sleep 24h Timer On Timer

Maintenance & Prevention Functions

Self Diagnostic Detachable

Others

Back-up Switch Auto Restart Luminous 24h-10N

Specifications

| Item | Model | YL series | | | |
|---------------------------------|--------------|---------------------|---|--------------|-----------------------|
| | | Indoor unit | SRK10YL-S | SRK13YL-S | SRK18YL-S |
| | | Outdoor unit | SRC10YL-S | SRC13YL-S | SRC18YL-S |
| Power Source | | | 1 Phase, 220/230/240V : 50Hz, 220V : 60 Hz | | |
| Capacity | | kW | 2.50 | 3.50 | 5.00 |
| | | BTU/h | 8530 | 12000 | 17060 |
| Input | | kW | 0.67 | 0.98 | 1.56 |
| EER | | BTU/hW | 12.7 | 12.2 | 10.9 |
| Current | | A | 3.3 | 4.5 | 7.1 |
| Exterior dimensions (H × W × D) | Indoor unit | mm | 268 × 790 × 224 | | |
| | Outdoor unit | mm | 540 × 780 (+62) × 290 | | 595 × 780 (+62) × 290 |
| Net weight | Indoor unit | kg | 8.5 | | |
| | Outdoor unit | kg | 29 | 32 | 35 |
| Air Flow | Indoor unit | m ³ /min | 8.0 | 10.0 | 12.0 |
| | Outdoor unit | m ³ /min | 29.5 | 27.8 | 37.7 |
| Refrigerant | | kW | R410A | | |
| Refrigerant piping | Liquid line | mm | Ø6.35 (1/4") | | |
| | Gas line | mm | Ø9.52 (3/8") | Ø9.52 (3/8") | Ø12.7 (1/2") |
| Connecting wiring | | | 1.5mm ² × 4cores (Including earth cable) | | |
| Connecting method | | | Terminal block (Screw fixing type) | | |

Note: The use of wall mounted fan coil units are not recommended for hair saloon environment. (Refer page 11)

INVERTER HEAT PUMP MODEL



SRK-ZMA

Wall Mounted type



NEW

SRK25ZMA-S
SRK35ZMA-S, SRK50ZMA-S

Single Multi

All SRK-ZMA series can be selected for use as indoor units in the combination with SCM Multi system outdoor unit.



Standard equipment

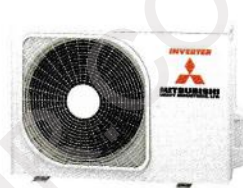

SRC25ZM-S, SRC35ZM-S

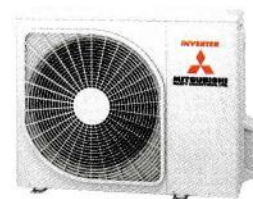

SRC50ZM-S

Refrigerant pipe length

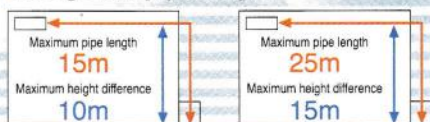

SRK25ZMA-S
SRK35ZMA-S

SRK50ZMA-S

FUNCTION

Comfortable Functions: Fuzzy, Auto, HI POWER

Comfortable Air Flow Functions: 3D Auto, Auto Flap, Memory, UP/DOWN, Lateral Swing, Positioning of installation

Convenient & Economy Functions: On/Off Weekly Timer, On/Off 24h Timer, On/Off Timer, DRY, Economy, Sleep, Silent, Night setback 10°C

Maintenance & Prevention Functions: MC, Self Diagnostic, Detachable

Others: Back-up Switch, Auto Restart, Luminous

SPECIFICATIONS

| Item | Model | Indoor unit | | SRK25ZMA-S | SRK35ZMA-S | SRK50ZMA-S |
|-------------------------------------|-------------------------|------------------------|---------------------|---|------------------------|-------------------------|
| | | Outdoor unit | | SRC25ZM-S | SRC35ZM-S | SRC50ZM-S |
| Power source | | | | 1 Phase, 220 - 240V, 50Hz | | |
| Nominal cooling capacity (Min~Max) | | | | 2.5(1.0~2.9) | 3.5(1.0~3.8) | 5.0(1.6~5.5) |
| EER | | | | 4.03 | 3.47 | 3.23 |
| Max. running current | | | | 9 | 9 | 14 |
| Air flow | Indoor | Cooling (Hi/Me/Lo/Ulo) | m ³ /min | 7.9 / 6.0 / 5.3 / 5.0 | 10.1 / 6.4 / 5.4 / 5.0 | 11.3 / 7.8 / 6.0 / 5.3 |
| | Outdoor | Cooling | | 32.1 | 31.5 | 36.0 |
| Exterior dimensions | Indoor | HeightxWidthxDepth | mm | 294 x 798 x 229 | | |
| | Outdoor | | | 540 x 780(+62) x 290 | | 640 x 800 x(+71) x 290 |
| Net weight | Indoor / Outdoor | | kg | 9.5 / 31.5 | 9.5 / 34.5 | 9.5 / 40.5 |
| Ref.piping size | Liquid/Gas | | ø mm | 6.35(1/4") / 9.52(3/8") | | 6.35(1/4") / 12.7(1/2") |
| Refrigerant line (one way) length | | | m | Max. 15 | | Max. 25 |
| Vertical height differences | Outdoor is higher/lower | | m | Max. 10 / Max. 10 | | Max. 15 / Max. 15 |
| Outdoor operating temperature range | Cooling | | °C | ~15-46 | | |
| Clean filter | | | | Allergen Clear Filter x 1, Photocatalytic Washable Deodorizing Filter x 1 | | |

The data are measured under the following conditions(ISO-T1). Cooling: Indoor temp. of 27°CDB, 19°CWB, and outdoor temp. of 35°CDB. Heating: Indoor temp. of 20°CDB, and outdoor temp. of 7°CDB, 6°CWB. * Indicates the value in an anechoic chamber. During operation these values are somewhat higher due to ambient conditions.

Note: The use of wall mounted fan coil units are not recommended for hair saloon environment. (Refer page 11)

INVERTER MULTI-SPLIT MODEL

Inverter Multi-split System



The multi-split system allows a single outdoor unit to service a range of configurations of up to four indoor unit ---- from a lineup of 6 units ranging from 6.0kW to 13.5kW.



ZMX, ZM, ZMA
Wall mounted type **SRK**

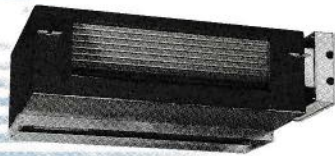

Ceiling Concealed type **SRR**



4way ceiling cassette type **FDT**

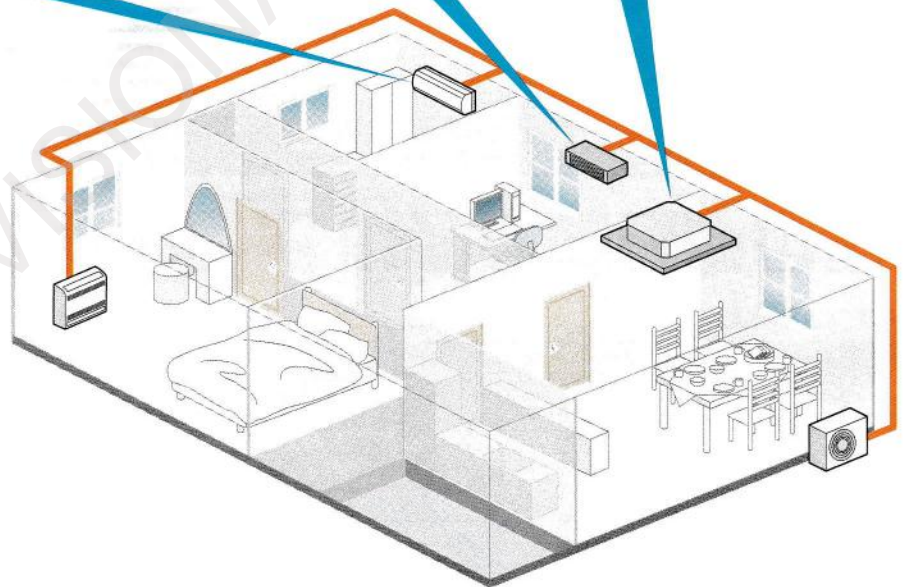
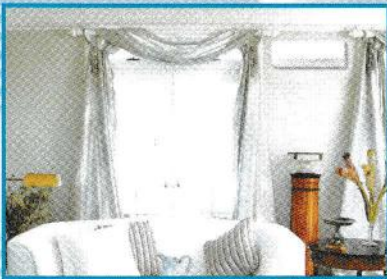

OUTDOOR UNIT



INVERTER MULTI-SPLIT SYSTEM

Multi System INDOOR UNIT



Premium Series

SRK-ZMA-S



Wall mounted type

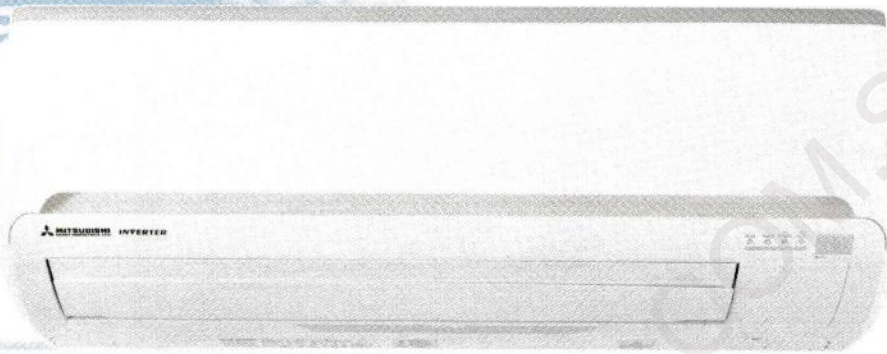

SRK25ZMA-S, SRK35ZMA-S, SRK50ZMA-S

FUNCTION



Comfortable Functions



Comfortable Air Flow Functions



Convenient & Economy Functions



Maintenance & Prevention Functions



Others



SPECIFICATIONS

| Item | Model | SRK25ZMA-S | SRK35ZMA-S | SRK50ZMA-S |
|------------------------------|--------------------|---|-----------------------|-----------------------|
| Cooling capacity | ISO-T1(JIS) kW | 2.5 | 3.5 | 5.0 |
| Heating capacity | ISO-T1(JIS) kW | 3.4 | 4.5 | 5.8 |
| Sound pressure level * | Cooling dB(A) | Hi:34 Me:28 Lo:21 | Hi:42 Me:32 Lo:22 | Hi:46 Me:37 Lo:26 |
| Air flow | Indoor Cooling CMM | Hi:7.9 Me:6.0 Lo:5.0 | Hi:10.1 Me:6.4 Lo:5.0 | Hi:11.3 Me:7.8 Lo:5.3 |
| Exterior dimensions (H×W×D) | mm | 294×798×229 | | |
| Net weight | kg | 9.5 | | |
| Clean filter | | Allergen Clear Filter × 1, Photocatalytic Washable Deodorizing Filter × 1 | | |
| Piping | Liquid line mm(in) | φ 6.35(1/4") | | |
| | Gas line mm(in) | φ 9.52(3/8") | | |
| OUTDOOR UNITS TO BE COMBINED | | SCM45,60,80,100,125ZJ-S | | SCM60,80,100,125ZJ-S |

The data are measured under the following conditions(ISO-T1). Cooling: Indoor temp. of 27CDB, 19CWB, and outdoor temp. of 35CDB. Heating: Indoor temp. of 20CDB, and outdoor temp. of 7CDB, 6CWB.
* Indicates the value in an anechoic chamber. During operation these values are somewhat higher due to ambient conditions.

Note: The use of wall mounted fan coil units are not recommended for hair saloon environment. (Refer page 11)

INVERTER MULTI-SPLIT SYSTEM

Multi System INDOOR UNIT



SRK-ZMXS

Wall Mounted type



SRK60ZMX-S



Standard equipment

FUNCTION



Comfortable Air Flow Functions



Convenient & Economy Functions



Maintenance & Prevention Functions



Others



SPECIFICATIONS

| Item | Model | SRK60ZMX-S |
|-----------------------------|--------------------|---|
| Nominal cooling capacity | ISO-T1(JIS) kW | 6.0 |
| Sound power level * | Cooling dB(A) | 62 |
| Sound pressure level * | Cooling dB(A) | Hi:51 Me:41 Lo:29 |
| Air flow | Cooling CMM | Hi:14.5 Me:12.5 Lo:8.5 |
| Exterior dimensions (H×W×D) | mm | 309×890×220 |
| Net weight | kg | 15 |
| Clean filter | | Allergen Clear Filter × 1, Photocatalytic Washable Deodorizing Filter × 1 |
| Piping | Liquid line mm(in) | φ 6.35(1/4") |
| | Gas line mm(in) | φ 12.7(1/2") |

The data are measured under the following conditions(ISO-T1). Cooling: Indoor temp. of 27CDB, 19CWB, and outdoor temp. of 35CDB. Heating: Indoor temp. of 20CDB, and outdoor temp. of 7CDB, 6CWB.
 * Indicates the value in an anechoic chamber. During operation these values are somewhat higher due to ambient conditions.

Note: The use of wall mounted fan coil units are not recommended for hair saloon environment. (Refer page 11)

INVERTER MULTI-SPLIT SYSTEM

Multi System INDOOR UNIT



Premium Series

SRK-ZMS

Wall Mounted type

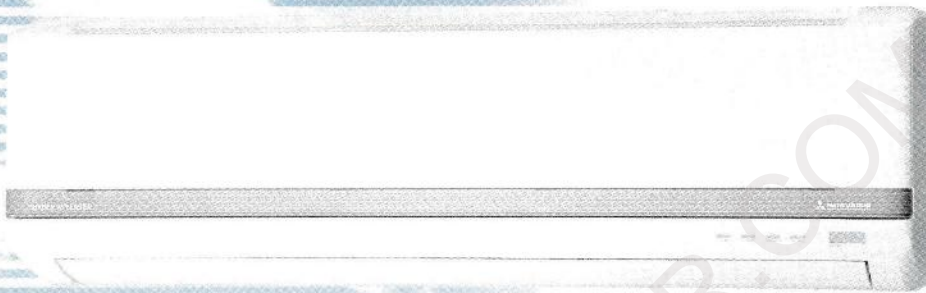

SRK71ZM-S



Standard equipment

FUNCTION



Comfortable Functions



Comfortable Air Flow Functions



Convenient & Economy Functions



Maintenance & Prevention Functions



Others



SPECIFICATIONS

| Item | Model | | SRK71ZM-S |
|-----------------------------|-------------|--------|---|
| Nominal cooling capacity | ISO-T1(JIS) | kW | 7.1 |
| Sound power level * | Cooling | dB(A) | 60 |
| Sound pressure level * | Cooling | dB(A) | Hi:49 Me:45 Lo:39 Ulo:26 |
| Air flow | Cooling | CMM | Hi:19.5 Me:17.5 Lo:14.0 Ulo:8.0 |
| Exterior dimensions (HxWxD) | | mm | 318x1098x248 |
| Net weight | | kg | 16 |
| Clean filter | | | Allergen Clear Filter × 1, Photocatalytic Washable Deodorizing Filter × 1 |
| Piping | Liquid line | mm(in) | φ 6.35(1/4") |
| | Gas line | mm(in) | φ 15.88(5/8") |

The data are measured under the following conditions(ISO-T1). Cooling: Indoor temp. of 27CDB, 19CWB, and outdoor temp. of 35CDB. Heating: Indoor temp. of 20CDB, and outdoor temp. of 7CDB, 6CWB.
 * Indicates the value in an anechoic chamber. During operation these values are somewhat higher due to ambient conditions.

Note: The use of wall mounted fan coil units are not recommended for hair saloon environment. (Refer page 11)

SRR-ZJ

Ceiling Concealed type

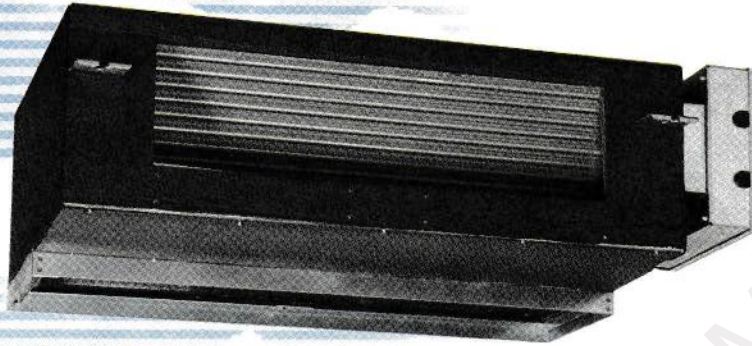

SRR35ZJ-S, SRR50ZJ-S, SRR60ZJ-S

FUNCTION



Comfortable Functions



Convenient & Economy Functions



Maintenance & Prevention Functions



Others



OPTIONAL PARTS FOR DUCTED TYPE

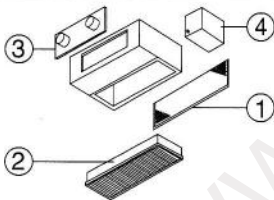

① **RBF12**
Back side air intake filter



② **RTS12**
Bottom air inlet grille set



③ **RFJ22**
Duct joint for air outlet plate



④ **RDU12E**
Drain up kit



SPECIFICATIONS

| Item | Model | SRR35ZJ-S | SRR50ZJ-S | SRR60ZJ-S |
|------------------------------|--------------------|-------------------|-------------------|-------------------|
| Cooling capacity | ISO-T1(JIS) kW | 3.5 | 5.0 | 6.0 |
| Heating capacity | ISO-T1(JIS) kW | 4.5 | 5.8 | 6.8 |
| Sound pressure level * | Cooling dB(A) | Hi:42 Me:37 Lo:30 | Hi:48 Me:42 Lo:33 | Hi:51 Me:44 Lo:35 |
| Air flow Q'ty (Hi) | Cooling CMM | 9.0 | 10.5 | 12.5 |
| Exterior dimensions(H×W×D) | mm | 230×740×455 | | |
| Net weight | kg | 22 | 23 | |
| Piping | Liquid line mm(in) | φ 6.35(1/4") | | |
| | Gas line mm(in) | φ 9.52(3/8") | | |
| OUTDOOR UNITS TO BE COMBINED | | SCM45,60,80ZJ-S | SCM60,80ZJ-S | SCM60,80ZJ-S |

The data are measured under the following conditions(ISO-T1). Cooling: Indoor temp. of 27CDB, 19CWB, and outdoor temp. of 35CDB. Heating: Indoor temp. of 20CDB, and outdoor temp. of 7CDB, 6CWB.
* Indicates the value in an anechoic chamber. During operation these values are somewhat higher due to ambient conditions.

INVERTER MULTI-SPLIT MODEL

The industry's highest COP levels

Our new models, SCM45~125ZJ-S have realized the highest level of COP (coefficient of performance) in the industry with full model change to both of outdoor and indoor (SRK series) units.

Outdoor unit uses new advanced compressors with new inverter control (Vector control) and new M shape fin.

Indoor units SRK series are the latest series, which are common to both of single and multi system, using the new heat exchanger and improved air flow system.

EER in Cooling

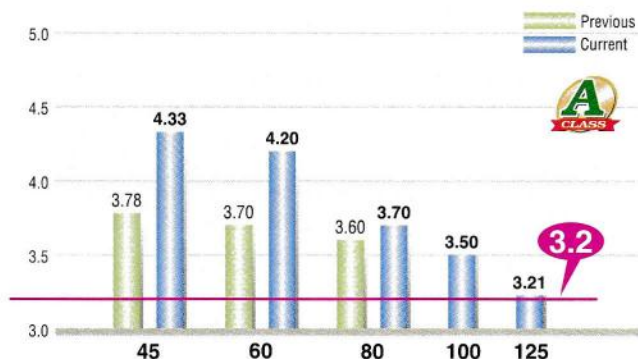

PIPING LENGTH

Limit The maximum piping length of the refrigerant pipes for the outdoor units, and the maximum height difference for the outdoor units are as shown below.

| | SCM45ZJ-S | SCM60ZJ-S1 | SCM80ZJ-S1 | SCM100/125ZJ-S1 |
|---------------------------------------|---|------------|------------|-----------------|
| length for one indoor unit | under 25m | under 25m | under 25m | under 25m |
| total length for all rooms | under 30m | under 40m | under 70m | under 90m |
| height difference | lower installation spot of the indoor unit (A) | under 15m | under 15m | under 20m |
| | upper installation spot of the indoor unit (B) | under 15m | under 15m | under 20m |
| | maximum height difference of the indoor units (C) | under 25m | under 25m | under 25m |
| length of precharged refrigerant pipe | 30m | 40m | 40m | 50m |

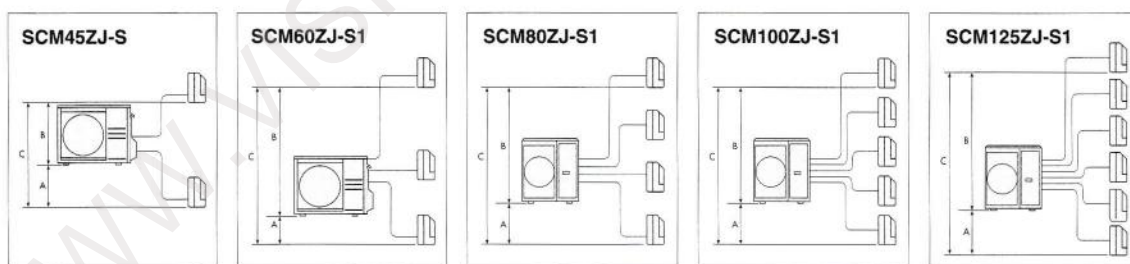

OUTDOOR UNIT SPECIFICATIONS

| Item | Model | | | For two rooms | For three rooms | For four rooms | For five rooms | For six rooms |
|-----------------------------|---------|-------|--|----------------------------|-----------------|-------------------|--------------------|--------------------|
| | | | | SCM45ZJ-S | SCM60ZJ-S1 | SCM80ZJ-S1 | SCM100ZJ-S1 | SCM125ZJ-S1 |
| Power supply | | | | 1Phase, 220/230/240V, 50Hz | | | | |
| Nominal cooling capacity | ISO-T1 | kW | | 4.5(1.8~6.4) | 6.0(1.8~7.5) | 8.0(1.8~9.2) | 10.0(1.8~12.0) | 12.5(1.8~14.0) |
| Cooling input | at 230V | kW | | 1.04(0.49~2.14) | 1.43(0.50~2.39) | 2.16(0.48~2.83) | 2.86(0.65~4.03) | 3.90(0.65~4.80) |
| Energy label | Cooling | | | A/A | A/A | A/A | A/A | A/A |
| EER (In cooling) | | | | 4.33 | 4.2 | 3.70 | 3.50 | 3.21 |
| Running current | Cooling | A | | 4.8/4.6/4.4 | 6.8/6.5/6.2 | 9.9/9.4/9.0 | 13.0/12.4/11.9 | 17.7/17.0/16.3 |
| Inrush current (Max) | | A | | 5.5/5.3/5.1(14) | 7.1/6.8/6.6(17) | 10.4/10.0/9.5(20) | 13.3/12.8/12.2(29) | 17.7/17.0/16.3(29) |
| Sound power level* | Cooling | dB(A) | | 60 | 63 | 66 | 68 | 69 |
| Sound pressure level* | Cooling | dB(A) | | 47 | 50 | 54 | 56 | 57 |
| Air flow | Cooling | CMM | | 40.0 | 42.0 | 56.0 | 75.0 | 75.0 |
| Exterior dimensions (H×W×D) | | mm | | 640×850(+65)×290 | | 750×880(+73)×340 | 945×970(+73)×370 | |
| Net weight | | kg | | 47 | 49 | 62 | 92 | |
| Refrigerant | | | | R410A | | | | |
| Total indoor units capacity | | kW | | 7.0 | 11.0 | 13.5 | 16.0 | 19.5 |

The data are measured under the following conditions(ISO-T1). Cooling: Indoor temp. of 27CDB, 19CWB, and outdoor temp. of 35CDB.

* Indicates the value in an anechoic chamber. During operation these values are somewhat higher due to ambient conditions.

Control option

Wired remote control can be connected

| Model | Interface | Remote Control |
|--|--------------|----------------|
| SRK25-60ZMX-S/S1 SRK71/80ZM-S SRK25-50ZMA-S SRF35/50ZJX-S/S1 SRR35/50/60ZJ-S | SC-BIKN-E | RC-E5 |
| FDT※ | not required | |

※ If wireless remote control is required, use RCN-TC-24W-ER

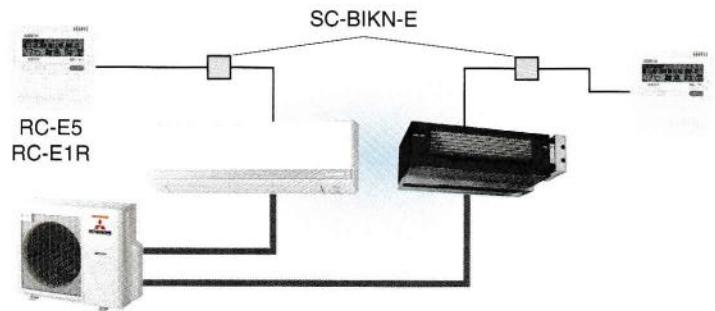

Can be connected to SUPERLINK-@

| Model | Interface | Remote Control |
|---|------------------------|----------------|
| SRK25-60ZMX-S SRK71/80ZM-S SRK25-50ZMA-S SRF35/50ZJX-S/S1 SRR35/50/60ZJ-S | SC-BIKN-E SC-ADNA-E | RC-E5 |
| FDT | SC-ADNA-E | |

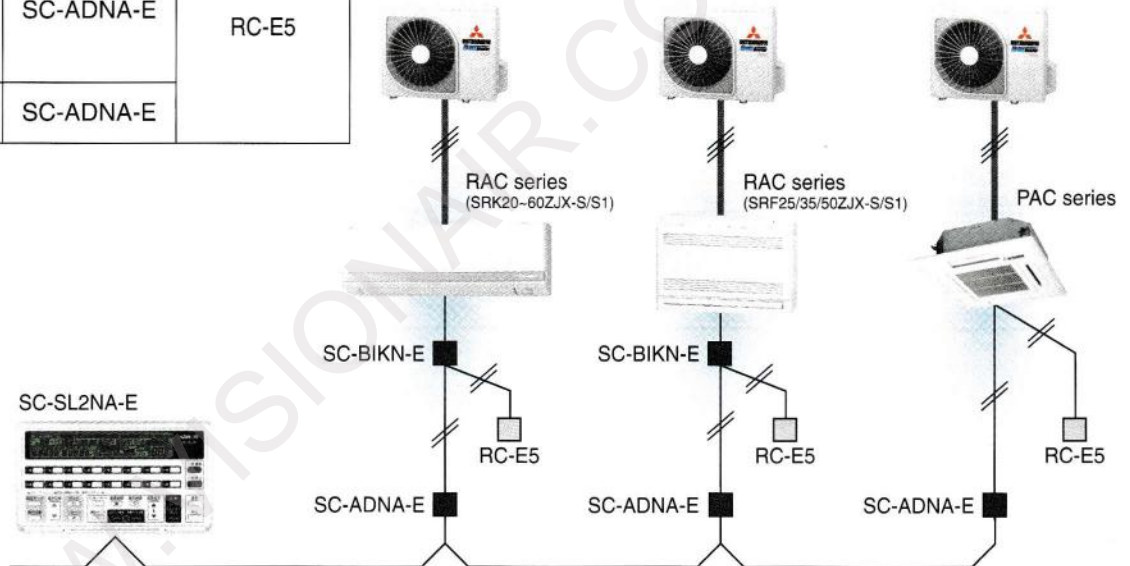

External switch connection CnT

All indoor units are equipped with an additional connection point-CnT-to connect indoor units to an external ON/OFF switch; e.g. time clock, fire alarm, etc.

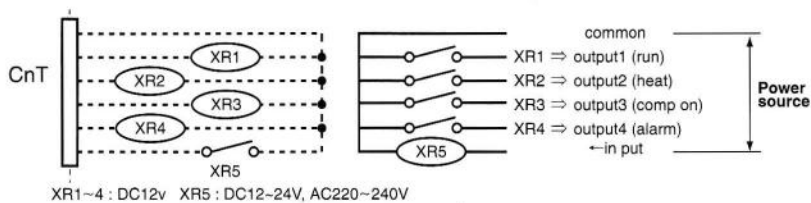

XR1~4 : DC12v XR5 : DC12-24V, AC220~240V

| Model | Interface |
|--|--------------|
| FDT | not required |
| SRK20-60ZMX-S SRK63/71/80ZM-S SRK25-50ZMA-S SRF35/50ZJX-S/S1 SRR35/50/60ZJ-S | SC-BIKN-E |



Remote surveillance system



Card key on-off



Humidifier linkage

**Table of Indoor unit combination SCM45ZJ-S
(Cooling operation)**

| Indoor unit combination | Cooling capacity (kW) | | | | | | Power consumption (W) | | | Standard current (A) | | | |
|-------------------------|----------------------------|--------|------|---------------------|----------|------|-----------------------|----------|------|----------------------|------|------|-----|
| | Room cooling capacity (kW) | | | Total capacity (kW) | | | Min. | Standard | Max. | 220V | 230V | 240V | |
| | A room | B room | | Min. | Standard | Max. | | | | | | | |
| 1 room | 25 | 2.5 | — | — | 1.8 | 2.5 | 3.2 | 490 | 710 | 1040 | 3.3 | 3.1 | 3.0 |
| | 35 | 3.5 | — | — | 1.8 | 3.5 | 3.7 | 490 | 1030 | 1200 | 4.7 | 4.5 | 4.3 |
| 2 room | 25 + 25 | 2.50 | 2.50 | — | 3.0 | 5.0 | 6.1 | 560 | 1340 | 2050 | 6.2 | 5.9 | 5.6 |
| | 25 + 35 | 2.42 | 3.38 | — | 3.0 | 5.8 | 6.3 | 560 | 1820 | 2140 | 8.4 | 8.0 | 7.7 |
| | 35 + 35 | 2.90 | 2.90 | — | 3.0 | 5.8 | 6.3 | 560 | 1820 | 2140 | 8.4 | 8.0 | 7.7 |

**Table of Indoor unit combination SCM60ZJ-S1
(Cooling operation)**

| Indoor unit combination | Cooling capacity (kW) | | | | | | Power consumption (W) | | | Standard current (A) | | | |
|-------------------------|----------------------------|--------|--------|---------------------|----------|------|-----------------------|----------|------|----------------------|------|------|------|
| | Room Cooling capacity (kW) | | | Total capacity (kW) | | | Min. | Standard | Max. | 220V | 230V | 240V | |
| | A room | B room | C room | Min. | Standard | Max. | | | | | | | |
| 1 room | 25 | 2.5 | — | — | 1.8 | 2.5 | 3.2 | 500 | 760 | 1080 | 3.5 | 3.3 | 3.2 |
| | 35 | 3.5 | — | — | 1.8 | 3.5 | 3.7 | 500 | 1150 | 1240 | 5.3 | 5.1 | 4.8 |
| | 50 | 5.0 | — | — | 1.8 | 5.0 | 5.6 | 500 | 1860 | 2100 | 8.5 | 8.2 | 7.8 |
| | 60 | 6.0 | — | — | 1.8 | 6.0 | 6.1 | 500 | 2350 | 2370 | 10.8 | 10.3 | 9.9 |
| 2 room | 25 + 25 | 2.45 | 2.45 | — | 3.0 | 4.9 | 6.1 | 570 | 1340 | 2110 | 6.2 | 5.9 | 5.6 |
| | 25 + 35 | 2.42 | 3.38 | — | 3.0 | 5.8 | 6.4 | 570 | 1920 | 2270 | 8.8 | 8.4 | 8.1 |
| | 25 + 50 | 2.23 | 4.47 | — | 3.0 | 6.7 | 6.8 | 570 | 2370 | 2390 | 10.9 | 10.4 | 10.0 |
| | 25 + 60 | 1.97 | 4.73 | — | 3.0 | 6.7 | 6.8 | 570 | 2370 | 2390 | 10.9 | 10.4 | 10.0 |
| | 35 + 35 | 3.30 | 3.30 | — | 3.0 | 6.6 | 6.8 | 570 | 2330 | 2390 | 10.7 | 10.2 | 9.8 |
| | 35 + 50 | 2.76 | 3.94 | — | 3.0 | 6.7 | 6.8 | 570 | 2370 | 2390 | 10.9 | 10.4 | 10.0 |
| | 35 + 60 | 2.47 | 4.23 | — | 3.0 | 6.7 | 6.8 | 570 | 2370 | 2390 | 10.9 | 10.4 | 10.0 |
| | 50 + 50 | 3.35 | 3.35 | — | 3.0 | 6.7 | 6.8 | 570 | 2370 | 2390 | 10.9 | 10.4 | 10.0 |
| | 50 + 60 | 3.05 | 3.65 | — | 3.0 | 6.7 | 6.8 | 570 | 2370 | 2390 | 10.9 | 10.4 | 10.0 |
| 3 room | 25 + 25 + 25 | 2.00 | 2.00 | 2.00 | 3.6 | 6.0 | 7.3 | 690 | 1470 | 2390 | 7.0 | 6.7 | 6.4 |
| | 25 + 25 + 35 | 1.79 | 1.79 | 2.51 | 3.6 | 6.1 | 7.3 | 690 | 1500 | 2390 | 7.1 | 6.8 | 6.5 |
| | 25 + 25 + 50 | 1.60 | 1.60 | 3.20 | 3.6 | 6.4 | 7.3 | 690 | 1540 | 2390 | 7.3 | 7.0 | 6.7 |
| | 25 + 25 + 60 | 1.52 | 1.52 | 3.65 | 3.6 | 6.7 | 7.3 | 690 | 1580 | 2390 | 7.5 | 7.2 | 6.9 |
| | 25 + 35 + 35 | 1.68 | 2.36 | 2.36 | 3.6 | 6.4 | 7.3 | 690 | 1540 | 2390 | 7.3 | 7.0 | 6.7 |
| | 25 + 35 + 50 | 1.52 | 2.13 | 3.05 | 3.6 | 6.7 | 7.3 | 690 | 1580 | 2390 | 7.5 | 7.2 | 6.9 |
| | 25 + 35 + 60 | 1.52 | 2.13 | 3.05 | 3.6 | 6.7 | 7.3 | 690 | 1580 | 2390 | 7.5 | 7.2 | 6.9 |
| | 35 + 35 + 35 | 2.20 | 2.20 | 2.20 | 3.6 | 6.6 | 7.3 | 690 | 1560 | 2390 | 7.4 | 7.1 | 6.8 |

**Table of Indoor unit combination SCM80ZJ-S1
(Cooling operation)**

| Indoor unit combination | Cooling capacity (kW) | | | | | | Power consumption (W) | | | Standard current (A) | | | |
|-------------------------|----------------------------|--------|------|---------------------|----------|------|-----------------------|----------|------|----------------------|------|------|------|
| | Room cooling capacity (kW) | | | Total capacity (kW) | | | Min. | Standard | Max. | 220V | 230V | 240V | |
| | A room | B room | | Min. | Standard | Max. | | | | | | | |
| 1 room | 25 | 2.5 | — | — | 1.8 | 2.5 | 3.2 | 480 | 730 | 1080 | 3.4 | 3.2 | 3.1 |
| | 35 | 3.5 | — | — | 1.8 | 3.5 | 3.7 | 480 | 1120 | 1240 | 5.1 | 4.9 | 4.7 |
| | 50 | 5.0 | — | — | 1.8 | 5.0 | 5.8 | 480 | 1710 | 2100 | 7.9 | 7.5 | 7.2 |
| | 60 | 6.0 | — | — | 1.8 | 6.0 | 6.7 | 480 | 2140 | 2700 | 9.8 | 9.4 | 9.0 |
| 2 room | 25 + 25 | 2.50 | 2.50 | — | 3.0 | 5.0 | 6.5 | 550 | 1360 | 2270 | 6.2 | 6.0 | 5.7 |
| | 25 + 35 | 2.46 | 3.44 | — | 3.0 | 5.9 | 6.8 | 550 | 1780 | 2470 | 8.2 | 7.8 | 7.5 |
| | 25 + 50 | 2.47 | 4.93 | — | 3.0 | 7.4 | 7.5 | 550 | 2430 | 2830 | 11.2 | 10.7 | 10.2 |
| | 25 + 60 | 2.18 | 5.22 | — | 3.0 | 7.4 | 7.5 | 550 | 2430 | 2830 | 11.2 | 10.7 | 10.2 |
| | 35 + 35 | 3.45 | 3.45 | — | 3.0 | 6.9 | 7.5 | 550 | 2200 | 2680 | 10.1 | 9.7 | 9.3 |
| | 35 + 50 | 3.05 | 4.35 | — | 3.0 | 7.4 | 7.5 | 550 | 2430 | 2830 | 11.2 | 10.7 | 10.2 |
| | 35 + 60 | 2.73 | 4.67 | — | 3.0 | 7.4 | 7.5 | 550 | 2430 | 2830 | 11.2 | 10.7 | 10.2 |
| | 50 + 50 | 3.70 | 3.70 | — | 3.0 | 7.4 | 7.5 | 550 | 2430 | 2830 | 11.2 | 10.7 | 10.2 |
| | 50 + 60 | 3.36 | 4.04 | — | 3.0 | 7.4 | 7.5 | 550 | 2430 | 2830 | 11.2 | 10.7 | 10.2 |
| | 60 + 60 | 3.70 | 3.70 | — | 3.0 | 7.4 | 7.5 | 550 | 2430 | 2830 | 11.2 | 10.7 | 10.2 |
| 3 room | 25 + 25 + 25 | 2.37 | 2.37 | 2.37 | 3.7 | 7.1 | 8.1 | 670 | 1950 | 2830 | 9.0 | 8.6 | 8.2 |
| | 25 + 25 + 35 | 2.29 | 2.29 | 3.21 | 3.7 | 7.8 | 8.1 | 670 | 2320 | 2830 | 10.7 | 10.2 | 9.8 |
| | 25 + 25 + 50 | 1.95 | 1.95 | 3.90 | 3.7 | 7.8 | 8.1 | 670 | 2320 | 2830 | 10.7 | 10.2 | 9.8 |
| | 25 + 25 + 60 | 1.77 | 1.77 | 4.25 | 3.7 | 7.8 | 8.1 | 670 | 2320 | 2830 | 10.7 | 10.2 | 9.8 |
| | 25 + 35 + 35 | 2.05 | 2.87 | 2.87 | 3.7 | 7.8 | 8.1 | 670 | 2320 | 2830 | 10.7 | 10.2 | 9.8 |
| | 25 + 35 + 50 | 1.77 | 2.48 | 3.55 | 3.7 | 7.8 | 8.1 | 670 | 2320 | 2830 | 10.7 | 10.2 | 9.8 |
| | 25 + 35 + 60 | 1.63 | 2.28 | 3.90 | 3.7 | 7.8 | 8.1 | 670 | 2320 | 2830 | 10.7 | 10.2 | 9.8 |
| | 25 + 50 + 50 | 1.56 | 3.12 | 3.12 | 3.7 | 7.8 | 8.1 | 670 | 2320 | 2830 | 10.7 | 10.2 | 9.8 |
| | 25 + 50 + 60 | 1.44 | 2.89 | 3.47 | 3.7 | 7.8 | 8.1 | 670 | 2320 | 2830 | 10.7 | 10.2 | 9.8 |
| | 35 + 35 + 35 | 2.60 | 2.60 | 2.60 | 3.7 | 7.8 | 8.1 | 670 | 2320 | 2830 | 10.7 | 10.2 | 9.8 |
| | 35 + 35 + 50 | 2.28 | 2.28 | 3.25 | 3.7 | 7.8 | 8.1 | 670 | 2320 | 2830 | 10.7 | 10.2 | 9.8 |
| | 35 + 35 + 60 | 2.10 | 2.10 | 3.60 | 3.7 | 7.8 | 8.1 | 670 | 2320 | 2830 | 10.7 | 10.2 | 9.8 |
| | 35 + 50 + 50 | 2.02 | 2.89 | 2.89 | 3.7 | 7.8 | 8.1 | 670 | 2320 | 2830 | 10.7 | 10.2 | 9.8 |
| 4 room | 25 + 25 + 25 + 25 | 1.98 | 1.98 | 1.98 | 4.4 | 7.9 | 8.7 | 890 | 2200 | 2830 | 10.0 | 9.6 | 9.2 |
| | 25 + 25 + 25 + 35 | 1.80 | 1.80 | 1.80 | 4.4 | 7.9 | 8.7 | 890 | 2200 | 2830 | 10.0 | 9.6 | 9.2 |
| | 25 + 25 + 25 + 50 | 1.60 | 1.60 | 1.60 | 4.4 | 8.0 | 8.7 | 890 | 2220 | 2830 | 10.1 | 9.7 | 9.3 |
| | 25 + 25 + 25 + 60 | 1.48 | 1.48 | 1.48 | 4.4 | 8.0 | 8.7 | 890 | 2220 | 2830 | 10.1 | 9.7 | 9.3 |
| | 25 + 25 + 35 + 35 | 1.67 | 1.67 | 2.33 | 4.4 | 8.0 | 8.7 | 890 | 2220 | 2830 | 10.1 | 9.7 | 9.3 |
| | 25 + 25 + 35 + 50 | 1.48 | 1.48 | 2.07 | 4.4 | 8.0 | 8.7 | 890 | 2220 | 2830 | 10.1 | 9.7 | 9.3 |
| | 25 + 35 + 35 + 35 | 1.54 | 2.15 | 2.15 | 4.4 | 8.0 | 8.7 | 890 | 2220 | 2830 | 10.1 | 9.7 | 9.3 |

Table of Indoor unit combination SCM100ZJ-S1 (30A) ISOLATOR (Cooling operation)

| Indoor unit combination | Cooling capacity (kW) | | | | | | Total capacity (kW) | | | Power consumption (W) | | | Standard current (A) | | |
|-------------------------|----------------------------|--------|--------|--------|--------|--------|---------------------|----------|------|-----------------------|----------|------|----------------------|------|------|
| | Room cooling capacity (kW) | | | | | | Min. | Standard | Max. | Min. | Standard | Max. | 220V | 230V | 240V |
| | A room | B room | C room | D room | E room | F room | | | | | | | | | |
| 1 room | 25 | 2.5 | - | - | - | - | 1.8 | 2.5 | 3.2 | 650 | 1000 | 1350 | 4.6 | 4.4 | 4.2 |
| | 35 | 3.5 | - | - | - | - | 1.8 | 3.5 | 3.7 | 650 | 1500 | 1600 | 6.9 | 6.6 | 6.3 |
| | 50 | 5.0 | - | - | - | - | 1.8 | 5.0 | 5.8 | 650 | 2150 | 2500 | 9.9 | 9.4 | 9.0 |
| | 60 | 6.0 | - | - | - | - | 1.8 | 6.0 | 6.7 | 650 | 2720 | 3000 | 12.5 | 11.9 | 11.4 |
| | 71 | 7.1 | - | - | - | - | 1.8 | 7.1 | 7.2 | 650 | 3250 | 3080 | 14.9 | 14.3 | 13.7 |
| 2 room | 25 + 25 | 2.50 | 2.50 | - | - | - | 3.0 | 5.0 | 6.8 | 740 | 1420 | 2200 | 6.5 | 6.2 | 6.0 |
| | 25 + 35 | 2.50 | 3.50 | - | - | - | 3.0 | 6.0 | 6.9 | 740 | 1810 | 2320 | 8.3 | 7.9 | 7.6 |
| | 25 + 50 | 2.50 | 5.00 | - | - | - | 3.0 | 7.5 | 9.0 | 740 | 2470 | 3220 | 11.3 | 10.8 | 10.4 |
| | 25 + 60 | 2.50 | 6.00 | - | - | - | 3.0 | 8.5 | 9.4 | 740 | 2810 | 3360 | 12.9 | 12.3 | 11.8 |
| | 25 + 71 | 2.53 | 7.17 | - | - | - | 3.0 | 9.7 | 10.4 | 740 | 3350 | 4020 | 15.4 | 14.7 | 14.1 |
| | 35 + 35 | 3.50 | 3.50 | - | - | - | 3.0 | 7.0 | 7.4 | 740 | 2290 | 2820 | 10.5 | 10.1 | 9.6 |
| | 35 + 50 | 3.50 | 5.00 | - | - | - | 3.0 | 8.5 | 9.5 | 740 | 2810 | 3620 | 12.9 | 12.3 | 11.8 |
| | 35 + 60 | 3.50 | 6.00 | - | - | - | 3.0 | 9.5 | 10.4 | 740 | 3280 | 3990 | 15.1 | 14.4 | 13.8 |
| | 35 + 71 | 3.30 | 6.70 | - | - | - | 3.0 | 10.0 | 10.9 | 740 | 3480 | 4250 | 15.8 | 15.1 | 14.5 |
| | 50 + 50 | 5.00 | 5.00 | - | - | - | 3.0 | 10.0 | 11.6 | 740 | 3480 | 4350 | 16.0 | 15.3 | 14.6 |
| | 50 + 60 | 4.55 | 5.45 | - | - | - | 3.0 | 10.0 | 11.8 | 740 | 3480 | 4410 | 16.0 | 15.3 | 14.6 |
| 50 + 71 | 4.13 | 5.87 | - | - | - | 3.0 | 10.0 | 11.8 | 740 | 3470 | 4410 | 15.8 | 15.1 | 14.5 | |
| 60 + 60 | 5.00 | 5.00 | - | - | - | 3.0 | 10.0 | 11.8 | 740 | 3470 | 4410 | 15.9 | 15.2 | 14.6 | |
| 60 + 71 | 4.58 | 5.42 | - | - | - | 3.0 | 10.0 | 11.8 | 740 | 3470 | 4410 | 15.8 | 15.1 | 14.5 | |
| 71 + 71 | 5.00 | 5.00 | - | - | - | 3.0 | 10.0 | 11.8 | 740 | 3460 | 4410 | 15.6 | 14.9 | 14.3 | |
| 3 room | 25 + 25 + 25 | 2.50 | 2.50 | 2.50 | - | - | 3.7 | 7.5 | 9.4 | 880 | 2130 | 3340 | 9.8 | 9.4 | 9.0 |
| | 25 + 25 + 35 | 2.50 | 2.50 | 3.50 | - | - | 3.7 | 8.5 | 9.9 | 880 | 2650 | 3540 | 12.2 | 11.6 | 11.2 |
| | 25 + 25 + 50 | 2.50 | 2.50 | 5.00 | - | - | 3.7 | 10.0 | 11.8 | 880 | 3280 | 4250 | 15.1 | 14.4 | 13.8 |
| | 25 + 25 + 60 | 2.27 | 2.27 | 5.45 | - | - | 3.7 | 10.0 | 11.8 | 880 | 3280 | 4250 | 15.1 | 14.4 | 13.8 |
| | 25 + 25 + 71 | 2.07 | 2.07 | 5.87 | - | - | 3.7 | 10.0 | 11.8 | 880 | 3270 | 4250 | 15.0 | 14.4 | 13.8 |
| | 25 + 35 + 35 | 2.50 | 3.50 | 3.50 | - | - | 3.7 | 9.5 | 10.4 | 880 | 3130 | 3950 | 14.4 | 13.7 | 13.2 |
| | 25 + 35 + 50 | 2.27 | 3.18 | 4.55 | - | - | 3.7 | 10.0 | 11.8 | 880 | 3280 | 4250 | 15.1 | 14.4 | 13.8 |
| | 25 + 35 + 60 | 2.08 | 2.92 | 5.00 | - | - | 3.7 | 10.0 | 11.8 | 880 | 3270 | 4250 | 15.0 | 14.4 | 13.8 |
| | 25 + 35 + 71 | 1.91 | 2.67 | 5.42 | - | - | 3.7 | 10.0 | 11.8 | 880 | 3270 | 4250 | 15.0 | 14.4 | 13.8 |
| | 25 + 50 + 50 | 2.00 | 4.00 | 4.00 | - | - | 3.7 | 10.0 | 11.8 | 880 | 3270 | 4250 | 15.0 | 14.4 | 13.8 |
| | 25 + 50 + 60 | 1.85 | 3.70 | 4.44 | - | - | 3.7 | 10.0 | 11.8 | 880 | 3270 | 4250 | 15.0 | 14.4 | 13.8 |
| | 25 + 50 + 71 | 1.71 | 3.42 | 4.86 | - | - | 3.7 | 10.0 | 11.8 | 880 | 3260 | 4250 | 15.0 | 14.4 | 13.8 |
| | 25 + 60 + 60 | 1.72 | 4.14 | 4.14 | - | - | 3.7 | 10.0 | 11.8 | 880 | 3260 | 4250 | 15.0 | 14.4 | 13.8 |
| | 25 + 60 + 71 | 1.60 | 3.85 | 4.55 | - | - | 3.7 | 10.0 | 11.8 | 880 | 3260 | 4250 | 15.0 | 14.4 | 13.8 |
| | 35 + 35 + 35 | 3.33 | 3.33 | 3.33 | - | - | 3.7 | 10.0 | 10.9 | 880 | 3280 | 4120 | 15.1 | 14.4 | 13.8 |
| | 35 + 35 + 50 | 2.92 | 2.92 | 4.17 | - | - | 3.7 | 10.0 | 11.8 | 880 | 3270 | 4250 | 15.0 | 14.4 | 13.8 |
| | 35 + 35 + 60 | 2.69 | 2.69 | 4.62 | - | - | 3.7 | 10.0 | 11.8 | 880 | 3270 | 4250 | 15.0 | 14.4 | 13.8 |
| | 35 + 35 + 71 | 2.48 | 2.48 | 5.04 | - | - | 3.7 | 10.0 | 11.8 | 880 | 3260 | 4250 | 14.8 | 14.2 | 13.6 |
| | 35 + 50 + 50 | 2.59 | 3.70 | 3.70 | - | - | 3.7 | 10.0 | 11.8 | 880 | 3270 | 4250 | 15.0 | 14.4 | 13.8 |
| | 35 + 50 + 60 | 2.41 | 3.45 | 4.14 | - | - | 3.7 | 10.0 | 11.8 | 880 | 3260 | 4250 | 15.0 | 14.3 | 13.7 |
| 35 + 50 + 71 | 2.24 | 3.21 | 4.55 | - | - | 3.7 | 10.0 | 11.8 | 880 | 3260 | 4250 | 15.0 | 14.3 | 13.7 | |
| 35 + 60 + 60 | 2.26 | 3.87 | 3.87 | - | - | 3.7 | 10.0 | 11.8 | 880 | 3260 | 4250 | 15.0 | 14.3 | 13.7 | |
| 50 + 50 + 50 | 3.33 | 3.33 | 3.33 | - | - | 3.7 | 10.0 | 11.8 | 880 | 3260 | 4250 | 15.0 | 14.3 | 13.7 | |
| 50 + 50 + 60 | 3.13 | 3.13 | 3.75 | - | - | 3.7 | 10.0 | 11.8 | 880 | 3260 | 4250 | 15.0 | 14.3 | 13.7 | |
| 4 room | 25 + 25 + 25 + 25 | 2.50 | 2.50 | 2.50 | 2.50 | - | 4.4 | 10.0 | 11.8 | 1100 | 3220 | 4050 | 14.7 | 14.0 | 13.4 |
| | 25 + 25 + 25 + 35 | 2.27 | 2.27 | 2.27 | 3.18 | - | 4.4 | 10.0 | 11.8 | 1100 | 3210 | 4050 | 14.6 | 14.0 | 13.4 |
| | 25 + 25 + 25 + 50 | 2.00 | 2.00 | 2.00 | 4.00 | - | 4.4 | 10.0 | 11.8 | 1100 | 3210 | 4050 | 14.6 | 14.0 | 13.4 |
| | 25 + 25 + 25 + 60 | 1.85 | 1.85 | 1.85 | 4.44 | - | 4.4 | 10.0 | 11.8 | 1100 | 3200 | 4050 | 14.6 | 13.9 | 13.3 |
| | 25 + 25 + 25 + 71 | 1.71 | 1.71 | 1.71 | 4.86 | - | 4.4 | 10.0 | 11.8 | 1100 | 3190 | 4050 | 14.5 | 13.9 | 13.3 |
| | 25 + 25 + 35 + 35 | 2.08 | 2.08 | 2.92 | 2.92 | - | 4.4 | 10.0 | 11.8 | 1100 | 3210 | 4050 | 14.6 | 14.0 | 13.4 |
| | 25 + 25 + 35 + 50 | 1.85 | 1.85 | 2.59 | 3.70 | - | 4.4 | 10.0 | 11.8 | 1100 | 3200 | 4050 | 14.6 | 13.9 | 13.3 |
| | 25 + 25 + 35 + 60 | 1.72 | 1.72 | 2.41 | 4.14 | - | 4.4 | 10.0 | 11.8 | 1100 | 3190 | 4050 | 14.5 | 13.9 | 13.3 |
| | 25 + 25 + 35 + 71 | 1.60 | 1.60 | 2.24 | 4.55 | - | 4.4 | 10.0 | 11.8 | 1100 | 3190 | 4050 | 14.5 | 13.9 | 13.3 |
| | 25 + 25 + 50 + 50 | 1.67 | 1.67 | 3.33 | 3.33 | - | 4.4 | 10.0 | 11.8 | 1100 | 3190 | 4050 | 14.5 | 13.9 | 13.3 |
| | 25 + 25 + 50 + 60 | 1.56 | 1.56 | 3.13 | 3.75 | - | 4.4 | 10.0 | 11.8 | 1100 | 3180 | 4050 | 14.5 | 13.8 | 13.3 |
| | 25 + 35 + 35 + 35 | 1.92 | 2.69 | 2.69 | 2.69 | - | 4.4 | 10.0 | 11.8 | 1100 | 3200 | 4050 | 14.6 | 13.9 | 13.3 |
| | 25 + 35 + 35 + 50 | 1.72 | 2.41 | 2.41 | 3.45 | - | 4.4 | 10.0 | 11.8 | 1100 | 3190 | 4050 | 14.5 | 13.9 | 13.3 |
| | 25 + 35 + 35 + 60 | 1.61 | 2.26 | 2.26 | 3.87 | - | 4.4 | 10.0 | 11.8 | 1100 | 3190 | 4050 | 14.5 | 13.9 | 13.3 |
| | 25 + 35 + 50 + 50 | 1.56 | 2.19 | 3.13 | 3.13 | - | 4.4 | 10.0 | 11.8 | 1100 | 3180 | 4050 | 14.5 | 13.8 | 13.3 |
| | 35 + 35 + 35 + 35 | 2.50 | 2.50 | 2.50 | 2.50 | - | 4.4 | 10.0 | 11.8 | 1100 | 3190 | 4050 | 14.5 | 13.9 | 13.3 |
| | 35 + 35 + 35 + 50 | 2.26 | 2.26 | 2.26 | 3.23 | - | 4.4 | 10.0 | 11.8 | 1100 | 3190 | 4050 | 14.5 | 13.9 | 13.3 |
| 5 room | 25 + 25 + 25 + 25 + 25 | 2.00 | 2.00 | 2.00 | 2.00 | 2.00 | 5.1 | 10.0 | 11.8 | 1210 | 2940 | 4030 | 13.4 | 12.8 | 12.3 |
| | 25 + 25 + 25 + 25 + 35 | 1.85 | 1.85 | 1.85 | 1.85 | 2.59 | 5.1 | 10.0 | 11.8 | 1210 | 2940 | 4030 | 13.4 | 12.8 | 12.3 |
| | 25 + 25 + 25 + 25 + 50 | 1.67 | 1.67 | 1.67 | 1.67 | 3.33 | 5.1 | 10.0 | 11.8 | 1210 | 2930 | 4030 | 13.3 | 12.8 | 12.2 |
| | 25 + 25 + 25 + 25 + 60 | 1.56 | 1.56 | 1.56 | 1.56 | 3.75 | 5.1 | 10.0 | 11.8 | 1210 | 2930 | 4030 | 13.3 | 12.8 | 12.2 |
| | 25 + 25 + 25 + 35 + 35 | 1.72 | 1.72 | 1.72 | 2.41 | 2.41 | 5.1 | 10.0 | 11.8 | 1210 | 2930 | 4030 | 13.3 | 12.8 | 12.2 |
| | 25 + 25 + 25 + 35 + 50 | 1.56 | 1.56 | 1.56 | 2.19 | 3.13 | 5.1 | 10.0 | 11.8 | 1210 | 2930 | 4030 | 13.3 | 12.8 | 12.2 |
| 25 + 25 + 35 + 35 + 35 | 1.61 | 1.61 | 2.26 | 2.26 | 2.26 | 5.1 | 10.0 | 11.8 | 1210 | 2930 | 4030 | 13.3 | 12.8 | 12.2 | |

Table of Indoor unit combination SCM125ZJ-S1 (30A) ISOLATOR (Cooling operation)

| Indoor unit combination | Cooling capacity (kW) | | | | | | Total capacity (kW) | | | Power consumption (W) | | | Standard current (A) | | |
|-------------------------|----------------------------|--------|--------|--------|--------|--------|---------------------|----------|------|-----------------------|----------|------|----------------------|------|------|
| | Room cooling capacity (kW) | | | | | | Min. | Standard | Max. | Min. | Standard | Max. | 220V | 230V | 240V |
| | A room | B room | C room | D room | E room | F room | | | | | | | | | |
| 1 room | 25 | 2.5 | - | - | - | - | 1.8 | 2.5 | 3.2 | 650 | 1000 | 1350 | 4.6 | 4.4 | 4.2 |
| | 35 | 3.5 | - | - | - | - | 1.8 | 3.5 | 3.7 | 650 | 1500 | 1600 | 6.9 | 6.6 | 6.3 |
| | 50 | 5.0 | - | - | - | - | 1.8 | 5.0 | 5.8 | 650 | 2150 | 2500 | 9.9 | 9.4 | 9.0 |
| | 60 | 6.0 | - | - | - | - | 1.8 | 6.0 | 6.7 | 650 | 2720 | 3000 | 12.5 | 11.9 | 11.4 |
| | 71 | 7.1 | - | - | - | - | 1.8 | 7.1 | 7.2 | 650 | 3250 | 3080 | 14.9 | 14.3 | 13.7 |
| 2 room | 25 + 25 | 2.50 | 2.50 | - | - | - | 3.0 | 5.0 | 6.8 | 740 | 1420 | 2200 | 6.5 | 6.2 | 6.0 |
| | 25 + 35 | 2.50 | 3.50 | - | - | - | 3.0 | 6.0 | 6.9 | 740 | 1810 | 2320 | 8.3 | 7.9 | 7.6 |
| | 25 + 50 | 2.50 | 5.00 | - | - | - | 3.0 | 7.5 | 9.0 | 740 | 2470 | 3220 | 11.3 | 10.8 | 10.4 |
| | 25 + 60 | 2.50 | 6.00 | - | - | - | 3.0 | 8.5 | 9.4 | 740 | 2810 | 3360 | 12.9 | 12.3 | 11.8 |
| | 25 + 71 | 2.53 | 7.17 | - | - | - | 3.0 | 9.7 | 10.4 | 740 | 3350 | 4020 | 15.4 | 14.7 | 14.1 |
| | 35 + 35 | 3.50 | 3.50 | - | - | - | 3.0 | 7.0 | 7.4 | 740 | 2290 | 2820 | 10.5 | 10.1 | 9.6 |
| | 35 + 50 | 3.50 | 5.00 | - | - | - | 3.0 | 8.5 | 9.5 | 740 | 2810 | 3620 | 12.9 | 12.3 | 11.8 |
| | 35 + 60 | 3.50 | 6.00 | - | - | - | 3.0 | 9.5 | 10.4 | 740 | 3280 | 3990 | 15.1 | 14.4 | 13.8 |
| | 35 + 71 | 3.50 | 7.10 | - | - | - | 3.0 | 10.6 | 10.9 | 740 | 3760 | 4250 | 17.1 | 16.3 | 15.7 |
| | 50 + 50 | 5.00 | 5.00 | - | - | - | 3.0 | 10.0 | 10.8 | 740 | 3520 | 4050 | 16.2 | 15.5 | 14.8 |
| | 50 + 60 | 5.00 | 6.00 | - | - | - | 3.0 | 11.0 | 12.0 | 740 | 3870 | 4410 | 17.8 | 17.0 | 16.3 |
| | 50 + 71 | 4.96 | 7.04 | - | - | - | 3.0 | 12.0 | 12.0 | 740 | 4410 | 4410 | 20.0 | 19.2 | 18.4 |
| | 60 + 60 | 6.00 | 6.00 | - | - | - | 3.0 | 12.0 | 12.0 | 740 | 4410 | 4410 | 20.2 | 19.4 | 18.6 |
| | 60 + 71 | 5.73 | 6.77 | | | | | | | | | | | | |

Table of Indoor unit combination SCM125ZJ-S1 (30A) ISOLATOR

| Indoor unit combination | Cooling capacity (kW) | | | | | | | | | Power consumption (W) | | | Standard current (A) | | | |
|-------------------------|----------------------------|--------|--------|--------|--------|--------|---------------------|----------|------|-----------------------|----------|------|----------------------|------|------|------|
| | Room cooling capacity (kW) | | | | | | Total capacity (kW) | | | Min. | Standard | Max. | 220V | 230V | 240V | |
| | A room | B room | C room | D room | E room | F room | Min. | Standard | Max. | | | | | | | |
| 3 room | 25 + 25 + 25 | 2.50 | 2.50 | 2.50 | - | - | - | 3.7 | 7.5 | 9.6 | 880 | 2130 | 3640 | 9.8 | 9.4 | 9.0 |
| | 25 + 25 + 35 | 2.50 | 2.50 | 3.50 | - | - | - | 3.7 | 8.5 | 10.1 | 880 | 2650 | 3900 | 12.2 | 11.6 | 11.2 |
| | 25 + 25 + 50 | 2.50 | 2.50 | 5.00 | - | - | - | 3.7 | 10.0 | 12.6 | 880 | 3420 | 4800 | 15.7 | 15.0 | 14.4 |
| | 25 + 25 + 60 | 2.50 | 2.50 | 6.00 | - | - | - | 3.7 | 11.0 | 12.6 | 880 | 3910 | 4800 | 18.0 | 17.2 | 16.5 |
| | 25 + 25 + 71 | 2.58 | 2.58 | 7.33 | - | - | - | 3.7 | 12.5 | 12.6 | 880 | 4670 | 4800 | 21.2 | 20.3 | 19.5 |
| | 25 + 35 + 35 | 2.50 | 3.50 | 3.50 | - | - | - | 3.7 | 9.5 | 10.4 | 880 | 3130 | 3910 | 14.4 | 13.7 | 13.2 |
| | 25 + 35 + 50 | 2.50 | 3.50 | 5.00 | - | - | - | 3.7 | 11.0 | 12.6 | 880 | 3910 | 4800 | 18.0 | 17.2 | 16.5 |
| | 25 + 35 + 60 | 2.50 | 3.50 | 6.00 | - | - | - | 3.7 | 12.0 | 12.6 | 880 | 4440 | 4800 | 20.4 | 19.5 | 18.7 |
| | 25 + 35 + 71 | 2.39 | 3.34 | 6.77 | - | - | - | 3.7 | 12.5 | 12.6 | 880 | 4670 | 4800 | 21.4 | 20.5 | 19.7 |
| | 25 + 50 + 50 | 2.50 | 5.00 | 5.00 | - | - | - | 3.7 | 12.5 | 12.6 | 880 | 4670 | 4800 | 21.4 | 20.5 | 19.7 |
| | 25 + 50 + 60 | 2.31 | 4.63 | 5.56 | - | - | - | 3.7 | 12.5 | 12.6 | 880 | 4670 | 4800 | 21.4 | 20.5 | 19.7 |
| | 25 + 50 + 71 | 2.14 | 4.28 | 6.08 | - | - | - | 3.7 | 12.5 | 12.6 | 880 | 4670 | 4800 | 21.4 | 20.5 | 19.7 |
| | 25 + 60 + 60 | 2.16 | 5.17 | 5.17 | - | - | - | 3.7 | 12.5 | 12.6 | 880 | 4670 | 4800 | 21.4 | 20.5 | 19.7 |
| | 25 + 60 + 71 | 2.00 | 4.81 | 5.69 | - | - | - | 3.7 | 12.5 | 12.6 | 880 | 4670 | 4800 | 21.4 | 20.5 | 19.7 |
| | 25 + 71 + 71 | 1.87 | 5.31 | 5.31 | - | - | - | 3.7 | 12.5 | 12.6 | 880 | 4670 | 4800 | 21.4 | 20.5 | 19.7 |
| | 35 + 35 + 35 | 3.50 | 3.50 | 3.50 | - | - | - | 3.7 | 10.5 | 10.9 | 880 | 3770 | 4180 | 17.3 | 16.6 | 15.9 |
| | 35 + 35 + 50 | 3.50 | 3.50 | 5.00 | - | - | - | 3.7 | 12.0 | 12.6 | 880 | 4440 | 4800 | 20.4 | 19.5 | 18.7 |
| | 35 + 35 + 60 | 3.37 | 3.37 | 5.77 | - | - | - | 3.7 | 12.5 | 12.6 | 880 | 4670 | 4800 | 21.4 | 20.5 | 19.7 |
| | 35 + 35 + 71 | 3.10 | 3.10 | 6.29 | - | - | - | 3.7 | 12.5 | 12.6 | 880 | 4660 | 4800 | 21.2 | 20.3 | 19.4 |
| | 35 + 50 + 50 | 3.24 | 4.63 | 4.63 | - | - | - | 3.7 | 12.5 | 12.6 | 880 | 4670 | 4800 | 21.4 | 20.5 | 19.7 |
| | 35 + 50 + 60 | 3.02 | 4.31 | 5.17 | - | - | - | 3.7 | 12.5 | 12.6 | 880 | 4660 | 4800 | 21.4 | 20.5 | 19.6 |
| | 35 + 50 + 71 | 2.80 | 4.01 | 5.69 | - | - | - | 3.7 | 12.5 | 12.6 | 880 | 4660 | 4800 | 21.4 | 20.5 | 19.6 |
| | 35 + 60 + 60 | 2.82 | 4.84 | 4.84 | - | - | - | 3.7 | 12.5 | 12.6 | 880 | 4660 | 4800 | 21.4 | 20.5 | 19.6 |
| | 35 + 60 + 71 | 2.64 | 4.52 | 5.35 | - | - | - | 3.7 | 12.5 | 12.6 | 880 | 4660 | 4800 | 21.4 | 20.5 | 19.6 |
| | 35 + 71 + 71 | 2.47 | 5.01 | 5.01 | - | - | - | 3.7 | 12.5 | 12.6 | 880 | 4650 | 4800 | 21.3 | 20.4 | 19.6 |
| | 50 + 50 + 50 | 4.17 | 4.17 | 4.17 | - | - | - | 3.7 | 12.5 | 12.6 | 880 | 4660 | 4800 | 21.4 | 20.5 | 19.6 |
| | 50 + 50 + 60 | 3.91 | 3.91 | 4.69 | - | - | - | 3.7 | 12.5 | 12.6 | 880 | 4660 | 4800 | 21.4 | 20.5 | 19.6 |
| | 50 + 50 + 71 | 3.65 | 3.65 | 5.19 | - | - | - | 3.7 | 12.5 | 12.6 | 880 | 4650 | 4800 | 21.3 | 20.4 | 19.6 |
| | 50 + 60 + 60 | 3.68 | 4.41 | 4.41 | - | - | - | 3.7 | 12.5 | 12.6 | 880 | 4650 | 4800 | 21.3 | 20.4 | 19.6 |
| | 50 + 60 + 71 | 3.45 | 4.14 | 4.90 | - | - | - | 3.7 | 12.5 | 12.6 | 880 | 4650 | 4800 | 21.3 | 20.4 | 19.6 |
| 60 + 60 + 60 | 4.17 | 4.17 | 4.17 | - | - | - | 3.7 | 12.5 | 12.6 | 880 | 4650 | 4800 | 21.3 | 20.4 | 19.6 | |
| 60 + 60 + 71 | 3.93 | 3.93 | 4.65 | - | - | - | 3.7 | 12.5 | 12.6 | 880 | 4650 | 4800 | 21.3 | 20.4 | 19.6 | |
| 4 room | 25 + 25 + 25 + 25 | 2.50 | 2.50 | 2.50 | 2.50 | - | - | 4.4 | 10.0 | 12.8 | 1100 | 3210 | 4800 | 14.6 | 14.0 | 13.4 |
| | 25 + 25 + 25 + 35 | 2.50 | 2.50 | 2.50 | 3.50 | - | - | 4.4 | 11.0 | 12.8 | 1100 | 3580 | 4800 | 16.3 | 15.6 | 14.9 |
| | 25 + 25 + 25 + 50 | 2.50 | 2.50 | 2.50 | 5.00 | - | - | 4.4 | 12.5 | 12.8 | 1100 | 4740 | 4800 | 21.6 | 20.6 | 19.8 |
| | 25 + 25 + 25 + 60 | 2.31 | 2.31 | 2.31 | 5.56 | - | - | 4.4 | 12.5 | 12.8 | 1100 | 4730 | 4800 | 21.5 | 20.6 | 19.7 |
| | 25 + 25 + 25 + 71 | 2.14 | 2.14 | 2.14 | 6.08 | - | - | 4.4 | 12.5 | 12.8 | 1100 | 4730 | 4800 | 21.5 | 20.6 | 19.7 |
| | 25 + 25 + 35 + 35 | 2.50 | 2.50 | 3.50 | 3.50 | - | - | 4.4 | 12.0 | 12.8 | 1100 | 4100 | 4800 | 18.7 | 17.8 | 17.1 |
| | 25 + 25 + 35 + 50 | 2.31 | 2.31 | 3.24 | 4.63 | - | - | 4.4 | 12.5 | 12.8 | 1100 | 4730 | 4800 | 21.5 | 20.6 | 19.7 |
| | 25 + 25 + 35 + 60 | 2.16 | 2.16 | 3.02 | 5.17 | - | - | 4.4 | 12.5 | 12.8 | 1100 | 4730 | 4800 | 21.5 | 20.6 | 19.7 |
| | 25 + 25 + 35 + 71 | 2.00 | 2.00 | 2.80 | 5.69 | - | - | 4.4 | 12.5 | 12.8 | 1100 | 4720 | 4800 | 21.5 | 20.5 | 19.7 |
| | 25 + 25 + 50 + 50 | 2.08 | 2.08 | 4.17 | 4.17 | - | - | 4.4 | 12.5 | 12.8 | 1100 | 4730 | 4800 | 21.5 | 20.6 | 19.7 |
| | 25 + 25 + 50 + 60 | 1.95 | 1.95 | 3.91 | 4.69 | - | - | 4.4 | 12.5 | 12.8 | 1100 | 4720 | 4800 | 21.5 | 20.5 | 19.7 |
| | 25 + 25 + 50 + 71 | 1.83 | 1.83 | 3.65 | 5.19 | - | - | 4.4 | 12.5 | 12.8 | 1100 | 4720 | 4800 | 21.5 | 20.5 | 19.7 |
| | 25 + 25 + 60 + 60 | 1.84 | 1.84 | 4.41 | 4.41 | - | - | 4.4 | 12.5 | 12.8 | 1100 | 4720 | 4800 | 21.5 | 20.5 | 19.7 |
| | 25 + 25 + 60 + 71 | 1.73 | 1.73 | 4.14 | 4.90 | - | - | 4.4 | 12.5 | 12.8 | 1100 | 4710 | 4800 | 21.4 | 20.5 | 19.6 |
| | 25 + 25 + 71 + 71 | 1.63 | 1.63 | 4.62 | 4.62 | - | - | 4.4 | 12.5 | 12.8 | 1100 | 4700 | 4800 | 21.4 | 20.5 | 19.6 |
| | 25 + 35 + 35 + 35 | 2.40 | 3.37 | 3.37 | 3.37 | - | - | 4.4 | 12.5 | 12.8 | 1100 | 4740 | 4800 | 21.6 | 20.6 | 19.8 |
| | 25 + 35 + 35 + 50 | 2.16 | 3.02 | 3.02 | 4.31 | - | - | 4.4 | 12.5 | 12.8 | 1100 | 4730 | 4800 | 21.5 | 20.6 | 19.7 |
| | 25 + 35 + 35 + 60 | 2.02 | 2.82 | 2.82 | 4.84 | - | - | 4.4 | 12.5 | 12.8 | 1100 | 4720 | 4800 | 21.5 | 20.5 | 19.7 |
| | 25 + 35 + 35 + 71 | 1.88 | 2.64 | 2.64 | 5.35 | - | - | 4.4 | 12.5 | 12.8 | 1100 | 4720 | 4800 | 21.5 | 20.5 | 19.7 |
| | 25 + 35 + 50 + 50 | 1.95 | 2.73 | 3.91 | 3.91 | - | - | 4.4 | 12.5 | 12.8 | 1100 | 4720 | 4800 | 21.5 | 20.5 | 19.7 |
| | 25 + 35 + 50 + 60 | 1.84 | 2.57 | 3.68 | 4.41 | - | - | 4.4 | 12.5 | 12.8 | 1100 | 4720 | 4800 | 21.5 | 20.5 | 19.7 |
| | 25 + 35 + 50 + 71 | 1.73 | 2.42 | 3.45 | 4.90 | - | - | 4.4 | 12.5 | 12.8 | 1100 | 4710 | 4800 | 21.4 | 20.5 | 19.6 |
| | 25 + 35 + 60 + 60 | 1.74 | 2.43 | 4.17 | 4.17 | - | - | 4.4 | 12.5 | 12.8 | 1100 | 4710 | 4800 | 21.4 | 20.5 | 19.6 |
| | 25 + 35 + 60 + 71 | 1.64 | 2.29 | 3.93 | 4.65 | - | - | 4.4 | 12.5 | 12.8 | 1100 | 4700 | 4800 | 21.4 | 20.5 | 19.6 |
| | 25 + 50 + 50 + 50 | 1.79 | 3.57 | 3.57 | 3.57 | - | - | 4.4 | 12.5 | 12.8 | 1100 | 4710 | 4800 | 21.4 | 20.5 | 19.6 |
| | 25 + 50 + 50 + 60 | 1.69 | 3.38 | 3.38 | 4.05 | - | - | 4.4 | 12.5 | 12.8 | 1100 | 4710 | 4800 | 21.4 | 20.5 | 19.6 |
| | 25 + 50 + 60 + 60 | 1.60 | 3.21 | 3.85 | 3.85 | - | - | 4.4 | 12.5 | 12.8 | 1100 | 4700 | 4800 | 21.4 | 20.5 | 19.6 |
| | 35 + 35 + 35 + 35 | 3.13 | 3.13 | 3.13 | 3.13 | - | - | 4.4 | 12.5 | 12.8 | 1100 | 4730 | 4800 | 21.5 | 20.6 | 19.7 |
| | 35 + 35 + 35 + 50 | 2.82 | 2.82 | 2.82 | 4.03 | - | - | 4.4 | 12.5 | 12.8 | 1100 | 4720 | 4800 | 21.5 | 20.5 | 19.7 |
| | 35 + 35 + 35 + 60 | 2.65 | 2.65 | 2.65 | 4.55 | - | - | 4.4 | 12.5 | 12.8 | 1100 | 4720 | 4800 | 21.5 | 20.5 | 19.7 |
| 35 + 35 + 35 + 71 | 2.49 | 2.49 | 2.49 | 5.04 | - | - | 4.4 | 12.5 | 12.8 | 1100 | 4710 | 4800 | 21.4 | 20.5 | 19.6 | |
| 35 + 35 + 50 + 50 | 2.57 | 2.57 | 3.68 | 3.68 | - | - | 4.4 | 12.5 | 12.8 | 1100 | 4720 | 4800 | 21.5 | 20.5 | 19.7 | |
| 35 + 35 + 50 + 60 | 2.43 | 2.43 | 3.47 | 4.17 | - | - | 4.4 | 12.5 | 12.8 | 1100 | 4710 | 4800 | 21.4 | 20.5 | 19.6 | |
| 35 + 35 + 50 + 71 | 2.29 | 2.29 | 3.27 | 4.65 | - | - | 4.4 | 12.5 | 12.8 | 1100 | 4700 | 4800 | 21.4 | 20.5 | 19.6 | |
| 35 + 35 + 60 + 60 | 2.30 | 2.30 | 3.95 | 3.95 | - | - | 4.4 | 12.5 | 12.8 | 1100 | 4700 | 4800 | 21.4 | 20.5 | 19.6 | |
| 35 + 50 + 50 + 50 | 2.36 | 3.38 | 3.38 | 3.38 | - | - | 4.4 | 12.5 | 12.8 | 1100 | 4710 | 4800 | 21.4 | 20.5 | 19.6 | |
| 35 + 50 + 50 + 60 | 2.24 | 3.21 | 3.21 | 3.85 | - | - | 4.4 | 12.5 | 12.8 | 1100 | 4700 | 4800 | 21.4 | 20.5 | 19.6 | |
| 5 room | 25 + 25 + 25 + 25 + 25 | 2.50 | 2.50 | 2.50 | 2.50 | 2.50 | - | 5.1 | 12.5 | 13.3 | 1210 | 4440 | 4800 | 20.2 | 19.3 | 18.5 |
| | 25 + 25 + 25 + 25 + 35 | 2.31 | 2.31 | 2.31 | 2.31 | 3.24 | - | 5.1 | 12.5 | 13.3 | 1210 | 4430 | 4800 | 20.2 | 19.3 | 18.5 |
| | 25 + 25 + 25 + 25 + 50 | 2.08 | 2.08 | 2.08 | 2.08 | 4.17 | - | 5.1 | 12.5 | 13.3 | 1210 | 4410 | 4800 | 20.1 | 19.2 | 18.4 |
| | 25 + 25 + 25 + 25 + 60 | 1.95 | 1.95 | 1.95 | 1.95 | 4.69 | - | 5.1 | 12.5 | 13.3 | 1210 | 4410 | 4800 | 20.1 | 19.2 | 18.4 |
| | 25 + 25 + 25 + 35 + 35 | 2.16 | 2.16 | 2.16 | 3.02 | 3.02 | - | 5.1 | 12.5 | 13.3 | 1210 | 4420 | 4800 | 20.1 | 19.2 | 18.4 |
| | 25 + 25 + 25 + 35 + 50 | 1.95 | 1.95 | 1.95 | 2.73 | 3.91 | - | 5.1 | 12.5 | 13.3 | 1210 | 4410 | 4800 | 20.1 | 19.2 | 18.4 |
| | 25 + 25 + 25 + 35 + 60 | 1.84 | 1.84 | 1.84 | 2.57 | 4.41 | - | 5.1 | 12.5 | 13.3 | 1210 | 4400 | 4800 | 20.0 | 19.1 | 18.4 |
| | 25 + 25 + 25 + 35 + 71 | 1.73 | 1.73 | 1.73 | 2.42 | 4.90 | - | 5.1 | 12.5 | 13.3 | 1210 | 4390 | 4800 | 20.0 | 19.1 | 18.3 |
| | 25 + 25 + 25 + 50 + 50 | 1.79 | 1.79 | 1.79 | 3.57 | 3.57 | - | 5.1 | 12.5 | 13.3 | 1210 | 4390 | 4800 | 20.0 | 19.1 | 18.3 |
| | 25 + 25 + 25 + 50 + 60 | 1.69 | 1.69 | 1.69 | 3.38 | 4.05 | - | 5.1 | 12.5 | 13.3 | 1210 | 4390 | 4800 | 20.0 | 19.1 | 18.3 |
| | 25 + 25 + 25 + 60 + 60 | 1.60 | 1.60 | 1.60 | 3.85 | 3.85 | - | 5.1 | 12.5 | 13.3 | 1210 | 4380 | 4800 | 19.9 | 19.1 | 18.3 |
| | 25 + 25 + 35 + 35 + 35 | 2.02 | 2.02 | 2.82 | 2.82 | 2.82 | - | 5.1 | 12.5 | 13.3 | 1210 | 4410 | 4800 | 20.1 | | |

Dimensions

INDOOR UNIT

Unit: mm

Wall mounted type SRK60ZMX-S

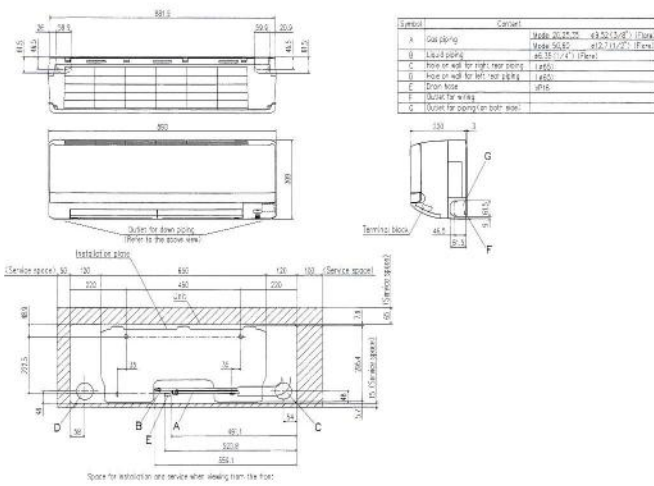

Wall mounted type SRK25ZMA-S SRK35ZMA-S SRK50ZMA-S

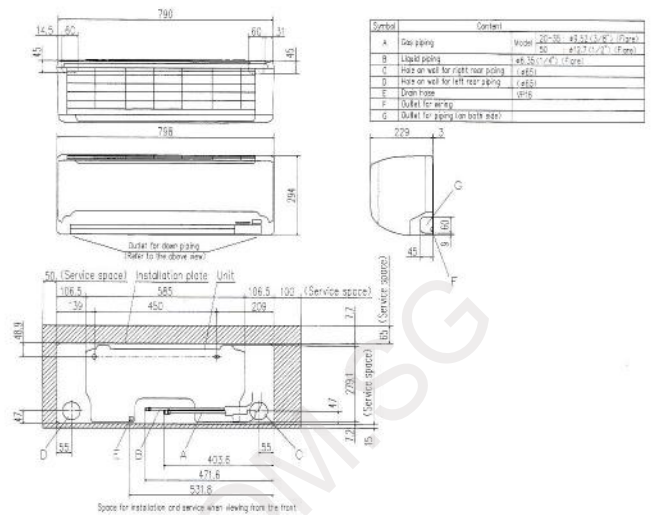

Wall mounted type SRK71ZM-S

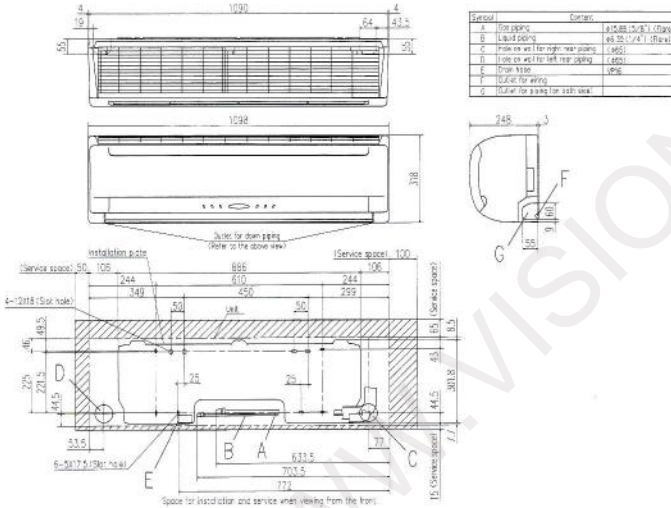

Ceiling Concealed SRR35ZJ-S SRR50ZJ-S SRR60ZJ-S

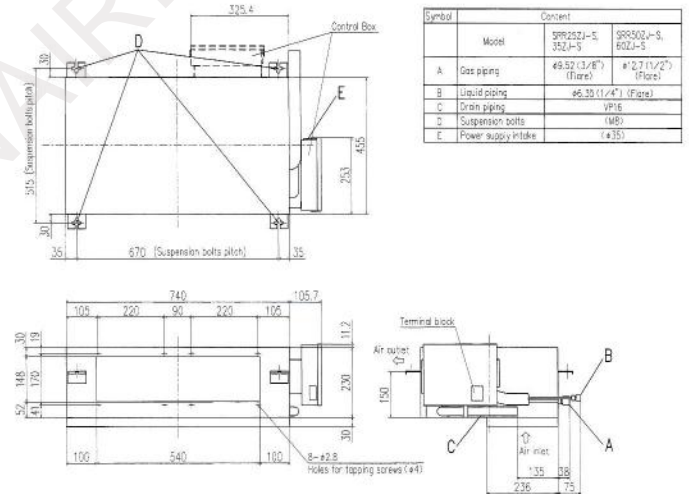

OUTDOOR UNIT

Unit: mm

SCM45ZJ-S

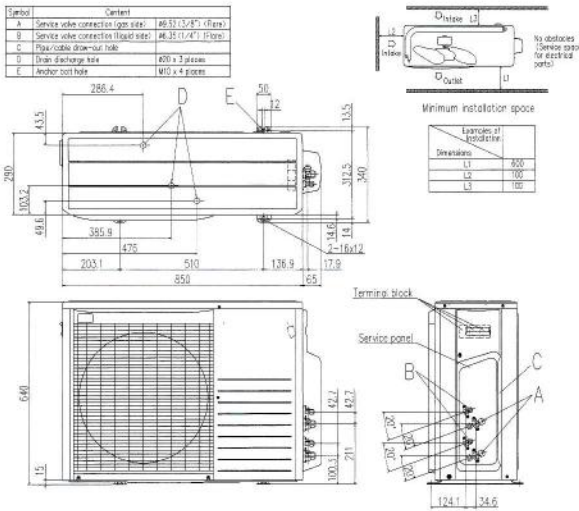

SCM80ZJ-S1

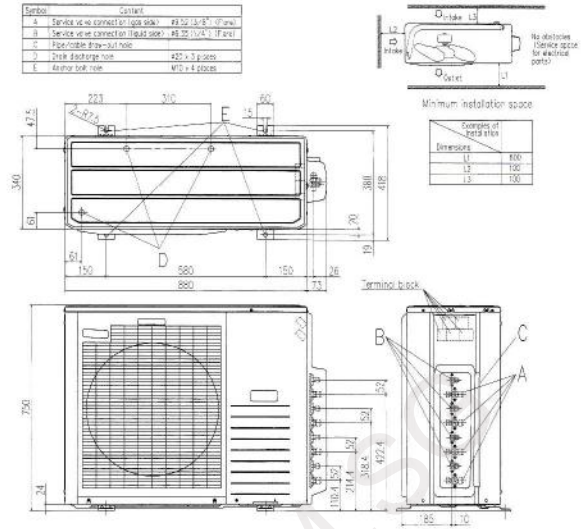

SCM60ZJ-S1

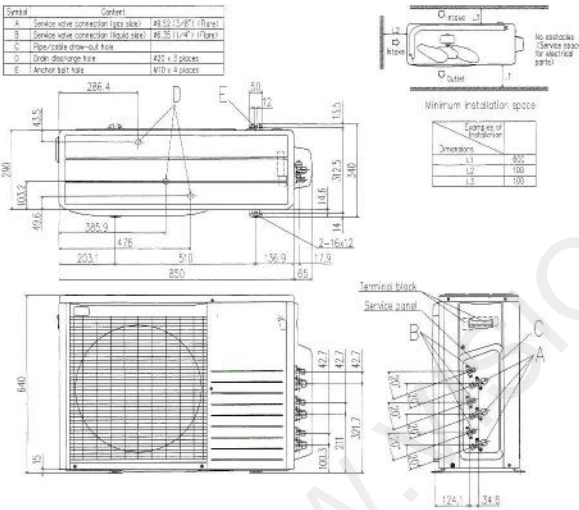

SCM100ZJ-S1

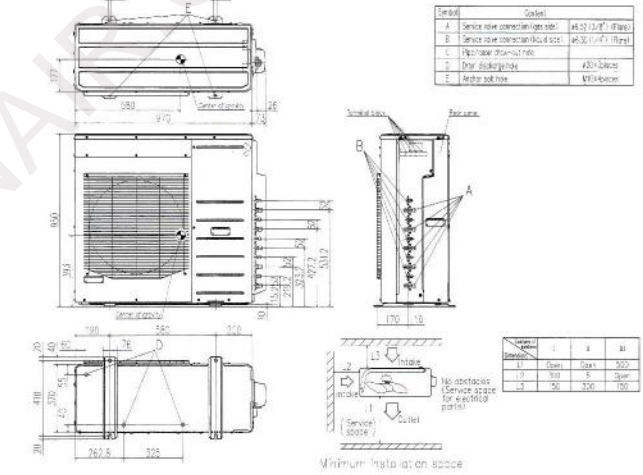

SRC71ZM-S

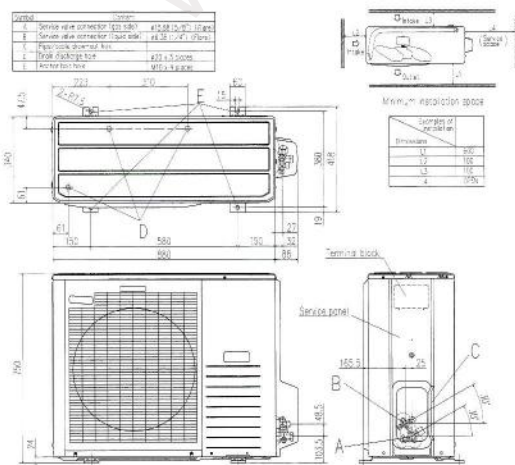

SCM125ZJ-S1

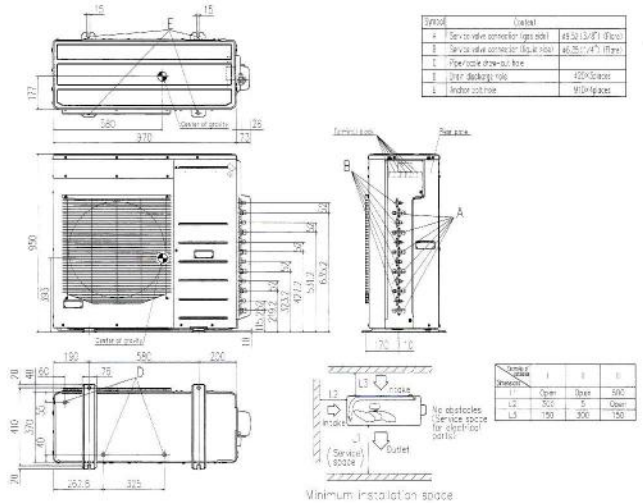

Before starting use

Heating performance

The heating performance values (kW) described in catalog are the values obtained by operating at an outdoor temperature of 7C and indoor temperature of 20C as set forth in the ISO Standards. As the heating performance decreases as the outdoor temperature drops, if the outdoor temperature is too low and the heating performance is insufficient, use other heating appliances as well.

Indication of sound values

The sound values are the values (A scale) measured in a chamber such as an anechoic chamber following the ISO Standards. In the actual installation state, the value is normally larger than the values given in the catalog due to the effect of surrounding noise and echo. Take this into consideration when installing.

Use in oil atmosphere

Avoid installing this unit in as atmosphere where oil scatters or builds up, such as in a kitchen or machine factory. If the oil adheres to the heat exchanger, the heat exchanging performance will drop, mist may be generated, and the synthetic resin parts may deform and break.

Use in acidic or alkaline atmosphere

If this unit is used in acidic atmosphere such as hot spring areas having high level of sulfuric gases or in alkaline atmosphere including ammonia or calcium chloride, places where the exhaust of the heat exchanger is sucked in, or at coastal areas where the unit is subject to salt breezes, the outer plate or heat exchanger, etc., will corrode. Please ask a dealer or specialist when you use an air conditioner in places differing from a general atmosphere.

Use in places with high ceilings

If the ceiling is high, install a circulator to improve the heat and air flow distribution when heating.

Refrigerant leakage

The refrigerant (R410A) used for the Residential Air conditioner is non-toxic and inflammable in its original state. However, in consideration of a state where the refrigerant leaks into the room, measures against refrigerant leaks must be taken in small rooms where the tolerable level could be exceeded. Take measures by installing ventilation devices, etc.

Use in snowy areas

Take the following measures when installing the outdoor unit in snowy areas.

•Snow-prevention

Install a snow-prevention hood so that the snow does not obstruct the air intake port or enter and freeze in the outdoor unit.

•Snow piling

In areas with heavy snow fall, the piled snow could block the air intake port. In this case, a frame that is 50cm or higher than the estimated snow fall must be installed underneath the outdoor unit.

Automatic defrosting device

If the temperature is low, and the humidity is high, frost will stick to the heat exchanger of the outdoor unit. If use is continued, the heating performance will drop.

The "Automatic defrosting device" will function to remove this frost. After heating for approx, three to ten minutes, it will stop, and the frost will be removed. After defrosting, hot air will be blown again.

Servicing the air-conditioner

After the air-conditioner is used for several seasons, dirt will build up in the air-conditioner causing the performance to drop. In addition to regular servicing, we recommend the maintenance contract (charged for) by a specialist.

⚠ Safety Precautions

Air-conditioner usage target

The air-conditioner described in this catalog is a dedicated cooling/heating device for human use.

Do not use it for special applications such as the storage of foodstuffs, animals or plants, precision devices or valuable art, etc.

This could cause the quality of the items to drop, etc.

Do not use this for cooling vehicles or ships. Water leakage or current leaks could occur.

Before use

Always read the "User's Manual" thoroughly before starting use.

Installation

Always commission the installation to a dealer or specialist. Improper installation will lead to water leakage, electric shocks and fires.

Make sure that the outdoor unit is stable in installation. Fix the unit to stable base.

Usage place

Do not install in places where combustible gas could leak or where there are sparks.

Installation in a place where combustible gas could be generated, flow or accumulate, or places containing carbon fibers could lead to fires.



Our factories are ISO9001 and ISO14001 certified.

Certified ISO 9001



BIWAJIMA PLANT
Mitsubishi Heavy Industries, Ltd.
Air-conditioning & Refrigeration Systems Headquarters
Certificate ISO 9001
Certificate number: JGA-239



MITSUBISHI HEAVY INDUSTRIES-
MAHAJAK AIR CONDITIONERS CO., LTD.
Certificate ISO 9001
Certificate number: 0410/199/013

Certified ISO 14001



BIWAJIMA PLANT
Mitsubishi Heavy Industries, Ltd.
Air-conditioning & Refrigeration Systems Headquarters
Certificate ISO 14001
Certificate number: JGA-EM226



MITSUBISHI HEAVY INDUSTRIES-
MAHAJAK AIR CONDITIONERS CO., LTD.
Certificate number: 04104/199/013 ES



Exclusive Distributor

Wo Kee Hong Marketing Pte Ltd
(Member of KM Capital Pte Ltd)

No.1 Jalan Kilang Timor #08-03 Pacific Tech Centre Singapore 159303

Tel: (65) 6376 0338 Fax: (65) 6376 0166

Email: pacwkhs@wokeehong.com.sg Website: www.wokeehong.com.sg

Dealer:

