

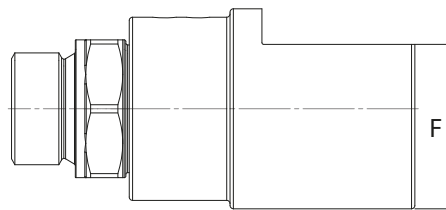

Rotary Swivel Joint - HP-SJ9005

Swivel joint which is mounted between a hose assembly and a rigid component in order to allow for occasional rotations to prevent any hose damage.

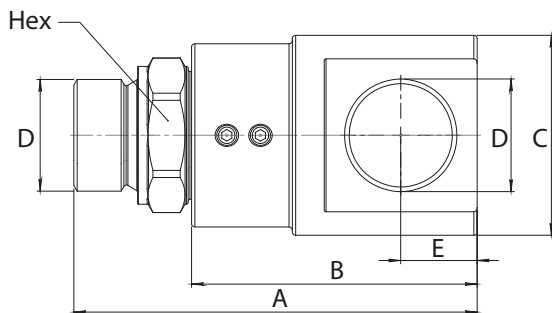
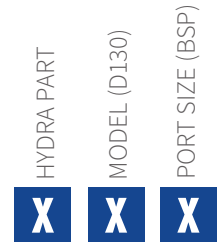
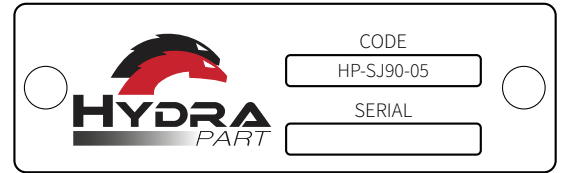

Size	A	B	C Ø	D BSP	E	F	Hex	Weight kg
01	72,5	50	34	1/4	11,5	30,5	19	0,31
02	79	55	37,5	3/8	14	33	24	0,45
03	94	65	39,5	1/2	16	33	27	0,60
04	104	74	49,5	3/4	17,8	43,5	41	1,10
05	120	85	59,5	1	23	50	41	1,50
06	116	83	-	1 1/4	32	-	50	1,85
07	136	100	-	1 1/2	38	-	55	3,10
09	143	110	-	2	43	-	65	4,50

Hydraulic Symbol

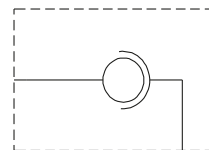

Curves

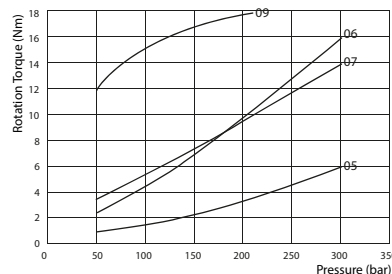
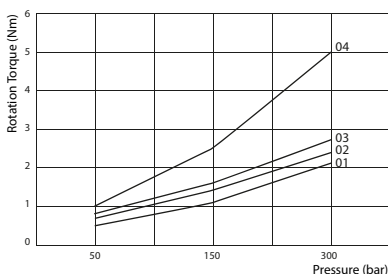

Features

Size	01	02	03	04	05	06	07	09
Max Flow Rate (lpm)	25	45	80	120	150	200	250	300
Max Static Pressure (bar)	400	400	360	310	280	250	210	180

Materials: Zinc plated steel.