

TECHNICAL DATA SHEETS
and
RECOMMENDATIONS

ABER

Manufacturing Hydraulic Excellence since 1972

www.ABER.pt



CONSTANT DRIVE 10 BOLT MOUNT POWER TAKE OFF RECOMMENDATIONS BEFORE START-UP



Torque Table			
Size (mm - inch)	M8 3/8"	M10 7/16"	M12 1/2"
Screws and nuts Torque	25 N.m 18 lbf.ft	60 N.m 45 lbf.ft	80 N.m 59 lbf.ft
Studs Torque	10 N.m 7 lbf.ft	20 N.m 15 lbf.ft	30 N.m 22 lbf.ft

Installation of a constant drive 10 bolt mount PTO

1 - Drain the oil from the gearbox, remove hatch cover and the respective gasket and verify if PTO and transmission gears are compatible;

Manufacturer's Declaration

ABER ensures compliance of its products with the essential health and safety requirements of the Directive 2006/42/EC and harmonized standard EN ISO 12100:2010.

General information

The Power Take Offs are mechanical devices that transmit mechanical power. They are usually applied to transmissions from where the power is taken to be transmitted to the hydraulic pumps, intermediate shafts, etc. Normally applied in dumpers, cranes, cleaning systems, moving floors, compressors, etc. This device stands out do to the fact of almost non-existence noise and its high efficiency.

Safety information



- Do not attempt to work or install a Power Take-Off with the engine running.
- A PTO must be properly matched to the vehicle transmission and to the auxiliary equipment. An incorrect matched could cause several damage to the vehicle transmission and the auxiliary equipment.

ATTENTION

- Do not exceed the limits of power and torque in the technical sheet.
- The decisions of install guards in the PTO warning shall be the responsibility of the designers or installers.

Maintenance

Monthly	Annually
<ul style="list-style-type: none"> -Check the transmission oil level. We advise seeing the vehicle manufacturer recommendations. -Check for PTO leaks under and around the vehicle. Any leaks found should be stopped immediately -Check the tightness of the fixation studs and if necessary tighten more. Consult torque table to tight studs correctly. 	<ul style="list-style-type: none"> -Check the transmission oil level. We advise seeing the vehicle manufacturer recommendations. -Check for PTO leaks under and around the vehicle. Any leaks found should be stopped immediately -Check the tightness of the fixation studs and if necessary tighten more. Consult torque table to tight studs correctly. -Visual inspection of all the components and if necessary proceed with the repair.



2 - Clean the lip of the hatch with a wire brush or spatula, being careful not to let any foreign bodies into the transmission;

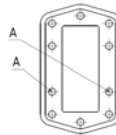

3 - In the PTO mounting Kit find the two alignment studs. Fit the studs in the respective holes (A) accord to the schematic image.

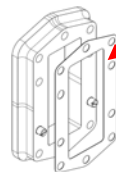

4 - Fit one or more gaskets as needed, between the inspection hatch and the PTO body. Ensure that the teeth of the gears in the transmission and those in the PTO are properly meshed.

ATTENTION

Do not use more than three gaskets.

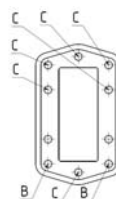

5 - Fit the screws, and washers according to the schematic image. The 25 mm screws and washers are fitted in the (B) holes and the 30mm screws and washers are fitted in the (C) holes. Consult torque table to tighten screws correctly.

6 - Attach the 90° elbow fitting provided in the kit to the PTO threaded hole (T)

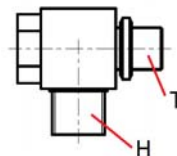
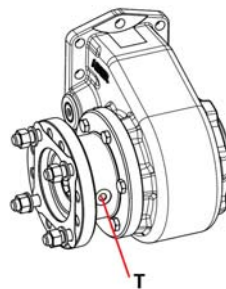



CONSTANT DRIVE 10 BOLT MOUNT POWER TAKE OFF RECOMMENDATIONS BEFORE START-UP

7 - Attach the 90° elbow fitting provided in the kit to the threaded hole (P) on the transmission.

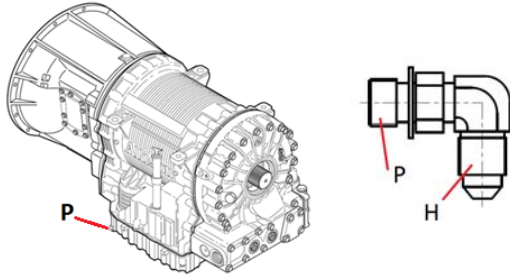

8 - Attach the hydraulic hose to the fittings (H). Check oil level and signs of oil leakage.

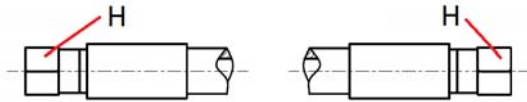

Faults, causes and remedies

Faults	Causes	Remedies
Noise	<ol style="list-style-type: none"> 1. Assembly clearance 2. Broken teeth 3. Damaged roller-bearings 	<ol style="list-style-type: none"> 1. Check/adjust the looseness between the teeth and the thickness of the gaskets 2-3. Repair or replace
Over-heating	<ol style="list-style-type: none"> 1. Lack of lubrication 2. Too tight between the wheel of the PTO and the wheel of the transmission 	<ol style="list-style-type: none"> 1. Refill the oil level 2. Adjust the gap between teeth with the thickness of the gaskets
Leaks	<ol style="list-style-type: none"> 1. Loose fixation nuts and studs 2. Damaged gasket 	<ol style="list-style-type: none"> 1. Tight according to recommendations 2. Replace gasket for another with the same thickness
No transmission of movement	<ol style="list-style-type: none"> 1. PTO blockage 	<ol style="list-style-type: none"> 1. Repair or replace control



- A PTO should be mounted by qualified personnel. The correct mounting of the PTO is influenced by the ability of the operator.
- Always read carefully all owner's manuals, or other instructions before installation of PTO and driven equipment.
- In case of difficulties please ask our service department for advice.
- To install a PTO, the vehicle must be parked on a flat surface with the engine off and parking brake applied.
- Use appropriated tools and safety equipment.
- Ensure that the system cannot boot involuntarily.
- Ensure that the levels and quality of the oil are as recommended, that there are no leaks and that everything is properly tightened before starting.
- When the PTO is working, never touch or pull hoses or intermediate shaft when applied. When intermediate shaft is applied take into account that parts can be ejected.
- The application of the ABER's PTO must follow all the instructions hereby mentioned in order to assure the safety of all personal working with the equipment including its surroundings, assure a long life to the product and preserve the warranty of the brand. All applications that do not follow the hereby instruction are solely the users responsibility. If there should happen any malfunctioning, it is strictly forbidden the disassembly of the product except if it is being made by a qualified technician of the brand or if there is a special authorization to do that. If this specification should not be followed, all warranties might be lost.

ABER is constantly engaged in improving its products and, therefore, reserves itself the right to modify without any further notice the characteristics shown



ABER - Embraiagens e Comandos Hidráulicos - A. B. LDA

Rua Francisco de Almeida, Nº 30 – Vila Nova da Telha – 4470 MAIA - Portugal

Telephone: +351.22.9438070 Fax: +351.22.9420823 e-mail: aber@aber.pt <http://www.aber.pt>



POWER TAKE OFF RECOMMENDATIONS BEFORE START-UP



Manufacturer's Declaration

ABER ensures compliance of its products with the essential health and safety requirements of the Directive 2006/42/EC and harmonized standard EN ISO 12100:2010.

General information

The Power Take Offs are mechanical devices that transmit mechanical power. They are usually applied to gearboxes from where the power is taken to be transmitted to the hydraulic pumps, intermediate shafts, etc. Normally applied in dumpers, cranes, cleaning systems, moving floors, compressors, power generators, etc. This device stands out do to the fact of almost non-existence noise and its high efficiency.

How to use

The following procedure is not valid for automatic gearboxes. The procedure to operate the PTO should always be made with the vehicle parked, parking brake actuated, engine running and in neutral.

- 1.press the clutch for 5/10 seconds;
- 2.turn on PTO control (pneumatic, vacuum, electric or mechanic);
- 3.release the clutch slowly;

To disconnect the PTO:

- 1.press the clutch for 5/10 seconds;
- 2.turn off PTO control;
- 3.release the clutch;

ATTENTION

PTO must be turned off, before the vehicle starts moving again. Do not exceed the limits of power and torque in the technical sheet. The incorrect engagement and disengagement, may cause premature equipment damage.

Maintenance

Daily	Monthly	Annually
-Check the tightness of the pneumatic system and the light switches.	-Check the tightness of the pneumatic system and the light switches. -Check the oil level and refill if necessary. We advise seeing the gearbox manufacturer recommendations. -Check the tightness of the fixation studs and if necessary tighten more. Consult torque table to tight studs correctly. -Visual inspection of all the components and if necessary proceed with the repair.	-Check the tightness of the pneumatic system and the light switches -Check the oil level and refill if necessary. We advise seeing the gearbox manufacturer recommendations. -Check the tightness of the fixation studs and if necessary tighten more. Consult torque table to tight studs correctly. -Visual inspection of all the components and if necessary proceed with the repair. -Clean the gearbox and if necessary proceed with the repair.

General information to mount a PTO

-The general instructions contained in this document do not replace specific information of any component involved in the assembly.

-To install the PTO, the vehicle must be parked on a flat surface with the engine off and parking brake applied.

-Use only the components supplied with PTO.

-Before final tightening, we recommend that you tighten the lock-nuts to the minimum torque and operate the PTO for 10/15 seconds. This allows the gears in the gearbox to self-align and also to check for any excessive noise.

-Before re-filling the gear-box with oil it is advisable to check the noise level of the PTO. If the PTO produces a hissing noise, this means that there is insufficient backlash in which case another gasket must be added. If the Power Take-off rattles, this indicates that there is too much backlash and the number of gaskets must be reduced. Once the gearbox has been re-filled with oil, make sure there are no leaks. Make sure that the power required from the unit is effectively obtainable from the gearbox. If the Power Take-off becomes noisy after the additional assembly of a universal joint, make sure that the joint is not damaged nor the are the edges of the gearbox and PTO.

Torque Table

Size (mm - inch)	M8 3/8"	M10 7/16"	M12
Screws and nuts Torque (Nm)	25	50	80
Studs Torque (Nm)	10	20	30

Installation of a side mount PTO

1 - Drain the oil from the gearbox, remove hatch cover and the respective gasket and verify if PTO and gearbox gears are compatible;

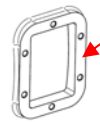

2 - Clean the lip of the hatch with a wire brush or spatula, being careful not to let any foreign bodies into the gearbox;

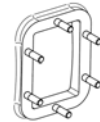

3 - If the PTO uses studs, fit them on the gearbox. Consult torque table to tighten studs correctly. In the case of through-threading, make sure that the studs do not interfere with the gears inside the gearbox. Apply a sealing glue to the thread of the studs;

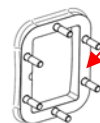

4 - Fit one or more gaskets as needed, between the inspection hatch and the PTO body. Ensure that between the teeth of the gears in the gearbox and those in the PTO there is a backlash of 0,15/0,3 mm.

ATTENTION

Do not use more than three gaskets.

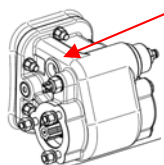

5 - Fit the PTO to the gearbox. On the PTO body there is a plug, if unscrewed, it's large enough to allow manual checking of backlash between the PTO and the gears of the gearbox. The upper wheel of the PTO should move manually and not be too loose, that is, not hitting anything.



This should be checked with the engine off and the truck blocked with the parking brake.



POWER TAKE OFF RECOMMENDATIONS BEFORE START-UP

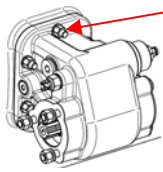

6 - Fit the PTO tightly onto the gearbox. Consult torque table to tighten studs correctly. This operation is more secure when using a dynamometric spanner. Check the oil quality and level recommended by the manufacturer of the vehicle and refill the oil of the gearbox.

7 - Place fittings and accessories for control.

Installation of a rear mount PTO

1-Drain the oil from the gearbox (in some gearboxes this step is no needed because the oil level does not reach the rear door), find the rear open and remove its cover and the respective gasket.

2-Clean the surface of the hatch with a wire brush or spatula, being careful not to let any foreign bodies in the gearbox;

3-If the PTO uses studs, fit them on the gearbox. Consult torque table to tighten studs correctly. In the case of through-threading, make sure that the studs do not interfere with the gears inside the gearbox. Apply a sealing glue to the thread of the studs;

4-Fit one gasket between the inspection hatch and the PTO body.

5- Install the PTO on the gearbox (install pump in PTO when studs are used to fix both components) and tighten the screws using the tightening torque indicated in the torque table.

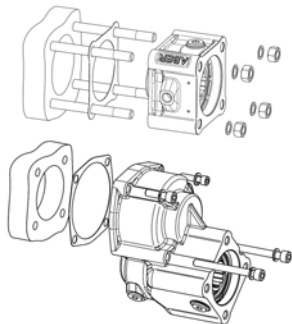

6-Check the oil and the level given by the manufacturer of the vehicle and refill the oil of the gearbox taking into account the presence of the PTO.

7-Place the fitting and the air pipe.

ATTENTION

For multi axis PTO it is recommend that you assemble the PTO according to the positions indicated in the

following diagram, which ensure a good lubrication of the internal components.



- A PTO should be mounted by qualified personnel. The correct mounting of the PTO is influenced by the ability of the operator.
- In case of difficulties please ask our service department for advice.
- To install a PTO, the vehicle must be parked on a flat surface with the engine off and parking brake applied.
- Use appropriated tools.
- Ensure that the system cannot boot involuntarily.
- Ensure that the levels and quality of the oil are as recommended, that there are no leaks and that everything is properly tightened before starting.
- When the PTO is working, never touch or pull hoses or intermediate shaft when applied. When intermediate shaft is applied take into account that parts can be ejected.

-The application of the ABER's PTO must follow all the instructions hereby mentioned in order to assure the safety of all personal working with the equipment including its surroundings, assure a long life to the product and preserve the warranty of the brand. All applications that do not follow the hereby instruction are solely the users responsibility. If there should happen any malfunctioning, it is strictly forbidden the disassembly of the product except if it is being made by a qualified technician of the brand or if there is a special authorization to do that. If this specification should not be followed, all warranties might be lost.

Vertical assembly
Low outlet

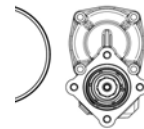

Horizontal assembly



Use lubrication kit

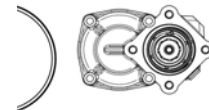

Vertical assembly
High outlet



Use lubrication kit

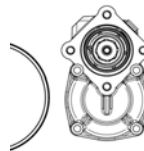

Faults, causes and remedies

Faults	Causes	Remedies
Noise	<ol style="list-style-type: none"> 1.Vehicles clutch is not working properly 2. Assembly clearance 3.Broken teeth 4.Damaged roller-bearings 	<ol style="list-style-type: none"> 1.Fully press the clutch or wait more time for the gearbox gearing to stop 2. Check/adjust the looseness between the teeth and the thickness of the gaskets 3-4.Repair or replace
Over-heating	<ol style="list-style-type: none"> 1-2.Lack of lubrication 3.Too tight between the wheel of the PTO and the wheel of the gearbox 	<ol style="list-style-type: none"> 1.Refill the oil level 2.Use a PTO with a lubrication hose connected directly to the gearbox 3.Adjust the gap between teeth with the thickness of the gaskets
Leaks	<ol style="list-style-type: none"> 1.Loose fixation nuts and studs 2.Damaged gasket 	<ol style="list-style-type: none"> 1.Tight according to recommendations 2.Replace gasket for another with the same thickness
PTO doesn't engage	<ol style="list-style-type: none"> 1.Obstructed air hose 2.Low air pressure 3.Control failure 	<ol style="list-style-type: none"> 1.Clean or replace hose 2.Check for leak source and fix it 3.Repair or replace control
PTO doesn't disengage	<ol style="list-style-type: none"> 1. Internal PTO problem 	<ol style="list-style-type: none"> 1.Repair or replace control
No transmission of movement	<ol style="list-style-type: none"> 1.PTO blockage 	<ol style="list-style-type: none"> 1.Repair or replace control





Power Take Offs		Ref. TF14003P
RENAULT	B9.150 ; B18.150	

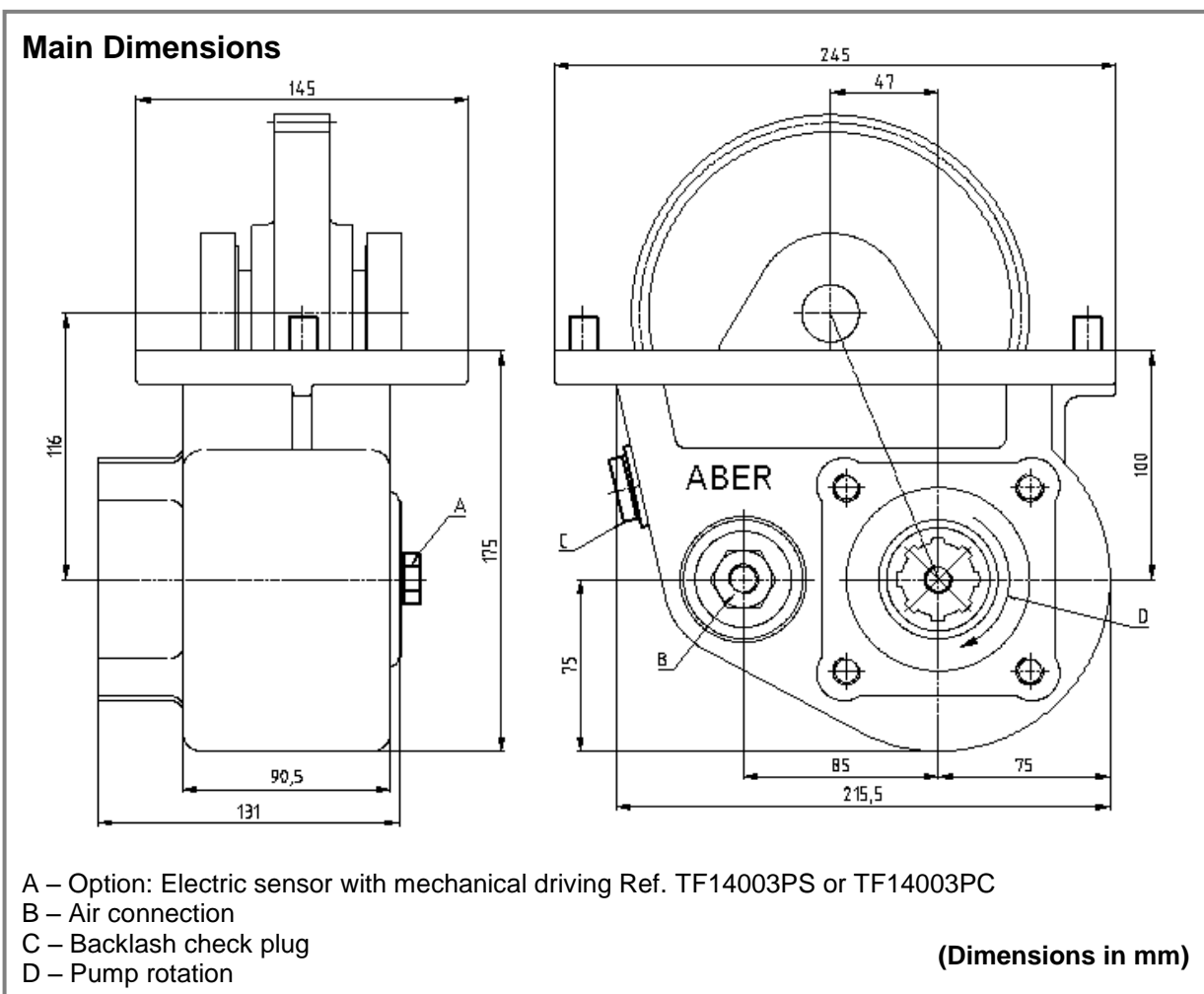

Main Data	
Continuous Torque (Nm)	380
Intermittent Torque (Nm)	530
Power (at 1000 rpm)	53 cv / 39 kW
Mounting Position	Right
Pump Rotation	Left Hand
Weight (kg)	19
PTO internal ratio	1:1,56
Indicative ratio from motor to PTO's output	
B9.150	.- 1 : 1.26
B18 Normal	.- 1 : 1.26
B18 High	.- 1 : 1.46

CTI TF14003P 1211-2

ABER is constantly engaged in improving its products and, therefore, reserves itself the right to modify without any further notice the characteristics shown. The gear boxes are in constant change; therefore, ABER is not to be held responsible for any damage resulting from wrong application or application of outdated material.



ABER - Embragens e Comandos Hidráulicos - A. B. LDA
 Rua Francisco de Almeida, Nº 30 – Vila Nova da Telha – 4470 MAIA - Portugal
 Telephone: +351.22.9438070 Fax: +351.22.9420823 e-mail: aber@aber.pt <http://www.aber.pt>