

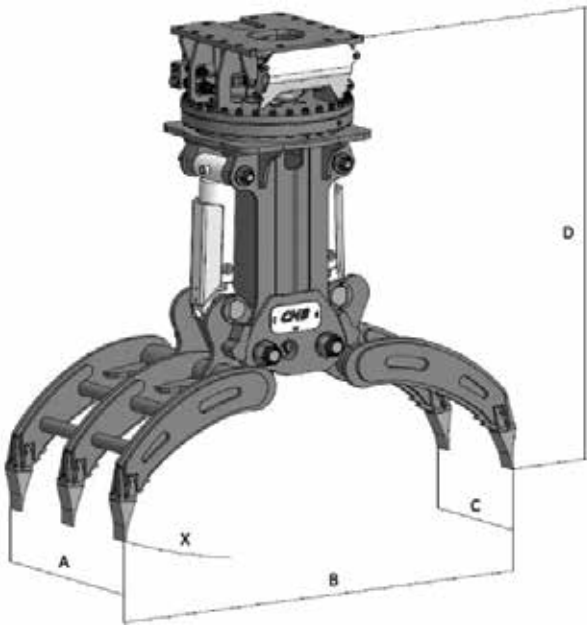







## MR Series Handling Grapple



		MR 200	MR 400	MR 700	MR 1200	MR 1500	MR 2500
	Kg	220	450	780	1550	2000	3650
	ton	2 - 5	5 - 10	9 - 13	18 - 22	23 - 40	40 - 60
A	mm	350	620	660	700	865	1105
B	mm	880	1200	1625	1950	2530	3000
C	mm	200	355	430	450	565	690
D	mm	1130	1380	1600	2160	2240	2550
X	ton	2	3,5	4,5	6	10	15
	bar	200	200	200	320	320	320
	l/min	30	40	40	70	90	140
	bar	100	100	120	140	140	140
	l/min	10 / 20	10 / 20	10 / 20	20 / 30	20 / 30	30 / 40
	model.	GR5S	GR7	GR15	GR20	GR30	GR50