

# INTERMERCATO <sup>↑</sup> Forest residue grabs

HIGH PERFORMANCE LIFT & LOAD ATTACHMENTS

## TG SR

**Forest residue grab, ideal for feeding chippers**  
 Available with 3, 4 and 5 claws and is used for all sorts of wood waste. The larger models are so robust, they're suitable for rigid mounting on excavator.



# DEFINITELY A BEAST.

### KEY FEATURES





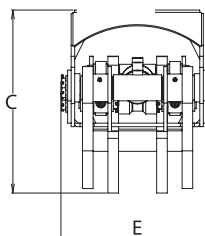
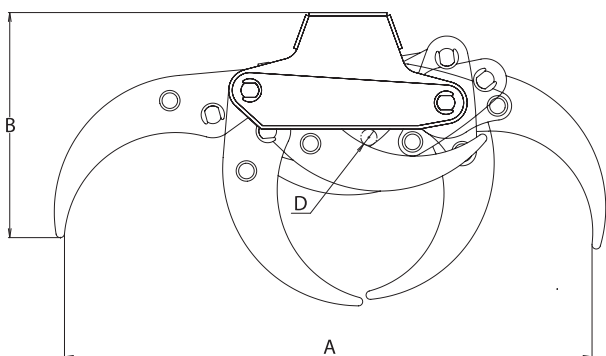





- Made of Hardox®
- Extra reinforced body for rigid mounting
- TG 28 SR and up + the entire PRO-series have homogeneous guide bars made of Hardox®
- Optimal roll in- roll out properties
- Cylinder with double piston rod seals for high pressure

[www.intermercato.com](http://www.intermercato.com)



	TG 16 SR4-50	TG 16 SR4	TG 16 SR5	TG 16 PROSR4	TG 16 PROSR5
<b>A</b>	952	950	933	950	950
<b>B</b>	550	550	590	482	482
<b>C</b>	420	417	400	355	355
<b>D</b>	60	60	60	47	47
<b>E</b>	301	301	287	344	344

	TG 22 PROSR4	TG 22 PROSR5	TG 25 SR3	TG 25 SR4-W	TG 25 PROSR4	TG 25 PROSR5	TG 28 SR3	TG 28 SR4	TG 28 SR5	TG 35 SR4	TG 35 SR5	TG 42 SR4	TG 42 SR5	TG 55 SR4	TG 55 SR5
<b>A</b>	1225	1225	1203	1460	1370	1370	1500	1500	1500	1890	1890	1895	1895	2425	2425
<b>B</b>	585	585	637	705	675	675	730	735	735	763	763	912	912	967	967
<b>C</b>	440	440	516	510	495	495	582	565	565	594	594	677	677	796	796
<b>D</b>	60	60	45	45	72	72	100	95	95	65	65	100	100	150	150
<b>E</b>	432	432	432	391	478	478	508	508	508	522	522	533	533	635	635

MODEL SPECS.											
TG 16 SR4-50	67	0,16	200	40	16,7	1	3	5	1-3	-	-
TG 16 SR4	68	0,16	200	40	16,7	1	3	5	1-3	-	-
TG 16 SR5	75	0,16	200	40	16,7	1	3	5	1-3	-	-
TG 16 PRO SR4	78	0,16	200	40	7,25	2	4	7	1-6	1-4	Ja
TG 16 PRO SR5	81	0,16	200	40	7,25	2	4	7	1-6	1-4	Ja
TG 22 PRO SR4	150	0,20	200	50	11,6	3	5	10	4-10	4-6	Ja
TG 22 PRO SR5	156	0,20	200	50	11,6	3	5	10	4-10	4-6	Ja
TG 25 SR3	213	0,20	250	50	12,6	3	8	15	6-12	6-8	-
TG 25 SR4-W	230	0,25	250	50	12,6	3	8	15	6-12	6-8	-
TG 25 PRO SR4	217	0,22	250	50	14,5	4	10	15	6-12	6-10	Ja
TG 25 PRO SR5	230	0,22	250	50	14,5	4	10	15	6-12	6-10	Ja
TG 28 SR3	300	0,30	250	60	16,6	5	12	30	8-16	8-12	Ja
TG 28 SR4	295	0,30	250	60	16,6	5	12	30	8-16	8-12	Ja
TG 28 SR5	306	0,30	250	60	16,6	5	12	30	8-16	8-12	Ja
TG 35 SR4	380	0,38	250	60	17,2	7	15	35	10-20	10-14	Ja
TG 35 SR5	393	0,38	250	60	17,2	7	15	35	10-20	10-14	Ja
TG 42 SR4	458	0,50	250	70	21,8	8	20	40	12-22	12-16	Ja
TG 42 SR5	480	0,50	250	70	21,8	8	20	40	12-22	12-16	Ja
TG 55 SR4	873	0,65	250	90	24,2	10	30	-	14-25	14-18	-
TG 55 SR5	910	0,65	250	90	24,2	10	30	-	14-25	14-18	-

Recommended machine weight and crane size

## Accessorize your grab

### Crane scale

Intermercato is world leading in weighing of hanging load. Our crane scales are based on intelligent technology - an advanced algorithm calculates the weight. It's the only RTT&E certified and legal for trade system in the world for hanging load in motion.

### Rotator and excavator attachment

Accessorize your grab with an excavator attachment! We have suitable attachments for all types of excavators. We can also deliver all our grabs and clamshell buckets complete with hose kit!

