

DOC 400

For tractors 100-130 hp

REAR HEDGE MOWERS



Hydraulic hedge mower of 5,5/6.5 m. range, for tractors HP 100/130 and weight 4500/5000 kg, suitable for all working and roads, strong, compact, connected on the tractor in high position and fast on the motions.

DOC 400
DOC 400 S
DOC 400 P
DOC 400 PS
DOC 400 A
DOC 400 AS

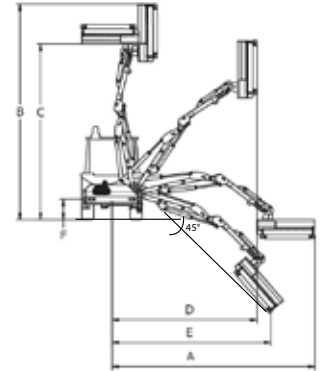

DOC 400	A/P	S/PS/AS
A (mm)	5.500	6.500
B (mm)	5.700	6.700
C (mm)	4.600	5.600
D (mm)	4.500	5.500
E (mm)	3.700	4.700
F (mm)	550	550

ARM MOWER

TRACTOR

Model	Extension E (mm)	Telescopic	Weight (kg)	Oil tank (L)	Head (model)	Pump (l/min)	Hydraulic Motor (HP [kW])	Power (HP [kW])	Weight (kg)	Width (m)	PTO (rpm)
DOC 400	5.500	0	1.100	260	30.5	100+20	55 (41)	100 / 130 (73 / 97)	4.500	2,4	540
DOC 400 P	5.500	0	1.150	260	30.5	100+20	55 (41)	100 / 130 (73 / 97)	4.500	2,4	540
DOC 400 A	5.500	0	1.200	260	30.5	100+20	55 (41)	100 / 130 (73 / 97)	4.500	2,4	540
DOC 400 S	6.500	1	1.300	260	30.5	100+20	55 (41)	100 / 130 (73 / 97)	5.000	2,4	540
DOC 400 PS	6.500	1	1.350	260	30.5	100+20	55 (41)	100 / 130 (73 / 97)	5.000	2,4	540
DOC 400 AS	6.500	1	1.400	260	30.5	100+20	55 (41)	100 / 130 (73 / 97)	5.000	2,4	540



P: Mechanism that allows to work flush to the wheel with long extension machines, with a very-good speed and handling quickness.



A: Machine with central advancement to the tractor, for a great visibility during work.







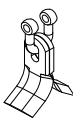

S: With telescopic arm/s.

TECHNICAL FEATURES AND STANDARD EQUIPMENT

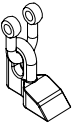
- Frame in structural steel ST 52
- Highly resistant steel DOMEX700 for 1st, 2nd arm and telescopic extension terminal with hexagonal section
- Telescopic extension terminal on guide slides on ERTALON anti-wear material
- 90° rotating column and shock resistant hydraulic safety device
- Three points attachment 2nd and 3th category
- Oil tank 260 l
- Double gear pump group 3+2 - 100+20 l/min
- Bidirectional hydraulic motor HP 55 power
- Distributor with remote controls with mm 3000 flexible cables
- Self-levelling floating system
- Feeler roller recordable on 3 positions
- Head rotating angle 200°
- Helicoidal rotor with jointed cut blade KC4
- Number revs to rotor 3000 rpm
- Fixing tie-rods
- Cardan joint
- Air-oil heat exchanger with radiating mass at high thermal exchange
- Rear underrun protection with lights
- Flail head mm 1300 MODEL 30.5 TTD 130 with direct transmission

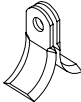
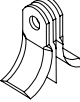

<p>KC4 Ø max 2 cm</p> <p>standard equipment</p>		<p>KC5 Ø max 2 cm</p> 	<p>HC2 Ø max 4 cm</p> 	<p>HF4 Ø max 6 cm</p> 
<p>KF4 Ø max 4 cm</p>		<p>KF5 Ø max 4 cm</p> 	<p>KF6 Ø max 3 cm</p> 	<p>HF5 Ø max 6 cm</p> 

ACCESSORIES ON REQUEST

- Nitrogen accumulator for 1st arm suspension
- Rear flail head hitch
- Ventilator (tractor quick couplings)
- Trestle bracing
- Belt transmission "TTC"
- Closed circuit pistons Motor and Pump 70 hp *
- Hydraulic flail head hood
- Gear pump and motor Parker - 80 hp *
- Power-assisted with joystick
- Biaxial prop. distributor with joystick SAUER DANFOSS
- Additional auxiliary line 3/8"
- Tie rods adapter Cat. 2 o 3

* with TTC

TERMINAL TOOLS - IN REPLACEMENT OF THE STANDARD MULCHER

BRANCH CUTTING BAR	DISC BRANCH CUTTER	FOREST DISCS CUTTING BAR	DITCH CLEANER
BTZ5 15	DFG12	BD3	PF80
BTZ5 18	DFG15	BD4	
BTZ10 16	DFG18	BD6	
BTZ10 19			
BTZ10 22			



pag. 27



pag. 28



pag. 29



pag. 30