

# PIONEER SL SERIES FINISHES AND FUNCTIONS



| FINISHES AVAILABLE |         |  |
|--------------------|---------|--|
| BHMA SYMBOL        | US CODE | DESCRIPTION                            |
| 605                | US3     | Polished Brass                         |
| 606                | US4     | Satin Brass                            |
| 609                | US5     | Antique Brass                          |
| 612                | US10    | Satin Bronze                           |
| 613                | US10BE  | Dark Oxidized Satin Bronze, Equivalent |
| 619                | US15    | Satin Nickel                           |
| 625                | US26    | Polished Chrome                        |
| 626                | US26D   | Satin Chrome                           |

Refer to price list for stock finishes and functions

## DOOR PREPARATION

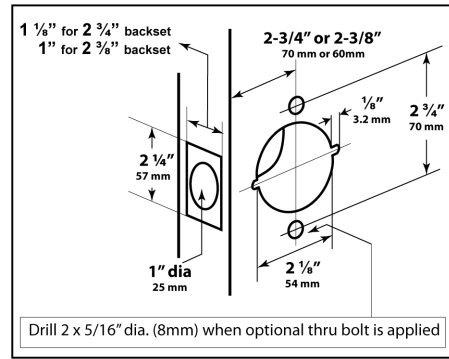

**LIFETIME WARRANTY**

**BHMA CERTIFIED**  
Be Safe. Be Secure. Look for the Mark.

**UL US**  
3 HOUR FIRE RATED  
UL10C, UBC7-2-1997

**SL00**  
**ICSL00**  
**CSL00**  
ANSI: F109

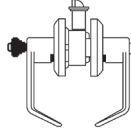

**ENTRANCE / OFFICE LOCK**  
Turn / Push button locking. Pushing and turning button locks outside lever requiring use of key until button is manually unlocked. Pushing button locks outside lever until unlocked with key or inside lever is turned.

**SL101**  
**ICSL101**  
**CSL101**  
ANSI: F90

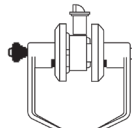

**DORMITORY / ASSISTED LIVING**  
Deadlocking latch bolt operated by lever from either side except when outside lever is locked by key or by push button on inside lever. Key in outside lever locks or unlocks outside lever. Outside key releases push button when locked from inside. Rotating inside lever or closing the door releases push button.

**SL00/T220**

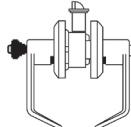

**COMBINATION ENTRANCE / OFFICE LOCK AND SINGLE CYLINDER DEADBOLT -- KA / 2 PACKED TOGETHER**  
Turn / Push button locking. Pushing and turning button locks outside lever requiring use of key until button is manually unlocked. Pushing button locks outside lever until unlocked with key or inside lever is turned. Dead locking latch bolt retracted by key from outside or by thumb turn on inside. Adjustable 2 3/8" or 2 3/4" backset.

**SL10**  
**CSL10**  
ANSI: F77

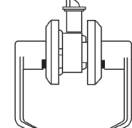

**PATIO**  
Deadlocking latch bolt operated by lever from either side. Outside lever is locked by push button inside and unlocked by rotating inside lever or closing door.

**SL01**  
**ICSL01**  
**CSL01**  
ANSI: F82

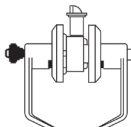

**ENTRANCE LOCK PUSH BUTTON**  
Pushing button in inside lever locks outside lever. Turning inside lever or operating key in outside lever releases button automatically. Closing door does not release button. Button cannot be fixed in lock position. Inside lever always free. Latch bolt automatically deadlocks when door is closed.

**SL20**  
**CSL20**  
ANSI: F76

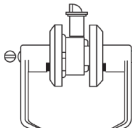

**PRIVACY LOCK**  
Latch bolt operated by lever from either side. Outside lever is locked by push button inside and unlocked by emergency release outside. Turning inside lever or closing door releases push button.

**SL03**  
**ICSL03**  
**CSL03**  
ANSI: F84

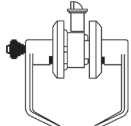

**CLASSROOM LOCK**  
Dead locking latch bolt operated by lever from either side except when outside lever is locked from outside by key. When outside lever is locked, latch bolt is operated by turning inside lever.

**SL30**  
ANSI: F75

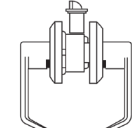

**PASSAGE SET**  
Latch bolt operated by lever from either side at all times.

**SL05**  
**ICSL05**  
**CSL05**  
ANSI: F86



**STOREROOM LOCK**  
Dead locking latch bolt operated by key in outside lever or by rotating inside lever. Outside lever is always fixed.

**SL40**



**DUMMY LEVER**  
Single dummy trim for one side of door. Pull only.

**SL80**  
**ICSL80**  
**CSL80**  
ANSI: F89



**EXIT LOCK**  
**CONNECTING ROOM WITH KEY**  
Deadlocking latch bolt operated with key from inside only. Blank plate outside.

**SL50**  
ANSI: F89



**EXIT LOCK**  
Blank plate outside. Inside lever always unlocked.

● "IC" Indicates function available with BEST, FALCON & ARROW Interchangeable Core.  
● "CSL" Indicates function available with clutch  
**OTHER FUNCTIONS NOT LISTED AVAILABLE UPON REQUEST**

**HOW TO ORDER:**  
For "AG" or "RL" designs, replace design name.  
Example: SL00 entrance in "AG" is AG00.